

Satellite Mission Assurance

WITH KEYSIGHT TECHNOLOGIES

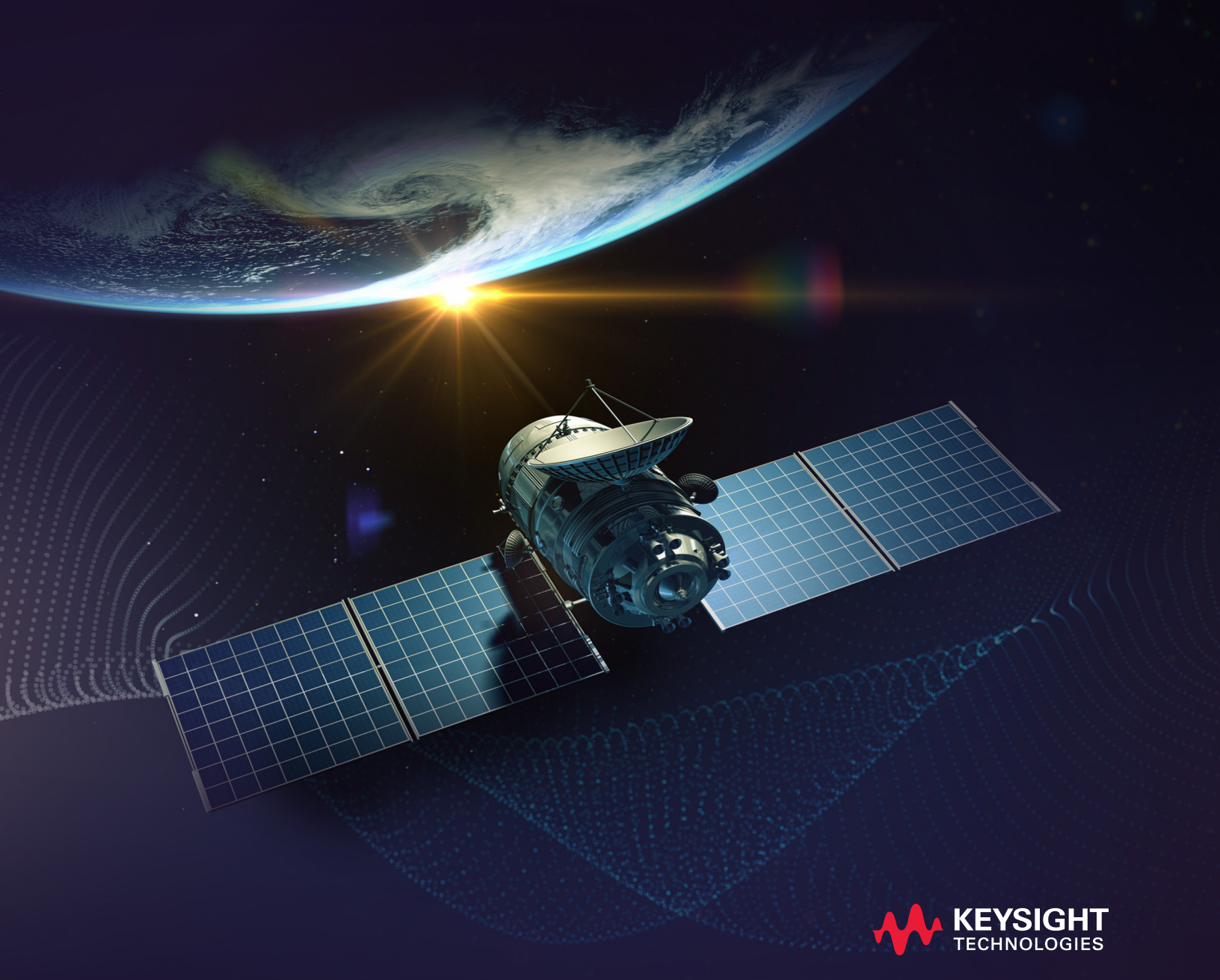

Overview

Every step in the path to new satellite development is crucial — from design and simulation to verification and manufacturing through deployment. Keysight will help you accelerate the speed of design, test, and manufacturing while maintaining a high quality of service and low risk profiles. From guidance and power systems to satellite payloads and microwave communications, our design and validation tools provide greater assurance that your satellite and its subsystems will work the first time, every time. Keysight leverages its experience and expertise, together with its Hewlett-Packard and Agilent legacy, to produce world-class hardware, software, and custom measurement solutions for your space applications. We continue to build on Hewlett-Packard's heritage of innovation in the space industry, which began with the Apollo program, to innovate for today's agile, fast-paced, and vibrant NewSpace economy. Keysight is more than a measurement company. We are trusted hardware, innovative software, and a global network of experts focused on your mission success. [keysight.com/find/satellite](https://www.keysight.com/find/satellite)

Contents

As the space industry experiences disruption not seen since the original space race, numerous companies are gearing up to provide space-based capabilities with new risk profiles, increased volumes, and decreased costs. Established businesses are adapting to take advantage of these opportunities. Whether it is high-throughput satellite (HTS) microwave payloads or telemetry, tracking, and control (TT&C), Keysight's design and validation tools provide greater assurance that your satellite and its subsystems work the duration of the mission.

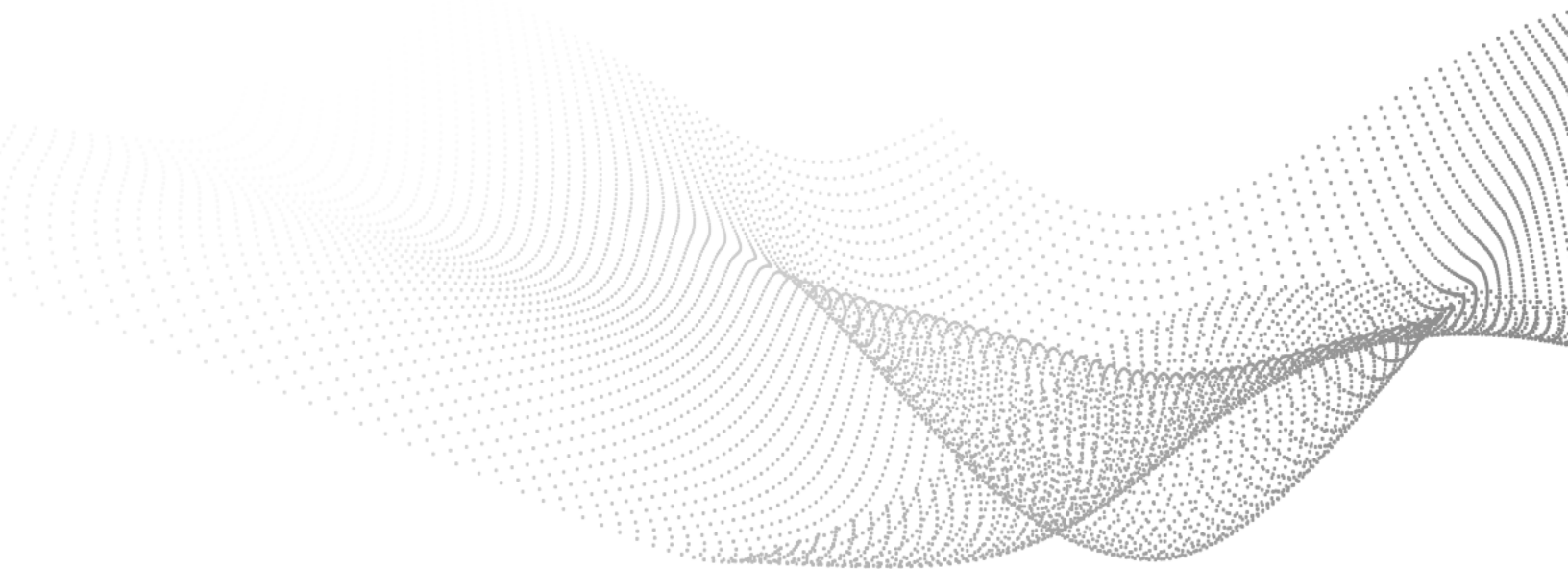



CHAPTER 1

Design and Simulation

Simulation Ensures Success from Planning to Operations..... 5

High-Fidelity System-Level Design Using PathWave System Design..... 7



Simulation Ensures Success from Planning to Operations

Satellite missions operate with a unique set of link budget obstacles. Those challenges include Doppler shifts, atmospheric distortion, latency, extreme temperature fluctuations, high-power levels driving amplifiers into nonlinear regions, and the unforgiving nature of being in space. There are no second chances for a satellite to work. Take extra care in every stage of the design, manufacturing, and deployment process to ensure that a satellite works the first time, every time. Digital modeling of satellite communications systems in these dynamic environments reduces design time and expedites manufacturing while increasing the probability of mission success and lowering production costs. You can integrate Keysight's PathWave System Design (SystemVue) electronic system-level (ESL) design software with AGI's System Tool Kit (STK) software, allowing engineers to accurately simulate and validate their signals in the dynamic space environment.

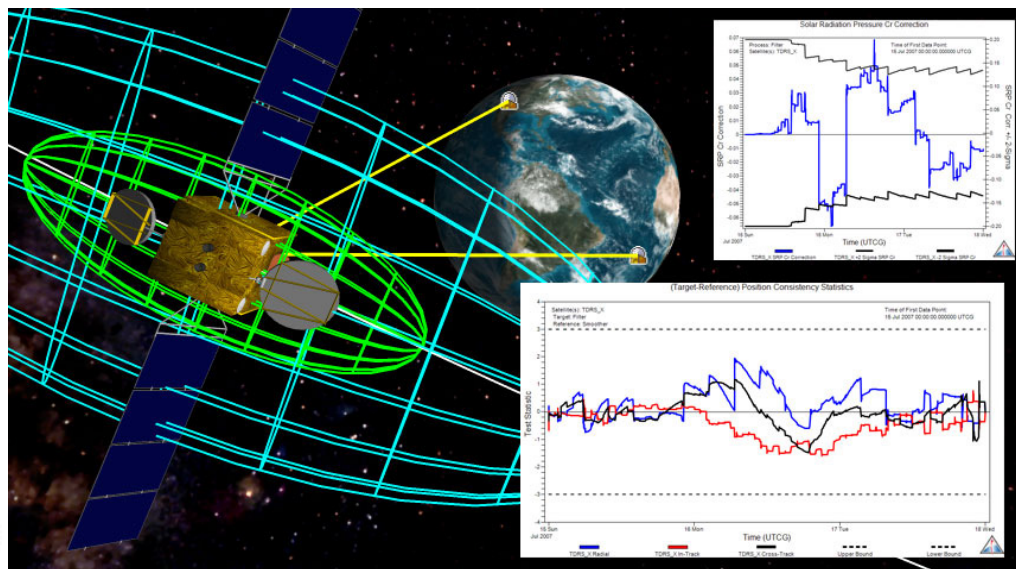

Figure 1. Orbit and communications life cycle simulation

- PathWave System Design with STK is an integrated solution for creating a true, mission-level, digital twin used in the digital mission engineering lifecycle.
- The solution uses PathWave System Design's high-fidelity radio-frequency (RF) impairment and channel models to permit user control of STK assets from PathWave System Design simulations.
- Perform a broad set of trade studies on satellite subsystems and payloads through a model-based design with integrated mission kinematics.
- The PathWave System Design and STK integrated virtual platform provides coverage analysis using actual standards-compliant modulated sources. Analysis includes all mission dynamics with various receiver architectures.
- Continually improve simulations by using Keysight's high-fidelity measurement data to enhance and refine system models.

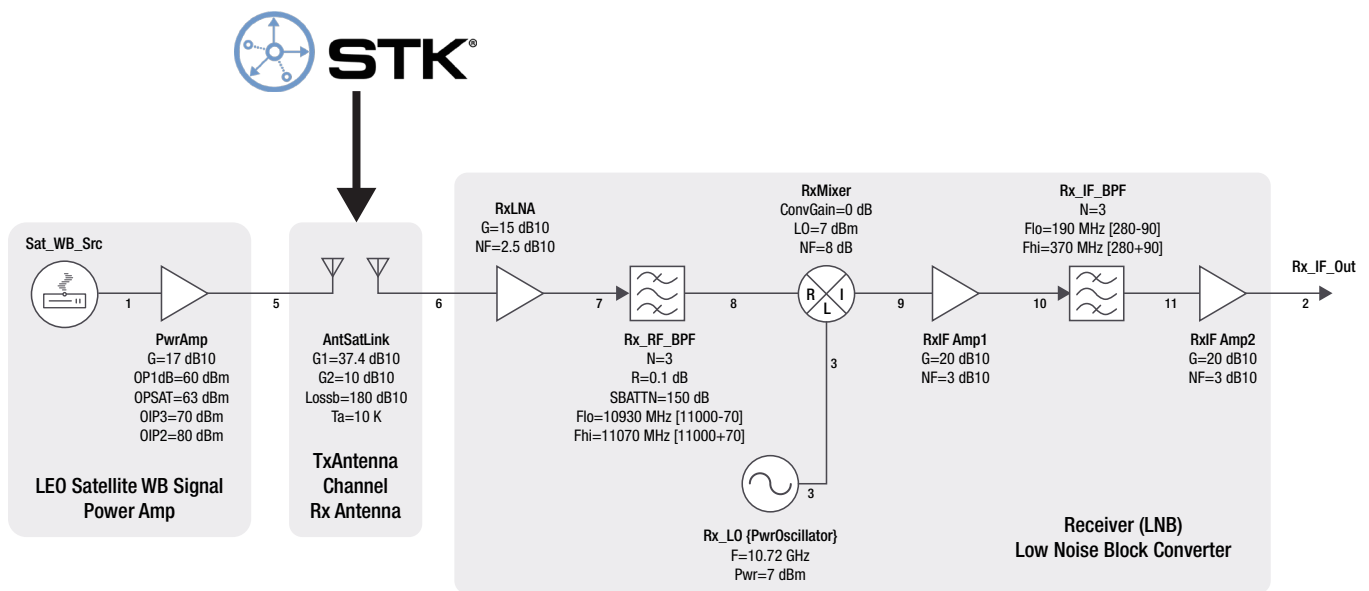

Figure 2. PathWave System Design simulation using channel kinematics imported from STK

*Note: STK is a trademark of Analytical Graphics, Inc. STK by Analytical Graphics, Inc. is subject to US ITAR export regulations. For more information, contact your local Keysight sales representative.

High-Fidelity System-Level Design Using PathWave System Design

PathWave System Design is a multidomain modeling implementation and verification cockpit for ESL design. It allows system architects and algorithm developers to cross traditional baseband and RF boundaries to innovate the physical layer of next-generation aerospace/defense and satellite communications systems. PathWave System Design simplifies tasks by integrating popular digital signal processing (DSP) modeling and implementation interfaces, along with accurate RF electronic design automation (EDA) tools, standards/intellectual property (IP) references, and test and measurement links into a single, highly productive environment.

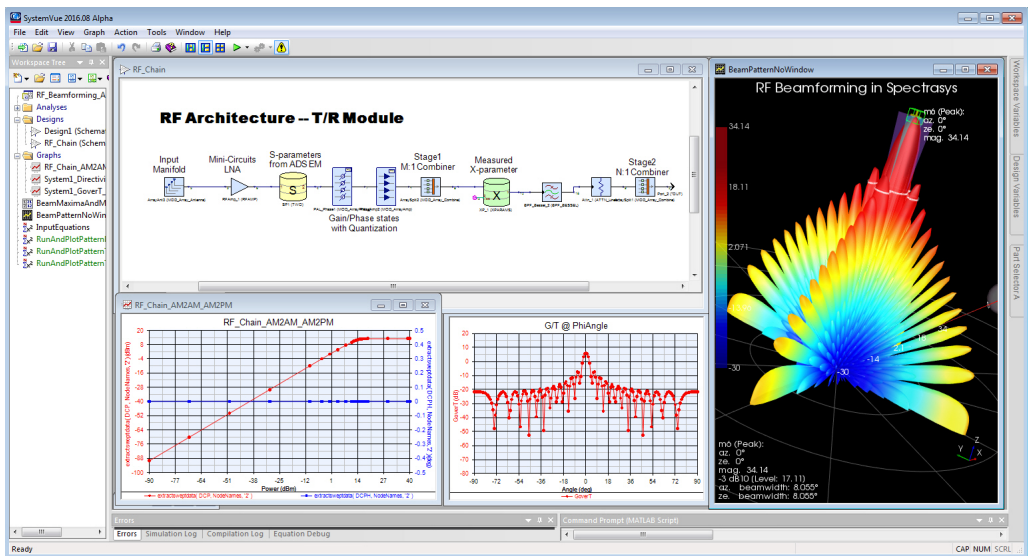
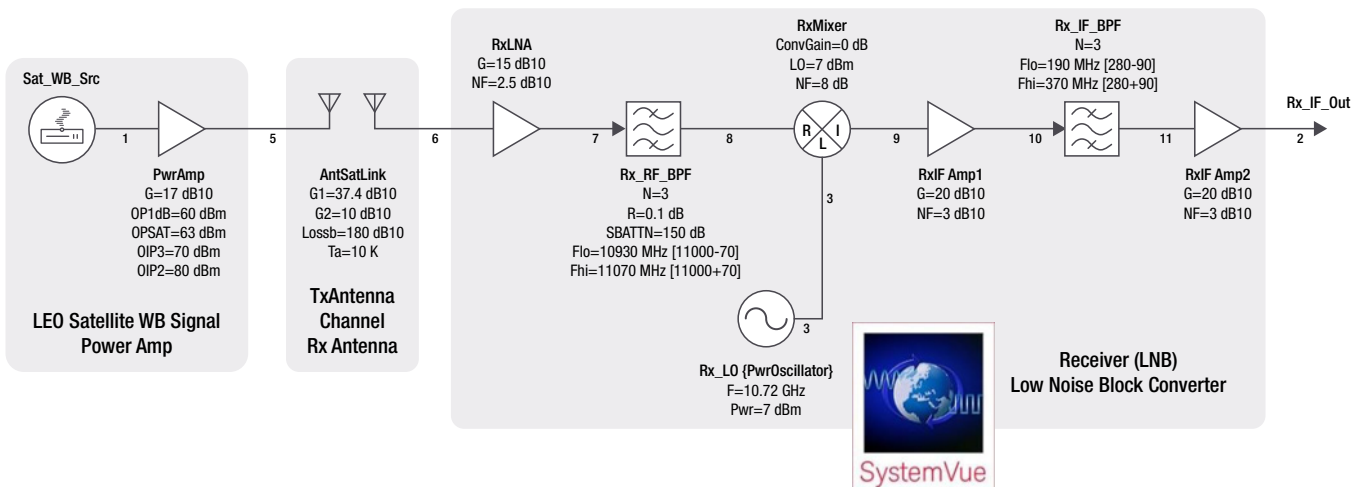
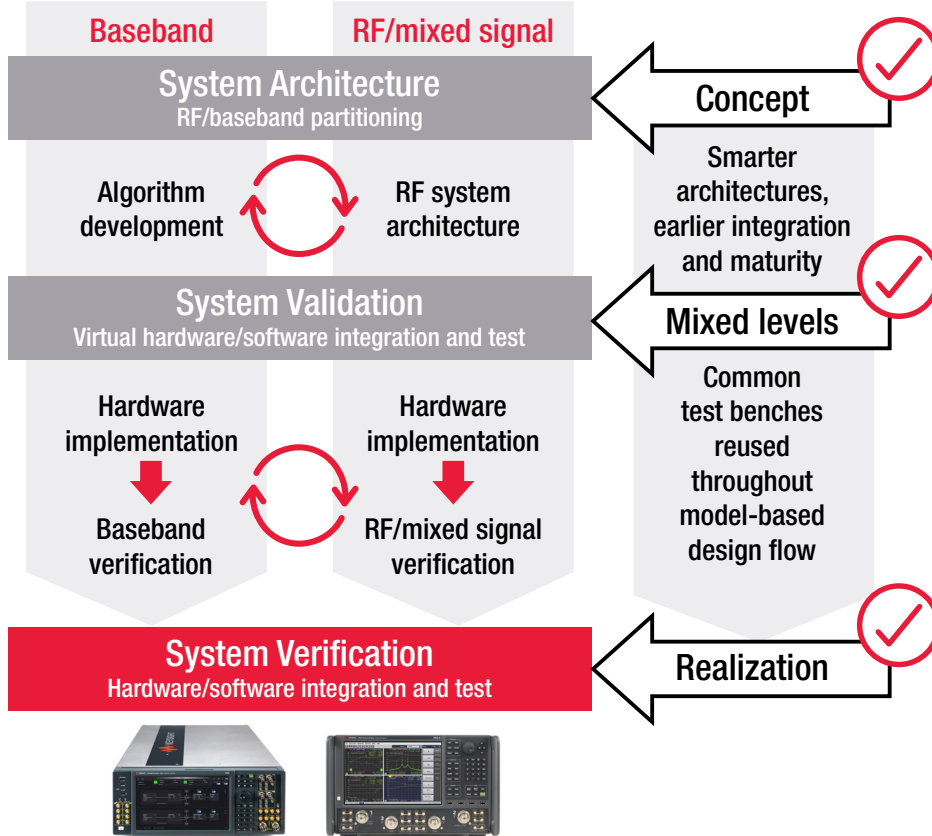

Figure 3. Phased array model using PathWave System Design



ESL Design Flow



The W4800B PathWave System Design Core is the base environment, which can be enhanced with essential simulators and libraries. It includes many capabilities not found in other system-level communications design tools or available only as added-cost options.

- W4501E Comms/DSP Analysis
- W4502E RF Analysis
- W4503E Phased Array Analysis
- W4514E PathWave STK Link
- W4524E Satellite Comms Library



CHAPTER 2

Design Optimization

Accelerate Innovation with Hardware-in-the-Loop Testing.....	10
Custom Modulation Analysis	11
Wideband Signal Analysis for Satellite Test.....	12
See Farther Down in Phase Noise	13
Modulation Distortion Application	14



Accelerate Innovation with Hardware-in-the-Loop Testing

Next-generation satellite constellations are enabling high-capacity, low-latency networks. Those networks drive the need for more bandwidth at higher frequencies to support uninterrupted connections around the world. Keysight can help you reduce project overhead, innovate faster, and lower the project risk profile by streamlining the design and optimization phase with custom design, simulation, and measurement solutions. Keysight's full range of test and measurement equipment easily enables you to move from a digital model into hardware prototypes during hardware-in-the-loop (HIL) testing. Use PathWave System Design to connect with Keysight test equipment to provide fast, reliable, high-fidelity models of satellite communications components, systems, and antennas.



Figure 4. Keysight N5247B PNA-X microwave network analyzer

1. Load communications channel parameters and kinematics into PathWave System Design from STK.

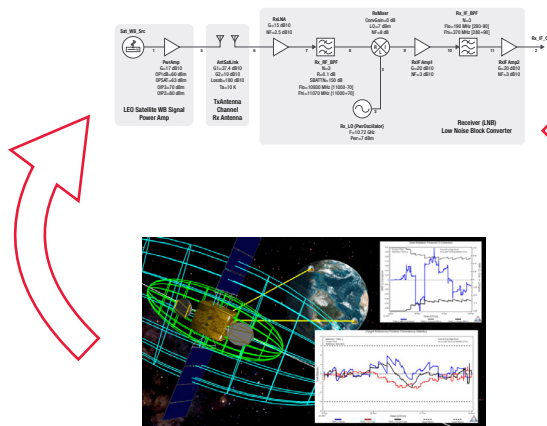

2. Use HIL to characterize system components and accelerate design cycles.



3. Optimize system design by loading PathWave System Design communications and antenna simulations into STK.

Figure 5. PathWave System Design rapid development cycle

Custom Modulation Analysis

New and proprietary modulation formats in aerospace, defense, and satellite communications define signals with unique geometric and even asymmetric forms. Every new transmitter must be thoroughly characterized with measurements like modulation quality, gain, and flatness. The development and maintenance of synchronization, signal quality, and hardware connectivity algorithms can be time-consuming – especially when test equipment or constellation formats can change across missions.

The “Custom IQ” modulation analysis feature within the 89600 VSA software platform can assist you in accurately designing and verifying your proprietary signals.

- Demodulate arbitrary constellations as defined in the constellation editor.
- Verify your transmitter using the VSA as a reference receiver for calculations of error vector magnitude (EVM), frequency error, and more.
- Evaluate demodulated bits by using coupled markers between the symbol bits and the IQ or time domains.
- Isolate the effects of nonlinear noise and distortion from linear impairments using an adaptive channel equalizer.

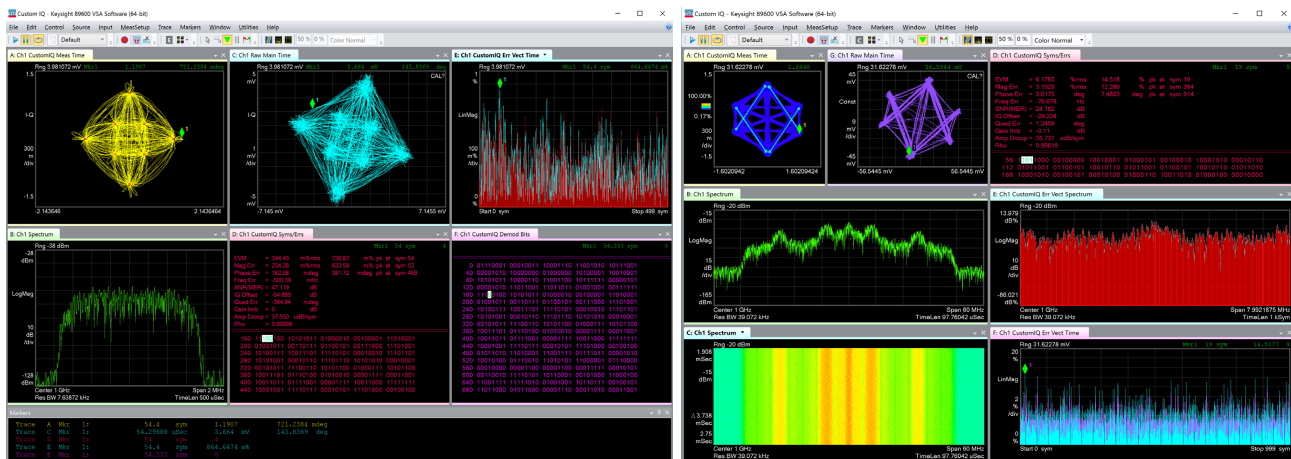

Figure 6: Custom IQ modulation analysis using VSA

Wideband Signal Analysis for Satellite Test

Wideband communications applications, such as Ka, V, and W-band HTS systems, support high data rates. Characterizing amplifiers intended for those applications can pose unique challenges. Measurements such as EVM, noise power ratio (NPR), gain compression, and phase distortion can be good indicators of a component's performance when deployed in a system. Evaluating these results over operational power and temperature range can deepen the understanding of an amplifier's behavior. This solution delivers wideband signal analysis with high dynamic range at an affordable price.

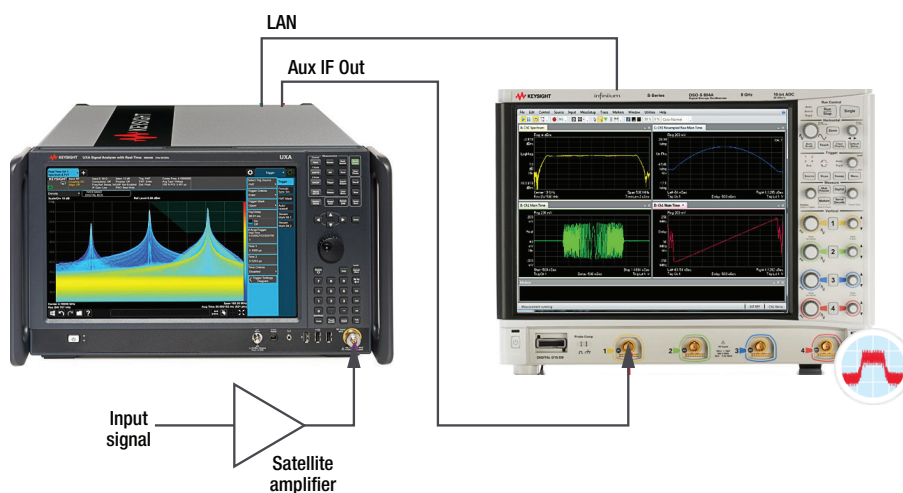

Figure 7. Wideband signal analysis test

- Export correction data from the analyzer to the VSA software.
- Load correction data quickly with center frequency and span changes.
- Amplitude and phase corrections enable accurate analysis of custom modulations.



Figure 8. Infiniium UXR-Series oscilloscope

See Farther Down in Phase Noise

Communications satellite transponders, either bent pipe or digitally regenerative, need to contribute a minimum amount of noise to the received signal. A satellite transceiver's frequency conversion stage requires the transfer of the local oscillator's phase noise onto the mixer output signals, degrading the signal-to-noise ratio and increasing the bit error rate (BER). Phase noise measurements are therefore a vital parameter when receiving low-power signals. The Keysight N5511A Phase Noise Test System can dramatically reduce the test times of both absolute and residual phase noise measurements.

- Best-in-class absolute and residual measurements
 - Measure down to the thermal noise floor (kT): -177 dBm/Hz
 - Extremely fast and flexible for the most demanding measurements
 - Multi-segment cross-correlation in FPGA hardware
- Completely code compatible with the Keysight E5505A Phase Noise Measurement Solution



Figure 9. N5511A Phase Noise Test System, 50 kHz to 40 GHz

Modulation Distortion Application

In satellite communications systems, high-power amplifiers and low-noise amplifiers are critical links in the transmission chain to supply the required power to antennas. High-power amplifiers, such as traveling-wave tube amplifiers (TWTAs) and solid-state power amplifiers, are often driven close to saturation power to maximize efficiency, particularly in the orbiting satellite. In driving these devices to those high power levels, there is a risk that any nonlinear behavior will distort the modulated signal beyond recognition. As such, the nonlinear response of the power amplifier (PA) directly impacts BER in the demodulation. In addition to poor BER in your channel, spectral regrowth created by nonlinearities can cause unwanted power in adjacent channels, making carrier aggregation impossible. Thus, understanding the linearity of the RF chain is critical for the quality of satellite communications.



Modulation source such as:



VXG

or...



M9383A/B

or...



PSG + M819X AWG

or...



MXG

or...



N5192/4A UXG

Modulation distortion app on PNA-X

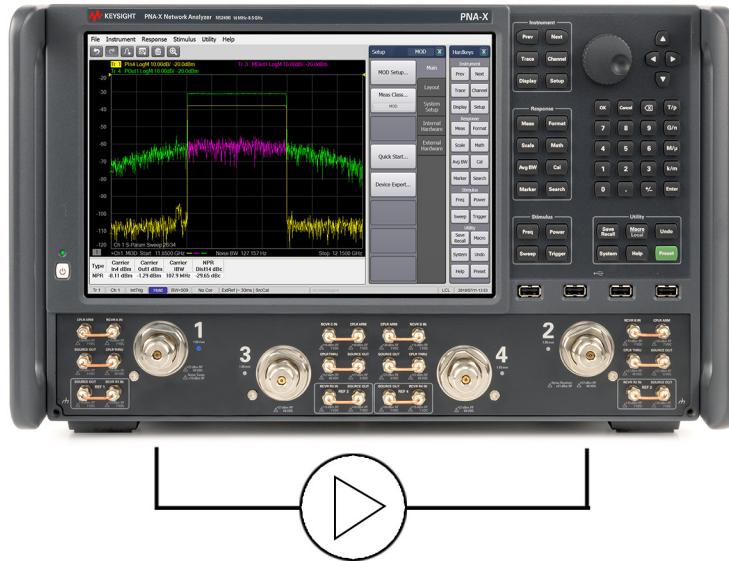

Keysight's S93070xB modulation distortion application, combined with the Keysight PNA-X vector network analyzer (VNA) and a vector signal generator such as the Keysight VXG, enables users to measure the nonlinear behavior of PAs under wideband modulated stimulus conditions. In addition to existing PNA-X measurements such as S-parameter, gain compression, intermodulation distortion, and noise figure, PNA-X allows error-corrected nonlinear distortion measurement under the modulated stimulus condition, without changing any connections. As a result, users can achieve excellent signal fidelity and accurate modulated measurement at RF and millimeter-wave frequencies.



CHAPTER 3

System Integration and Emulation

Test the Whole Communications System..... 17

Test Your Satellite System's Functional Performance Before Launch 20



Test the Whole Communications System

Geostationary earth orbit (GEO) HTS satellite systems and the NewSpace commercial trend of low earth orbit (LEO) constellations bring new challenges to component and system-level satellite testing. The utilization of higher frequency and wider bandwidths in satellites requires more complex testing and characterization to ensure that components and systems meet demanding space requirements. For a variety of test scenarios essential to the design, verification, and manufacturing of satellite components and systems, spectrum analysis and signal generation are the fundamentals of a robust test system.

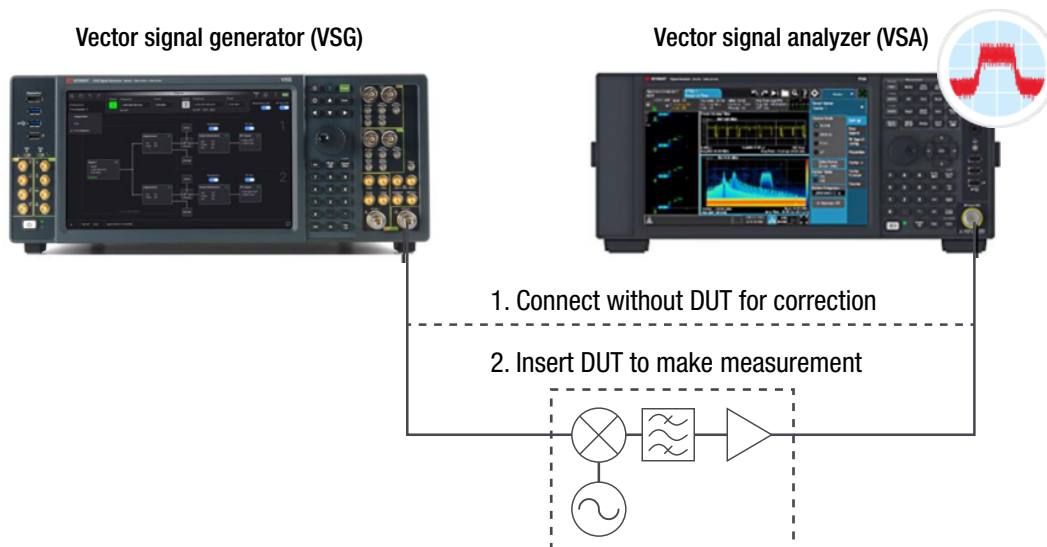

- Every measurement is repeatable and traceable to National Metrology Institutes through Keysight-engineered calibration procedures that verify instrument reference signals, enabling you to see true device-under-test (DUT) characteristics.
- Keysight's VXG microwave signal generator has a compact design that provides frequency coverage from 1 MHz to 44 GHz, up to 2 GHz RF modulation bandwidth, and dual coherent channels for even wider bandwidths.
- Adding real-time signal analysis (RTSA) to an X-Series signal analyzer creates a cost-effective solution that combines traditional spectrum measurements with real-time capabilities.



Figure 10. Keysight M9384B and M9383B VXG microwave signal generators

One ongoing challenge for satellite operators is how to transmit more data to more users at higher speeds within the available spectrum bandwidth. As a result of this challenge, higher-order orthogonal frequency-division multiplexing (OFDM) and more complex modulation techniques are used. While the modulation becomes more complex, it becomes increasingly difficult to view a waveform in either the time or frequency domain and troubleshoot problems in signal quality. Therefore, modulation accuracy measurements are the best choice to characterize digitally modulated signals at the system level. With the PathWave Vector Signal Analysis (89600 VSA) software, you can measure more than 75 signal standards and modulation types, including satellite communications.

Use **Keysight's PathWave Signal Generation software** to create standard and custom modulations:

- Digital video N7623C
- Multitone distortion N7621B
- Real-time fading N7605C
- PathWave Signal Generation Pro (Signal Studio Pro) for custom modulation N7608C, including DVB-S2X

Then evaluate your nonstandard or proprietary OFDM and APSK signals using Keysight's PathWave VSA (89600) software.

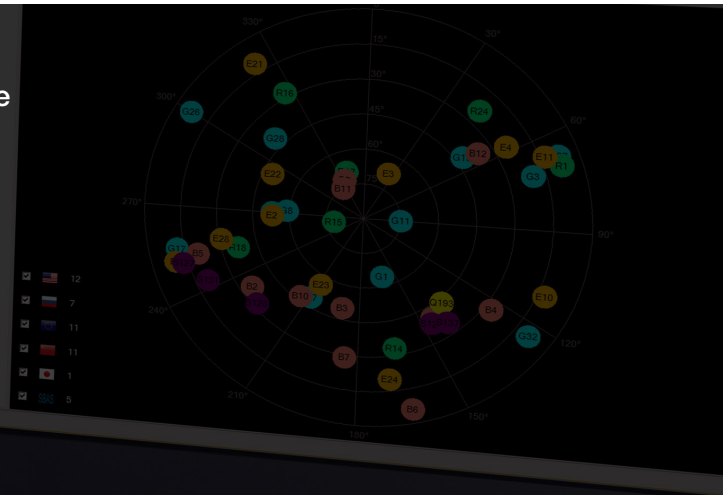



Figure 11. Keysight PathWave Signal Generation Pro

Keysight products allow you to generate and analyze video signals commonly used in direct broadcast satellite systems. Those signals include DVB-S/S2/S2X, and standard or custom communication signals – such as custom IQ, OFDM, and 5G – from DC to V-band and beyond. These tools are necessary to test the entire satellite system. The same products can perform digital system verification, allowing you to debug everything from sensor data on the controller area network bus to cutting-edge, low-voltage differential signaling or SpaceWire/SpaceFibre signaling in a digitally channelized or regenerative satellite.

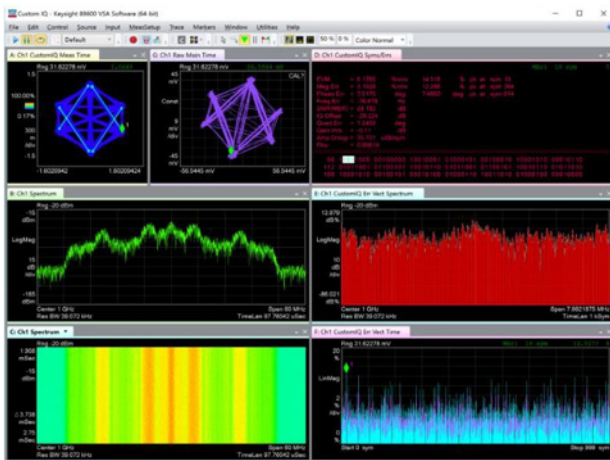
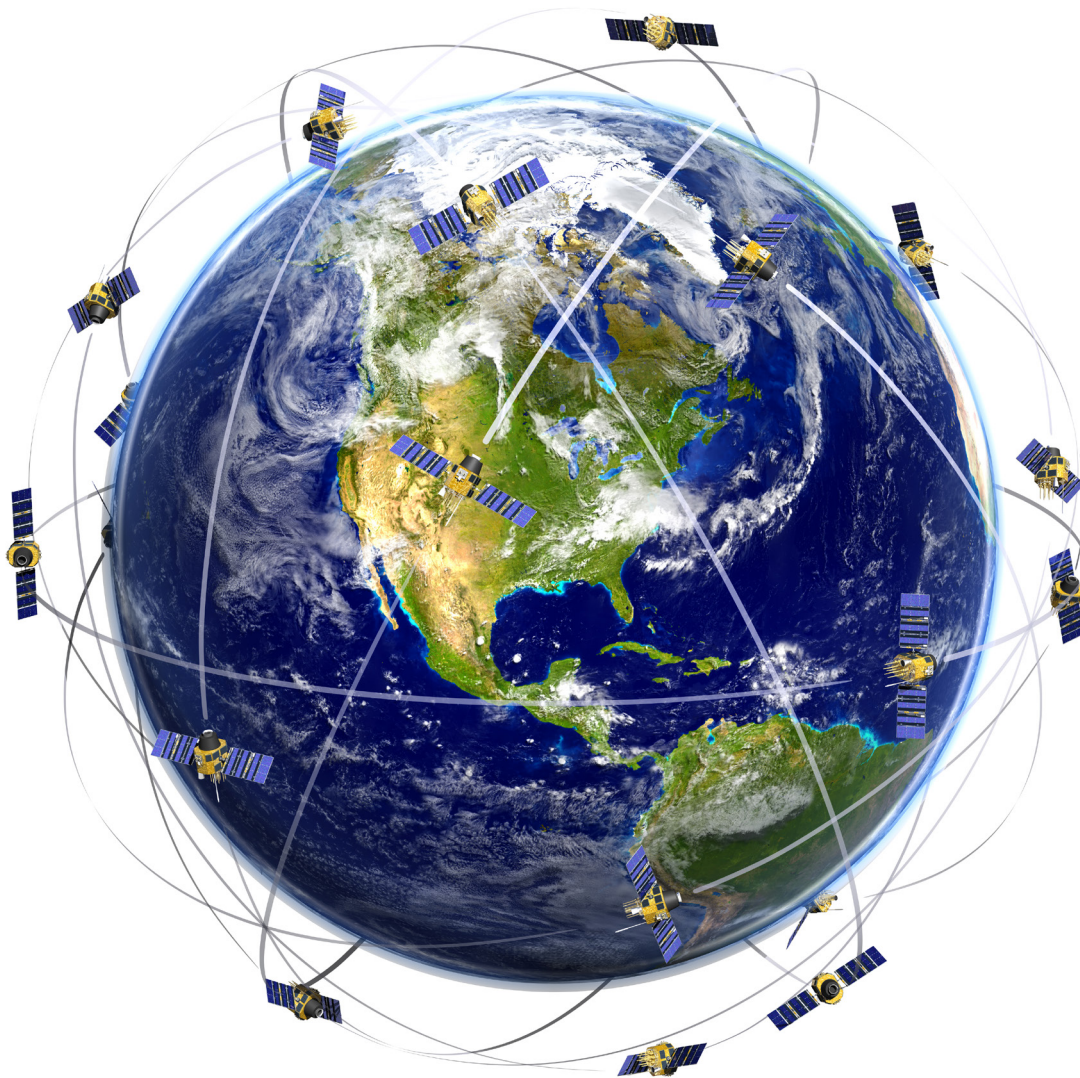

Figure 12. Keysight PathWave VSA (89600) custom IQ analysis software

Test Your Satellite System's Functional Performance Before Launch

Satellites, aerospace, and airborne radio devices must meet stringent reliability requirements. A failure in these communication links can lead to the loss of life-critical data. Test conditions need to mimic the environment where these radios operate as much as they can—not only at the link level but also at the multilink network level.

Keysight's PROPSIM Satellite Channel Emulation solution supports realistic test conditions in the lab for current and future satellite and aerospace communication systems. Creating dynamic scenarios and modeling an entire satellite mesh constellation pushes the testing standard to its orbital height.



Solution Benefits

- Quick and repeatable satellite radio system tests in a laboratory
- Advanced test tools for network protocol and receiver performance optimization
- Support for all wireless applications such as aerospace, satellite, and 5G NR non-terrestrial networks
- Emulate extreme RF propagation channel conditions in the lab:
 - High delay Doppler
 - Sliding delay
 - Multipath
 - Path loss and rain fading



Figure 13. Keysight's PROPSIM satellite channel emulators

Use PROPSIM to identify and resolve issues early in the development process, shortening research and development cycles. By identifying issues at an early stage, you can ensure that your satellites are more mature and have fewer errors before launching to space. This approach accelerates R&D cycles while significantly reducing development and testing costs. Keysight's PROPSIM Satellite Channel Emulation Solution is the most reliable and cost-effective solution for end-to-end functional performance testing in the laboratory.



CHAPTER 4

Antenna Testing

Phased Array Antenna Characterization 23



Phased Array Antenna Characterization

As phased array antennas become more capable and complex, they often have multiple test ports. Past approaches routed these multiple test ports through an RF switch matrix to a one-channel receiver. The switch matrix added loss, reducing measurement sensitivity while adding measurement time to sequence through the various switch positions. For a multiport antenna today, you can use a multiport receiver that measures all test ports simultaneously, greatly reducing measurement time with improved sensitivity. You can configure the M980xA Multiport VNA with 2 to 50 test ports up to 20 GHz. You can then measure all the antenna test ports simultaneously with each trigger from the antenna rotation positioning system. This preferred method of measuring multiport antennas greatly improves measurement throughput and productivity.

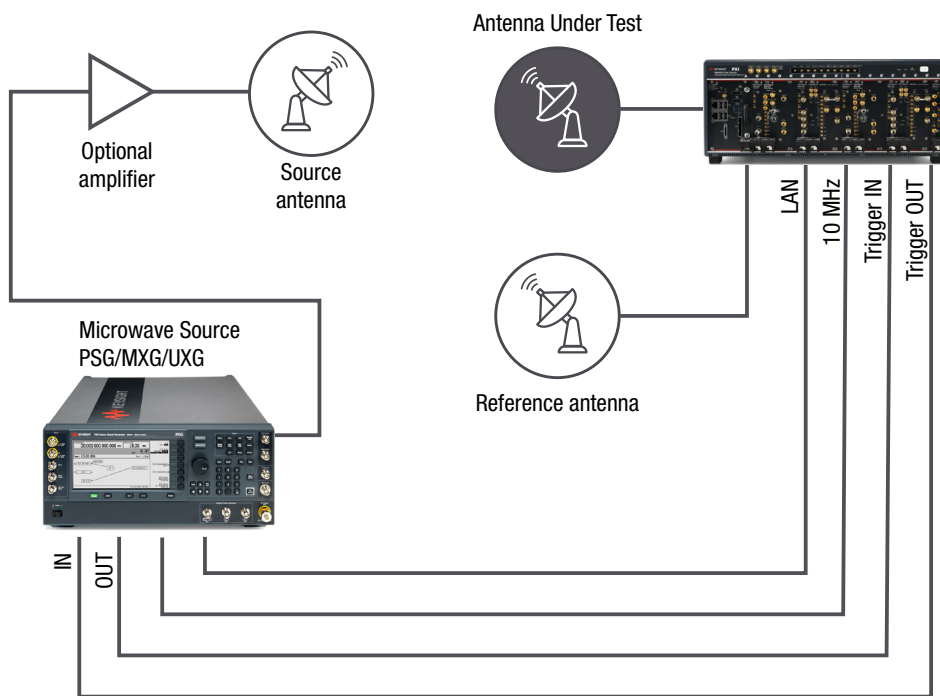

Figure 14. Multiport phased array antenna test setup

Multiport VNA advantages over switch-based solutions include the following:

- Test and reference receivers per VNA port
- Improved measurement speed and device throughput with fewer sweeps
- Better dynamic range
- Better accuracy and stability
- Modular approach allows for flexibility and scalability

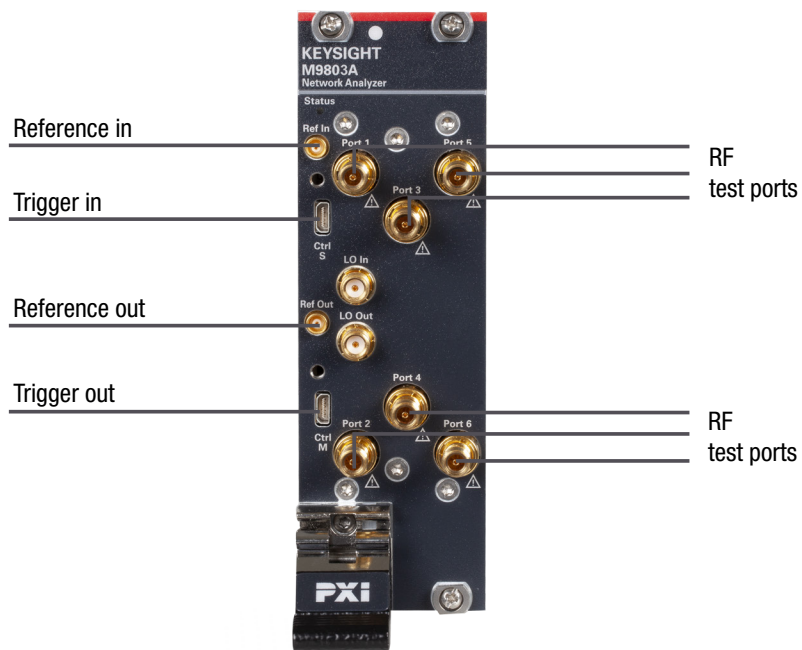

Figure 15. Keysight M9804A six port VNA



CHAPTER 5

Production

Manufacturing for Reliability.....	26
Moving at the Speed of Production.....	27
Power Up Your Satellite.....	29
Custom Satellite Test Solutions.....	30



Manufacturing for Reliability

After satellite deployment, physically repairing aerospace and satellite devices in orbit is expensive and difficult — virtually impossible. Therefore, it is critical to maintain the highest level of quality throughout the production process, especially as production volume scales. Keysight's commitment to quality can help you reduce production costs while increasing mission success. Keysight provides confidence in measurement results through dependable custom test solutions that offer exceptional test speed and data fidelity.



Figure 16. M9384B VXG, UXR1102A Infiniium oscilloscope, and N9041B UXA

Moving at the Speed of Production

PathWave Test is an advanced software suite that connects teams and test stations. Scalable from a single user to a global enterprise, PathWave Test accelerates your test workflow, giving you the power to collaborate and manage test projects from your web browser.

PATHWAVE

Traditional product design and development workflows are full of design and test silos, unnecessary rework, and legacy manual processes. Accelerate your workflow with PathWave, the platform for agile and connected engineering workflows. Keysight's trusted design and test software is evolving to meet the ever-increasing needs of your organization. The PathWave software platform is designed to provide a consistent user experience, common data formats, and control interfaces. Every step in your product development path is connected and integrated.

- PXI products can easily integrate with other automated test equipment through PathWave, thereby accelerating measurements.
- NPR measurements on the PNA-X with the modulation distortion application vastly reduce test time.
- PathWave software tools, including data analytics, can optimize test times and track test trends throughout the development process.

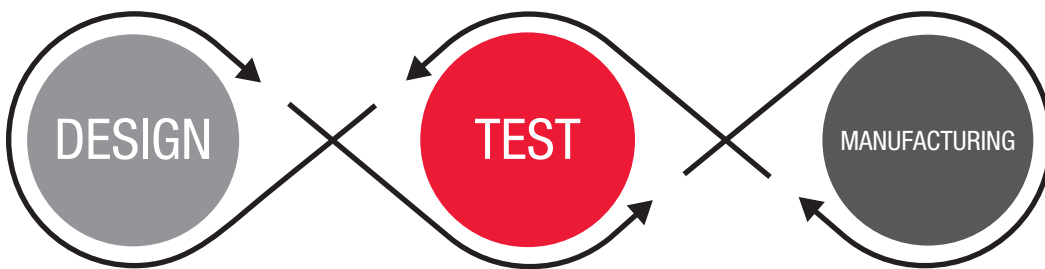

Satellite manufacturers are moving from a custom low-volume production process to full industrialization. Transitioning from a few units per month to several satellites per day is a challenge specific to LEO constellations. As production scales, testing and specifically test times must meet the needs of today and tomorrow. Keysight's experience and expertise can help you optimize production processes and translate your unique requirements into a high-performance, fully integrated, and repeatable custom test and measurement solution. Move forward with the world leader in measurement science and test applications.



Figure 17. Keysight N6705C 600W DC Power Analyzer



Figure 18. UXR0134A 4-Channel Infiniium Oscilloscope



Power Up Your Satellite

The satellite power management system is a critical subsystem. It serves as the fuel source to power every operation in the satellite once in orbit. One function of the power management system is charging the satellite's battery. While the solar arrays are the primary power source, the battery serves as the secondary power source during launch and early orbit phases (LEOP), eclipses, and periods of peak power demand. The charging system must be meticulously tested to ensure that it can properly charge the battery. Using an actual battery during testing may not be practical and can be extremely time consuming, as the battery will need to be manually charged and discharged to the proper start level at every test. A programmable DC power supply that can seamlessly source and sink current will automate this process. By emulating the satellite battery, it is possible to repeatably and accurately test the power management system.



Figure 19. E4360A Modular Solar Array Simulator



Figure 20. RP7900 Regenerative Power System



Custom Satellite Test Solutions

A test system is only as good as its ability to evaluate the specific unit under test (UUT). Keysight has the knowledge, resources, and processes in place to match the system to your needs. Working with our select partners, we will assist you in meeting your testing needs in a cost-competitive manner. With our custom satellite test solutions, we will help you achieve remarkable results and meet your key business objectives. Examples include the following:

- Power and Data Bus Test System
- Solar Array Simulator (SAS) System
- Payload RF Test Solution
- Space Ground Link Test System
- Component/Subsystem Automated Test Platform



Power and Data Bus Test System

The Power and Data Bus Test System is a custom-built test solution. It consists of hardware to provide command and telemetry signals, BER testing, DC power interface, data storage, and standard RS422 and IEEE 1553 signal interfaces for satellite panel and unit testing.

- customizable to specific requirements
- capability to supply stimulus, power, and measurements for satellite bus testing
- optional BERT capability
- redundant power supply bus protection and monitoring
- relay switching of signals to oscilloscope and data recorder
- support for additional satellite protocols such as SpaceWire/SpaceFibre

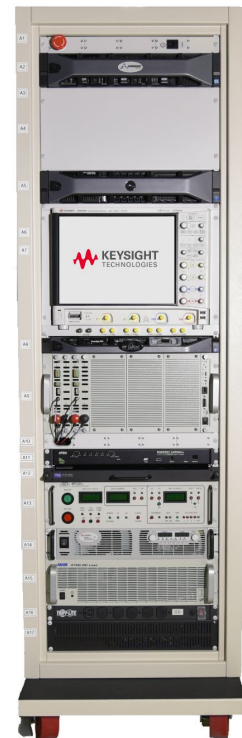

Solar Array Simulator

The Keysight E4360A modular, scalable, and purpose-built SAS enables you to accurately and efficiently simulate complex behavior of one or more photovoltaic cells or solar arrays. Those attributes make it possible to accurately — and efficiently — simulate the complex behavior of one or more photovoltaic cells and solar arrays for any satellite operational scenario.

- outstanding modularity for dynamic reconfiguration
- accurate simulation of any solar array type
- small size – 2 outputs in 2U
- high output power – up to 600 watts per output
- fast I-V curve change and fast recovery switching time
- exceptional mean time to repair, including individual module service and calibration

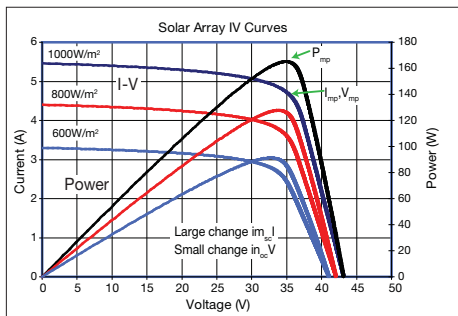
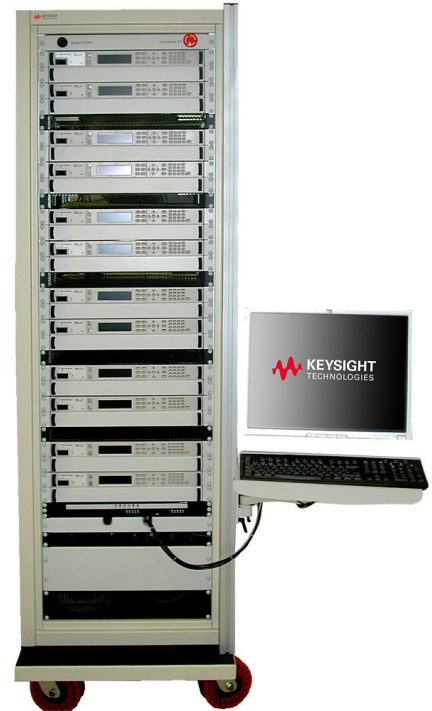

Figure 21. I-V curves with varying irradiation level

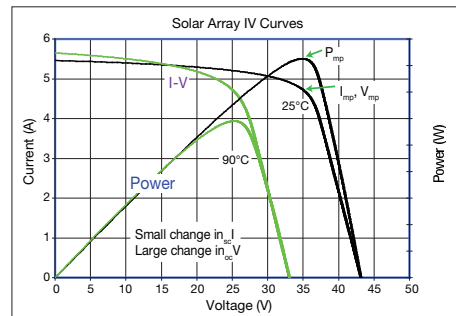

Figure 22. I-V curves with varying temperature

“Working with Keysight, we took a new approach to manufacturing test. Instead of duplicating an existing test solution to increase production, we focused on our cost of ownership and were able to lower cost and protect against obsolescence.”

Subassembly Testing Manager, Defense Contractor

Telemetry, Tracking, and Control Systems

Ground stations receive telemetry information from satellites concerning their health, status, and location. The ground station uses this data to then transmit control commands back to the satellite. The satellite uses those commands to reconfigure subsystems, payload, or modify its position. This communication link to the ground station is vital to ensure proper satellite deployment and maintenance, particularly for satellite constellations. The Space Ground Link System (SGLS) test set performs command and telemetry signal processing between a satellite control computer and a satellite UUT. The test set will further provide switch routing and measurement equipment to verify signal integrity and system performance. Signal conversion equipment emulates the satellite ground station hardware for the control and status of the UUT. The flexible SGLS platform product allows system modifications for specific customer applications.

- modulates ternary data and clock command signals
- performs custom or standard modulation formats and signal up conversion
- automatically routes signals with RF and digital switches to appropriate inputs and outputs for test operations
- conducts BER testing
- includes necessary signal conditioning for the command and telemetry RF signals

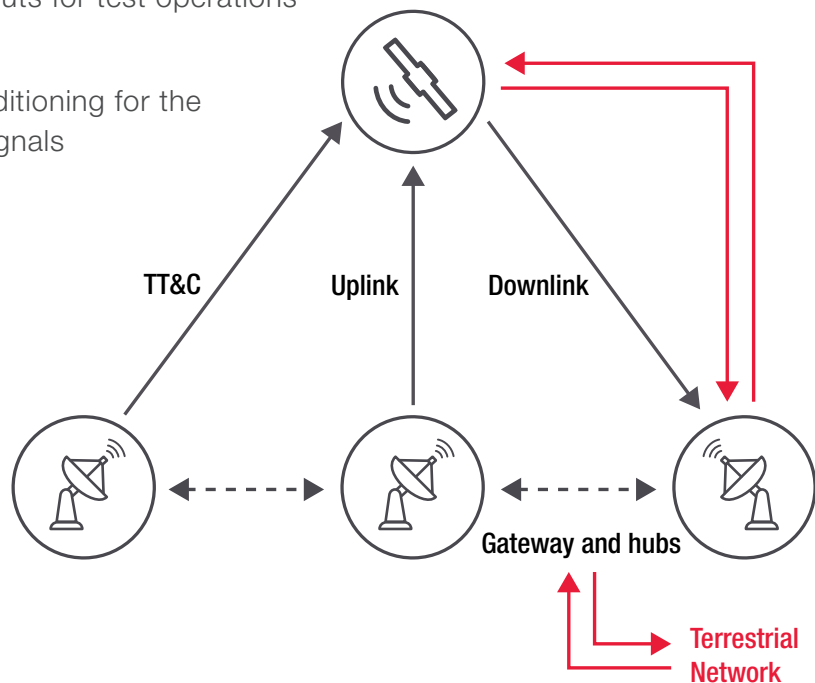



CHAPTER 6

Environmental Testing

Thermal Vacuum Chamber Testing 34

Minimize Risk and Maximize Performance 35

Test the Satellite, not the RF Cables 36

Precision Power for Precision Satellites 37



Thermal Vacuum Chamber Testing

Equipment used in space applications undergoes these stringent environmental tests to prove that it can survive extreme launch and space conditions. Accurately simulating the extreme environmental conditions of space requires testing a satellite in a thermal vacuum (TVAC) chamber. Tests last up to a few months running 24 hours a day, seven days a week. The TVAC chamber test is typically the final test conducted, as well as the most complex and expensive. Success requires detailed planning, which normally occurs six to 18 months before testing. Tests in a TVAC chamber can cost up to \$1 million per day, making it critical to ensure the accuracy of all measurements. TVAC testing helps uncover possible problems, such as outgassing of equipment or materials that could contaminate the satellite environment, design flaws from overheating of materials, and a corona (metal vapor arcing) effect that can cause problems in the low-pressure environment.

Credit: NASA/JPL/UA/
Lockheed Martin

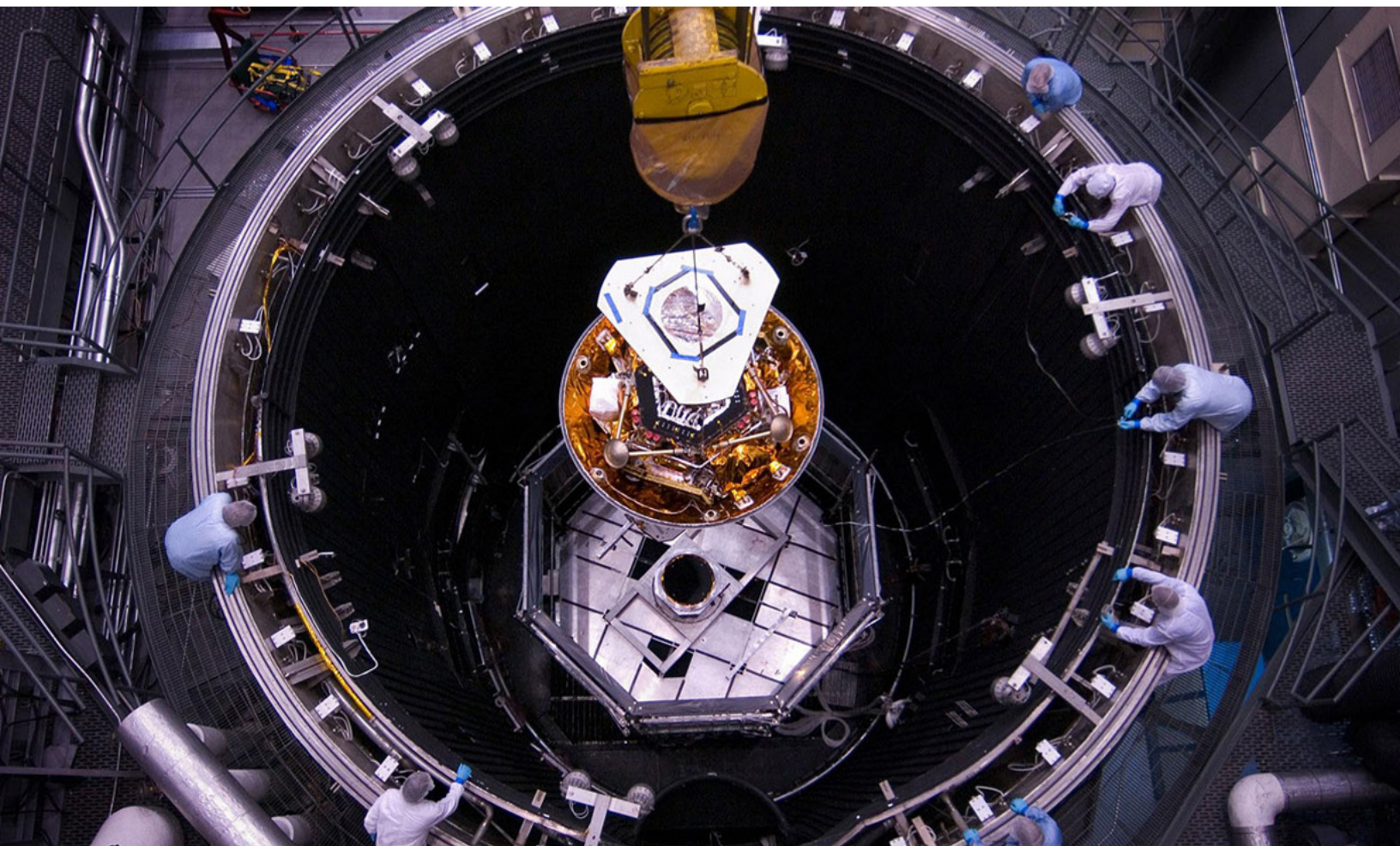

Minimize Risk and Maximize Performance



Figure 23. L8990M Custom Modular Switch Matrix

The time to compromise on quality is not during the choice of switches, cables, and connectors. They significantly impact overall system measurement performance and reliability. Ideally, signals would not degrade on the path to the DUT. For actual test systems, however, the signal always experiences some

degradation when passing through these components. This degradation is directly related to signal frequency and the quality of routing components. To ensure the best signal integrity, select switches where the insertion loss, return loss, and isolation do not compromise the quality of the measurement.

- excellent RF performance — based on the proven family of Keysight RF switches specified for low loss and high repeatability in applications to 67 GHz
- automated and manual control — based on the Keysight L449n controller with LAN, SCPI command set, and web-based GUI
- each Keysight L8990M modular switch matrix is delivered fully integrated according to the user-specified configuration
- custom front and rear panel meet design requirements
- interactive RF schematic for Keysight Z2091C allows engineers to point and click on components to change state



Figure 24. Z2091C Smart Switch Platform

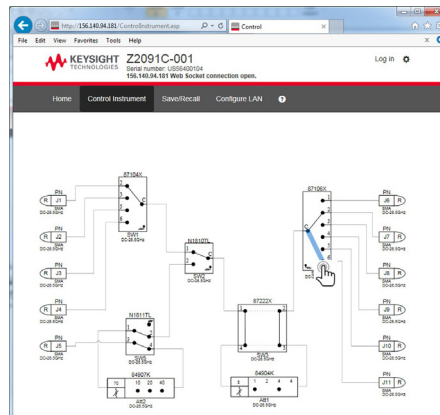

Figure 25. Interactive RF schematic using Z2091C Smart Switch

Test the Satellite, not the RF Cables

TVAC chambers create difficult testing environments during the satellite manufacturing process. The long cable lengths, thermal effects, and sealed chamber make it impractical to calibrate your measurements over varying chamber conditions throughout the test process. The use of Keysight CalPod assemblies in the test system allows you to perform calibrations at the system's front panel. The calibrations are then transferred out to the DUT measurement plane. This approach considerably reduces the amount of calibration required while making calibrations more accurate and easier to perform. CalPods provide a quick and easy way to refresh network analyzer calibration at the push of a button without removing the DUT or reconnecting physical standards.



Figure 26. N5247B PNA-X microwave network analyzer



Figure 27. 85542B 40 GHz TVAC-rated CalPod

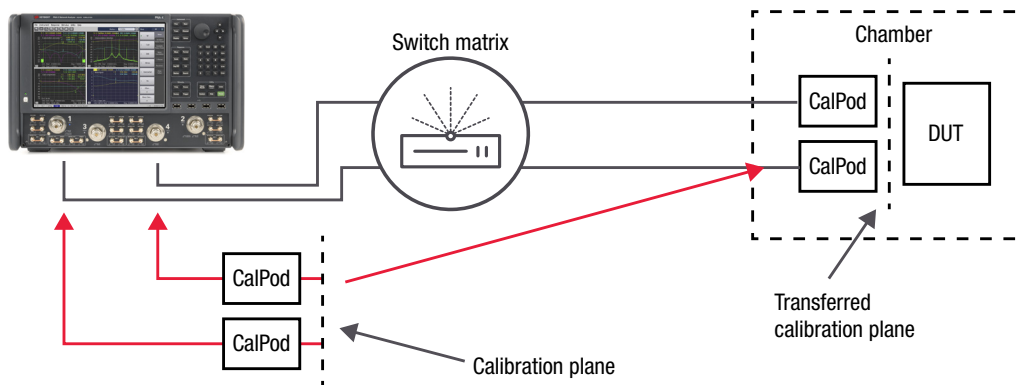
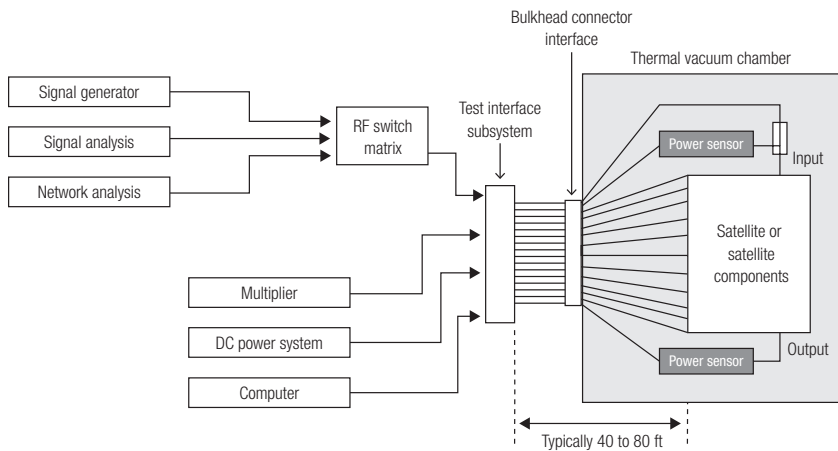

Figure 28. Use CalPods for in-situ calibration at the DUT

- use CalPods placed close to the DUT and de-embed the cabling to measure DUT parameters accurately
- remove random errors with CalPod technology, including environmental effects, such as amplitude and phase changes, due to movement or thermal variation of the test cables
- eliminate connector and switch matrix repeatability errors from the measurement of your DUT's performance

Precision Power for Precision Satellites

The whole satellite, satellite components, or modules go inside a TVAC chamber. All electrical connections to the system under test must include hermetically sealed connector feedthroughs to maintain the vacuum. Historically, the power meter and sensors are located outside the chamber and connect to the satellite using the sealed feedthroughs via switch matrices. With the Keysight U2049XA option TVA and L2065/66/67XT LAN power sensors, the TVAC-qualified sensor can connect directly to the satellite inside the TVAC chamber.



Keysight's power sensors monitor the output power of the transmitters during the testing stage and detect any instability, power spikes, or other irregularities. Upon detection of an irregularity, test software will shut down the satellite to prevent damage. You can simultaneously connect up to 20 power meters and sensors to a satellite to perform this comprehensive testing over the Ku and Ka bands.

- the TVAC power sensor is designed with minimum outgassing materials
- the power sensor improves measurement accuracy and simplifies test setup or calibration procedure
- cover a wide range of satellite signals with a frequency range of 10 MHz to 33/53/54/67 GHz and a wide power range of -70 to +20 dBm
- the LAN power sensors are capable of long-distance remote monitoring to 100 meters with a standard LAN cable
- broadband coverage provides accurate average power measurements of complex modulated signals

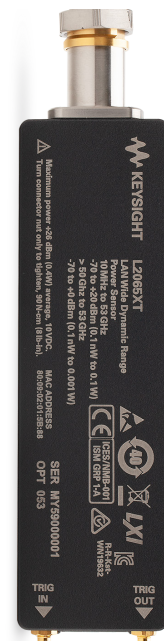

Figure 29. TVAC LAN power sensors



CHAPTER 7 Operation/Maintenance

Maintaining Quality of Service	39
Identify Interfering Signals.....	42
Powerful RTSA for Interference Detection.....	44



Maintaining Quality of Service

The satellite launch does not end the story. Satellite ground stations manage data, monitor satellite health, and control satellite operations. The ground station must manage its own unique set of challenges. Today's satellite systems deliver more complex data streams to and from ground stations than ever before. The ground station must provide high uplink transmit power. Because of the long distance between a satellite and an earth station, the signal received at the earth station is usually very weak. The signal's condition may worsen with weather conditions such as cloud cover, humidity, and extreme temperature ranges that cause high atmospheric attenuation. To compound these difficulties, antenna misalignment can result in signal power degradation.

Compensating for these link variations demands regular maintenance and service for the ground stations. Satellite ground station installation and maintenance requires a wide range of RF/microwave tests. However, more challenges arise when getting test equipment to a location that lacks the conveniences of the lab. Field testing limitations include difficulty of access, limited power access, equipment temperature constraints, equipment ingress protection ratings for dust and moisture protection, warm-up times for measurement accuracy, and multiple pieces of equipment. Equipment transport and field tests are generally more difficult to perform.



Figure 30. N9918B FieldFox Handheld Microwave Analyzer

Earth Station Maintenance and Troubleshooting Requirements

a) Testing requirements	b) Equipment requirements
Antenna <ul style="list-style-type: none"> • return loss • alignment • polarization • sidelobe levels 	<ul style="list-style-type: none"> • power meter • spectrum analyzer • vector network analyzer • line sweeping (distance to fault (DTF)/ time domain) • RF source (continuous wave (CW) and swept) • DC source voltage/current meter
Transmission lines <ul style="list-style-type: none"> • cable and waveguide loss • rotary joint voltage standing wave ratio (VSWR) • fault location 	
Transmitter <ul style="list-style-type: none"> • high power amplifier (HPA) performance • converter performance • occupied bandwidth • adjacent channel power • frequency stability 	
Receiver <ul style="list-style-type: none"> • low noise amplifier (LNA) performance • converter performance • interference • Global Navigation Satellite System (GNSS) 	
System <ul style="list-style-type: none"> • effective isotropically radiated power (EIRP) • G/T, C/N • BER 	

Satellite ground stations contain many sophisticated and delicate RF and microwave components and subsystems, including antenna subsystems, waveguides, coaxial cables, filters, low-noise amplifiers, low-noise blocks, block upconverters, high-power amplifiers, and TWTAs. You should verify these components during installation or operation. You also need to monitor the spectrum performance of the whole system. Maintenance becomes challenging when the ground station is in a remote area.

A single Keysight FieldFox handheld analyzer is an ideal test solution thanks to its high performance, broad capabilities, and lightweight portability. It eliminates the need to transport multiple benchtop instruments to ground station sites.

- quickly assure system performance with internal amplitude alignment for measurement confidence
- each FieldFox is CalReady at both RF ports to obtain greater efficiency and measurement consistency
- multiple instruments in one enable quick diagnosis of ground station faults
- quickly pinpoint performance issues by recording spectrum of interest
- FieldFox is a completely sealed instrument, rugged enough to meet military specifications
- find signal interferers with the flexibility of remote monitoring, programmability, and control



Identify Interfering Signals

With the dramatic increase in satellites and the more complex electromagnetic environment, satellite operators and regulation institutions must overcome the challenge of interference detection — especially for intermittent or transient signals and the rollout of 5G networks. The Keysight N6820ES Signal Surveyor 4D software spectrum monitoring tool can automate signal search and survey functions. It tasks internal or external processes with the capture and analysis of spectrum events or comprehensive surveys of the RF environment. Its powerful triggering and alarm functions are unrivaled in the commercial spectrum monitoring industry. Used manually, it functions as a high-speed spectrum display with the ability to task handoff receivers, modulation recognition, recording, direction-finding, and emitter location measurements.

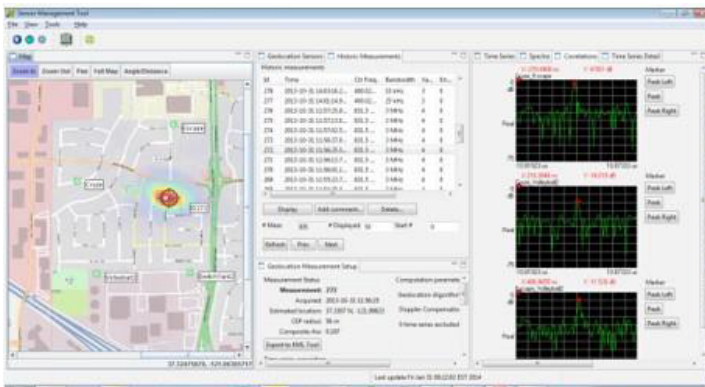

Figure 31. Signal Surveyor software

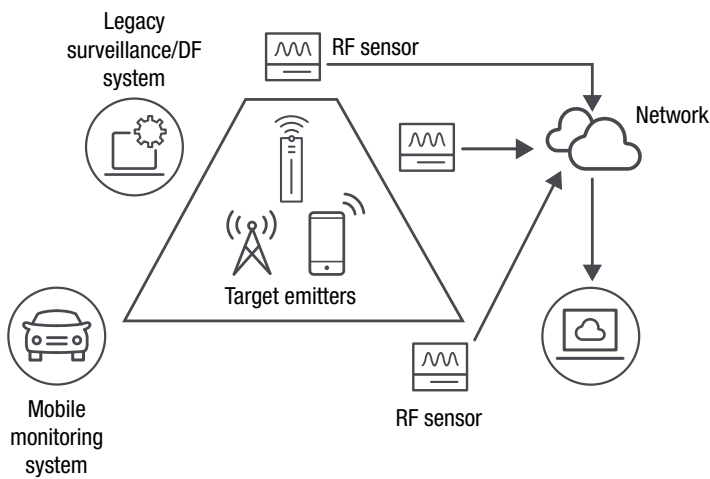

Figure 32. Signal monitoring and surveillance system

Choosing the Right Tools

Surveyor 4D software operates with the N6841A RF Sensor, M9391A or M9393A PXI VSAs, and the FieldFox Handheld RF Analyzers. These options provide highly effective and affordable tools for RF professionals.



Figure 33. FieldFox Handheld RF Analyzer



Figure 34. M9391A PXI VSA



Figure 35. N6841A RF Sensor



Figure 36. M9393A PXI Performance VSA



Figure 37. N6850A Broadband Omnidirectional Antenna



Figure 38. N9910x-822 Handheld Directional Antenna

Powerful RTSA for Interference Detection

The level of interference determines the quality of service. Optimized antenna location and patterns in a satellite earth station (ES) contribute to the reliability of communication under all weather conditions. Satellite monitoring systems, based on frequency-sweeping technology, work well with interferers that are present on the transponder for a significant amount of time. For the unintentional interferences with low duty cycles, the sweep rate will limit the ability of the monitoring systems to detect signals. With its gap-free nature, RTSA is ideal for the detection of transient signals. It captures interfering signals and displays them clearly on the screen. Effective triggering mechanisms, such as frequency mask trigger, enable the user to focus on the signal of interest. Used with the PathWave VSA, this feature simplifies the capture of the interfering signal, replaying it, and performing deep analysis.



Figure 39. N9030B PXA with RTSA monitoring 12 satellite channels + interferer

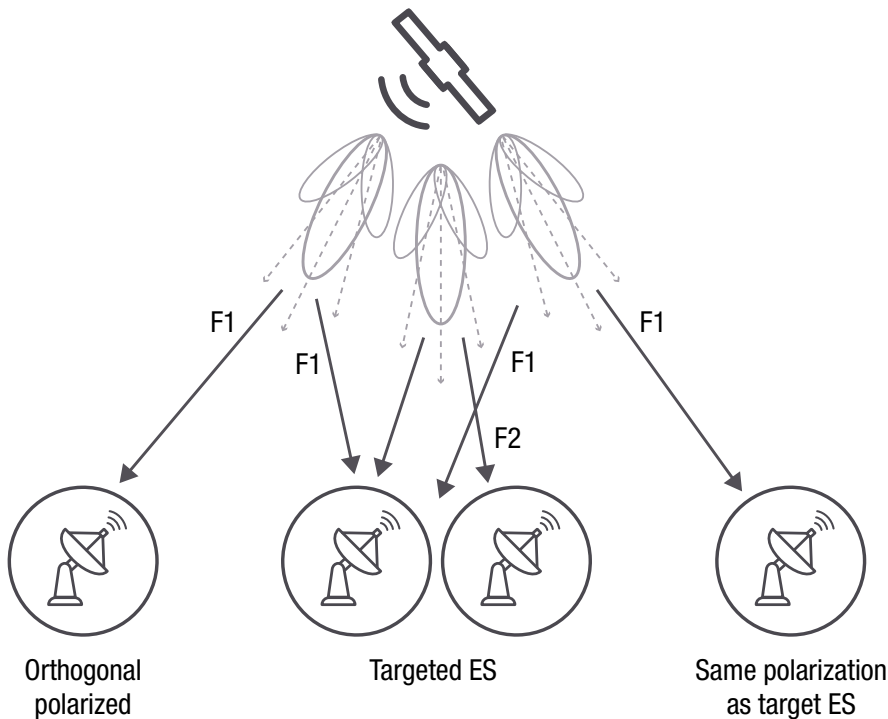

Figure 40. Interference in satellite ground station operation



CHAPTER 8

Service and Support

Leading-Edge Test Solutions for Long-Term Program Support 46

Additional Information 47



Leading-Edge Test Solutions for Long-Term Program Support

Keysight Service offers a broad portfolio of support and services to assist engineers working on satellite programs. We understand that engineers count on accurate, repeatable measurements to ensure mission success while meeting budget and schedule requirements. Inaccurate measurements and system downtime affect yield and increase the risk of a device failing during operation. The emergence of new and unique technologies drives a need for constant modernization. To address this challenge, you can:

- implement an optimal migration strategy with Technology Refresh Services to modernize test equipment to the latest technology as soon as it is available with upgrade and trade-in services
- have confidence that your instruments are performing to specification by using Keysight's global network of 69 service centers in 19 countries
- avoid the need to disassemble and reassemble test systems and improve true yields with system calibration services



Around the World, We're Ready to Help You Change It

- 150 locations
- conducting business in more than 100 countries
- 12,900 employees
- ASIC design center and proprietary fabrication facility
- technology centers for MMICs, optical components, and microelectronic packaging
- over 1,700 patents
- >4,000 products
- R&D centers in 15 countries around the world
- 40 service hubs

Additional Information

Design and simulation

SystemVue Electronic System-Level (ESL) Design Software, 5992-0106EN

Keysight EEsof EDA Advanced Design System, 5988-3326EN

Genesys An Integrated Simulation and Synthesis Tool for RF/Microwave, 5989-7014EN

Design Optimization

Microwave Network Analyzers PNA-X series, 5990-4592EN

Keysight 89600 VSA Software, 5990-6553EN

Keysight N5511A Phase Noise Test System (PNTS), 5992-4083EN

Better Satellite Link Distortion Testing Using Spectral Correlation Method, 5992-4190EN

System Integration and Emulation

PathWave Signal Creation Brochure, 5989-6448EN

Propsim Channel Emulation Aerospace, Satellite and Airborne Radio System Testing, 5992-1606EN

Antenna Testing

W1720EP Phased Array Beamforming Kit W1467 SystemVue Array Architect Bundle, 5992-1590EN

Production

Keysight Process Analysis, 5992-1575EN

Conquering the Multi Kilowatt Source/Sink Test Challenge, 5991-2873EN

Solving the Challenges of Solar Array Simulation, 5990-5915EN

Environmental Testing

Achieving Accurate RF and Microwave Power Measurements for Satellite Thermal Vacuum Test, 5992-1151EN

RF/Microwave Switching Solutions, 5989-8065EN

Operation/Maintenance

Overcoming the Challenges in Satellite Testing and Interference Detection, 5992-1505EN

Top 5 Reasons Why FieldFox Is the Ideal Companion for Satellite Ground Station Maintenance, 5992-0054EN

Overcoming RF & MW Interference Challenges in the Field Using Real-Time Spectrum Analysis (RTSA), 5992-1722EN

Precision Validation, Maintenance, and Repair of Satellite Earth Stations FieldFox Handheld Analyzers, 5992-0727EN

Service and Support

8 Proven Ways to Increase Test Asset ROI, 5992-2593EN

