

**Anritsu** envision : ensure

# Network Master™ Series

## Network Master Flex MT1100A

10G Multirate Module MU110010A

100G Multirate Module MU110011A

40/100G Advanced Module MU110013A

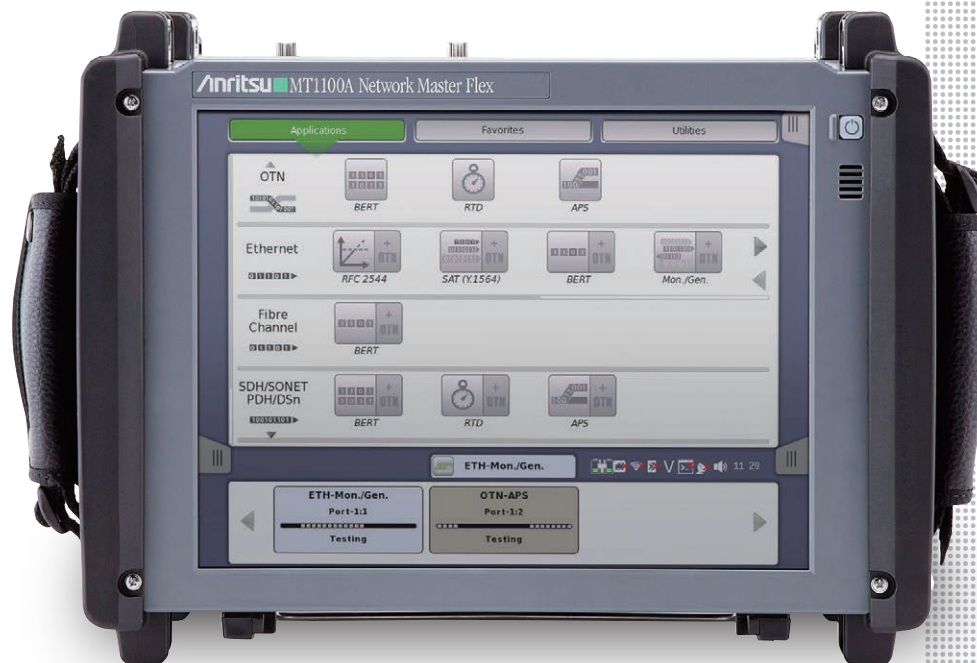

# Network Master Flex MT1100A Overview

## Transport Tester for Evolving (Advancing) Networks

### Versatile Support up to 100 Gbps plus High Work Efficiency at R&D and Mass-Production Manufacturing

Today's core and metro communications networks are implementing 100 GigE and OTN technologies rapidly to provide sufficient bandwidth supporting the explosive increase in mobile communications data. These high-bit-rate networks demand very high reliability due to the large data volumes and variety of client signals in use. Consequently, every stage from R&D through to manufacturing, installation, and maintenance, requires precision testing and verification of network equipment and transport devices.

The all-in-one Network Master Flex MT1100A supports the communications network technologies. Selecting and installing up to two modules from a range of three module options supports all-in-one R&D, manufacturing, installation and maintenance tests of network and transport equipment operating at bit rates from 1.5 Mbps to 100 Gbps. The large, 12.1-inch color LCD touch panel with easy-to-use GUI plus remote operation of a full range of test functions over an Internet connection greatly improves test efficiency and helps cut costs.

Key Benefits and Features:	Key Applications:
<ul style="list-style-type: none"> <li>All-in-one transport tester                             <ul style="list-style-type: none"> <li>Supports testing from 1.5 Mbps to 100 Gbps</li> </ul> </li> <li>Up to 4 ports at all rates</li> <li>Various interfaces for optical transceivers support: CFP, CFP2, CXP, QSFP28, QSFP+, SFP+, SFP</li> <li>Various interfaces for electrical support: CAUI, XLAUI, CAUI4</li> <li>Easy and intuitive GUI</li> <li>WLAN*/Bluetooth*/LAN connectivity</li> <li>PDF, CSV and XML report generation for documenting test results</li> <li>Remote operation (VNC, Dedicated GUI software)</li> <li>Remote control (scripting, via Ethernet, WLAN, GPIB)</li> <li>Compact, lightweight design for maximum field portability</li> <li>High performance in small form factor</li> <li>Modular platform ensuring maximum return on investment</li> </ul>	<ul style="list-style-type: none"> <li>Core and metro networks installation and maintenance                             <ul style="list-style-type: none"> <li>OTN up to OTU4 including mapping of Ethernet, CPRI, Fibre Channel and SDH/SONET client signals, multistage mapping and FEC (Forward Error Correction) also supporting O.182 Poisson error addition</li> <li>Testing and verification of OTN functions                                     <ul style="list-style-type: none"> <li>ODU0, ODU2e, ODU3e1, ODU3e2, ODU4, ODUflex</li> </ul> </li> </ul> </li> <li>Carrier Class Ethernet installation and troubleshooting                             <ul style="list-style-type: none"> <li>Ethernet testing up to 100 Gbps including RFC 2544, Y.1564 and RFC 6349 (Up to 10 Gbps)</li> <li>100GBASE-SR4 RS-FEC</li> <li>Ethernet OAM</li> <li>MPLS-TP and PBB</li> <li>IP Channel Statistics (up to 10 Gbps)</li> <li>Frame capture for advanced troubleshooting</li> </ul> </li> <li>Mobile Fronthaul and backhaul installation and verification                             <ul style="list-style-type: none"> <li>eCPRI/RoE (IEEE1914.3)/CPRI/OBSAI</li> <li>Synchronous Ethernet testing up to 10 Gbps</li> <li>TCP Throughput testing with RFC 6349 or iperf</li> </ul> </li> <li>Powerful Storage Area Networking (SAN) testing                             <ul style="list-style-type: none"> <li>Fibre Channel up to 10 Gbps</li> </ul> </li> <li>Quick and easy testing of SDH/SONET and PDH/DSn networks                             <ul style="list-style-type: none"> <li>SDH/SONET (STM-1 to 256/OC-3 to 768)</li> <li>PDH/DSn (E1, E3, E4, DS1, DS3)</li> </ul> </li> </ul>

\*1: Available for certified countries and regions including USA, Canada, Japan and EU countries. Please visit the Anritsu web site for updated information. The Bluetooth® mark and logos are owned by Bluetooth SIG, Inc. and are used by Anritsu under license.

### Connector Panel Overview

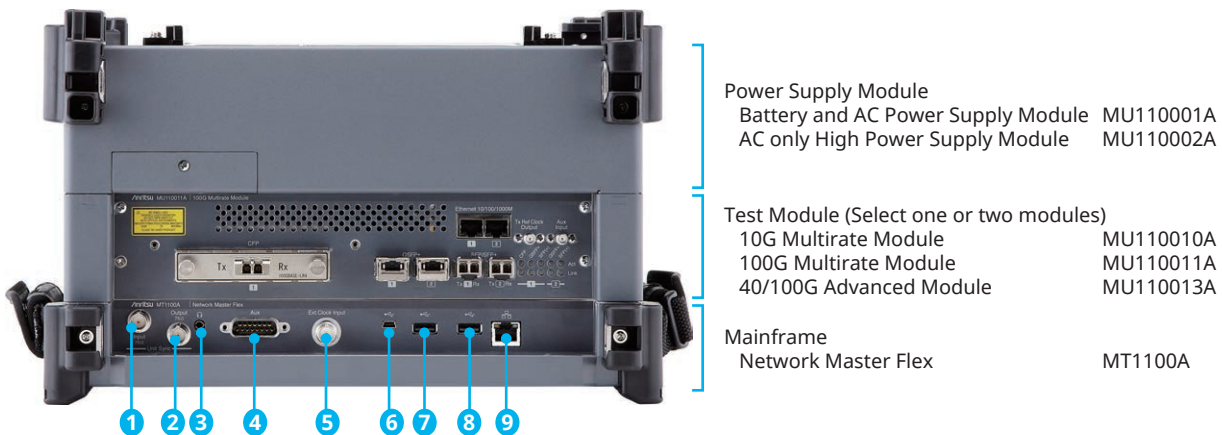

- 1 Unit Sync. Input (for future use)
- 2 Unit Sync. Output (for future use)
- 3 Audio (3.5ø: CTIA Standard)
- 4 AUX (for G0325A, GPS receiver)
- 5 External Clock Input
- 6 USB Mini-B
- 7 USB A
- 8 USB A
- 9 Ethernet Service Interface

# Measurement Modules

## Transport Tester for Evolving (Advancing) Networks

### 10G Multirate Module MU110010A

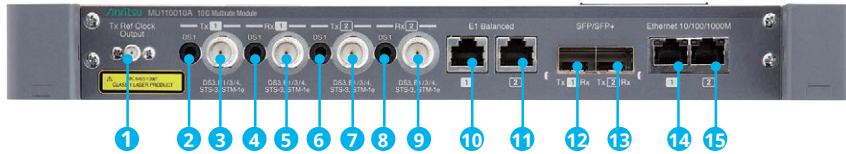

- 1 Tx Reference Clock Output
- 2 Port1, Tx Mini-bantam (DS1)
- 3 Port1, Tx BNC (E1, E3, E4, DS3, STM-1e, STS-3)
- 4 Port1, Rx Mini-bantam (DS1)
- 5 Port1, Rx BNC (E1, E3, E4, DS3, STM-1e, STS-3)
- 6 Port2, Tx Mini-bantam (DS1)
- 7 Port2, Tx BNC (E1, E3, E4, DS3, STM-1e, STS-3)
- 8 Port2, Rx Mini-bantam (DS1)
- 9 Port2, Rx BNC (E1, E3, E4, DS3, STM-1e, STS-3)
- 10 Port1, Tx/Rx RJ48 (E1 balanced)
- 11 Port2, Tx/Rx RJ48 (E1 balanced)
- 12 Port1, Tx/Rx SFP/SFP+ (OTN, Ethernet, eCPRI/RoE/CPRI/OBSAI, Fibre Channel, SDH/SONET optical)
- 13 Port2, Tx/Rx SFP/SFP+ (OTN, Ethernet, eCPRI/RoE/CPRI/OBSAI, Fibre Channel, SDH/SONET optical)
- 14 Port1, Tx/Rx RJ45 (Ethernet, eCPRI/RoE electrical)
- 15 Port2, Tx/Rx RJ45 (Ethernet, eCPRI/RoE electrical)

### 100G Multirate Module MU110011A

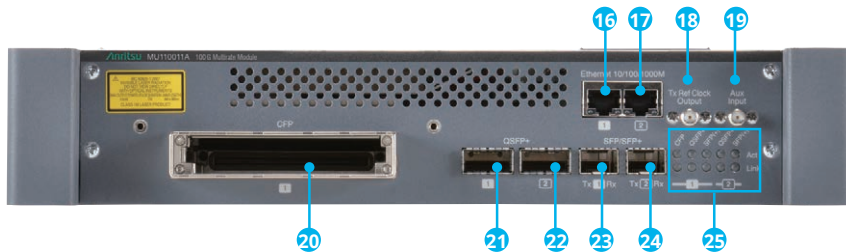

- 16 Port1, Tx/Rx RJ45 (Ethernet, eCPRI/RoE electrical)
- 17 Port2, Tx/Rx RJ45 (Ethernet, eCPRI/RoE electrical)
- 18 Tx Reference Clock Output
- 19 AUX Input (for future use)
- 20 Tx/Rx CFP (OTN, Ethernet, eCPRI/RoE, SDH/SONET optical)
- 21 Port1, Tx/Rx QSFP+ (OTN, Ethernet, eCPRI/RoE optical)
- 22 Port2, Tx/Rx QSFP+ (OTN, Ethernet, eCPRI/RoE optical)
- 23 Port1, Tx/Rx SFP/SFP+ (OTN, Ethernet, eCPRI/RoE/CPRI/OBSAI, Fibre Channel, SDH/SONET optical)
- 24 Port2, Tx/Rx SFP/SFP+ (OTN, Ethernet, eCPRI/RoE/CPRI/OBSAI, Fibre Channel, SDH/SONET optical)
- 25 Act, Link Indicators

### 40/100G Advanced Module MU110013A

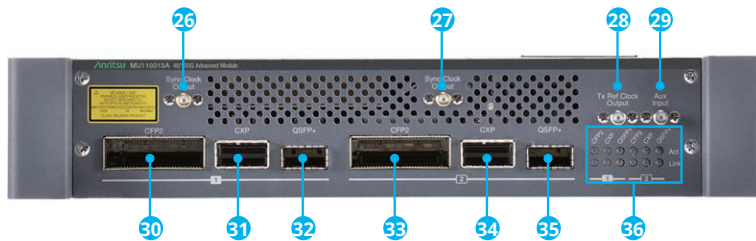

- 26 Port1, CFP2 Sync. Clock Output
- 27 Port2, CFP2 Sync. Clock Output
- 28 Tx Reference Clock Output
- 29 AUX Input (for future use)
- 30 Port1, Tx/Rx CFP2 (OTN, Ethernet, eCPRI/RoE optical)
- 31 Port1, Tx/Rx CXP (Ethernet, eCPRI/RoE optical)
- 32 Port1, Tx/Rx QSFP+ (OTN Ethernet, eCPRI/RoE optical)
- 33 Port2, Tx/Rx CFP2 (OTN, Ethernet, eCPRI/RoE optical)
- 34 Port2, Tx/Rx CXP (Ethernet, eCPRI/RoE optical)
- 35 Port2, Tx/Rx QSFP+ (OTN Ethernet, eCPRI/RoE optical)
- 36 Act, Link Indicators

# Mainframe/Power Modules Specifications

## Network Master Flex MT1100A Mainframe

User Interfaces	
Display	12.1-inch active matrix TFT display (800 × 600 pixels) and touch screen
Supported Languages	English, Chinese, Japanese, French, Russian, Spanish, Finnish, Korean, German

Service Interfaces	
USB Interface	MT1100A operates as host: USB 2.0 type A (2 ports) MT1100A operates as device: USB 2.0 type Mini-B (1 port)
Ethernet Interface	Ethernet 10M/100M/1000M, Connector: RJ45
WLAN Interface*	IEEE 802.11 b/g/n
Bluetooth Interface*	Bluetooth 2.1 + EDR

\*: Available for certified countries and regions including USA, Canada, Japan and EU countries. Please visit the Anritsu web site for updated information.

Other Interfaces	
Unit synchronization Input	(Not used)
Unit Synchronization Output	(Not used)
Audio Interface	For connection of CTIA Standard head set Connector: 3.5-mm diameter jack
AUX Connector	For connection of G0325A GPS receiver
Built-in Loudspeaker	Monitors speech of voice channel Output level: user-controlled from user Interface
Ext. Clock Input	For connection of external clock signals: • SETS (E1: 2.048 Mbps), BITS (DS1: 1.544 Mbps), or 2.048 MHz TTL signal in accordance with ITU-T G.703, 10 MHz Connector: BNC

Miscellaneous		
Dimensions and Mass	320 (W) × 225 (H) × 46 (D) mm (excluding projections), ≤2.5 kg	
Environmental	Temperature and Humidity • Operating: 0° to +40°C, ≤80% RH (non-condensing) • Storage: -20° to +60°C, ≤80% RH (non-condensing)	
CE	EMC	2014/30/EU, EN61326-1, EN61000-3-2
	LVD	2014/35/EU, EN61010-1
	RoHS	2011/65/EU, EN50581

## Battery and AC Power Supply Module MU110001A

Battery	14.4 V rechargeable and replaceable intelligent Li-ion battery Operation time: 1 hour (typ.) (with MU110011A, 100 Gbps Ethernet operation) Charging time: 6 hours (typ.) (25°C) Remaining capacity indication:%	
Power Supply	100 V(ac) to 240 V(ac), 50 Hz/60 Hz 380 VA (max.)	
Dimensions and Mass	320 (W) × 225 (H) × 82 (D) mm (excluding projections), ≤3.0 kg (without battery)	
Environmental	Temperature and Humidity • Operating: 0° to +40°C, ≤80% RH (non-condensing) • Storage: -20° to +60°C, ≤80% RH (non-condensing, without battery) -20° to +50°C, ≤80% RH (non-condensing, with battery)	
Module Combination	1 module: Un limited 2 modules: MU110010A + MU110010A MU110010A + MU110011A MU110010A + MU110013A	
CE	EMC	2014/30/EU, EN61326-1, EN61000-3-2
	LVD	2014/35/EU, EN61010-1
	RoHS	2011/65/EU, EN50581

## AC only High Power Supply Module MU110002A

Power Supply	100 V(ac) to 240 V(ac), 50 Hz/60 Hz 700 VA (max.)	
Dimensions and Mass	320 (W) × 225 (H) × 72 (D) mm (excluding projections), ≤3.0 kg	
Environmental	Temperature and Humidity • Operating: 0° to +40°C, ≤80% RH (non-condensing) • Storage: -20° to +60°C, ≤80% RH (non-condensing)	
CE	EMC	2014/30/EU, EN61326-1, EN61000-3-2
	LVD	2014/35/EU, EN61010-1
	RoHS	2011/65/EU, EN50581

# Measurement Modules Specifications

## 10G Multirate Module MU110010A

Test Port/Reference Standard	SFP/SFP+: 2 ports • SFF-8431, SFF-8472 compliant, IEEE 802.3ae-2002, IEEE 802.3-2008 compliant RJ45: 2 ports • IEEE 802.3-2008 10BASE-T, 100BASE-TX, 1000BASE-T compliant • Auto MDI-X • 10 Mbps/100 Mbps full/half duplex, 1000 Mbps full duplex BNC: 2 ports • ITU-T G.703 compliant RJ48: 2 ports • ITU-T G.703 compliant RTT Bantam: 2 ports • ANSI DS1.102 compliant																																																																																																																															
Bit Rate*1	<table border="1"> <thead> <tr> <th>Standard</th> <th>Bit Rate</th> <th>Interfaces</th> </tr> </thead> <tbody> <tr><td>10BASE-T</td><td>12.5 Mbps</td><td>RJ45</td></tr> <tr><td>100BASE-TX</td><td>125 Mbps</td><td>RJ45</td></tr> <tr><td>1000BASE-T</td><td>1.25 Gbps</td><td>RJ45</td></tr> <tr><td>100BASE-XX</td><td>125 Mbps</td><td>SFP</td></tr> <tr><td>1000BASE-XX</td><td>1.25 Gbps</td><td>SFP</td></tr> <tr><td>10GBASE-XX</td><td>10.3125 Gbps</td><td>SFP+</td></tr> <tr><td>STM-1/OC-3</td><td>155.52 Mbps</td><td>SFP</td></tr> <tr><td>STM-4/OC-12</td><td>622.08 Mbps</td><td>SFP</td></tr> <tr><td>STM-16/OC-48</td><td>2.48832 Gbps</td><td>SFP</td></tr> <tr><td>STM-64/OC-192</td><td>9.95328 Gbps</td><td>SFP+</td></tr> <tr><td>OTU1</td><td>2.666057143 Gbps</td><td>SFP</td></tr> <tr><td>OTU2</td><td>10.70922532 Gbps</td><td>SFP+</td></tr> <tr><td>OTU1e</td><td>11.04910714 Gbps</td><td>SFP+</td></tr> <tr><td>OTU2e</td><td>11.09572785 Gbps</td><td>SFP+</td></tr> <tr><td>OTU1f</td><td>11.27008929 Gbps</td><td>SFP+</td></tr> <tr><td>OTU2f</td><td>11.31764241 Gbps</td><td>SFP+</td></tr> <tr><td>1GFC</td><td>1.0625 Gbps</td><td>SFP</td></tr> <tr><td>2GFC</td><td>2.125 Gbps</td><td>SFP</td></tr> <tr><td>4GFC</td><td>4.25 Gbps</td><td>SFP</td></tr> <tr><td>8GFC</td><td>8.5 Gbps</td><td>SFP+</td></tr> <tr><td>10GFC</td><td>10.51875 Gbps</td><td>SFP+</td></tr> </tbody> </table>		Standard	Bit Rate	Interfaces	10BASE-T	12.5 Mbps	RJ45	100BASE-TX	125 Mbps	RJ45	1000BASE-T	1.25 Gbps	RJ45	100BASE-XX	125 Mbps	SFP	1000BASE-XX	1.25 Gbps	SFP	10GBASE-XX	10.3125 Gbps	SFP+	STM-1/OC-3	155.52 Mbps	SFP	STM-4/OC-12	622.08 Mbps	SFP	STM-16/OC-48	2.48832 Gbps	SFP	STM-64/OC-192	9.95328 Gbps	SFP+	OTU1	2.666057143 Gbps	SFP	OTU2	10.70922532 Gbps	SFP+	OTU1e	11.04910714 Gbps	SFP+	OTU2e	11.09572785 Gbps	SFP+	OTU1f	11.27008929 Gbps	SFP+	OTU2f	11.31764241 Gbps	SFP+	1GFC	1.0625 Gbps	SFP	2GFC	2.125 Gbps	SFP	4GFC	4.25 Gbps	SFP	8GFC	8.5 Gbps	SFP+	10GFC	10.51875 Gbps	SFP+	<table border="1"> <thead> <tr> <th>Standard</th> <th>Bit Rate</th> <th>Interfaces</th> </tr> </thead> <tbody> <tr><td>E1</td><td>2.048 Mbps</td><td>RJ48, BNC</td></tr> <tr><td>E3</td><td>34.368 Mbps</td><td>BNC</td></tr> <tr><td>E4</td><td>139.264 Mbps</td><td>BNC</td></tr> <tr><td>DS1</td><td>1.544 Mbps</td><td>RTT Bantam</td></tr> <tr><td>DS3</td><td>44.736 Mbps</td><td>BNC</td></tr> <tr><td>STM-1e/STS-3</td><td>155.52 Mbps</td><td>BNC</td></tr> <tr><td>CPRI Option1</td><td>614.4 Mbit/s</td><td>SFP</td></tr> <tr><td>CPRI Option2</td><td>1,228.8 Mbit/s</td><td>SFP</td></tr> <tr><td>CPRI Option3</td><td>2,457.6 Mbit/s</td><td>SFP, SFP+</td></tr> <tr><td>CPRI Option4</td><td>3,072.0 Mbit/s</td><td>SFP, SFP+</td></tr> <tr><td>CPRI Option5</td><td>4,915.2 Mbit/s</td><td>SFP+</td></tr> <tr><td>CPRI Option6</td><td>6,144.0 Mbit/s</td><td>SFP+</td></tr> <tr><td>CPRI Option7</td><td>9,830.4 Mbit/s</td><td>SFP+</td></tr> <tr><td>CPRI Option8</td><td>10,137.6 Mbit/s</td><td>SFP+</td></tr> <tr><td>OBSAI 1x</td><td>768 Mbit/s</td><td>SFP</td></tr> <tr><td>OBSAI 2x</td><td>1,536 Mbit/s</td><td>SFP, SFP+</td></tr> <tr><td>OBSAI 4x</td><td>3,072 Mbit/s</td><td>SFP, SFP+</td></tr> <tr><td>OBSAI 8x</td><td>6,144 Mbit/s</td><td>SFP+</td></tr> </tbody> </table>			Standard	Bit Rate	Interfaces	E1	2.048 Mbps	RJ48, BNC	E3	34.368 Mbps	BNC	E4	139.264 Mbps	BNC	DS1	1.544 Mbps	RTT Bantam	DS3	44.736 Mbps	BNC	STM-1e/STS-3	155.52 Mbps	BNC	CPRI Option1	614.4 Mbit/s	SFP	CPRI Option2	1,228.8 Mbit/s	SFP	CPRI Option3	2,457.6 Mbit/s	SFP, SFP+	CPRI Option4	3,072.0 Mbit/s	SFP, SFP+	CPRI Option5	4,915.2 Mbit/s	SFP+	CPRI Option6	6,144.0 Mbit/s	SFP+	CPRI Option7	9,830.4 Mbit/s	SFP+	CPRI Option8	10,137.6 Mbit/s	SFP+	OBSAI 1x	768 Mbit/s	SFP	OBSAI 2x	1,536 Mbit/s	SFP, SFP+	OBSAI 4x	3,072 Mbit/s	SFP, SFP+	OBSAI 8x	6,144 Mbit/s	SFP+
Standard	Bit Rate	Interfaces																																																																																																																														
10BASE-T	12.5 Mbps	RJ45																																																																																																																														
100BASE-TX	125 Mbps	RJ45																																																																																																																														
1000BASE-T	1.25 Gbps	RJ45																																																																																																																														
100BASE-XX	125 Mbps	SFP																																																																																																																														
1000BASE-XX	1.25 Gbps	SFP																																																																																																																														
10GBASE-XX	10.3125 Gbps	SFP+																																																																																																																														
STM-1/OC-3	155.52 Mbps	SFP																																																																																																																														
STM-4/OC-12	622.08 Mbps	SFP																																																																																																																														
STM-16/OC-48	2.48832 Gbps	SFP																																																																																																																														
STM-64/OC-192	9.95328 Gbps	SFP+																																																																																																																														
OTU1	2.666057143 Gbps	SFP																																																																																																																														
OTU2	10.70922532 Gbps	SFP+																																																																																																																														
OTU1e	11.04910714 Gbps	SFP+																																																																																																																														
OTU2e	11.09572785 Gbps	SFP+																																																																																																																														
OTU1f	11.27008929 Gbps	SFP+																																																																																																																														
OTU2f	11.31764241 Gbps	SFP+																																																																																																																														
1GFC	1.0625 Gbps	SFP																																																																																																																														
2GFC	2.125 Gbps	SFP																																																																																																																														
4GFC	4.25 Gbps	SFP																																																																																																																														
8GFC	8.5 Gbps	SFP+																																																																																																																														
10GFC	10.51875 Gbps	SFP+																																																																																																																														
Standard	Bit Rate	Interfaces																																																																																																																														
E1	2.048 Mbps	RJ48, BNC																																																																																																																														
E3	34.368 Mbps	BNC																																																																																																																														
E4	139.264 Mbps	BNC																																																																																																																														
DS1	1.544 Mbps	RTT Bantam																																																																																																																														
DS3	44.736 Mbps	BNC																																																																																																																														
STM-1e/STS-3	155.52 Mbps	BNC																																																																																																																														
CPRI Option1	614.4 Mbit/s	SFP																																																																																																																														
CPRI Option2	1,228.8 Mbit/s	SFP																																																																																																																														
CPRI Option3	2,457.6 Mbit/s	SFP, SFP+																																																																																																																														
CPRI Option4	3,072.0 Mbit/s	SFP, SFP+																																																																																																																														
CPRI Option5	4,915.2 Mbit/s	SFP+																																																																																																																														
CPRI Option6	6,144.0 Mbit/s	SFP+																																																																																																																														
CPRI Option7	9,830.4 Mbit/s	SFP+																																																																																																																														
CPRI Option8	10,137.6 Mbit/s	SFP+																																																																																																																														
OBSAI 1x	768 Mbit/s	SFP																																																																																																																														
OBSAI 2x	1,536 Mbit/s	SFP, SFP+																																																																																																																														
OBSAI 4x	3,072 Mbit/s	SFP, SFP+																																																																																																																														
OBSAI 8x	6,144 Mbit/s	SFP+																																																																																																																														
Tx Ref. Clock Output	Frequency : Selectable from 1/16, or 1/64 against the bit rate. (Available only when one of SFP ports is selected) Level : 250 mVp-p (min.), 550 mVp-p (max.) Termination : 50Ω/AC (Single ended) Connector : SMA																																																																																																																															
Dimensions and Mass	320 (W) × 225 (H) × 37 (D) mm, ≤1.4 kg																																																																																																																															
Environmental	Temperature and Humidity • Operating : 0° to +40°C, ≤80% RH (non-condensing) • Storage : -20° to +60°C, ≤80% RH (non-condensing)																																																																																																																															
CE	EMC	2014/30/EU, EN61326-1, EN61000-3-2																																																																																																																														
	LVD	2014/35/EU, EN61010-1																																																																																																																														
	RoHS	2011/65/EU, EN50581																																																																																																																														
Laser Safety*3	IEC 60825-1: 2007 CLASS 1 21CFR1040.10 and 1040.11*2																																																																																																																															

\*1: The frequency accuracy depends on the accuracy of the MT1100A internal clock or the external clock of MT1100A.

Refer to the external interfaces in MT1100A specifications.

\*2: Excludes deviations caused by conformance to Laser Notice No. 50 dated June 24, 2007

\*3: Safety measures for laser products

This product complies with optical safety standards in 21CFR1040.10, 1040.11 and IEC 60825-1; the following descriptive labels are affixed to the product.

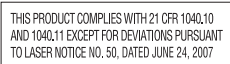

# Measurement Modules Specifications

## 100G Multirate Module MU110011A

Test Port/Reference Standard	CFP: 1 port • CFP MSA Hardware Specification, Rev. 1.4 compliant • CFP MSA Management Interface Specification V2.2 R06a compliant (Not supported to MSA 100GLH) • IEEE 802.3ba-2010 compliant QSFP+: 2 ports • SFF-8436, SFF-8472 compliant • IEEE 802.3ba-2010 compliant SFP/SFP+: 2 ports • SFF-8431, SFF-8472 compliant • IEEE 802.3ae-2002, IEEE 802.3-2008 compliant RJ45: 2 ports • IEEE 802.3-2008 10BASE-T, 100BASE-TX, 1000BASE-T compliant • Auto MDI-X • 10 Mbps/100 Mbps full/half duplex, 1000 Mbps full duplex																																																																																																																																														
Bit Rate*1	<table border="1"> <thead> <tr> <th>Standard</th> <th>Bit Rate</th> <th>Interfaces</th> </tr> </thead> <tbody> <tr><td>10BASE-T</td><td>12.5 Mbps</td><td>RJ45</td></tr> <tr><td>100BASE-TX</td><td>125.0 Mbps</td><td>RJ45</td></tr> <tr><td>1000BASE-T</td><td>1.25 Gbps</td><td>RJ45</td></tr> <tr><td>100BASE-XX</td><td>125.0 Mbps</td><td>SFP</td></tr> <tr><td>1000BASE-XX</td><td>1.25 Gbps</td><td>SFP</td></tr> <tr><td>10GBASE-XX</td><td>10.3125 Gbps</td><td>SFP+</td></tr> <tr><td>40 GigE</td><td>40.3125 Gbps × 4 Lane</td><td>CFP, QSFP+</td></tr> <tr><td>40GBASE-FR</td><td>41.25 Gbps</td><td>CFP</td></tr> <tr><td>100 GigE</td><td>100.3125 Gbps × 10 Lane</td><td>CFP</td></tr> <tr><td>STM-1/OC-3</td><td>155.52 Mbps</td><td>SFP</td></tr> <tr><td>STM-4/OC-12</td><td>622.08 Mbps</td><td>SFP</td></tr> <tr><td>STM-16/OC-48</td><td>2.48832 Gbps</td><td>SFP</td></tr> <tr><td>STM-64/OC-192</td><td>9.95328 Gbps</td><td>SFP+</td></tr> <tr><td>STM-256/OC-768</td><td>9.95328 Gbps × 4 Lane</td><td>CFP</td></tr> <tr><td>FR model</td><td>39.81312 Gbps</td><td>CFP</td></tr> <tr><td>OTU1</td><td>2.666057143 Gbps</td><td>SFP</td></tr> <tr><td>OTU2</td><td>10.70922532 Gbps</td><td>SFP+</td></tr> <tr><td>OTU1e</td><td>11.04910714 Gbps</td><td>SFP+</td></tr> <tr><td>OTU2e</td><td>11.09572785 Gbps</td><td>SFP+</td></tr> <tr><td>OTU1f</td><td>11.27008929 Gbps</td><td>SFP+</td></tr> <tr><td>OTU2f</td><td>11.31764241 Gbps</td><td>SFP+</td></tr> <tr><td>OTU3</td><td>10.75460339 Gbps × 4 Lane</td><td>CFP, QSFP+</td></tr> <tr><td>FR model</td><td>43.01841356 Gbps</td><td>CFP</td></tr> </tbody> </table>	Standard	Bit Rate	Interfaces	10BASE-T	12.5 Mbps	RJ45	100BASE-TX	125.0 Mbps	RJ45	1000BASE-T	1.25 Gbps	RJ45	100BASE-XX	125.0 Mbps	SFP	1000BASE-XX	1.25 Gbps	SFP	10GBASE-XX	10.3125 Gbps	SFP+	40 GigE	40.3125 Gbps × 4 Lane	CFP, QSFP+	40GBASE-FR	41.25 Gbps	CFP	100 GigE	100.3125 Gbps × 10 Lane	CFP	STM-1/OC-3	155.52 Mbps	SFP	STM-4/OC-12	622.08 Mbps	SFP	STM-16/OC-48	2.48832 Gbps	SFP	STM-64/OC-192	9.95328 Gbps	SFP+	STM-256/OC-768	9.95328 Gbps × 4 Lane	CFP	FR model	39.81312 Gbps	CFP	OTU1	2.666057143 Gbps	SFP	OTU2	10.70922532 Gbps	SFP+	OTU1e	11.04910714 Gbps	SFP+	OTU2e	11.09572785 Gbps	SFP+	OTU1f	11.27008929 Gbps	SFP+	OTU2f	11.31764241 Gbps	SFP+	OTU3	10.75460339 Gbps × 4 Lane	CFP, QSFP+	FR model	43.01841356 Gbps	CFP	<table border="1"> <thead> <tr> <th>Standard</th> <th>Bit Rate</th> <th>Interfaces</th> </tr> </thead> <tbody> <tr><td>OTU3e1</td><td>11.14274364 Gbps × 4 Lane</td><td>CFP, QSFP+</td></tr> <tr><td>FR model</td><td>44.57097456 Gbps</td><td>CFP</td></tr> <tr><td>OTU3e2</td><td>11.14583889 Gbps × 4 Lane</td><td>CFP, QSFP+</td></tr> <tr><td>FR model</td><td>44.58335556 Gbps</td><td>CFP</td></tr> <tr><td>OTU4</td><td>11.18099736 Gbps × 10 Lane</td><td>CFP</td></tr> <tr><td>1GFC</td><td>1.0625 Gbps</td><td>SFP</td></tr> <tr><td>2GFC</td><td>2.125 Gbps</td><td>SFP</td></tr> <tr><td>4GFC</td><td>4.25 Gbps</td><td>SFP</td></tr> <tr><td>8GFC</td><td>8.5 Gbps</td><td>SFP+</td></tr> <tr><td>10GFC</td><td>10.51875 Gbps</td><td>SFP+</td></tr> <tr><td>CPRI Option1</td><td>614.4 Mbps</td><td>SFP</td></tr> <tr><td>CPRI Option2</td><td>1,228.8 Mbps</td><td>SFP</td></tr> <tr><td>CPRI Option3</td><td>2,457.6 Mbps</td><td>SFP, SFP+</td></tr> <tr><td>CPRI Option4</td><td>3,072.0 Mbps</td><td>SFP, SFP+</td></tr> <tr><td>CPRI Option5</td><td>4,915.2 Mbps</td><td>SFP+</td></tr> <tr><td>CPRI Option6</td><td>6,144.0 Mbps</td><td>SFP+</td></tr> <tr><td>CPRI Option7</td><td>9,830.4 Mbps</td><td>SFP+</td></tr> <tr><td>CPRI Option8</td><td>10,137.6 Mbps</td><td>SFP+</td></tr> <tr><td>OBSAI 1x</td><td>768 Mbps</td><td>SFP</td></tr> <tr><td>OBSAI 2x</td><td>1,536 Mbps</td><td>SFP, SFP+</td></tr> <tr><td>OBSAI 4x</td><td>3,072 Mbps</td><td>SFP, SFP+</td></tr> <tr><td>OBSAI 8x</td><td>6,144 Mbps</td><td>SFP+</td></tr> </tbody> </table>	Standard	Bit Rate	Interfaces	OTU3e1	11.14274364 Gbps × 4 Lane	CFP, QSFP+	FR model	44.57097456 Gbps	CFP	OTU3e2	11.14583889 Gbps × 4 Lane	CFP, QSFP+	FR model	44.58335556 Gbps	CFP	OTU4	11.18099736 Gbps × 10 Lane	CFP	1GFC	1.0625 Gbps	SFP	2GFC	2.125 Gbps	SFP	4GFC	4.25 Gbps	SFP	8GFC	8.5 Gbps	SFP+	10GFC	10.51875 Gbps	SFP+	CPRI Option1	614.4 Mbps	SFP	CPRI Option2	1,228.8 Mbps	SFP	CPRI Option3	2,457.6 Mbps	SFP, SFP+	CPRI Option4	3,072.0 Mbps	SFP, SFP+	CPRI Option5	4,915.2 Mbps	SFP+	CPRI Option6	6,144.0 Mbps	SFP+	CPRI Option7	9,830.4 Mbps	SFP+	CPRI Option8	10,137.6 Mbps	SFP+	OBSAI 1x	768 Mbps	SFP	OBSAI 2x	1,536 Mbps	SFP, SFP+	OBSAI 4x	3,072 Mbps	SFP, SFP+	OBSAI 8x	6,144 Mbps	SFP+
Standard	Bit Rate	Interfaces																																																																																																																																													
10BASE-T	12.5 Mbps	RJ45																																																																																																																																													
100BASE-TX	125.0 Mbps	RJ45																																																																																																																																													
1000BASE-T	1.25 Gbps	RJ45																																																																																																																																													
100BASE-XX	125.0 Mbps	SFP																																																																																																																																													
1000BASE-XX	1.25 Gbps	SFP																																																																																																																																													
10GBASE-XX	10.3125 Gbps	SFP+																																																																																																																																													
40 GigE	40.3125 Gbps × 4 Lane	CFP, QSFP+																																																																																																																																													
40GBASE-FR	41.25 Gbps	CFP																																																																																																																																													
100 GigE	100.3125 Gbps × 10 Lane	CFP																																																																																																																																													
STM-1/OC-3	155.52 Mbps	SFP																																																																																																																																													
STM-4/OC-12	622.08 Mbps	SFP																																																																																																																																													
STM-16/OC-48	2.48832 Gbps	SFP																																																																																																																																													
STM-64/OC-192	9.95328 Gbps	SFP+																																																																																																																																													
STM-256/OC-768	9.95328 Gbps × 4 Lane	CFP																																																																																																																																													
FR model	39.81312 Gbps	CFP																																																																																																																																													
OTU1	2.666057143 Gbps	SFP																																																																																																																																													
OTU2	10.70922532 Gbps	SFP+																																																																																																																																													
OTU1e	11.04910714 Gbps	SFP+																																																																																																																																													
OTU2e	11.09572785 Gbps	SFP+																																																																																																																																													
OTU1f	11.27008929 Gbps	SFP+																																																																																																																																													
OTU2f	11.31764241 Gbps	SFP+																																																																																																																																													
OTU3	10.75460339 Gbps × 4 Lane	CFP, QSFP+																																																																																																																																													
FR model	43.01841356 Gbps	CFP																																																																																																																																													
Standard	Bit Rate	Interfaces																																																																																																																																													
OTU3e1	11.14274364 Gbps × 4 Lane	CFP, QSFP+																																																																																																																																													
FR model	44.57097456 Gbps	CFP																																																																																																																																													
OTU3e2	11.14583889 Gbps × 4 Lane	CFP, QSFP+																																																																																																																																													
FR model	44.58335556 Gbps	CFP																																																																																																																																													
OTU4	11.18099736 Gbps × 10 Lane	CFP																																																																																																																																													
1GFC	1.0625 Gbps	SFP																																																																																																																																													
2GFC	2.125 Gbps	SFP																																																																																																																																													
4GFC	4.25 Gbps	SFP																																																																																																																																													
8GFC	8.5 Gbps	SFP+																																																																																																																																													
10GFC	10.51875 Gbps	SFP+																																																																																																																																													
CPRI Option1	614.4 Mbps	SFP																																																																																																																																													
CPRI Option2	1,228.8 Mbps	SFP																																																																																																																																													
CPRI Option3	2,457.6 Mbps	SFP, SFP+																																																																																																																																													
CPRI Option4	3,072.0 Mbps	SFP, SFP+																																																																																																																																													
CPRI Option5	4,915.2 Mbps	SFP+																																																																																																																																													
CPRI Option6	6,144.0 Mbps	SFP+																																																																																																																																													
CPRI Option7	9,830.4 Mbps	SFP+																																																																																																																																													
CPRI Option8	10,137.6 Mbps	SFP+																																																																																																																																													
OBSAI 1x	768 Mbps	SFP																																																																																																																																													
OBSAI 2x	1,536 Mbps	SFP, SFP+																																																																																																																																													
OBSAI 4x	3,072 Mbps	SFP, SFP+																																																																																																																																													
OBSAI 8x	6,144 Mbps	SFP+																																																																																																																																													
Tx Ref. Clock Output	Frequency: Select 1/16 or 1/64 for bit rates of 10G or less. Select 1/16 or 1/64 for each lane rate for XLAUI and OTL3.4 of 40G. Select 1/16 or 1/64 for each lane rate for CAUI and OTL4.19 of 100G. (RJ45 port cannot be selected) Level: 250 mVp-p (min.), 550 mVp-p (max.) Termination: 50Ω/AC (Single ended) Connector: SMA																																																																																																																																														
Dimensions and Mass	320 (W) × 225 (H) × 60 (D) mm, ≤3.0 kg																																																																																																																																														
Environmental	Temperature and Humidity • Operating : 0° to +40°C, ≤80% RH (non-condensing) • Storage : -20° to +60°C, ≤80% RH (non-condensing)																																																																																																																																														
CE	EMC	2014/30/EU, EN61326-1, EN61000-3-2																																																																																																																																													
	LVD	2014/35/EU, EN61010-1																																																																																																																																													
	RoHS	2011/65/EU, EN50581																																																																																																																																													
Laser Safety*3	IEC 60825-1: 2007 CLASS 1 21CFR1040.10 and 1040.11*1 CFP : 100GBASE-LR4, 40GBASE-LR4, 40GBASE-FR QSFP+ : 40GBASE-LR4 SFP : 4GFC(SX), 4GFC(LX), 4GFC(EX), OC-48 LR-1/STM L-16.1, OC-48 LR-2/STM L-16.2, 100BASE-FX, 100BASE-LX SFP+ : 1000BASE-SX/LX/ZX, 10GBASE-LR, 10GBASE-ER, 10GBASE-ZR  IEC 60825-1: 2007 CLASS 1M 21CFR1040.10 and 1040.11*1 CFP : 100G BASE-SR10 QSFP+ : 40GBASE-SR4																																																																																																																																														

\*1: The frequency accuracy depends on the accuracy of the MT1100A internal clock or the external clock of MT1100A.

Refer to the external interfaces in MT1100A specifications.

\*2: Excludes deviations caused by conformance to Laser Notice No. 50 dated June 24, 2007

\*3: Safety measures for laser products

This product complies with optical safety standards in 21CFR1040.10, 1040.11 and IEC 60825-1; the following descriptive labels are affixed to the product.



THIS PRODUCT COMPLIES WITH 21 CFR 1040.10 AND 1040.11 EXCEPT FOR DEVIATIONS PURSUANT TO LASER NOTICE NO. 50, DATED JUNE 24, 2007

# Measurement Modules Specifications

## 40/100G Advanced Module MU110013A

Test Port/Reference Standard	<p>CFP2: 2 ports</p> <ul style="list-style-type: none"> <li>• CFP MSA CFP2 Hardware Specification, Rev. 1.0 compliant</li> <li>• CFP MSA Management Interface Specification V2.2 R06a compliant (Not supported to MSA 100GLH)</li> <li>• IEEE 802.3ba-2010 compliant</li> </ul> <p>CXP: 2 ports</p> <ul style="list-style-type: none"> <li>• InfiniBand Architecture 1.2.1 Annex A6: CXP compliant</li> <li>• SFF-8642, IEEE 802.3ba-2010 compliant</li> </ul> <p>QSFP+: 2 ports</p> <ul style="list-style-type: none"> <li>• SFF-8436, SFF-8472 compliant</li> <li>• IEEE 802.3ba-2010 compliant</li> </ul>																										
Bit Rate*1	<table border="1"> <thead> <tr> <th>Standard</th> <th>Bit Rate</th> <th>Interfaces</th> </tr> </thead> <tbody> <tr> <td>40 GigE</td> <td>10.3125 Gbps × 4 Lane</td> <td>QSFP+</td> </tr> <tr> <td>100 GigE</td> <td>10.3125 Gbps × 10 Lane</td> <td>CXP</td> </tr> <tr> <td>100 GigE</td> <td>25.78125 Gbps × 4 Lane</td> <td>CFP2, QSFP28*2</td> </tr> <tr> <td>OTU3</td> <td>10.75460339 Gbps × 4 Lane</td> <td>QSFP+</td> </tr> <tr> <td>OTU3e1</td> <td>11.14274364 Gbps × 4 Lane</td> <td>QSFP+</td> </tr> <tr> <td>OTU3e2</td> <td>11.14583889 Gbps × 4 Lane</td> <td>QSFP+</td> </tr> <tr> <td>OTU4</td> <td>27.952493392 Gbps × 4 Lane</td> <td>CFP2, QSFP28*2</td> </tr> </tbody> </table>			Standard	Bit Rate	Interfaces	40 GigE	10.3125 Gbps × 4 Lane	QSFP+	100 GigE	10.3125 Gbps × 10 Lane	CXP	100 GigE	25.78125 Gbps × 4 Lane	CFP2, QSFP28*2	OTU3	10.75460339 Gbps × 4 Lane	QSFP+	OTU3e1	11.14274364 Gbps × 4 Lane	QSFP+	OTU3e2	11.14583889 Gbps × 4 Lane	QSFP+	OTU4	27.952493392 Gbps × 4 Lane	CFP2, QSFP28*2
Standard	Bit Rate	Interfaces																									
40 GigE	10.3125 Gbps × 4 Lane	QSFP+																									
100 GigE	10.3125 Gbps × 10 Lane	CXP																									
100 GigE	25.78125 Gbps × 4 Lane	CFP2, QSFP28*2																									
OTU3	10.75460339 Gbps × 4 Lane	QSFP+																									
OTU3e1	11.14274364 Gbps × 4 Lane	QSFP+																									
OTU3e2	11.14583889 Gbps × 4 Lane	QSFP+																									
OTU4	27.952493392 Gbps × 4 Lane	CFP2, QSFP28*2																									
Tx Ref. Clock Output	<p>Frequency</p> <p>Select 1/16 or 1/64 for each lane rate of XX.</p> <p>40 GigE : XLAUI</p> <p>OTU3, OTU3e1, OTU3e2: OTL3.4</p> <p>100 GigE : CAUI</p> <p>OTU4 : OTL4.10</p> <p>Level: 250 mVp-p (min.), 550 mVp-p (max.)</p> <p>Termination: 50Ω/AC (Single ended)</p> <p>Connector: SMA</p>																										
Sync Clock Output	<p>Frequency</p> <p>Select 1/8 or 1/16 against the bit rate of the data lane for CFP2 port.</p> <p>100 GigE : CAUI4</p> <p>OTU4 : OTL 4.4</p> <p>Level: 150 mVp-p (min.), 650 mVp-p (max.)</p> <p>Termination: 50Ω/AC (Single ended)</p> <p>Connector: SMA</p>																										
Dimensions and Mass	320 (W) × 225 (H) × 60 (D) mm, ≤3.0 kg																										
Environmental	<p>Temperature and Humidity</p> <ul style="list-style-type: none"> <li>• Operating : 0° to +40°C, ≤80% RH (non-condensing)</li> <li>• Storage : -20° to +60°C, ≤80% RH (non-condensing)</li> </ul>																										
CE	EMC	2014/30/EU, EN61326-1, EN61000-3-2																									
	LVD	2014/35/EU, EN61010-1																									
	RoHS	2011/65/EU, EN50581																									
Laser Safety*4	<p>IEC 60825-1: 2007 CLASS 1</p> <p>21CFR1040.10 and 1040.11*3</p> <p>QSFP+ : 40G BASE-LR4</p> <p>CFP2 : 100G BASE-LR4</p> <p>QSFP28: 100G BASE-LR4</p> <p>IEC 60825-1: 2007 CLASS 1M</p> <p>21CFR1040.10 and 1040.11*3</p> <p>QSFP+ : 40G BASE-SR4</p> <p>CXP : 100G BASE-SR10</p> <p>QSFP28: 100G BASE-SR4</p>																										

\*1: The frequency accuracy depends on the accuracy of the MT1100A internal clock or the external clock of MT1100A.

Refer to the external interfaces in MT1100A specifications.

\*2: Enabled only with Z2046A, Z2047A, and Z2048A.

\*3: Excludes deviations caused by conformance to Laser Notice No. 50 dated June 24, 2007

\*4: Safety measures for laser products

This product complies with optical safety standards in 21CFR1040.10, 1040.11 and IEC 60825-1; the following descriptive labels are affixed to the product.

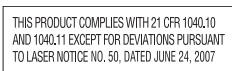

# Ethernet Testing Specifications

## Ethernet Testing

Ethernet Test	
Test Configuration	• Monitor/Generate, Pass-through, Reflector
Auto MDI-X	On/Off
Encapsulation	• EtherType II (DIX v.2), IEEE 802.3 with 802.2 (LLC1), IEEE 802.3 with SNAP
100 GigE FEC	Interface : CFP2 slots FEC enable: On/Off FEC Code : RS (528, 514, 7, 10) FEC status & counter Loss of FEC alignment, Corrected CW, Uncorrectable CW, Corrected Symbol each lane FEC related Error Injection Bit error per CAUI4 lane encoded RS-FEC (Injection timing is Single/Burst.)

Configuration, Monitor/Generate	
Traffic Generation	<ul style="list-style-type: none"> <li>• Variable line rate traffic generation, up to full line rate</li> <li>• Line load profile: Constant, Ramp</li> <li>• Traffic duration: Continuous, Programmable number of seconds or frames</li> <li>• Adjustable frame size: 60 bytes to 16000 bytes</li> <li>• Frame sizes: Constant, Stepped, Random</li> <li>• Payload profiles: Data, Video, Voice</li> <li>• User-defined traffic mix of unicast and broadcast frames</li> <li>• Fixed or incremented IP identifier</li> <li>• User programmable DSCP/TOS byte</li> <li>• Configurable IP and Ethernet source and destination addresses (supports IPv4 and IPv6 addressing) <ul style="list-style-type: none"> <li>IPv4: Fixed, DHCP, DNS</li> <li>IPv6: Fixed <ul style="list-style-type: none"> <li>• Address increment, Decrement and Random generation supported</li> </ul> </li> </ul> </li> <li>• User programmable UDP/TCP address</li> <li>• Automatic TCP connect (user selectable)</li> <li>• UDP check sum: Automatic, Fixed (null); TCP check sum: Automatic</li> <li>• Generate pause frames, Respond to pause frames</li> <li>• Answer incoming ARP, Ping requests (On/Off)</li> </ul>
Stacked VLAN	Up to 8 user-settable VLAN tags Parameters per VLAN tag: <ul style="list-style-type: none"> <li>• Ether-type 0x8100 (802.1Q), 0x88a8 (802.1ad), 0x9100 or 0x9200</li> <li>• User-defined VLAN ID, CFI, VLAN priority</li> <li>• Address increment, Decrement and Random generation supported</li> </ul> Only one VLAN level supported at traceroute and RFC 2544 router latency tests. Only two VLAN level supported at ping.
Multistream	Number of streams: Up to 16 streams per port can be activated
Transmit Signal Clock Sources	Internal, Received clock, 2-MHz signal, SETS (E1: 2.048 Mbps), BITS (DS1: 1.544 Mbps), PTP (IEEE 1588 v2) recovered clock or signal from optional GPS receiver Frequency deviation: ±200 ppm (0.1 ppm steps)
Receiver Setting	<ul style="list-style-type: none"> <li>• User-defined expected preamble length: 3 bytes to 15 bytes</li> <li>• User-defined IFG lower threshold: 8 bytes to 15 bytes (Ethernet 10 Mbps, 100 Mbps, 1000 Mbps)</li> <li>• User-defined Jumbo frame size upper limit: 1519 bytes to 16000 bytes</li> </ul>
Error Generation	FCS, Preamble, Error symbol, IFG for ethernet 10 Mbps, 100 Mbps, 1000 Mbps, Wrong IP check sum, Fragmented IP, Wrong layer 4 check sum, PRBS bit error, BER test sequence error 40 Gbps/100 Gbps: Invalid block type (0x00, 0x2d, 0x33, 0x66), Invalid sync. header (00, 11), Invalid alignment marker, BIP error
Alarm Generation	No link, Remote fault, Local fault (10 Gbps) PCS 10 Gbps/40 Gbps/100 Gbps: High BER
PCS Skew	40 Gbps, 100 Gbps <ul style="list-style-type: none"> <li>• Insertion <ul style="list-style-type: none"> <li>100 Gbps Tx lane: 0 to 4224 bits</li> <li>40 Gbps, 100 Gbps physical lane: 0 to 8448 bits</li> </ul> </li> <li>• Detection <ul style="list-style-type: none"> <li>Relative skew, Marker map</li> </ul> </li> </ul>



# Ethernet Testing Specifications

Result, Monitor/Generate	
Status	<ul style="list-style-type: none"> <li>Link status, Interface type, Jabber detected, Frames present, MPLS/EoMPLS/VLAN, Speed, Full or half duplex, Local clock (Ethernet 1000 Mbps), LFS LF/RF (Ethernet 10 Gbps), Signal present, Bit rate of incoming Ethernet signal, Auto negotiation complete</li> <li>Link partner abilities: Pause capable and Asymmetric pause request (not Ethernet 10 Gbps), Remote fault, Speed/Duplex</li> <li>Indicators for Utilization, Throughput and Errored frames</li> <li>Signal level indication for optical Ethernet interfaces</li> </ul>
Resolution	User-defined resolution for statistical measurements: 1, 2, 5, 10, 15, 30 s, 1, 5, 10, 15, 30 min, 1, 2, 4, 6, 12 h Event log: Major measurement events incl. errors and alarms are logged with 1-second resolution.
Performance Statistics	• Utilization (Max./Min./Avg.), Throughput (Max./Min./Avg.), Frame rate (Max./Min./Avg.)
Frame Statistics	<ul style="list-style-type: none"> <li>Total frames, Total valid frames, Unicast/Multicast/Broadcast frames, Number of pause frames</li> <li>Number of VLAN tagged frames, Max. number of VLAN layers detected, Last received VLAN ID, Last received VLAN priority</li> <li>Number of MPLS frames and MPLS-TP frames. Max. number of MPLS layers detected. Last received MPLS Label, MPLS Priority and MPLS TTL.</li> <li>Number of PBB frames. Last received B/I-tag ID and B/I-tag priority.</li> <li>Total errored frames, Fragmented frames, Number of oversized and undersized (runts) frames, Number of FCS errored frames, Error symbol frames (not Ethernet 10 Gbps)/Code violation frames (Ethernet 10 Gbps), Number of collisions (10 Mbps, 100 Mbps half duplex), Preamble violations, IFG violations (Ethernet 10 Mbps, 100 Mbps, 1000 Mbps), False carrier, 10G LFS LF (local fault), 10G LFS RF (remote fault)</li> </ul>
Burst Statistics	Total frames, Total valid frames, Number of burst, Total frames in bursts, Burst size (Max./Min./Avg.)
Frame Distribution Statistics	<ul style="list-style-type: none"> <li>Total valid/ frames, 64 to 127, 128 to 255, 256 to 511, 512 to 1023, 1024 to 1518 byte frames, Total number of jumbo frames</li> <li>Frame size (Max./Min./Avg.)</li> </ul>
Multistream Statistics	Available information per stream: • Frame loss count/rate, Throughput, Latency, Packet jitter, Frames and bytes received and transmitted
Transmit Statistics	Total frames, Total valid frames, Unicast/Multicast/Broadcast frames, FCS errors, Total errors 64 to 127, 128 to 255, 256 to 511, 512 to 1023, 1024 to 1518 byte frames, Total number of jumbo frames Total number of frames (Tx (own port) – Rx (selectable port))
Filter	Up to 8 filter conditions can be defined. Each condition can filter using: IP or MAC source address, IP or MAC destination address, Broadcast address, IEEE OUI value, Encapsulation type, VLAN ID and VLAN tag priority, MPLS, PBB source and destination MAC address, PBB B/I-tag, MPLS-TP source and destination MAC address, TPC/UDP source and destination port, User-defined pattern at defined offset
Adjustable Thresholds	Utilization, Throughput, Errored frames, Collision rate, Unicast frames, Multicast frames, Broadcast frames, Pause frames, Fragmented frames, Undersized frames (runts), Oversized frames, FCS errored frames, IFG violations (Ethernet 10 Mbps, 100 Mbps, 1000 Mbps), Preamble violations, BER test pattern errors, Sequence errors, Diff.Tx-Rx
DHCP	<ul style="list-style-type: none"> <li>Display source IP address assigned by DHCP</li> <li>Display current lease expire time</li> <li>Display IP addresses of primary and secondary DNS server when obtained by DHCP</li> <li>Gateway setup using DHCP</li> </ul>
NDP	• Apply and show source IPv6 address assigned by NDP

BER Test and Service Disruption Measurement	
BER Test	<p>Generation and detection of test patterns, Count of errors in received test pattern, Pattern generation: Unframed (Layer 1), Framed Ethernet (MAC) header (Layer 2), Framed Ethernet (MAC) header with IP header (Layer 3) or Framed Ethernet (MAC) header, Framed with IP header and TCP/UDP header (Layer 4), User-defined header pattern (14 byte to 256 byte)</p> <p>Detection of sequence errors and loss of sequence synchronization</p> <p>Frame loss count and frame loss seconds</p> <p>Throughput measurement results are calculated for:</p> <ul style="list-style-type: none"> <li>Utilization layer, Physical layer, Physical layer excluding preamble, Link layer, Network layer and Data layer</li> <li>Min./Max./Avg. values</li> </ul> <p>Performance (M.2100 type) parameters: ES, SES, ALS, UAT, AVT, EFS</p> <p>Test patterns: PRBS 9, PRBS 11, PRBS 15, PRBS 20, PRBS 23, PRBS 29, PRBS 31, HF test pattern, CRPAT, JTPAT, SPAT, 55 Hex, Fox, 32-bit user programmable</p> <p>User-defined resolution: 1, 2, 5, 10, 15, 30 s, 1, 5, 10, 15, 30 min, 1, 2, 4, 6, 12 h</p>
Error Generation	FCS, Preamble, Error symbol, IFG for Electrical Interface (10 Mbps, 100 Mbps, 1000 Mbps), Wrong IP check sum, Fragmented IP, Wrong layer 4 check sum, PRBS bit error, BER test sequence error
Alarm Generation	No link, Remote fault
Service Disruption Measurement	Service disruption measurement activated as part of BER test <ul style="list-style-type: none"> <li>Max./Avg. service disruption time, Resolution: 0.1 μs</li> <li>Number of service disruptions</li> <li>Disruption Type: Packet, LOS</li> </ul>

RFC 2544 Test	
RFC 2544 Test	<p>Switch/Router test and Single ended network test modes:</p> <ul style="list-style-type: none"> <li>Throughput, Frame loss, Latency or Packet jitter, Back-to-back frames (burstability)</li> </ul> <p>End-to-end network test mode (two MT1100A units in Local-remote setup):</p> <ul style="list-style-type: none"> <li>Throughput, Frame loss, Back-to-back frames (burstability)</li> </ul> <p>Router latency test mode:</p> <ul style="list-style-type: none"> <li>IP ping based latency test or packet jitter</li> </ul>

# Ethernet Testing Specifications

Service Activation Test (Y.1564)	
Service Activation Test	<p>ITU-T Y.1564 Service Activation Test</p> <ul style="list-style-type: none"> <li>• Up to 8 services per port</li> <li>• Color-aware and non-color-aware in combinations (IP DSCP or VLAN PCP)</li> <li>• Test modes: One-way (uni- or bi-directional, symmetrical or asymmetrical), Round-trip</li> <li>• Verification against service acceptance criteria: Information rate, Frame transfer delay, Frame delay variation, Frame loss rate, Availability</li> </ul> <p>Optional GPS timing synchronization</p>
Service Configuration Test	<ul style="list-style-type: none"> <li>• Subtests for: Committed information rate, Excess information rate, Traffic policing, Committed burst size, Excess burst size</li> <li>• Step duration: 1 s to 60 s (user programmable)</li> <li>• Number of steps: 1 to 10 (user programmable)</li> <li>• Slope: Rising/Falling</li> <li>• Results: Pass/Fail indication, IR (Max./Min./Avg.), FL (Count/FLR), FTD, FDV (Max./Min./Avg./Current (during measurement))</li> </ul>
Service Performance Test	<ul style="list-style-type: none"> <li>• All services tested simultaneously at CIR</li> <li>• Duration 15 min, 2 h, 24 h, user programmable</li> <li>• Results: Pass/Fail indication, IR (Max./Min./Avg.), FL (Count/FLR), FTD, FDV (Max./Min./Avg./Current (during measurement)), AVAIL (%), Unavail (s)</li> </ul>

RFC 6349 TCP Throughput Test	
TCP Throughput Test	<p>TCP Throughput Test According to RFC 6349</p> <p>Supports connecting to iPerf server</p> <p>Test Direction Setup</p> <ul style="list-style-type: none"> <li>• Local → Remote</li> <li>• Remote → Local</li> <li>• Simultaneous in both directions</li> </ul> <p>For RFC 6349 test sequence, user can choose to measure for:</p> <ul style="list-style-type: none"> <li>• Path MTU</li> <li>• Baseline RTT</li> <li>• Window Scan and Throughput</li> <li>• Multi-Service</li> </ul> <p>Multi-Service: DSCP or TOS can be set to each TCP connections</p> <p>Measurement results include:</p> <ul style="list-style-type: none"> <li>• Auto-calculation of Bandwidth Delay Product (BDP)</li> <li>• Transmitted and Retransmitted Bytes</li> <li>• TCP Transfer Time Ratio</li> <li>• TCP Efficiency</li> <li>• Retransmitted Percentage</li> <li>• Buffer Delay Percentage</li> </ul>

Cable Test	
Cable Test	Identifies cable faults like short circuits, or breaks in wire pair, and displays distance from instrument to fault

Discovery	
Function	The Auto Discovery feature allows a local Network Master Pro user to discover other remote Network Master Pro units on the network to complete testing. The local user can manage multiple testers remotely without a dedicated network connection. Support IP version: IPv4
Setting	<p>Network: Src MAC Address, Src IP Address, Network Mask, Gateway, DHCP</p> <p>Connection Security: Password</p> <p>VLAN: OFF, 1, 2</p> <p>Frame Capture: On/Off</p>

Ping Test and Traceroute	
Ping Test	<p>For Connectivity and Configuration check</p> <ul style="list-style-type: none"> <li>• Round Trip Time (RTT)</li> <li>• Supports IPv4 and IPv6 addressing</li> <li>• Answer incoming ping requests (On/Off)</li> </ul>
Traceroute	<p>Trace IP route over IP network</p> <ul style="list-style-type: none"> <li>• User-defined Max. number of hops (1 to 255)</li> </ul> <p>Information per hop: Ping time (Max./Min./Avg.), Number of ping timeouts</p>

# Ethernet Testing Specifications

IP Channel Statistics	
Supported Bit Rate	10 Mbps, 100 Mbps, 1 Gbps, 10 Gbps
Statistics	<p>Statistics for up to 230 channels, identified by user-defined combinations of:</p> <ul style="list-style-type: none"> <li>• IPv4, IPv6 or MAC address</li> <li>• VLAN ID or MPLS label</li> <li>• Protocol information</li> <li>• IP next header (protocol)</li> <li>• TCP/UDP ports</li> </ul> <p>Traffic capacity:</p> <ul style="list-style-type: none"> <li>• 10 Mbps, 100 Mbps, 1 Gbps, 10 Gbps, line speeds: 100% line load</li> </ul> <p>Available Information per channel:</p> <ul style="list-style-type: none"> <li>• Frame count/rate, Throughput, Byte count, MPLS frames, IP frame/packet size distribution, IP header bytes, IP fragments, TTL threshold violations, IP packet count/rate, IP bytes, IP throughput, IP header errors, TCP/UDP bytes, TCP/UDP packet count/rate, Throughput, TCP/UDP errored packets, Undersize frames, Oversize frames</li> </ul>

MPLS/MPLS-TP	
Number of MPLS Header	Up to 8 MPLS headers set by user
Parameters per MPLS Header	<p>User-defined label, Exp and TTL fields in each MPLS header</p> <ul style="list-style-type: none"> <li>• Address increment, Decrement and Random generation</li> </ul> <p>An EoMPLS (Ethernet over MPLS) or PWE3 (Pseudo-wire emulation edge-to-edge) label (RFC 4448 control word) can be added. MPLS can only transport VLAN if EoMPLS activated.</p>
Statistics	<ul style="list-style-type: none"> <li>• Number of labels (Max./Min.)</li> <li>• Number of MPLS-TP frames</li> <li>• Last received MPLS-TP label/priority/TTL</li> </ul>
OAM (MPLS-TP)	<p>ITU-T G.8113.1 comply</p> <p>Supported OAM messages</p> <ul style="list-style-type: none"> <li>• ITU-T Y.1731: CCM, LBM, LBR, LTM, LTR, AIS, LCK, TST, MCC, LMM, LMR, 1DM, DMM, DMR, EXM, EXR, VSM, VSR, SLM, SLR</li> <li>• IEEE 802.1ag: CCM, LBM, LBR, LTM, LTR</li> </ul>

PBB (Mac-in-Mac MiM)	
Programmable Field	B-tag, I-tag, MAC destination and source addresses
Result	Number of PBB frames, Last received B-tag VLAN ID, Last received B-tag priority, Last received I-tag priority, Last received I-tag service ID
OAM	<p>Supported OAM messages</p> <ul style="list-style-type: none"> <li>• ITU-T Y.1731: CCM, LBM, LBR, LTM, LTR, AIS, LCK, TST, MCC, LMM, LMR, 1DM, DMM, DMR, EXM, EXR, VSM, VSR, SLM, SLR</li> <li>• IEEE 802.1ag: CCM, LBM, LBR, LTM, LTR</li> </ul>

Ethernet OAM	
OAM Standards Supported	<ul style="list-style-type: none"> <li>• ITU-T Y.1731 (Service layer OAM)</li> <li>• IEEE 802.1ag (Connectivity layer OAM)</li> <li>• IEEE 802.3 (formerly IEEE 802.3ah) (Access link OAM)</li> </ul>
Messages Supported	<p>Generates and receives following OAM messages.</p> <p>Supported OAM messages</p> <ul style="list-style-type: none"> <li>• ITU-T Y.1731: CCM, LBM, LBR, LTM, LTR, AIS, LCK, TST, MCC, LMM, LMR, 1DM, DMM, DMR, EXM, EXR, VSM, VSR, SLM, SLR</li> <li>• IEEE 802.1ag: CCM, LBM, LBR, LTM, LTR</li> <li>• IEEE 802.3ah: Information, Variable request, Variable response, Loopback control</li> </ul>
IEEE 802.3ah Function	<ul style="list-style-type: none"> <li>• Discovery</li> <li>• Loopback activate</li> </ul>
Statistics	<ul style="list-style-type: none"> <li>• Number of each message generated/received</li> </ul>

# Ethernet Testing Specifications

Ethernet Network Synchronization Test	
Supported Bit Rate	10 Mbps, 100 Mbps, 1 Gbps, 10 Gbps
SyncE Protocol Emulation	Signal generation for Quality Level (QL) specified by SyncE function. Analysis of QL indicated in received Ethernet signal with alarm at missing QL indications. SyncE results: SSM Rx count and rate, SSM Tx count, Indicated QL statistics, SSF seconds ESMC messages captured and exported in Wireshark format.
IEEE 1588 v2 Protocol Emulation	Each port of the Ethernet interface can act as a timing master or a timing slave independently. <ul style="list-style-type: none"> <li>Supported modes: Multicast (native PTP), Unicast (G.8265.1)</li> <li>When acting as master in Unicast (G.8265.1) mode, one slave is accepted at a time. If the slave requires 32, 64, or 128 Sync messages per second, IEEE 1588-2008 paragraph 7.7.2.1 specifying 90% confidence interval is not supported.</li> <li>Configurable parameters (per port): Clock identity, Port number, Priority 1, Priority 2, Domain number, Clock class, Slave only mode, Time source, Encapsulation, Announce receipt timeout, Clock accuracy, Clock step mode, Announce interval, Sync interval, Minimum delay request interval and Unicast duration. The UTC offset used when acting as clock master can be specified.</li> </ul>

Ethernet Frame Capture	
Capture Buffer Size	1 Mbytes to 128 Mbytes (10 Mbps, 100 Mbps, 1 Gbps, 10 Gbps) 512 kbytes (40 Gbps, 100 Gbps) When capture buffer full: Stop or Wrap
Capture Frame Slicing	If activated capture frame is first 64 bytes or 128 bytes of each frame (ignores rest of frame)
Include Tx Frame	On/Off
Capture Trigger	Manual, On error, Field match Trigger position: Top, Middle
Trigger Error	Fragmented frames Oversize frames Undersized frames Undersized and oversized frames FCS errored frames Any type
Trigger Condition Field	Enabled when capture trigger setting is field match <ul style="list-style-type: none"> <li>Offset: 0 to 15999 bytes</li> <li>Length: 1 bytes to 16 bytes</li> <li>Value: 16-byte data (max.)</li> </ul>
Capture Data	Pcap format for display in Wireshark

Wireshark® is a registered trademarks of the Wireshark Foundation.

10G WAN-PHY	
WAN Mode	10 Gbps Ethernet
Terminology	SDH or SONET
Error Generation	SDH: A1A2, B1, B2, MS-REI, B3, HP-REI SONET: A1A2, B1, B2, REI-L, B3, REI-P
Alarm Generation	SDH: LOF, OOF, MS-AIS, MS-RDI, MS-TIM, AU-AIS, AU-LOP, HP-PLM, HP-UNEQ, HP-TIM, HP-RDI, LCD SONET: LOF, SEF, TIM-S, AIS-L, RDI-L, AIS-P, LOP-P, TIM-P, PLM-P, UNEQ-P, RDI-P
Error Measurement	SDH: A1A2, B1, B2, MS-REI, B3, HP-REI SONET: A1A2, B1, B2, REI-L, B3, REI-P G.826, G.828+G.829 or M.2101.1 (M.2100) error performance parameters are calculated
Alarm Detection	SDH: LOS, LOF, OOF, MS-AIS, MS-RDI, MS-TIM, AU-AIS, AU-LOP, HP-PLM, HP-UNEQ, HP-TIM, HP-RDI, LCD, LSS SONET: LOS, LOF, SEF, TIM-S, AIS-L, RDI-L, AIS-P, LOP-P, TIM-P, PLM-P, UNEQ-P, RDI-P, LCD-P, LSS
Overhead Byte Functionality	Generation of user-defined overhead bytes Capture and display of current overhead bytes

Reflector	
Reflector Mode	The following parameters are user selectable: <ul style="list-style-type: none"> <li>Reflector MAC/IP address</li> <li>Swap all MAC addresses or one specific MAC address</li> <li>Swap IP addresses</li> <li>Swap port numbers on UDP/TCP frames</li> <li>Force ACK on TCP frames</li> <li>Answer incoming ARP, Ping requests</li> </ul>

# OTN Testing Specifications

## OTN Testing

OTN Test	
Framing	OTU4, OTU3, OTU3e1, OTU3e2, OTU2, OTU2e, OTU1e, OTU2f, OTU1f, OTU1
Transmitter Clock	<ul style="list-style-type: none"> <li>• Internal clock accuracy: <math>\pm 4.6</math> ppm, Clock offset: <math>\pm 200</math> ppm (0.1 ppm steps)</li> <li>• Received clock</li> <li>• TTL level external 2 MHz clock</li> <li>• SETS (E1: 2.048 Mbps), BITS (DS1: 1.544 Mbps)</li> <li>• Signal from optional GPS receiver</li> </ul>
Receive Signal Rate	$\pm 200$ ppm Frequency deviation indication resolution: $\pm 0.1$ ppm
Scrambling	Complies with ITU-T G.709

### OTN Mapping

Support the mappings of OTU1 and OTU2x in MU110010A

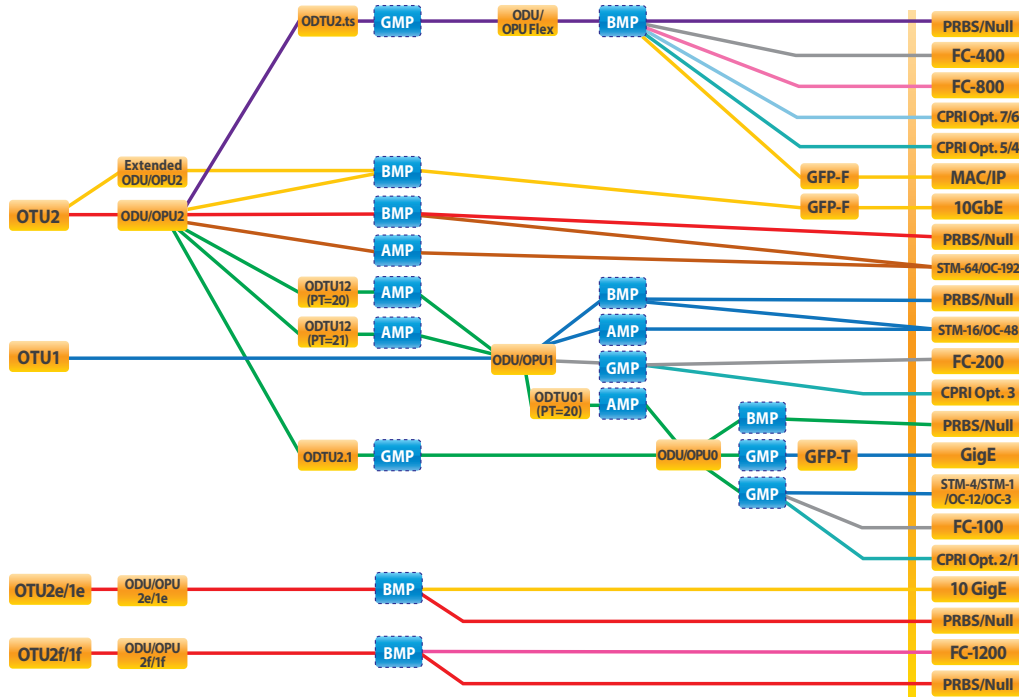

- MU110010A-001 Up to 2.7G Dual Port
- MU110010A-051/052 OTN 10G Single/Dual Channel
- MU110010A-061 ODU Multiplexing
- MU110010A-062 ODU Flex
- MU110010A-011/012 Ethernet 10G Single/Dual Channel
- MU110010A-081/082 STM-64 OC-192 Single/Dual Channel
- MU110010A-002 1G 2G 4GFC Dual Port
- MU110010A-091/092 FC 8G 10G Single/Dual Channel
- MU110010A-071 CPRI/OBSAI Up to 5G Dual channel
- MU110010A-072/073 CPRI/OBSAI 6G to 10G Single/Dual channel

# OTN Testing Specifications

Support the mappings of OTU1 and OTU2x in MU110011A

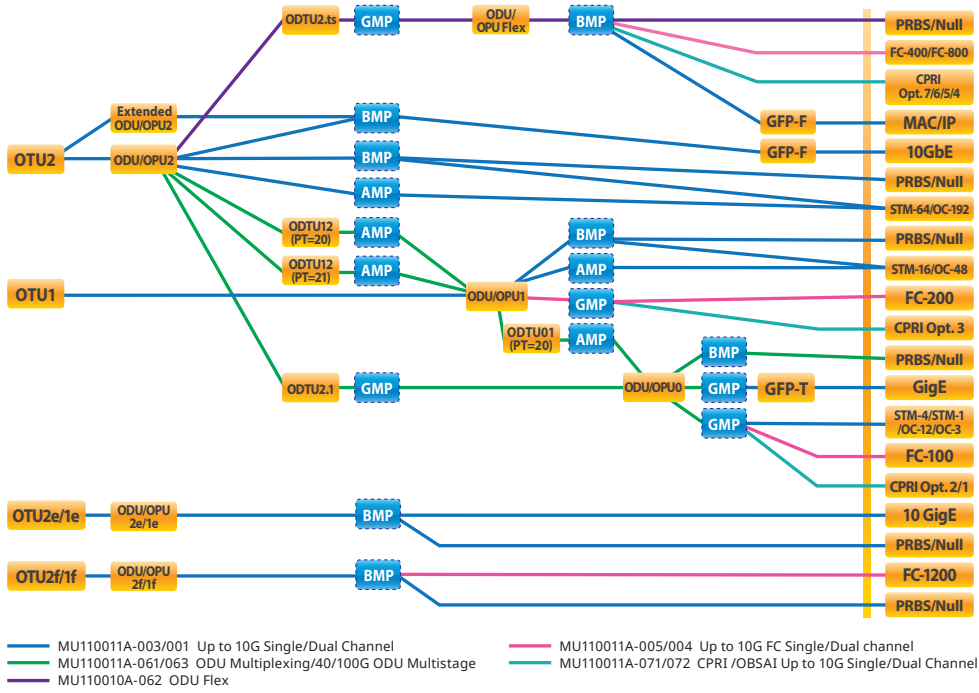

Support the mappings of OTU3 in MU110011A/13A

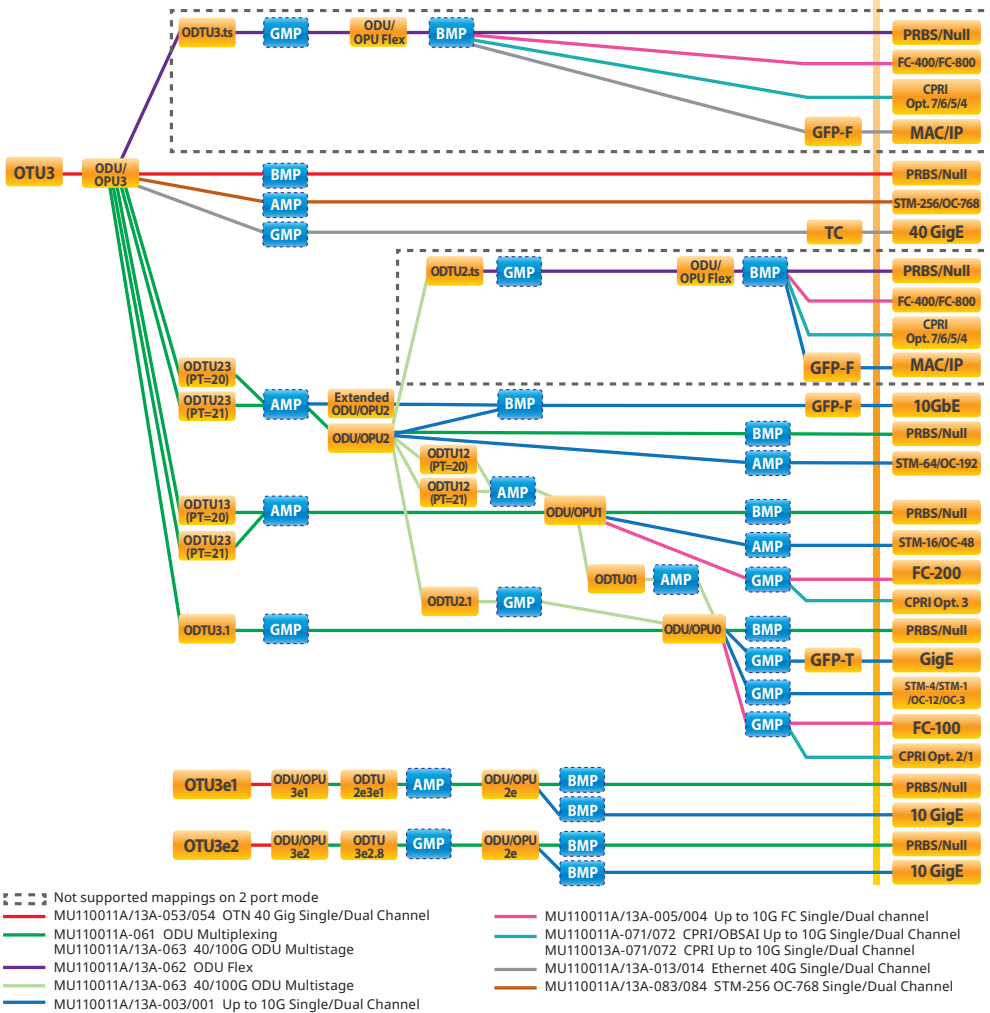

# OTN Testing Specifications

Support the mappings of OTU4 in MU110011A/13A

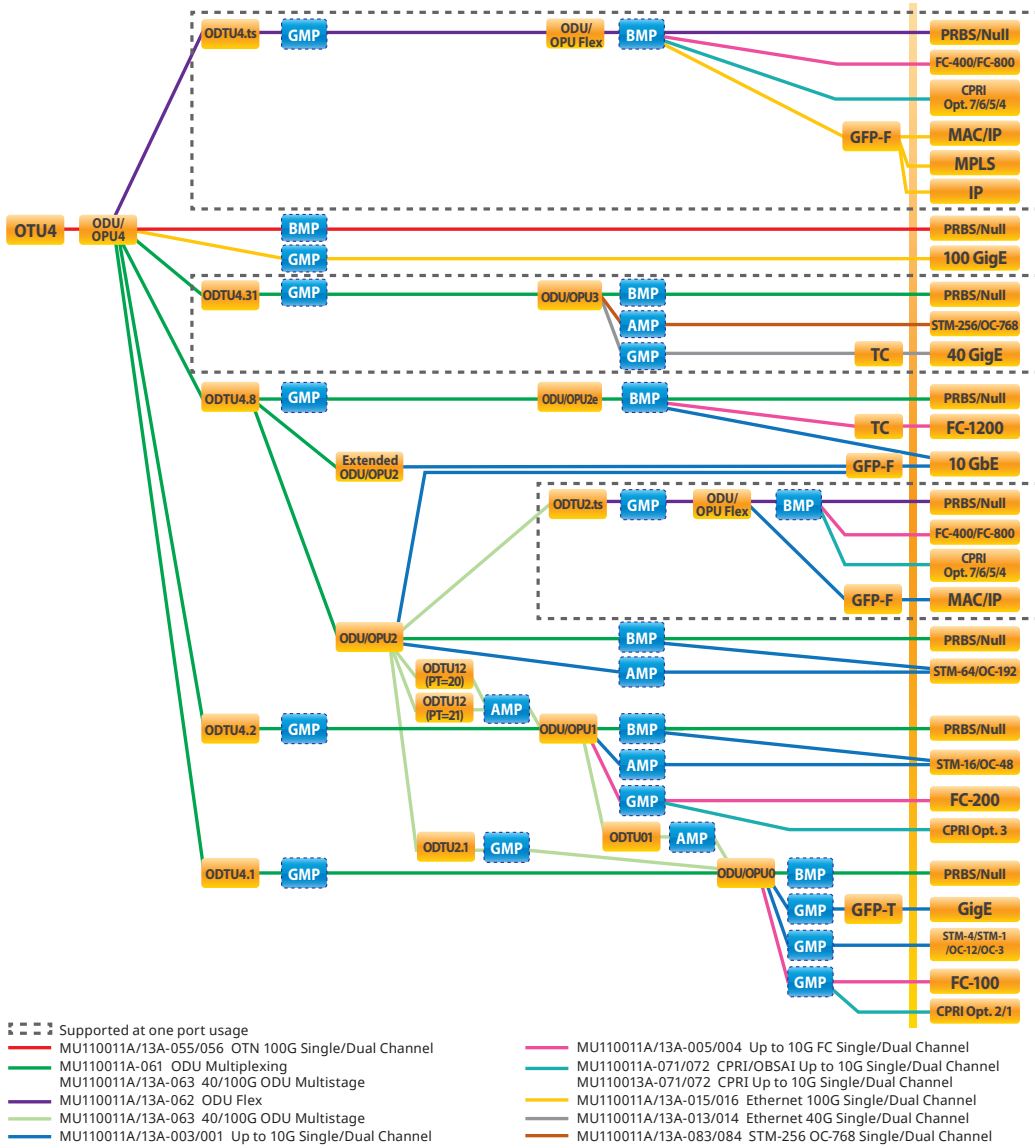

## OTN Alarms

### Detected alarms

- OTU layer: OTU-AIS, LOF, OOF, LOM, OOM, SM-TIM, SM-BIAE, SM-BDI, SM-IAE
- ODU layer: LOS, ODU-AIS, ODU-OCI, ODU-LCK, PM-TIM, PM-BDI, FSF, FSD, BSF, BSD
- ODU multiplexing: ODU-LOFLOM, ODU-OOF, OOM, ODU-AIS, ODU-OCI, ODU-LCK, PM-TIM, PM-BDI, MSIM
- OPU layer: PLM, OPU-MSIM, Client-AIS, CSF, LSS
- TCM: TCMi-TIM, TCMi-BIAE, TCMi-BDI, TCMi-IAE, TCMi-LTC (i = 1 to 6)
- OTL: LOF, OOF, OOR, LOR, ILA/OLA (OTU4, OTU3, OTU3e1, OTU3e2)

### Generated alarms

- OTU layer: OTU-AIS, OTU-OOF/LOF, OOM/LOM, SM-TIM, SM-BIAE, SM-BDI, SM-IAE
- ODU layer: ODU-AIS, ODU-OCI, ODU-LCK, PM-TIM, PM-BDI, FSF, FSD, BSF, BSD
- ODU multiplexing: OOF/LOF, OOM/LOM, ODU-AIS, ODU-LCK, PM-TIM, PM-BDI, FSF, FSD, BSF, BSD
- OPU layer: Client-AIS, CSF
- TCM: TCMi-TIM, TCMi-BIAE, TCMi-IAE, TCMi-BDI, TCMi-LTC (i = 1 to 6)
- OTL: LOF, OOF, OOR, LOR (OTU4, OTU3, OTU3e1, OTU3e2)

# OTN Testing Specifications

OTN Errors	<p>Detected errors</p> <ul style="list-style-type: none"> <li>• OTU layer: FAS, MFAS, SM-BEI, SM-BIP8, FEC-Correctable, FEC-Uncorrectable</li> <li>• ODU layer: PM-BIP8, PM-BEI</li> <li>• OPU layer: Pattern error</li> <li>• GMP error: CRC8 error, CRC5 error</li> <li>• GFP errors: cHEC corrected, cHEC uncorrectable, tHEC corrected, tHEC uncorrectable, CSF Signal, CSF Sync, Invalid GFP Frame, Superblock CRC, eHEC corrected, eHEC uncorrectable, FCS, CMF Sync, CMF Signal, SSF, PTI Mismatch, UPI Mismatch</li> <li>• TCM: TCMi-BEI, TCMi-BIP-8 (i = 1 to 6)</li> <li>• OTL: MFAS, LLM (OTU4, OTU3, OTU3e1, OTU3e2)</li> </ul> <p>Generated errors</p> <ul style="list-style-type: none"> <li>• OTU layer: Bit all, FAS, OTU-FAS, MFAS, SM-BIP8, SM-BEI</li> <li>• ODU layer: PM-BIP8, PM-BEI, ODU-FAS</li> <li>• TCMi-BIP8, TCMi-BEI (i = 1 to 6)</li> <li>• Pattern error</li> <li>• OTL: MFAS, LLM (OTU4, OTU3, OTU3e1, OTU3e2)</li> <li>• GMP: CRC8, CRC5, Invalid JC1, Invalid JC2, Invalid JC1&amp;JC2</li> <li>• GFP: cHEC, tHEC, Superblock CRC, eHEC, FCS, CMF</li> </ul> <p>Inserted Error bits are editable.</p>
Error Performance	<ul style="list-style-type: none"> <li>• G.8201/M.2401 analysis of received signal based on detected errors and alarms: BBE, BBER, SES, SESR, UNAV</li> </ul>
Justification Analysis	<p>Count</p> <ul style="list-style-type: none"> <li>• AMP: Positive (+1), Positive (+2), Negative (-1), Offset (ppm)</li> <li>• GMP: CRC8 Error, CRC5 Error, Inc, Inc &gt; 1, Inc &gt; 2, Inc Over, Dec, Dec &gt; 1, Dec &gt; 2, Dec Over, Offset (ppm), Cm (t) Max., Cm (t) Min.</li> </ul>
BER Test Pattern	<p>Pattern generation and detection for bulk test patterns:</p> <ul style="list-style-type: none"> <li>• Test patterns: PRBS 9, PRBS 11, PRBS 15, PRBS 20, PRBS 23, PRBS 29, PRBS 31, Null</li> <li>• PRBS patterns can be inverted.</li> <li>• User-defined patterns (Pattern length: 2048 bits, 32 bits)</li> </ul>
FEC Test	ITU-T O.182 Random error insertion
Overhead	<p>User-editable header bytes</p> <ul style="list-style-type: none"> <li>• OTU layer: FAS, SM, GCC0, RES</li> <li>• ODU layer: PM, FTL, APS/PCC, GCC1, GCC2, RES, EXP, TCMi (i = 1 to 6)</li> <li>• OPU layer(s): PSI</li> </ul> <p>Capture and display current overhead bytes</p> <p>The following signals are decoded: TTI (SM, PM, TCMi (i = 1 to 6) of high-order, FTL, PT)</p>
OTL Skew	<p>OTU4, OTU3, OTU3e1, OTU3e2</p> <ul style="list-style-type: none"> <li>• Insertion</li> <li>• Bits: 0 to 32000 (Tx lane)</li> <li>• Detection</li> <li>• Relative skew, Marker map</li> </ul>
Through Mode	<ul style="list-style-type: none"> <li>• Transparent mode</li> <li>• OH overwrite mode</li> </ul> <p>The OTU, ODU and OPU overhead can be changed.</p> <p>The FEC encoder and decoder can be set On/Off in any mode</p>

OTN Results	
Status	<p>Current information on:</p> <ul style="list-style-type: none"> <li>• Alarms and errors on monitored line</li> <li>• Input level indication for optical signals</li> <li>• Frequency</li> <li>• Frequency deviation</li> </ul>
Statistics	<p>User-defined measurement resolution: 1, 2, 5, 10, 15, 30 s, 1, 5, 10, 15, 30 min, 1, 2, 4, 6, 12 h</p> <p>Logged information: Alarms (s), Errors (count or count and ratio), Client Frequency, Deviation</p>
APS	<p>APS (Automatic Protection Switching) test and analysis</p> <ul style="list-style-type: none"> <li>• APS switching time is measured. A switching time exceeding the user-defined threshold is highlighted.</li> <li>• Start and stop triggers can be selected independently. <ul style="list-style-type: none"> <li>• Trigger events can be selected from the high-order OTU and ODU, Pattern bit error, LOS (Loss of Signal).</li> </ul> </li> <li>• Switching time, Switching count, Pass/Fail, Minimum, Maximum and Average can be displayed.</li> <li>• APS switching time measurement resolution: 0.1 ms</li> </ul>
Round Trip Delay (Propagation Time) Measurement	<p>Resolution: 0.1 <math>\mu</math>s</p> <p>Measured Max. time: 10.0 s</p> <p>Interval: 0.5, 1, 2, 5, 10 s</p>
Tributary Scan	<p>Supports up to 10 Gbps</p> <p>Detected alarms: OTU-AIS, LOF, OOF, LOM, OOM, SM-BIAE, SM-BDI, SM-IAE, ODU-AIS, ODU-OCI, ODU-LCK, PM-BDI, LOFLOM</p>



## Mobile xHaul Testing Specifications

Common	
Bit Rate	CPRI: 614.4, 1228.8, 2457.6, 3072.0, 4915.2, 6144.0, 9830.4, 10137.6 Mbps OBSAI: 768, 1536, 3072.0, 6144.0 Mbps eCPRI/RoE (IEEE1914.3): 10M/100M/1000 Mbps, 1 Gbps, 10 Gbps, 25 Gbps, 40 Gbps, 100 Gbps
Test Configuration	CPRI/OBSAI BERT, CPRI Pass Through, eCPRI/RoE BERT

CPRI/OBSAI BER Test	
Port Mode	Off, Normal, Through (CPRI Link)
Transmitter Clock	Reference Clock <ul style="list-style-type: none"> <li>• Internal clock</li> <li>• External clock</li> <li>• BITS</li> <li>• SETS</li> <li>• 2 MHz</li> <li>• 10 MHz</li> <li>• GPS</li> <li>• Received clock</li> </ul>
Frequency Offset	±100 ppm, 1-ppm steps
Content	Unframed, CPRI Link, OBSAI Link
Pattern	PRBS 15, PRBS 20, PRBS 23, PRBS 29, PRBS 31, User 32 bits, Off
CPRI	
CPRI Link	Start up: Enabled, Disabled Role: Master, Slave Protocol version: 1, 2 HDLC rate: no HDLC, 240, 480, 960, 1920, 2400 kbit/s, Highest possible Ethernet: On, Off; Pointer: 20 to 63
Alarm Insertion	Signal Loss, LOS, LOF, LSS, Remote-LOS, Remote-LOF, RAI, SDI, Reset
Error Insertion	Item: LCV, SHV, K30.7, Pattern error Insertion timing: Manual, Rate
Alarm Detection	Signal loss, LOS, LOF, LSS
Error Detection	LCV, SHV, K30.7, Pattern error
Remote Status	Remote LOS, Remote LOF, RAI, SDI, Reset
Link	Rx: Protocol version, HDLC rate, Pointer P Tx: Protocol version, HDLC rate, Pointer P
Statistics	Alarms: Signal loss, LOS, LOF, LSS, Remote LOS, Remote LOF, RAI, SDI, Reset Errors: LCV, SHV, K30.7, Pattern error Frames count: Rx hyper frame, Rx code words, Tx hyper frame, Tx code words Delay: Delay, Average Delay, Min. Delay, Max. Delay Measurement count
OBSAI	
OBSAI Link	Tx: Force idle, Scramble seed, RP3 address, RP3 type Rx: Forced scrambler seed, Rx Filter, Scramble seed, RP3 address, RP3 type
Alarm Insertion	Signal Loss, LOF, No message, LSS
Error Insertion	Item: LCV, K30.7, Pattern error Insertion timing: Manual, Rate
Alarm Detection	Signal Loss, LOF, No message, LSS
Error Detection	LCV, K30.7, Pattern error
Link	Rx : Sync state
Statistics	Alarms: Signal loss, LOF, LSS Errors: LCV, K30.7, Pattern error Frames count: Tx/Rx Message Groups Delay: Delay, Average Delay, Min. Delay, Max. Delay Measurement count
CPRI/OBSAI APS	APS (Automatic Protection Switching) test and analysis <ul style="list-style-type: none"> <li>• APS switching time is measured. A switching time exceeding the user-defined threshold is highlighted.</li> <li>• Trigger events (user selectable)</li> <li>• Alarm: Signal Loss, LOS (CPRI), LOF</li> <li>• Error: LCV, SHV (CPRI), Pattern error</li> <li>• Remote Alarm (CPRI): Remote LOS, Remote LOF, RAI, SDI, Reset</li> <li>• Switching time, Switching count, Pass/Fail, Minimum, Maximum and Average can be displayed.</li> <li>• APS switching time measurement resolution: 1 μs</li> </ul>

# Mobile xHaul Testing Specifications

CPRI Pass Through	
Port Mode	Off, Normal
Statistics	Alarms: Signal loss, LOS , LOF, LSS, Remote LOS , Remote LOF , RAI , SDI , Reset Errors: LCV, SHV , K30.7, Pattern error

eCPRI/RoE (IEEE1914.3) BER Test (Setting)	
Frame Length	eCPRI: 50 byte to 16000 byte RoE: 51 byte to 16000 byte
eCPRI Frame Configuration	<ul style="list-style-type: none"> <li>• Transmitting mode: Normal, Burst</li> <li>• Variable line rate traffic generation, up to full line rate</li> <li>• Line load profile: Constant, Ramp</li> <li>• Traffic duration: Continuous, Programmable number of seconds or frames</li> <li>• Frame sizes: Constant</li> <li>• Protocol Stack <ul style="list-style-type: none"> <li>• Ethernet-eCPRI, Ethernet-IPv4-UDP-eCPRI, Ethernet-IPv6-UDP-eCPRI, Ethernet-VLAN-eCPRI, Ethernet-VLAN-IPv4-UDP-eCPRI, Ethernet-VLAN-IPv6-UDP-eCPRI,</li> </ul> </li> <li>• eCPRI frame parameter <ul style="list-style-type: none"> <li>• Common Header: Following the Message Type can be chosen IQ Data, Bit Sequence, Real-Time Control Data, Generic Data Transfer, Remote Memory Access, One-way Delay Measurement, Remote Reset, Event Indication, User Defined, None</li> <li>• Message Header: Change of Message Type</li> <li>• Payload: PRBS31</li> <li>• Increment, Decrement and Random: PC_ID, SEQ_ID, RTC_ID, RESET_ID</li> </ul> </li> </ul>
RoE (IEEE1914.3) Frame Configuration	<ul style="list-style-type: none"> <li>• Transmitting mode: Normal, Burst</li> <li>• Variable line rate traffic generation, up to full line rate</li> <li>• Line load profile: Constant, Ramp</li> <li>• Traffic duration: Continuous, Programmable number of seconds or frames</li> <li>• Frame sizes: Constant</li> <li>• Protocol Stack <ul style="list-style-type: none"> <li>• Ethernet-RoE, Ethernet-VLAN-RoE</li> </ul> </li> <li>• RoE Frame setting <ul style="list-style-type: none"> <li>• Common Header: Following the Sub Type can be chosen RoE Control sub type, RoE Structure-agnostic data sub type, RoE Structure-aware CPRI data sub type, RoE Slow C&amp;M CPRI sub type, RoE Native time domain data sub type, RoE Native frequency domain data sub type, RoE Native PRACH data sub type, User Defined, None</li> </ul> </li> <li>• Flow ID: Fixed, Increment, Decrement and Random</li> <li>• Ordering info: Fixed, Increment, Decrement and Random <ul style="list-style-type: none"> <li>• Sub Header: Choice of the Sub Type</li> <li>• Payload: PRBS31</li> </ul> </li> </ul>
VLAN, ARP, IP/UDP Address Setting	<ul style="list-style-type: none"> <li>• Two VLAN tags supported</li> <li>• Generate pause frames, Respond to pause frames</li> <li>• Answer incoming ARP, Ping requests (On/Off)</li> </ul> <p>The following items can also be set only when eCPRI is selected.</p> <ul style="list-style-type: none"> <li>• Configurable IP and Ethernet source and destination addresses (supports IPv4 and IPv6 addressing) <ul style="list-style-type: none"> <li>• IPv4: Fixed, DHCP, DNS</li> <li>• IPv6: Fixed, NDP</li> </ul> </li> <li>• Address increment, Decrement and Random generation supported</li> <li>• User programmable UDP port number</li> <li>• UDP check sum: Automatic</li> </ul>
Transmit Signal Clock Sources	Internal, Received clock, 2-MHz signal, SETS (E1: 2.048 Mbps), BITS (DS1: 1.544 Mbps), PTP (IEEE 1588 v2) recovered clock or signal from optional GPS receiver Frequency deviation: ±100 ppm (1-ppm steps)
Receive Setting	User-defined expected preamble length: 3 bytes to 15 bytes User-defined IFG lower threshold: 8 bytes to 15 bytes (RJ45 port only) User-defined Jumbo frame size upper limit: 1519 bytes to 16000 bytes
Error Generation	IFG for Ethernet (RJ45 port only), FCS, Preamble, Error symbol/block, Wrong IP check sum, Fragmented IP, Wrong layer 4 check sum, PRBS bit error, BER test sequence error
Alarm Generation	No link, Remote fault
SyncE Protocol Emulation	Signal generation for Quality Level (QL) specified by SyncE function. Analysis of QL indicated in received Ethernet signal with alarm at missing QL indications. SyncE results: SSM Rx count and rate, SSM Tx count, Indicated QL statistics, SSF seconds ESMC messages captured and exported in Wireshark format.

# Mobile xHaul Testing Specifications

IEEE 1588 v2 Protocol Emulation	<ul style="list-style-type: none"> <li>Each port of the Ethernet interface can act as a timing master or a timing slave independently.</li> <li>Supported profiles: G.8265.1, G.8275.1, User Defined</li> <li>When acting as master in Unicast (G.8265.1) mode, one slave is accepted at a time.</li> <li>If the slave requires 32, 64, or 128 Sync messages per second, IEEE 1588-2008 paragraph 7.7.2.1 specifying 90% confidence interval is not supported.</li> </ul> <p>Configurable parameters</p> <ul style="list-style-type: none"> <li>Domain: 0 to 255</li> <li>Step Mode: One-step, Two-step</li> <li>Delay Mechanism: Delay request/response, Peer delay</li> <li>Negotiation: On/Off (Unicast only)</li> <li>Clock Source: Internal or UTC locked with GPS</li> <li>Clock Identify</li> <li>Priority#1, #2, Class, Time Source, Accuracy Index: 0 to 255</li> <li>Announce Interval: 1/8 to 32 s</li> <li>Announce Timeout: 2 to 255 s</li> <li>Sync Interval: 1/128 to 32 s</li> <li>Minimum Delay Request Interval: 1/128 to 32 s</li> <li>Unicast Duration: 60 s to 1,000 s</li> </ul> <ul style="list-style-type: none"> <li>Protocol Stack <ul style="list-style-type: none"> <li>Layer2: Ethernet, Ethernet/VLAN, Ethernet/MPLS</li> <li>Layer3: None, IPv4, IPv6</li> </ul> </li> <li>PTP Protocol Analysis <ul style="list-style-type: none"> <li>Statistics of IEEE 1588 messages and message rate.</li> <li>Logged IEEE 1588 events: Clock state transitions, State transition events, Faults and Changes in grand-master clock</li> <li>IEEE 1588 messages captured and exported in Wireshark format</li> </ul> </li> </ul>
E-OAM Protocol Emulation	<p>Standards Supported</p> <ul style="list-style-type: none"> <li>ITU-T Y.1731 (Service layer OAM)</li> <li>IEEE 802.1ag (Connectivity layer OAM)</li> <li>IEEE 802.3 (formerly IEEE 802.3ah) (Access link OAM)</li> </ul> <p>Generates and receives following OAM messages.</p> <ul style="list-style-type: none"> <li>ITU-T Y.1731: CCM, LBM, LBR, LTM, LTR, AIS, LCK, TST, MCC, LMM, LMR, 1DM, DMM, DMR, EXM, EXR, VSM, VSR, SLM, SLR</li> <li>IEEE 802.1ag: CCM, LBM, LBR, LTM, LTR</li> <li>IEEE 802.3ah: Information, Variable request, Variable response, Loopback control</li> </ul>
IEEE 802.3ah Function	<ul style="list-style-type: none"> <li>Discovery</li> <li>Loopback activate</li> </ul>

eCPRI/RoE (IEEE1914.3) BER Test (Counter, Monitor)	
Status	<ul style="list-style-type: none"> <li>Link status, Interface type, Jabber detected, Frames present, MPLS/EoMPLS/VLAN, Speed, Full or half duplex, Local clock (Ethernet 1000 Mbps), LFS LF/RF (Ethernet 10 Gbps), Signal present, Bit rate of incoming Ethernet signal, Auto negotiation complete</li> <li>Link partner abilities: <ul style="list-style-type: none"> <li>Pause capable and Asymmetric pause request (not Ethernet 10 Gbps and more), Remote fault, Speed/Duplex</li> </ul> </li> <li>Indicators for Utilization, Throughput and Errored frames</li> <li>Signal level indication for optical Ethernet interfaces</li> <li>LFS local fault, LFS remote fault, High BER, LOA (10 Gbps)</li> <li>Invalid sync header, Invalid alignment marker, BIP error, Invalid block (10 Gbps)</li> </ul>
Resolution	<ul style="list-style-type: none"> <li>User-defined resolution for statistical measurements: 1, 2, 5, 10, 15, 30 s, 1, 5, 10, 15, 30 min, 1, 2, 4, 6, 12 h</li> <li>Event log: Major measurement events incl. errors and alarms are logged with 1-second resolution.</li> </ul>
Performance Statistics	<ul style="list-style-type: none"> <li>Utilization (Max./Min./Avg.), Throughput (Max./Min./Avg.), Frame rate (Max./Min./Avg.)</li> </ul>
Frame Statistics	<ul style="list-style-type: none"> <li>Total frames, Total valid frames, Unicast/Multicast/Broadcast frames, Number of pause frames</li> <li>Number of VLAN tagged frames, Max. number of VLAN layers detected, Last received VLAN ID, Last received VLAN priority</li> <li>Total errored frames, Fragmented frames, Number of oversized and undersized (runts) frames, Number of FCS errored frames</li> </ul>
Burst Statistics	<ul style="list-style-type: none"> <li>Total frames, Total valid frames, Number of burst, Total frames in bursts, Burst size (Max./Min./Avg.)</li> </ul>
Frame Distribution Statistics	<ul style="list-style-type: none"> <li>Total valid/ frames, 64 to 127, 128 to 255, 256 to 511, 512 to 1023, 1024 to 1518 byte frames, Total number of jumbo frames</li> <li>Frame size (Max./Min./Avg.)</li> </ul>

## Mobile xHaul Testing Specifications

Adjustable Threshold	Utilization, Throughput, Errored frames, Collision rate, Unicast frames, Multicast frames, Broadcast frames, Pause frames, Fragmented frames, Undersized frames (runts), Oversized frames, FCS errored frames, IFG violations (RJ45 port only), Preamble violations, BER test pattern errors, Sequence errors, Diff.Tx-Rx
BER Test	<p>Generation and detection of test patterns, Count of errors in received test pattern, Detection of sequence errors, loss of sequence synchronization, Frame loss count and frame loss seconds</p> <p>Throughput measurement results are calculated for:</p> <ul style="list-style-type: none"> <li>• Utilization layer, Physical layer, Physical layer excluding preamble, Link layer, Network layer and Data layer</li> <li>• Min./Max./Avg. values</li> </ul> <p>Performance (M.2100 type) parameters: ES, SES, ALS, UAT, AVT, EFS</p> <p>Test patterns: PRBS 31</p> <p>User-defined resolution: 1, 2, 5, 10, 15, 30 s, 1, 5, 10, 15, 30 min, 1, 2, 4, 6, 12 h</p> <p>Event log: Major measurement events incl. errors and alarms are logged with 1-second resolution.</p>

eCPRI/RoE (IEEE1914.3) BER Test (Frame Capture)	
Capture Buffer Size	1 Mbytes to 128 Mbytes (10 Mbps, 100 Mbps, 1 Gbps, 10 Gbps) When capture buffer full: Stop or Wrap
Capture Frame Slicing	If activated capture frame is first 64 bytes or 128 bytes of each frame (ignores rest of the frame)
Timestamp Resolution	100 ns
Include Tx Frame	On/Off
Capture Trigger	Manual, On error, Field match Trigger position: Top, Middle
Error Trigger	Fragmented frames, Oversize frames, Undersized frames, Undersized and oversized frames, FCS errored frames, Any type
Trigger Field Pattern Data	Enabled when capture trigger setting is Field match <ul style="list-style-type: none"> <li>• Offset: 0 to 15999 bytes</li> <li>• Length: 1 bytes to 16 bytes</li> </ul>
Capture Data	Pcap format for display in Wireshark

# Fibre Channel Testing Specifications

Common	
Bit Rate	1.0625 Gbps (FC-100/1GFC), 2.125 Gbps (FC-200/2GFC), 4.25 Gbps (FC-400/4GFC), 8.5 Gbps (FC-800/8GFC), 10.52 Gbps (FC-1200/10GFC)
Test Configuration	FC-Performance Test, FC-BERT, FC-Reflector

FC-BERT	
Port mode	Off, 1GFC, 2GFC, 4GFC, 8GFC, 10GFC
Timing source	Internal, External, GPS, Received
Topology	Point-to-point, Fabric, E-Port
Flow Control	Credit based transmitter: On/Off Buffer-to-buffer credit configuration: 1 to 65535, Buffer-to-buffer credit and R_RDY counters, R_RDY injection
Source	Port WWN: User define or Default ID: 000000 to FFFFFFFF
Destination	Port WWN: User define or Default ID: 000000 to FFFFFFFF
Primitive Sequence Protocol	Count and transmit primitive sequence: LR, LRR, NOS, OLS
Traffic Generation	<ul style="list-style-type: none"> <li>• 1GFC (with SOF and EOF frame delimiters and 2GFC frames), Class-3 service frames</li> <li>• Traffic shaping: Constant, Ramp, Burst, 2GFC frame header configuration</li> <li>• Frame length configuration: 3240 bytes (max.)</li> </ul>
BERT test	<ul style="list-style-type: none"> <li>• Test modes: Unframed BER test, Layer 1 BER test, Layer 2 BER test</li> <li>• Test patterns: PRBS 9, PRBS 11, PRBS 15, PRBS 20, PRBS 23, PRBS 29, PRBS 31, HF test pattern, CSPAT, CJPAT, CRPAT, JTPAT, SPAT, 55 Hex, Fox, 32-bit user programmable, ZERO</li> <li>• Error injection: Bit, CRC, Symbol</li> <li>• Results: Pattern loss seconds, Traffic loss seconds, Bit error count, BER</li> </ul>
Measurement	<ul style="list-style-type: none"> <li>• Alarm detection: LOS, Link down, Pattern loss</li> <li>• Service disruption measurement: Average/Max service disruption, Number of service disruptions</li> <li>• Traffic statistics: Bandwidth utilization, Data rate, Frame count, Byte count, Frame size distribution, Buffer-to-buffer credit count, R_RDY count, Frame loss count, Round trip delay, Packet jitter, Bit errors, CRC errors, Symbol errors, LR, LRR, NOS, OLS</li> </ul>

FC-Reflector	
Port mode	Off, 1GFC, 2GFC, 4GFC, 8GFC, 10GFC
Timing source	Internal, External, GPS, Received
Topology	Point-to-point, Fabric, E-Port
Flow Control	Credit based transmitter: On/Off Buffer-to-buffer credit configuration: 1 to 65535, Buffer-to-buffer credit and R_RDY counters, R_RDY injection
Source	Port WWN: User define or Default
Frame Setup	Framing: SOF:Data:EOF or SOF:Header:Data:CRC:EOF

FC-Performance Test	
Port mode	Off, 1GFC, 2GFC, 4GFC, 8GFC, 10GFC
Timing source	Internal, External, GPS, Received
Topology	Point-to-point, Fabric, E-Port
Flow Control	Credit based transmitter: On/Off Buffer-to-buffer credit configuration: 1 to 65535, Buffer-to-buffer credit and R_RDY counters, R_RDY injection
Source	Port WWN: User define or Default ID: 000000 to FFFFFFFF
Destination	Port WWN: User define or Default ID: 000000 to FFFFFFFF
Configuration	Test Mode: Port-to-Port, Loopback Kinds of test: Throughput, Traffic Profile, Latency, Burst, Credit Frame Size: User Defined (64, 128, 256, 512, 768, 2014, 1280, 2140, up to 3240), Stepped (40 to 3240), Constant

# Device Testing, SDH/SONET Testing Specifications

## Device Testing

Device Test	
Interface Type	Off, CFP, CFP2, CXP, QSFP+
Supported Bit Rate	Off, 40 Gbps Ethernet, 100 Gbps Ethernet, STM-256/OC-78, OTU4, OTU3, OTU3e1, OTU3e2
Timing Source	Internal clock, External clock
Test Pattern	PRBS 7, PRBS 9, PRBS 15, PRBS 23, PRBS 31, Square wave
Frequency Offset	±200 ppm (0.1 ppm step)
Error Insertion	Item Bit error Insertion timing Single
Monitor	Signal level: dBm Frequency: Hz, ppm LOS, LSS, CDR lock, Bit error
Transceiver	Module Present Transceiver Information Alarm, Wavelength and bit rate, Compliance, Vendor Information, Output Control Power monitor For CFP and CFP2 • MDIO analysis: NVR1, NVR2, Module FAWS, MW Lane FAWS, CTRL, MDIO • I2C • Setting For CFP: VOD, Pre-Emphasis, Rx Equalizer For CFP2: Attenuation, Pre-Emphasis, Rx Equalizer
No Frame Measurement	Bit error, Frequency

## SDH/SONET and PDH/DSn Testing

SDH and SONET Test	
Framing	SDH: Complies with ITU-T G.707, SONET: Complies with Telcordia GR-253
Transmitter Clock	• Internal clock accuracy: ±4.6 ppm, Clock offset: ±200 ppm (0.1 ppm steps) • Recovered clock • TTL level external 2 MHz clock • SETS (E1: 2.048 Mbps), BITS (DS1: 1.544 Mbps)
Receive Signal Rate	±200 ppm Frequency deviation indication resolution: ±0.1 ppm
STM-1e Electrical Attenuation and Impedance Mode	<b>TERMINATE:</b> Up to 12 dB cable attenuation, Nominal impedance <b>MONITOR:</b> 20 dB linear attenuation and up to 12 dB cable attenuation, Nominal impedance
TCM Frame Format	ITU-T G.783, G.707 Annex D (TCM option 2) and Annex E, POH bytes: N1 (VC-4, VC-3), Z5 (STS-3c, STS-1), N2 (VC-12, VC-11), Z6 (VT-2, VT-1.5) TCM Access Point Identifier (Apid): 15 bytes ASCII sequence, CRC-7
Scrambling	SDH: Complies with ITU-T G.707, SONET: Complies with Telcordia GR-253

### SDH/SONET Mapping

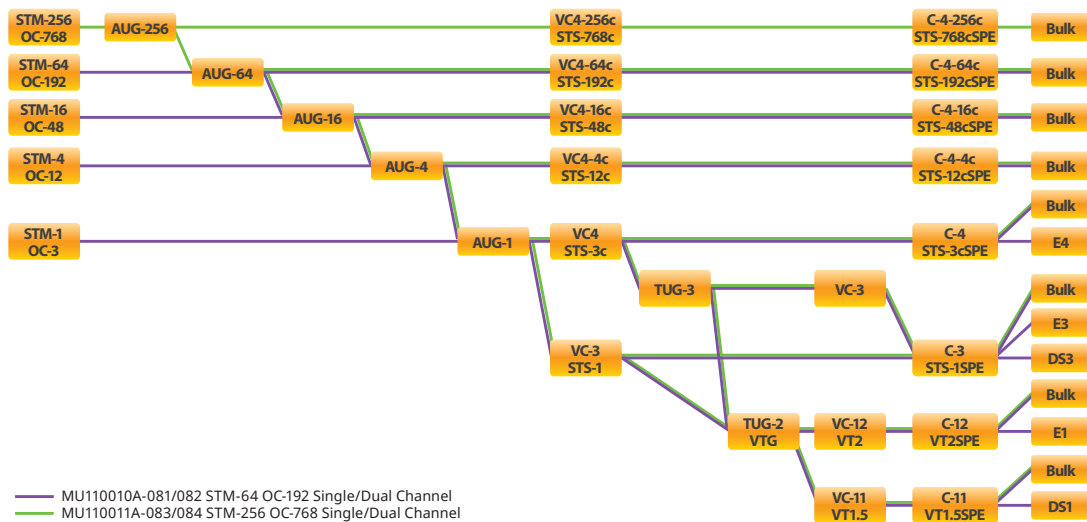

# PDH/DSn Testing Specifications

Alarms	<p>Detected and generated alarms</p> <ul style="list-style-type: none"> <li>SDH: LOS, LOF, OOF, MS-AIS, MS-RDI, AU-AIS, AU-LOP, HP-PLM, HP-UNEQ, HP-TIM, HP-RDI, TU-LOM, TU-AIS, TU-LOP, LP-PLM, LP-UNEQ, LP-TIM, LP-RDI, LSS</li> <li>STM-256: LOF-STL, OOF-STL, LOR-STL, OOR-STL</li> <li>SONET: LOS, LOF, OOF, AIS-L, RDI-L, AIS-P, LOP-P, TIM-P, PLM-P, UNEQ-P, RDI-P, LOM-V, AIS-V, LOP-V, PLM-V, UNEQ-V, RDI-V, TIM-V, LSS</li> <li>OC-768: LOF-STL, OOF-STL, LOR-STL, OOR-STL</li> <li>TCM: TC-LTC, TC-TIM, TC-UNEQ, TC-AIS, TC-RDI, TC-ODI, STL (STM-256)</li> </ul> <p>Inserted alarms</p> <ul style="list-style-type: none"> <li>Permanent</li> <li>Alternate: 1 to 8000 consecutive alarm frames, 1 to 8000 consecutive normal frames</li> </ul>
Errors	<p>Detected and generated errors</p> <ul style="list-style-type: none"> <li>SDH: A1/A2, B1, B2, MS-REI, B3, HP-REI, V5/B3, LP-REI, Pattern error, ERR trans</li> <li>STM-256: A1A2-STL</li> <li>SONET: A1/A2, B1, B2, REI-L, B3, REI-P, V5/B3, REI-V, Pattern error, ERR trans</li> <li>OC-768: A1A2-STL</li> <li>TCM: TC-IEC, TC-BIP2, TC-REI, TC-OEI</li> </ul> <p>Error insertion</p> <ul style="list-style-type: none"> <li>Manual: 1 to 8000 consecutive errors (excluding Pattern error) 1 to 4000 consecutive errors (for Pattern error)</li> <li>Continuous: <math>10^{-3}</math>, <math>10^{-4}</math>, <math>10^{-5}</math>, <math>10^{-6}</math>, <math>10^{-7}</math>, <math>10^{-8}</math>, <math>10^{-9}</math>, <math>10^{-10}</math> (The available highest rate varies depending on the error item.)</li> <li>Alternate: 1 to 8000 consecutive error frames, 1 to 8000 consecutive normal frames (excluding Pattern error and ERR trans) 1 to 4000 consecutive error bits, 100 to 4000 consecutive normal bits (for Pattern error)</li> </ul>
BER Test Pattern	<p>Pattern generation and detection for O.181 bulk test pattern</p> <ul style="list-style-type: none"> <li>Test patterns supported: PRBS 9, PRBS 11, PRBS 15, PRBS 20, PRBS 23, PRBS 29, PRBS 31, PRBS patterns can be inverted. All 0 s, All 1 s, Alternating 1:1, Alternating 1:3, Alternating 1:7, 2 in 8 User-defined patterns (Pattern length: up to 2048, Length step: 8-bit)</li> </ul>
Pointer	<ul style="list-style-type: none"> <li>Support pointer events monitoring and generation</li> <li>Pointer test sequences: None, Single alternating, Regular + Double, Regular + Missing, Double alternating</li> <li>Display pointer value of receiver side</li> <li>Graphical display of pointer movements</li> </ul>
Overhead	<ul style="list-style-type: none"> <li>Generation of section/transport and path overhead bytes</li> <li>Display of current section/transport and path overhead bytes</li> </ul> <p>All overhead can be decoded, including decoded J0, J1, J2 byte.</p>
STL Skew	<p>STM-256, OC-768</p> <ul style="list-style-type: none"> <li>Insertion Bits: 0 to 138240</li> <li>Detection Relative skew, Marker map</li> </ul>
Through Mode	<ul style="list-style-type: none"> <li>Transparent mode</li> <li>OH overwrite mode: Can be changed SOH (SDH), TOH (SONET)</li> </ul>

SDH and SONET Results	
Status	<p>Current information on</p> <ul style="list-style-type: none"> <li>Alarms and errors on monitored line</li> <li>Input level indication for optical signals</li> <li>Input level indication for electrical signals</li> <li>Actual bit rate</li> <li>Frequency deviation</li> </ul>
Statistics	<p>User-defined measurement resolution: 1, 2, 5, 10, 15, 30 s, 1, 5, 10, 15, 30 min, 1, 2, 4, 6, 12 h</p> <p>Logged information: Alarms (seconds and ratio), Errors (count or count and ratio), Pointer operations</p> <p>Event log: Major measurement events incl. errors, alarms and pointer operations are logged with 1-second resolution.</p>
Error Performance	<p>G.826/G.828/G.829/M.2100 analysis of received signal based on detected errors and alarms:</p> <p>ES, SES, BBE (not M.2100), UNAV</p>
APS	<p>APS (Automatic Protection Switching) test and analysis</p> <ul style="list-style-type: none"> <li>APS switching time is measured. A switching time exceeding the user-defined threshold is highlighted. <ul style="list-style-type: none"> <li>Trigger events (user selectable): <ul style="list-style-type: none"> <li>SDH: SDH alarms and errors, pattern bit error, APS switchover</li> <li>SONET: SONET alarms and errors, pattern bit error, APS switchover</li> </ul> </li> <li>Number of switchovers indicated by APS protocol</li> <li>K1/K2 bytes set and displayed</li> <li>Resolution of APS switching time measurement, SDH <ul style="list-style-type: none"> <li>SDH events excluding VC-12 and VC-11 events, LOS (Loss of Signal): 1 <math>\mu</math>s</li> <li>VC-12 and VC-11 events: 0.5 ms</li> </ul> </li> <li>Resolution of APS switching time measurement, SONET <ul style="list-style-type: none"> <li>SONET events excluding VT-1.5 and VT-2 events, LOS (Loss of Signal): 1 <math>\mu</math>s</li> <li>VT-1.5 and VT-2 events: 0.5 ms</li> </ul> </li> </ul> </li> </ul>
Round Trip Delay (Propagation Time) Measurement	<p>Resolution: 0.1 <math>\mu</math>s</p> <p>Measured Max. time: 10.0 s</p> <p>Interval: 0.5, 1, 2, 5, 10 s</p>
Tributary Scan	<p>Displays the alarm status of all channels in a specified layer except STM-256/OC-768</p> <p>Green: No alarm Red: Alarm occurring Gray: Not applied</p>

## PDH/DSn Testing Specifications

E1 Test	
Test Port	Electrical line interfaces: 2 ports (MU110010A-001) Connector: BNC or RJ48 (selectable)
General	Complies with ITU-T G.703 for 2048 kbps
Impedance	Supported input impedances • 75Ω (unbalanced), 120Ω (balanced), High (>10 × nominal)
Line Code	HDB3 or AMI
Framing	Unframed or Framed: FAS/nFAS, Transmitter: Sa-bits (non-FAS), User-programmable
Transmitter Clock	• Internal 2.048 Mbps clock accuracy: ±4.6 ppm, Clock offset: ±125 ppm (1 ppm steps) • Recovered from receiver • TTL level external 2.048 MHz clock • SETS (E1: 2.048 Mbps), BITS (DS1: 1.544 Mbps)
Receive Signal Rate	• 2048 kbps ±150 ppm • Frequency deviation indication accuracy: ±1 ppm
Receiver Attenuation and Impedance Mode	<u>TERMINATE</u> • Up to 40 dB cable attenuation, Nominal impedance <u>MONITOR</u> • 20 to 26 dB linear attenuation and up to 6 dB cable attenuation, Nominal impedance • 20 to 30 dB linear attenuation, 0 dB cable attenuation, Nominal impedance <u>BRIDGED</u> • Up to 40 dB cable attenuation, High impedance
Drop and Insert	Supports drop & insert of one or multiple 64 kbps timeslots (TS) within E1
Alarms	Detected and generated alarms: No signal, AIS, No frame, Distant (RDI) alarm, Pattern sync. loss, No CAS, MFAS, Distant (RDI) MF alarms
Errors	Detected: FAS/nFAS, CRC4, E-bit, Code, Pattern, Pattern slips, Frame slips Generated: FAS bit, FAS word, CRC-4, E-bit, Code, Pattern, Transparent Error insertion • Manual: 1 to 255 consecutive errors (1 to 16 consecutive FAS word errors) • Continuous: 10 <sup>-2</sup> , 10 <sup>-3</sup> , 10 <sup>-4</sup> , 10 <sup>-5</sup> , 10 <sup>-6</sup> , 10 <sup>-7</sup> • Provoking of G.821, G.826 or M.2100 events (ES, SES etc.) (FAS, Pattern, CRC-4, E-bit) Manual slip insertion: Frame slips, Pattern slips
BER Test Pattern	Pattern generation • Unframed or Framed: n × 64 kbps in contiguous or non-contiguous channel access Supported test patterns • PRBS 6, PRBS 7, PRBS 9, PRBS 11, PRBS 15, PRBS 20, PRBS 23, QRSS 11, QRSS 20 • Fox pattern, Fox (CMA 3000), All 0, All 1, Alternating (1:1), (1:3), (1:7), (3:24) • User-defined up to 32 bits (Length: 1-bit steps) • User-defined up to 2048 bits (Length: 8-bit steps) All patterns can be inverted, except user-defined
CAS	CAS signaling bits can be set.
Tone and Speech Signal Insertion	Tone in one speech channel on one transmitter • Frequency: 1 Hz to 4 kHz (1-Hz steps) • Level: -70 to +3 dBm (1-dBm steps) • Artificial speech signal
Speech Decode	64 kbps (ITU-T G.703): A-law according to ITU-T G.711

E1 Results	
Status	Current Information on • Alarms and errors on monitored line • Input level indication • Actual bit rate • Frequency deviation • FAS/non-FAS and CAS bits • Traffic overview: Busy/Idle indication from all 31 channels
Time Slot Monitoring	Contents of single time slot including positive/negative peak values. • Frequency for encoded tone: 1 Hz to 4 kHz (1-Hz steps) • Level for encoded tone: -66 to +3 dBm (1-dBm steps)
Statistics	User-defined measurement resolution: 1, 2, 5, 10, 15, 30 s, 1, 5, 10, 15, 30 min, 1, 2, 4, 6, 12 h Logged information: Alarms (seconds and ratio), Errors (count or count and ratio), Frequency deviation information Event log: Major measurement events incl. errors and alarms are logged with 1-second resolution.
Error Performance	G.821, G.826 or M.2100 analysis of PRBS in received signal, or based on CRC-4, E-bit or FAS: ES, SES, BBE (G.826), UAT, EFS, AT % or count. Error performance evaluation for total measurement: • HR% for user-defined error performance parameter or programmable OK and not-OK limits for FAS, Pattern, CRC-4 or E-bit count or ratio



# PDH/DSn Testing Specifications

APS	APS switching time is measured. A switching time exceeding the user-defined threshold is highlighted. Number of switchovers. Trigger events (User selectable): 2 Mbps alarms (LOF or AIS; pattern bit error) Resolution of APS switching time measurement: LOF and AIS: 0.25 ms
Round Trip Delay (Propagation Time) Measurement	Resolution: 1 $\mu$ s Measured Max. time: 10.0 s Interval: 0.5, 1, 2, 5, 10 s

DS1 Test	
Test Port	Electrical line interfaces: 2 ports (MU110010A-001) Connector: Bantam
General	Complies with ANSI T1.102 for 1544 kbps.
Impedance	100 $\Omega$ or High (10 $\times$ nominal; Receiver only) and DSX MON 100 $\Omega$ $\pm$ 1%
Line Code	B8ZS, AMI
Framing	Unframed or Framed, Framed: SF, ESF, J-ESF (J1)
Transmitter Clock	<ul style="list-style-type: none"> <li>Internal 1.544 Mbps clock accuracy: <math>\pm</math>4.6 ppm, Clock offset: <math>\pm</math>125 ppm (1 ppm steps)</li> <li>Recovered from receiver</li> <li>TTL level external 2.048 MHz clock</li> <li>SETS (E1: 2.048 Mbps), BITS (DS1: 1.544 Mbps)</li> </ul>
Line Build Out	0, -7.5, -15, -22.5 dB 0 to 133 ft, 133 to 266 ft, 266 to 399 ft, 399 to 533 ft, 533 to 655 ft
Receive Signal Rate	1544 kbps $\pm$ 150 ppm Frequency deviation indication resolution: $\pm$ 1 ppm
Receiver Sensitivity	<u>DS1 Short Haul</u> <ul style="list-style-type: none"> <li>15 dB linear attenuation, 0 dB cable attenuation, Nominal impedance</li> </ul> <u>TERMINATE</u> <ul style="list-style-type: none"> <li>Up to 36 dB cable attenuation, Nominal impedance</li> </ul> <u>DSX MONITOR</u> <ul style="list-style-type: none"> <li>15 to 25 dB linear attenuation, Nominal impedance</li> </ul> <u>BRIDGE</u> <ul style="list-style-type: none"> <li>Up to 36 dB cable attenuation, High impedance</li> </ul>
Drop and Insert	Drop & Insert of one or multiple 56 kbps or 64 kbps timeslots (TS) within DS1
Alarms	Generated and detected: LOS, OOF, AIS (Blue), RAI (Yellow), LSS
Errors	Generated or detected: Pattern, F-bit, S-bit, Pattern slips, BPV (Code), CRC-6, EXZ Error insertion <ul style="list-style-type: none"> <li>Manual: 1 to 255 consecutive errors</li> <li>Continuous: 10<sup>-2</sup>, 10<sup>-3</sup>, 10<sup>-4</sup>, 10<sup>-5</sup>, 10<sup>-6</sup>, 10<sup>-7</sup></li> <li>For performance: ES, SES</li> </ul>
BER Test Pattern	Supported test patterns <ul style="list-style-type: none"> <li>PRBS 9, PRBS 11, PRBS 15, PRBS 20, PRBS 23, PRBS 29, PRBS 31, QRSS 20</li> <li>All 0, All 1, Alternating (1:1), (1:3), (1:7), (3:24), Fox pattern, Fox (CMA 3000)</li> <li>User-defined up to 32 bits (Length: 1-bit steps)</li> <li>User-defined up to 2048 bits (Length: 8-bit steps)</li> </ul> All patterns can be inverted, except User-define
Loopback Code	Supported loopback codes: LLA, LLD, PLA, PLD, ULB, NLA, USR, ACS, DCS, AN1, DN1, AN2, DN2, 100K, USER_INBAND (User-defined FDL/in-band code) Insertion: On/Off
CAS	CAS signaling bits can be set.
Tone and Speech Signal Insertion	Tone in one speech channel on one transmitter <ul style="list-style-type: none"> <li>Frequency: 1 Hz to 4 kHz (1-Hz steps)</li> <li>Level: -70 to +3 dBm (1-dBm steps)</li> <li>Artificial speech signal</li> </ul>
Speech Decode	64 kbps or 56 kbps: $\mu$ -law

# PDH/DSn Testing Specifications

DS1 Results	
Status	Current Information on <ul style="list-style-type: none"> <li>• Alarms and errors on monitored line</li> <li>• Input level indication</li> <li>• Actual bit rate</li> <li>• Frequency deviation</li> <li>• Contents of one time slot</li> <li>• Framing and CAS bits</li> <li>• Traffic overview: Busy/Idle indication from all 24 channels</li> </ul>
Time Slot Monitoring	Contents of single time slot including positive/negative peak values. <ul style="list-style-type: none"> <li>• Frequency for encoded tone: 1 Hz to 4 kHz (1-Hz steps)</li> <li>• Level for encoded tone: -66 to +3 dBm (1-dBm steps)</li> </ul>
Statistics	User-defined measurement resolution: 1, 2, 5, 10, 15, 30 s, 1, 5, 10, 15, 30 min, 1, 2, 4, 6, 12 h Logged information: Alarms (seconds and ratio), Errors (count or count and ratio), Frequency deviation information Event log: Major measurement events incl. errors and alarms are logged with 1-second resolution.
Error Performance	G.821, G826, or M.2100 analysis of PRBS in received signal, or based on detected errors: ES, SES, ALS, UAT, AVT, EFS, BBE (G.826)
APS	APS switching time is measured. A switching time exceeding the user-defined threshold is highlighted. Number of switchovers. Trigger events (User selectable): 1.5 Mbps alarms (OOF, AIS; pattern bit error) APS switching time measurement resolution: No frame, AIS: 0.25 ms
Round Trip Delay (Propagation Time) Measurement	Resolution: 1 $\mu$ s Measured Max. time: 10.0 s Interval: 0.5, 1, 2, 5, 10 s

E3 Test	
Test Port	Electrical line interfaces: 2 ports (MU110010A-001) Connector: BNC
General	Complies with ITU-T G.703 for 34368 kbps
Impedance	75 $\Omega$
Line Code	HDB3
Framing	Unframed or Framed: Complies with ITU-T G.751 for E3 signals
Transmitter Clock	<ul style="list-style-type: none"> <li>• Internal clock accuracy: <math>\pm 4.6</math> ppm, Clock offset: <math>\pm 125</math> ppm (1 ppm steps)</li> <li>• Recovered from receiver</li> <li>• TTL level external 2.048 MHz clock</li> <li>• SETS (E1: 2.048 Mbps), BITS (DS1: 1.544 Mbps)</li> </ul>
Receive Signal Rate	34368 kbps $\pm 150$ ppm Frequency deviation indication resolution: $\pm 1$ ppm
Attenuation and Impedance Mode	<u>TERMINATE</u> <ul style="list-style-type: none"> <li>• Up to 12 dB cable attenuation, Nominal impedance</li> </ul> <u>MONITOR</u> <ul style="list-style-type: none"> <li>• 20 dB linear attenuation and up to 12 dB cable attenuation, Nominal impedance</li> <li>• 20 to 30 dB linear attenuation, 0 dB cable attenuation, Nominal impedance</li> </ul>
Alarms	Detected and generated alarms: No signal, AIS, No frame, RDI, Pattern sync. loss
Errors	Detected and generated errors: Frame, Code, Pattern, Pattern slip Error insertion <ul style="list-style-type: none"> <li>• Manual: 1 to 255 consecutive errors</li> <li>• Continuous: <math>10^{-2}</math>, <math>10^{-3}</math>, <math>10^{-4}</math>, <math>10^{-5}</math>, <math>10^{-6}</math>, <math>10^{-7}</math></li> <li>• For performance: ES, SES</li> </ul>
BER Test Pattern	Pattern Generation and Detection, Supported test patterns <ul style="list-style-type: none"> <li>• PRBS 9, PRBS 11, PRBS 15, PRBS 20, PRBS 23</li> <li>• Fox pattern, Fox (CMA 3000), All 0, All 1, Alternating 1:1, Alternating 1:3, Alternating 1:7, Alternating 3:24</li> <li>• User-defined up to 32 bits (Length: 1-bit steps)</li> <li>• User-defined up to 2048 bits (Length: 8-bit steps)</li> </ul> All patterns can be inverted, except user-defined

## PDH/DSn Testing Specifications

E3 Results	
Status	Current Information on <ul style="list-style-type: none"> <li>• Alarms and errors on monitored line</li> <li>• Input level indication</li> <li>• Actual bit rate</li> <li>• Frequency deviation</li> </ul>
Statistics	User-defined measurement resolution: 1, 2, 5, 10, 15, 30 s, 1, 5, 10, 15, 30 min, 1, 2, 4, 6, 12 h Logged information: Alarms (seconds and ratio), Errors (count or count and ratio), Frequency deviation information Event log: Major measurement events incl. errors and alarms are logged with 1-second resolution.
Error Performance	G.826/M.2100 analysis of received signal, or based on detected errors ES, SES, ALS, UAT, AVT, EFS, BBE (G.826)
Round Trip Delay (Propagation Time) Measurement	Resolution: 1 $\mu$ s Measured Max. time: 10.0 s Interval: 0.5, 1, 2, 5, 10 s

DS3 Test	
Test Port	Electrical line interfaces: 2 ports (MU110010A-001) Connector: BNC
General	Complies with ANSI for 44736 kbps
Impedance	75 $\Omega$
Line Code	B3ZS
Framing	Unframed or Framed, Framed: C-bit parity, M13 in accordance with ANSI T1.107
Transmitter Clock	<ul style="list-style-type: none"> <li>• Internal clock accuracy: <math>\pm 4.6</math> ppm, Clock offset: <math>\pm 125</math> ppm (1 ppm steps)</li> <li>• Recovered from receiver</li> <li>• TTL level external 2.048 MHz clock</li> <li>• SETS (E1: 2.048 Mbps), BITS (DS1: 1.544 Mbps)</li> </ul>
Line Build Out	0 ft, 225 ft
Receive Signal Rate	44736 kbps $\pm 150$ ppm Frequency deviation indication resolution: $\pm 1$ ppm
Attenuation and Impedance Mode	<b>TERMINATE</b> <ul style="list-style-type: none"> <li>• Up to 12 dB cable attenuation, Nominal impedance</li> </ul> <b>MONITOR</b> <ul style="list-style-type: none"> <li>• 20 dB linear attenuation and up to 12 dB cable attenuation, Nominal impedance</li> <li>• 20 to 30 dB linear attenuation, 0 dB cable attenuation, Nominal impedance</li> </ul>
Alarms	Detected and generated alarms: LOS, LOF, AIS (Blue), RAI (Yellow), DS3 idle, LSS
Errors	Detected and generated errors: Pattern, C-bit, F-bit, P-bit, Code (BPV), FEBE (detect only), EXZ (detect only) Error insertion <ul style="list-style-type: none"> <li>• Manual: 1 to 255 consecutive errors</li> <li>• Continuous: <math>10^{-2}</math>, <math>10^{-3}</math>, <math>10^{-4}</math>, <math>10^{-5}</math>, <math>10^{-6}</math>, <math>10^{-7}</math></li> </ul>
BER Test Pattern	Pattern generation and detection, Supported test patterns <ul style="list-style-type: none"> <li>• PRBS 9, PRBS 11, PRBS 15, PRBS 20, PRBS 23, PRBS 29, PRBS 31, QRSS 20</li> <li>• Fox pattern, Fox (CMA 3000), All 0, All 1, Alternating 1:1, Alternating 1:3, Alternating 1:7, Alternating 3:24</li> <li>• User-defined up to 32 bits (Length: 1-bit steps)</li> <li>• User-defined up to 2048 bits (Length: 8-bit steps)</li> </ul> All patterns can be inverted, except user-defined
Loopback Code	Supports FEAC and C-bits loopback (ANSI T1.404 & T1.107a)

DS3 Results	
Status	Current information on <ul style="list-style-type: none"> <li>• Alarms and errors on monitored line</li> <li>• Input level indication</li> <li>• Actual bit rate</li> <li>• Frequency deviation</li> </ul>
Statistics	User-defined measurement resolution: 1, 2, 5, 10, 15, 30 s, 1, 5, 10, 15, 30 min, 1, 2, 4, 6, 12 h Logged information: Alarms (seconds and ratio), Errors (count or count and ratio), Frequency deviation Event log: Major measurement events incl. errors and alarms are logged with 1-second resolution.
Error Performance	G.826/M.2100 analysis of received signal, or based on detected errors ES, SES, ALS, UAT, AVT, EFS, BBE (G.826)
Round Trip Delay (Propagation Time) Measurement	Resolution: 1 $\mu$ s Measured Max. time: 10.0 s Interval: 0.5, 1, 2, 5, 10 s

# PDH/DSn Testing Specifications

E4 Test	
Test Port	Electrical line interfaces: 2 ports (MU110010A-001) Connector: BNC
General	Complies with ITU-T G.703 for 139264 kbps interfaces
Impedance	75Ω
Line Code	CMI
Framing	Unframed or Framed: Complies with ITU-T G.751 for E4 signals
Transmitter Clock	<ul style="list-style-type: none"> <li>• Internal clock accuracy: ±4.6 ppm, Clock offset: ±125 ppm (1 ppm steps)</li> <li>• Recovered from receiver</li> <li>• TTL level external 2.048 MHz clock</li> <li>• SETS (E1: 2.048 Mbps), BITS (DS1: 1.544 Mbps)</li> </ul>
Receive Signal Rate	139264 kbps ±150 ppm Frequency deviation indication resolution: ±1 ppm
Attenuation and Impedance Mode	<p><u>TERMINATE</u></p> <ul style="list-style-type: none"> <li>• Up to 12 dB cable attenuation, Nominal impedance</li> </ul> <p><u>MONITOR</u></p> <ul style="list-style-type: none"> <li>• 20 dB linear attenuation and up to 12 dB cable attenuation, Nominal impedance</li> </ul>
Alarms	Detected and generated alarms: No signal, AIS, No frame, RDI, Pattern sync. loss
Errors	<p>Detected and generated errors: Frame, Pattern error, Pattern slips</p> <p>Error insertion</p> <ul style="list-style-type: none"> <li>• Manual: 1 to 255 consecutive errors</li> <li>• Continuous: 10<sup>-2</sup>, 10<sup>-3</sup>, 10<sup>-4</sup>, 10<sup>-5</sup>, 10<sup>-6</sup>, 10<sup>-7</sup></li> <li>• For performance: ES, SES</li> </ul>
BER Test Pattern	<p>Pattern generation and detection, Supported test patterns</p> <ul style="list-style-type: none"> <li>• PRBS 9, PRBS 11, PRBS 15, PRBS 20, PRBS 23, PRBS 29, PRBS 31, QRSS 20</li> <li>• All 0, All 1, Alternating 1:1, Alternating 1:3, Alternating 1:7, Alternating 3:24</li> <li>• User-defined up to 32 bits (Length: 1-bit steps)</li> <li>• User-defined up to 2048 bits (Length: 8-bit steps)</li> </ul> <p>All patterns can be inverted, except user-defined</p>

E4 Results	
Status	<p>Current information on</p> <ul style="list-style-type: none"> <li>• Alarms and errors on monitored line</li> <li>• Input level indication</li> <li>• Actual bit rate</li> <li>• Frequency deviation</li> </ul>
Statistics	<p>User-defined measurement resolution: 1, 2, 5, 10, 15, 30 s, 1, 5, 10, 15, 30 min, 1, 2, 4, 6, 12 h</p> <p>Logged information: Alarms (seconds and ratio), Errors (count or count and ratio), Frequency deviation</p> <p>Event log: Major measurement events incl. errors and alarms are logged with 1-second resolution.</p>
Error Performance	G.826/M.2100 analysis of received signal, or based on detected errors ES, SES, ALS, UAT, AVT, EFS, BBE (G.826)
Round Trip Delay (Propagation Time) Measurement	<p>Resolution: 1 μs</p> <p>Measured Max. time: 10.0 s</p> <p>Interval: 0.5, 1, 2, 5, 10 s</p>

# Optical Module Adaptors Specifications

## 10 Lane Extender MZ1223C

Interface/Connector	Host side: CFP MSA Draft 1.4 Compatible Interface Network side: SMP (plug) × 46
Insertion/Removal Cycles (max.)	Host side: 180 (CFP connector) Network side: 480 (SMP connector)
Insertion Loss	≤3.5 dB @ 5.59050 GHz (1/2 × 11.1809793568 Gbps) Including connector
Telecommunications Quality	Bit Error Rate: 1.0E-13 or less (Condition) for Evaluation: Installed in MT1100A, Loopback via 30 cm Semi-rigid cable Bit rate: 11.1809793568 Gbps × 10 lanes Pattern: PRBS31
Dimensions and Mass	160 (W) × 59.7 (H) × 218.4 (D) mm (excluding projections), ≤2 kg
Environmental	Temperature range Operating: +10° to +30°C, Storage: -20° to +60°C

✱: Each I/O of Tx10p, Tx10n, Rx10p, and Rx10n is not connected with MT1100A when MZ1223C is installed in MT1100A.

✱: Tx/Rx indicates transmission signal/reception signal. p/n indicates Positive/Negative sides for a differential interface.  
The logic level of the sending and receiving signal is 1.4VPMCL (Differential).

✱: MZ1223C and MT1100A are DC Coupled, and the capacitor for the AC coupling is not arranged in MZ1223C and MT1100A.

## CFP2-CFP4 Adaptor J1665A\*1

Interface/Connector	Host Side: CFP2 Plug connector CFP4 Side: CFP4 Host adaptor
Insert/Removal Cycles	Host Side: 50 times (CFP2 connector) CFP4 Side: 100 times (CFP4 connector)
Insertion Loss (S <sub>21</sub> )	≤-8.5 dB @14 GHz*2
Return Loss (S <sub>11</sub> ) CFP4 Side	≤-5 dB @14 GHz*2
Skew between Pair Connectors	≤4 ps
Dimensions and Mass	106.5 (W) × 41.5 (H) × 14.8 (D) mm (excluding projections), ≤120 g
Environmental	Temperature range Operating: 0° to +40°C, Storage: -20° to +60°C

✱1: Discontinued.

✱2: Defined as the total loss when connecting with HCB (Host Compliance Board) or MCB (Module Compliance Board) that conforms to CEI-28G-VSR.

## CFP2-QSFP28 Adaptor J1756A\*3

Interface/Connector	Host Side: CFP2 Plug connector QSFP28 Side: QSFP28 Host adaptor
Insert/Removal Cycles	Host Side: 50 times (CFP2 connector) QSFP28 Side: 100 times (QSFP28 connector)
Insertion Loss (S <sub>21</sub> )	≤-12 dB @14 GHz*4
Return Loss (S <sub>11</sub> ) QSFP28 Side	≤-4 dB @14 GHz*4
Dimensions and Mass	106.5 (W) × 41.5 (H) × 14.8 (D) mm (excluding projections), ≤120 g
Environmental	Temperature range Operating: 0° to +40°C, Storage: -20° to +60°C

✱3: Discontinued.

✱4: Defined as the total loss when connecting with HCB (Host Compliance Board) or MCB (Module Compliance Board) that conforms to CEI-28G-VSR.

# Ordering Information

Please specify the model/order number, name and quantity when ordering.  
The names listed in the chart below are Order Names. The actual name of the item may differ from the Order Name.

## 1. Mainframe

Model/Order No.	Name
<b>Mainframe</b>	
MT1100A	Network Master Flex
<b>Standard accessories for MT1100A</b>	
	Power Cord
Z1746A	Stylus
Z1870A	Utilities ROM
W3734AE	MT1100A Quick Reference Guide (English)
W3734AW	MT1100A Quick Reference Guide (Japanese)
Z1861A	Carrying Strap
Z1862A	Module Combination Kit
B0699A	Soft Case
<b>Option</b>	
MT1100A-003*1	Connectivity for WLAN/Bluetooth

\*1: Please visit the Anritsu web site for updated information.

## 2. Power Supply Module

Model/Order No.	Name
MU110001A*2	Battery and AC Power Supply Module
MU110002A*2	AC only High Power Supply Module
<b>Standard accessories for MU110001A</b>	
G0327A*3	Li-ion Battery: 2 pcs

\*2: Select MU110001A or MU110002A. Refer to page 31 for Configuration Guide.  
When installing two test modules in an MT1100A mainframe, one module must be an MU110010A to select MU110001A, battery powered power module.

\*3: MU110001A requires two G0327A.

## 3. Measurement Module\*4

Model/Order No.	Name
MU110010A	10G Multirate Module
MU110011A	100G Multirate Module
MU110013A	40/100G Advanced Module

\*4: One or two modules of MU110010A/11A/13A can be installed in one mainframe. Refer to page 31 for Configuration Guide.

## 4. Protocol Options\*5, \*6

### MU110010A

Model/Order No.	Name
<b>Ethernet</b>	
MU110010A-001	Up to 2.7G Dual Channel
MU110010A-011	Ethernet 10G Single Channel
MU110010A-012	Ethernet 10G Dual Channel
MU110010A-020	TCP Throughput
<b>CPRI/OBSAI</b>	
MU110010A-071	CPRI/OBSAI Up to 5G Dual Channel
MU110010A-072	CPRI/OBSAI 6G to 10G Single Channel
MU110010A-073	CPRI/OBSAI 6G to 10G Dual Channel
<b>OTN</b>	
MU110010A-001	Up to 2.7G Dual Channel
MU110010A-051	OTN 10G Single Channel
MU110010A-052	OTN 10G Dual Channel
MU110010A-061	ODU Multiplexing
MU110010A-062	ODU Flex
<b>SDH/SONET</b>	
MU110010A-001	Up to 2.7G Dual Channel
MU110010A-081	STM-64 OC-192 Single Channel
MU110010A-082	STM-64 OC-192 Dual Channel
<b>Fibre Channel</b>	
MU110010A-002	FC 1G 2G 4G Dual Channel
MU110010A-091	FC 8G 10G Single Channel
MU110010A-092	FC 8G 10G Dual Channel

\*5: "channel" means physical port or client signal test mapped in OTN.  
Refer to page 5 to 7 for OTN and client signals.

\*6: These options can be retrofitted.

The Model/Order No. of retrofit options is "-3\*\*".

Example

MU110010A-001 Up to 2.7G Dual Channel becomes MU110010A-301 Up to 2.7G Dual Channel Retrofit. In addition, specify one of the following media along with the required option.

Model/Order No.	Name
Z1849A	DVD-ROM for Retrofit Options
Z1850A	USB Stick for Retrofit Options

### MU110011A

Model/Order No.	Name
<b>Ethernet</b>	
MU110011A-001	Up to 10G Single Channel
MU110011A-003	Up to 10G Dual Channel
MU110011A-013	Ethernet 40G Single Channel
MU110011A-014	Ethernet 40G Dual Channel
MU110011A-015	Ethernet 100G Single Channel
MU110011A-020	TCP Throughput
<b>CPRI/OBSAI</b>	
MU110011A-071	CPRI/OBSAI Up to 10G Single Channel
MU110011A-072	CPRI/OBSAI Up to 10G Dual Channel
<b>OTN</b>	
MU110011A-001	Up to 10G Single Channel
MU110011A-003	Up to 10G Dual Channel
MU110011A-053	OTN 40G Single Channel
MU110011A-054	OTN 40G Dual Channel
MU110011A-055	OTN 100G Single Channel
MU110011A-061	ODU Multiplexing
MU110011A-062	ODU Flex
MU110011A-063*7	40G/100G ODU Multi Stage
<b>SDH/SONET</b>	
MU110011A-001	Up to 10G Single Channel
MU110011A-003	Up to 10G Dual Channel
MU110011A-083	STM-256 OC-768 Single Channel
MU110011A-084	STM-256 OC-768 Dual Channel
<b>Fibre Channel</b>	
MU110011A-005	Up to 10G FC Single Channel
MU110011A-004	Up to 10G FC Dual Channel

### MU110013A

Model/Order No.	Name
<b>Ethernet</b>	
MU110013A-001**8	Up to 10G Single Channel
MU110013A-003**8	Up to 10G Dual Channel
MU110013A-013	Ethernet 40G Single Channel
MU110013A-014	Ethernet 40G Dual Channel
MU110013A-015	Ethernet 100G Single Channel
MU110013A-016	Ethernet 100G Dual Channel
MU110013A-023*9	RS-FEC for 100GBASE-SR4
<b>CPRI/OBSAI</b>	
MU110013A-071**8	CPRI Up to 10G Single Channel
MU110013A-072**8	CPRI Up to 10G Dual Channel
<b>OTN</b>	
MU110013A-001**8	Up to 10G Single Channel
MU110013A-003**8	Up to 10G Dual Channel
MU110013A-053	OTN 40G Single Channel
MU110013A-054	OTN 40G Dual Channel
MU110013A-055	OTN 100G Single Channel
MU110013A-056	OTN 100G Dual Channel
MU110013A-062	ODU Flex
MU110013A-063	40G/100G ODU Multi Stage
<b>SDH/SONET</b>	
MU110013A-001**8	Up to 10G Single Channel
MU110013A-003**8	Up to 10G Dual Channel
MU110013A-083**8	STM-256 OC-768 Single Channel
MU110013A-084**8	STM-256 OC-768 Dual Channel
<b>Fibre Channel</b>	
MU110013A-005**8	Up to 10G FC Single Channel
MU110013A-004**8	Up to 10G FC Dual Channel
<b>Device Test</b>	
MU110013A-008*10	4 × 25G/28G BERT

\*7: These options including MU11001xA-061 function.

\*8: MU110013A does not have a physical interface of these options.

These options are required for the client signal mapped in the OTN.

Refer to page 5 to 7 for OTN and client signals.

\*9: Required to MU110013A-015 or MU110013A-016.

\*10: Requires one of the following options:

MU100013A-015, MU100013A-016, MU100013A-055, MU100013A-056

# Ordering Information

## Configuration Guide

### Mainframe and Modules

Product Number	Product Name	Description
MT1100A	Network Master Flex	Network Master Flex Mainframe
MU110001A	Battery and AC Power Supply Module	Power supply module for MT1100A Includes G0237A × 2 (Battery), Z1862A (Hexagon wrench)
MU110002A	AC only High Power Supply Module	High power supply module for MT1100A Includes Z1862A (Hexagon wrench)
MU110010A	10G Multirate Module	SFP/SFP+: 2, RJ45: 2, BNC (Tx/Rx): 2, RJ48: 2, Mini-bantam (Tx/Rx): 2
MU110011A	100G Multirate Module	CFP: 1, QSFP+: 2, SFP/SFP+: 2, RJ45: 2
MU110013A	40/100G Advanced Module	CFP2: 2, CXP: 2, QSFP+: 2, QSFP28: 2 (When using Z2046A, Z2047A, and Z2048A)

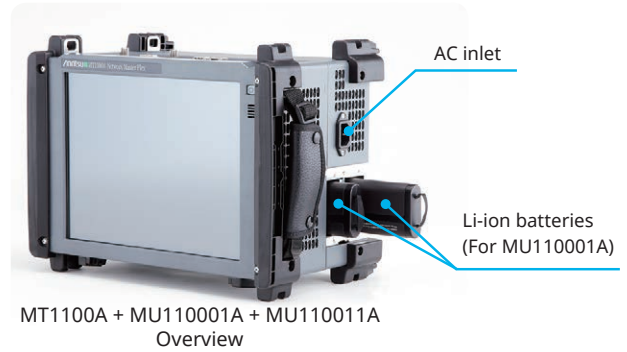
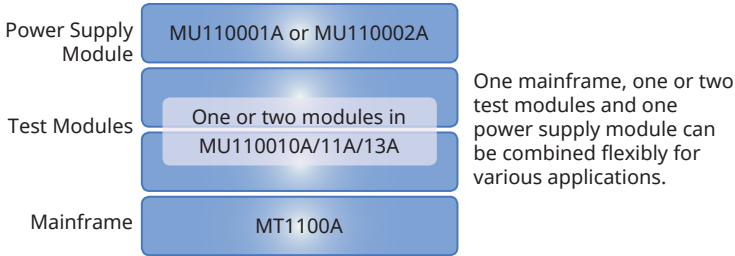

### Power Supply Modules and Test Modules Combination

Battery and AC Power Supply Module MU110001A

		Module 2			
		No Module	MU110010A	MU110011A	MU110013A
Module 1	MU110010A	✓	✓	✓	✓
	MU110011A	✓	✓	—	—
	MU110013A	✓	✓	—	—

AC only High Power Supply Module MU110002A

		Module 2			
		No Module	MU110010A	MU110011A	MU110013A
Module 1	MU110010A	✓	✓	✓	✓
	MU110011A	✓	✓	✓	✓
	MU110013A	✓	✓	✓	✓

✓: Available —: Not Available

### Test Modules and Maximum Operating Ports

Protocol	PDH/DSn	OTU1	100 Mbps to 1 Gbps Ethernet	STM-16/OC-48	1GF to 4GFC	OTU2/1e/2e/1f/2f	10 Gbps Ethernet	STM-64/OC-192	8GFC to 10GFC	OBSA11 X to 4 X	CPRI Option 1 to 8	OTU3/3e1/3e2	40 Gbps Ethernet	STM-256/OC-768	OTU4	100 Gbps Ethernet
MU110010A	2 ports	2 ports			2 ports											
MU110011A		2 ports			2 ports						2 ports*1	1 port				
MU110013A											2 ports	*2	2 ports			

\*1: Up to two ports in two QSFP+ and one CFP can be operated simultaneously.

\*2: MU110013A does not have a STM-256/OC-768 physical interface.

MU110013A-083/084 are the options for STM-256/OC-768 client signals mapped in the OTN. Please refer to page 7.

## Ordering Information

### 5. Optional Accessories

Model/Order No.	Name
<b>Optical modules*10</b>	
G0332A	100M FX 1310 nm MM SFP
G0329A	10G LR 1310 nm SFP+
G0315A	10G LR/LW 1310 nm SFP+
G0316A	10G ER/EW 1550 nm 40 km SFP+
G0318A	10G ZR/ZW 1550 nm 80 km SFP+
G0319A	Up to 2.7G 1310 nm 15 km SFP
G0320A	Up to 2.7G 1310 nm 40 km SFP
G0321A	Up to 2.7G 1550 nm 80 km SFP
G0328A	1G/2G/4G FC 850 nm SFP
G0322A	1G/2G/4G FC 1310 nm SFP
G0323A	1G/2G/4G FC 1550 nm SFP
G0356A	8G FC/10G SR 850 nm SFP+
G0359A	40G SR4 850 nm QSFP+
G0334A	40G LR4 1310 nm QSFP+
G0335A	40G LR4 1310 nm CFP
G0336A	40G FR 1550 nm CFP
G0337A	100G LR4 1310 nm CFP
G0338A	100G LR4 1310 nm CFP2
G0339A	100G 850 nm CXP
Z2048A*11	CFP2-QSFP28 Adaptor with G0366A
Z2046A*11	CFP2-QSFP28 Adaptor with G0364A
Z2047A*11	CFP2-QSFP28 Adaptor with G0365A
<b>Mainframe optional accessories</b>	
B0717A	Hard Case
Z1860A	Battery Charger
G0325A	GPS Receiver
Z1871A	Utilities in USB Stick
B0692A*12	ESD Box
G0382A	Autofocus Video Inspection Probe
G0306B	Video Inspection Probe
J1667A*13	GPIB-USB Converter
B0705A	Rack Mount Kit
<b>Cables</b>	
J1571A	Optical Cable SM LC/PC to SC/PC 3 m
J1575A	Optical Cable SM LC/PC to FC/PC 3 m
J1579A	Optical Cable SM LC/PC to LC/PC 3 m
J1581A	Optical Cable MM LC/PC to LC/PC 3 m
J1583A	Optical Attenuator 10 dB LC/PC to LC/PC
J1584A	RJ45 Cable 3 m
J1585A	RJ48 to Crocodile Clips Cable 3 m
J1586A	RJ48 to Crocodile Clips Cable 20 dB ATT 3 m
J1588A	BNC Cable 2.5 m
J1589A	BNC to 1.6/5.6 Cable 2.5 m
J1591A	RJ48 to Two 3-pin Banana Plug Cable 2.5 m
J1597A	RJ48 Balanced PDH Cable Crossed 3 m
J1598A	Bantam Cable 3 m
J0775D	Coaxial Cord, 2.0 m (75Ω)
<b>Manuals</b>	
W3735AE	MT1100A Operation Manual (English)
W3735AW	MT1100A Operation Manual (Japanese)
W3736AE	MT1000A/MT1100A Remote Scripting Operation Manual (English)
W3736AW	MT1000A/MT1100A Remote Scripting Operation Manual (Japanese)

\*10: Refer to page 22 for the specifications of the optical module.

\*11: Set of QSFP28 optical modules and CFP2-QSFP28 conversion adapters.

\*12: Up to 4 SFP+/SFPs can be stored.

\*13: J1667A is required for SCPI remote control via GPIB.

### 6. Extended Warranties

Model/Order No.	Name
MT1100A-ES210	2 Years Extended Warranty Service
MT1100A-ES310	3 Years Extended Warranty Service
MT1100A-ES510	5 Years Extended Warranty Service
MU110001A-ES210	2 Years Extended Warranty Service
MU110001A-ES310	3 Years Extended Warranty Service
MU110001A-ES510	5 Years Extended Warranty Service
MU110002A-ES210	2 Years Extended Warranty Service
MU110002A-ES310	3 Years Extended Warranty Service
MU110002A-ES510	5 Years Extended Warranty Service
MU110010A-ES210	2 Years Extended Warranty Service
MU110010A-ES310	3 Years Extended Warranty Service
MU110010A-ES510	5 Years Extended Warranty Service
MU110011A-ES210	2 Years Extended Warranty Service
MU110011A-ES310	3 Years Extended Warranty Service
MU110011A-ES510	5 Years Extended Warranty Service
MU110013A-ES210	2 Years Extended Warranty Service
MU110013A-ES310	3 Years Extended Warranty Service
MU110013A-ES510	5 Years Extended Warranty Service



# Optical Transceivers Interface List

MU110010A	MU110011A	MU110013A	Model/ Order No.	Name	Form Factor	100 Meg Ethernet	156 Meg STM-1	614 Meg CPRI	622 Meg STM-4	768 Meg OBSAI	1 Gig FC	1.23 Gig CPRI	1.25 Gig Ethernet	1.54 Gig OBSAI	2 Gig FC	2.46 Gig CPRI	2.488 Gig STM-16	2.67 Gig OTU1	3.07 Gig CPRI OBSAI	4 Gig FC	4.92 Gig CPRI	6.14 Gig CPRI OBSAI	8 Gig FC	9.83 Gig CPRI	9.95 Gig STM-64	10.1 Gig CPRI	10.3 Gig Ethernet	10.5 Gig FC	10.7 Gig OTU2	11.05 Gig OTU1e	11.09 Gig OTU2e	11.27 Gig OTU1f	11.3 Gig OTU2f	40G SDH/SONET	40G Ethernet	40G OTN	100G Ethernet	100G OTN				
✓	✓		G0332A	100M FX 1310 nm MM SFP	SFP	1310 nm, MM, 2 km																																				
✓	✓		G0329A	10G LR 1310 nm SFP+	SFP+							1310 nm, SM, 10 km																														
✓	✓		G0315A	10G LR/LW 1310 nm SFP+	SFP+																																					
✓	✓		G0316A	10G ER/EW 1550 nm 40 km SFP+	SFP+																																					
✓	✓		G0318A	10G ZR/ZW 1550 nm 80 km SFP+	SFP+																																					
✓	✓		G0319A	Up to 2.7G 1310 nm 15 km SFP	SFP							1310 nm, SM, 15 km																														
✓	✓		G0320A	Up to 2.7G 1310 nm 40 km SFP	SFP							1310 nm, SM, 40 km																														
✓	✓		G0321A	Up to 2.7G 1550 nm 80 km SFP	SFP							1550 nm, SM, 80 km																														
✓	✓		G0328A	1G/2G/4G FC 850 nm SFP	SFP							850 nm, MM, 0.5 km																														
✓	✓		G0322A	1G/2G/4G FC 1310 nm SFP	SFP							1310 nm, SM, 10 km																														
✓	✓		G0323A	1G/2G/4G FC 1550 nm SFP	SFP							1550 nm, SM, 40 km																														
✓	✓		G0356A	8G FC/10G SR 850 nm SFP+	SFP+																		850 nm, MM, 0.3 km																			
✓	✓		G0359A	40G SR4 850 nm QSFP+	QSFP+																																					
✓	✓		G0334A	40G LR4 1310 nm QSFP+	QSFP+																																					
✓			G0335A	40G LR4 1310 nm CFP	CFP																																					
✓			G0336A	40G FR 1550 nm CFP	CFP																																					
✓			G0337A	100G LR4 1310 nm CFP	CFP																																					
	✓		G0338A	100G LR4 1310 nm CFP2	CFP2																																					
	✓		G0339A	100G 850 nm CXP	CXP																																					
	✓		Z2048A*	CFP2-QSFP28 Adaptor with G0366A	CFP2 (QSFP28)																																					
	✓		Z2046A*	CFP2-QSFP28 Adaptor with G0364A	CFP2 (QSFP28)																																					
	✓		Z2047A*	CFP2-QSFP28 Adaptor with G0365A	CFP2 (QSFP28)																																					

\*: Set of QSFP28 optical modules and CFP2-QSFP28 conversion adapters. See page 34 for details of G0364A, G0365A, and G0366A.

# Optical Transceivers Specification

Model/Order No.	Description (Approx. Distance)	Max. Input Power	Input Sensitivity	Input Wavelength	Output Power	Output Wavelength	Loop Back
G0332A 100M FX 1310 nm MM SFP	10GBASE - FX 1310 nm multi mode (2 km)	-14 dBm	-31 dBm	1270 nm to 1600 nm	-20 to -15 dBm	1280 nm to 1380 nm	OK
G0329A 10G LR 1310 nm SFP+	10GBASE - LR 1310 nm single mode (10 km)	+0.5 dBm	-14 dBm	1260 nm to 1355 nm	-8.2 to +0.5 dBm	1260 nm to 1355 nm	OK
G0315A 10G LR/LW 1310 nm SFP+	10GBASE - LR 1310 nm single mode (10 km)	+0.5 dBm	-14.4 dBm	1260 nm to 1565 nm	-6 to -1 dBm	1290 nm to 1330 nm	OK
G0316A 10G ER/EW 1550 nm 40 km SFP+	10GBASE - ER 1550 nm single mode (40 km)	-1 dBm	-15.8 dBm	1260 nm to 1565 nm	-3 to +3 dBm	1530 nm to 1560 nm	>4 dB ATT
G0318A 10G ZR/ZW 1550 nm 80 km SFP+	10GBASE - ER 1550 nm single mode (80 km)	-8 dBm	-22 dBm	1260 nm to 1565 nm	0 to +5 dBm	1525 nm to 1565 nm	>13 dB ATT
G0319A Up to 2.7G 1310 nm 15 km SFP	STM-1/4/16 short haul 1310 nm single mode (15 km)	0 dBm	-18 dBm	1270 nm to 1580 nm	-5 to 0 dBm	1260 nm to 1360 nm	OK
G0320A Up to 2.7G 1310 nm 40 km SFP	STM-1/4/16 long haul 1310 nm single mode (40 km)	-9 dBm	-27 dBm	1270 nm to 1580 nm	-2 to +3 dBm	1280 nm to 1335 nm	>12 dB ATT
G0321A Up to 2.7G 1550 nm 80 km SFP	STM-1/4/16 long haul 1550 nm single mode (80 km)	-9 dBm	-28 dBm	1270 nm to 1580 nm	-2 to +3 dBm	1500 nm to 1580 nm	>12 dB ATT
G0328A 1G/2G/4G FC 850 nm SFP	1GFC, 2GFC, 4GFC 850 nm multi mode (0.5 km)	-3 dBm	-15 dBm	830 nm to 860 nm	-9 to 0 dBm	830 nm to 860 nm	>3 dB ATT
G0322A 1G/2G/4G FC 1310 nm SFP	1GFC, 2GFC, 4GFC 1310 nm single mode (10 km)	-3 dBm	-18 dBm	1260 nm to 1360 nm	-8 to 0 dBm	1260 nm to 1360 nm	>3 dB ATT
G0323A 1G/2G/4G FC 1550 nm SFP	1GFC, 2GFC, 4GFC 1550 nm single mode (40 km)	-3 dBm	-18 dBm	1470 nm to 1600 nm	0 to +5 dBm	1510 nm to 1590 nm	>8 dB ATT
G0356A 8G FC/10G SR 850 nm SFP+	8GFC, 10GFC, 10GBASE - SR 850 nm multi mode (0.3 km)	-1 dBm	-11.1 dBm	840 nm to 860 nm	-7.3 to -1.0 dBm	840 nm to 860 nm	OK
G0359A 40G SR4 850 nm QSFP+	40GBASE - SR4 850 nm multi mode (0.1 km)	+2.4 dBm (per Lane)	-9.9 dBm	840 nm to 860 nm	-8 to +2.4 dBm	840 nm to 860 nm	OK
G0334A 40G LR4 1310 nm QSFP+	40G Ethernet/OTN 1310 nm single mode (10 km)	+2.3 dBm (per Lane)	-11.5 dBm (per Lane)	1264.5 nm to 1277.5 nm 1284.5 nm to 1297.5 nm 1304.5 nm to 1317.5 nm 1324.5 nm to 1337.5 nm	+8.3 dBm (max.) (Total) -2 to +2.3 dBm (per Lane)	1264.5 nm to 1277.5 nm 1284.5 nm to 1297.5 nm 1304.5 nm to 1317.5 nm 1324.5 nm to 1337.5 nm	OK
G0335A 40G LR4 1310 nm CFP	40G Ethernet/OTN 1310 nm single mode (10 km)	+2.3 dBm (per Lane)	-11.1 dBm (per Lane)	1264.5 nm to 1277.5 nm 1284.5 nm to 1297.5 nm 1304.5 nm to 1317.5 nm 1324.5 nm to 1337.5 nm	+8.3 dBm (max.) (Total) -2 to +2.3 dBm (per Lane)	1264.5 nm to 1277.5 nm 1284.5 nm to 1297.5 nm 1304.5 nm to 1317.5 nm 1324.5 nm to 1337.5 nm	OK
G0336A 40G FR 1550 nm CFP	40G SDH/OTN 1550 nm single mode (2 km)	+3 dBm (per Lane)	-6 dBm	1530 nm to 1565 nm	0 to +3 dBm	1530 nm to 1565 nm	OK
G0337A 100G LR4 1310 nm CFP	100G Ethernet/OTN 1310 nm single mode (10 km)	+4.5 dBm (per Lane)	-10.3 dBm (per Lane)	1294.53 nm to 1296.59 nm 1299.02 nm to 1301.09 nm 1303.54 nm to 1305.63 nm 1308.09 nm to 1310.19 nm	+8.9 dBm (max.) (Total) -2.9 to +2.9 dBm (per Lane)	1294.53 nm to 1296.59 nm 1299.02 nm to 1301.09 nm 1303.54 nm to 1305.63 nm 1308.09 nm to 1310.19 nm	OK
G0338A 100G LR4 1310 nm CFP2	100G Ethernet/OTN 1310 nm single mode (10 km)	+4.5 dBm (per Lane)	-10.3 dBm (per Lane)	1294.53 nm to 1296.59 nm 1299.02 nm to 1301.09 nm 1303.54 nm to 1305.63 nm 1308.09 nm to 1310.19 nm	+8.9 dBm (max.) (Total) -2.9 to +2.9 dBm (per Lane)	1294.53 nm to 1296.59 nm 1299.02 nm to 1301.09 nm 1303.54 nm to 1305.63 nm 1308.09 nm to 1310.19 nm	OK
G0339A 100G 850 nm CXP	100G Ethernet 850 nm multi mode (0.1 km)	+2.4 dBm (per Lane)	-9.5 dBm (per Lane)	840 nm to 860 nm	+8.9 dBm (max.) (Total) -7.6 to +2.4 dBm (per Lane)	840 nm to 860 nm	OK
G0366A 100G BASE-SR4 QSFP28	100G Ethernet 850 nm multi mode (0.1 km)	+2.4 dBm (per Lane)	-9.9 dBm (per Lane)	840 nm to 860 nm	+8.9 dBm (max.) (Total) -9.1 to +2.4 dBm (per Lane)	840 nm to 860 nm	OK
G0364A 100G BASE-LR4 QSFP28	100G Ethernet 1310 nm single mode (10 km)	+4.5 dBm (per Lane)	-8.6 dBm (per Lane)	1294.53 nm to 1296.59 nm 1299.02 nm to 1301.09 nm 1303.54 nm to 1305.63 nm 1308.09 nm to 1310.19 nm	+10.5 dBm (max.) (Total) -4.3 to +4.5 dBm (per Lane)	1294.53 nm to 1296.59 nm 1299.02 nm to 1301.09 nm 1303.54 nm to 1305.63 nm 1308.09 nm to 1310.19 nm	OK
G0365A 100G LR4 Dual Rate 1310 nm QSFP28	100G Ethernet /OTN 1310 nm single mode (10 km)	+4 dBm (per Lane)	-8.4 dBm (per Lane)	1294.53 nm to 1296.59 nm 1299.02 nm to 1301.09 nm 1303.54 nm to 1305.63 nm 1308.09 nm to 1310.19 nm	+10 dBm (max.) (Total) -0.6 to +4 dBm (per Lane)	1294.53 nm to 1296.59 nm 1299.02 nm to 1301.09 nm 1303.54 nm to 1305.63 nm 1308.09 nm to 1310.19 nm	OK
G0369A 100G LR4 Dual Rate 1310 nm CFP4	100G Ethernet /OTN 1310 nm single mode (10 km)	+4.5 dBm (per Lane)	-8.6 dBm (per Lane)	1294.53 nm to 1296.59 nm 1299.02 nm to 1301.09 nm 1303.54 nm to 1305.63 nm 1308.09 nm to 1310.19 nm	+10.5 dBm (max.) (Total) -4.3 to +4.5 dBm (per Lane)	1294.53 nm to 1296.59 nm 1299.02 nm to 1301.09 nm 1303.54 nm to 1305.63 nm 1308.09 nm to 1310.19 nm	OK



● **United States**

**Anritsu Americas Sales Company**

450 Century Parkway, Suite 190, Allen,  
TX 75013, U.S.A.  
Phone: +1-800-Anritsu (1-800-267-4878)

● **Canada**

**Anritsu Electronics Ltd.**

700 Silver Seven Road, Suite 120, Kanata,  
Ontario K2V 1C3, Canada  
Phone: +1-613-591-2003  
Fax: +1-613-591-1006

● **Brazil**

**Anritsu Eletronica Ltda.**

Praça Amadeu Amaral, 27 - 1 Andar  
01327-010 - Bela Vista - Sao Paulo - SP  
Brazil  
Phone: +55-11-3283-2511  
Fax: +55-11-3288-6940

● **Mexico**

**Anritsu Company, S.A. de C.V.**

Bldv Miguel de Cervantes Saavedra #169 Piso 1, Col. Granada  
Mexico, Ciudad de Mexico, 11520, MEXICO  
Phone: +52-55-4169-7104

● **United Kingdom**

**Anritsu EMEA Ltd.**

200 Capability Green, Luton, Bedfordshire, LU1 3LU, U.K.  
Phone: +44-1582-433200  
Fax: +44-1582-731303

● **France**

**Anritsu S.A.**

12 avenue du Québec, Bâtiment Iris 1-Silic 612,  
91140 VILLEBON SUR YVETTE, France  
Phone: +33-1-60-92-15-50  
Fax: +33-1-64-46-10-65

● **Germany**

**Anritsu GmbH**

Nemetschek Haus, Konrad-Zuse-Platz 1  
81829 München, Germany  
Phone: +49-89-442308-0  
Fax: +49-89-442308-55

● **Italy**

**Anritsu S.r.l.**

Via Elio Vittorini 129, 00144 Roma, Italy  
Phone: +39-6-509-9711  
Fax: +39-6-502-2425

● **Sweden**

**Anritsu AB**

Isafjordsgatan 32C, 164 40 KISTA, Sweden  
Phone: +46-8-534-707-00

● **Finland**

**Anritsu AB**

Teknobulevardi 3-5, FI-01530 VANTAA, Finland  
Phone: +358-20-741-8100  
Fax: +358-20-741-8111

● **Denmark**

**Anritsu A/S**

Torveporten 2, 2500 Valby, Denmark  
Phone: +45-7211-2200  
Fax: +45-7211-2210

● **Russia**

**Anritsu EMEA Ltd.**

**Representation Office in Russia**

Tverskaya str. 16/2, bld. 1, 7th floor.  
Moscow, 125009, Russia  
Phone: +7-495-363-1694  
Fax: +7-495-935-8962

● **Spain**

**Anritsu EMEA Ltd.**

**Representation Office in Spain**

Edificio Cuzco IV, Po. de la Castellana, 141, Pta. 5  
28046, Madrid, Spain  
Phone: +34-915-726-761  
Fax: +34-915-726-621

● **United Arab Emirates**

**Anritsu EMEA Ltd.**

**Dubai Liaison Office**

902, Aurora Tower,  
P O Box: 500311 - Dubai Internet City  
Dubai, United Arab Emirates  
Phone: +971-4-3758479  
Fax: +971-4-4249036

● **India**

**Anritsu India Private Limited**

6th Floor, Indigube ETA, No.38/4, Adjacent to EMC2,  
Doddanekundi, Outer Ring Road, Bengaluru - 560048, India  
Phone: +91-80-6728-1300  
Fax: +91-80-6728-1301

● **Singapore**

**Anritsu Pte. Ltd.**

11 Chang Charn Road, #04-01, Shriro House  
Singapore 159640  
Phone: +65-6282-2400  
Fax: +65-6282-2533

● **P.R. China (Shanghai)**

**Anritsu (China) Co., Ltd.**

Room 2701-2705, Tower A,  
New Caohejing International Business Center  
No. 391 Gui Ping Road Shanghai, 200233, P.R. China  
Phone: +86-21-6237-0898  
Fax: +86-21-6237-0899

● **P.R. China (Hong Kong)**

**Anritsu Company Ltd.**

Unit 1006-7, 10/F., Greenfield Tower, Concordia Plaza,  
No. 1 Science Museum Road, Tsim Sha Tsui East,  
Kowloon, Hong Kong, P.R. China  
Phone: +852-2301-4980  
Fax: +852-2301-3545

● **Japan**

**Anritsu Corporation**

8-5, Tamura-cho, Atsugi-shi, Kanagawa, 243-0016 Japan  
Phone: +81-46-296-6509  
Fax: +81-46-225-8352

● **Korea**

**Anritsu Corporation, Ltd.**

5FL, 235 Pangyoyeok-ro, Bundang-gu, Seongnam-si,  
Gyeonggi-do, 13494 Korea  
Phone: +82-31-696-7750  
Fax: +82-31-696-7751

● **Australia**

**Anritsu Pty. Ltd.**

Unit 20, 21-35 Ricketts Road,  
Mount Waverley, Victoria 3149, Australia  
Phone: +61-3-9558-8177  
Fax: +61-3-9558-8255

● **Taiwan**

**Anritsu Company Inc.**

7F, No. 316, Sec. 1, NeiHu Rd., Taipei 114, Taiwan  
Phone: +886-2-8751-1816  
Fax: +886-2-8751-1817