

# Keysight N5102A Baseband Studio Digital Signal Interface Module

Due to our continuing efforts to improve our products through firmware and hardware revisions, N5102A module design and operation may vary from descriptions in this guide. We recommend that you use the latest revision of this guide to ensure you have up-to-date product information. Compare the print date of this guide with the latest revision, which can be downloaded from the following website:  
<http://www.keysight.com/find/basebandstudio>

Notice: This document contains references to Agilent. Please note that Agilent's Test and Measurement business has become Keysight Technologies. For more information, go to [www.keysight.com](http://www.keysight.com).

# Notices

© Keysight Technologies, Inc.  
2012-2015

No part of this manual may be reproduced in any form or by any means (including electronic storage and retrieval or translation into a foreign language) without prior agreement and written consent from Keysight Technologies, Inc. as governed by United States and international copyright laws.

## Trademark Acknowledgments

## Manual Part Number

N5102-90003

## Print Date

January 2015

Published in USA

Keysight Technologies  
1400 Fountaingrove Parkway  
Santa Rosa, CA 95403

## Warranty

THE MATERIAL CONTAINED IN THIS DOCUMENT IS PROVIDED "AS IS," AND IS SUBJECT TO BEING CHANGED, WITHOUT NOTICE, IN FUTURE EDITIONS. FURTHER, TO THE MAXIMUM EXTENT PERMITTED BY APPLICABLE LAW, KEYSIGHT DISCLAIMS ALL WARRANTIES, EITHER EXPRESS OR IMPLIED WITH REGARD TO THIS MANUAL AND ANY INFORMATION CONTAINED HEREIN, INCLUDING BUT NOT LIMITED TO THE IMPLIED WARRANTIES OF MERCHANTABILITY AND FITNESS FOR A PARTICULAR PURPOSE. KEYSIGHT SHALL NOT BE LIABLE FOR ERRORS OR FOR INCIDENTAL OR CONSEQUENTIAL DAMAGES IN CONNECTION WITH THE FURNISHING, USE, OR PERFORMANCE OF THIS DOCUMENT OR ANY INFORMATION CONTAINED HEREIN. SHOULD KEYSIGHT AND THE USER HAVE A SEPARATE WRITTEN AGREEMENT WITH WARRANTY TERMS COVERING THE MATERIAL IN THIS DOCUMENT THAT CONFLICT WITH THESE TERMS, THE WARRANTY TERMS IN THE SEPARATE AGREEMENT WILL CONTROL.

## Technology Licenses

The hardware and/or software described in this document are furnished under a license and may be used or copied only in accordance with the terms of such license.

## Restricted Rights Legend

If software is for use in the performance of a U.S. Government prime contract or subcontract, Software is delivered and licensed as "Commercial computer software" as defined in DFAR 252.227-7014 (June

1995), or as a "commercial item" as defined in FAR 2.101(a) or as "Restricted computer software" as defined in FAR 52.227-19 (June 1987) or any equivalent agency regulation or contract clause. Use, duplication or disclosure of Software is subject to Keysight Technologies' standard commercial license terms, and non-DOD Departments and Agencies of the U.S. Government will receive no greater than Restricted Rights as defined in FAR 52.227-19(c)(1-2) (June 1987). U.S. Government users will receive no greater than Limited Rights as defined in FAR 52.227-14 (June 1987) or DFAR 252.227-7015 (b)(2) (November 1995), as applicable in any technical data.

## Safety Notices

### CAUTION

A **CAUTION** notice denotes a hazard. It calls attention to an operating procedure, practice, or the like that, if not correctly performed or adhered to, could result in damage to the product or loss of important data. Do not proceed beyond a **CAUTION** notice until the indicated conditions are fully understood and met.

### WARNING

A **WARNING** notice denotes a hazard. It calls attention to an operating procedure, practice, or the like that, if not correctly performed or adhered to, could result in personal injury or death. Do not proceed beyond a **WARNING** notice until the indicated conditions are fully understood and met.

## Where to Find the Latest Information

Documentation is updated periodically. For the latest information about these products, including instrument software upgrades, application information, and product information, browse to one of the following URLs, according to the name of your product:

<http://www.keysight.com/find/basebandstudio>

To receive the latest updates by email, subscribe to Keysight Email Updates at the following URL:

<http://www.keysight.com/find/MyKeysight>

Information on preventing analyzer damage can be found at:

[www.keysight.com/find/PreventingInstrumentRepair](http://www.keysight.com/find/PreventingInstrumentRepair)

## Is your product software up-to-date?

Periodically, Keysight releases software updates to fix known defects and incorporate product enhancements. To search for software updates for your product, go to the Keysight Technical Support website at:

<http://www.keysight.com/find/techsupport>



Table of Contents

**1. Installation**

Safety Information . . . . . 2

    Warnings, Cautions, and Notes . . . . . 2

    Instrument Markings . . . . . 2

    General Safety Considerations . . . . . 3

Getting Started . . . . . 4

    Checking the Shipment . . . . . 4

    Meeting Electrical and Environmental Requirements . . . . . 4

    Ventilation . . . . . 5

    Line Settings . . . . . 5

    Connecting the AC Power Cord . . . . . 6

    AC Power Cord Localization . . . . . 6

    Proper Usage and Cleaning . . . . . 6

Connecting the N5102A Module to the ESG/PSG/X-Series (N5182B/72B) or N5101A PCI Card . . . . . 8

Operation Verification . . . . . 11

Regulatory Information . . . . . 13

    Statement of Compliance . . . . . 13

    Assistance . . . . . 13

    Certification . . . . . 13

    Declaration of Conformity . . . . . 13

    Compliance with German Noise Requirements . . . . . 13

    Compliance with Canadian EMC Requirements . . . . . 13

**2. Overview**

Features . . . . . 16

Front Panel . . . . . 19

    1. DC Power Receptacle . . . . . 19

    2. Power LED . . . . . 19

    3. Status LED . . . . . 19

    4. Digital Bus Connector . . . . . 20

    5. Freq Ref Connector . . . . . 20

Rear Panel . . . . . 21

    1. Ext Clock In Connector . . . . . 22

    2. Clock Out Connector . . . . . 22

    3. Device Interface Connector . . . . . 22

**3. Device Interface Connections**

Break-Out Boards . . . . . 24

    Dual 20-Pin Break-Out Board . . . . . 25

    Dual 38-Pin Break-Out Board . . . . . 27

    Dual 40 Pin Break-Out Board . . . . . 29

    Single 68-Pin SCSI Style Break-Out Board . . . . . 30

    Dual 100-Pin Break-Out Board . . . . . 31

Device Interface Connector . . . . . 33

---

## Contents

|   |    |
|---|----|
| Input and Output Clock Signals .....                      | 36 |
| Data Lines .....  | 36 |
| DC Supply .....   | 37 |
| VCCIO .....   | 37 |
| Device Interface Mating Connector .....                   | 38 |
| <b>4. Troubleshooting</b>                                 |    |
| If You Encounter a Problem .....                          | 42 |
| Checking Power Problems .....                             | 43 |
| Running Diagnostic Tests .....                            | 44 |
| Replaceable Parts .....                                   | 48 |
| Returning an N5102A Module to Keysight Technologies ..... | 49 |
| Contacting Keysight Technologies .....                    | 50 |

# 1 Installation

This chapter provides the following:

- “Safety Information” on page 2
- “Getting Started” on page 4
- “Connecting the N5102A Module to the ESG/PSG/X-Series (N5182B/72B) or N5101A PCI Card” on page 8
- “Operation Verification” on page 11
- “Regulatory Information” on page 13

## Safety Information

### Warnings, Cautions, and Notes

The following safety notations are used throughout this manual. Familiarize yourself with each notation and its meaning before operating this product.

**WARNING**      **Warning** denotes a hazard. It calls attention to a condition or situation that could result in personal injury or loss of life. Do not proceed beyond a warning until the indicated conditions or situations are fully understood.

---

**CAUTION**      **Caution** calls attention to a possible condition or situation that could result in a loss of a user's work, damage, or destruction of the product. Do not proceed beyond a caution until the indicated conditions are fully understood.

---

**NOTE**          **Note** calls the user's attention to an important point of special information within the text. It provides operational information or additional instructions of which the user should be aware.

---

### Instrument Markings

The following markings are used on the N5102A Baseband Studio digital signal interface module. Familiarize yourself with it and its meaning before operating the module.



The CE mark is a registered trademark of the European Community. If this symbol is accompanied by a year, it is the year when the design was proven.



The CSA mark is a registered trademark of the Canadian Standards Association.



The C-Tick Mark is a trademark registered to the Australian Spectrum Management Agency. This indicates compliance with all Australian EMC regulatory information.



This symbol indicates that the center conductor (of the power supply) is positive, and the outer conductor is negative.



Installation  
Safety Information

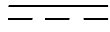

This symbol indicates that the input power required is DC.

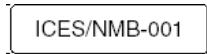

This symbol indicates compliance with the Canadian Interference-Causing Equipment Standard (ICES-001).

## General Safety Considerations

**WARNING**

Personal injury may result if the module cover is removed. There are no operator serviceable parts inside. To avoid electrical shock, refer servicing to qualified personnel.

---

## Getting Started

### Checking the Shipment

1. Inspect the shipping container for damage.

Signs of damage may include a dented or torn shipping container or cushioning material that indicates signs of unusual stress or compacting.

2. Carefully remove the contents from the shipping container and verify that your order is complete.

The following items are shipped standard with each N5102A Baseband Studio digital signal interface module:

- installation guide
- three-prong AC power cord (specific to geographic location)
- power supply
- proprietary three-meter digital bus cable
- five break-out boards (PC boards with connectors that simplify the connections between the N5102A module and the device under test)
- loop back fixture (for troubleshooting)
- Device Interface port mating connector  
See **“Rear Panel”** on page 21 for connector locations.

### Instrument Dimensions

|         |                    |
|---------|--------------------|
| Length: | 189.9 mm (7.48 in) |
| Width:  | 144.8 mm (5.70 in) |
| Height: | 41.6 mm (1.64 in)  |

### Meeting Electrical and Environmental Requirements

The N5102A module is designed for use in the following environmental conditions:

- indoor use
- altitudes < 15,000 feet (4,572 meters)
- 0 to 55°C temperatures, unless otherwise specified
- 80% relative humidity (maximum for temperatures up to 31°C, decreasing linearly to 50% relative humidity at 40°C).

**CAUTION** This product is designed for use in INSTALLATION CATEGORY II and POLLUTION DEGREE 2, per IEC 61010-1 and 664, respectively.

---

## Ventilation

Ventilation holes are located on the front and rear panels of the N5102A module. Do not allow these holes to be obstructed, as they allow air flow through the module.

When installing the module in a cabinet, the convection into and out of the module must not be restricted. The ambient temperature outside the cabinet must be less than the maximum operating temperature of the module by 4°C for every 100 watts dissipated within the cabinet.

**CAUTION** Damage to the module may result when the total power dissipated in the cabinet is greater than 800 watts. When this condition exists, forced convection must be applied.

---

## Line Settings

The **N5102A module** requires a power supply that meets the following conditions:

|                   |      |
|-------------------|------|
| <b>Voltage:</b>   | 5V   |
| <b>Frequency:</b> | DC   |
| <b>Current:</b>   | 4.0A |

The module's **power supply** requires a power source that meets the following conditions:

|                   |          |
|-------------------|----------|
| <b>Voltage:</b>   | 100-240V |
| <b>Frequency:</b> | 50-60 Hz |
| <b>Current:</b>   | 0.7A     |

**CAUTION** Damage may result if a supply voltage is not within its specified range.

---

## Connecting the AC Power Cord

This is a Safety Class 1 Product provided with a protective earth ground incorporated into the power cord. The AC power cord is the device that disconnects the mains circuits from the mains supply. In addition, an external circuit breaker, readily identifiable and easily reached by the operator, should be available for use as the disconnecting device. Use the following steps to connect the AC power cord:

**WARNING** Personal injury may occur if there is any interruption of the protective conductor inside or outside of the product. Intentional interruption is prohibited.

---

**CAUTION** Damage to the product may result without adequate earth grounding. Always use the supplied three-prong AC power cord.

---

1. Ensure that the power cord is not damaged.
2. Install the product so that one of the following items is readily identifiable and easily reached by the operator: AC power cord, alternative switch, or circuit breaker.
3. Insert the mains plug into a socket outlet provided with a protective earth grounding.

## AC Power Cord Localization

The AC power cord included with the module is appropriate for the final shipping destination. You can, however, order additional AC power cords for use in different areas: see ["Replaceable Parts" on page 48](#).

## Proper Usage and Cleaning

The N5102A module cover protects against physical contact with internal assemblies that contain hazardous voltages, but does not protect against the entrance of water. To avoid damage and personal injury, ensure that liquid substances are positioned away from your N5102A module.

**WARNING** Personal injury may result if the N5102A module is not used as specified. Unspecified use impairs the protection provided by the equipment. The N5102A module must be used with all means for protection intact.

---

Installation  
Getting Started

### Cleaning Suggestions

To prevent dust build-up that could potentially obstruct ventilation, clean the N5102A module cover periodically. Use a dry cloth, or one slightly dampened with water, to clean the external case parts.

**WARNING**

To prevent electrical shock, disconnect the N5102A module from the mains supply before cleaning. Do not attempt to clean internally.

---

## Connecting the N5102A Module to the ESG/PSG/X-Series (N5182B/72B) or N5101A PCI Card

The N5102A digital signal interface module is used with an Keysight E4438C ESG<sup>1</sup>, E8267C PSG<sup>1</sup>, E8267D PSG<sup>1</sup>, X-Series (N5182B/72B), or a PC with an installed Keysight N5101A PCI card being used with software<sup>2</sup> engineered to control the N5102A module.

This section provides information on connecting the N5102A module to a signal generator or N5101A PCI card. The illustrations in this procedure show the N5102A module being connected to an ESG signal generator, however, the connection process is the same for a PSG signal generator or a PCI card installed in a PC. For more information on the N5101A PCI card, see the **N5101A Installation Guide**.

### CAUTION

The digital bus cable connector has a release latch on each side (as shown below). To avoid connector damage, simultaneously squeeze both release latches when connecting or disconnecting the cable. A securely connected cable does not come loose when gently pulled.

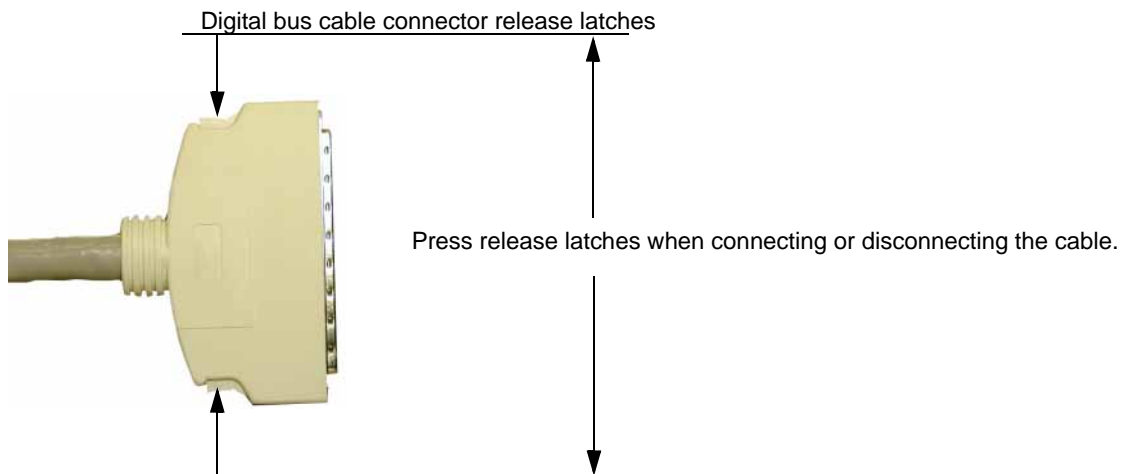

1. Refer to **Figure 1-1**. Connect the end of the digital bus cable that has the EMI suppressor to the signal generator or PCI card's digital bus connector.

1. Requires Options 003 and/or 004, and either 601(if available) or 602.

2. For example, the N5110B Baseband Studio for waveform capture and playback software is designed to control the N5102A module.

## Installation

Connecting the N5102A Module to the ESG/PSG/X-Series (N5182B/72B) or N5101A PCI Card

**NOTE** The digital bus connector may be labeled as DIGITAL BUS, DIG I/Q I/O, or DIGITAL I-Q I/O.

---

**Figure 1-1** Signal Generator Digital Bus Cable Connection

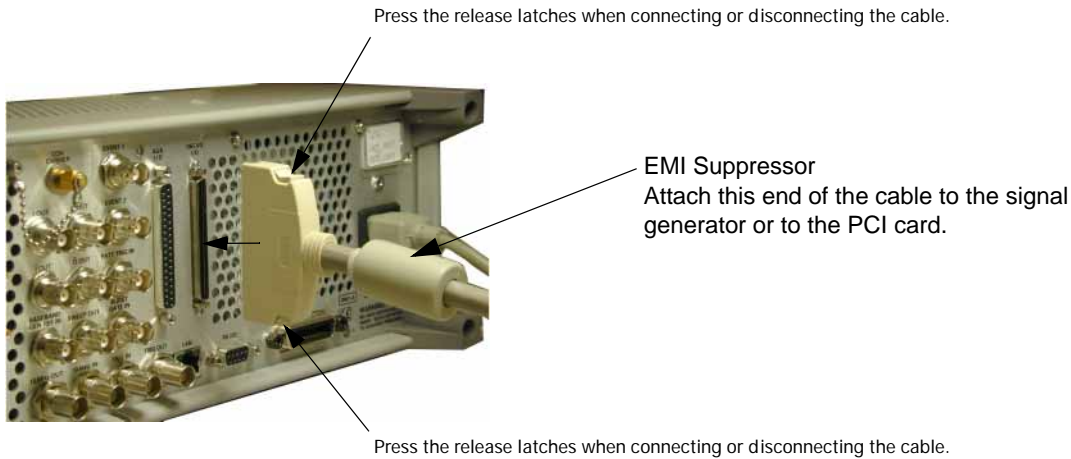

2. Refer to **Figure 1-2**. Connect the other end of the digital bus cable to the Digital Bus connector on the N5102A module.

The proprietary three meter cable enables you to place the interface module in a location close to the device under test (DUT).

**Figure 1-2** N5102A Module Digital Bus Cable Connection

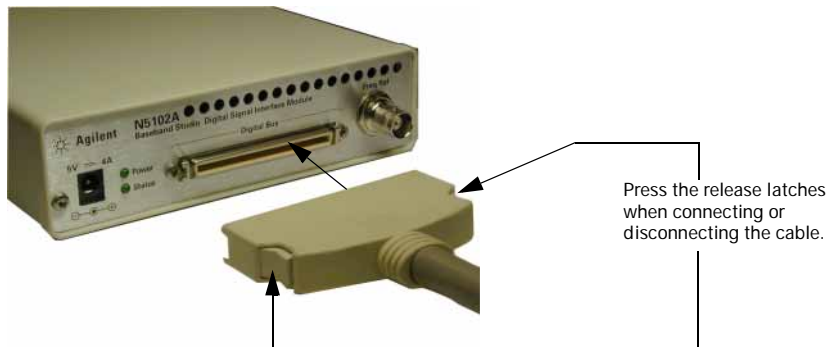

3. Refer to **Figure 1-3**. Connect the AC power cord to both the power supply and the AC power source (for details on connecting an AC power cord to an AC power source, see **"Connecting the AC Power Cord"** on page 6).
4. Connect the power supply to the N5102A module DC power receptacle.

Installation  
Connecting the N5102A Module to the ESG/PSG/X-Series (N5182B/72B) or N5101A  
PCI Card

**Figure 1-3** N5102A Module Power Supply Connections

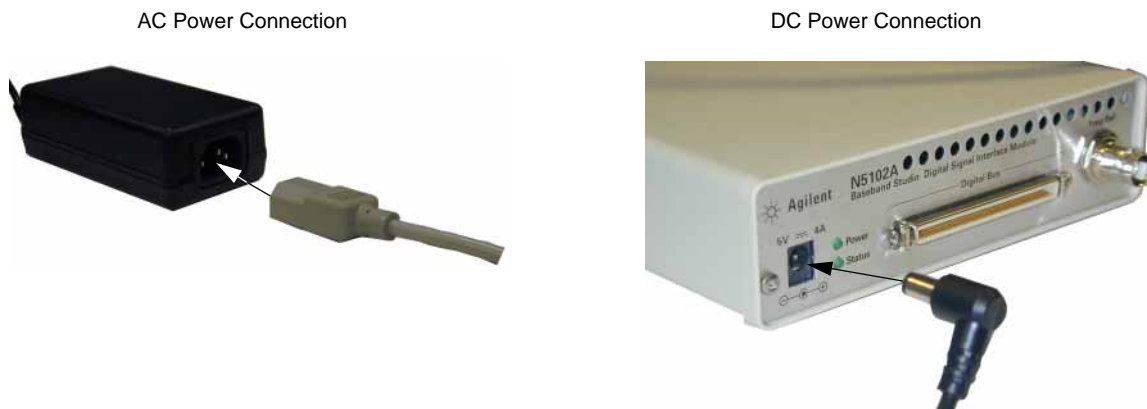

The power LED should be illuminated, indicating that the interface module is connected to the power source. If the power LED is not illuminated, check the AC power connection for the power supply and ensure that the DC power supply plug is fully inserted into the N5102A module DC power receptacle. If problems still persist after checking the power cords, refer to [Chapter 4, "Troubleshooting"](#), on page 41.

[Figure 1-4](#) shows a completed installation.

**Figure 1-4** Completed N5102A Module Installation

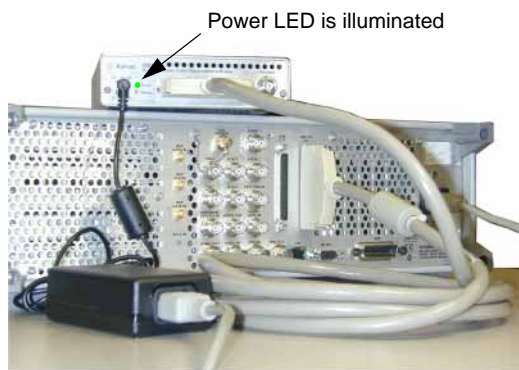

**Note:**  
This illustration shows the N5102A module connected to an ESG signal generator. Connections to a PSG signal generator or an N5101A PCI card are similar.



## Operation Verification

This section describes how to verify the operation of the N5102A module when connected to an ESG or PSG signal generator. The operation verification uses the device interface test (Device Intfc), which is one of four interface module diagnostic tests, referred to as loop back tests. This loop back test checks the complete setup, providing a high level of confidence that the system is functioning properly. The three other tests are used if this test fails, and are described in ["Running Diagnostic Tests" on page 44](#).

If your N5102A interface module is connected to an N5101A PCI card in a PC, operation verification occurs through the controlling software (for example, **N5110B Baseband Studio for waveform capture and playback**). For more information, see the software's documentation.

### CAUTION

The Device Interface connector on the interface module communicates using high speed digital data. Use ESD precautions to eliminate potential damage when making connections.

1. Connect the N5102A module to the signal generator (as described in ["Connecting the N5102A Module to the ESG/PSG/X-Series \(N5182B/72B\) or N5101A PCI Card" on page 8](#)).
2. Refer to [Figure 1-5](#). Connect the Loop Back Test Single Ended IO Dual 40 Pin board to the Device Interface connector on the rear panel of the N5102A module.

**Figure 1-5** Connecting the Loop Back Board to the N5102A Module

Loop Back Test Single Ended IO Dual 40 Pin Board

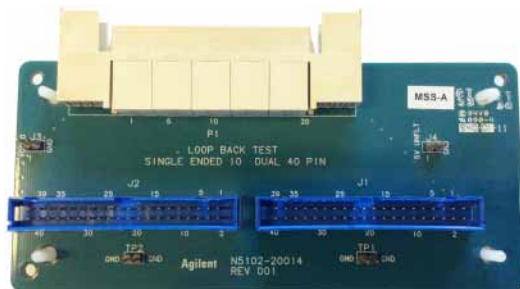

Connecting the Board to the Device Interface Connector

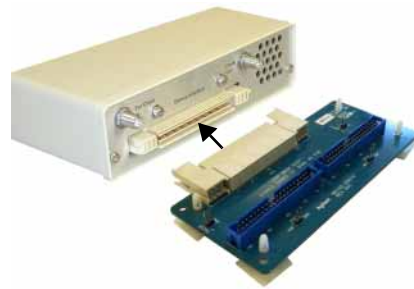

The Loop Back Test Single Ended IO Dual 40 Pin board is used both for loop back testing and as a break-out board to simplify the connection between the N5102A module and the device under test. When used for loopback testing, there should be no connections to the dual 40-pin connectors.

3. If the signal generator is not already on, turn it on.

4. On the signal generator, select the device interface test:

Press **Aux Fctn** > **N5102A Interface** > **Diagnostics** > **Loop Back Test Type** > **Device Intfc**.

As shown in **Figure 1-6**, the currently selected test is displayed in parenthesis below the **Loop Back Test Type** softkey. Note also that the graphic provided displays the current test setup.

**Figure 1-6** ESG/PSG/X-Series (N5182B/72B) Diagnostic Test Display

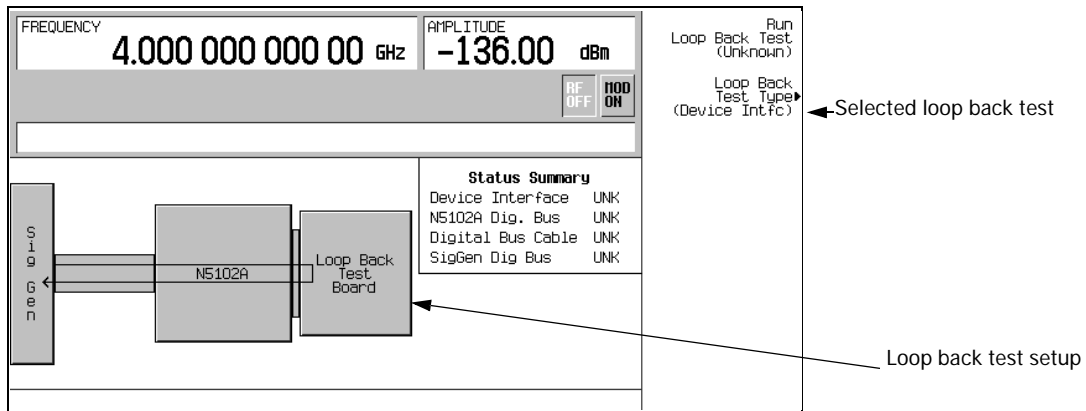

5. Run the selected test: press **Run Loop Back Test**.

When the test completes, the results of the test (pass or fail) replaces **Unknown** in both the parenthesis of the softkey and in the **Status Summary** display as shown in **Figure 1-7**. If this test fails, refer to **"Running Diagnostic Tests"** on page 44.

**Figure 1-7** ESG/PSG/X-Series (N5182B/72B) Loop Back Test Result

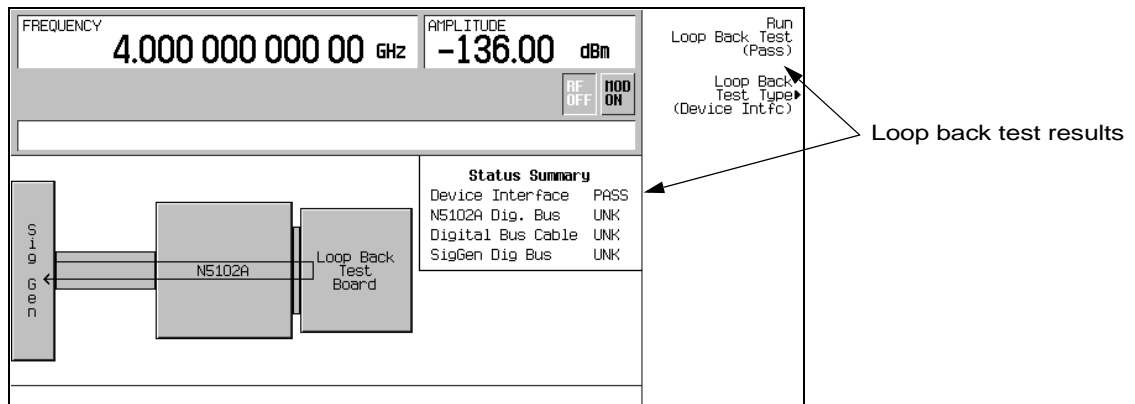

## Regulatory Information

### Statement of Compliance

This product has been designed and tested in accordance with IEC Publication 61010, **Safety Requirements for Electronic Measuring Apparatus**, and has been supplied in a safe condition. The documentation contains information and warnings that must be followed by the user to ensure safe operation and to maintain the product in a safe condition.

### Assistance

Product maintenance agreements and other customer assistance agreements are available for Keysight Technologies products. For any assistance, contact Keysight Technologies (see [page 49](#)).

### Certification

Keysight Technologies certifies that this product met its published specifications at the time of shipment from the factory.

This product does not require calibration.

### Declaration of Conformity

A declaration of conformity is on file for this product, and a copy is available upon request.

### Compliance with German Noise Requirements

This is to declare that this instrument is in conformance with the German Regulation on Noise Declaration for Machines (Laermangabe nach der Maschinenlaermrrordnung -3.GSGV Deutschland).

Table 1-1

#### German Noise Requirements

| Acoustic Noise Emission/Geraeuschemission |                     |
|---|---------------------|
| LpA < 70 dB                               | LpA < 70 dB         |
| Operator position                         | am Arbeitsplatz     |
| Normal position                           | normaler Betrieb    |
| per ISO 7779                              | nach DIN 45635 t.19 |

### Compliance with Canadian EMC Requirements

This ISM device complies with Canadian ICES-001.  
Cet appareil ISM est conforme a la norme NMB du Canada.

Installation  
Regulatory Information

## 2 Overview

This chapter describes the features of the N5118A digital signal interface module along with the options required for its operation.

- [“Features” on page 16](#)
- [“Front Panel” on page 19](#)
- [“Rear Panel” on page 21](#)

## Features

The N5118A digital signal interface module works with the Keysight E4438C ESG<sup>1</sup>, E8267C PSG<sup>1</sup>, E8267D PSG<sup>1</sup>, X-Series (N5182B/72B), or N5101A PCI card installed in a PC to provide a flexible digital interface for delivering digital baseband (IQ) or digital intermediate frequency (IF) test signals. The complex modulation formats of the signal generators, including W-CDMA, multitone, 1xEV-DV, WLAN and many more, are available at the bit level for testing digital components, transceivers, and subsystems. The N5102A module delivers the digital IQ or digital IF<sup>2</sup> signals to your device with the data requirements, clock features, and signaling you need. With its selection of logic types and break-out board connectors, the interface module connects into your test system, in most cases eliminating the need for custom fixtures.

- 
1. Requires Options 003 and/or 004, and either Option 601 or 602.
  2. Digital IF is only available for output mode.

The N5102A module provides many features:

- output mode (requires Option 003 for ESG/PSG/X-Series (N5182B/72B) or Option 195 for N5110B waveform playback)
- input mode (requires Option 004 for ESG/PSG/X-Series (N5182B/72B) or Option 194 for N5110B waveform capture)
- bit level access to arbitrary waveform generator (ARB) and real-time signal generator baseband data from a wide range of signal creation applications
- simple user interface
- flexible data formats
  - variable 4-bit to 16-bit word size
  - serial, parallel, and parallel interleaved data transmission
  - 2's complement or offset binary word representation
  - MSB or LSB bit order
  - digital IQ or digital IF signal
- flexible clocking
  - automatic resampling
  - 1 kHz to 100 MHz sample rate
  - multiple clock inputs and outputs
  - adjustable clock phase and skew
  - multiple clocks per sample 1x, 2x, and 4x (Output mode only. Input mode is limited to 1x.)
- flexible signal interface
  - multiple logic types provide single ended and differential testing capability—low voltage TTL (LVTTTL), LVDS, and CMOS 1.5 V, 1.8 V, 2.5 V, and 3.3 V
  - proprietary three meter digital bus cable connects the N5102A module to the signal generator
  - interchangeable break-out boards

When connected to an ESG, PSG, or X-Series (N5182B/72B) signal generator the parameters for the N5102A module are set using the user interface (UI) on the ESG/PSG/X-Series (N5182B/72B). This provides familiar softkey operation for both the modulation format and the interface module. Option 003 (output mode) and Option 004 (input mode) on the ESG/PSG/X-Series (N5182B/72B) enable the N5102A module user interface on the signal generators.

Overview  
Features

When connected to an N5101A PCI card, the parameters for the N5102A module are set using the UI on the controlling software (for example, N5110B Baseband Studio waveform capture and playback). This provides intuitive operation for both the waveform setup and the interface module in a single software application.

With the capability of connecting an N5102A module to a signal generator or an N5101A PCI card, you can perform multiple levels of testing. Since the baseband data that is provided to the interface module is the same data that can be modulated onto the RF carrier, this enables early-stage testing of digital components and subsystems with the N5102A module, and then testing the integrated system using the modulated RF carrier.

The N5102A digital interface module does not support the Real Time GPS format.



## Front Panel

The baseband data and frequency reference inputs for the N5102A module are located on the front panel along with the receptacle for the DC power. A Power LED indicates when DC power has been applied and a Status LED shows when the data lines are active.

Figure 2-1 Front Panel Features

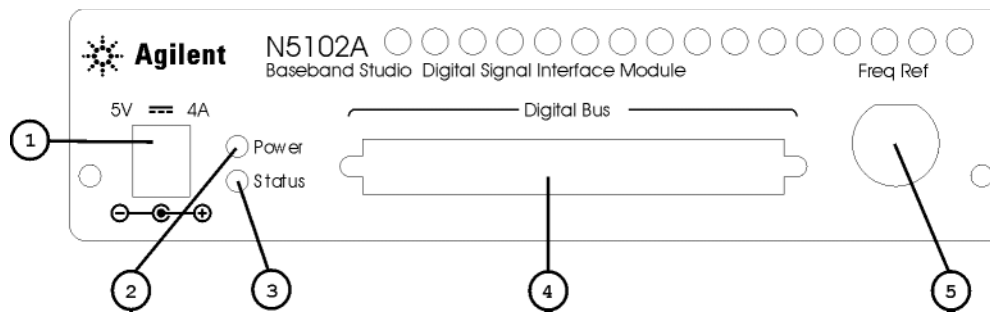

### 1. DC Power Receptacle

This receptacle accepts the DC power cord from the power supply. A DC power cord is shipped with the interface module.

### 2. Power LED

This LED illuminates when DC power is supplied to the N5102A module.

### 3. Status LED

This LED illuminates when the interface module is first turned on by an ESG, PSG, X-Series (N5182B/72B), or controlling software.

- For the ESG/PSG/X-Series (N5182B/72B), press the **N5102A Off On** softkey in the signal generator UI or after performing a module diagnostic test. Once lit, the LED stays on until the DC power is removed from the interface module.
- For controlling software, refer to the software's Help system for module control information.

The LED conveys the status of the data lines and has two modes of operation:

**Blinks Rapidly** This indicates that the data lines are active and ready to transmit or are transmitting a digital signal.

**Solid Illumination** The data lines are inactive.

## 4. Digital Bus Connector

The N5102A module uses this connector to communicate with the ESG, PSG, X-Series (N5182B/72B), or PCI card. A proprietary three-meter digital bus cable is supplied that connects to the Digital Bus connector.

## 5. Freq Ref Connector

When Internal is the selected clock source, the clock is referenced to this 50W connector. This connector accepts an external clock at 3 dBm  $\pm$ 6 dB within the frequency range of 1 MHz to 100 MHz.

### CAUTION

It is important that the interface module, the DUT, and the signal generator (if one is being used) are locked to a common frequency reference. Failure to have a common frequency reference may result in a loss of data. Also refer to the common frequency reference information in:

- E4428C/38C ESG Signal Generators User's Guide Digital Signal Interface Module chapter
  - E8257D/67D PSG Signal Generators User's Guide Peripheral Devices chapter
  - X-Series Signal Generators User's Guide
  - Help system in the software that controls the N5102A module.
-

## Rear Panel

The rear panel has three connectors that are shown in **Figure 2-2** and are described in the following sections.

Figure 2-2 Rear Panel Features

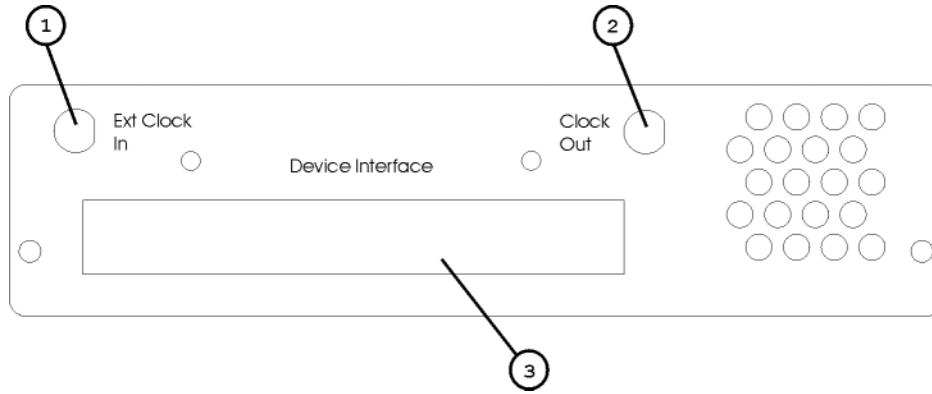

## 1. Ext Clock In Connector

This AC coupled 50W connector is used for connecting an external clock source to the N5102A module. It accepts a signal with a nominal amplitude of 0 dBm and has a frequency range of 1 MHz to 400 MHz.

### CAUTION

It is important that the interface module, the DUT, and the signal generator (if one is being used) are locked to a common frequency reference. Failure to have a common frequency reference may result in a loss of data. Also refer to the common frequency reference information in:

- E4428C/38C ESG Signal Generators User's Guide Digital Signal Interface Module chapter
  - E8257D/67D PSG Signal Generators User's Guide Peripheral Devices chapter
  - X-Series Signal Generators User's Guide
  - Help system in the software that controls the N5102A module.
- 

## 2. Clock Out Connector

This 50W connector outputs the clock signal at a nominal 400 mVp-p level with a frequency range of 100 kHz to 400 MHz. For a frequency range of 1 kHz to 100 kHz, a high impedance load of 5 kW produces a nominal 2 Vp-p clock signal.

## 3. Device Interface Connector

This connector interfaces with the device under test and supplies the digital IQ and digital IF signals in addition to sense lines, ground connections, a DC supply, and input and output clock signals. For more information on this connector, including a pin-out diagram, see "[Device Interface Connector](#)" on [page 33](#).

### CAUTION

The Device Interface connector on the interface module communicates using high speed digital data. Use ESD precautions to eliminate potential damage when making connections.

---

### 3 Device Interface Connections

This chapter provides information for the N5102A module Device Interface connector, the supplied break-out boards, and the device interface mating connector.

- [“Break-Out Boards” on page 24](#)
- [“Device Interface Connector” on page 33](#)
- [“Device Interface Mating Connector” on page 38](#)

## Break-Out Boards

This section describes the different break-out boards and provides pin-out diagrams for each one.

To maximize signal integrity, make the device connection as close as possible to the N5102A module Device Interface connector. The break-out boards are supplied to aid in minimizing this distance. An alternate solution is to incorporate the device interface mating connector onto the device under test (DUT). This eliminates the need for the break-out board and connecting cables.

Five interchangeable break-out boards are supplied with the N5102A module, each with a different type of connector, providing a wide range of connection possibilities. The break-out boards connect to the Device Interface connector on the rear panel of the module. The different boards are easily identified by their connector. If the situation arises where none of the break-out boards mate with the device being tested, make a customized connection solution using the device interface mating connector. See [“Device Interface Connector” on page 33](#) and [“Device Interface Mating Connector” on page 38](#) for information. [Table 3-1](#) lists the five break-out boards and the test type for which each is intended.

Table 3-1 Break-Out Board List

| Break-Out Board                            | Test Type    | Comment   |
|--|--------------|---|
| Single Ended I/O Dual 20 Pin               | Single-ended | 0.1 inch spaced header<br>This connector is commonly used for Keysight logic analyzer probe connections.  |
| Differential I/O Dual 38 Pin               | Differential | This connector is commonly used for Keysight logic analyzer probe connections.  |
| Loop Back Test Single Ended IO Dual 40 Pin | Single-ended | 0.1 inch spaced header<br>This board serves a dual purpose:<br>– as a break-out board for DUT connectivity<br>– used for N5102A module diagnostic testing |
| Single Ended I/O 68 Pin                    | Single-ended | Single SCSI-style connector   |
| Differential I/O Dual 100 Pin              | Differential | This connector is commonly used for Keysight logic analyzer probe connections.  |

The mating connectors for the break-out boards are readily available from suppliers external to Keysight Technologies and are listed in [Table 3-2](#) along with the connectors already mounted on the boards.

Table 3-2 Connector Part Numbers and Manufacturers

| Connector Type        | Break-out Board Output Connector Manufacturer Part Number | Mating Connector Manufacturer Part Number | Manufacturer     |
|-----------------------|---|---|------------------|
| 20-Pin                | 2520-6002UB   | 3421-6700 (wire connector)                | 3M               |
| 38-Pin Mictor         | 2-767004-2  | 767006-1 (board connector)                | Tyco Electronics |
| 40-Pin                | 2540-6002UB   | 3417-6700 (wire connector)                | 3M               |
| 68-Pin D-Subminiature | 787170-7  | 749621-7 (wire connector)                 | Tyco Electronics |
| 100-Pin Samtec        | ASP-65067-01  | ASP-65267-02 (wire connector)             | Samtec           |

Table 3-3 Clock, Marker, and Trigger Zero-ohm Resistor Installation

| Board Type        | Data Clock  | Marker 1 and Trigger         | Marker 2    |
|-------------------|---|------------------------------|-------------|
| 63003 Dual 40 Pin | No zero-ohm resistors are required                |                              |             |
| 63004 Dual 20 Pin | J2-2 <-> C2                                       | J1-2 <-> C12                 | J2-1 <-> D2 |
| 63005 Mictor      | J2-1 <-> C2 (pos. clock) J2-2 <-> C1 (neg. clock) | J1-1 <-> C12<br>J1-2 <-> C11 | N/A         |
| 63006 Samtec      | No zero-ohm resistors are required                |                              |             |
| 63007 SCSI        | J1-66 <-> C2                                      | Not available                |             |

### Dual 20-Pin Break-Out Board

Use this break-out board when single-ended testing is required and there are minimal connection points. It is most suitable at lower sample rates using easily constructed ribbon cables. **Figure 3-1** shows this board along with the pin-out diagram for the connectors. The 20-pin connectors are a common 0.1 inch spaced header. Notice that the parallel I and Q signals are separated by connectors; J1 provides the Q signals and J2 provides the I signals. The serial signals are also provided on the J2 connector.

To enable the use of clock, trigger, marker 1, or marker 2 signals with this break-out board, zero-ohm resistors must be installed between the contacts for the desired signals, as shown in **Figure 3-1**. Refer to **Table 3-3 on page 25** for a list of required connections.

The VCCIO (selected high logic level voltage) is obtained at J3, while the + 5 volt unfiltered DC supply is acquired at J4.

Device Interface Connections  
Break-Out Boards

Figure 3-1 Dual 20-Pin 0.1 Spaced Connector

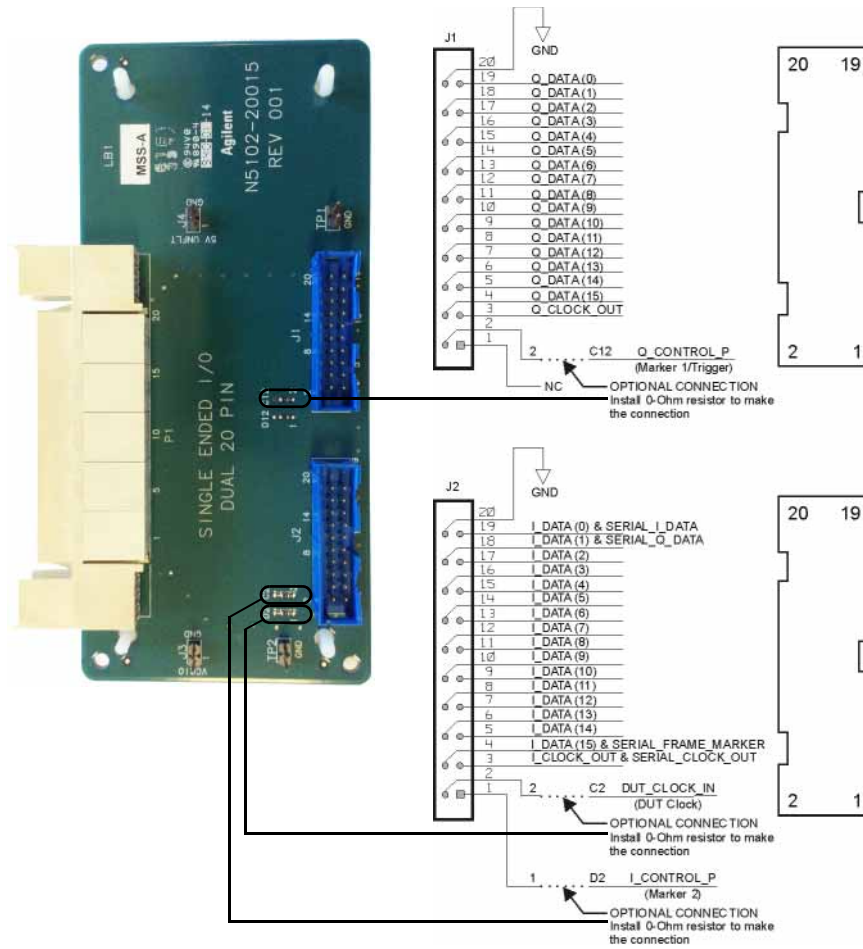



## Dual 38-Pin Break-Out Board

This board is intended for differential testing, however it can also be used for single-ended signals. For single-ended signals, the data is transmitted on the positive lines. **Figure 3-2** shows this break-out board along with the pin-out diagram for the connectors. Notice that the parallel I and Q signals are separated by connectors; J1 provides the Q signals and J2 provides the I signals. The serial signals are also provided on the J2 connector.

To enable the use of clock (positive or negative), trigger, marker 1, or marker 2 signals with this break-out board, zero-ohm resistors must be installed between the contacts for the desired signals, as shown in **Figure 3-2**. Refer to **Table 3-3 on page 25** for a list of required connections.

The VCCIO (selected high logic level voltage) is obtained at J4, while the + 5 volt unfiltered DC supply is acquired at J3.

Device Interface Connections  
Break-Out Boards

Figure 3-2 Dual 38-Pin Mictor Connector

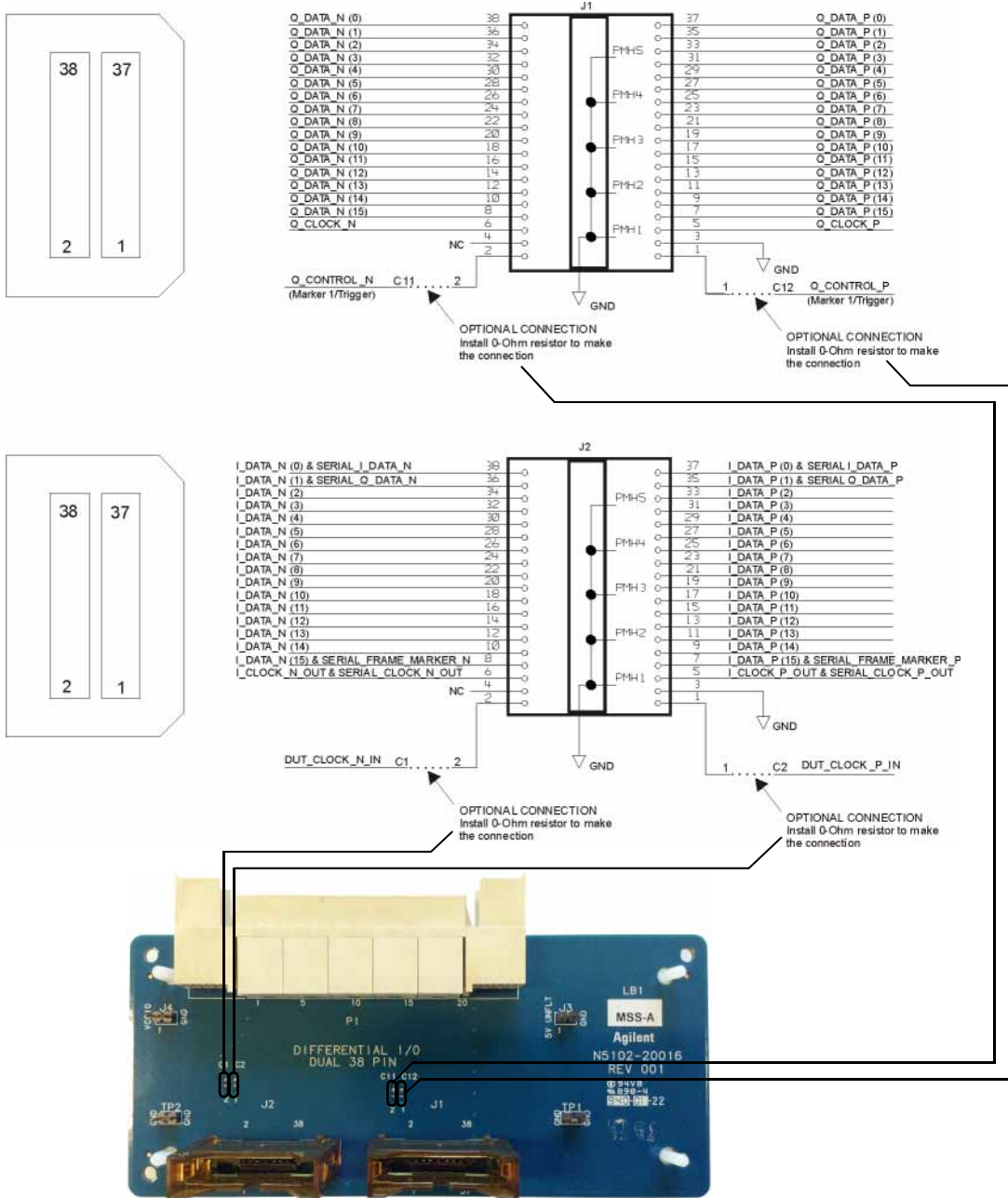

## Dual 40 Pin Break-Out Board

This break-out board is useful for higher rate single-ended signals that benefit from a ground associated with each signal line. The 40-pin connectors are a common 0.1 inch spaced header. **Figure 3-3** shows this break-out board along with the pin-out diagram for the connectors. Notice that the parallel I and Q signals are separated by connectors; J1 provides the Q signals and J2 provides the I signals. The serial signals are also provided on the J2 connector.

This board serves a dual function, one as a break-out board simplifying the connectivity of the device under test and the other as a loop back test board when performing N5102A module diagnostic tests.

The VCCIO (selected high logic level voltage) is obtained at J3, while the + 5 volt unfiltered DC supply is acquired at J4.

Figure 3-3

Dual 40 Pin 0.1 Spaced Header Connectors

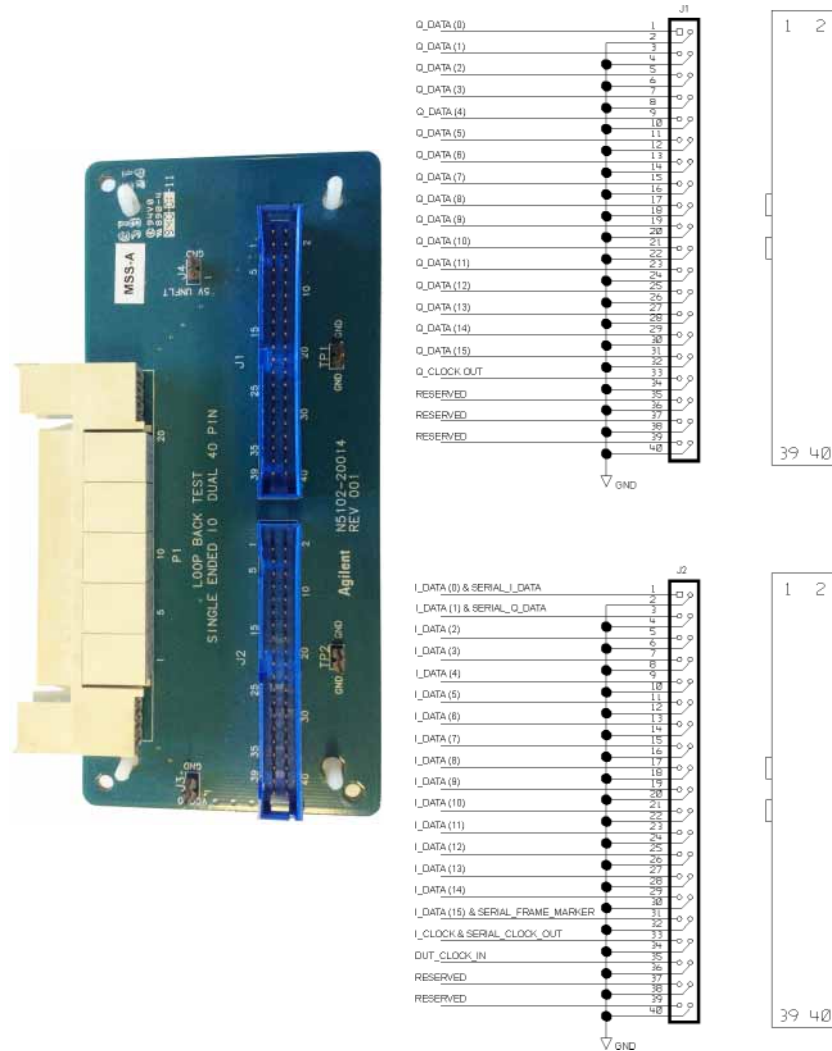

### Single 68-Pin SCSI Style Break-Out Board

This break-out board is intended for single-ended testing. The connector is a SCSI style interface that is compatible with some existing products that provide a digital data output. The serial signals are transmitted on the I data lines. **Figure 3-4** shows this break-out board along with the pin-out diagram for the output connector.

For the N5102A module to receive a clock through the Device Interface connector by way of this break-out board, a zero-ohm resistor must be installed between the 66 to C2 contacts. This is shown in **Figure 3-4**.

The VCCIO (selected high logic level voltage) is obtained at J3, while the + 5 volt unfiltered DC supply is acquired at J4.

Figure 3-4 Single 68-Pin D-Subminiature SCSI Style Connector

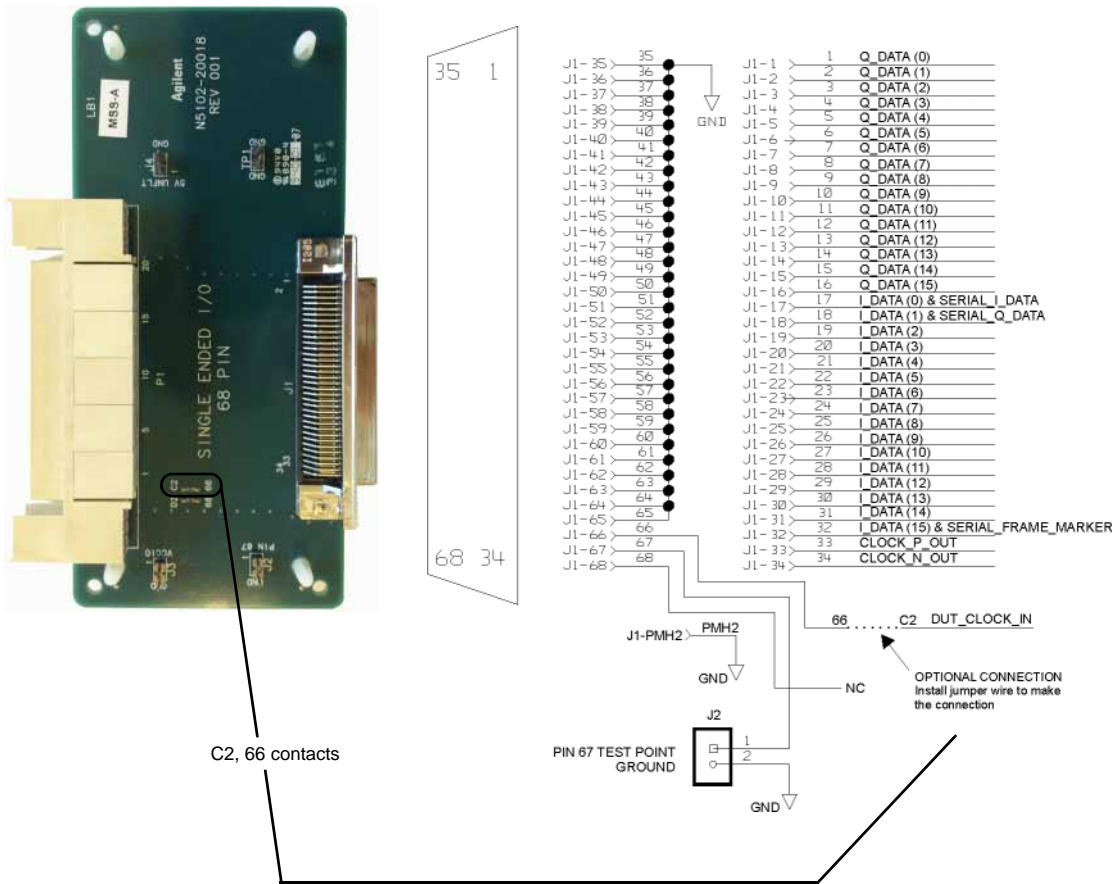

## Dual 100-Pin Break-Out Board

This break-out board is intended for differential testing, however it can also be used for single-ended signals. For single-ended signals, the data is transmitted on the positive lines. **Figure 3-5** shows this break-out board along with the pin-out diagram for the connectors. Notice that the parallel I and Q signals are separated by connectors; J1 provides the Q signals and J2 provides the I signals. Serial signals are also provided on the J2 connector.

The VCCIO (selected high logic level voltage) is obtained at J4, while the + 5 volt unfiltered DC supply is acquired at J3.

Device Interface Connections  
Break-Out Boards

Figure 3-5

Dual 100-Pin Samtec Connector

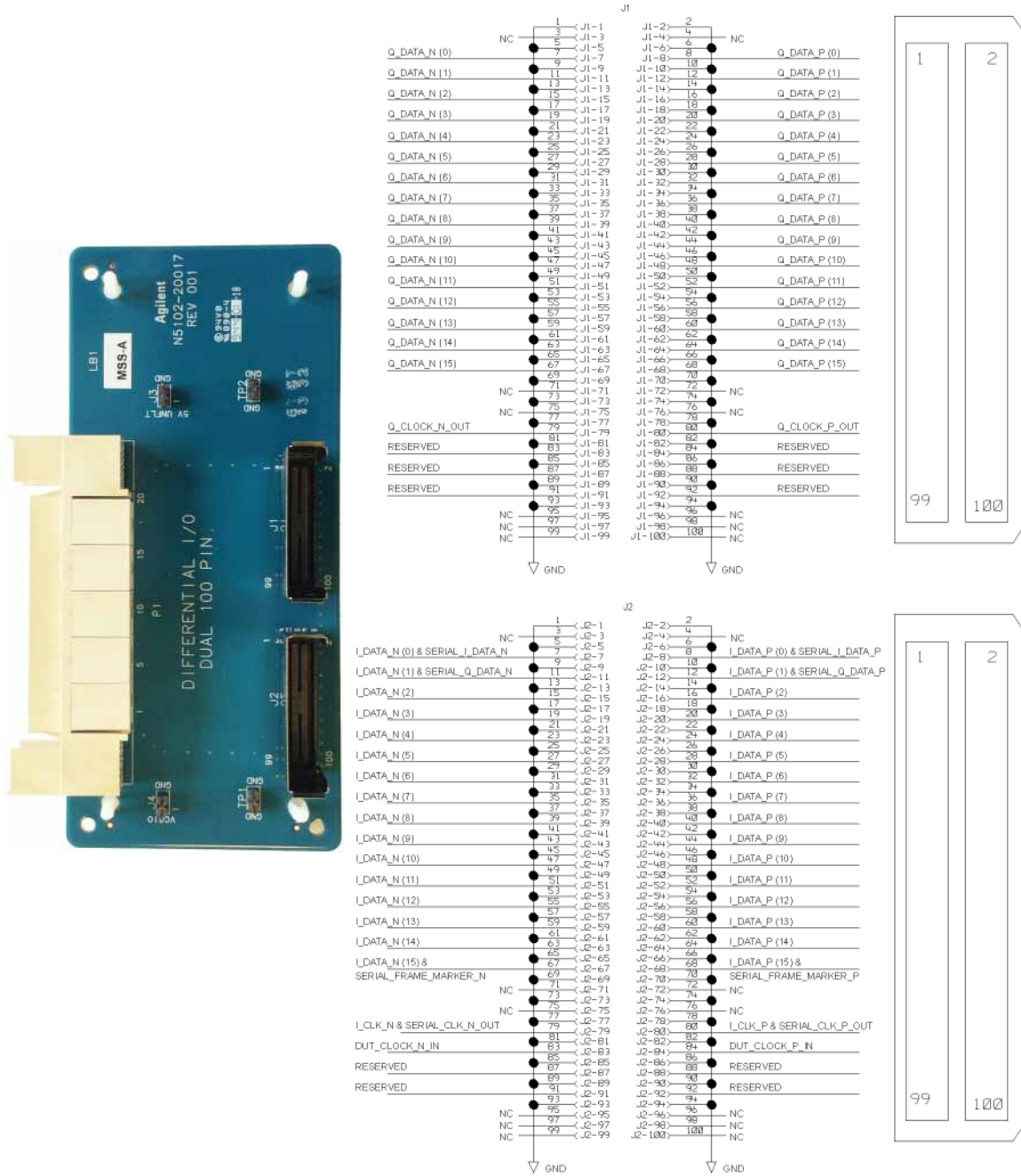

## Device Interface Connector

The figures and information shown in this section will assist when customizing a connection solution for the device under test using the device interface mating connector (see **“Device Interface Mating Connector”** on page 38). The signal contact layout for the Device Interface connector is shown in **Figure 3-6** and the connector pin-out is shown in **Figure 3-7** and **Figure 3-8**.

Figure 3-6 Device Interface Connector Layout

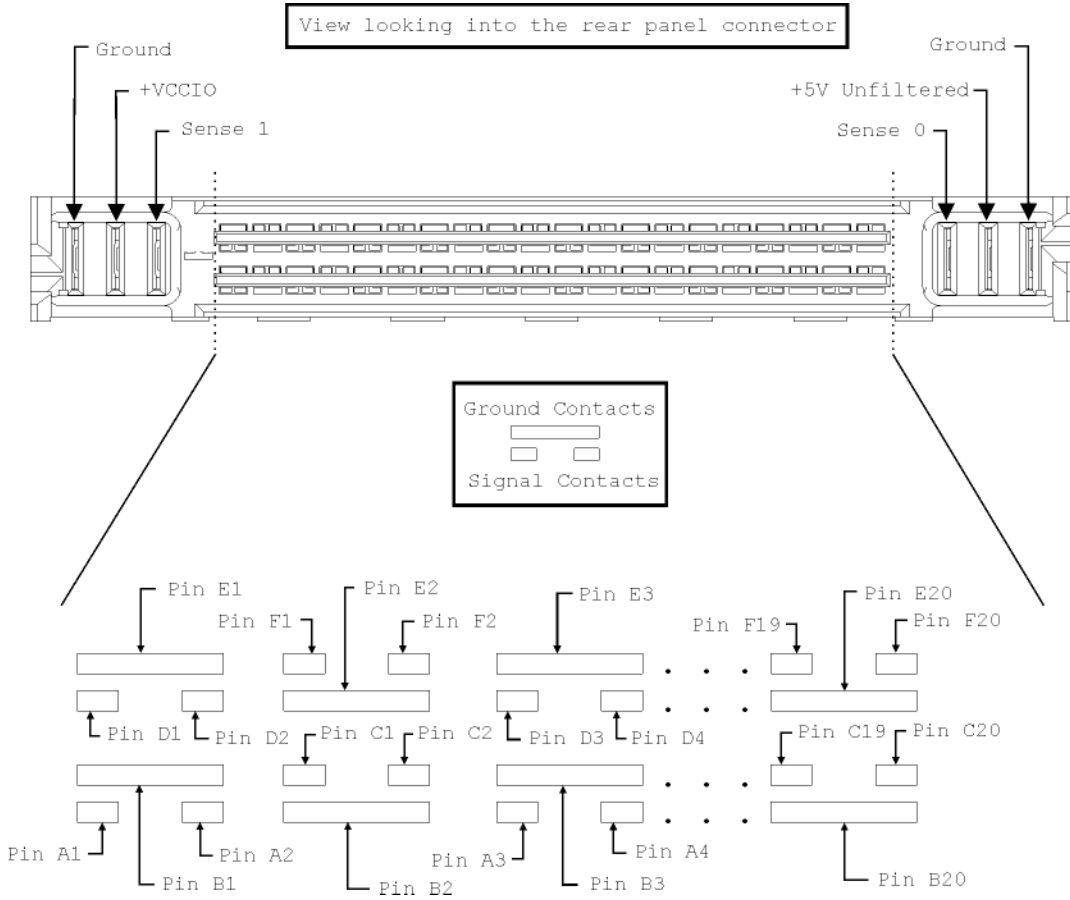

Device Interface Connections  
 Device Interface Connector

Figure 3-7

Device Interface Connector Pin-Out

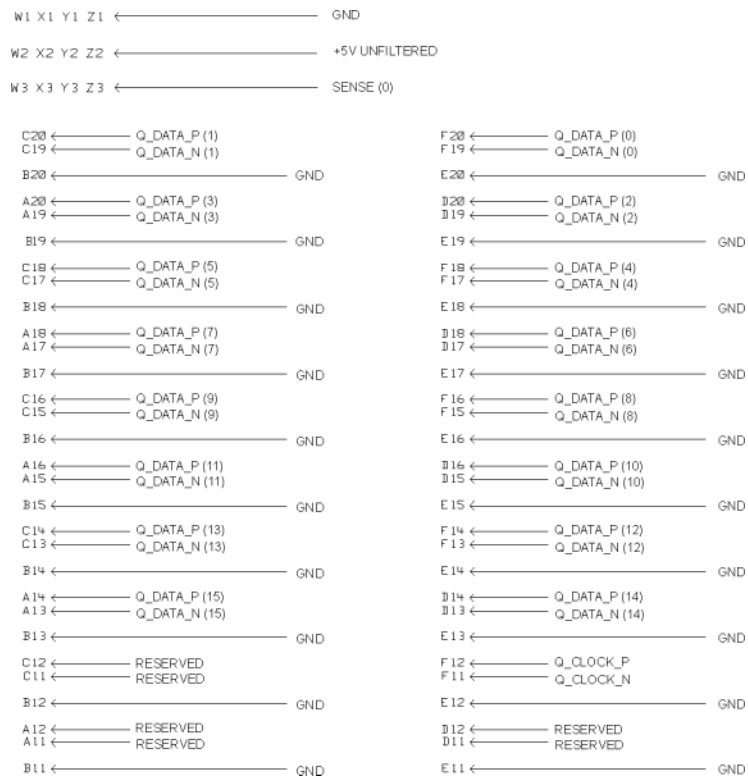



Device Interface Connections  
 Device Interface Connector

Figure 3-8

Device Interface Connector Pin-Out (continued)



## Input and Output Clock Signals

There are multiple output clock lines and two input clock lines to handle differential clocking. The N5102A module can be configured to accept the device under test clock through the Device Interface connector for data clocking. Using the input clock signal from the Device Interface connector is an alternative to using a clock signal applied to the Clock In connector. **Table 3-4** lists the Device Interface connector pins for the different clock signals and the serial frame marker.

**Table 3-4 Clock Signal and Serial Frame Marker Lines**

| Clock Signal Type                  | Pin | Clock Signal Type                  | Pin |
|------------------------------------|-----|------------------------------------|-----|
| Output Q-Clock Neg                 | F11 | Output Q-Clock Pos                 | F12 |
| Output I-Clock Neg                 | F1  | Output I-Clock Pos                 | F2  |
| Output Serial Clock Neg            | F1  | Output Serial Clock Pos            | F2  |
| Output Serial Frame Marker Pos     | A3  | Output Serial Frame Marker Neg     | A4  |
| Input Clock Signal (DUT Clock) Neg | C1  | Input Clock Signal (DUT Clock) Pos | C2  |

## Data Lines

There are 64 data lines on the Device Interface connector that allow for either differential or single-ended signals. These 64 data lines consist of 32-I lines (16 positive and 16 negative), and 32-Q lines (16 positive and 16 negative). Single-ended signals are routed on the positive data lines. **Table 3-5** shows which data lines are used for a given signal.

**Table 3-5 Data Lines**

| Signal       | Serial Data                           |                                       | Parallel Data <sup>1</sup>   |  |
|--------------|---------------------------------------|---------------------------------------|--|--|
|              | I                                     | Q                                     | I  | Q  |
| Differential | Positive and negative lines: F9 & F10 | Positive and negative lines: C9 & C10 | Positive and negative lines 0–16 (A3–A10, C3–C10 D3–D10, F3–F10)                         | Positive and negative lines 0–16 (A13–A20, C13–C20, D13–D20, F13–F20)                                |
| Single-Ended | F10                                   | C10                                   | Positive lines 0–16 (A4, A6, A8, A10, C4, C6, C8, C10, D4, D6, D8, D10, F4, F6, F8, F10) | Positive lines 0–16 (A14, A16, A18, A20, C14, C16, C18, C20, D14, D16, D18, D20, F14, F16, F18, F20) |

1. Parallel interleaving (IQ and QI) occurs on the I data lines.

## DC Supply

Referring to **Figure 3-6**, notice that the interface module provides an unfiltered +5 volts DC supply through the Device Interface connector. This DC supply provides up to 100 mA and has a self-resettable fuse. Use this DC current to bias components on the device under test where the noise will not compromise test results.

## VCCIO

The Device Interface connector also provides a connection for the VCCIO that can be measured at a test point on each break-out board. The VCCIO amplitude is equal to the high voltage level of the selected logic type.

## Device Interface Mating Connector

A mating connector for the Device Interface port is supplied to make the device under test connection easier when none of the break-out boards offer a connection solution for the device.

There are two ways to use the mating connector. One is to attach wires directly to the pins providing a quick connection solution. The other is to make a PC board with a footprint that matches the connector mounting pins. **Figure 3-9** shows the layout of the signal contacts while looking directly into the connector and the pin footprint while viewing the connector from the bottom. **Figure 3-10** shows the connector footprint for a PC board.

The signal pin-out for the connector can be obtained from **Figure 3-7 on page 34** and **Figure 3-8 on page 35**. These figures display the pin-out diagrams for the N5102A module Device Interface connector.

**Table 3-6** provides the manufacturer and the part numbers for the Device Interface connector and its mate. Both connectors are available from suppliers external to Keysight Technologies.

Table 3-6

Device Interface Connector Manufacturer and Part Numbers

| Connector Type | Connector Manufacturer Part Number | Mating Connector Manufacturer Part Number | Manufacturer     |
|----------------|------------------------------------|---|------------------|
| 144-Pin Z-Dok+ | 1367550-5                          | 1367555-2 (board connector)               | Tyco Electronics |

Figure 3-9 Z-Dok+ Device Interface Mating Connector Layout and Footprint

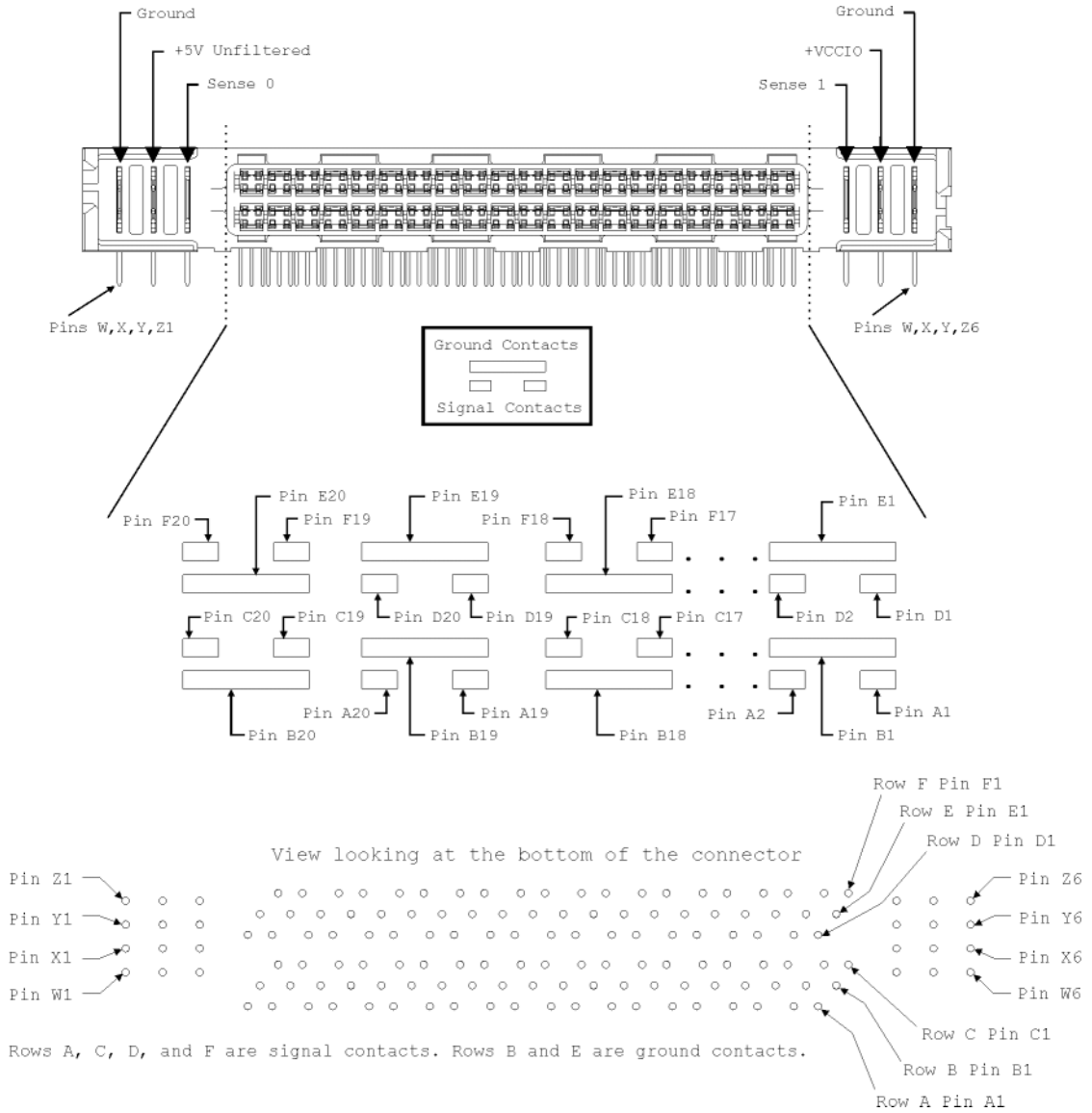

Device Interface Connections  
 Device Interface Mating Connector

Figure 3-10

Z-Dok+ Device Interface Mating Connector PC Board Foot Print

Component Side Shown

It is recommended that you check the Tyco Electronics web site for the most current PC board footprint drawing.

Rows A, C, D, and F are signal contacts. Rows B and E are ground contacts.

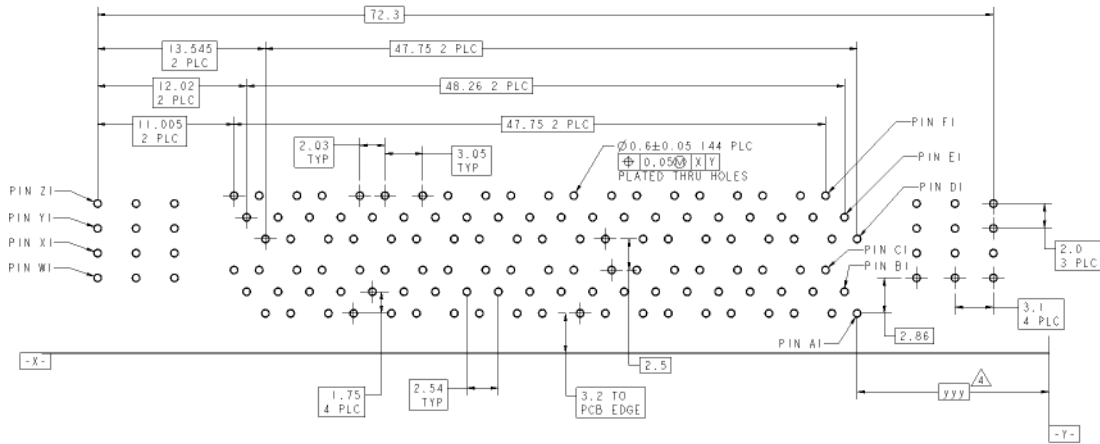

Δ DIMENSIONS PER CUSTOMER BOARD LAYOUT.

## 4 Troubleshooting

This chapter provides the following information to assist you in troubleshooting the N5102A Baseband Studio digital signal interface module:

- [“If You Encounter a Problem” on page 42](#)
- [“Replaceable Parts” on page 48](#)
- [“Returning an N5102A Module to Keysight Technologies” on page 49](#)

## If You Encounter a Problem

### CAUTION

Immediately unplug the N5102A module from the AC power line if the unit shows any of the following symptoms:

- Smoke, arcing, or unusual noise from inside the unit.
- A circuit breaker or fuse on the main AC power line opens.

These potentially serious faults must be corrected before proceeding.

---

When connected to the ESG/PSG/X-Series (N5182B/72B) and the signal generator displays an error, read the error message text by pressing **Utility > Error Info**. Resolve any problems specific to the signal generator (refer to the signal generator's documentation).

When connected to a PCI card, read the controlling software's error message and resolve any problems identified in the message. Refer to the software's online help for more information.

If the N5102A module is not operating properly, refer to the following table to begin troubleshooting.

| Symptom   | Action  |
|---|---|
| Power LED is off  | Go to <b>"Checking Power Problems"</b> on page 43   |
| Fails <b>"Operation Verification"</b> on page 11  | Go to <b>"Running Diagnostic Tests"</b> on page 44  |
| ESG/PSG/X-Series (N5182B/72B) or controlling software has a persistent N5102A module error.<br><br>A module error persists even after you fix the problem described in the ESG/PSG/X-Series (N5182B/72B) error message and clear the error queue:<br><b>Utility &gt; Error Info &gt; Clear Error Queue(s)</b> | Reset the module (disconnect the power supply from the digital module and then reconnect it). |

### NOTE

If new firmware is downloaded to the ESG/PSG/X-Series (N5182B/72B) while the digital module is connected, you must power cycle the digital module to restore normal operation. Disconnect the power supply from the digital module and then reconnect it. This will preset the digital module.

---



## Checking Power Problems

When you connect the power supply to the module, the green Power LED should light.



If the Power LED does not light:

1. Check the power cord; ensure that it is:

- in good condition
- properly plugged in to a live outlet (line power connection is described on [page 6](#))
- properly connected to the power supply (power supply connection is described on [page 9](#)) and the DC power supply plug is fully inserted into the N5102A module DC power receptacle

If this does not solve the problem, go to step 2 to check the power supply.

2. Using a DVM, check the power supply output.

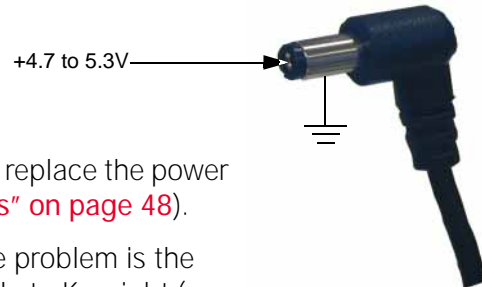

If the output voltage is not correct, replace the power supply (refer to ["Replaceable Parts" on page 48](#)).

If the output voltage is correct, the problem is the N5102A module. Return the module to Keysight (see [page 49](#)).

## Running Diagnostic Tests

Diagnostic tests, referred to as loop back tests, are provided to help isolate problems when connected to the ESG/PSG/X-Series (N5182B/72B). Perform the tests, in the order listed, in the following flow chart. When connected to a PCI card, use the controlling software's self tests wizard to diagnose the problem.

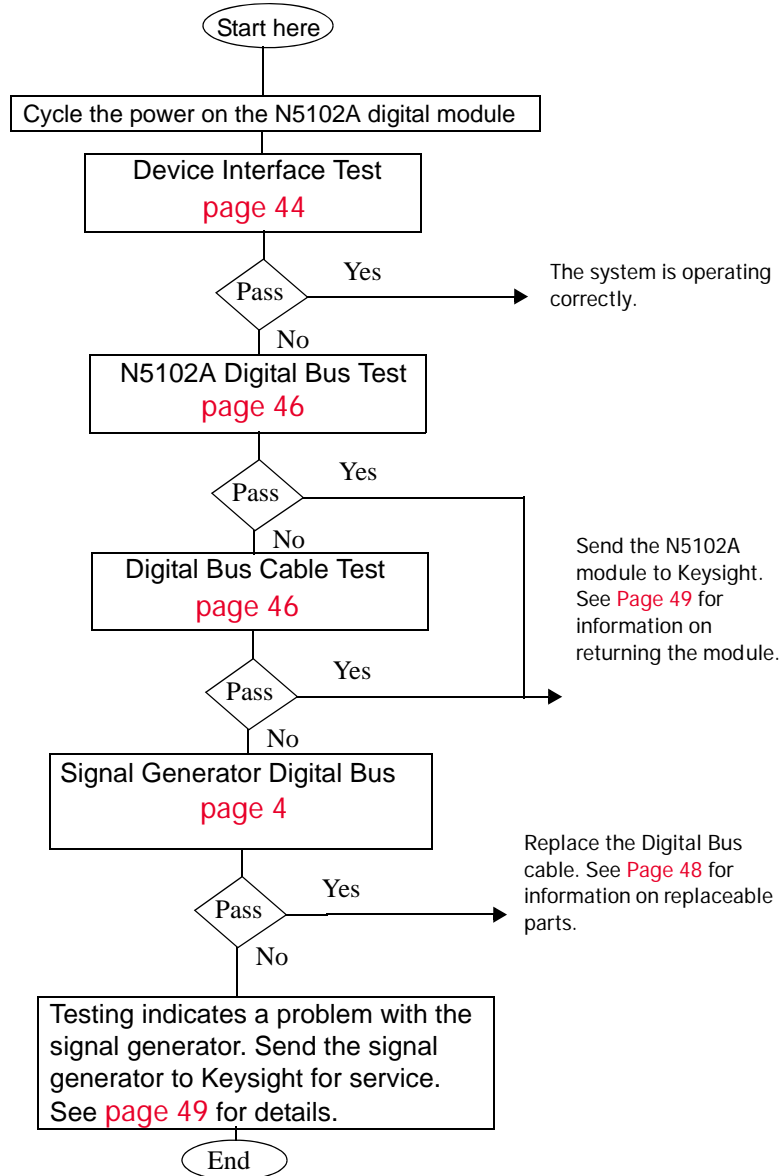

### Device Interface (System) Test

This is a comprehensive test that checks the paths from the signal generator Digital Bus connector to the Device Interface connector on the N5102A module. This is the same test used in the section, "**Operation Verification**" on [page 11](#), which describes the test in more detail.

Troubleshooting  
If You Encounter a Problem

1. Connect the N5102A module to the signal generator according to the steps in **“Connecting the N5102A Module to the ESG/PSG/X-Series (N5182B/72B) or N5101A PCI Card”** on page 8.

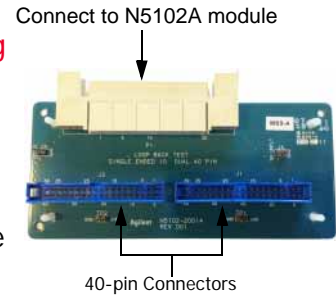

2. Connect the Loop Back Test Single Ended IO Dual 40 Pin board, shown at right, to the Device Interface connector on the rear of the N5102A module.

Ensure that there are no connections to the two 40-pin connectors.

3. Select and run the Device Interface test:
  - a. On the signal generator, press **Aux Fctn > N5102A Interface > Diagnostics > Loop Back Test Type > Device Intfc.**

Note that the test selection in parentheses below the **Loop Back Test Type** softkey updates to reflect the current test.

- b. Press **Run Loop Back Test**.

Because all signal generator modulation formats and the N5102A module interface must be off before a loop back test can run, if they are active when you press the **Run Loop Back Test** softkey, they turn off automatically.

Results:

|      |  |
|------|--|
| Pass | The system is operating correctly.   |
| Fail | Examine all connectors (they should be clean and undamaged) and connections (they must be secure). If the test still fails, perform the N5102A Digital Bus test to help isolate the problem. |

## N5102A Digital Bus Test

This test checks the communication path from the Digital Bus connector on the signal generator to the input of the N5102A module. It does not require the use of a loop back test board.

1. If not already done, disconnect the Loop Back Test Single Ended IO Dual 40 Pin board from the N5102A module.

Leave all other connections.

2. Select and run the N5102A Digital Bus test:

On the signal generator, press **Loop Back Test Type > N5102A Dig Bus > Run Loop Back Test.**

Results:

|      |  |
|------|--|
| Pass | The N5102A module has a problem, send the module to Keysight for service (see <a href="#">page 49</a> ). |
| Fail | Perform the Digital Bus Cable test to further isolate the problem.                                       |

## Digital Bus Cable Test

This test checks the communication path from the Digital Bus connector on the signal generator to the end of the digital bus cable. It requires the use of the digital bus loop back fixture.

1. Disconnect the digital bus cable from the N5102A module.

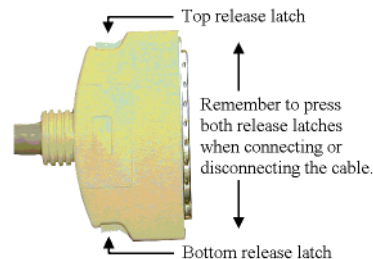

2. Check the connectors on the digital bus loop back fixture, shown at right, to ensure that they are clean and undamaged, then connect it securely to the digital bus cable in place of the module.

Connect to the digital bus cable



3. Select and run the Digital Bus Cable test:

On the signal generator, press **Loop Back Test Type > Dig Bus Cable > Run Loop Back Test.**

Results:

- |      |  |
|------|--|
| Pass | The N5102A module has a problem, send the module to Keysight for service (see <a href="#">page 49</a> ). |
| Fail | Perform the Signal Generator Digital Bus test to further isolate the problem.                            |

### Signal Generator Digital Bus Test

This test checks the digital output capability of the signal generator and requires the use of the loop back fixture, shown at right.

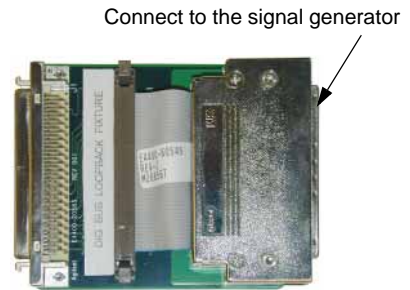

1. Disconnect the digital bus loop back fixture from the digital bus cable.
2. Disconnect the digital bus cable from the signal generator, and connect the digital bus loop back fixture securely in its place.
3. Select and run the Signal Generator Digital Bus test

On the signal generator, press **Loop Back Test Type > SigGen Dig Bus > Run Loop Back Test**.

Results:

- |      |   |
|------|---|
| Pass | The problem is with the digital bus cable; replace the cable (see <a href="#">"Replaceable Parts" on page 48</a> ).         |
| Fail | The problem is with the signal generator; send the signal generator to Keysight for service (see <a href="#">page 49</a> ). |

## Replaceable Parts

Contact Keysight (see [Table 4-1](#)) for price and availability of the following parts.

| Description                                      | Part Number | Description                    | Part Number |
|--|-------------|--------------------------------|-------------|
| Digital Bus Cable                                | N5102-60019 | Power Cord                     |             |
| Digital Bus Loop Back Fixture                    | E4400-63768 | United Kingdom                 | 8120-8709   |
| Loop Back Test Single Ended IO Dual 40 Pin Board | N5102-63014 | Australia and New Zealand      | 8120-0696   |
| Single Ended I/O Dual 20 Pin Board               | N5102-63015 | Continental Europe             | 8120-1692   |
| Differential I/O 38 Pin Board                    | N5102-63016 | United States and Canada, 120V | 8120-1521   |
| Differential I/O Dual 100 Pin Board              | N5102-63017 | Switzerland                    | 8120-2296   |
| Single Ended I/O 68 Pin Board                    | N5102-63018 | Denmark                        | 8120-2957   |
| N5102A Installation Guide                        | N5102-90003 | South Africa and India         | 8120-4600   |
| Power Supply, AC-DC 5V 4A                        | 0950-4540   | Japan                          | 8120-4754   |
|  |             | Israel                         | 8120-5181   |
|  |             | Argentina                      | 8120-6868   |
|  |             | Chile                          | 8120-6979   |
|  |             | China                          | 8120-8377   |
|  |             | Brazil and Thailand            | 8120-8671   |

## Returning an N5102A Module to Keysight Technologies

To return your N5102A digital signal interface module to Keysight Technologies for servicing, follow these steps:

1. Gather as much information as possible regarding the module's problem.
2. Call the phone number listed on the Internet (<http://www.keysight.com/find/assist>) that is specific to your geographic location. If you do not have access to the Internet, contact your Keysight field engineer. See also "[Contacting Keysight Technologies](#)" on page 50.

After sharing information regarding the module and its condition, you will receive information regarding where to ship your module for repair.

3. Ship the module in the original factory packaging materials, if available, or use similar packaging to properly protect the module.

## Contacting Keysight Technologies

There is support on the world-wide web. The address is:

**<http://www.keysight.com/find/support>**

FAQs, instrument software updates, documentation, and other support information can be accessed from this site.

To obtain servicing information or to order replacement parts, contact the nearest Keysight office listed in **Table 4-1**. In any correspondence or telephone conversations, refer to the instrument by its model number (N9030A) and full serial number (ex. MY49250887). With this information, the Keysight representative can quickly determine whether your unit is still within its warranty period.

By internet, phone, or fax, get assistance with all your test and measurement needs.



Table 4-1

## Contacting Keysight

Online assistance: [www.keysight.com/find/contactus](http://www.keysight.com/find/contactus)

### Americas

| Country       | Phone Number     |
|---------------|------------------|
| Canada        | (877) 894 4414   |
| Brazil        | 55 11 3351 7010  |
| Mexico        | 001 800 254 2440 |
| United States | 1 800 829-4444   |

### Asia Pacific

| Country            | Phone Number   |
|--------------------|----------------|
| Australia          | 1 800 629 485  |
| China              | 800 810 0189   |
| Hong Kong          | 800 938 693    |
| India              | 1 800 112 929  |
| Japan              | 0120 (421) 345 |
| Korea              | 080 769 0800   |
| Malaysia           | 1 800 888 848  |
| Singapore          | 1 800 375 8100 |
| Taiwan             | 0800 047 866   |
| Other AP Countries | (65) 6375 8100 |

### Europe and Middle

| Country | Phone Number |
|---------|--------------|
| Austria | 0800 001122  |
| Belgium | 0800 58580   |
| Finland | 0800 523252  |
| France  | 0805 980333  |
| Germany | 0800 6270999 |
| Ireland | 1800 832700  |
| Israel  | 1 809 343051 |
| Italy   | 800 599100   |

**Europe and Middle**

| <b>Country</b> | <b>Phone Number</b>                                      |
|----------------|--|
| Luxembourg     | +32 800 58580  |
| Netherlands    | 0800 0233200   |
| Russia         | 8800 5009286   |
| Spain          | 0800 000154  |
| Sweden         | 0200 882255  |
| Switzerland    | 0800 805353<br>Opt. 1 (DE)<br>Opt. 2 (FR)<br>Opt. 3 (IT) |
| United Kingdom | 0800 0260637   |

**For other unlisted countries:**  
[www.keysight.com/find/contactus](http://www.keysight.com/find/contactus)

## Index

## Numerics

- 100-pin break-out board [31](#)
- 20-pin break-out board [25](#)
- 38-pin break-out board [27](#)
- 40-pin break-out board [29](#)
- 68-pin break-out board [30](#)

## A

- AC power cord, connection [6](#)
- altitude, operating [4](#)
- assistance, customer [13](#)

## B

- bit level access [17](#)
- break-out boards [24](#)
  - connector part numbers [25](#)
  - differential testing [27, 31](#)
  - dual 100-pin [31](#)
  - dual 20-pin [25](#)
  - dual 38-pin [27](#)
  - dual 40-pin [29](#)
  - enabling signals [25](#)
  - loop back testing [29](#)
  - single 68-pin [30](#)
  - single-ended testing [25, 29, 30](#)
  - test type, DUT [24](#)

## C

- Canadian EMC compliance [13](#)
- capture (input mode) option [17](#)
- certification [13](#)
- checking the shipment [4](#)
- cleaning suggestions [7](#)
- clock [25, 27](#)
  - features [17](#)
  - in, ext connector [22](#)
  - lines, device interface connector [36](#)
  - out connector [22](#)
  - signals, input and output [36](#)
- compliance
  - Canadian EMC [13](#)
  - German noise requirements [13](#)
  - IEC [13](#)
- connections
  - digital bus connector [8](#)
  - module to ESG/PSG [8](#)
  - module to N5101A PCI card [8](#)

- power supply [9](#)
- connectors
  - 100-pin break-out board [31](#)
  - 20-pin break-out board [25](#)
  - 38-pin mictor, break-out board [27](#)
  - 68-pin SCSI style break-out board [30](#)
  - clock out [22](#)
  - device interface [22, 33](#)
  - digital bus [20](#)
  - ext clock in [22](#)
  - freq ref [20](#)
  - mating connector, device interface [38](#)
  - part numbers, break-out boards [25](#)
  - part numbers, device interface & mating connectors [38](#)
- contacting Keysight Technologies [49](#)
- contents [4](#)
- customer assistance [13](#)

## D

- data formats [17](#)
- data lines, device interface connector [36](#)
- DC power receptacle [19](#)
- DC power supply connection [9](#)
- DC supply, device interface connector [37](#)
- declaration of conformity [13](#)
- device interface
  - connector [33](#)
    - clock signal lines [36](#)
    - data lines [36](#)
    - DC supply [37](#)
    - footprint [33](#)
    - location [22](#)
    - pin-out [34](#)
    - VCCIO [37](#)
  - mating connector [38](#)
  - test, running [44](#)
- diagnostics
  - device interface test [44](#)
  - digital bus cable test [46](#)
  - ESG/PSG digital bus test [47](#)
  - menu [44](#)
  - module digital bus test [46](#)
  - tests, running [44](#)
- differential testing
  - 100-pin break-out board [31](#)
  - 38-pin break-out board [27](#)

digital bus  
cable test, running 46  
connector location 20  
connector, connecting 8  
ESG/PSG test 47  
loop back fixture 46  
module test 46  
dimensions, instrument 4  
dual connector break-out boards  
100-pin 31, 48  
20-pin 25, 48  
38-pin 27, 48  
40-pin 29, 48  
DUT test type, break-out boards 24

E  
electrical requirements 4  
EMI suppressor 8  
environmental requirements 4  
error messages, reading on ESG/PSG 42  
ext clock in connector 22

F  
failures. *See* troubleshooting  
features 16  
clock 17  
signal interface 17  
freq ref connector 20  
front panel information 19

G  
German noise requirements compliance 13

H  
height, instrument 4  
humidity 4

I  
IEC compliance 13  
information  
front panel 19  
rear panel 21  
regulatory 13  
safety 2  
input clock signals 36  
input mode option 17

instrument  
dimensions 4  
markings 2  
ventilation requirements 5

K  
Keysight Technologies 49  
Sales and Service offices 50

L  
LEDs  
power 9, 19, 43  
status 19  
length, instrument 4  
line cord 48  
line voltage 5  
logic level, VCCIO 37  
loop back  
boards  
40-pin break-out 11, 29, 44  
digital bus loop back fixture 46, 47  
testing 44

M  
manufacturer, device interface 38  
manufacturer, mating connectors 38  
manufacturers, break-out board connectors 25  
Marker 1 25, 27  
Marker 2 25, 27  
markings, instrument 2  
mating connector, device interface 38  
message URL [www.keysight.com/find/assist](http://www.keysight.com/find/assist) 52  
mictor connector, dual 38-pin 27  
module  
input current 5  
input voltage 5  
overview 16  
power supply 5

O  
operation verification 11  
options  
003 (output mode) 17  
004 (input mode) 17  
194 playback (output mode) 17  
195 capture (input mode) 17

- required signal generator [16](#)
- output clock signals [36](#)
- output mode option [17](#)
- overview, module [16](#)

## P

- part numbers
  - break-out board connectors [25](#)
  - device interface [38](#)
  - mating connectors [38](#)
  - replaceable [48](#)
- pin-out
  - device interface connector [34](#)
  - dual 100-pin break-out board [32](#)
  - dual 20-pin break-out board [26](#)
  - dual 38-pin break-out board [28](#)
  - dual 40-pin break-out board [29](#)
  - single 68-pin SCSI style break-out board [30](#)
- playback (output mode) option [17](#)
- power
  - cord, AC connection [6](#)
  - cord, part number [48](#)
  - DC receptacle [19](#)
  - LED troubleshooting [9](#)
  - LED, location [19](#)
  - LED, troubleshooting [43](#)
  - supply specifications [5](#)
  - supply, connecting [9](#)
- problems. *See* troubleshooting

## R

- rear panel connector
  - clock out [22](#)
  - device interface [22](#)
  - ext clock in [22](#)
- rear panel information [21](#)
- regulatory information [13](#)
- replaceable parts [48](#)
- required options, signal generator [16](#)
- requirements
  - electrical [4](#)
  - environmental [4](#)
  - instrument ventilation [5](#)
  - voltage [5](#)
- returning a signal generator to Keysight [49](#)

## S

- safety information [2](#)
- Sales and Service offices [50](#)

- SCSI style connector, 68-pin [30](#)
- shipment [4](#)
- signal generator
  - error queue, clearing [42](#)
  - error queue, reading messages [42](#)
  - required options [16](#)
- signal interface features [17](#)
- single 68-pin break-out board [30](#), [48](#)
- single-ended testing
  - 20-pin break-out board [25](#)
  - 40-pin break-out board [29](#)
  - 68-pin break-out board [30](#)
- status LED [19](#)
- support URL [50](#)
- support web site [50](#)
- symbols, instrument markings [2](#)
- system test, running [44](#)

## T

- temperatures, operating [4](#)
- test type, break-out boards [24](#)
- test, operation verification [11](#)
- testing, DUT
  - differential
    - 100-pin break-out board [31](#)
    - 38-pin break-out board [27](#)
  - single-ended
    - 20-pin break-out board [25](#)
    - 40-pin break-out board [29](#)
    - 68-pin break-out board [30](#)
- tests, diagnostic
  - device interface [44](#)
  - digital bus cable [46](#)
  - ESG/PSG digital bus [47](#)
  - module digital bus [46](#)
  - running [44](#)
  - system [44](#)
- trigger [25](#), [27](#)
- troubleshooting
  - diagnostics, running [44](#)
  - overview [41](#)
  - replaceable parts [48](#)

## U

- unfiltered DC supply [37](#)
- URL [50](#)

## V

- VCCIO, device interface connector [37](#)

ventilation requirements 5  
verification, operation 11  
voltage requirements 5

W

width, instrument 4

Z

Z-Dok+ 38