

DCA Wide-Bandwidth Oscilloscope Family

Keysight's Digital Communication Analyzer (DCA) family consists of the DCA-X mainframes, modules, and standalone mini-DCAs (DCA-Ms).



Table of Contents

Legend.....	3
86105C 9 GHz Optical/20 GHz Electrical Sampling Module.....	4
86105D 20/34 GHz Optical, 35/50 GHz Electrical Module.....	6
86115D 20/34 GHz Dual Optical Channel Module.....	8
86116C 40/65 GHz Optical, 80 GHz Electrical Module.....	10
N1000A DCA-X Wide-Bandwidth Oscilloscope Mainframe.....	12
N1030A/B 65 GHz Single/Dual Channel Optical Mini-Module	14
N1040A 33/60 GHz Dual Channel Electrical Mini-Module	16
N1045B 60 GHz 2/4 Port Electrical Remote Sampling Head Module	18
N1046A 75/85/>100 GHz 1/2/4 Port Electrical Remote Sampling Head Module	20
N1055A 35/50 GHz 2/4 Port TDR/TDT Remote Sampling Head Module	22
N1060A 50/85 GHz 64 GBd Precision Waveform Analyzer.....	24
N1076B Electrical Clock Recovery	26
N1077A Single/Multimode Optical/Electrical Clock Recovery.....	28
N1078A Single-Mode Optical/Electrical Clock Recovery	30
N1090A DCA-M Sampling Oscilloscope	32
N1092A/B/C/D/E 1/2/3/4 Channel Optical DCA-M Sampling Oscilloscope.....	34
N1094A/B 2/4 Channel Electrical DCA-M Oscilloscope.....	36
N1010x00A Analysis Packages	38
Appendix.....	39
Common DCA Accessories.....	39
DCA Input Connectors	40
RF/Microwave Connectors.....	41
Literature References.....	42
Web Resources.....	42

Legend

The configuration drawings used in this document indicate mandatory features in bold with a dark red background and optional ones in *italic* with a light gray background. In addition, switches indicate what choices you can make. Figure 1 shows a generic example:

- The product must always have option 1.
- The product must have either option 2 or option 3 or option 4 (always select exactly one). Option 2 is the default or recommended choice.
- The product may or may not have option 5. Option 5 is recommended or selected by default.
- The product may or may not have option 6. Option 6 is not selected by default.
- The product may or may not have option 7 or 8 (if desired then select exactly one). There is no default or recommendation.
- If you want the feature of option 9 then you must first choose option 8.

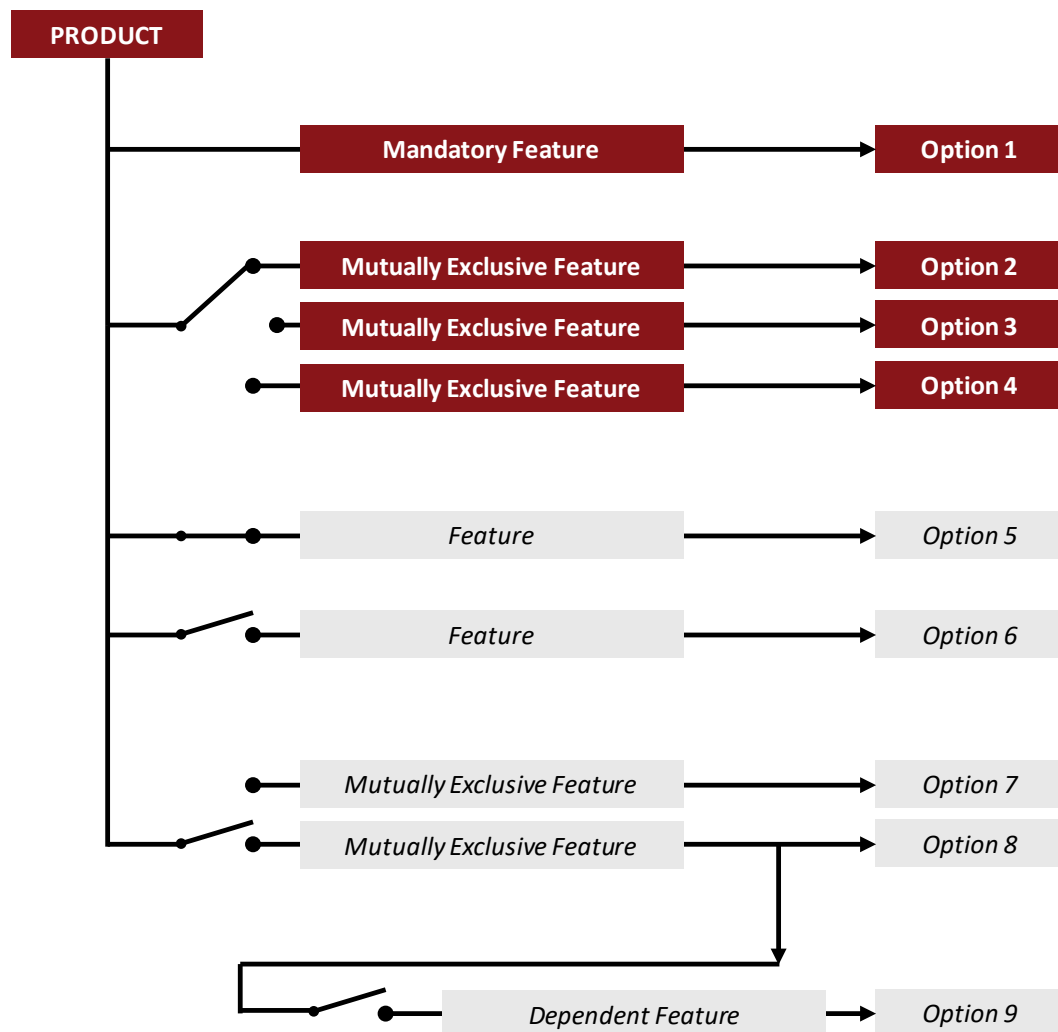

Figure 1: Legend for configuration drawings.

86105C 9 GHz Optical/20 GHz Electrical Sampling Module

The 86105C module is an amplified module optimized for maximum flexibility. Its filters support telecom and datacom/enterprise technologies up to 11.3 Gb/s.

- 9 GHz amplified optical channel for 9/125 to 62.5/125 fibers
- 750 to 1650 nm wavelength range
- 20 GHz electrical channel with 3.5 mm male input
- Compatible with 86100A/B DCA, 86100C DCA-J and 86100D DCA-X mainframes

Product/Option	Description
86105C	9 GHz optical, 20 GHz electrical sampling module
86105C-100	155 Mb/s through 6.25 Gb/s (choose exactly 4 filter rates)
86105C-110	155 Mb/s
86105C-120	622 Mb/s (also covers 614 Mb/s)
86105C-130	1.063 Gb/s
86105C-140	1.244/1.250 Gb/s (also covers 1.229 Mb/s)
86105C-150	2.125 Gb /s
86105C-160	2.488/2.500 Gb/s (also covers 2.458 Gb/s)
86105C-170	2.666 Gb/s
86105C-180	3.125 Gb/s (also covers 3.072 Gb/s)
86105C-190	4.250 Gb/s
86105C-193	5.0 Gb/s
86105C-195	6.250 Gb/s (also covers 6.144 Gb/s)
86105C-200	8.5, 9.953, 10.3125, 10.519, 10.664, 10.709, 11.096, 11.317 Gb/s
86105C-300	Combination of rates available in 86105C-100 and 86105C-200
86105C-IRC	Impulse response correction (optical channel only)



Figure 2: 86105C module with options 130, 150, 180, 190, 300

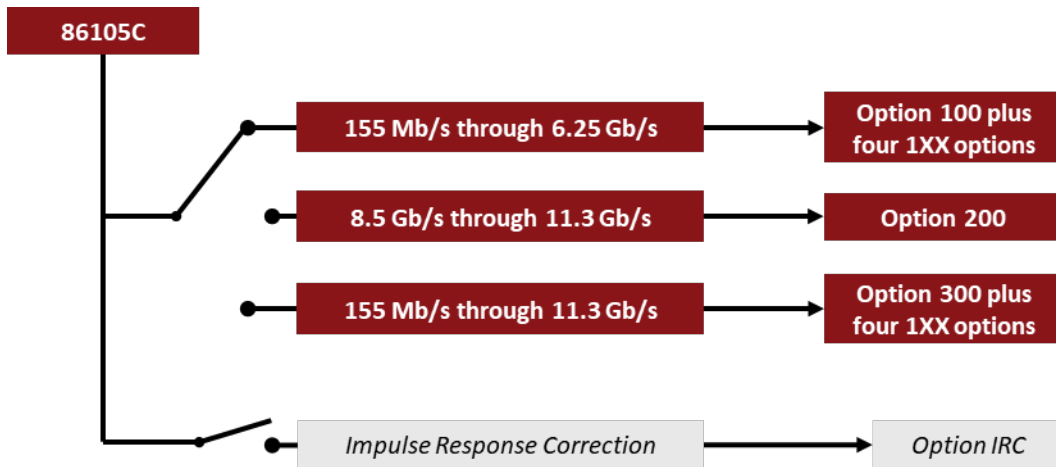

Figure 3: 86105C configuration chart

86105D 20/34 GHz Optical, 35/50 GHz Electrical Module

The 86105D is an unamplified module optimized for best waveform accuracy.

- 20 or 34 GHz optical bandwidth
- 750 to 1650 nm wavelength range
- 35 or 50 GHz electrical channel with 3.5 mm or 2.4 mm connector
- Compatible with 86100C DCA-J and 86100D DCA-X mainframes

Product/Option	Description
86105D	20/34 GHz optical, 35/50 GHz electrical module
86105D-100	Removes the 14.025 Gb/s filter from option 141
86105D-141	20 GHz optical channel; single-mode and multimode, (750 to 1650 nm) Filters for 8.5, 9.953, 10.3125, 10.519, 10.664, 10.709, 11.096, 11.317, 14.025 Gb/s 35 GHz electrical channel, 3.5 mm input
86105D-168	25 Gb/s TDEC filter (requires option 281)
86105D-200	Removes the 8.5 Gb/s to 11.317 Gb/s filters from option 141
86105D-206	20.625 Gb/s TDEC filter (requires option 281)
86105D-281	34 GHz optical channel Filters for 15, 25.78, 27.95, 28.05 Gb/s 50 GHz electrical channel, 2.4 mm input
86105D-IRC	Impulse response correction (optical channel only)



Figure 4: 86105D module with option 141

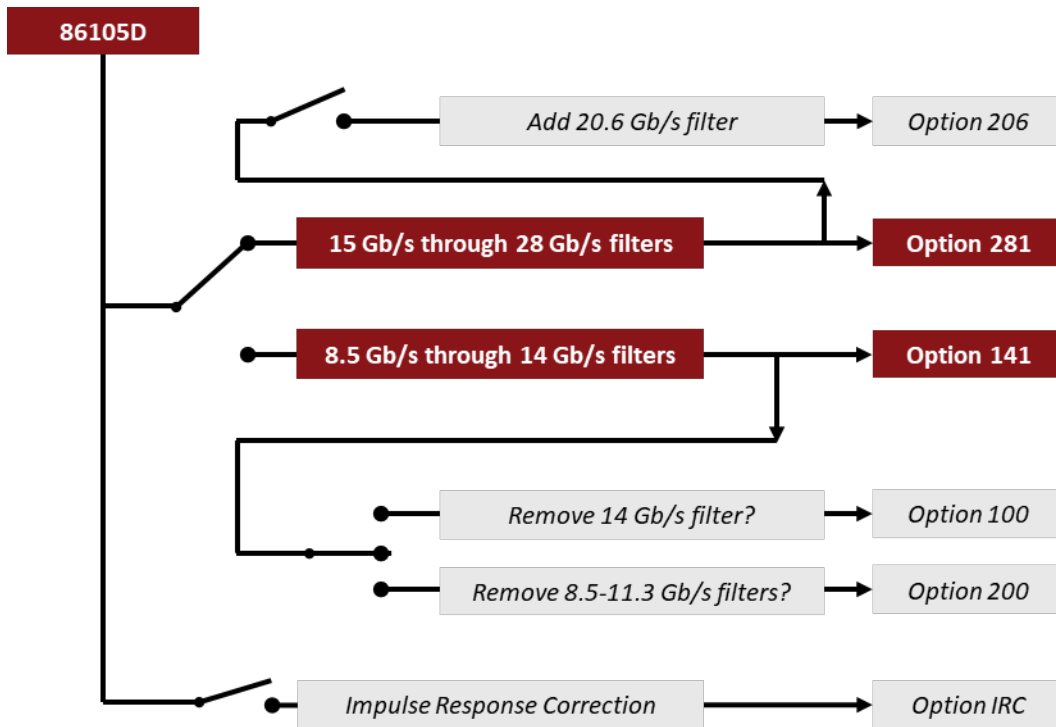

Figure 5: 86105D configuration chart

86115D 20/34 GHz Dual Optical Channel Module

The 86115D is the dual optical version of the 86105D module. It is unamplified and optimized for best waveform accuracy. All options and features apply to both channels.

- 20 or 34 GHz optical bandwidth
- 750 to 1650 nm wavelength range
- Compatible with 86100C DCA-J and 86100D DCA-X mainframes

Product/Option	Description
86115D	20/34 GHz dual optical channel module
86115D-002	20 GHz optical channel; single-mode and multimode, (750 to 1650 nm) Filters for 8.5, 9.953, 10.3125, 10.519, 10.664, 10.709, 11.096, 11.317, 14.025 Gb/s
86115D-102	20 GHz optical channel; single-mode and multimode, (750 to 1650 nm) Filters for 8.5, 9.953, 10.3125, 10.519, 10.664, 10.709, 11.096, 11.317 Gb/s
86115D-142	20 GHz optical channel; single-mode and multimode, (750 to 1650 nm) Filter for 14.025 Gb/s
86115D-206	20.625 Gb/s TDEC filter (requires option 282)
86115D-282	34 GHz optical channel Filters for 15, 25.78, 27.95, 28.05 Gb/s
86115D-IRC	Impulse response correction



Figure 6: 86115D module with option 002

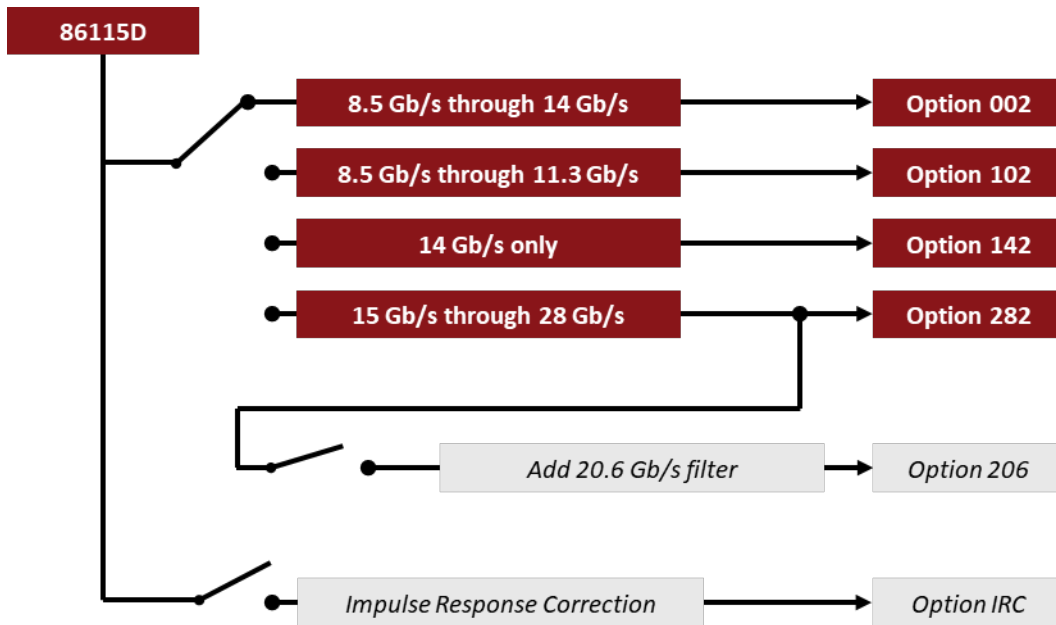

Figure 7: 86115D configuration chart

86116C 40/65 GHz Optical, 80 GHz Electrical Module

The 86116C is an unamplified module optimized for maximum bandwidth.

86116C with option 041:

- 65 GHz optical channel
- Reference receiver for 39.81, 41.25 and 43.02 Gb/s NRZ

86116C with option 025:

- 45 GHz optical channel
- Reference receiver for 17, 25.8, and 27.7 Gb/s

Both versions:

- 80 GHz electrical channel
- 1.85 mm male input
- Compatible with 86100C DCA-J and 86100D DCA-X Mainframes

Product/Option	Description
86116C	40/65 GHz optical, 80 GHz electrical module
86116C-025	40 GHz opt./80 GHz elec., 17.0/25.8/27.7 Gb/s reference receiver
86116C-041	65 GHz opt./80 GHz elec., 39.8/41.25/43.0 Gb/s reference receiver
86116C-201	15 cm 1.85 mm semi rigid cable ¹
86116C-IRC	Impulse response correction (optical channel only)

¹ Use N5520B 1.85 mm (f-f) connector saver to connect the cable to the 86116C electrical channel.



Figure 8: 86116C module with option 025

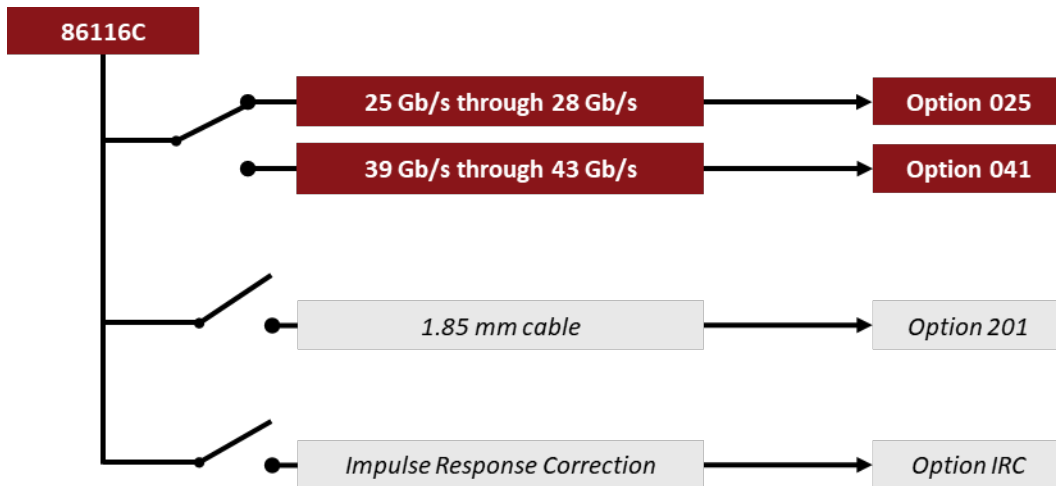

Figure 9: 86116C configuration chart

N1000A DCA-X Wide-Bandwidth Oscilloscope Mainframe

The N1000A DCA-X Wide-Bandwidth Oscilloscope is a modular platform that provides accurate and precise measurements on high-speed digital designs from 50 Mb/s to more than 80 Gb/s. Users configure the N1000A DCA-X mainframe by selecting from a variety of plug-in modules that perform precision optical, electrical, and TDR/TDT measurements. Select specific modules to obtain the desired bandwidth, filtering, and sensitivity that match your measurement needs.

- Flexible, modular platform
- Precision measurements on high-speed signals
- Powerful analysis features

Product/Option	Description
N1000A	DCA-X Wide-bandwidth oscilloscope mainframe
N1000A-STB	Standard timebase
N1000A-LOJ	Low jitter timebase
N1000A-PTB	Internal precision timebase (requires # LOJ)
N1000A-PLK	Pattern lock trigger hardware
N1000A-GPI	GPIB card interface
N1000A-C0C	Certificate of calibration
N1000A-UK6	Commercial calibration certificate with test data
N1010100A	R&D package for FlexDCA (requires pattern lock capability)
N1010200A	Manufacturing package for FlexDCA (requires pattern lock capability)
N1010300A	Signal integrity package for FlexDCA



Figure 10: N1000A DCA-X mainframe (without option PTB)

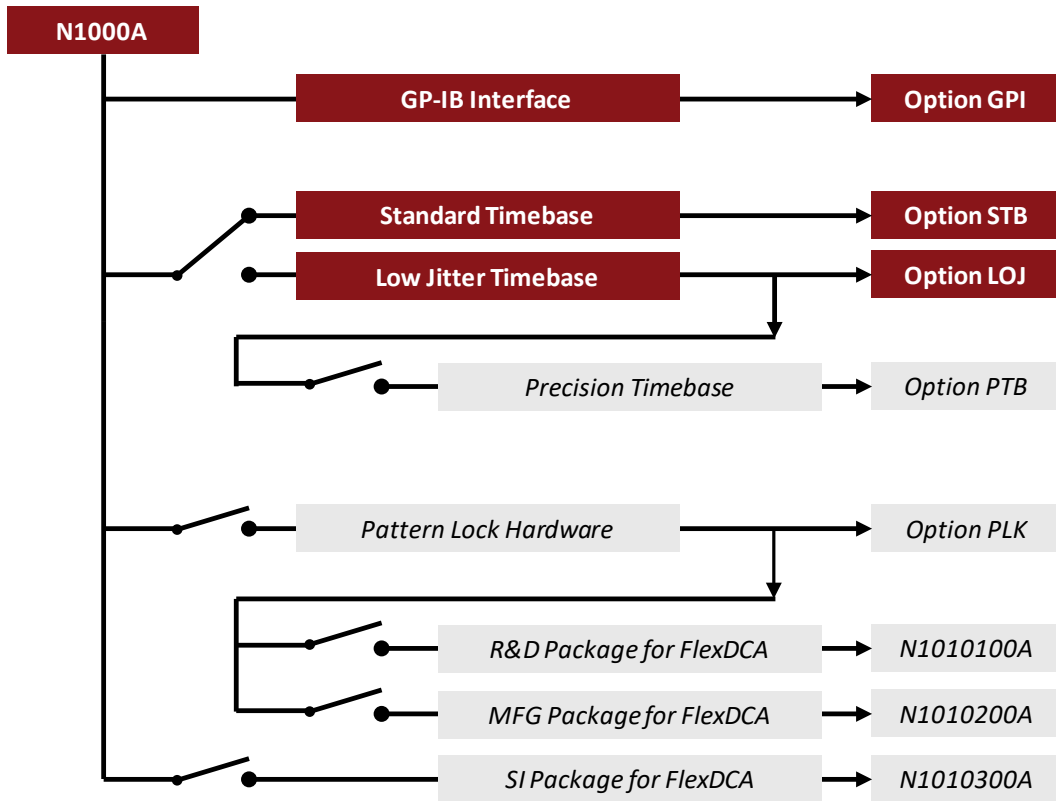

Figure 11: N1000A configuration chart

N1030A/B 65 GHz Single/Dual Channel Optical Mini-Module

The N1030A/B are unamplified mini-modules that provide:

- 65 GHz optical bandwidth
- Optional electrical channel (N1030A only) with 33/40/50/70/85/95 GHz BW settings
- 1 to 8 channels per mainframe
- Simultaneous data acquisition on all channels
- Impulse response correction on all channels (optical and electrical)
- Maximum sampling rate:
 - In 86100D mainframe: 40 kSa/s
 - In N1000A mainframe: 250 kSa/s

Product/Option	Description
N1030A	Single optical channel module
N1030A-280	Hardware filters for 25-28 NRZ Gbaud rates
N1030A-560	Hardware filters for 53-56 Gbaud rates
N1030A-65U	65 GHz unamplified optical channel
N1030A-EC1	Add 95 GHz single electrical channel
N1030A-IRC	Impulse response correction (optical and electrical channels)

Product/Option	Description
N1030B	Dual optical channel module
N1030B-280	Hardware filters for 25-28 NRZ Gbaud rates
N1030B-560	Hardware filters for 53-56 Gbaud rates
N1030B-65U	65 GHz unamplified optical channel
N1030B-IRC	Impulse response correction



Figure 12: N1030A, N1030A with option EC1, N1030B mini-modules

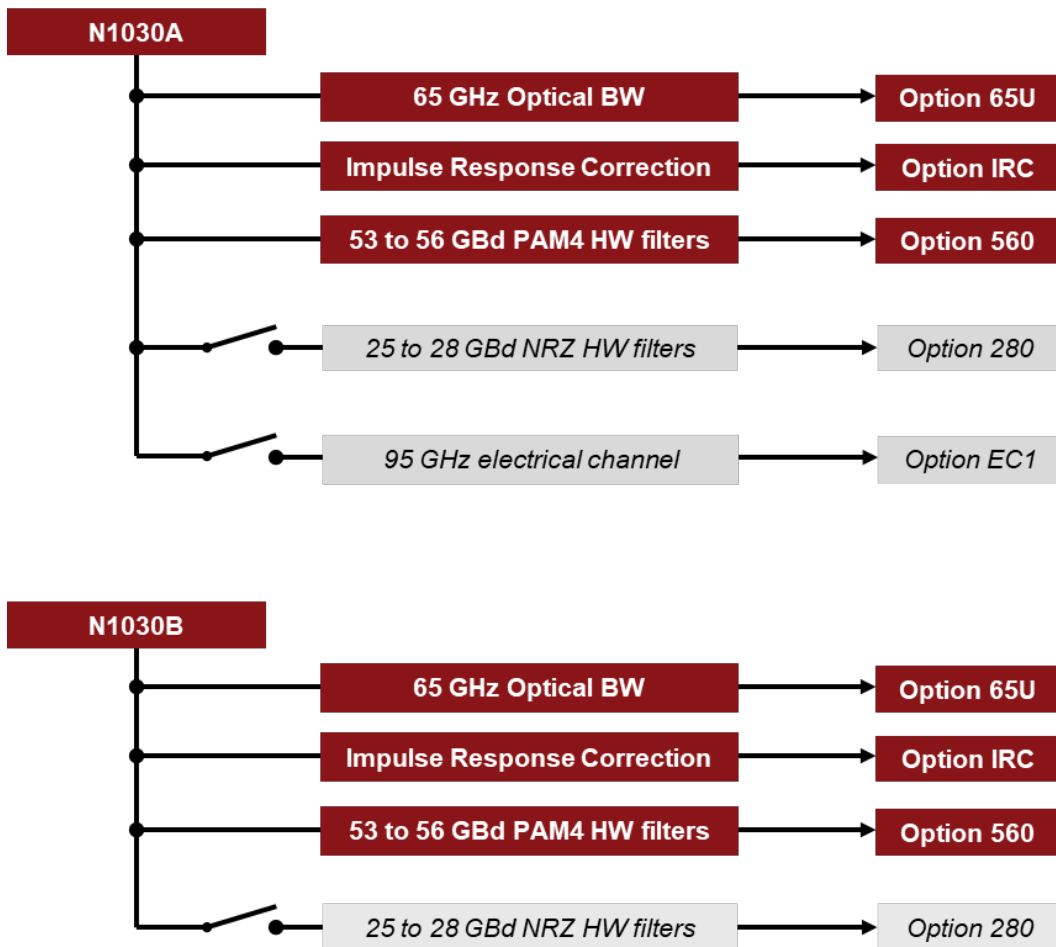

Figure 13: N1030A/B configuration chart

N1040A 33/60 GHz Dual Channel Electrical Mini-Module

The N1040A electrical mini-module provides two electrical channels.

- 20 to 60 GHz bandwidth settings
- Independent skew control for each channel
- 2 to 8 channels per mainframe
- Simultaneous data acquisition on all channels
- Impulse response correction
- Maximum sampling rate:
 - In 86100D mainframe: 40 kSa/s
 - In N1000A mainframe: 250 kSa/s

Product/Option	Description
N1040A	Dual electrical channel module
N1040A-033	20/33 GHz bandwidth, 2.92 mm inputs
N1040A-060	20/33/40/60 GHz bandwidth, 1.85 mm inputs
N1040A-IRC	Impulse response correction



Figure 14: N1040A mini-module

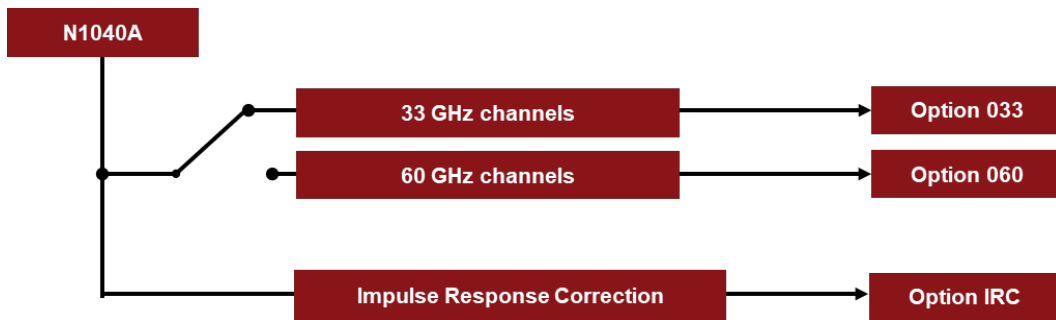

Figure 15: N1040A configuration chart

N1045B 60 GHz 2/4 Port Electrical Remote Sampling Head Module

The N1045B 60 GHz remote sampling head module is engineered to provide superior measurement accuracy with the highest throughput for testing multi-lane electrical designs. The remote head design allows the high-bandwidth sampler to be located very near the device under test which minimizes loss due to cabling.

- 60 GHz bandwidth (65 GHz typical)
- Independent skew control on each sampler
- 2 to 16 electrical channels per mainframe
- Simultaneous data acquisition on all channels
- Maximum sampling rate:
 - In 86100D mainframe: 40 kSa/s
 - In N1000A mainframe: 250 kSa/s

Product/Option	Description
N1045B	60 GHz 2/4 port electrical remote sampling head
N1045B-02F	2 channel remote head, 1.85mm, female inputs
N1045B-02M	2 channel remote head, 1.85mm, male inputs
N1045B-04F	4 channel remote head, 1.85mm, female inputs
N1045B-04M	4 channel remote head, 1.85mm, male inputs
N1045B-C0C	Certificate of calibration
N1045B-UK6	Commercial calibration certificate with test data
N1027A-45A	Accessory kit for two N1045A/N1045B channels



Figure 16: N1045B 60 GHz remote head module with option 04M

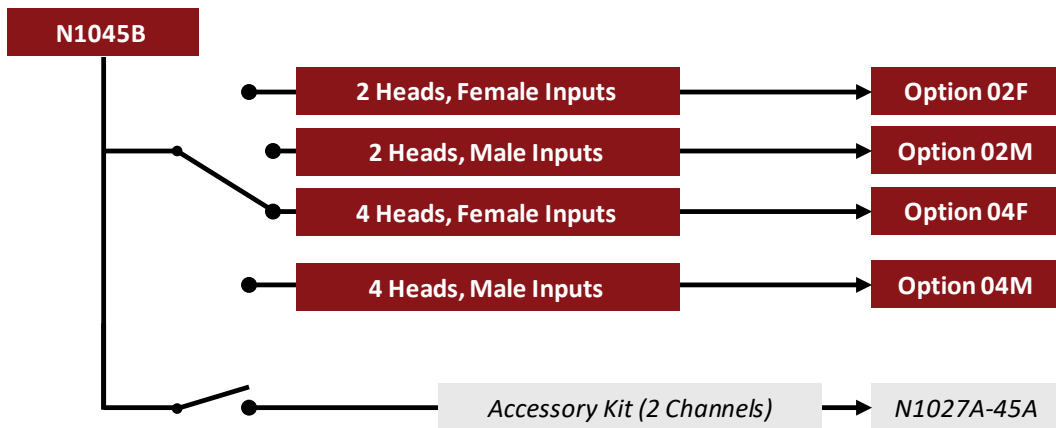

Figure 17: N1045B configuration chart

N1046A 75/85/>100 GHz 1/2/4 Port Electrical Remote Sampling Head Module

The N1046A is a group of remote sampling head modules designed for the fastest oscilloscope applications. The “soft roll-off” of their frequency response can capture wideband digital signals such as NRZ or PAM4, as well as narrowband.

- 75 GHz, 85 GHz or > 100 GHz maximum available bandwidth (selectable option, upgradable)
- 1, 2 or 4 channels per module
- 1 to 4 modules per mainframe
- Independent skew control on each sampler
- Simultaneous data acquisition on all channels
- User-selectable bandwidth settings starting at 60 GHz
- Maximum sampling rate:
 - In 86100D mainframe: 40 kSa/s
 - In N1000A mainframe: 250 kSa/s¹

Product/Option	Description
N1046A	75/85/100 GHz 1/2/4 Port Electrical Remote Sampling Head
N1046A-11F	100 GHz, 1 channel remote head, 1 mm, female
N1046A-12F	100 GHz, 2 channel remote head, 1 mm, female
N1046A-14F	100 GHz, 4 channel remote head, 1 mm, female
N1046A-71F	75 GHz, 1 channel remote head, 1 mm, female
N1046A-72F	75 GHz, 2 channel remote head, 1 mm, female
N1046A-74F	75 GHz, 4 channel remote head, 1 mm, female
N1046A-81F	85 GHz, 1 channel remote head, 1 mm, female
N1046A-82F	85 GHz, 2 channel remote head, 1 mm, female
N1046A-84F	85 GHz, 4 channel remote head, 1 mm, female
N1046A-C0C	Certificate of calibration
N1046A-UK6	Commercial calibration certificate with test data
N1027A-46A	Accessory kit for two N1046A channels

¹ Modules with serial number prefix small than US5840 are limited to 40 kSa/s. Keysight will upgrade them to the full sampling rate free of charge during their next calibration cycle.



Figure 18: N1046A 100 GHz remote head module with option 12F, 1.0 mm input connector detail

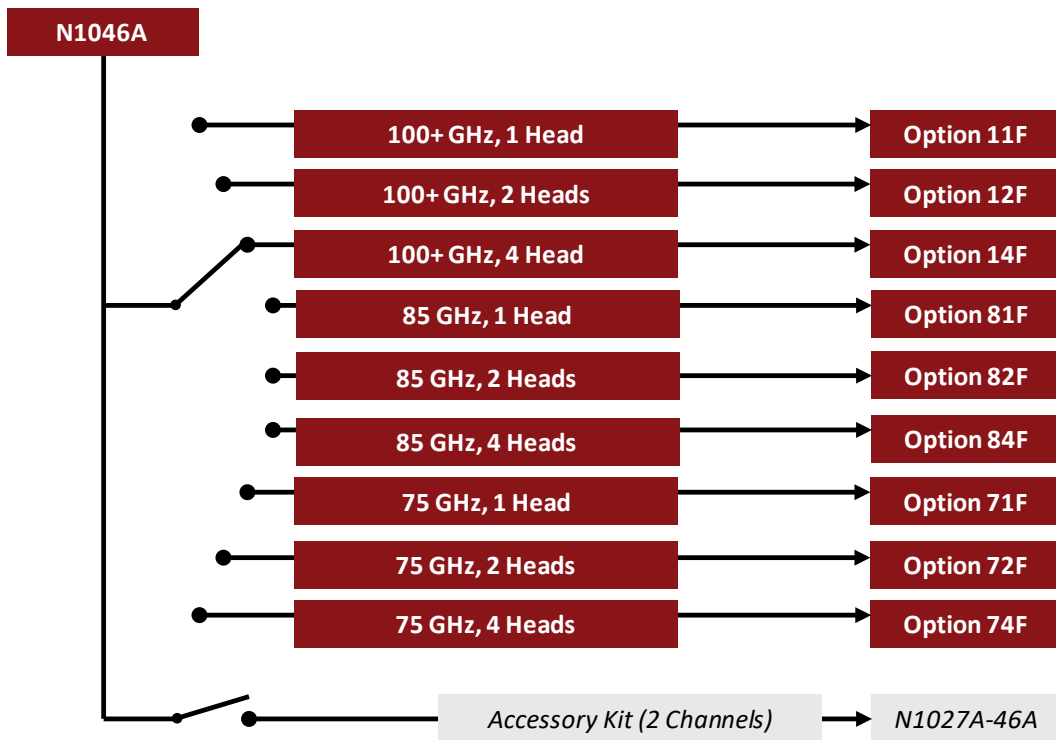

Figure 19: N1046A configuration chart

N1055A 35/50 GHz 2/4 Port TDR/TDT Remote Sampling Head Module

The Keysight N1055A 35/50-GHz (8-ps) time-domain reflectometry (TDR) and time-domain transmission (TDT) module for the Keysight 86100D DCA-X platform provides fast, accurate impedance and S-parameter measurements on high-speed designs that have up to 16 ports.

- Dual or quad remote heads with either 35 or 50 GHz bandwidth
- Edge speed (10 to 90%, typical): 18 ps (35 GHz) or 8 ps (50 GHz)
- Integrated diode limiters for ESD/EOS protection
- Maximum sampling rate:
 - In 86100A mainframe: 40 kSa/s (200 kSa/s²)
 - In N1000A mainframe: 250 kSa/s

Product/Option	Description
N1055A	35/50 GHz 2/4 Port electrical remote head module with TDR/TDT
N1055A-32F	35 GHz 2 channels, 2.92 mm, female
N1055A-32M	35 GHz 2 channels, 2.92 mm, male
N1055A-34F	35 GHz 4 channels, 2.92 mm, female
N1055A-34M	35 GHz 4 channels, 2.92 mm, male
N1055A-52F	50 GHz 2 channels, 1.85 mm, female
N1055A-52M	50 GHz 2 channels, 1.85 mm, male
N1055A-54F	50 GHz 4 channels, 1.85 mm, female
N1055A-54M	50 GHz 4 channels, 1.85 mm, male
N1055A-C0C	Certificate of calibration
N1055A-UK6	Commercial calibration certificate with test data
<i>N1055A-FS1</i>	<i>Fast sampling (mandatory on all new units)</i>
N1027A-x4y ³	TDT/TDT accessory kit with DC to 67 GHz ECal module and adapters
N4694D-0DC	DC to 67 GHz 2-port 1.85 mm ECal module ⁴

² In TDR mode when only channels from one module are active.

³ x and y of N1027A option must match the N1055A option (e.g., use N1027A-54F for N1055A-52F/54F).

⁴ Use N469xD with option M0M for N1055A-xxF remote heads, and N469xD-F0F for N1055A-xxM.



Figure 20: N1055A 50 GHz TDR/TDT modules with option 52F (left), and option 54M (right)

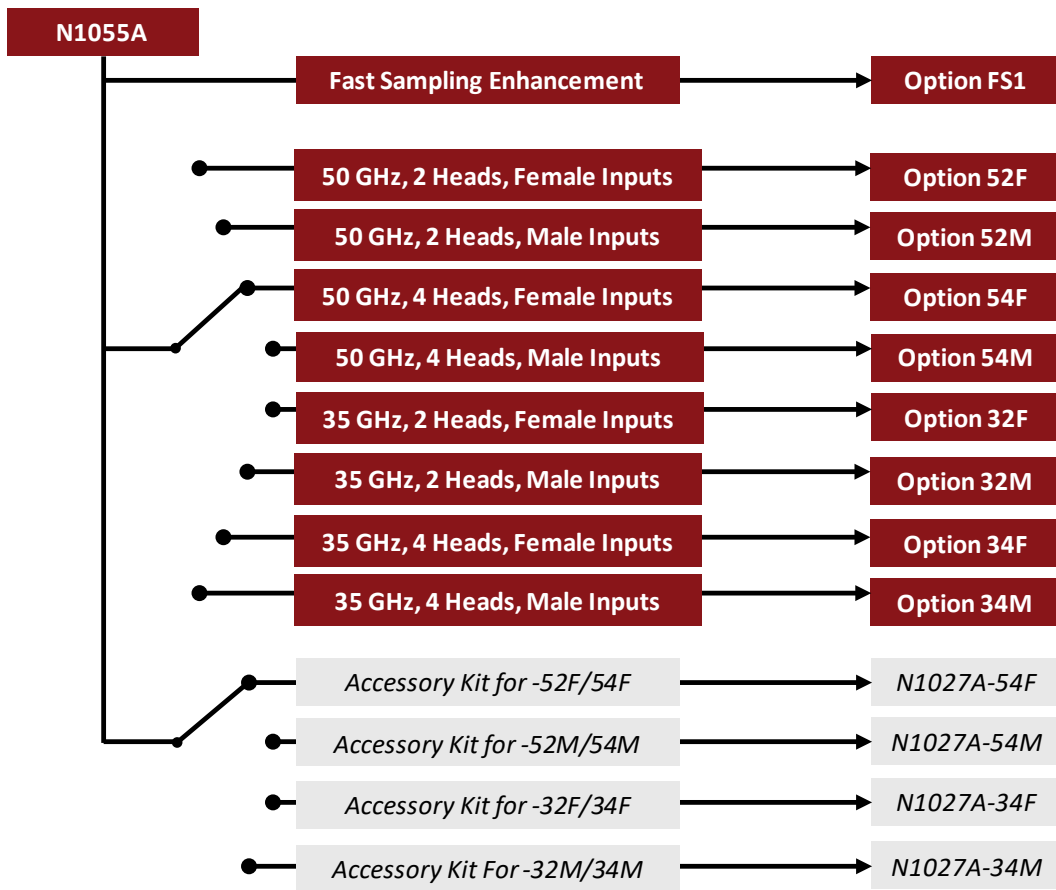

Each accessory kit includes one DC-67 GHz coupled ECal module, adapters, torque wrenches, and more.

Figure 21: N1055A configuration chart

N1060A 50/85 GHz 64 GBd Precision Waveform Analyzer

The N1060A precision Waveform Analyzer is a three-slot wide module that combines two electrical channels with a clock recovery (CDR) and a precision timebase (PTB). Integration minimizes path delay differences between the CDR, PTB and the samplers, resulting in more accurate jitter measurements.

- 50 or 85 GHz bandwidth
- 16, 32 or 64 GBd NRZ and PAM4 clock recovery
- Jitter Spectrum Analysis and Clock Recovery Emulation
- Electrical inputs: 1.0 mm male
 - Ships with 1.0 female to 1.85 female and 1.0 female to 2.92 female adapters

Product/Option	Description
N1060A	Precision waveform analyzer
N1060A-050	Two 50 GHz channels
N1060A-085	Two 85 GHz channels
N1060A-216	Supported input rates: 125 MBd to 16 GBd
N1060A-232	Supported input rates: 125 MBd to 32 GBd
N1060A-264	Supported input rates: 125 MBd to 64 GBd
N1060A-EVA	Integrated variable equalizer
N1060A-JSA	Jitter spectrum analysis and clock recovery emulation
N1060A-PTB	Precision timebase, ultra-low random jitter
N1060A-C0C	Certificate of calibration
N1060A-UK6	Commercial calibration certificate with test data
N1060A-A1F	Two 1.0 mm female to 1.0 mm female adapters
N1060A-CA1	Cable pair, 1.0 mm
N1060A-CA2	Cable pair (matched), 2.4 mm, 60 cm
N1060A-DC2	Two DC blocks, 2.4 mm, 50KHz - 50GHz
N1060A-DC8	Two DC blocks, 1.85 mm, 700KHz-67GHz



Figure 22: N1060A Precision waveform analyzer with option 085

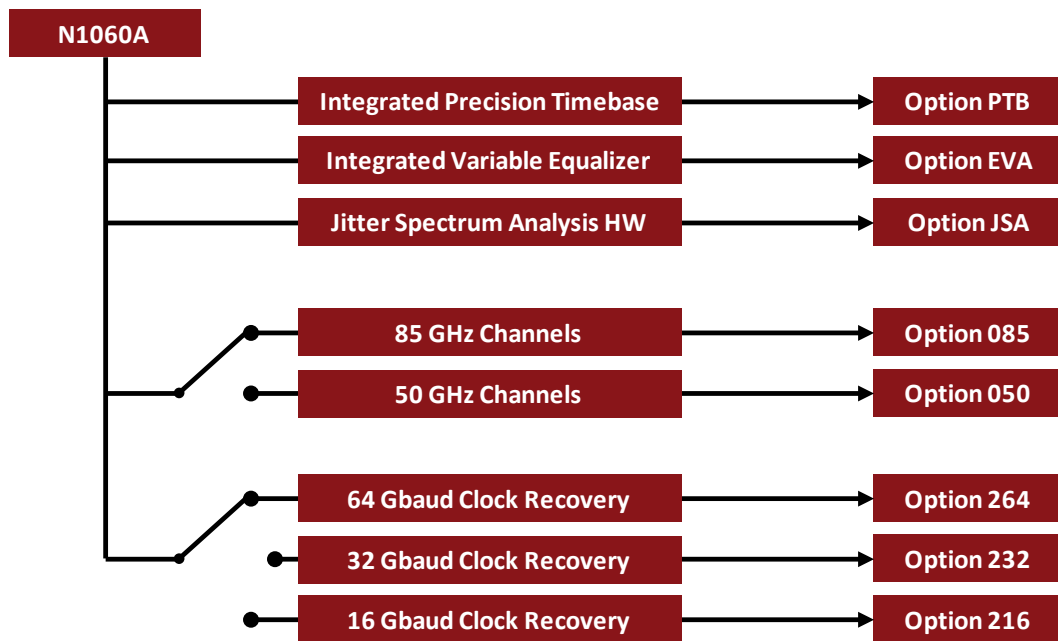

Figure 23: N1060A configuration chart

N1076B Electrical Clock Recovery

Provides compliant clock recovery capabilities for electrical non-return-to-zero (NRZ) and pulse amplitude modulation 4-level (PAM4) signals

- Continuous unbanded tuning from 125 MBd to 64 GBd PAM4 and NRZ
- Adjustable clock recovery loop bandwidth (to 20 MHz) and peaking for “Golden PLL” performance
- Internal and external equalizers to recover clock from closed eyes
- Ultra-low residual random jitter < 100 fs RMS
- Jitter Spectrum Analysis (JSA) and “ideal” clock recovery emulation capability
- Phase noise analysis of clock or data signals using 86100DU-400 PLL software
- Controlled by N1010A FlexDCA application (free download) or DCA-X mainframe

Product/Option	Description
N1076B	Electrical clock recovery
N1076B-216	Supported input rates: 125 MBd to 16 GBd
N1076B-232	Supported input rates: 125 MBd to 32 GBd
N1076B-264	Supported input rates: 125 MBd to 64 GBd
N1076B-EVA	Integrated variable equalizer
N1076B-JSA	Jitter spectrum analysis and clock recovery emulation
N1076B-C0C	Certificate of calibration
N1076B-UK6	Commercial calibration certificate with test data
N1076B-1CM	Single DCA-M rack mount kit
N1076B-1CN	Dual DCA-M side by side rack mount
N1076B-CR1	Clock recovery phase matching kit
N1076B-2P1	Microwave pick-off tee 1.0mm connectors, matched pair
N1076B-2P2	Microwave pick-off tee 2.4mm connectors, matched pair
N1076B-2P3	Microwave pick-off tee 2.92mm connectors, matched pair
N1076B-2P8	Microwave pick-off tee 1.85mm connectors, matched pair



Figure 24: N1076B Electrical clock recovery with option 264

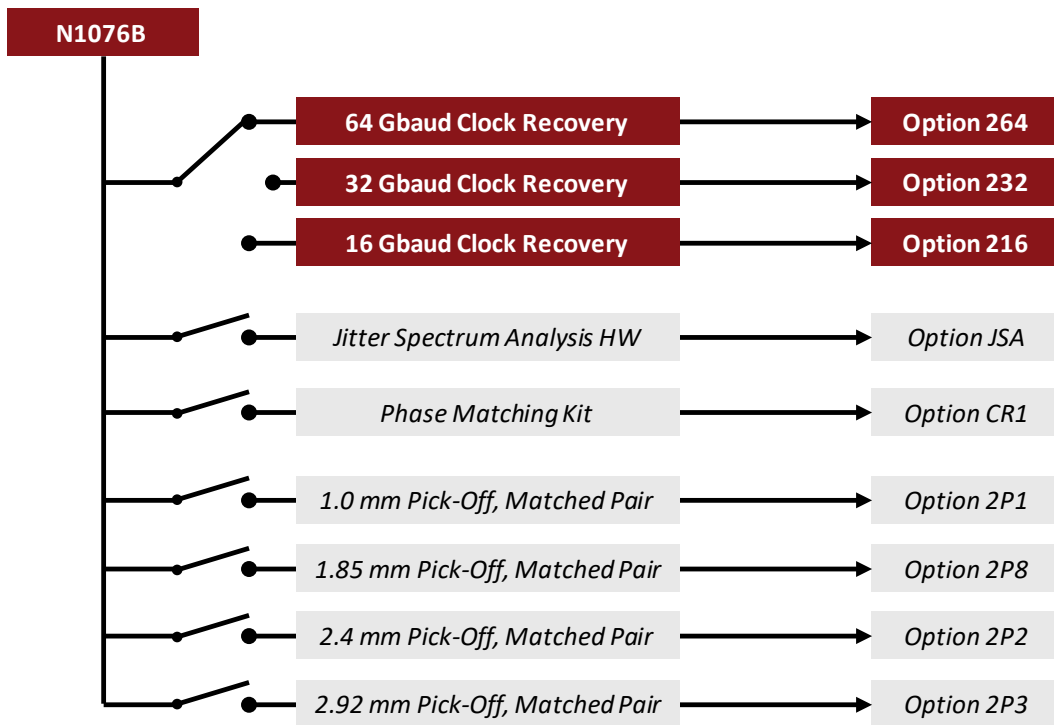

The pick-offs have 2.92 mm connectors on the clock recovery port. The other two ports are male and female with connector sizes as shown above.

Figure 25: N1076B configuration chart

N1077A Single/Multimode Optical/Electrical Clock Recovery

Provides compliant clock recovery capabilities for single- and multimode optical as well as electrical signals

- Works with non-return-to-zero (NRZ) and pulse amplitude modulation 4-level (PAM4) modulation
- Continuous unbanded tuning from 50 MBd to 32 GBd
- 830 to 1600 nm, single-mode and multimode
- Integrated amplified optical-to-electrical (O/E) (high sensitivity)
- Adjustable clock recovery loop bandwidth (to 20 MHz) and peaking for “Golden PLL” performance
- Supports NRZ and PAM4 signals
- Ultra-low residual random jitter < 100 fs RMS
- Integrated single-mode (SM) and multimode (MM) splitters (optional)
- Jitter Spectrum Analysis (JSA) and “ideal” clock recovery emulation capability (optional)
- Supports phase noise analysis of clock or data signals using 86100DU-400 PLL software
- Controlled by N1010A FlexDCA application (free download) or DCA-X mainframe

Product/Option	Description
N1077A	Optical/electrical clock recovery
N1077A-216	Supported input rates: 50 MBd to 16 GBd
N1077A-232	Supported input rates: 50 MBd to 32 GBd
N1077A-SMS	Internal single-mode (9/125 um) and multimode (50/125um) splitter
N1077A-SXT	External splitter (supplied by customer)
N1077A-JSA	Jitter spectrum analysis and clock recovery emulation
N1077A-C0C	Certificate of calibration
N1077A-UK6	Commercial calibration certificate with test data
N1077A-1CM	Single DCA-M rack mount kit
N1077A-1CN	Dual DCA-M side by side rack mount kit
N1077A-CR1	Clock recovery phase matching kit

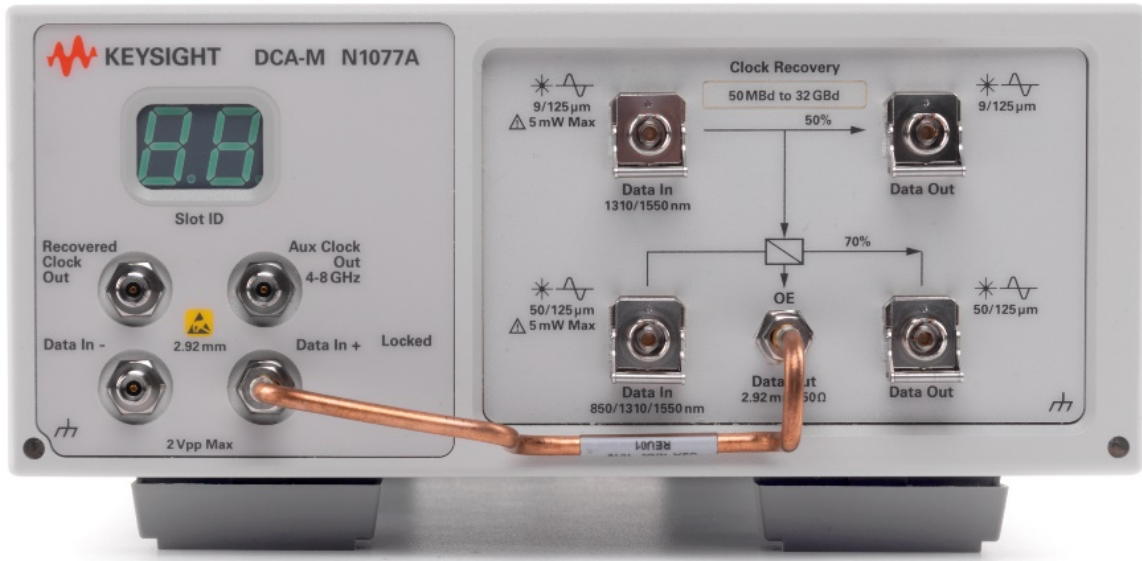
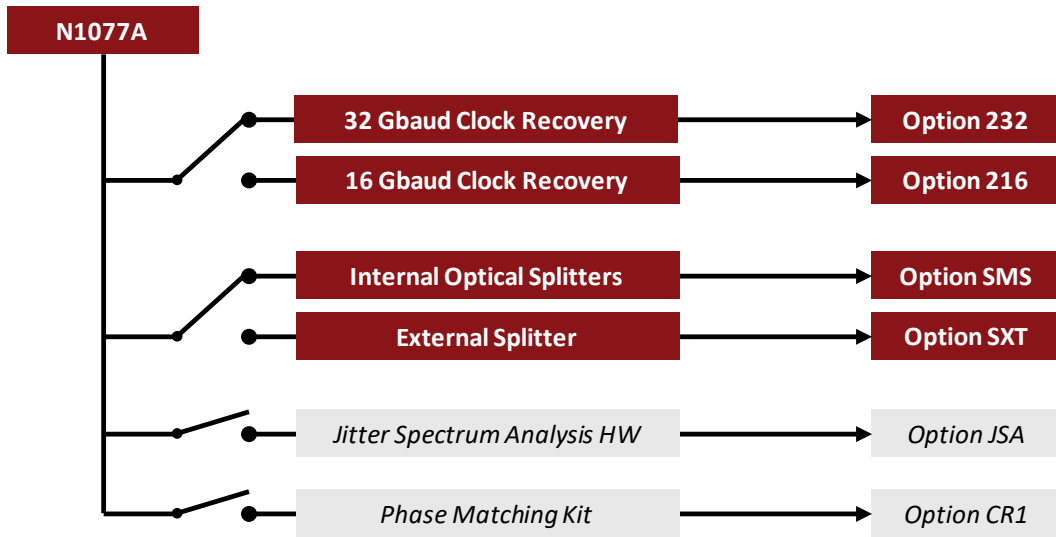

Figure 26: N1077A Single- & multimode optical/electrical clock recovery with options 232 and SMS



External splitters must be supplied by the customer.

Figure 27: N1077A configuration chart

N1078A Single-Mode Optical/Electrical Clock Recovery

Provides compliant clock recovery capabilities for single-mode optical as well as electrical signals

- Works with non-return-to-zero (NRZ) and pulse amplitude modulation 4-level (PAM4) modulation
- Continuous unbanded tuning from 125 MBd to 64 GBd PAM4 and NRZ
- Adjustable clock recovery loop bandwidth (to 20 MHz) and peaking for “Golden PLL” performance
- Internal and external equalizers to recover clock from closed eyes
- Ultra-low residual random jitter < 100 fs RMS
- Jitter Spectrum Analysis (JSA) and “ideal” clock recovery emulation capability
- Phase noise analysis of clock or data signals using 86100DU-400 PLL software
- Controlled by N1010A FlexDCA application (free download) or DCA-X mainframe

Product/Option	Description
N1078A	Optical/electrical clock recovery
N1078A-216	Supported input rates: 125 MBd to 16 GBd
N1078A-225	Supported input rates 25 GBd to 29 GBd
N1078A-232	Supported input rates: 125 MBd to 32 GBd
N1078A-253	Supported input rates 53 GBd to 58 GBd
N1078A-264	Supported input rates: 125 MBd to 64 GBd
N1078A-S50	Internal single-mode splitter 50 percent to optical output, 9/125 um
N1078A-SXT	External splitter
N1078A-EVA	Integrated variable equalizer
N1078A-JSA	Jitter spectrum analysis and clock recovery emulation
N1078A-C0C	Certificate of calibration
N1078A-UK6	Commercial calibration certificate with test data
N1078A-CR1	Clock recovery phase matching kit



Figure 28: N1078A Single-mode optical/electrical clock recovery with options 264 and S50

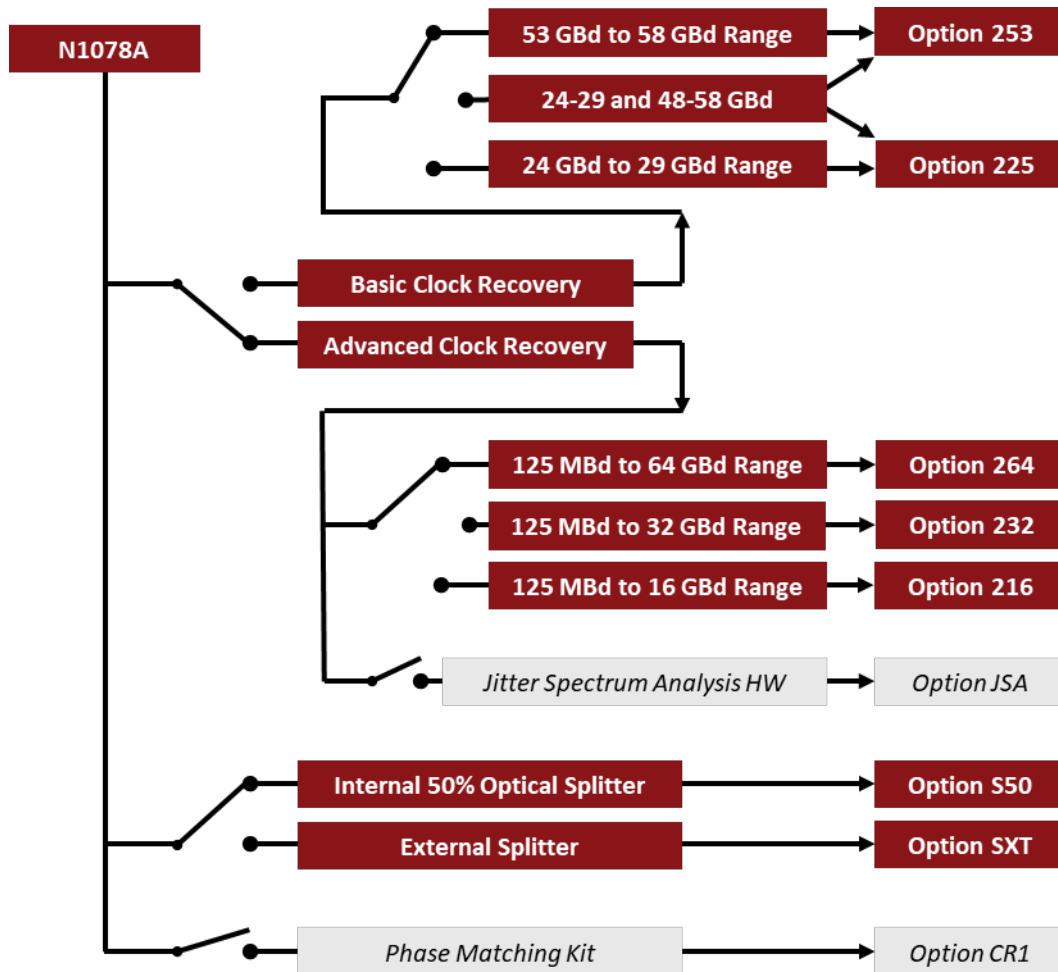

Figure 29: N1078A configuration chart

N1090A DCA-M Sampling Oscilloscope

High accuracy, low cost solution for optical eye diagram analysis

- 750 to 1650 nm, single- and multimode
- Maximum sampling rate: 60 kSa/s
- Controlled by N1010A FlexDCA application (free download) or DCA-X mainframe

Product/Option	Description
N1090A	Optical sampling oscilloscope
N1090A-140	Reference receiver filters for 1.244/1.25/1.229 Gb/s
N1090A-160	Reference receiver filters for 2.458/2.488/2.5 Gb/s
N1090A-180	Reference receiver filters for 3.072/3.125 Gb/s
N1090A-200	Reference receiver filters for 8.5/9.95/10.3/10.5/10.66/10.71/11.1/11.3 Gb/s
N1090A-204	Reference receiver filters for 8.5/9.95/10.3/10.5 Gb/s
N1090A-EEC	Enable electrical channel
N1090A-PLK	Pattern lock trigger hardware
N1090A-C0C	Certificate of calibration
N1090A-UK6	Commercial calibration certificate with test data
N1090A-1CM	Single N1090A rack mount kit
N1090A-1CN	Dual instrument side by side rack mount kit
N1010100A	R&D package for FlexDCA (requires pattern lock capability)
N1010200A	Manufacturing package for FlexDCA (requires pattern lock capability)



Figure 30: N1090A DCA-M (without option EEC)

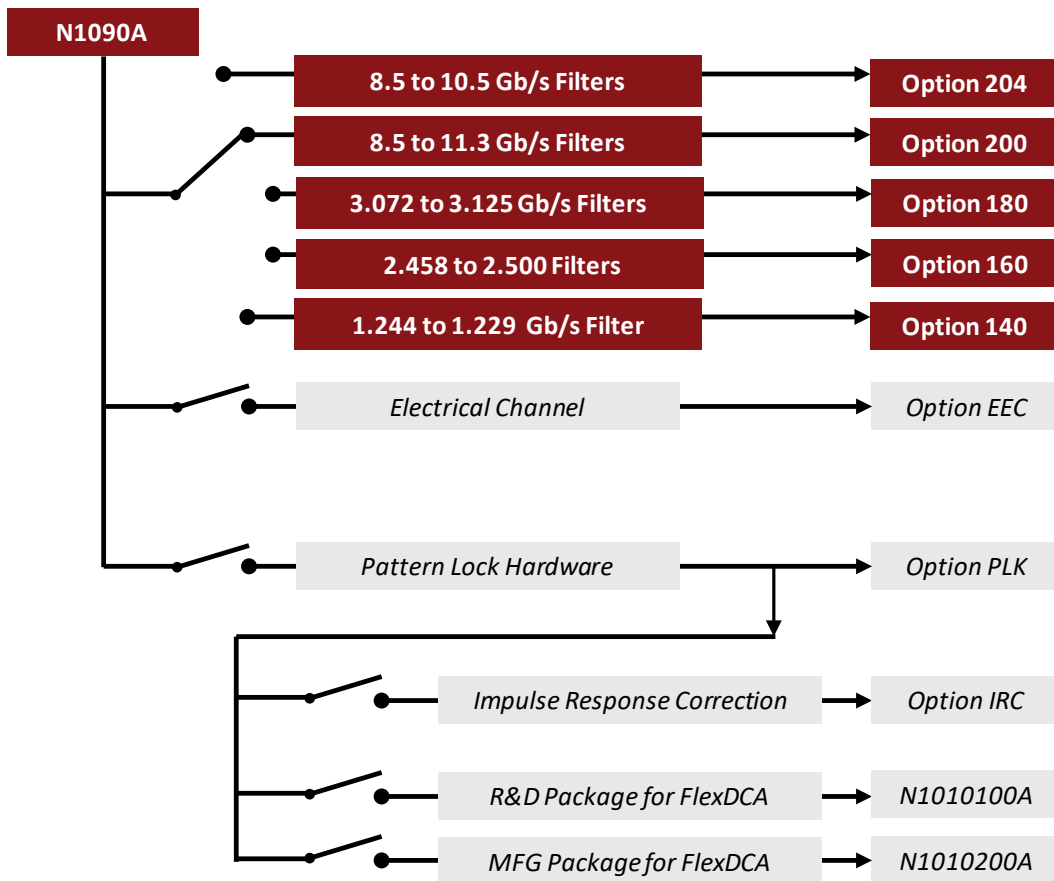

Figure 31: N1090A configuration chart

N1092A/B/C/D/E 1/2/3/4 Channel Optical DCA-M Sampling Oscilloscope

High accuracy, low cost solution for optical eye, waveform and jitter analysis

- 830 to 1600 nm, single- and multimode
- 50 GHz electrical channels (N1092C/E)
- Characteristic intrinsic jitter: 400 fs (standard), 160 fs (option LOJ)
- Maximum sampling rate: 100 kSa/s (standard), 250 kSa/s (option FS1)
- Controlled by N1010A FlexDCA application (free download) or DCA-X mainframe

Product/Option	Description
N1092A/B/D	Single/dual/quad optical channel oscilloscope
N1092C/E	Single/dual optical, dual electrical channel oscilloscope
N1092x-280	25.781, 26.563, 27.952, 28.050 Gbaud filters (mandatory)
N1092x-30A	30 GHz amplified optical
N1092x-40A	40 GHz amplified optical and additional 53.125 GBd hardware filter
N1092x-168	Additional 25.78 Gb/s TDEC filter
N1092x-CDR	Add 24-29 and 48-58 GBd Clock Recovery (N1092A/B models only, requires #40A)
N1092x-206	Additional 20.625 Gb/s filter
N1092x-STB	Standard timebase
N1092x-LOJ	Low jitter timebase
N1092x-PLK	Pattern lock trigger hardware (requires option LOJ)
N1092x-FS1	Fast sampling rate
N1092x-IRC	Impulse response correction (optical channels only)
N1092x-C0C	Certificate of calibration
N1092x-UK6	Commercial calibration certificate with test data
N1092x-1CM	Single instrument rack mount kit
N1092x-1CN	Dual instrument side by side rack mount kit
N1010100A	R&D package for FlexDCA (requires options PLK and LOJ)
N1010200A	Manufacturing package for FlexDCA (requires options PLK and LOJ)

TDECQ measurements compliant to IEEE 802.3bs/cd can be made with either option 30A or 40A, and requires options LOJ, PLK, IRC and the R&D or MFG package. Option 168 (TDEC HW filter) is recommended when making 25-28 GBd TDECQ measurements with option 30A.



Figure 32: N1092D quad optical DCA-M with options 30A, 280 and 168

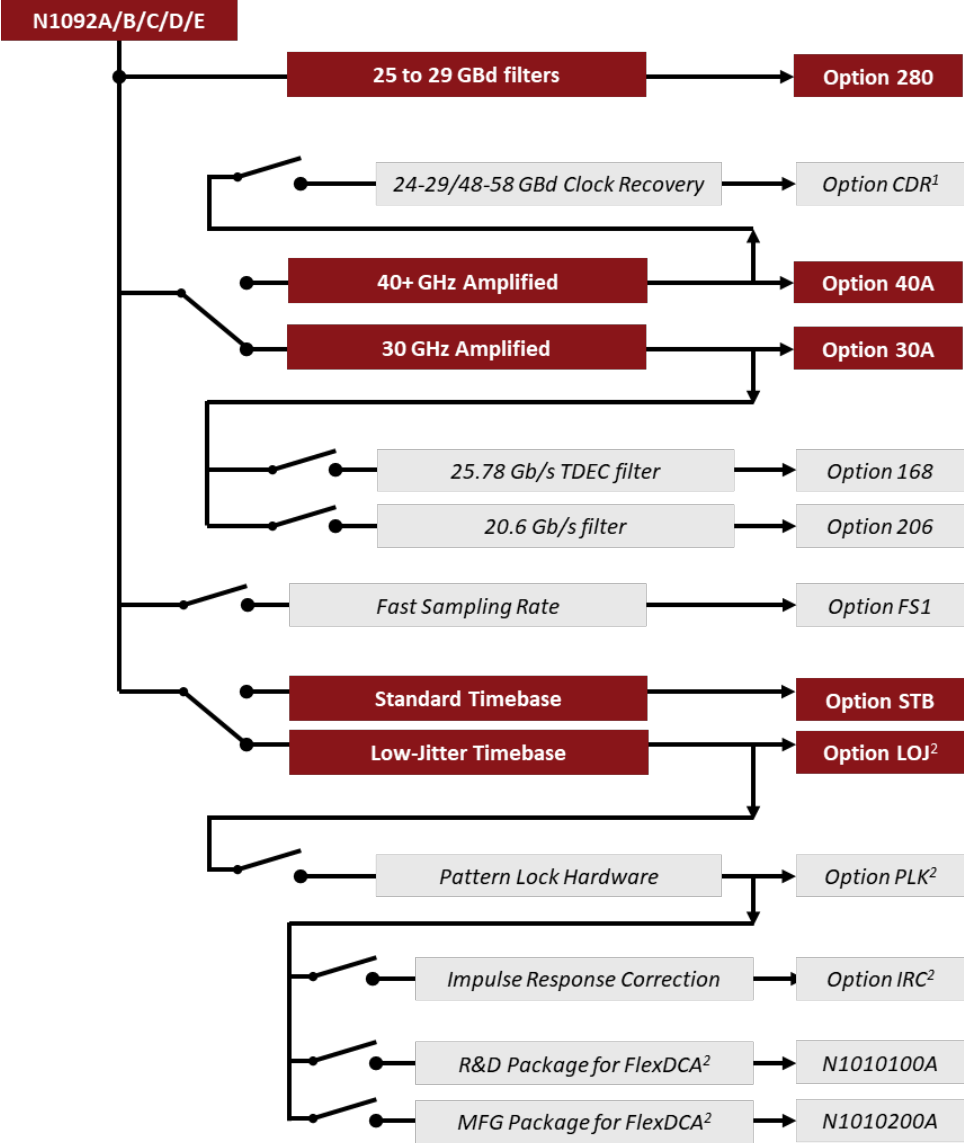

¹ Option CDR is available only on the N1092A and N1092B.

² TDECQ measurements require options LOJ, PLK, IRC and the R&D or MFG package. See document 5992-3635EN for TDECQ measurement details.

Figure 33: N1092A/B/C/D/E configuration chart

N1094A/B 2/4 Channel Electrical DCA-M Oscilloscope

High-accuracy, low-cost solution for electrical eye, waveform and jitter analysis

- 20/33 GHz and 20/33/40/50 GHz bandwidth settings support OIF and Ethernet standards
- Characteristic intrinsic jitter: 400 fs (standard), 135 fs (option LOJ)
- Maximum sampling rate: 100 kSa/s (standard), 250 kSa/s (option FS1)
- Controlled by N1010A FlexDCA application (free download) or DCA-X mainframe

Product/Option	Description
N1094A	Dual electrical channel oscilloscope
N1094B	Quad electrical channel oscilloscope
N1094A/B-030	33 GHz maximum bandwidth
N1094A/B-050	50 GHz maximum bandwidth
N1094A/B-STB	Standard timebase
N1094A/B-LOJ	Low jitter timebase
N1094A/B-PLK	Pattern lock trigger hardware (requires option LOJ)
N1094A/B-FS1	Fast sampling rate
N1094A/B-C0C	Certificate of calibration
N1094A/B-UK6	Commercial calibration certificate with test data
N1094A/B-1CM	Single instrument rack mount kit
N1092A/B-1CN	Dual instrument side by side rack mount kit
N1010100A	R&D package for FlexDCA (requires pattern lock capability)
N1010200A	Manufacturing package for FlexDCA (requires pattern lock capability)



Figure 34: N1094B quad electrical DCA-M with option 050

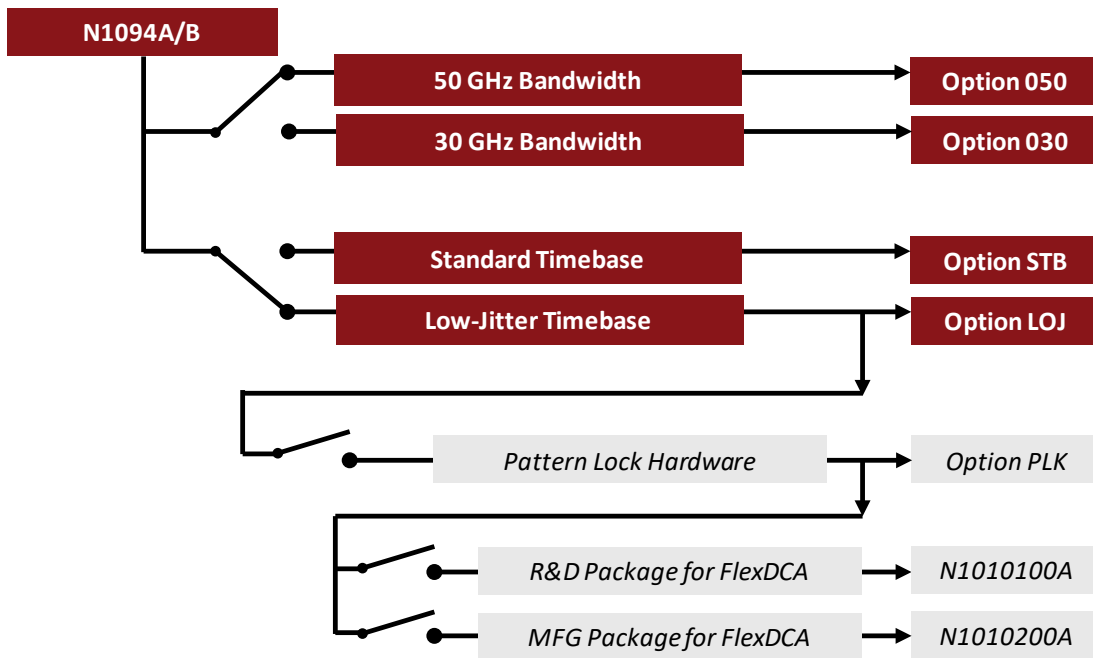

Figure 35: N1094A/B configuration chart

N1010x00A Analysis Packages

Analysis Packages offer additional features that provide deep insights into signal or DUT properties, significantly improve throughput, and transform raw data into powerful graphics. The following table shows how their major features sets map into older N1010AT-xxx licenses and the newer N1010100A R&D, N1010200A MFG, and N1010300A SI packages.

Feature Description	Legacy	R&D	MFG	SI
Advanced Amplitude Analysis/RIN/Q-Factor	300	X		
Advanced Eye Analysis	401	X		
Automatic Fixture Removal in TDR Mode	BFP			X
Enhanced Impedance and S-Parameters	202		X	X
Enhanced Jitter Analysis	200	X		
Equalizers (CTLE, DFE, LFE)	201	X		
Access to Licenses on Remote DCA	DCA	X	X	X
Independent Eye Acquisition and Analysis (FlexEye)	EFP	X	X	
PAM-N Analysis (Enhanced: all of "Basic" plus partial TDECQ/Noise/SER measurements + PAM4 Jitter)	9FP	X		
PAM-N Analysis (Basic: includes TDECQ, EW/EH, Linearity)	9FP	X	X	
Send Data to Analytics Web Service	-	X	X	X
TDEC Transmitter and Dispersion Eye Closure for NRZ	500	X	X	
TDECQ Transmitter and Dispersion Eye Closure for PAM4	TFP	X	X	
Unrestricted Data File Import	-	X		
User Defined Measurements and Operators	201	X		X
Waveform Transformations (embedding/de-embedding)	SIM	X		

Appendix

Common DCA Accessories

Keysight offers a collection of accessories for the 861xxx and N10xxx series of Digital Communication Analyzers (DCA-Xs, DCA-Ms). Popular accessories/spare parts include:

Cables:

N1027A-1C1	Coaxial RF cable, 1.85 mm, 67GHz, 100 mm
N1027A-3C1	Coaxial RF cable, 2.92 mm, 2.37 ns delay, 0.55 m length
N1027A-3C2	Coaxial RF cable, 2.92 mm, 4.33 ns delay, 1.0 m
N1027A-3C3	Coaxial RF cable, SMA, for N1076A/B data out/data in

Pick-offs, Equalizers:

N1027A-2P1	Microwave pick-off tee 1.0 mm connectors, matched pair
N1027A-2P8	Microwave pick-off tee 1.85 mm connectors, matched pair
N1027A-2P2	Microwave pick-off tee 2.4 mm connectors, matched pair
N1027A-2P3	Microwave pick-off tee 2.92 mm connectors, matched pair
N1027A-EF6	Equalizer, 2.92mm (m) to 2.92mm (f), 6dB, up to 56 GBd
N1027A-EQ3	Equalizer, 2.92mm (m) to 2.92mm (f), 3dB
N1027A-EQ6	Equalizer, 2.92mm (m) to 2.92mm (f), 6dB
N1027A-EQ9	Equalizer, 2.92mm (m) to 2.92mm (f), 9dB

Adapters, DC Blocks:

11920A/B/C	1.0 mm to 1.0 mm adapters (e.g., for N1046A)
11921E/F/G/H	1.0 mm to 1.85 mm adapters (e.g., for N1046A)
Y1900B/1B/3B	Ruggedized 1.0 mm to 1.0/1.85/2.92 mm adapters (e.g., for N1060A)
11904A/B/C/D	2.4 mm to 2.92 mm adapters (e.g., for N1092X, N1094X)
N9398C/F/G	DC blocks
11636B/C	DC coupled RF/microwave power dividers

For a comprehensive list of DCA accessories see literature number [5991-2340EN](#).

DCA Input Connectors

Product	3.5 mm	2.92 mm	2.4 mm	1.85 mm	1.0 mm	Optical	Comment
N1000A		f/f CS					
N1030A/B					m fixed (#EC1)	FC/PC	#EC1 ships with 1.0 (f) to 1.85 (f) adapter(s)
N1040A		f/f CS (#033)		f/f CS (#060)			
N1045A/B-xxF				f fixed			
N1045A/B-xxM				m fixed			
N1046A					f fixed		Ships with 1.0 (m) to 1.85 (f) adapter(s)
N1055A-3xF N1055A-3xM		f fixed m fixed					
N1055A-5xF N1055A-5xM				f fixed m fixed			
N1060A Channel A/B					m fixed		Ships with 1.0 (f) to 1.85 (f) and 1.0 (f) to 2.92 (f) adapters
N1060A PTB, Clock Out		f fixed					
N1076A/76B		f fixed					
N1077A/78B		f fixed				FC/PC	
N1090A	f SMA					FC/PC	
N1092A/B/D						FC/PC	
N1092C/E			f/f CS			FC/PC	
N1094A/B			f/f CS				#030 ships with 2.4 (f) to 2.92 (f) adapters

f/f CS: Female/female connector saver (bulkhead is male, customer can remove connector saver)

f fixed: Female fixed interface

m fixed: Male fixed interface

f SMA: Female SMA input (fixed)

FC/PC: Cleanable FC/PC interface

1.0 mm inputs ship with adapters to 1.85 mm (f) standard

DCA-M clock: Clock inputs of the N109XX DCA-M series have 2.92 female connectors

RF/Microwave Connectors

3.5 mm connector

The 3.5 mm connector was primarily developed at Hewlett Packard—now Keysight Technologies, Inc. with early manufacturing at Amphenol. Its design strategy focused on highly-rugged physical interfaces that would mate with popular SMA dimensions, allowing thousands of repeatable connections. It is mode-free to 34 GHz.

2.92 mm connector

The 2.92 mm connector mates with SMA and 3.5 mm connectors and offers mode-free performance to 40 GHz.

2.4 mm connector

The 2.4 mm connector was developed by Hewlett Packard, Amphenol, and M/A-COM for use to 50 GHz. This design eliminates the fragility of the SMA and 2.92 mm connectors by increasing the outer wall thickness and strengthening the female fingers. It can mate with SMA, 3.5 mm and 2.92 mm, with the use of precision adapters. The 2.4 mm product is offered in three quality grades: general purpose, instrument, and metrology. General-purpose grade is intended for economy use on components, cables, and microstrip where limited connections and low repeatability is acceptable. Instrument-grade is best suited for measurement applications where repeatability and long life are primary considerations. Metrology-grade is best suited for calibration applications where the highest performance and repeatability are required.

1.85 mm connector

The 1.85 mm connector was developed in the mid-1980s by Hewlett Packard (now Keysight Technologies) for mode-free performance to 65 GHz. Hewlett Packard offered their design as public domain in 1988 to encourage standardization of connector types; a few devices are available from various manufacturers for research work. The 1.85 mm connector mates with the 2.4 mm connector and has the same ruggedness. In recent years, the 1.85 mm connector has been optimized to operate mode-free to 67 GHz.

1.0 mm connector

The 1.0 mm connector was designed for ultra-high frequency coaxial signals DC to at least 110 GHz. It utilizes an air dielectric interface for the highest accuracy and repeatability. The coupling diameter and thread size were chosen to maximize strength, increase durability and provide highly repeatable connections. The connector is designed so that the outer conductor engages before the center conductor.

Literature References

Generic literature link: literature.cdn.keysight.com/litweb/pdf/<literature number>.pdf

Data Sheet	Literature #
DCA Family Brochure (Solutions overview)	5992-3301EN
86100D DCA-X Mainframe and Modules Technical Specifications	5990-5824EN
N1000A DCA-X Mainframe and Modules Technical Specifications	5992-3271EN
N109XX DCA-M Technical Specifications	5992-1454EN
N107XX Clock Recovery Technical Specifications	5992-1620EN
DCA Accessories	5991-2340EN
DCA Configuration Guide	5992-3372EN
FlexDCA Technical Overview	5992-3319EN

Web Resources

Generic: www.keysight.com/find/<product number> for any product number mentioned here

DCA-X Mainframe:

www.keysight.com/find/dcax

DCA-M standalone:

www.keysight.com/find/dcam

FlexDCA (main page)

www.keysight.com/find/flexdca_pro

FlexDCA (download page)

www.keysight.com/find/flexdca_download

Clock recovery:

www.keysight.com/find/cdr

Learn more at: www.keysight.com

For more information on Keysight Technologies' products, applications or services, please contact your local Keysight office. The complete list is available at: www.keysight.com/find/contactus

