

# R&S®NRP Power Meter Family

## Trust your power measurements



# R&S®NRP Power Meter Family At a glance

The most important features for accurate and uncomplicated power measurements are top measurement accuracy and speed as well as simple operation on a base unit or a laptop/PC. The R&S®NRP power meter family combines all these characteristics in the R&S®NRP2 base unit, R&S®NRPV virtual power meter PC software and a comprehensive portfolio of USB-capable power sensors. The R&S®NRP family is ideal for use in production, R&D and calibration labs as well as for installation and maintenance tasks.

All R&S®NRP-Zxx power sensors are independent measuring instruments. Using an USB adapter, they can be directly connected to a laptop/PC and operated via the R&S®NRPV software.

The compact, robust R&S®NRP2 base unit with color display supports up to four R&S®NRP-Zxx power sensors and all sensor-dependent measurement functions. Measured values are displayed numerically or graphically, depending on the measurement function. The window-based user interface allows simple, intuitive operation; the base unit can be remotely controlled via Ethernet, GPIB or USB.

## Key facts

- Cost-effective and compact: sensor operation on a laptop/PC via USB
- Comprehensive portfolio for power measurements from DC to 110 GHz, from -67 dBm to +45 dBm
- 90 dB dynamic range with three-path diode power sensors
- Precise analysis of the envelope power with wideband power sensors
- Top accuracy with thermal power sensors
- Up to four R&S®NRP-Zxx power sensors can be simultaneously connected to the R&S®NRP2 base unit



# R&S®NRP

## Power Meter Family

### Benefits and key features

#### R&S®NRP-Zxx power sensors

- ▮ The right sensor for all applications
  - ▮ Versatile measurement functions
  - ▮ Simply plug in and measure
  - ▮ Minimize measurement uncertainty
  - ▮ Enhanced auto averaging filter
  - ▮ Easy system integration
  - ▮ Multiple ways to operate R&S®NRP-Zxx power sensors
- ▷ [page 4](#)

#### R&S®NRP2: versatile, user-friendly base unit

- ▮ Straightforward numerical and graphical display of measured values, plus intuitive operation
  - ▮ Hardware interfaces for remote control and triggering
  - ▮ Emulation of other common power meters
  - ▮ Expandable to up to four measurement channels
- ▷ [page 18](#)

#### R&S®NRPV: convenient power measurements via PC application

- ▮ Sophisticated PC application
  - ▮ Multifunctional trace mode window
  - ▮ Extremely flexible marker functions
  - ▮ Intelligent licensing concept: dongle-free on multiple PCs
- ▷ [page 20](#)

Versatile use of the R&S®NRP-Zxx power sensors						
Sensor type	Features	Available measurement functions				
		Continuous average mode	Trace mode	Timeslot/time gate mode	Burst average mode	Statistical mode
R&S®NRP-Z11/-Z2x/-Z31 three-path diode power sensors ▷ <a href="#">page 8</a>	fast, accurate and packed with features to measure CW and modulated signals	•	•	•	•	–
R&S®NRP-Z211/-Z221 two-path diode power sensors ▷ <a href="#">page 10</a>	cost-effective power measurement solution for production	•	•	•	•	–
R&S®NRP-Z8x wideband power sensors ▷ <a href="#">page 11</a>	time domain analysis and automatic pulse analysis for radar applications and universal use	•	•	•	•	•
R&S®NRP-Z5x thermal power sensors ▷ <a href="#">page 13</a>	most accurate power measurements for reference applications and use in calibration labs	•	–	–	–	–
R&S®NRP-Z91/-Z92 average power sensors ▷ <a href="#">page 15</a>	accurate average power measurements for EMC applications	•	–	–	–	–
R&S®NRP-Z28/-Z98 level control sensors ▷ <a href="#">page 16</a>	highly accurate signal level generation in conjunction with a signal generator	•	• <sup>1)</sup>	• <sup>1)</sup>	• <sup>1)</sup>	–
R&S®NRP-Z271/-Z37 power sensor modules ▷ <a href="#">page 17</a>	level calibration of signal sources in conjunction with the R&S®FSMR measurement receiver	•	–	–	–	–

<sup>1)</sup> R&S®NRP-Z28 only.

# R&S®NRP-Zxx

## power sensors

### The right sensor for all applications

Rohde&Schwarz offers a comprehensive portfolio of power sensors including multipath sensors, thermal sensors, wideband sensors and sensors for special applications. The individual sensors differ in terms of dynamic range, measurement accuracy and measurement functionality.

Thanks to their wide dynamic and frequency range, the R&S®NRP-Z11/-Z2x/-Z3x diode power sensors with patented three-path technology can be used in many applications. The sensors feature high measurement accuracy and speed and offer a wide range of measurement functions.

For applications in production, the R&S®NRP-Z211/-Z221 two-path sensors with slightly reduced dynamic range and performance are a cost-effective alternative to the three-path sensors.

Due to their high video bandwidth, the R&S®NRP-Z8x wideband power sensors permit accurate time domain analysis of the envelope power. Analysis is fast and easy thanks to additionally integrated measurement functions such as automatic pulse analysis.

The R&S®NRP-Z5x thermal power sensors feature outstanding measurement accuracy and are the first choice for power measurements in the frequency range from DC to 110 GHz as performed in calibration labs, where measurement accuracy is the key requirement.

The R&S®NRP-Z91/-Z92 average power sensors were specially developed for EMC applications and cover the required frequency range from 9 kHz to 6 GHz.

### USB-capable R&S®NRP family

The R&S®NRP family is the only power sensor portfolio worldwide in which every sensor can be connected to a laptop/PC via USB.

The sensors function as independent measuring instruments and are completely characterized over frequency, level and temperature.

Only a display unit, such as the R&S®NRP2 base unit, a laptop/PC or supported Rohde&Schwarz instrument, is required to view measurement results.

The robust USB protocol handles communications between power sensor and display unit, eliminating measurement errors that could result from transferring measurement data. The USB interface also allows users to operate all sensors directly on a PC via the R&S®NRP-Z4 adapter cable.



### Versatile measurement functions

- Continuous average mode: reliable average power measurements on CW and modulated signals; supported by all R&S®NRP power sensors
- Burst average mode: burst average power measurements; sensors automatically detect start and end of burst
- Trace mode: display of envelope power versus time

- Timeslot mode: timeslot average power measurements on TDMA-based signals (e.g. GSM/EDGE, DECT)
- Time gate mode: average power measurements in up to four independent gates with individual time position and length
- Statistic mode: display of CCDF, CDF and PDF for analyzing noise-like CDMA (3GPP) and OFDM (LTE) signals

Timeslot measurement of a GSM signal with exclude times at the edges of the timeslot.



Numerical display of two continuous average measurements and their relation.

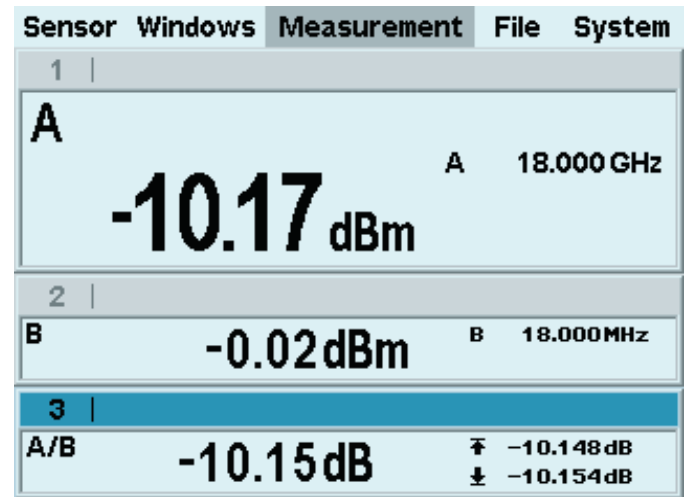

Determination of the power of an EDGE burst with the R&S®NRP-Z81 wideband power sensor using the gate function; exclusion of the training sequence in the center of the signal.

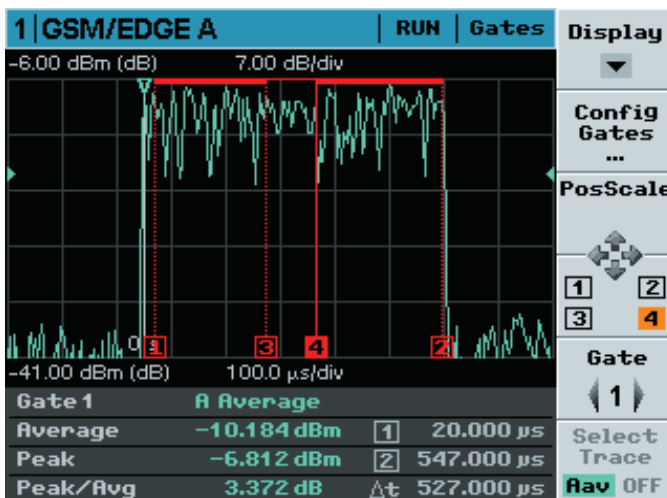

Signal statistics: CCDF of a 3GPP EUTRA/LTE signal; one million samples were recorded by the R&S®NRP-Z81 wideband power sensor within 25 ms at 30 MHz video bandwidth.



## Simply plug in and measure

The R&S®NRP power sensors are immediately ready for use. Contrary to conventional power sensors, no calibration is required prior to making measurements since the sensors are completely characterized over frequency, level and temperature and feature long-term stability. All calibration data is stored in the sensor. The sensors function as independent measuring instruments and can be operated on the R&S®NRP2 base unit, a laptop/PC or other instruments from Rohde&Schwarz (e.g. signal generators). Usually, no zeroing is required. Users can simply plug in the sensor and start measuring.

## Minimize measurement uncertainty

Even complex test setups represent no challenge for the R&S®NRP family of power sensors. Interfering effects like cable losses and reflections can be compensated using offset, S-parameter and  $\Gamma$  correction. Offset correction helps to take into account nonfrequency-dependent attenuation. S-parameter correction is used to mathematically shift the reference plane directly to the device under test (DUT) by taking into account the S-parameters for any component connected upstream.  $\Gamma$  correction makes it easy to compensate for the effects of impedance mismatch.

## Enhanced auto averaging filter

With fixed noise averaging (an enhanced auto averaging function), any measurement can be optimized with respect to measurement time and accuracy. The averaging filter is dynamically set to the optimum averaging value to achieve user-definable maximum noise content. This helps to achieve the shortest possible measurement time and the maximum production throughput with a specified accuracy, and to simplify the programming of remotely controlled measurement sequences.

## Easy system integration

The R&S®NRP2 base unit and all R&S®NRP-Zxx power sensors are easily integrated into automated test setups with the available drivers (LabView, LabWindows/CVI and VXI). The R&S®NRP2 base unit can be remotely controlled via GPIB, LAN or USB.

### Shifting the measurement plane from 1 to 2 by using S-parameter correction; the influence of additional components is compensated

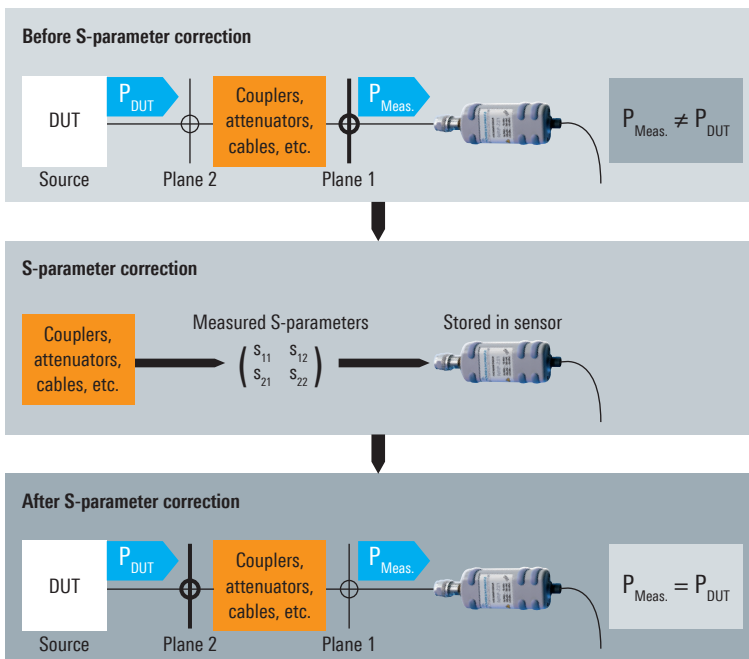

## Multiple ways to operate R&S®NRP-Zxx power sensors

The power sensors can be operated either on an R&S®NRP2 base unit or directly on a laptop/PC. They are also supported by numerous signal generators, signal analyzers, spectrum analyzers and network analyzers from Rohde & Schwarz.

The R&S®NRP-Z4 passive USB adapter cable is all that is needed to connect the sensors to a laptop/PC. To measure power levels below the minimum trigger threshold, an external trigger signal is required. This signal can be conveniently supplied via the trigger input of the R&S®NRP-Z3 active USB adapter cable or the R&S®NRP-Z5 sensor hub.

The sensor hub allows users to connect up to four sensors to a laptop/PC without additional adapters and to simultaneously start the measurements using an external trigger signal.

Standalone operation of several R&S®NRP-Zxx power sensors over a long distance using the R&S®NRP-Z5 sensor hub and a USB extender.

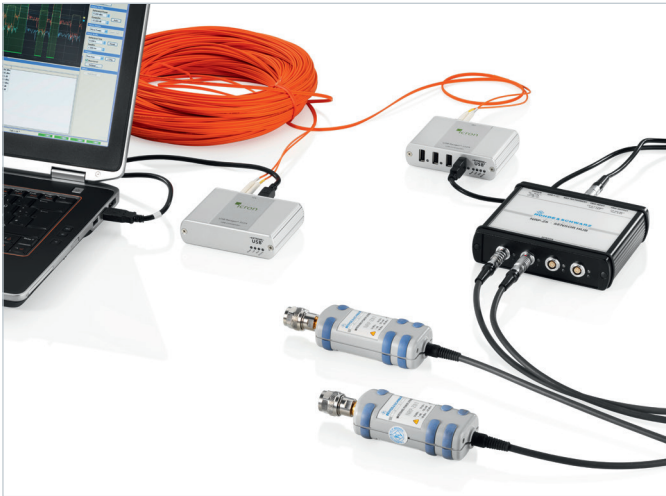

## Wide choice of ways to operate the power sensors

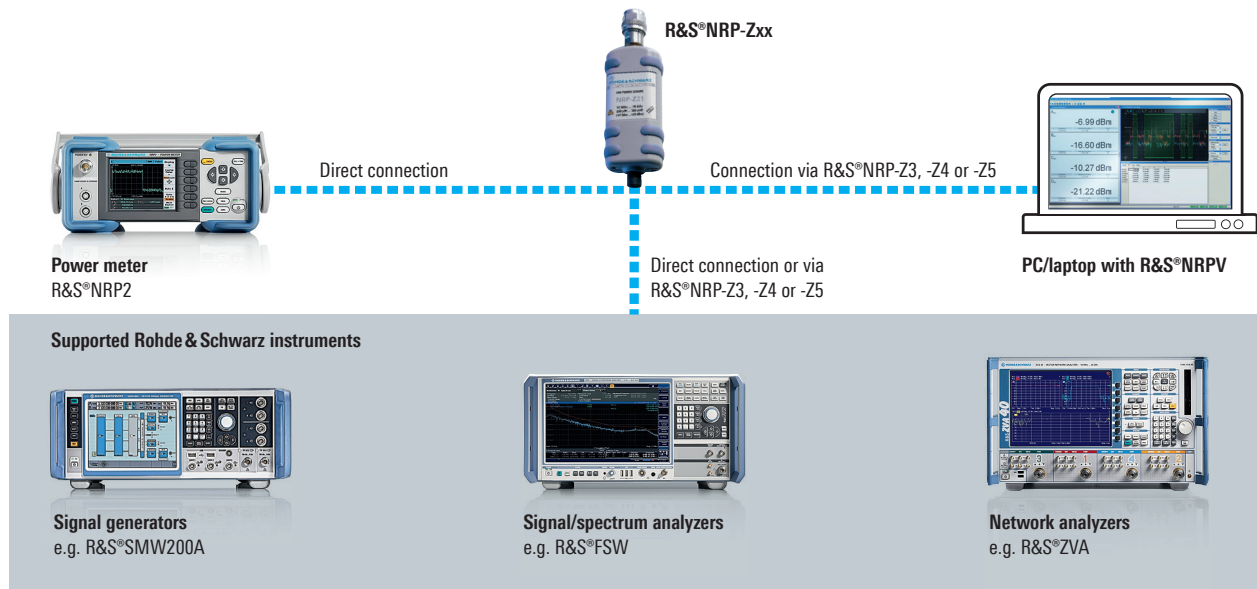

# Three-path diode power sensors

## Ideal for universal applications

Three-path diode power sensors are suitable for numerous applications because they support continuous average, burst average, timeslot average, gate average and trace measurements.

Featuring outstanding performance, high measurement speed and accuracy, the sensors can be used to perform precise average power measurements on modern wireless standard signals such as LTE, 3GPP, GSM, WiMAX™ and WLAN. For detailed analysis of GSM signals, for example, the sensors offer additional measurement functions such as the timeslot mode and trace mode with a video bandwidth of 100 kHz.

Due to its frequency range of up to 33 GHz, the R&S®NRP-Z31 is ideal for use in the automotive sector, for example in the development and production of distance and anti-collision radars (24 GHz). It is also perfect for installation and maintenance work on base stations of satellite systems.

Sensor type	Frequency range	Measurement range	Connector type
R&S®NRP-Z11	10 MHz to 8 GHz	-67 dBm to +23 dBm	N
R&S®NRP-Z21	10 MHz to 18 GHz	-67 dBm to +23 dBm	N
R&S®NRP-Z22	10 MHz to 18 GHz	-57 dBm to +33 dBm	N
R&S®NRP-Z23	10 MHz to 18 GHz	-47 dBm to +42 dBm	N
R&S®NRP-Z24	10 MHz to 18 GHz	-42 dBm to +45 dBm	N
R&S®NRP-Z31	10 MHz to 33 GHz	-67 dBm to +23 dBm	3.5 mm

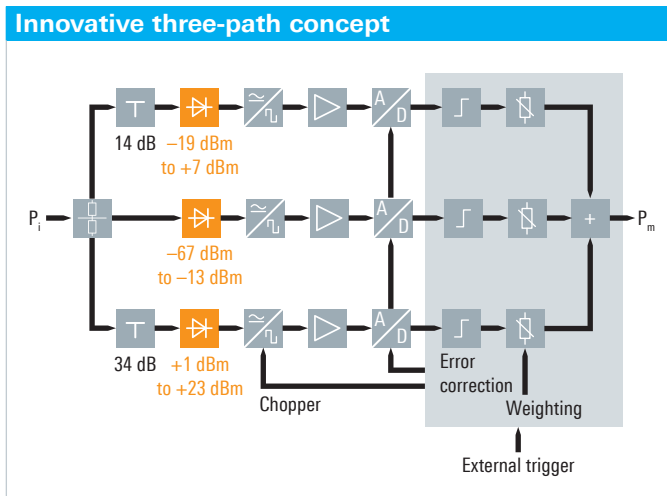

R&S®NRP-Z11/-Z21/-Z31 three-path diode power sensors.

### 90 dB dynamic range thanks to innovative three-path concept

The three-path concept of the R&S®NRP-Z11/-Z2x/-Z3x power sensors uses three separate diode paths, each operated in the optimum detector range. As a result, the average power can be determined with high accuracy independent of the modulation type. Measurement results are hardly affected by interfering signals or harmonics. This behavior is similar to the behavior of thermal power sensors. The dynamic range is 90 dB with a lower measurement limit of -67 dBm.

In contrast to conventional multipath technology, adjacent diode paths overlap by 6 dB each. All paths are continuously and simultaneously measured. The final measurement result is achieved by appropriately weighting the measurement results of all paths, which ensures a smooth transition between measurement paths. Problems due to hard switching between the measurement paths, such as additional measurement delays and differential nonlinearity, are eliminated. The patented sensor architecture also improves the signal-to-noise ratio and increases measurement speed in the transition region.

### High-power sensors

The R&S®NRP-Z22/-Z23/-Z24 high-power sensors consist of an R&S®NRP-Z21 and a detachable upstream attenuator and are able to perform power measurements of up to 2 W, 15 W and 30 W. After removing the attenuator, the sensor can be used alone as an R&S®NRP-Z21.

When used with the attenuator, mismatch errors between sensor and attenuator are automatically corrected. The S-parameters for the attenuator are determined and stored in the sensor during production. They are then automatically taken into account when performing measurements.



R&S®NRP-Z22/-Z23/-Z24 three-path diode power sensors for high-power applications up to 30 W.

# Two-path diode power sensors

**Cost-effective solution for production applications**

The R&S®NRP-Z211/-Z221 two-path diode power sensors combine all key characteristics relevant for their use in production. They are cost-effective, fast, precise and USB-capable. The sensors support the same measurement functions as the R&S®NRP-Z111/-Z2x/-Z3x three-path diode power sensors and offer the best price/performance ratio in their class.

**Mid-class sensor with tried and tested technology**

The two-path diode power sensors use the tried and tested Rohde&Schwarz multipath technology. With two overlapping diode paths measured in parallel and a wide dynamic range of 80 dB, the power sensors feature high measurement accuracy and speed.

Sensor type	Frequency range	Measurement range	Connector type
R&S®NRP-Z211	10 MHz to 8 GHz	-60 dBm to +20 dBm	N
R&S®NRP-Z221	10 MHz to 18 GHz	-60 dBm to +20 dBm	N



R&S®NRP-Z211/-Z221 two-path diode power sensors.



# Wideband power sensors

## Ideal for radar applications

The R&S®NRP-Z8x wideband power sensors are ideal for radar applications. In development or during installation and maintenance, pulse characteristics as well as output power have to be measured. Similar measurements are required in the production of radar systems and radar components. Thanks to a maximum video bandwidth of 30 MHz and a rise/fall time < 13 ns, the sensors can measure pulses with a pulse width as small as 50 ns.

## Use up to 44 GHz

The R&S®NRP-Z8x wideband power sensors are ideal for power measurements on microwave link modules. Especially the R&S®NRP-Z86 model .44 (upper frequency limit of 44 GHz) can be used for the development, production, installation and maintenance of the latest generation of microwave link modules. The user benefits from the sensor's high measurement speed and large dynamic range.

## Outstanding dynamic range and accuracy

The dynamic range of the R&S®NRP-Z8x wideband power sensors yields a lower limit of -47 dBm for envelope power measurements and -60 dBm for average power measurements. This sensitivity is unique and so far unprecedented on the market. Users benefit from enhanced reproducibility and high measurement speed.

These sensors are therefore ideal for analyzing envelope power as well as for measuring average power.

## High resolution mode

Some applications require the display of strongly magnified signal sections such as the rising edge of a pulse. To improve the graphical display in the trace mode, which has a resolution of 12.5 ns, a high density of samples is required. Equivalent time sampling with repetitive signals can achieve a time resolution of up to 100 ps.

## Highest measurement speed

The R&S®NRP-Z8x wideband power sensors are the world's fastest sensors. In buffered mode, a specified measurement speed of > 9000 measurements/s can be achieved.

Sensor type	Frequency range	Measurement range	Connector type
R&S®NRP-Z81	50 MHz to 18 GHz	-60 dBm to +20 dBm	N
R&S®NRP-Z85	50 MHz to 40 GHz	-60 dBm to +20 dBm	2.92 mm
R&S®NRP-Z86, model .40	50 MHz to 40 GHz	-60 dBm to +20 dBm	2.4 mm
R&S®NRP-Z86, model .44	50 MHz to 44 GHz	-60 dBm to +20 dBm	2.4 mm



R&S®NRP-Z81/-Z85/-Z86 wideband power sensors.

## Automatic pulse analysis

Automatic pulse analysis supports users in measuring important pulse parameters. It eliminates the need for complex measurements using markers; changes in the pulse shape are immediately taken into account in the measurement results.

The following parameters are determined by automatic pulse analysis:

- Time parameters: rise/fall time, start/stop time, pulse width, duty cycle, pulse period, pulse off time
- Level parameters: pulse top, pulse base, peak, average, minimum, overshoot (positive and negative)

## Statistical analysis

The R&S®NRP-Z8x wideband power sensors permit statistical analysis of the amplitude distribution of noise-like signals to determine key parameters such as peak envelope power, average power and peak-to-average power ratio. The measurement data supports the design of components for modern OFDM or CDMA based wireless systems, such as EUTRA/LTE and 3GPP FDD. A measurement of the CCDF, CDF or PDF using one million samples can be performed by the R&S®NRP-Z8x wideband power sensors in less than 25 ms at full video bandwidth.

It is also possible to perform statistical analysis on an individually configured time gate so that only specific signal sections are observed.

## Trigger master mode (with base unit or R&S®NRP-Z5)

Combined with the R&S®NRP2 base unit or the R&S®NRP-Z5 sensor hub, an R&S®NRP-Z8x wideband power sensor can be used as a trigger source. In the trigger master mode, a trigger signal is derived from the measured signal inside the power sensor and forwarded to the base unit or sensor hub for further use. All other connected sensors can be externally triggered using this trigger signal. An additional external trigger source is not required. This feature can be used for determining the input and output level of power amplifiers when the level at the input is too low for an internally triggered measurement, yet the level at the output is sufficient. In this case, an R&S®NRP-Z8x used for measuring the output signal acts as the trigger master to trigger the input signal measurement.

### Time parameters

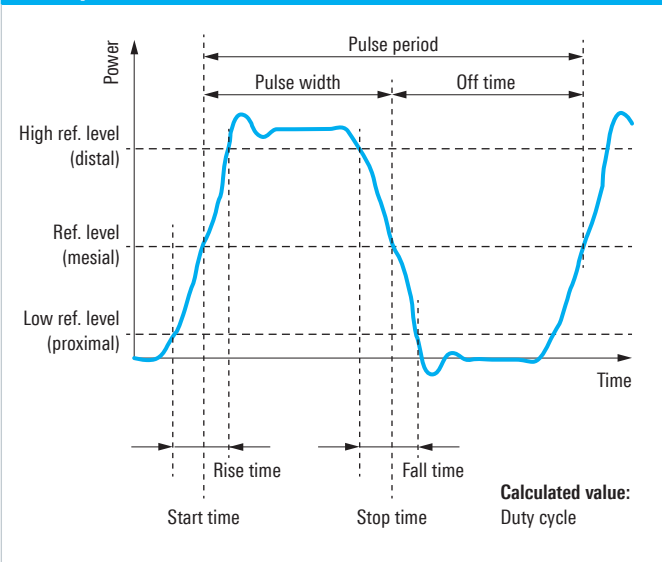

### Level parameters

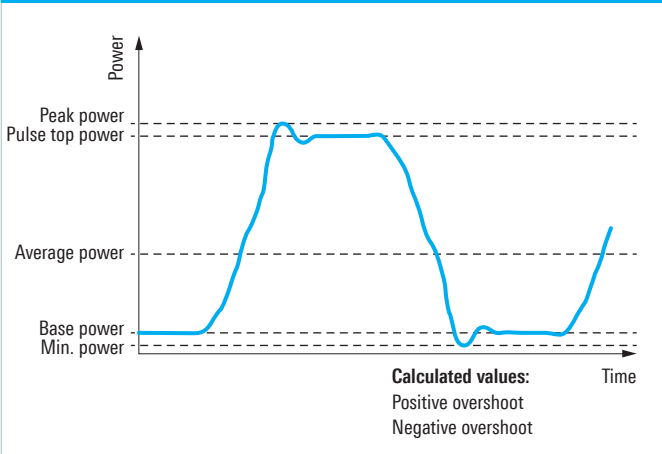

# Thermal power sensors

## Outstanding performance for reference applications

Thermal power sensors are especially used for complex measurement tasks where highest accuracy counts. They tolerate any type of modulation.

To improve measurement accuracy, the hardware of the R&S®NRP-Z5x thermal power sensors is designed to reduce measurement noise to a minimum and to make the sensor immune to thermal environmental effects.

To achieve stable measurement results, the temperature in the thermal test cell must correspond to the applied power. When the power is increased, the measurement cell of the R&S®NRP-Z5x thermal power sensors quickly attains a stable temperature. When the power level is decreased, the excess heat is dissipated extremely quickly. Thermal power sensors from Rohde&Schwarz are able to measure three times faster than comparable solutions on the market with triggered measurements and > 500 measurements/s in buffered mode – with top accuracy.

The R&S®NRP-Z5x thermal power sensors feature an unparalleled linearity of 0.007 dB (0.16 %) up to 67 GHz and 0.010 dB (0.23 %) between 67 GHz and 110 GHz, making them the ideal choice for performing relative measurements.

These sensor characteristics are particularly beneficial in reference applications and calibration labs.

## Excellent impedance matching

To a large extent, measurement uncertainty results from multiple reflections at the source and power sensor caused by mismatch. To minimize these reflections, all thermal power sensors in the R&S®NRP family are excellently matched up to high frequencies, reducing measurement uncertainty.

Sensor type	Frequency range	Measurement range	Connector type
R&S®NRP-Z51	DC to 18 GHz	-35 dBm to +20 dBm	N
R&S®NRP-Z52	DC to 33 GHz	-35 dBm to +20 dBm	3.50 mm
R&S®NRP-Z55, model .03	DC to 40 GHz	-35 dBm to +20 dBm	2.92 mm
R&S®NRP-Z55, model .04	DC to 44 GHz	-35 dBm to +20 dBm	2.92 mm
R&S®NRP-Z56	DC to 50 GHz	-35 dBm to +20 dBm	2.40 mm
R&S®NRP-Z57	DC to 67 GHz	-35 dBm to +20 dBm	1.85 mm
R&S®NRP-Z58	DC to 110 GHz	-35 dBm to +20 dBm	1 mm



R&S®NRP-Z5x thermal power sensors.

### Sophisticated connector concept

Thanks to the innovative connector design, the sensor can be easily screw-connected to the signal source to be measured. A ball bearing in the coupling nut ensures that only the coupling nut has to be turned to tighten the sensor. The sensor body stays fixed in the required position. Contrary to conventional connecting screws, the outer conductors of the sensor and DUT are not turned relative to each other and so their mating surfaces do not rub together. This reduces wear and enhances reproducibility of measurements. The connector concept contributes to high measurement accuracy.

### Internal calibration test

Rohde&Schwarz has implemented a special verification function in the R&S®NRP-Z5x sensors. This function covers all essential components of the signal path. Using a test routine, the sensor's response to a highly stable applied DC power is measured and compared against the value stored during the previous calibration. The result provides information about the functionality and accuracy of the power sensor. Two additional advantages: The power sensor can remain on site during verification, and verification can even be performed while another measurement is carried out.

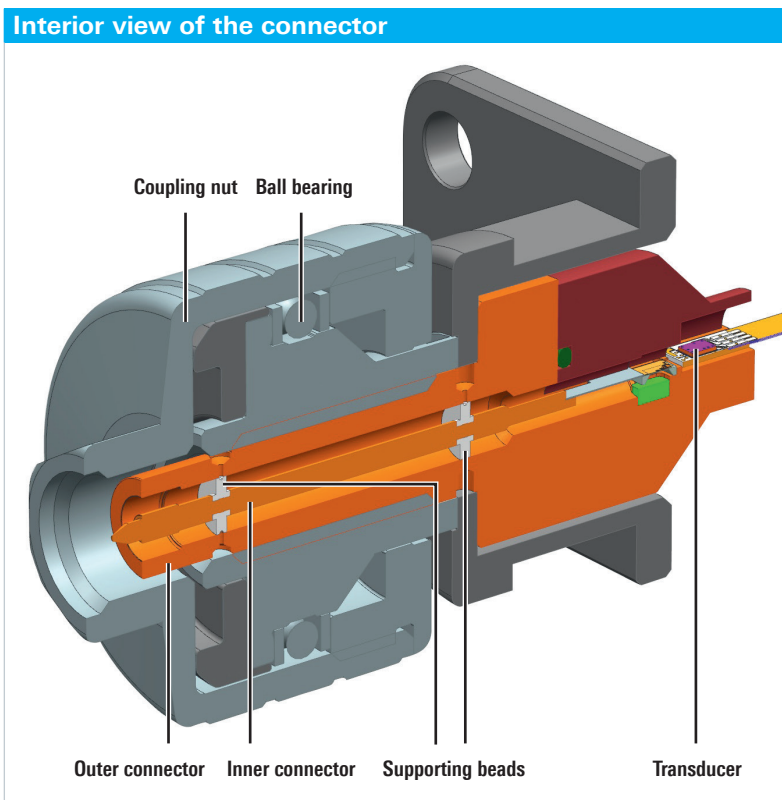

# Average power sensors

## Specially designed for EMC applications

In EMC applications, usually only the average power is of interest. This is where the R&S®NRP-Z91/-Z92 average power sensors are the perfect fit. They cover measurement ranges that are used in radio telecommunications (up to 6 GHz) as well as the important lower frequency bands (down to 9 kHz). Users benefit from the excellent properties of the three-path diode power sensors, including a dynamic range of up to 90 dB, very low influence of the modulation on the measurement and outstanding impedance matching.

Sensor type	Frequency range	Measurement range	Connector type
R&S®NRP-Z91	9 kHz to 6 GHz	-67 dBm to +23 dBm	N
R&S®NRP-Z92	9 kHz to 6 GHz	-57 dBm to +33 dBm	N



R&S®NRP-Z91/-Z92 average power sensors.

# Level control sensors

## Feeding accurate power level to a device under test (DUT)

The R&S®NRP-Z28/-Z98 level control sensors were developed especially to feed power to the DUT and monitor the power at the same time. The sensor's integrated power splitter splits the signal into two parts of equal power. One part is measured by the integrated power sensor and displayed on a Rohde&Schwarz signal generator, on the R&S®NRP2 base unit or on a laptop/PC. The other part, which is identical to the measured part, is output at the sensor's RF output and can be directly fed to the DUT. The sensor is a permanent part of the test setup. To perform a power measurement, it is not necessary to disconnect the DUT from the RF source. Uncertainties caused by a mismatched load or the cable loss between the signal generator and the DUT are prevented by using the R&S®NRP-Z28/-Z98 level control sensors together with the automatic level correction feature of Rohde&Schwarz signal generators. Distances of up to 1.2 m are bridged by an integrated low-loss microwave cable.

Sensor type	Frequency range	Measurement range	Connector type
R&S®NRP-Z28	10 MHz to 18 GHz	-67 dBm to +20 dBm	N
R&S®NRP-Z98	9 kHz to 6 GHz	-67 dBm to +20 dBm	N

## Supplying power P into a mismatched load via a long cable

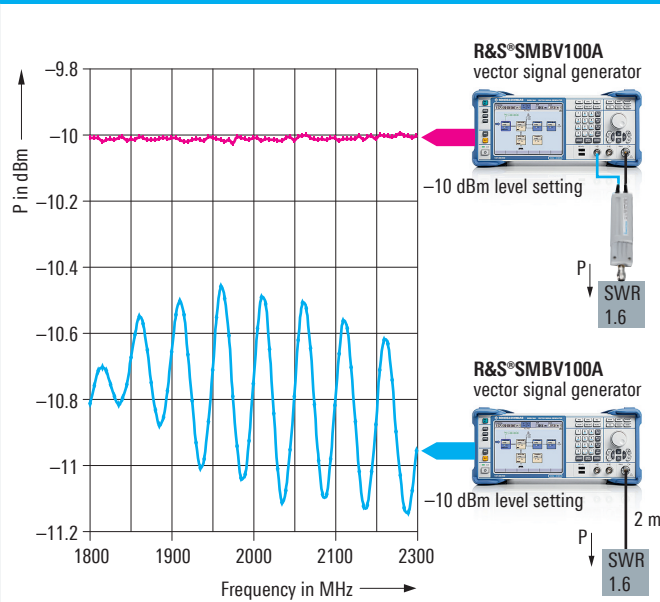

Upper graph: using the R&S®NRP-Z28, with activated user correction;  
lower graph: measurement results due to mismatch in a conventional setup

## Constant monitoring of signal generator output power and automated level correction using the R&S®NRP-Z28/-Z98 level control sensor

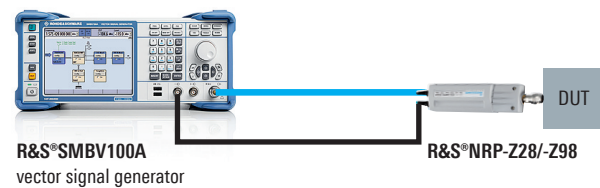

R&S®NRP-Z28/-Z98 level control sensors.



# Power sensor modules

## Solution for accurate level calibration

The R&S®NRP-Z27/-Z37 power sensor modules turn the R&S®FSMR measuring receivers into precision power meters with a wide dynamic range from -115 dBm to +30 dBm.

The R&S®NRP-Z27 and -Z37 power sensor modules were developed especially for level calibration using the R&S®FSMR measuring receiver. These sensors act as highly accurate references for determining the absolute power level. Together with the excellent linearity of the R&S®FSMR, this enables precise power calibration over the entire level range of the measuring receiver. Using an integrated power splitter, the power is fed to the integrated R&S®NRP-Z27/-Z37 thermal power sensor module and simultaneously to the measuring receiver via a phase-stable cable.

Like all other power sensors of the R&S®NRP family, the power sensor module is a fully self-contained power meter that is remotely controlled from the R&S®FSMR, R&S®NRP2 or any Windows PC via USB.

Sensor type	Frequency range	Measurement range	Connector type
R&S®NRP-Z27	DC to 18 GHz	-24 dBm to +26 dBm	N
R&S®NRP-Z37	DC to 26.5 GHz	-24 dBm to +26 dBm	3.5 mm

## R&S®FSMR measuring receiver with R&S®NRP-Z27/-Z37 power sensor module

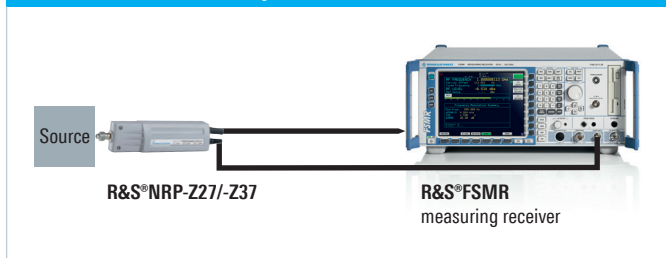

R&S®FSMR measuring receiver with R&S®NRP-Z27 power sensor module.



R&S®NRP-Z27/-Z37 power sensor modules.

# R&S®NRP2: versatile, user- friendly base unit

Numerical display.

Sensor	Windows	Measurement	File	System
1				
A		<b>-6.57 dBm</b>	↔	-6.573 dBm
2				
B		<b>55.0 μW</b>	↕	55.017 μW 54.943 μW
3				
RC (A,B)		<b>0.500</b>	A	1.000 GHz B 1.000 GHz
4				
B Rel		<b>-45.0%</b>	B	1.000 GHz

Automatic pulse analysis with the R&S®NRP-Z81.

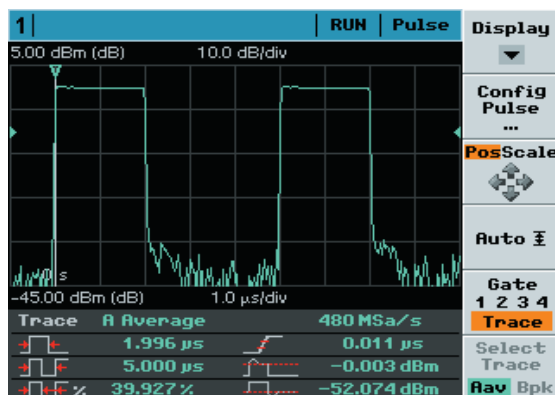

R&S®NRP2 power meter with connected R&S®NRP-Zxx power sensor.



## Straightforward numerical and graphical display of measured values, plus intuitive operation

The R&S®NRP2 simultaneously supports up to four power sensors of the R&S®NRP family. Function keys on the front panel provide quick access to the most important functions. Users can open the frequency setting menu or zero the connected sensors at the push of a button. The mode key provides direct access to all available measurement functions.

User-programmable save/recall memory locations allow fast access to personal settings. Presets for all major mobile radio standards, such as 3GPP LTE, 3GPP WCDMA, GSM/EDGE, WLAN and Bluetooth®, ensure correct measurement with a minimum of keystrokes.

The brilliant TFT color display supports the intuitive, window-based operating concept. Key parameters and functions are color-coded and can be seen at a glance.

Results are presented in numerical and graphical display windows that can be easily configured.

In the continuous average, burst average timeslot and time gate average measurement modes, up to four numerical results can be displayed in parallel. Ratio, SWR, return loss and reflection coefficient can be calculated from two measurement channels using predefined computation functions and displayed in addition to the absolute and relative power level.

Trace measurements and statistical measurements are presented in graphical windows. The trace mode allows simultaneous display of two traces in one measurement window. Level differences and time offset can be seen at a glance and accurately measured using horizontal and vertical markers. It is also possible to display the ratio of two traces.

Timeslots and time gates as well as the associated measurement values (average, peak or peak/average) can be graphically displayed in the trace window.

All R&S®NRP-Z8x wideband power sensors allow automatic pulse analysis. Up to six of 15 user-selected pulse parameters can be displayed in addition to the measurement trace (see page 12).

The statistical amplitude distribution of the envelope power is shown as CCDF, CDF or PDF in a statistics window.

## Hardware interfaces for remote control and triggering

The R&S®NRP2 provides three different remote interfaces for integration in automated test setups as standard: Ethernet, USB and GPIB.

A trigger input on the rear panel permits external triggering for synchronized power measurements. Using an R&S®NRP-Z81, for example, a trigger signal can be derived from the measurement signal and output at the trigger output (trigger master mode). A level-proportional voltage or a digital signal for limit monitoring can be output via BNC connectors.

Signal statistics: CDF of a 3GPP FDD signal recorded using the R&S®NRP-Z81; horizontal and vertical markers enable precise analysis (as with the PDF and CCDF).

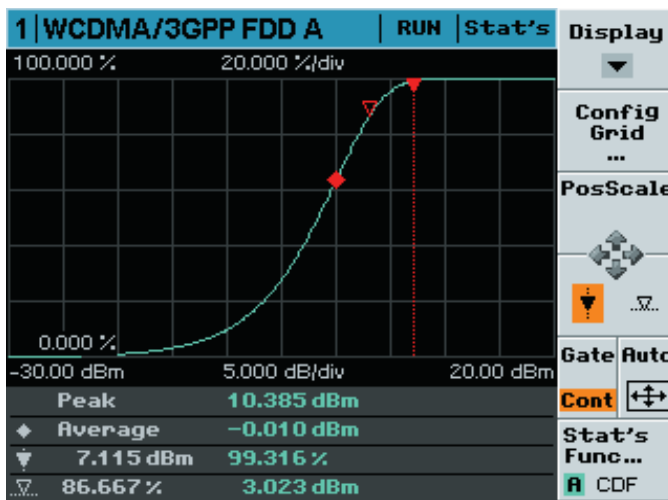

R&S®NRP2 rear view.



## Emulation of other common power meters

The R&S®NRP2 can interpret the command set of other power meters. Legacy instruments in existing systems can be quickly replaced by the R&S®NRP2 without additional programming effort. Instruments that can be emulated include the predecessor, the R&S®NRVD, and other manufacturers' instruments:

- ▮ R&S®NRVD
- ▮ HP 436A
- ▮ HP 437B
- ▮ HP 438A
- ▮ Agilent N1911A
- ▮ Agilent N1912A
- ▮ Agilent E4418B
- ▮ Agilent E4419B

## Expandable to up to four measurement channels

The R&S®NRP2 standard configuration includes one measurement channel. The base unit can be optionally expanded to two (R&S®NRP-B2) or four (R&S®NRP-B2 and R&S®NRP-B5) measurement channels. An optionally integrated 50 MHz/1 mW reference source (R&S®NRP-B1 sensor check source) can be used to check the function of the power sensors.

# R&S®NRPV: convenient power measurements via PC application

## Sophisticated PC application

In combination with the R&S®NRPV virtual power meter software, the USB capability of the R&S®NRP-Zxx power sensors can be ideally utilized. The software covers all sensor functions and supports up to four sensors connected to a laptop/PC via the R&S®NRP-Z3/-Z4 USB adapter cables or the R&S®NRP-Z5 sensor hub. The sensors are automatically detected when plugged in and added to all open measurement windows (hot plugging).

This cost-effective measurement solution supports all available measurement modes. Mathematical calculations during measurements to determine the SWR, difference or ratio are possible in the ContAv, gated average and burst average numerical modes and in the graphical trace mode.

## Multifunctional trace mode window

The trace mode is supported by all three-path diode power sensors, two-path diode power sensors and wideband power sensors. Up to four trace measurements and four mathematical traces can be simultaneously displayed in one window.

Gated measurement of two GSM/EDGE traces with the R&S®NRP-Z81.

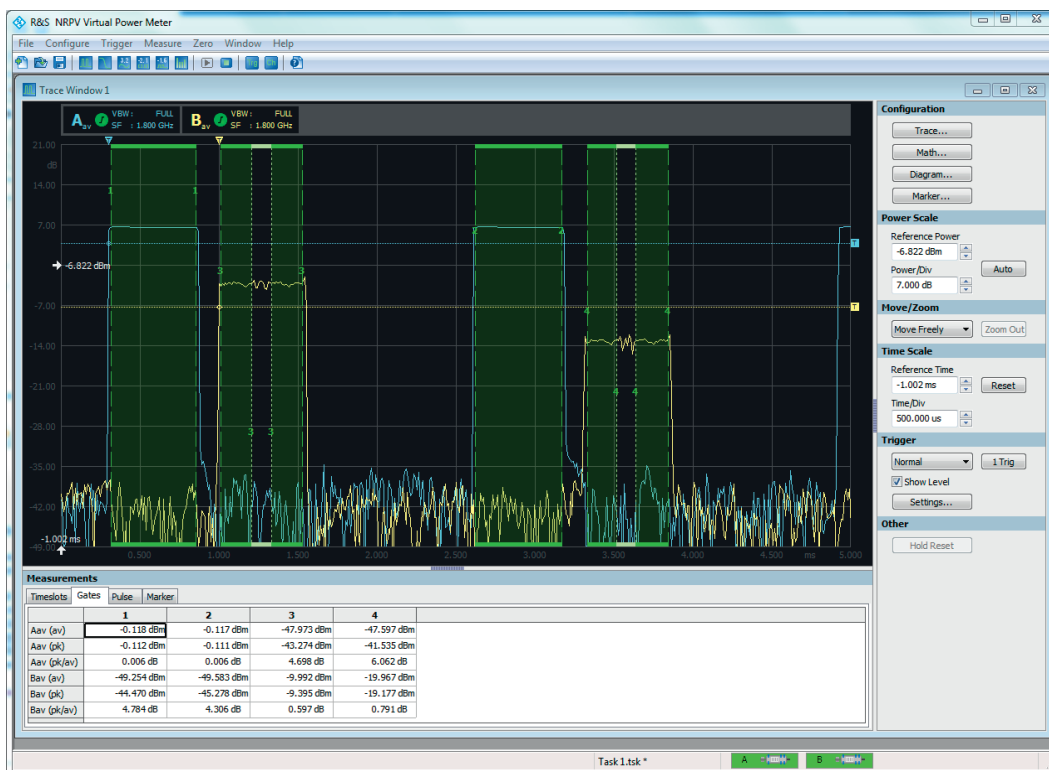

## Timeslot/time gate

Timeslot and time gate measurements are performed directly in the trace window. The R&S®NRPV virtual power meter software supports up to 16 timeslots and four independent time gates. They can be transparently displayed in the trace window. Timeslot and gate length as well as their starting position are adjusted using the mouse; measured values are displayed as a table in the measurement window.

## Automatic pulse analysis

The R&S®NRP-Z8x wideband power sensors are able to quickly and automatically analyze pulsed signals in trace mode to continuously determine the most important time and power parameters (see page 12).

## Extremely flexible marker functions

The marker function in the trace mode supports an unlimited number of markers that can be linked together as required. In addition to single markers (to measure the level at a fixed time) and double markers (to determine the level difference after a fixed time period), other functions such as automatic peak search are available.

Each marker can be used as a reference marker and functions as a reference point to determine time and level differences. Linked markers can be combined and extended as required. Since each marker is associated with a trace, markers from different traces can also be linked. The spacing between two pulses in different traces can be accurately and continuously measured, even if the pulse spacing changes.

Complex marker settings can be stored and retrieved at any time.

## Intelligent licensing concept: dongle-free on multiple PCs

The R&S®NRPV virtual power meter software can be installed on an unlimited number of laptops/PCs. For use with the R&S®NRPV software, each R&S®NRP-Zxx power sensor has to be activated individually using the sensor-related R&S®NRPZ-K1 keycode option. Once activated, the sensor can be operated on any laptop/PC. This licensing concept eliminates the need for USB dongles and does not tie a license to a specific laptop/PC.

Pulse delay measurement on different traces.

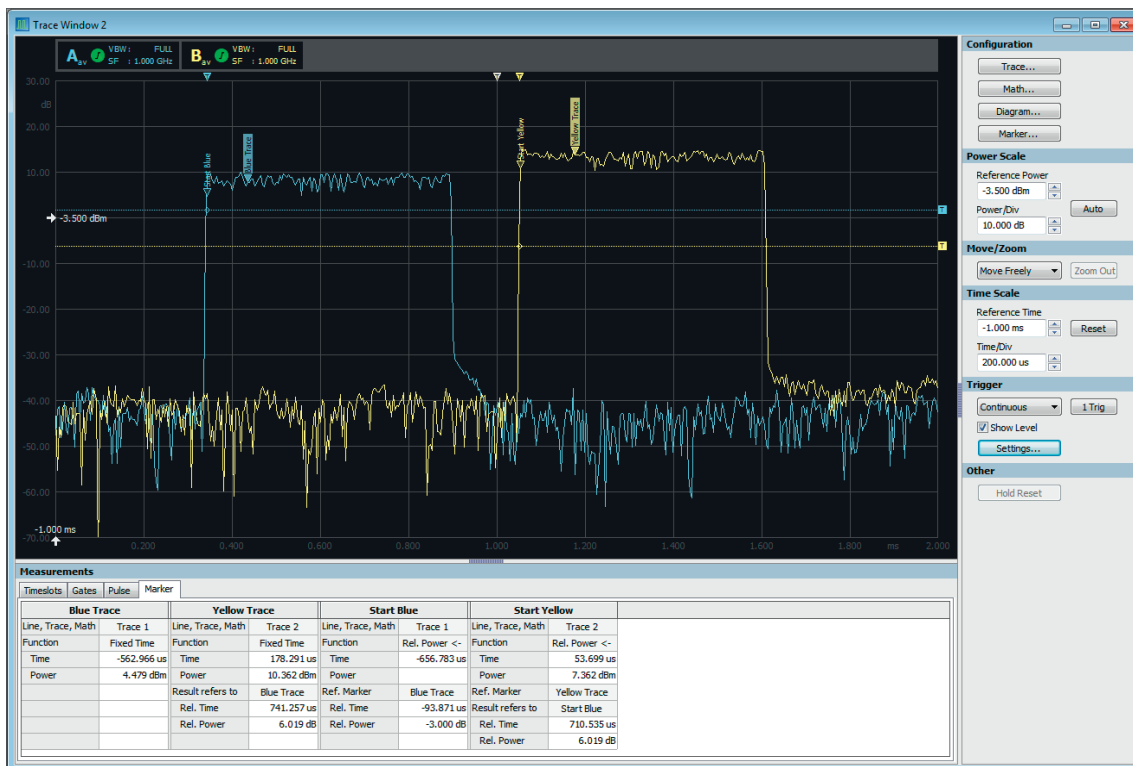



# Applications

## Accurate measurement of TDMA-based signals

The analysis of TDMA-based signals encountered in GSM/EDGE and DECT is a common application for power measurements. The R&S®NRP-Z11/-Z2x/-Z31/-Z2xx/-Z8x sensors are very powerful tools for such work. The trace mode makes graphical analysis of any signal very straightforward. The ability to easily modify the time axis plus the auto scaling function provides useful support during in-depth analysis of relevant signal components. The timeslot measurement in the trace mode allows simultaneous analysis of multiple equidistant timeslots.

Additionally, the R&S®NRP-Z11/-Z2x/-Z31/-Z2xx/-Z8x sensors support up to four independent measurement gates. Start time and length can be individually configured for each gate.

Measurement of eight timeslots in one shot with the R&S®NRPV.

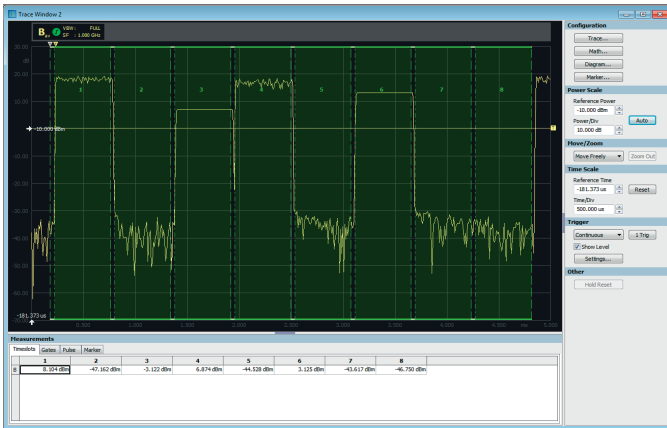

Statistical analysis of an LTE signal using the R&S®NRPV.

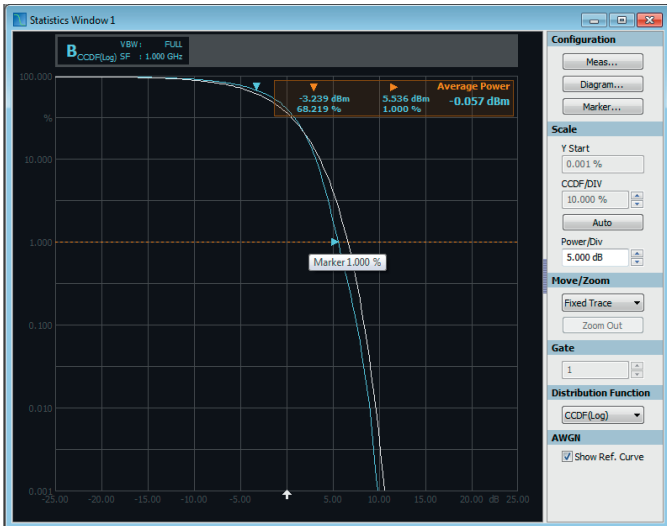

The power sensor also provides a fence function for the timeslot and time gate modes. The fence can be configured separately for each gate or globally for all timeslots. This allows the user to keep track of the power at all times during the time segments of interest. Exclude times can be set to mask interfering signal components at the edges of a timeslot.

## Power measurements in radiocommunications standards

Radiocommunications standards such as 3GPP LTE, 3GPP FDD and CDMA2000® exhibit very different power profiles depending on their channel utilization. Assessing these power profiles is a routine job with the power sensors of the R&S®NRP family. This is true no matter whether you need to accurately measure the average power, peak power, peak-to-average ratio in the time domain or you need fast statistical analysis to precisely determine the amplitude distribution.

Average power measurements are possible with all R&S®NRP-Zxx power sensors. The R&S®NRP-Z5x thermal power sensors are used when highest accuracy is required. The R&S®NRP-Z11/-Z2x/-Z31/-Z2xx/-Z9x multipath sensors perform average power measurements very quickly over a dynamic range of up to 90 dB. This is true even for signals with a high peak-to-average ratio. Thanks to the patented multipath technology, measurements are always fast and accurate even at the limits of the measurement paths. The innovative sensor architecture eliminates measurement range switching as well as the associated discontinuity in the measured values and extended measurement times.

For power analysis, the R&S®NRP-Z8x wideband power sensors are available. With a maximum video bandwidth of 30 MHz, these sensors are ideal for analyzing noise-like signals in statistic mode. Exact determination of the amplitude statistics permits accurate peak, average and crest factor measurements.

## Radar applications

The R&S®NRP-Z8x wideband power sensors with a maximum frequency of 44 GHz are ideal for time domain analysis of pulses. Automatic pulse analysis enables users to continuously monitor key pulse parameters such as rise/fall time, pulse width or pulse top without interaction. With a rise time of 13 ns, even steep edges can be measured. This performance is sufficient to measure most radar signals.

Even nonrepetitive pulse sequences where each pulse exhibits a different power level can be precisely measured.



R&S®NRP-Z8x wideband power sensors are suitable for accurate measurement of pulsed radar systems.



Using the sensor's buffered mode at < 9000 measurements/s, the measurements are performed so fast that it is possible to reliably measure the power of all pulses even in the presence of high pulse repetition rates and short pulses. This ensures reliable detection even of rarely occurring signal phenomena.

### Component tests with high throughput

In component testing, the focus is on precisely determining the input/output power, the gain and the input impedance matching of the DUT. The R&S®NRP family provides an outstanding solution for such applications. Only one R&S®NRP2 base unit with up to four measurement channels is required for the simultaneous evaluation of the results delivered by the sensors. This makes it possible to correctly measure the input and output power of a power amplifier as well as to accurately determine the gain and input impedance matching since the R&S®NRP2 base unit automatically calculates the power ratios.

### Typical test setup for multicarrier power amplifier (MCPA) tests; calculation functions of the R&S®NRP allow impedance matching and gain to be determined

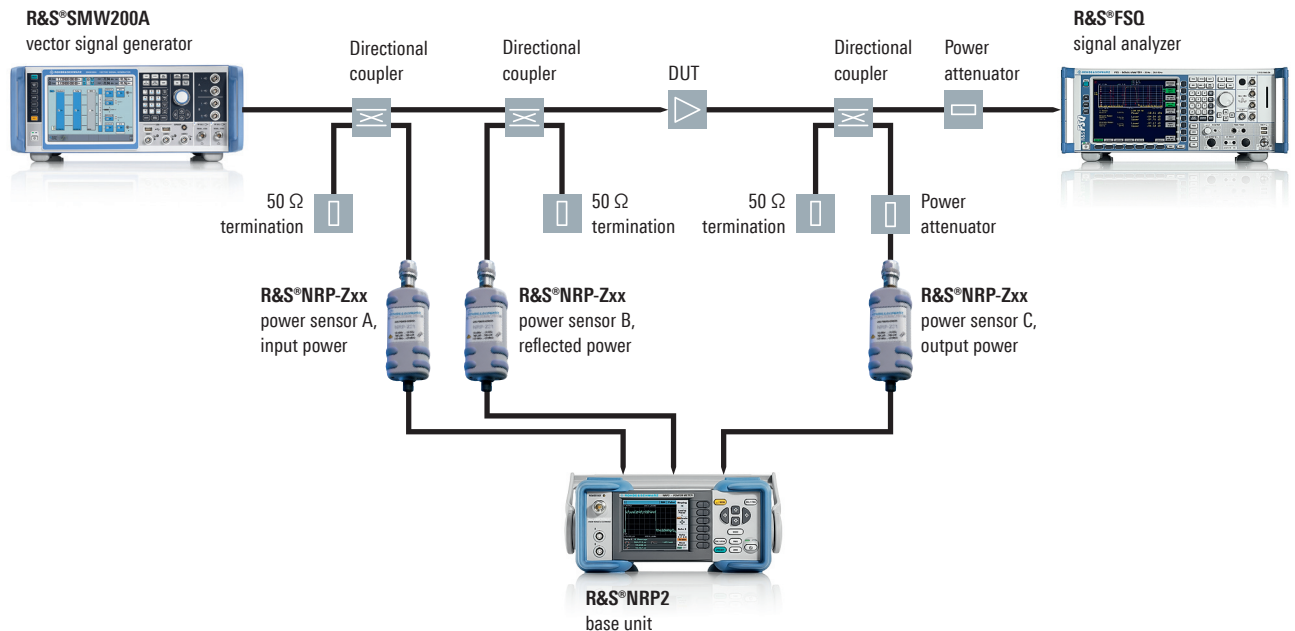

# Specifications in brief

Specifications in brief						
Sensor type, connector	Frequency range	Power measurement range, maximum input power	Impedance matching (SWR)	Rise time, video bandwidth	Uncertainty for power measurements at +20 °C to +25 °C	
					absolute (in dB)	relative (in dB)
<b>Three-path diode power sensors</b>						
R&S®NRP-Z11, N (m)	10 MHz to 8 GHz	200 pW to 200 mW (-67 dBm to +23 dBm) max. 400 mW (AVG)/ 1 W (PK, 10 µs)	10 MHz to 2.4 GHz: < 1.13 > 2.4 GHz to 8.0 GHz: < 1.20	< 8 µs > 50 kHz	0.047 to 0.083	0.022 to 0.066
R&S®NRP-Z21, N (m)	10 MHz to 18 GHz	200 pW to 200 mW (-67 dBm to +23 dBm) max. 400 mW (AVG)/ 1 W (PK, 10 µs)	10 MHz to 2.4 GHz: < 1.13 > 2.4 GHz to 8.0 GHz: < 1.20 > 8.0 GHz to 18.0 GHz: < 1.25		0.047 to 0.128	0.022 to 0.110
R&S®NRP-Z31, 3.5 mm (m)	10 MHz to 33 GHz	200 pW to 200 mW (-67 dBm to +23 dBm) max. 400 mW (AVG)/ 1 W (PK, 10 µs)	10 MHz to 2.4 GHz: < 1.13 > 2.4 GHz to 8.0 GHz: < 1.20 > 8.0 GHz to 18.0 GHz: < 1.25 > 18.0 GHz to 26.5 GHz: < 1.30 > 26.5 GHz to 33.0 GHz: < 1.35		0.051 to 0.137	0.022 to 0.118
R&S®NRP-Z22, N (m)	10 MHz to 18 GHz	2 nW to 2 W (-57 dBm to +33 dBm) max. 3 W (AVG)/ 10 W (PK, 10 µs)	10 MHz to 2.4 GHz: < 1.14 > 2.4 GHz to 8.0 GHz: < 1.20 > 8.0 GHz to 12.4 GHz: < 1.25 > 12.4 GHz to 18.0 GHz: < 1.30		0.079 to 0.178	0.022 to 0.112
R&S®NRP-Z23, N (m)	10 MHz to 18 GHz	20 nW to 15 W (-47 dBm to +42 dBm) max. 18 W (AVG)/ 100 W (PK, 10 µs)	10 MHz to 2.4 GHz: < 1.14 > 2.4 GHz to 8.0 GHz: < 1.25 > 8.0 GHz to 12.4 GHz: < 1.30 > 12.4 GHz to 18.0 GHz: < 1.41		0.078 to 0.199	0.022 to 0.110
R&S®NRP-Z24, N (m)	10 MHz to 18 GHz	60 nW to 30 W (-42 dBm to +45 dBm) max. 36 W (AVG)/ 300 W (PK, 10 µs)	10 MHz to 2.4 GHz: < 1.14 > 2.4 GHz to 8.0 GHz: < 1.25 > 8.0 GHz to 12.4 GHz: < 1.30 > 12.4 GHz to 18.0 GHz: < 1.41		0.078 to 0.222	0.022 to 0.110
<b>Two-path diode power sensors</b>						
R&S®NRP-Z211, N (m)	10 MHz to 8 GHz	1.0 nW to 100 mW (-60 dBm to +20 dBm) max. 400 mW (AVG)/ 2 W (PK, 10 µs)	10 MHz to 2.4 GHz: < 1.13 > 2.4 GHz to 8.0 GHz: < 1.20	< 10 µs > 40 kHz	0.054 to 0.110	0.022 to 0.112
R&S®NRP-Z221, N (m)	10 MHz to 18 GHz	1.0 nW to 100 mW (-60 dBm to +20 dBm) max. 400 mW (AVG)/ 2 W (PK, 10 µs)	10 MHz to 2.4 GHz: < 1.13 > 2.4 GHz to 8.0 GHz: < 1.20 > 8.0 GHz to 18.0 GHz: < 1.25		0.054 to 0.143	0.022 to 0.142
<b>Wideband power sensors</b>						
R&S®NRP-Z81, N (m)	50 MHz to 18 GHz	1 nW to 100 mW (-60 dBm to +20 dBm) max. 200 mW (AVG)/ 1 W (PK, 1 µs)	50 MHz to 2.4 GHz: < 1.16 > 2.4 GHz to 8.0 GHz: < 1.20 > 8.0 GHz to 18.0 GHz: < 1.25	< 13 ns > 30 MHz	0.130 to 0.150	0.039 to 0.148
R&S®NRP-Z85, 2.92 mm (m)	50 MHz to 40 GHz	1 nW to 100 mW (-60 dBm to +20 dBm) max. 200 mW (AVG)/ 1 W (PK, 1 µs)	50 MHz to 2.4 GHz: < 1.16 > 2.4 GHz to 8.0 GHz: < 1.20 > 8.0 GHz to 18.0 GHz: < 1.25 > 18.0 GHz to 26.5 GHz: < 1.30 > 26.5 GHz to 40.0 GHz: < 1.35		0.130 to 0.180	0.039 to 0.165
R&S®NRP-Z86, 2.4 mm (m)	50 MHz to 40 GHz	1 nW to 100 mW (-60 dBm to +20 dBm) max. 200 mW (AVG)/ 1 W (PK, 1 µs)	50 MHz to 2.4 GHz: < 1.16 > 2.4 GHz to 8.0 GHz: < 1.20 > 8.0 GHz to 18.0 GHz: < 1.25 > 18.0 GHz to 26.5 GHz: < 1.30 > 26.5 GHz to 40.0 GHz: < 1.35		0.130 to 0.180	0.039 to 0.165
R&S®NRP-Z86, 2.4 mm (m)	50 MHz to 44 GHz	1 nW to 100 mW (-60 dBm to +20 dBm) max. 200 mW (AVG)/ 1 W (PK, 1 µs)	50 MHz to 2.4 GHz: < 1.16 > 2.4 GHz to 8.0 GHz: < 1.20 > 8.0 GHz to 18.0 GHz: < 1.25 > 18.0 GHz to 26.5 GHz: < 1.30 > 26.5 GHz to 40.0 GHz: < 1.35 > 40.0 GHz to 44.0 GHz: < 1.40		0.130 to 0.190	0.039 to 0.165

## Specifications in brief

Sensor type, connector	Frequency range	Power measurement range, maximum input power	Impedance matching (SWR)	Rise time, video bandwidth	Uncertainty for power measurements at +20 °C to +25 °C	
					absolute (in dB)	relative (in dB)
<b>Thermal power sensors</b>						
R&S®NRP-Z51, N (m)	DC to 18 GHz	300 nW to 100 mW (–35 dBm to +20 dBm) max. 300 mW (AVG)/ 10 W (PK, 1 µs)	DC to 100 MHz: < 1.03 > 100 MHz to 2.4 GHz: < 1.06 > 2.4 GHz to 12.4 GHz: < 1.13 > 12.4 GHz to 18.0 GHz: < 1.16	–	0.040 to 0.082	0.010
R&S®NRP-Z52, 3.5 mm (m)	DC to 33 GHz	300 nW to 100 mW (–35 dBm to +20 dBm) max. 300 mW (AVG)/ 10 W (PK, 1 µs)	DC to 100 MHz: < 1.03 > 100 MHz to 2.4 GHz: < 1.06 > 2.4 GHz to 12.4 GHz: < 1.13 > 12.4 GHz to 18.0 GHz: < 1.16 > 18.0 GHz to 26.5 GHz: < 1.22 > 26.5 GHz to 33.0 GHz: < 1.28		0.040 to 0.101	0.010
R&S®NRP-Z55, model .03, 2.92 mm (m)	DC to 40 GHz	300 nW to 100 mW (–35 dBm to +20 dBm) max. 300 mW (AVG)/ 10 W (PK, 1 µs)	DC to 100 MHz: < 1.03 > 100 MHz to 2.4 GHz: < 1.06 > 2.4 GHz to 12.4 GHz: < 1.13 > 12.4 GHz to 18.0 GHz: < 1.16 > 18.0 GHz to 26.5 GHz: < 1.22 > 26.5 GHz to 40.0 GHz: < 1.28		0.040 to 0.108	0.010
R&S®NRP-Z55 model .04, 2.92 mm (m)	DC to 44 GHz	300 nW to 100 mW (–35 dBm to +20 dBm) max. 300 mW (AVG)/ 10 W (PK, 1 µs)	DC to 100 MHz: < 1.03 > 100 MHz to 2.4 GHz: < 1.06 > 2.4 GHz to 12.4 GHz: < 1.13 > 12.4 GHz to 18.0 GHz: < 1.16 > 18.0 GHz to 26.5 GHz: < 1.22 > 26.5 GHz to 40.0 GHz: < 1.28 > 40.0 GHz to 44.0 GHz: < 1.30		0.040 to 0.138	0.010
R&S®NRP-Z56, 2.4 mm (m)	DC to 50 GHz	300 nW to 100 mW (–35 dBm to +20 dBm) max. 300 mW (AVG)/ 10 W (PK, 1 µs)	DC to 100 MHz: < 1.03 > 100 MHz to 2.4 GHz: < 1.06 > 2.4 GHz to 12.4 GHz: < 1.13 > 12.4 GHz to 18.0 GHz: < 1.16 > 18.0 GHz to 26.5 GHz: < 1.22 > 26.5 GHz to 40.0 GHz: < 1.28 > 40.0 GHz to 50.0 GHz: < 1.30		0.040 to 0.143	0.010
R&S®NRP-Z57, 1.85 mm (m)	DC to 67 GHz	300 nW to 100 mW (–35 dBm to +20 dBm) max. 300 mW (AVG)/ 10 W (PK, 1 µs)	DC to 100 MHz: < 1.03 > 100 MHz to 2.4 GHz: < 1.06 > 2.4 GHz to 12.4 GHz: < 1.13 > 12.4 GHz to 18.0 GHz: < 1.16 > 18.0 GHz to 26.5 GHz: < 1.22 > 26.5 GHz to 40.0 GHz: < 1.28 > 40.0 GHz to 50.0 GHz: < 1.30 > 50.0 GHz to 67.0 GHz: < 1.35		0.040 to 0.248	0.010
R&S®NRP-Z58, 1 mm (m)	DC to 110 GHz	300 nW to 100 mW (–35 dBm to +20 dBm) max. 300 mW (AVG)/ 10 W (PK, 1 µs)	DC to 100 MHz: < 1.05 > 100 MHz to 2.4 GHz: < 1.08 > 2.4 GHz to 12.4 GHz: < 1.18 > 12.4 GHz to 18.0 GHz: < 1.23 > 18.0 GHz to 26.5 GHz: < 1.28 > 26.5 GHz to 40.0 GHz: < 1.38 > 40.0 GHz to 50.0 GHz: < 1.46 > 50.0 GHz to 67.0 GHz: < 1.56 > 67.0 GHz to 80.0 GHz: < 1.60 > 80.0 GHz to 95.0 GHz: < 1.66 > 95.0 GHz to 110.0 GHz: < 1.70		0.040 to 0.318	0.014
<b>Average power sensors</b>						
R&S®NRP-Z91, N (m)	9 kHz to 6 GHz	200 pW to 200 mW (–67 dBm to +23 dBm) max. 400 mW (AVG)/ 1 W (PK, 10 µs)	9 kHz to 2.4 GHz: < 1.13 > 2.4 GHz to 6.0 GHz: < 1.20	–	0.047 to 0.083	0.022 to 0.066
R&S®NRP-Z92, N (m)	9 kHz to 6 GHz	2 nW to 2 W (–57 dBm to +33 dBm) max. 3 W (AVG)/ 10 W (PK, 10 µs)	10 MHz to 2.4 GHz: < 1.14 > 2.4 GHz to 6.0 GHz: < 1.20	–	0.079 to 0.151	0.022 to 0.087

Specifications in brief							
Sensor type, connector	Frequency range	Power measurement range, maximum input power	Impedance matching (SWR)	Rise time, video bandwidth	Uncertainty for power measurements at +20 °C to +25 °C		
					absolute (in dB)	relative (in dB)	
<b>Level control sensors</b>							
R&S®NRP-Z28, N (m)	10 MHz to 18 GHz	200 pW to 100 mW (-67 dBm to +20 dBm) max. 700 mW (AVG)/ 4 W (PK, 10 µs)	10 MHz to 2.4 GHz: < 1.11 > 2.4 GHz to 4.0 GHz: < 1.15 > 4.0 GHz to 8.0 GHz: < 1.22 > 8.0 GHz to 18 GHz: < 1.30	< 8 µs > 50 kHz	0.047 to 0.130	0.022 to 0.110	
R&S®NRP-Z98, N (m)	9 kHz to 6 GHz	200 pW to 100 mW (-67 dBm to +20 dBm) max. 700 mW (AVG)/ 4 W (PK, 10 µs)	9 kHz to 2.4 GHz: < 1.11 > 2.4 GHz to 4.0 GHz: < 1.15 > 4.0 GHz to 6.0 GHz: < 1.22	–	0.047 to 0.083	0.022 to 0.066	
<b>Power sensor modules</b>							
R&S®NRP-Z27, N (m)	DC to 18 GHz	4 µW to 400 mW (-24 dBm to +26 dBm) max. 500 mW (AVG)/ 30 W (PK, 1 µs)	DC to 2.0 GHz: < 1.15 > 2.0 GHz to 4.2 GHz: < 1.18 > 4.2 GHz to 8.0 GHz: < 1.23 > 8.0 GHz to 12.4 GHz: < 1.25 > 12.4 GHz to 18.0 GHz: < 1.35	–	0.070 to 0.112	0.032	
R&S®NRP-Z37, 3.5 mm (m)	DC to 26.5 GHz	4 µW to 400 mW (-24 dBm to +26 dBm) max. 500 mW (AVG)/ 30 W (PK, 1 µs)	DC to 2.0 GHz: < 1.15 > 2.0 GHz to 4.2 GHz: < 1.18 > 4.2 GHz to 8.0 GHz: < 1.23 > 8.0 GHz to 12.4 GHz: < 1.25 > 12.4 GHz to 18.0 GHz: < 1.30 > 18.0 GHz to 26.5 GHz: < 1.45	–	0.070 to 0.122	0.032	

For data sheet, see PD 5213.5539.22 and [www.rohde-schwarz.com](http://www.rohde-schwarz.com)

# From pre-sale to service. At your doorstep.

The Rohde&Schwarz network in over 70 countries ensures optimum on-site support by highly qualified experts. User risks are reduced to a minimum at all stages of the project:

- ▮ Solution finding/purchase
- ▮ Technical startup/application development/integration
- ▮ Training
- ▮ Operation/calibration/repair

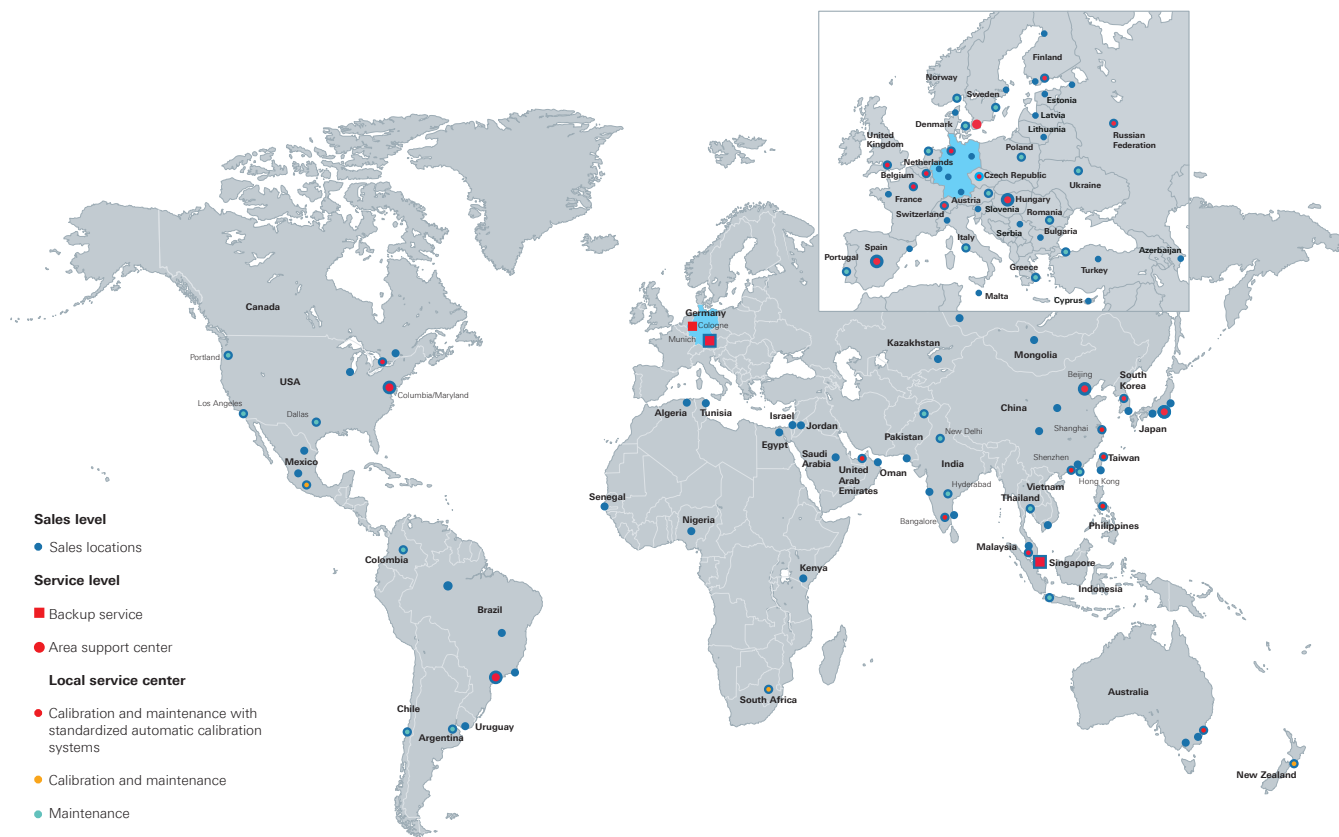

# Power sensor overview

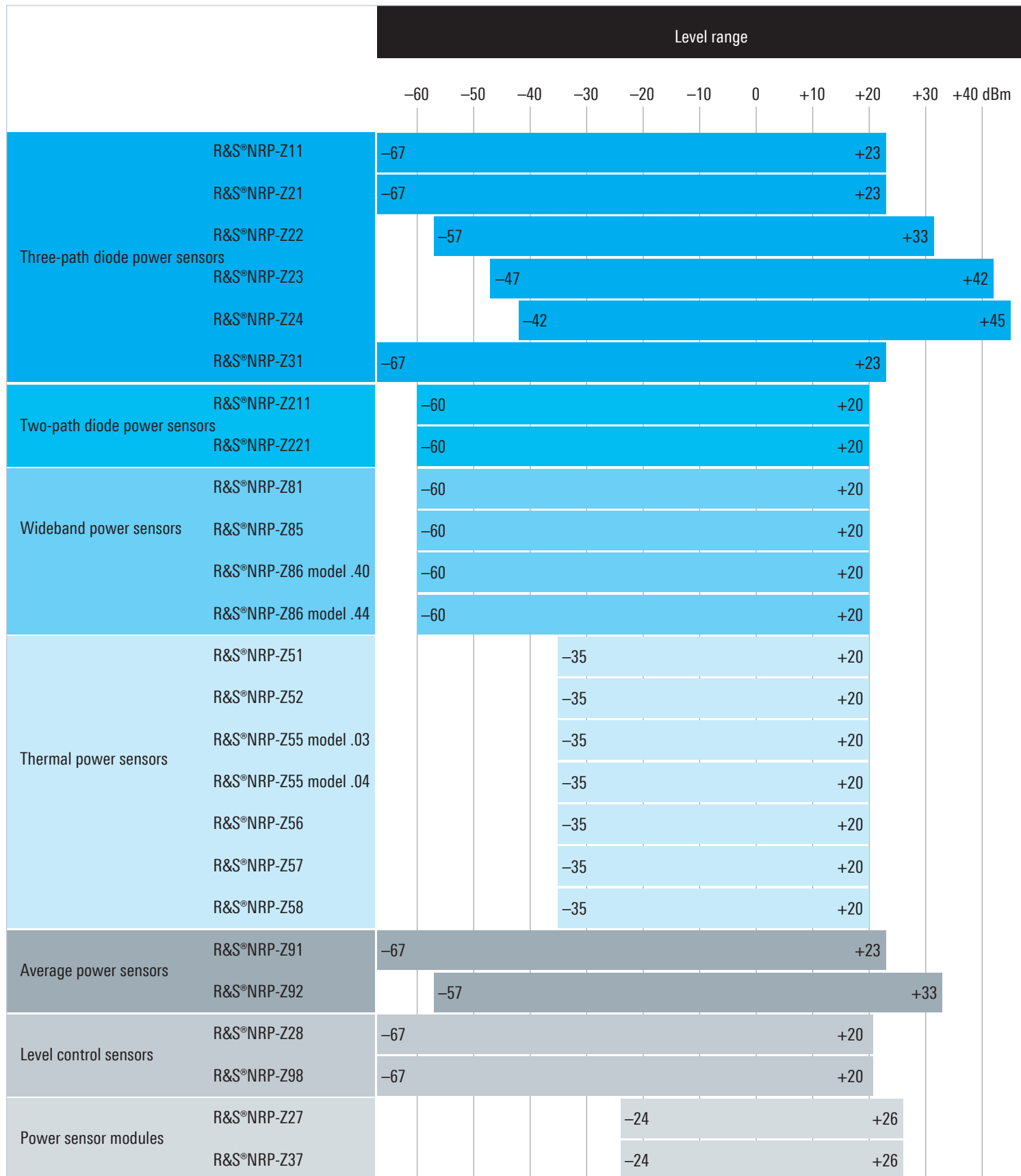



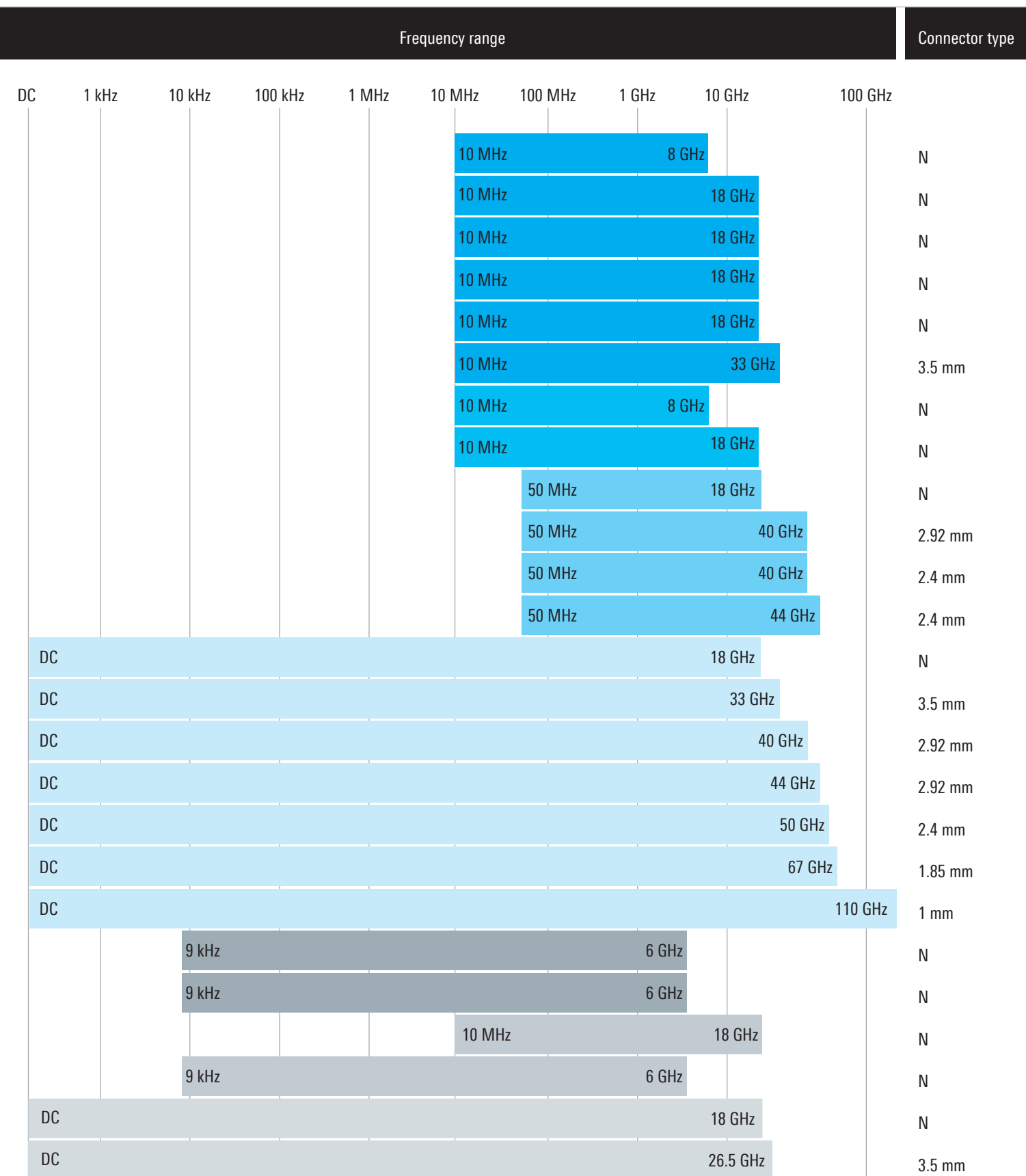

# Ordering information

Designation	Type	Order No.
<b>Base unit</b>		
Power Meter	R&S®NRP2	1144.1374.02
<b>Options</b>		
Sensor Check Source	R&S®NRP-B1	1146.9008.02
Second Sensor Input (B)	R&S®NRP-B2	1146.8801.02
3rd and 4th Sensor Inputs (C, D) <sup>1)</sup>	R&S®NRP-B5	1146.9608.02
Rear Panel Sensor Inputs A and B <sup>2)</sup>	R&S®NRP-B6	1146.9908.02
<b>Three-Path Diode Power Sensors</b>		
200 pW to 200 mW, 10 MHz to 8 GHz (cable length: 1.5 m)	R&S®NRP-Z11	1138.3004.02
200 pW to 200 mW, 10 MHz to 8 GHz (cable length: 0.4 m)	R&S®NRP-Z11	1138.3004.04
200 pW to 200 mW, 10 MHz to 18 GHz	R&S®NRP-Z21	1137.6000.02
2 nW to 2 W, 10 MHz to 18 GHz	R&S®NRP-Z22	1137.7506.02
20 nW to 15 W, 10 MHz to 18 GHz	R&S®NRP-Z23	1137.8002.02
60 nW to 30 W, 10 MHz to 18 GHz	R&S®NRP-Z24	1137.8502.02
200 pW to 200 mW, 10 MHz to 33 GHz (cable length: 1.5 m)	R&S®NRP-Z31	1169.2400.02
200 pW to 200 mW, 10 MHz to 33 GHz (cable length: 0.4 m)	R&S®NRP-Z31	1169.2400.04
<b>Two-Path Diode Power Sensors</b>		
1 nW to 100 mW, 10 MHz to 8 GHz	R&S®NRP-Z211	1417.0409.02
1 nW to 100 mW, 10 MHz to 18 GHz	R&S®NRP-Z221	1417.0309.02
<b>Wideband Power Sensors</b>		
1 nW to 100 mW, 50 MHz to 18 GHz	R&S®NRP-Z81	1137.9009.02
1 nW to 100 mW, 50 MHz to 40 GHz (2.92 mm)	R&S®NRP-Z85	1411.7501.02
1 nW to 100 mW, 50 MHz to 40 GHz (2.4 mm)	R&S®NRP-Z86	1417.0109.40
1 nW to 100 mW, 50 MHz to 44 GHz (2.4 mm)	R&S®NRP-Z86	1417.0109.44
<b>Thermal Power Sensors</b>		
300 nW to 100 mW, DC to 18 GHz	R&S®NRP-Z51	1138.0005.03
300 nW to 100 mW, DC to 33 GHz	R&S®NRP-Z52	1138.0005.02
300 nW to 100 mW, DC to 40 GHz	R&S®NRP-Z55	1138.2008.03
300 nW to 100 mW, DC to 44 GHz	R&S®NRP-Z55	1138.2008.04
300 nW to 100 mW, DC to 50 GHz	R&S®NRP-Z56	1171.8201.02
300 nW to 100 mW, DC to 67 GHz	R&S®NRP-Z57	1171.8401.02
300 nW to 100 mW, DC to 110 GHz	R&S®NRP-Z58	1173.7031.02
<b>Average Power Sensors</b>		
200 pW to 200 mW, 9 kHz to 6 GHz	R&S®NRP-Z91	1168.8004.02
2 nW to 2 W, 9 kHz to 6 GHz	R&S®NRP-Z92	1171.7005.02
<b>Level Control Sensors</b>		
200 pW to 100 mW, 9 kHz to 6 GHz	R&S®NRP-Z98	1170.8508.02
200 pW to 100 mW, 10 MHz to 18 GHz	R&S®NRP-Z28	1170.8008.02
<b>Power Sensor Modules</b>		
4 µW to 400 mW, DC to 18 GHz	R&S®NRP-Z27	1169.4102.02
4 µW to 400 mW, DC to 26.5 GHz	R&S®NRP-Z37	1169.3206.02
<b>Software options</b>		
The R&S®NRPV virtual power meter software is included with the sensors (software is delivered on CD-ROM).		
R&S®NRPV License for one R&S®NRP-Zxx	R&S®NRPZ-K1	1418.9800.03

Designation	Type	Order No.
<b>Recommended extras</b>		
Sensor Extension Cable, 1.5 m	R&S®NRP-Z2	1146.6750.03
Sensor Extension Cable, 3.5 m	R&S®NRP-Z2	1146.6750.05
Sensor Extension Cable, 3.5 m, for panel mounting	R&S®NRP-Z2	1146.6750.15
Sensor Extension Cable, 8.5 m (not with R&S®NRP-Z81/-Z85/-Z86)	R&S®NRP-Z2	1146.6750.10
USB Adapter Cable (active), 2 m	R&S®NRP-Z3	1146.7005.02
USB Adapter Cable (passive), 1.5 m	R&S®NRP-Z4	1146.8001.02
USB Adapter Cable (passive), 0.5 m	R&S®NRP-Z4	1146.8001.04
USB Adapter Cable (passive), 0.15 m	R&S®NRP-Z4	1146.8001.06
USB Adapter Cable (passive), 1 m, for panel mounting	R&S®NRP-Z4	1146.8001.11
Sensor Hub	R&S®NRP-Z5	1146.7740.02
19" Rack Adapter (for one R&S®NRP2 power meter and one empty casing)	R&S®ZZA-T26	1109.4387.00
19" Rack Adapter (for two R&S®NRP2 power meters)	R&S®ZZA-T27	1109.4393.00

<sup>1)</sup> R&S®NRP-B2 option required.

<sup>2)</sup> Not in conjunction with the R&S®NRP-B5 option.

<b>Service options</b>		
Extended Warranty, one year	R&S®WE1NRP2/WE1NRP-Zxx	Please contact your local Rohde & Schwarz sales office.
Extended Warranty, two years	R&S®WE2NRP2/WE2NRP-Zxx	
Extended Warranty, three years	R&S®WE3NRP2/WE3NRP-Zxx	
Extended Warranty, four years	R&S®WE4NRP2/WE4NRP-Zxx	
Extended Warranty with Calibration Coverage, one year	R&S®CW1NRP2/CW1NRP-Zxx	
Extended Warranty with Calibration Coverage, two years	R&S®CW2NRP2/CW2NRP-Zxx	
Extended Warranty with Calibration Coverage, three years	R&S®CW3NRP2/CW3NRP-Zxx	
Extended Warranty with Calibration Coverage, four years	R&S®CW4NRP2/CW4NRP-Zxx	

The Bluetooth® word mark and logos are registered trademarks owned by Bluetooth SIG, Inc. and any use of such marks by Rohde & Schwarz is under license.

CDMA2000® is a registered trademark of the Telecommunications Industry Association (TIA-USA).

“WiMAX Forum” is a registered trademark of the WiMAX Forum. “WiMAX”, the WiMAX Forum logo, “WiMAX Forum Certified”, and the WiMAX Forum Certified logo are trademarks of the WiMAX Forum.

Your local Rohde & Schwarz expert will help you determine the optimum solution for your requirements.

To find your nearest Rohde & Schwarz representative, visit

[www.sales.rohde-schwarz.com](http://www.sales.rohde-schwarz.com)

## Service you can rely on

- | Worldwide
- | Local and personalized
- | Customized and flexible
- | Uncompromising quality
- | Long-term dependability

## About Rohde & Schwarz

Rohde & Schwarz is an independent group of companies specializing in electronics. It is a leading supplier of solutions in the fields of test and measurement, broadcasting, radiomonitoring and radiolocation, as well as secure communications. Established more than 75 years ago, Rohde & Schwarz has a global presence and a dedicated service network in over 70 countries. Company headquarters are in Munich, Germany.

## Environmental commitment

- | Energy-efficient products
- | Continuous improvement in environmental sustainability
- | ISO 14001-certified environmental management system

Certified Quality System  
**ISO 9001**

## Rohde & Schwarz GmbH & Co. KG

[www.rohde-schwarz.com](http://www.rohde-schwarz.com)

## Regional contact

- | Europe, Africa, Middle East | +49 89 4129 12345  
[customersupport@rohde-schwarz.com](mailto:customersupport@rohde-schwarz.com)
- | North America | 1 888 TEST RSA (1 888 837 87 72)  
[customer.support@rsa.rohde-schwarz.com](mailto:customer.support@rsa.rohde-schwarz.com)
- | Latin America | +1 410 910 79 88  
[customersupport.la@rohde-schwarz.com](mailto:customersupport.la@rohde-schwarz.com)
- | Asia/Pacific | +65 65 13 04 88  
[customersupport.asia@rohde-schwarz.com](mailto:customersupport.asia@rohde-schwarz.com)
- | China | +86 800 810 8228/+86 400 650 5896  
[customersupport.china@rohde-schwarz.com](mailto:customersupport.china@rohde-schwarz.com)

R&S® is a registered trademark of Rohde & Schwarz GmbH & Co. KG

Trade names are trademarks of the owners | Printed in Germany (sk)

PD 5213.5539.12 | Version 05.00 | May 2013 | R&S®NRP

Data without tolerance limits is not binding | Subject to change

© 2002 - 2013 Rohde & Schwarz GmbH & Co. KG | 81671 München, Germany



5213553912