

# Keysight B2961A/B2962A 6.5 Digit Low Noise Power Source

1 ch/2 ch  
210 V, 3 A DC/10.5 A Pulse, 31.8W  
100 nV/10 fA Resolution



# Impressive 6.5 Digit 100 nV/10 fA Resolution, 10 $\mu$ Vrms Ultra Low Noise and Innovative Source Functions Accelerate Your Research and Development

## Revolutionary power supply/source meets both existing and future test needs

Power supplies/sources are essential instruments for test and evaluation across the electronics industry. The on-going industry trends of reduced power consumption and faster communication data rates increasingly require power sources that can support lower levels of current and voltage. These requirements mandate that power supplies/sources meet ever higher levels of performance.

The Keysight Technologies, Inc. B2961A/B2962A 6.5 Digit Low Noise Power Source is a new bench-top power supply/source with revolutionary capabilities and functions not previously available. Its unique features include bipolar current sourcing and sinking, a programmable output resistance feature, and a time-domain waveform viewer supported in the graphical user interface (GUI).

You can choose between 1-channel (B2961A) and 2-channel (B2962A) models, allowing you to select the exact amount of bench-top power source performance to meet your testing needs.

- Best-in-class 6.5 digit resolution (100 nV/10 fA minimum resolutions)
- Wide bipolar (4-quadrant) voltage/current ranges (210 V/3 A DC, 10.5 A Pulse)
- Ultra low noise filter (10  $\mu$ Vrms, 1 nV/ $\sqrt{\text{Hz}}$  at 10 kHz)
- Intuitive graphical user interface with wide 4.3" color LCD
- Convenient 4.5 digit voltage/current monitor
- Time domain waveform viewer for quick check and debug
- Precision 1 MHz -10 kHz arbitrary waveform generation capability
- Flexible programmable output resistance function.

In addition to these innovative bench-top power supply/source features, the Keysight B2961A/B2962A can be controlled remotely using Keysight PC-based BenchVue, Quick I/V Measurement Software or through any LXI compliant web browser. These capabilities simplify the task of incorporating measurement data and graphs into reports and presentations.

The superior performance and innovative functions of the Keysight B2961A/B2962A cover a broad range of test applications.

BEST IN CLASS RESOLUTION ▪ ULTRA-LOW NOISE ▪ INNOVATIVE SOURCE FUNCTIONS



## Key Features and Benefits

Key Features	Benefit
<b>Best-in-class resolution and wide bipolar range</b> <ul style="list-style-type: none"><li>– 6.5 digit (100 nV/10 fA resolution)</li><li>– 210 V &amp; 3 A (DC)/10.5 A (pulsed) ranges</li><li>– 4-quadrant operation</li></ul>	Very precise test and evaluation can be performed within a wide 4-quadrant voltage and current range.
<b>External ultra low noise filter (option)</b> <ul style="list-style-type: none"><li>– 10 <math>\mu</math>Vrms (10 Hz – 20 MHz)</li><li>– 1 nVrms/<math>\sqrt{\text{Hz}}</math> at 10 kHz</li></ul>	Reveal more of the true characteristics of your noise-sensitive devices and samples than ever before.
<b>Intuitive GUI implemented on 4.3" color LCD</b> <ul style="list-style-type: none"><li>– 4.5 digit voltage/current monitor</li><li>– Time domain waveform viewer</li></ul>	Improved test and debug efficiency without the need for a PC.
<b>Precision 1 mHz – 10 kHz arbitrary waveform generation capability</b> <ul style="list-style-type: none"><li>– Voltage and current waveform generation up to 210 V/3 A</li><li>– Support for six built-in waveforms and a user-defined arbitrary waveform</li></ul>	Goes beyond simple DC measurement and allows you to perform complex and more sophisticated testing of your devices and samples.
<b>Versatile programmable output resistance function</b> <ul style="list-style-type: none"><li>– Constant mode</li><li>– Voltage/current emulation mode</li></ul>	Enables you to simulate a wide variety of devices and sample types.

### A wide variety of Keysight B2961A/B2962A applications

To reduce power consumption battery-powered devices continue to reduce their supply voltage levels, which requires ever more precise power sources to accurately characterize device behavior. Noise performance requirements also continue to become more stringent in application areas such as mobile communications due to higher data rates and faster clock frequencies. These technology trends make the testing of advanced products increasingly difficult due to their extreme sensitivity to noise and other external disturbances.

As a result, power supplies/sources with more precision, better noise performance and more versatile sourcing functions are now required. The Keysight B2961A/B2962A meet these requirements, and they can be used for a wide variety of applications that permit you to perform critical tests and evaluations that have not been previously possible.

In addition, the Keysight B2961A/B2962A's superior performance and innovative functions make these instruments ideal companion power supplies/sources for use with other instruments such as network analyzers, spectrum analyzers, digital multimeters and nano-voltmeters.

### Application examples

- A/D and D/A converters
- High precision analog IC and circuitry
- RFICs and circuitry
- Medical applications
- Cable/wire harnesses evaluation
- Voltage controlled oscillators (VCOs)
- Sensor devices and transducers
- Solar cells and the interface circuitry
- Electrochemical applications
- Research and education
- Crystal oscillators
- Current source for small voltage measurement
- Battery management
- Advanced materials evaluation

# Superior Resolution and Wide Bipolar Ranges Meet your Most Challenging Test and Evaluation Needs

## 6.5 digit resolution enables precise analog-to-digital converter evaluation

One area where power supply sourcing resolution is important is analog-to-digital converter (ADC) evaluation. For an 8-bit ADC, a 1 V (peak to peak) signal would have a minimum step voltage of 3.9 mV. In this case a power source with 4.5 digit resolution is sufficient to use for the DC input voltage. However, for an ADC with 14-bits or more, 4.5 digit resolution is not enough. In this case the B2961A/B2962A's best-in-class 6.5-digit sourcing resolution is required in order to properly evaluate the ADC circuit.

ADC Resolution	Steps	Min Step Voltage	Conventional power supply resolution (4.5 digit/ Min 100 $\mu$ V)	B2961A/B2962A resolution (6.5 digit/ Min 1 $\mu$ V)
8-bit	256	3.9 mV	✓	✓
10-bit	1,024	1.0 mV	✓	✓
12-bit	4,096	244 $\mu$ V	✓	✓
14-bit	16,384	61 $\mu$ V		✓
16-bit	65,536	15 $\mu$ V		✓

Figure 1. Resolution comparison: ADC with 1 Vpp (Full Scale)

## Wide bipolar range (100 nV to 210 V, 10 fA to 10.5 A) permits characterization of many types of devices and samples

The wide bipolar (four-quadrant) voltage and current ranges of the Keysight B2961A/B2962A are capable of supporting both current and future testing needs. In addition, since they support both very small and very large current and voltage signal levels the B2961A/B2962A can often replace several other bench-top instruments. As shown in Figure 2, you can program any voltage and current value within the B2961A/B2962A's wide output range without worrying about any zero-crossing glitches.

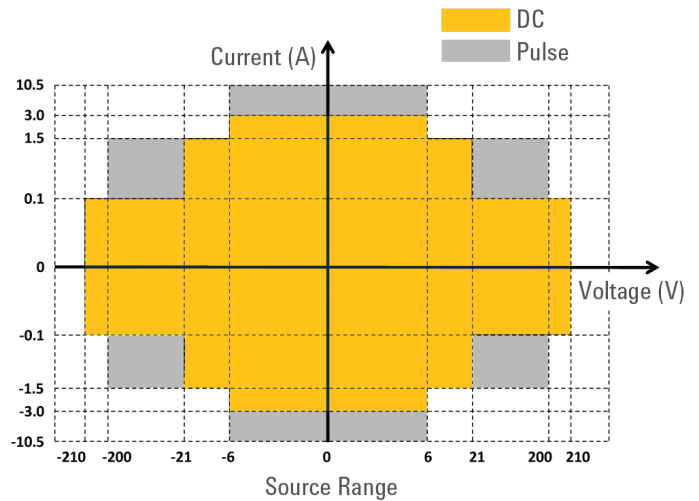

Figure 2. Wide bipolar voltage and current ranges (4-quadrant operation)

## Fast settling time increases your test efficiency

Unlike most conventional power supplies/sources, the Keysight B2961A/B2962A can quickly settle to their final value with 6.5 digit resolution throughout their entire output ranges. This reduces test times and improves measurement efficiency, especially when making multiple tests in sequence. See Figure 3.

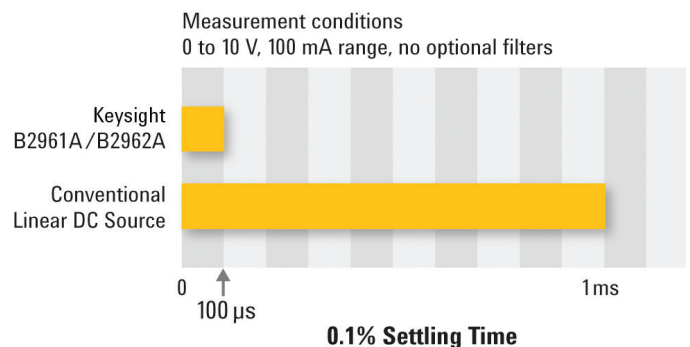

Figure 3. Fast settling time than conventional DC sources

# Best-in-Class Noise Performance (10 $\mu\text{Vrms}$ ) Unlocks the True Characteristics of Your Devices and Samples

## Three optional filters available for different test needs

For applications requiring ultra-low noise performance, the Keysight B2961A/B2962A supports three external filter options. This provides you with the flexibility to select the noise filter price/performance point that best meets your needs. The low noise filter (LNF) provides the same level of RMS noise as linear regulator-based power supplies and sources, while the high current ultra low noise filter (HC-ULNF) and the ultra low noise filter (ULNF) reduces noise to an impressive 10  $\mu\text{Vrms}$ . See Figure 4.



Figure 4. Optional external noise filters can meet your most stringent noise requirements

## HC-ULNF and ULNF provide unprecedented low-noise performance (10 $\mu\text{Vrms}$ and 1 $\text{nVrms}/\sqrt{\text{Hz}}$ at 10 kHz) in a low-cost bench-top instrument

As shown in Figure 5 both HC-ULNF and ULNF reduce the voltage noise of the Keysight B2961A/B2962A to 10  $\mu\text{Vrms}$  in the frequency range of 10 Hz – 20 MHz. The differences between HC-ULNF and ULNF are voltage and current coverage. HC-ULNF allow it to source up to 21 V and 500mA, and ULNF allowing up to 42 V and 105 mA. This outstanding low noise performance can be used to evaluate noise-sensitive devices and circuits such as ADC/DAC as well as many other types of analog and RF ICs. In addition, see Figure 6. the HC-ULNF and ULNF minimizes the noise density to 1  $\text{nVrms}/\sqrt{\text{Hz}}$  at 10 kHz, which is required for the phase noise evaluation of oscillator circuits such as VCOs, crystal oscillators, etc. There are two user-selectable output impedance settings, 2-wire (50  $\Omega$ ) and 4-wire (low impedance close to zero), to provide optimal flexibility when characterizing your devices and samples.

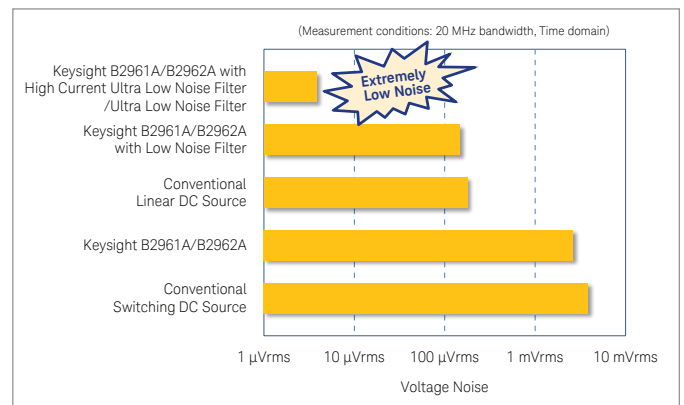

Figure 5. HC-ULNF and ULNF dramatically reduce output noise

## LNF supports full 210 V and 3 A bipolar output range

The LNF supports the B2961A/B2962A's wide bipolar voltage and current ranges (up to 210 V/3 A) while providing noise levels comparable to those of linear power supplies. In addition, when using the LNF you can still make 4-wire (Kelvin) measurements to eliminate residual cable resistance effects. For applications requiring a moderate level of low-noise performance, the LNF provides a cost-effective means to achieve low-noise sourcing capability for a modest price.

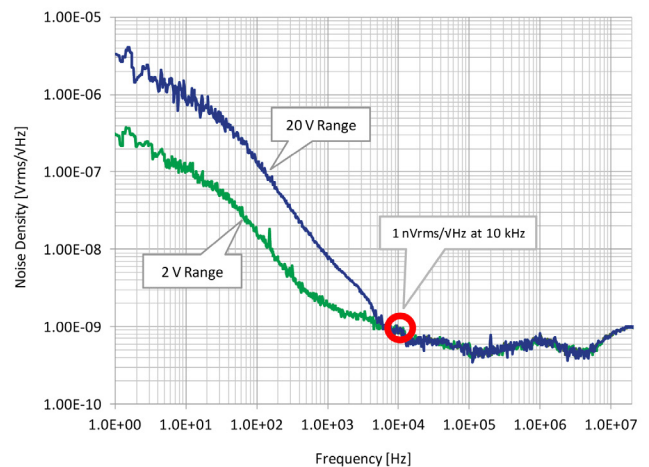

Figure 6. HC-ULNF and ULNF provide excellent noise density performance

## Intuitive Front-Panel GUI and Wide 4.3" Color LCD Maximize Test and Debug Efficiency

Many power supplies and sources only possess a numerical display or a very basic dot matrix display, which are only effective at showing DC values. In contrast, the Keysight B2961A/B2962A has an easy-to-use front panel GUI and a wide 4.3" color LCD. These make it easy to set up sourcing parameters and to display complex current and voltage waveforms. For added convenience, the Keysight B2961A/B2962A provides multiple viewing modes: single view, dual view (B2962A only) and graph view. These capabilities not only increase test and evaluation efficiency, but they also make the instrument easy to use without the need to struggle through paper manuals. See Figure 7.

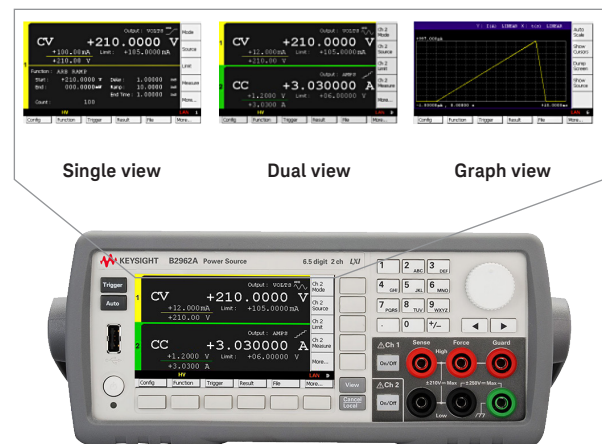

Figure 7. Three viewing modes provide you with flexible and efficient testing

## Integrated voltage and current monitoring capability verifies output with 4.5 digit resolution

The Keysight B2961A/B2962A has a built-in voltage and current monitoring feature that enables you to verify the actual voltage and current output. You can view the sourced voltage and current values with 4.5 digit numeric resolution in both single and dual viewing modes. With minimum voltage and current measurement resolution of 10  $\mu$ V and 1 pA (respectively), a digital multi-meter (DMM) is not necessary for measurement verification.

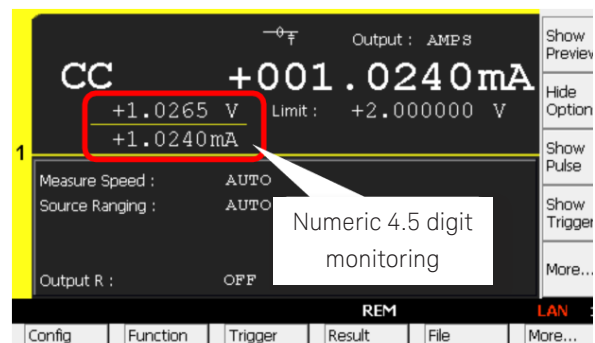

Figure 8. Perform quick status checks with 4.5 digit numeric display

## Time domain waveform viewer facilitates quick check and debug of output waveforms

In addition to the numeric monitoring, the Keysight B2961A/B2962A Power Source has a time domain waveform viewing capability (Figure 9). For most power supplies and sources, you cannot view the actual waveform you are applying to your device or sample without using some other sort of external instrument. The Keysight B2961A/B2962A's time domain monitoring capability displays applied waveforms on its LCD display (Graph View mode), enabling you to verify that you are applying the correct signal to your DUT.

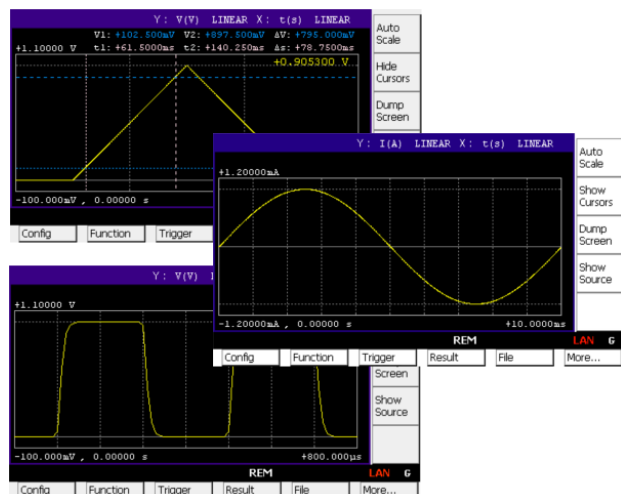

Figure 9. Graph View allows you to view output waveform in the time domain

# GUI Based Intuitive Front Panel Design with Rich Standard Interfaces for Your Bench-Top Needs

In addition to the graphical user interface and easy-to-use front panel, the Keysight B2961A/B2962A integrates standard interfaces such as USB 2.0, LAN (LXI class C compliant), digital I/O and GPIB in a bench-top instrument form. The optional filters are well designed for the B2961A/B2962A and easy to attach to/from front/rear channels.

USB 2.0 for memory I/O      4.3" color LCD      Assist key, numeric /alpha keys and rotary knob



Channel 1

Channel 2 (B2962A only)

Digital I/O

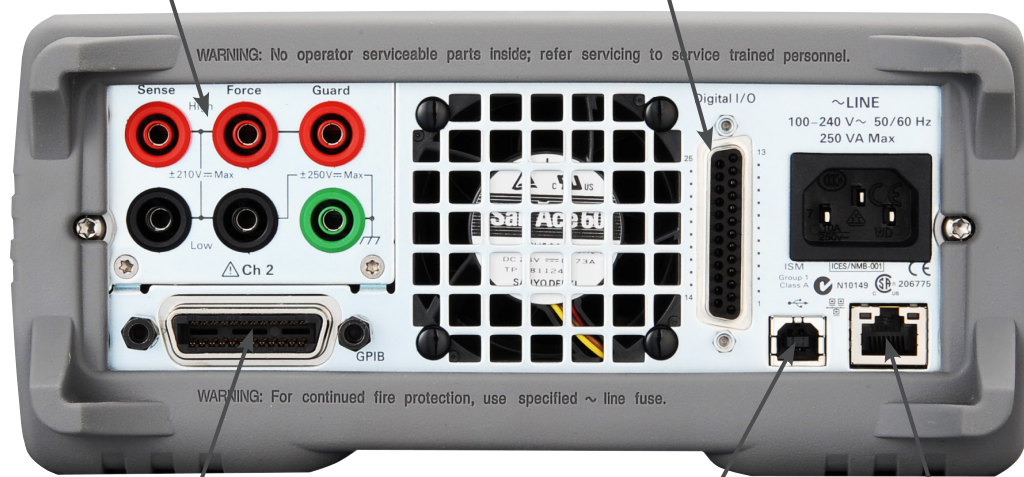

GPIB

USB 2.0

LAN



High Current  
Ultra Low Noise Filter  
(option)



Ultra Low Noise Filter  
(option)



Low Noise Filter  
(option)

# Flexible Source Functions Beyond a DC Instrument Remove Your Test Restrictions

## Pre-defined and arbitrary waveforms increase your test and evaluation flexibility

The Keysight B2961A/B2962A features full-fledged test and evaluation beyond conventional static DC testing. The pre-defined waveform generation capability provides six waveforms: sinusoidal, exponential, ramp, triangle, square and trapezoidal. In addition to these commonly used waveforms, you can set user-defined arbitrary waveforms with up to 100,000 points of setting. These flexible output capabilities should help you make deeper evaluation of your devices/samples that you've tested with other instruments than power supplies and sources.

## Precision and wide voltage/current waveform generation

The arbitrary waveform generation capability of Keysight B2961A/B2962A can generate both precision voltage and current waveforms in 1 mHz -10 kHz frequency range. Although some of conventional voltage/current source instruments feature a waveform generation capability, the output waveforms do not have enough accuracy as shown in Figure 11A. In contrast, as shown in Figure 11B, the Keysight B2961A/B2962A can generate cleaner and more precision waveforms for more sensitive device/sample testing. You can also make use of the same output voltage/current ranges (210 V/3 A) and the same resolutions (100 nV/10 fA) as those of original DC voltage/current specifications. This outstanding capability helps you make precision test and evaluation even in time domain.

## Preview of output waveform and simple user interface helps quick and reliable test

The Keysight B2961A/B2962A provides convenient and user-friendly interface for this arbitrary waveform generation capabilities. The preview mode shows the waveform shape on the same display that you set the waveform parameters, and enables you to check the forcing waveform shape in advance. This well-considered user interface provides you with an intuitive test environment, and improves your test and evaluation efficiency.

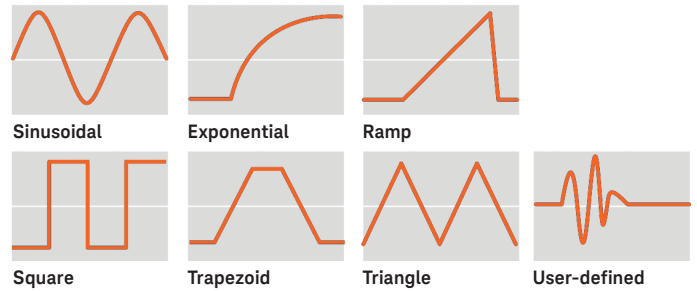

Figure 10. Convenient built-in waveform generation capabilities

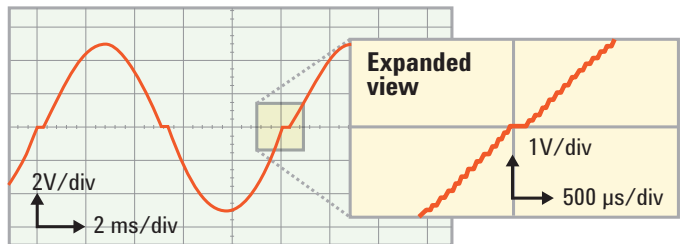

Figure 11A. Sinusoid waveform comparison at 100 Hz (Conventional voltage source)

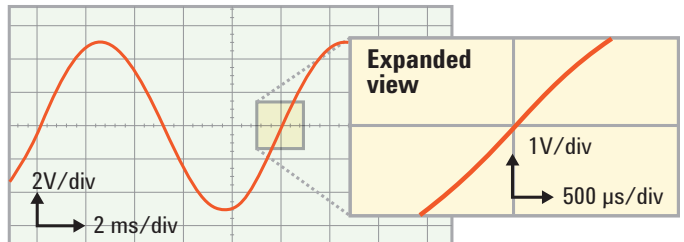

Figure 11B. Sinusoid waveform comparison at 100 Hz (B2961A/B2962A)

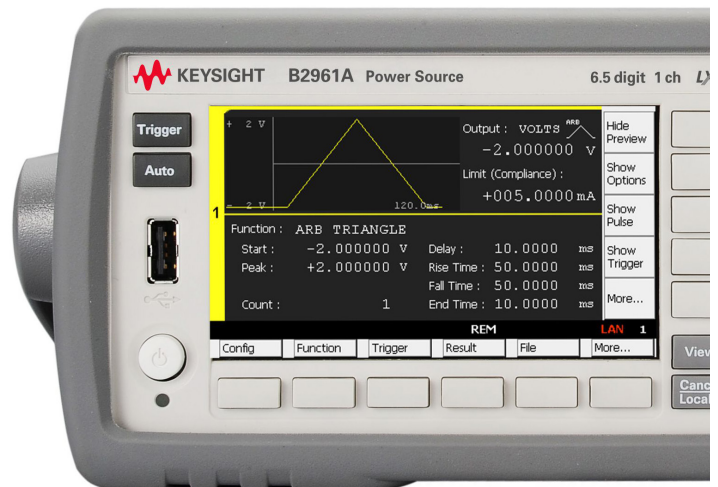

Figure 12. The preview of waveform you have just set



# Programmable Output Resistance and DC Voltage/Current Output Emulation Capabilities Solve Real-World Measurement Challenges

## The B2961A/B2962A's programmable output resistance function provides flexible measurement capabilities

The Keysight B2961A/B2962A has a programmable output resistance feature that allows you to control the output behavior of the power source. It supports two test modes, constant and V/I emulation, to provide maximum flexibility and versatility. Constant mode allows you to specify an output resistance value (either positive or negative) such that the output will respond exactly as if the specified resistance value were in series (voltage source mode) or in parallel (current source mode) with the source output. The constant mode can emulate resistance values over a wide range, and the negative resistance capability is particularly useful for cancelling out unwanted external resistances. For example, you can use the negative resistance feature to eliminate the resistance of long connection wires without the need to use a 4-wire (Kelvin) connection scheme. This is especially useful in situations where a 4-wire measurement is not possible due to packaged device limitations or to the absence of sense pads for probing.

## DC voltage/current characteristic emulation feature provides powerful bench-top analysis capabilities

The programmable output resistance's V/I emulation mode function allows you to simulate any DC voltage/current output characteristic. You can specify up to 16 voltage and current points to create the desired DC electrical characteristic. Since in this mode the Keysight B2961A/B2962A responds exactly like the equivalent device or sample, it is useful for simulating electrical behavior when an actual component is not available as well as for testing corner cases. In the example shown in Figure 14, the output of an active device (solar cell) is simulated using the V/I emulation mode function. This ability to simulate both active and passive devices provides unprecedented power and flexibility in a compact bench-top form factor. (Figure 15).

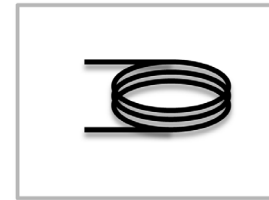

Long cable/wire

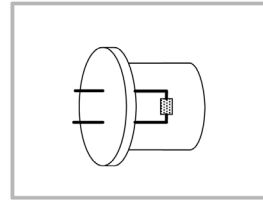

Wiring inside of package

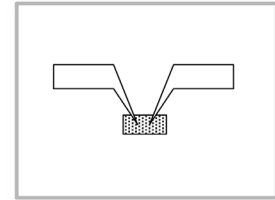

Probe tip 4-wire cannot be established

Figure 13. Measurement situations that benefit from Programmable Output Resistance's Constant mode feature

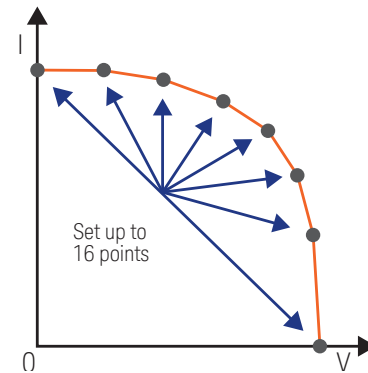

Figure 14. In V/I emulation mode you can specify up to 16 voltage/ current points to synthesize a desired electrical characteristic

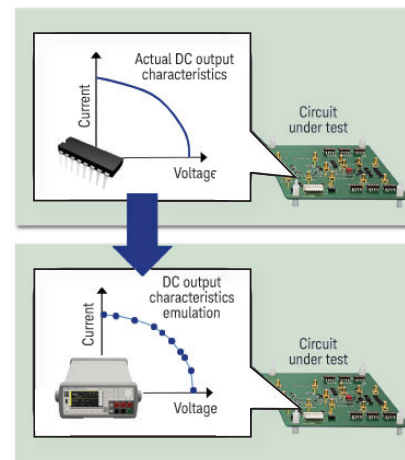

Figure 15. The B2961A/B2962A can emulate the DC voltage/current output characteristics of many devices and samples

# Multiple Communication Methods and Software Provide Flexible and Convenient Remote Control Options

## BenchVue

BenchVue allows you to control the B2961A/B2962A as voltage/current sources from a PC without the need to do any programming. In addition, because BenchVue supports a wide variety of Keysight instruments (oscilloscopes, meters, etc.) it is a good choice when you need to integrate together many different types of instruments on a benchtop.



## Quick I/V Measurement Software

Keysight supplies PC-based Quick I/V Measurement Software with the Keysight B2961A/B2962A at no charge. This software makes it easy to quickly setup and perform voltage or current sourcing and to display measurement data in tables and graphs without the need to program. Using Keysight Quick IV software you can control up to four instrument channels.

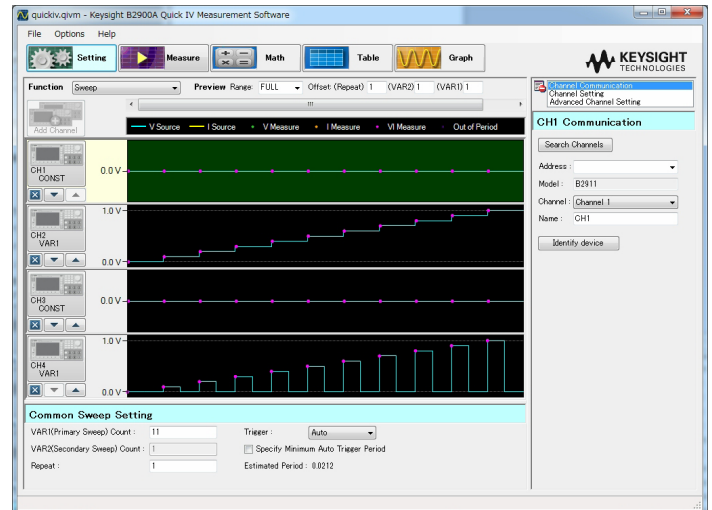

## Graphical Web Interface

The Keysight B2961A/B2962A has a built-in web server that allows it to be controlled using a web browser. This allows you to enjoy the convenience of external PC control without the need for any special software. Simply connect your computer to the instrument via its LAN port, type in the IP address of the Keysight B2961A/B2962A unit and begin making interactive tests.

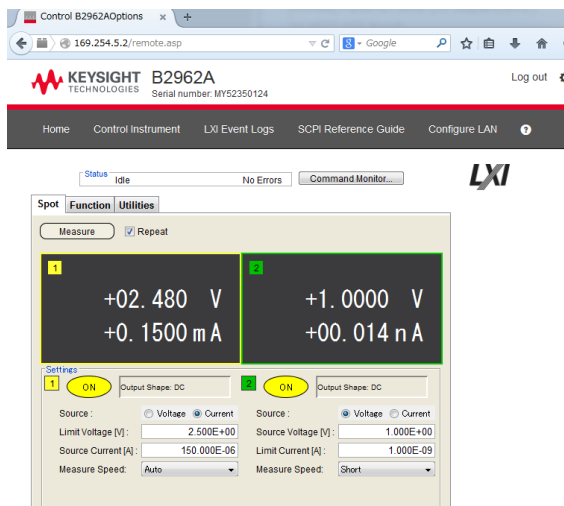

## Ready-to-use instrument drivers simplify Programming

For users that want to create their own customized software, IVI-C and IVI-COM drivers for the Keysight B2961A/B2962A are available. In addition, National Instruments LabView drivers are available at NI.COM.

## Key Specifications

		B2961A/B2962A	B2961A/B2962A with High Current Ultra Low Noise Filter	B2961A/B2962A with Ultra Low Noise Filter	B2961A/B2962A with Low Noise Filter	
Number of channel		1 or 2	1 or 2	1 or 2	1 or 2	
Output	DC or arbitrary waveform output	Maximum voltage	±210 V	±21 V	±42 V	±210 V
		Maximum current	±3.03 A	±500 mA	±105 mA	±3.03 A
	Pulsed	Maximum voltage	±200 V	±21 V	±42 V	±200 V
		Maximum current	±10.5 A	±500 mA	±105 mA	±3.03 A <sup>4</sup>
	Maximum power	31.8 W	10.5 W	4.4 W	31.8 W	
Output polarity		Bipolar (4-quadrant operation)	Bipolar (4-quadrant operation)	Bipolar (4-quadrant operation)	Bipolar (4-quadrant operation)	
Source resolution	Digit	6.5 digit	6.5 digit	6.5 digit	6.5 digit	
	Minimum resolution	100 nV /10 fA	100 nV /10 pA	100 nV /10 pA	100 nV /10 pA	
Output capability	DC	Yes	Yes	Yes	Yes	
	Pulsed	Yes	only voltage output	only voltage output	only voltage output	
	Sweep DC/Pulse/List	Yes	only voltage output	only voltage output	only voltage output	
	Arbitrary wave form	Yes	only voltage output	only voltage output	only voltage output	
Noise <sup>1</sup>	0.1 to 10 Hz	≤ 5 μVpp	≤ 5 μVpp	≤ 5 μVpp	≤ 5 μVpp	
	10 to 20M Hz	3 mVrms	10 μVrms (1 nVrms/√Hz @10kHz)	10 μVrms (1 nVrms/√Hz @10kHz)	350 μVrms	
Measurement capability		4.5 digit built-in voltage/current monitor	4.5 digit built-in voltage/current monitor	4.5 digit built-in voltage/current monitor	4.5 digit built-in voltage/current monitor	
Source/monitor ranges	Voltage range	200 mV to 200 V	200 mV to 20 V <sup>2</sup>	200 mV to 200 V <sup>3</sup>	200 mV to 200 V	
	Current range	10 nA to 10 A	1 mA to 1 A	10 μA to 100 mA	10 μA to 3 A	
Programmable output resistance	Constant R	Yes	No	No	No	
	V/I emulation	Yes	No	No	No	
View mode	Single view	Yes	Yes	Yes	Yes	
	Waveform preview	Yes	Yes	Yes	Yes	
	Dual View	Only 2ch model (B2962A)	Only 2ch model (B2962A)	Only 2ch model (B2962A)	Only 2ch model (B2962A)	
	Graph view (time-domain voltage/current waveform viewer)	Yes	Yes	Yes	Yes	
Max capacitive load		0.01 μF (normal mode)	50 μF	50 μF	1 mF	
Interface		GPIB, USB 2.0, LAN and digital I/O(LXI Core Conformant)				

1. Supplemental Characteristics
2. Maximum voltage output is limited to 21V for 20V range.
3. Maximum voltage output is limited to 42V for 200V range.
4. 10 A pulse range is not supported.

# Specifications

## Specification conditions

Temperature: 23 °C ± 5 °C  
 Humidity: 30 % to 80 % RH  
 After 60 minutes warm-up  
 Ambient temperature change less than ± 3 °C after self-calibration execution  
 Calibration period: 1 year  
 Measurement speed: 1 PLC (Power Line Cycle)

## Maximum voltage and current

	Maximum Voltage	Maximum Current
DC, Pulsed or Arbitrary Waveform Output <sup>1</sup>	210 V	0.105 A
	21 V	1.515 A <sup>2</sup>
	6 V	3.03 A <sup>2</sup>
Pulsed only <sup>1</sup>	200 V	1.515 A
	6 V	10.5 A

1. See “Maximum pulse width and duty cycle” in Pulse Source Supplemental Characteristics for applicable maximum voltage and current.
2. Max current limitation: For 21 V/1.515 A and 6 V/3.03 A ranges, total max current is limited by the table below for using 2 channels. Max current is not limited for using 1 channel only.

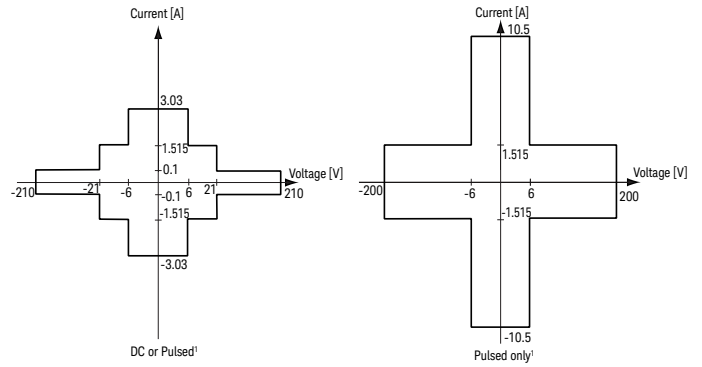

## Maximum current limitation

Ch1 voltage	Ch2 voltage	Max total current limitation of Ch1 and Ch2
±(0 V < V ≤ 6 V)	±(0 V < V ≤ 6 V)	Ch1 current + Ch2 current ≤ 4 A
±(0 V < V ≤ 6 V)	±(6 V < V ≤ 21 V)	Ch1 current + Ch2 current x 1.6 ≤ 4 A
±(6 V < V ≤ 21 V)	±(0 V < V ≤ 6 V)	Ch1 current + Ch2 current x 0.625 ≤ 2.5 A
±(6 V < V ≤ 21 V)	±(6 V < V ≤ 21 V)	Ch1 current + Ch2 current ≤ 2.5 A

# Source Specifications

## DC Voltage source specifications

Range	Programming resolution	Accuracy ±(% reading + offset)	Noise (peak to peak) 0.1 Hz to 10 Hz <sup>1</sup>	Max voltage (over range)
±200 mV	100 nV	0.015 % + 225 μV	≤ 5 μV	±210 mV
±2 V	1 μV	0.02 % + 350 μV	≤ 15 μV	±2.1 V
±20 V	10 μV	0.015 % + 5 mV	≤ 150 μV	±21 V
±200 V	100 μV	0.015 % + 50 mV	≤ 1.5 mV	±210 V

1. Supplemental characteristics

## DC Current source specifications

Range	Programming Resolution	Accuracy (% reading + offset)	Noise (peak to peak) 0.1 Hz to 10 Hz <sup>1</sup>	Max Current (over range)
±10 nA	10 fA	±(0.10 % + 50 pA)	≤ 1 pA	±10.5 nA
±100 nA	100 fA	±(0.06 % + 100 pA)	≤ 2 pA	±105 nA
±1 µA	1 pA	±(0.025 % + 500 pA)	≤ 20 pA	±1.05 µA
±10 µA	10 pA	±(0.025 % + 1.5 nA)	≤ 60 pA	±10.5 µA
±100 µA	100 pA	±(0.02 % + 25 nA)	≤ 1 nA	±105 µA
±1 mA	1 nA	±(0.02 % + 200 nA)	≤ 6 nA	±1.05 mA
±10 mA	10 nA	±(0.02 % + 2.5 µA)	≤ 100 nA	±10.5 mA
±100 mA	100 nA	±(0.02 % + 20 µA)	≤ 600 nA	±105 mA
±1 A	1 µA	±(0.03 % + 1.5 mA)	≤ 20 µA	±1.05 A
±1.5 A	1 µA	±(0.05 % + 3.5 mA)	≤ 20 µA	±1.515 A
±3 A	10 µA	±(0.4 % + 7 mA)	≤ 60 µA	±3.03 A
±10 A <sup>2</sup>	10 µA	±(0.4 % + 25 mA) <sup>3</sup>		±10.5 A

- Supplemental characteristics
- 10 A range is available only for pulse mode, not available for DC mode.
- Measurement speed: 0.01 PLC

## Source Supplemental Characteristics

### Pulsing capabilities

Minimum programmable pulse width	50 µs
Pulse width programming resolution	1 µs
Pulse width definition	The time from 10 % leading to 90 % trailing edge as follows.

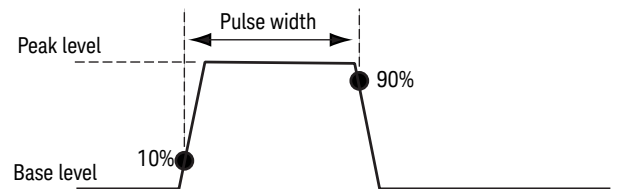

### Maximum pulse width and duty cycle:

	Pulsed					DC	
	Max Voltage	Max Peak Current	Max Base Current	Pulse Width	Max Duty Cycle	Max Voltage	Max Current
DC or pulsed	210 V	0.105 A	0.105 A	50 µs to 99999.9 s	99.9999 %	210 V	0.105 A
	21 V	1.515 A <sup>1</sup>	1.515 A <sup>1</sup>	50 µs to 99999.9 s	99.9999 %	21 V	1.515 A <sup>1</sup>
	6 V	3.03 A <sup>1</sup>	3.03 A <sup>1</sup>	50 µs to 99999.9 s	99.9999 %	6 V	3.03 A <sup>1</sup>
Pulsed only	200 V	1.515 A	50 mA	50 µs to 2.5 ms	2.5 %		
	180 V	1.05 A	50 mA	50 µs to 10 ms	2.5 %		
	6 V <sup>2</sup>	5.25 A <sup>2</sup>	0.1 A <sup>2</sup>	50 µs to 3 ms <sup>2</sup>	3.0 % <sup>2</sup>		
	6 V	10.5 A	0.5 A	50 µs to 1 ms	2.5 %		

- Max current limitation: For 21 V/1.515 A and 6 V / 3.03 A ranges, total max current is limited by the table in page 12 for using 2 channels. Max current is not limited for using 1 channel only
- Valid for the firmware rev 2.4 or later.

### Minimum pulse width at the given voltage, current and settling conditions:

Source Value	Limit Value	Load	Source Settling (% of range)	Min Pulse Width
200 V	1.5 A	200 Ω	0.1 %	1 ms
6 V	10.5 A	0.6 Ω	0.1 %	0.2 ms
1.5 A	200 V	65 Ω	0.1 %	2.5 ms
10.5 A	6 V	0.5 Ω	0.1 %	0.2 ms
10.5 A <sup>1</sup>	6 V <sup>1</sup>	0.1 Ω <sup>1</sup>	0.1 % <sup>1</sup>	0.1 ms <sup>1</sup>

- Valid for the firmware rev. 2.4 or later. Transient speed mode is set to FAST.

## Sweep capabilities

Sweep mode	Linear, logarithmic(log) or list
Sweep direction	single or double
Type	DC, or pulse
Number of steps	1 to 100,000
Min programmable value to create list sweep waveform	Minimum 10 $\mu$ s with 1 $\mu$ s resolution

## Arbitrary Waveform Generation Capabilities

### Pre-defined waveforms:

Supported waveforms	Sine, Square, Ramp, Triangle, Trapezoid and Exponential
Frequency	1 mHz to 10 kHz
Programmable frequency/timing resolution:	1 $\mu$ Hz nominal (sine), 250 ns(waveforms other than sine)
Frequency accuracy of time base	$\pm$ 50 ppm
Linearity (best-fit)	Voltage Source $\pm$ 0.01% <sup>1</sup> , Current Source $\pm$ 0.01% <sup>2</sup>
THD	Voltage Source -90 dB <sup>3</sup> , Current Source -90 dB <sup>4</sup>

1.  $\pm$ 1 V,  $\pm$ 10 V,  $\pm$ 200 V, open load
2.  $\pm$ 10 mA 1 k $\Omega$  load,  $\pm$ 100 mA 100  $\Omega$  load
3.  $\pm$ 1 V,  $\pm$ 10 V,  $\pm$ 180 V, open load
4.  $\pm$ 1  $\mu$ A 100 k $\Omega$  load,  $\pm$ 10  $\mu$ A 100 k $\Omega$  load,  $\pm$ 10 mA 100  $\Omega$  load

### User-defined waveforms:

Waveform length	1 to 100,000 points
Sample rate	0.001 to 100,000 Sa/s, 250 ns resolution
Storage	Non-volatile memory and USB memory are both available. Non-volatile memory can store one waveform with a length of up to 2500 points. USB memory can store waveforms of up to 100k points.

## Output characteristics

Temperature coefficient(0 to 18 °C and 28 °C to 50 °C)	$\pm$ (0.1 x Accuracy) /°C
Max output power and source/sink limits	31.8 W $\pm$ 6 V@ $\pm$ 3.03 A, $\pm$ 21 V@ $\pm$ 1.515 A, $\pm$ 210 V@ 105 mA, four quadrant source or sink operation
Output location	Channel 1 at front, and channel 2 at rear
Output connectors	Banana jack. Triaxial connections are recommended for sourcing less than 1 nA. A banana jack to triaxial adapter is available for low current source.
Low terminal connection	Chassis grounded or floating
Sensing Modes	2-wire or 4-wire (Remote-sensing) connections
Maximum load	Normal mode: 0.01 $\mu$ F High capacitance mode: 50 $\mu$ F
DC floating voltage	Max $\pm$ 250 V DC between low force and chassis ground
Guard offset voltage (V source)	< 4 mV
Remote sense operation range	Max voltage between High Force and High Sense = 3 V Max voltage between Low Force and Low Sense = 3 V
Common mode isolation	> 1 G $\Omega$ , < 4500 pF
Max sense lead resistance	1 k $\Omega$ for rated accuracy
Sense input impedance	> 10 G $\Omega$
Current limit/compliance	Accuracy is same as current source. Min value is 1 % of range, or 1 nA in 10 nA range.
Voltage limit/compliance	Accuracy is same as voltage source. Min value is 1 % of range, or 20 mV in 200 mV range
Over range	101 % of source range for 1.5 A and 3 A ranges. 105 % of source range other than 1.5 A and 3 A ranges. No over range for 200 V range with current exceeding 105 mA pulse only condition.
Over temperature protection	Output turns off then resets at over temperature sensed internally

## Voltage source:

Settling time: Time required to reach within 0.1 % of final value at open load condition. Step is 10 % to 90 % range

Voltage range	Settling time
200 mV	< 50 $\mu$ s
2 V	< 50 $\mu$ s
20 V	< 110 $\mu$ s
200 V	< 700 $\mu$ s

### Slew rate/small signal bandwidth

Current range	Voltage Range				Load resistance
	200 mV	2 V	20 V	200 V	
1 mA	44 mV/ $\mu$ s, 28 kHz	57 mV/ $\mu$ s, 18 kHz	57 mV/ $\mu$ s, 28 kHz	57 mV/ $\mu$ s, 28 kHz	10 M $\Omega$
10 mA	44 mV/ $\mu$ s, 28 kHz	360 mV/ $\mu$ s, 20 kHz	360 mV/ $\mu$ s, 17 kHz	360 mV/ $\mu$ s, 28 kHz	10 M $\Omega$
100 mA	28 mV/ $\mu$ s, 28 kHz	28 mV/ $\mu$ s, 20 kHz	28 mV/ $\mu$ s, 28 kHz	57 mV/ $\mu$ s, 28 kHz	10 M $\Omega$
1 A	25 mV/ $\mu$ s, 28 kHz	25 mV/ $\mu$ s, 28 kHz	25 mV/ $\mu$ s, 28 kHz		10 M $\Omega$
1.5 A	36 mV/ $\mu$ s, 28 kHz	36 mV/ $\mu$ s, 18 kHz	36 mV/ $\mu$ s, 28 kHz		10 M $\Omega$
3 A	27 mV/ $\mu$ s, 28 kHz	27 mV/ $\mu$ s, 28 kHz	27 mV/ $\mu$ s, 28 kHz		$\Omega$

Note: Slew rate and small signal bandwidth can be down to -20% in maximum.

Noise 10 Hz to 20 MHz	< 3 mVrms, 20 V range, without external filter
V source overshoot	< $\pm(0.1\% + 10\text{ mV})$ . Step is 10 % to 90 % range, resistive load
Voltage source range change overshoot	$\leq 250\text{ mV}$ . 100 k $\Omega$ load, 20 MHz bandwidth
Line regulation/load regulation	Included in voltage source specifications. Load transient recovery time

Time to recover to within the settling band following a load change.

	100 mA current change <sup>1</sup>	800 mA current change <sup>2</sup>
Settling band	$\pm 20\text{ mV}$	$\pm 20\text{ mV}$
Time	10 $\mu$ s	30 $\mu$ s

1. At a load change to change the flowing current from +50 mA to +150 mA, 10 V voltage force, 20 V range, 1 A limit.

2. At a load change to change the flowing current from +100 mA to +900 mA, 10 V voltage force, 20 V range, 1.5 A limit.

## Current source:

Settling time: Time required to reach within 0.1 % of final value at open load condition. Step is 10 % to 90 % range

Current range	Settling time
10 nA, 100 nA	< 10 ms
1 $\mu$ A	< 500 $\mu$ s
10 $\mu$ A, 100 $\mu$ A	< 250 $\mu$ s
1 mA, 10 mA, 100 mA	< 80 $\mu$ s
1 A, 1.5 A, 3 A	< 80 $\mu$ s

### Slew rate/small signal bandwidth

Current range	Voltage Range				Load resistance
	200 mV	2 V	20 V	200 V	
1 mA	94 $\mu$ A/ $\mu$ s, 21 kHz	160 $\mu$ A/ $\mu$ s, 21 kHz	160 $\mu$ A/ $\mu$ s, 21 kHz	150 $\mu$ A/ $\mu$ s, 21 kHz	100 $\Omega$
10 mA	94 $\mu$ A/ $\mu$ s, 21 kHz	670 $\mu$ A/ $\mu$ s, 21 kHz	900 $\mu$ A/ $\mu$ s, 21 kHz	900 $\mu$ A/ $\mu$ s, 21 kHz	100 $\Omega$
100 mA	8 mA/ $\mu$ s, 10 kHz	8 mA/ $\mu$ s, 10 kHz	8 mA/ $\mu$ s, 10 kHz	12 mA/ $\mu$ s, 21 kHz	1 $\Omega$
1 A	78 mA/ $\mu$ s, 12 kHz	94 mA/ $\mu$ s, 12 kHz	92 mA/ $\mu$ s, 12 kHz		0.1 $\Omega$
1.5 A	125 mA/ $\mu$ s, 12 kHz	135 mA/ $\mu$ s, 12 kHz	140 mA/ $\mu$ s, 12 kHz		0.1 $\Omega$
3 A	250 mA/ $\mu$ s, 13 kHz	270 mA/ $\mu$ s, 13 kHz	260 mA/ $\mu$ s, 13 kHz		0.041 $\Omega$

Note: Slew rate and small signal bandwidth can be down to -20% in maximum.

I source overshoot	< ±0.1 % (< ±0.3 % for 3 A range). Step is 10 % to 90 % range, resistive load
Current source range change overshoot	≤ 250 mV/R load, 20 MHz bandwidth
Line regulation/load regulation	Included in current source specifications.

## High capacitance mode

The high capacitance mode supports sources and measurements when the load capacitance is greater than 0.01 µF. In high capacitance mode the maximum allowed load capacitance value is 50 µF.

	Time required to reach within 0.1 % of final value with 4.7 µF capacitive load on a fixed range at specified current range and limit value		
Voltage output settling time:	200 mV, 2 V ranges	600 µs, at 1 A limit	
	20 V range	1.5 ms, at 1 A limit	
	200 V range	20 ms, at 100 mA limit	
	Time required to reach 0.1 % of final value after the voltage source stabilized in a fixed range. Vout is 5 V unless noted.		
Current measurement settling time	1 µA range	230 ms	
	10 µA, 100 µA ranges	23 ms	
	1 mA, 10 mA ranges	0.23 ms	
	100 mA to 3 A ranges	100 µs	
Mode change delay			
	Delay into high cap mode	1 µA range	230 ms
		10 µA, 100 µA ranges	23 ms
		1 mA to 3 A ranges	1 ms
Delay out of high cap mode	All ranges	10 ms	
Noise 10 Hz to 20 MHz (20 V range)		4.5 mVrms	
Voltage source range change overshoot (20 V range or below)		< 250 mV, 20 MHz bandwidth	
High capacitance mode working conditions	V/I mode: Voltage source mode only Range: Current measurement range is limited to fixed range only. 10 nA and 100 nA ranges are not available.		
Current limit		≥ 1 µA	

## Programmable output resistance\*

In its default state the Keysight B2961A/B2962A behaves like either an ideal voltage source with a negligibly small source resistance or an ideal current source with a huge source resistance. The programmable output resistance feature allows you to specify either a particular output resistance or a specific voltage versus current source characteristic. This feature is ideal for emulating a wide variety of devices (such as batteries, photovoltaic cells, sensors, transducers, etc.) that are otherwise difficult to simulate.

Mode	Constant or V/I Emulation	
Programmable resistance range:	Series resistance (Rs) at voltage source	- (Load Resistance/2) ≤ Rs ≤ Load Resistance, for resistive load Rs ≤ 25 Ω at 3 A range, ≤ 100 Ω at 1 A and 1.5 A ranges, ≤ 1 kΩ at 100 mA range, or ≤ 10 kΩ at other ranges, Rs can be limited by capacitive load.
	Shunt resistance (Rsh) at current source	Load Resistance ≤ Rsh ≤ 2 GΩ, for resistive load Rsh ≥ 10 MΩ at 10 nA and 100 nA ranges, ≥ 1 MΩ at other ranges, Rsh can be limited by capacitive load.
Emulation mode	Emulation mode allows you to program a non-linear resistance. You specify the desired voltage/current characteristic using a tabular format	
	Max number of points:	16 (piecewise linear interpolation between points)

\* Programmable output resistance is only available for DC output.



## External low noise filter supplemental characteristics

The Keysight B2961A/B2962A supports dedicated external low-noise filters; they are available as an option or as an accessory. They connect to the banana jack outputs of each Keysight B2961A/B2962A channel.

### High Current Ultra Low Noise Filter (N1294A-020)

Maximum output range	21 V / 500 mA (DC)		
Output connector	BNC		
Output/residual resistance	10 $\Omega$ nominal (2-wire), 0.3 $\Omega$ nominal (4-wire. 4-wire connected inside of filter)		
Small signal bandwidth	23 Hz nominal (2-wire), 8 Hz nominal (4-wire)		
Noise	Voltage source	0.1 to 10 Hz	Same as voltage specification
		10 to 20 MHz	10 $\mu$ Vrms, 1nVrms/Hz at 10 kHz (20 V / 100 mA range, 50 $\Omega$ load)
	Current source	0.1 to 10 Hz:	Same as current specification
		10 to 1 MHz	8 $\mu$ Arms (20 V / 1 A range, 2 $\Omega$ load)
Settling time	Voltage source <sup>1</sup>	80 ms (2-wire), 140 ms (4-wire)	
	Current source <sup>2</sup>	11 ms (2-wire), 150 ms (4-wire)	

1. Time required to reach within 0.1 % of final value at open load condition. Step is 10 % to 90 % range. At 20 V range, 500 mA limit/1 A range
2. Time required to reach within 0.1 % of final value at short condition. Step is 10 % to 90 % range. At 500 mA (1 A) range, 20 V limit / 20V range

Load transient recovery time:	Time to recover to within the settling band following a load change.
	250 mA current change <sup>1</sup>
Settling band	$\pm$ 20 mV
Time	50 ms (2-wire), 85 ms (4-wire)

1. At a load change to change the flowing current from +10 mA to +260 mA, 10 V voltage force, 20 V range, 500 mA limit.

Supported ranges	Voltage	200 mV to 200 V ranges (21 V maximum)
	Current	1 mA to 1 A ranges (500 mA maximum)
Maximum capacitive load	50 $\mu$ F (for 4-wire)	
Dimensions	41 mm H x 58.2 mm W x 141.5 mm D (When the filter is inserted to the output connector of B2961A/B2962A, the depth is 126.5 mm.)	
Weight	0.3 kg	

#### Note:

- The 10 A pulse range and programmable output resistance capability are not supported by external filters.
- For the current output, only DC is supported when using with external filters.
- The current measurement data monitored by the built-in voltage/current monitor can be influenced by the charge and discharge current of the capacitance inside of the filters.

### Ultra Low Noise Filter (N1294A-021)

Max output range	42 V / 105 mA (DC)		
Output connector	BNC		
Output / residual resistance	50 $\Omega$ nominal (2-wire), 0.3 $\Omega$ nominal (4-wire. 4-wire connected inside of filter)		
Small signal bandwidth	23 Hz nominal (2-wire), 8 Hz nominal (4-wire)		
Noise	Voltage source	0.1 to 10 Hz	Same as voltage specification
		10 to 20 MHz	10 $\mu$ Vrms, 1 nVrms/ $\sqrt{\text{Hz}}$ at 10 kHz (20 V / 100 mA range, 50 $\Omega$ load)
	Current source	0.1 to 10 Hz	Same as current specification
		10 to 1 MHz	300 nArms (20 V / 100 mA range, 10 $\Omega$ load)
Settling time	Voltage source <sup>1</sup>	80 ms (2-wire), 140 ms (4-wire)	
	Current source <sup>2</sup>	11 ms (2-wire), 150 ms (4-wire)	

1. Time required to reach within 0.1 % of final value at open load condition. Step is 10 % to 90 % range. At 20 V range, 100 mA limit/100 mA range
2. Time required to reach within 0.1 % of final value at short condition. Step is 10 % to 90 % range. At 100 mA range, 20 V limit / 20V range

Load transient recovery time:	Time to recover to within the settling band following a load change.
	50 mA current change <sup>1</sup>
Settling band	$\pm$ 20 mV
Time	50 ms (2-wire), 85 ms (4-wire)

1. At a load change to change the flowing current from +10 mA to +60 mA, 10 V voltage force, 20 V range, 100 mA limit

Supported ranges	Voltage	200 mV to 200 V ranges (42 V max)
	Current	10 $\mu$ A to 100 mA ranges (105 mA max)
Maximum capacitive load	50 $\mu$ F (for 4-wire)	
Dimensions	41 mm H x 58.2 mm W x 141.5 mm D (When the filter is inserted to the output connector of B2961A/ B2962A, the depth is 126.5 mm.)	
Weight	0.3 kg	

#### Note:

- The 10 A pulse range and programmable output resistance capability are not supported by external filters.
- For the current output, only DC is supported when using with external filters.
- The current measurement data monitored by the built-in voltage/current monitor can be influenced by the charge and discharge current of the capacitance inside of the filters.

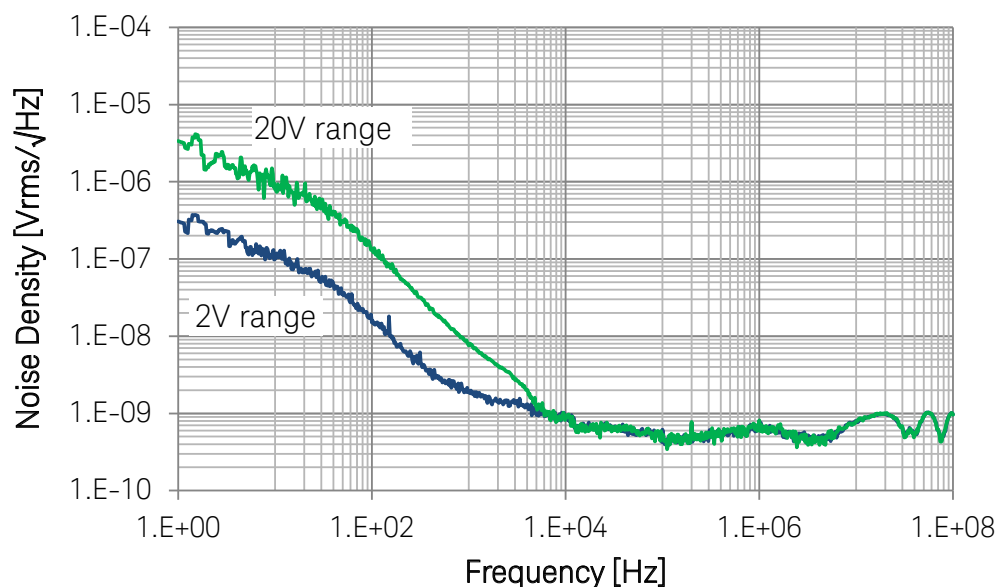

Low Noise Filter (N1294A-022)

Maximum output range	210 V / 3 A (DC)		
Output connector	Banana, 2-wire/4-wire		
Output / residual resistance	0.3 $\Omega$ nominal (2-wire)		
Small signal bandwidth	2 kHz nominal (1 A and 3 A ranges), 800 Hz nominal (100 mA range)		
Noise	Voltage source	0.1 to 10 Hz	Same as voltage specification
		10 to 20 MHz	350 $\mu$ Vrms (20 V / 1.5 A range, 50 $\Omega$ load)
	Current source	0.1 to 10 Hz:	Same as current specification
		10 to 1 MHz	450 $\mu$ Arms (20 V / 1.5 A range, 0.67 $\Omega$ load)
Settling time	Voltage source <sup>1</sup>	640 $\mu$ s (2-wire/4-wire)	
	Current source <sup>2</sup>	1.2 ms (2-wire/4-wire)	

1. Time required to reach within 0.1 % of final value at open load condition. Step is 10 % to 90 % range. At 20 V range, 1.5 A limit/1.5 A range
2. Time required to reach within 0.1 % of final value at short condition. Step is 10 % to 90 % range. At 1.5 A range, 20 V limit / 20V range

Load transient recovery time:	Time to recover to within the settling band following a load change. 800 mA current change <sup>1</sup>
Settling band	$\pm$ 20 mV
Time	450 $\mu$ s (2-wire), 650 $\mu$ s (4-wire)

1. At a load change to change the flowing current from +100 mA to +900 mA, 10 V voltage force, 20 V range, 1.5 A limit

Supported ranges	Voltage	200 mV to 200 V ranges (210 V max)
	Current	10 $\mu$ A to 3 A ranges (3 A max)
Maximum capacitive load	1 mF	
Dimensions	41.5 mm H x 58.2 mm W x 127.5 mm D (When the filter is inserted to the output connector of B2961A/ B2962A, the depth is 112.5 mm.)	
Weight	0.25 kg	

Note:

- The 10 A pulse range and programmable output resistance capability are not supported by external filters.
- For the current output, only DC is supported when using with external filters.
- The current measurement data monitored by the built-in voltage/current monitor can be influenced by the charge and discharge current of the capacitance inside of the filters.

## Keysight B2900A Family

The B2900A series is a member of B2900 Precision Instrument Family, which provide a variety of precision measurement solutions with both sourcing and measurement capabilities. The B2900A series of Source Measure Units (SMUs) have 6.5-digit resolution, enabling 100 nV/10 fA sourcing and measurement. The B2980A series of picoammeter/electrometer have down to 0.01fA and up to 10 P $\Omega$ . Further information on the B2900 Precision Instrument Family is available at <http://www.keysight.com/find/b2900a>.



B2980A Picoammeter and Electrometer/High R meter



B2900A Source Measure Unit

## Built-in voltage/current monitor specifications

### Voltage measurement specifications

Range	Measurement Resolution	Accuracy (% reading + offset)
±200 mV	10 µV	±(0.015 % + 225 µV)
±2 V	100 µV	±(0.02 % + 350 µV)
±20 V	1 mV	±(0.015 % + 5 mV)
±200 V	10 mV	±(0.015 % + 50 mV)

### Current measurement specifications

Range	Measurement Resolution	Accuracy (% reading + offset)
±10 nA	1 pA	±(0.10 % + 50 pA)
±100 nA	10 pA	±(0.06 % + 100 pA)
±1 µA	100 pA	±(0.025 % + 500 pA)
±10 µA	1 nA	±(0.025 % + 1.5 nA)
±100 µA	10 nA	±(0.02 % + 25 nA)
±1 mA	100 nA	±(0.02 % + 200 nA)
±10 mA	1 µA	±(0.02 % + 2.5 µA)
±100 mA	10 µA	±(0.02 % + 20 µA)
±1 A	100 µA	±(0.03 % + 1.5 mA)
±1.5 A	100 µA	±(0.05 % + 3.5 mA)
±3 A	1 mA	±(0.4 % + 7 mA)
±10 A <sup>1</sup>	1 mA	±(0.4 % + 25 mA) <sup>2</sup>

1. 10 A range is available only for pulse mode, not available for DC mode.

2. Measurement speed: 0.01 PLC

## Built-in voltage/current monitor supplemental characteristics

Temperature coefficient(0 to 18 °C and 28 °C to 50 °C)	± (0.1 x Accuracy) /°C
Over range	102 % of measurement range for 1.5 A and 3 A ranges 106 % of measurement range other than 1.5 A and 3 A ranges
Voltage measurement range change overshoot	< 250 mV. 100 kΩ load, 20 MHz bandwidth
Current measurement range change overshoot	< 250 mV/R load, 20 MHz bandwidth

Derating accuracy for measurement speed less than 1 PLC: Add % of range using the following table for measurement with PLC < 1

Derating accuracy with PLC setting < 1 PLC

	Voltage Range		Current Range			
	0.2 V	2 V to 200 V	10 nA	100 nA	1 µA to 100 mA	1 A to 3 A
0.1 PLC	0.01 %	0.01 %	0.1 %	0.01 %	0.01 %	0.01 %
0.01 PLC	0.05 %	0.02 %	1 %	0.1 %	0.05 %	0.02 %
0.001 PLC	0.5 %	0.2 %	5 %	1 %	0.5 %	0.2 %

## Timer and triggering specification

Timer	Time stamp	TIMER value automatically saved when each measurement is triggered
	Trigger timing resolution	1 $\mu$ s to 100 ms
	Accuracy	$\pm$ 50 ppm
	Arm/trigger delay	0 $\mu$ s to 100,000 s
	Arm/trigger interval	10 $\mu$ s to 100,000 s
	Arm/trigger event	1 to 100,000
Triggering <sup>1</sup>	Digital I/O Trigger in to trigger out	$\leq$ 5 $\mu$ s
	Digital I/O Trigger in to source change	$\leq$ 5 $\mu$ s
	LXI Trigger in to source change	Min 100 $\mu$ s, Typical 200 $\mu$ s, Max Unknown
	LXI Trigger in to measurement	Min 100 $\mu$ s, Typical 200 $\mu$ s, Max Unknown
	Internal event to external LXI trigger output	Min 100 $\mu$ s, Typical 200 $\mu$ s, Max unknown
	LXI event send/receive latency	Unknown
	Min trigger interval	10 $\mu$ s

1. Supplemental characteristics

## Environmental specifications

Environment	For use in indoor facilities	
Operating	0 °C to +55 °C, 30 % to 80 % non-condensing	
Storage	-30 °C to 70 °C, 10 % to 90 % non-condensing	
Altitude	Operating: 0 m to 2000 m, Storage: 0 m to 4600 m	
Power supply	90 V to 264 V, 47 Hz to 63 Hz, 250 VA max	
Cooling	Forced air. Side intake and rear exhaust.	
EMC	IEC61326-1/EN61326-1, AS/NZS CISPR 11, KC: RRA Notification amending Radio Waves Act Article 58-2	
Safety	IEC61010-1/EN61010-1, CAN/CSA-C22.2 No. 61010-1-04, C/US	
Certifications	CE, cCSAus, C-Tick, KC	
Dimensions	Case	88 mm H x 213 mm W x 450 mm D
	Working	180 mm H x 260 mm W x 480 mm D (with handle & feet)
Weight	Net	5.1 kg (B2961A), 6.5 kg (B2962A)
	Shipping	7.6 kg (B2961A), 9.0 kg (B2962A)

### Front Panel Operation

Front panel interface	4.3" TFT color display (480x272, with LED backlight) with keypads and rotary knob
View mode	Single view, Dual view and Graph view
Hardkeys	Single Trigger and Auto Trigger control, 10-key, Rotary Knob and Cursors, Channel on/off, View, Cancel/Local
Softkeys	Function, System and Input Assist Keys
Indicators	Channel (measurement) status, System status

### Data Buffers

Max buffer size:	100,000 points / channel
------------------	--------------------------

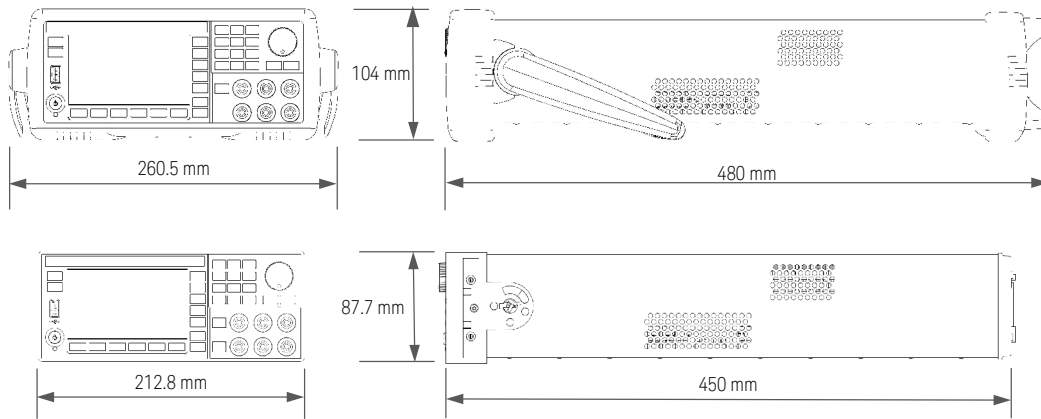

### Input/Output Connectivity

GPIB	IEEE-488.2	
Ethernet	100BASE-T / 10BASE-T	
USB	USB 2.0 host controller(front), USB 2.0 device interface (rear)	
Digital I/O	Connector type	25-pin female D.
	Input/output pins	14 open drain I/O bits
	Absolute max input voltage	5.25 V
	Absolute min input voltage	- 0.25 V
	Logic low max input voltage	0.8 V
	Logic high min input voltage	2.0 V
	Max source current	1 mA @ $V_{out} = 0$ V
	Max sink current	50 mA @ $V_{out} = 5$ V
	5 V power supply pin	Limited to 500 mA, solid state fuse protected
	Safety interlock pin:	One active high pin and one active low pin. Activation of both pin enables output voltage > 42 V
	Max number of simultaneously triggered units (using Digital I/O) <sup>1</sup> :	8

1. Supplemental characteristic

### Program, Software and Drivers

Programming	SCPI
Program memory	100 kB (2500 lines typical)
LXI compliance	LXI Core Conformant
Software available	Quick I/V Measurement Software, Graphical Web Interface, BenchVue
Drivers available	IVI-C, IVI-COM drivers, LabVIEW drivers

## Software Prerequisites

Quick IV	Operating system	Windows 7 (64 bit/32 bit)
	Supporting language	English (US)
	.NET Framework	Microsoft .NET, Framework 4.0 or later
	IO Libraries	16.0 or later
Interfaces		USB, GPIB, LAN
BenchVue	Operating system	Windows 10 32-bit and 64-bit (Professional, Enterprise, Education, Home versions) Windows 8 32-bit and 64-bit (Professional, Enterprise, Core) Windows 7 SP1 and later 32-bit and 64-bit (Professional, Enterprise, Ultimate, Home Basic, Home Premium)
	HDD	Processor: 1 GHz or faster (2 GHz or greater recommended) RAM: 1 GB (32-bit) or 2 GB (64-bit) (3 GB or greater recommended)
	Display resolution	1024 x 768 minimum for single instrument view (higher resolutions are recommended for multiple instrument view)
	Interfaces	USB, GPIB, LAN, RS-232 <sup>1</sup>

1. RS-232 Interface is not available on B2900 family.

## Furnished Accessories

Power cable, USB cable, Quick Reference (English), CD-ROMs (including PDF manuals, Quick I/V Measurement Software and drivers), Keysight I/O Library suite

## Ordering Information

Model Number	Description
B2961A	6.5 Digit Low Noise Power Source, 32 W, 210 V, 3 A, 1ch
B2962A	6.5 Digit Low Noise Power Source, 32 W, 210 V, 3 A, 2ch
Options	
ABA	Printed manual English (User's Guide)
ABJ	Printed manual Japanese (User's Guide)
A6J	ANSI Z540 calibration
UK6	Commercial calibration certificate with test data
Accessories	
N1294A-001	Banana - Triax adapter for 2-wire (non Kelvin) connection
N1294A-002	Banana - Triax adapter for 4-wire (Kelvin) connection
N1294A-011	1.5m, Interlock cable for 16442A/B test fixture (GPIO Dsub25 to 6pin mini plug)
N1294A-012	3m, Interlock cable for 16442A/B test fixture (GPIO Dsub25 to 6pin mini plug)
N1294A-020	High current ultra low noise filter, 21 V/500 mA, 10 $\Omega$
N1294A-021	Ultra low noise filter, 42V/105mA, 50 $\Omega$
N1294A-022	Low noise filter, 210V/3A
N1294A-031	GPIO-BNC trigger adapter
16494A-001	Low leakage triax cable (1.5 m)
16494A-002	Low leakage triax cable (3.0 m)
16494A-003	Low leakage triax cable (80 cm)
16494A-004	Low leakage triax cable (40 cm)
16494A-005	Low leakage triax cable (4.0 m)
34190A	Rack Mount Kit

Learn more at: [www.keysight.com](http://www.keysight.com)

For more information on Keysight Technologies' products, applications or services, please contact your local Keysight office. The complete list is available at: [www.keysight.com/find/contactus](http://www.keysight.com/find/contactus)

