

# R&S®NRP POWER METER FAMILY

Trust your power measurements



Product Brochure  
Version 16.00

**ROHDE & SCHWARZ**

Make ideas real



# AT A GLANCE

The most important features for accurate and uncomplicated power measurements are top measurement accuracy and speed as well as simple operation on a base unit or a laptop/PC. The R&S®NRP power meter family combines all these characteristics in the R&S®NRX base unit, R&S®NRPV virtual power meter PC software and a comprehensive portfolio of LAN and USB power sensors. The R&S®NRP family is ideal for use in production, R&D and calibration labs as well as for installation and maintenance tasks.

All R&S®NRP power sensors are independent measuring instruments. Using a USB adapter, they can be directly connected to a laptop/PC and operated via the R&S®NRPV software.

The compact, robust R&S®NRX base unit with color touch display supports up to four R&S®NRP power sensors and all sensor-dependent measurement functions. Measured values are displayed numerically or graphically, depending on the measurement function. The high resolution graphical user interface allows simple, intuitive operation; the base unit can be remotely controlled via Ethernet, GPIB or USB.

## Key facts

- ▶ Cost-effective and compact: sensor operation on a laptop/PC via USB
- ▶ R&S®NRPxxSN/TN/TWGN/AN LAN models: measurements over any distance via built-in web GUI and powered with PoE
- ▶ Comprehensive portfolio for power measurements from DC to 170 GHz, from  $-70$  dBm to  $+45$  dBm
- ▶ Up to 93 dB dynamic range with three-path diode power sensors
- ▶ Precise analysis of envelope power with pulse power sensors
- ▶ Top accuracy with thermal power sensors
- ▶ Up to four R&S®NRP power sensors can be simultaneously connected to the R&S®NRX base unit



# BENEFITS AND KEY FEATURES

## Functions and performance features

- ▶ Fully characterized power sensors
- ▶ Minimizes measurement uncertainty
- ▶ Intelligent averaging function minimizes measurement time
- ▶ Versatile measurement functions

## Additional features of R&S®NRPxxS(N)/P/T(N)/TWG(N)/A(N)/E

- ▶ USBTMC for easy system integration
- ▶ Built-in trigger I/O port
- ▶ Sensor status at a glance with status LED
- ▶ Detachable cables for flexible operation
- ▶ [page 4](#)

## Intelligent, LAN power measurements

- ▶ Almost every sensor available as LAN model
- ▶ Remote monitoring via LAN over any distance
- ▶ Power supply via Power over Ethernet (PoE)
- ▶ Built-in web GUI with full power measurement support
- ▶ [page 9](#)

## R&S®NRX versatile, user-friendly base unit

- ▶ Straightforward numerical and graphical display of measured values, plus intuitive operation
- ▶ Hardware interfaces for remote control and triggering
- ▶ Expandable to up to four measurement channels
- ▶ Flexible sensor interfaces
- ▶ Power reflection measurements
- ▶ Code emulation of the R&S®NRP2
- ▶ Sensor check source
- ▶ [page 7](#)

## R&S®NRPV: convenient power measurements via PC application

- ▶ Sophisticated PC application
- ▶ Multifunctional trace mode window
- ▶ Extremely flexible marker functions
- ▶ Intelligent licensing concept: dongle-free on multiple PCs
- ▶ [page 24](#)

Versatile use of the R&S®NRP power sensors			Available measurement functions (modes)				
Sensor type	Features	Continuous average	Trace	Timeslot/time gate	Burst average	Statistics	
R&S®NRPxxS(N) three-path diode power sensors ▶ <a href="#">page 11</a>	fast, accurate and packed with features to measure CW and modulated signals	•	•	•	•	–	
R&S®NRPxxSN-V TVAC-compliant three-path diode power sensors ▶ <a href="#">page 14</a>	specially designed for use in thermal vacuum (TVAC) chambers	•	•	•	•	–	
R&S®NRPxxT(N)/TWG(N) thermal power sensors ▶ <a href="#">page 15</a>	most accurate power measurements for reference applications and use in calibration labs	•	–	–	–	–	
R&S®NRPxxA(N) EMC average power sensors ▶ <a href="#">page 18</a>	accurate average power measurements for EMC applications	•	–	–	–	–	
R&S®NRPxxP pulse power sensors ▶ <a href="#">page 19</a>	time domain analysis and automatic pulse analysis for radar applications and universal use	•	•	•	•	•	
R&S®NRP8E/18E diode power sensors ▶ <a href="#">page 21</a>	cost-effective power measurement solution for production	•	•	•	•	–	
R&S®NRP-Z27/-Z37 power sensor modules ▶ <a href="#">page 22</a>	level calibration of signal sources in conjunction with the R&S®FSMR and R&S®FSMR3000 measuring receivers	•	–	–	–	–	
R&S®NRP-Z28/-Z98 level control sensors ▶ <a href="#">page 23</a>	highly accurate signal level generation in conjunction with a signal generator	•	• <sup>1)</sup>	• <sup>1)</sup>	• <sup>1)</sup>	–	

<sup>1)</sup> R&S®NRP-Z28 only.

# FUNCTIONS AND PERFORMANCE FEATURES

## Fully characterized power sensors

The R&S®NRPxxS(N), R&S®NRPxxT(N), R&S®NRPxxTWG(N), R&S®NRPxxA(N), R&S®NRPxxP and R&S®NRPxE power sensors are immediately ready for use. In contrast to conventional power sensors, no calibration is required prior to making measurements since the sensors are fully characterized over frequency, level and temperature and feature long-term stability. All calibration data is stored in the sensors, so they function as independent measuring instruments. Usually, no zeroing is required. Users can plug in a sensor and simply start measuring.

## Minimizes measurement uncertainty

Even complex test setups are no challenge for the R&S®NRPxxS(N), R&S®NRPxxT(N), R&S®NRPxxTWG(N), R&S®NRPxxA(N), R&S®NRPxxP and R&S®NRPxE power sensors. Unwanted effects such as cable losses and reflections can be compensated using offset, S-parameter and  $\Gamma$  correction. Offset correction is used to take into account frequency-independent attenuation. S-parameter correction is used to mathematically shift the reference plane to the device under test (DUT) by taking into account the S-parameters of any components connected upstream of the sensor.  $\Gamma$  correction compensates for the effects of impedance mismatch between the source and the power sensor.

## Intelligent averaging function minimizes measurement time

With fixed noise averaging (an enhanced auto averaging function), any measurement can be optimized with respect to measurement time and accuracy. The averaging filter is dynamically set to the optimum averaging value to achieve a user-defined maximum noise content. This helps minimize measurement time and maximize production throughput for a user-specified accuracy, and simplify programming of remotely controlled measurement sequences.

## Versatile measurement functions

- ▶ Continuous average mode: reliable average power measurements on CW and modulated signals
- ▶ Burst average mode: burst average power measurements; sensors automatically detect start and end of a burst
- ▶ Trace mode: display of envelope power versus time
- ▶ Timeslot mode: timeslot average power measurements on TDMA signals (e.g. GSM/EDGE)
- ▶ Time gate mode: average power measurements in up to four independent time gates with user-defined position and length

## Shifting the measurement plane from 1 to 2 by using S-parameter correction; the influence of upstream components is compensated

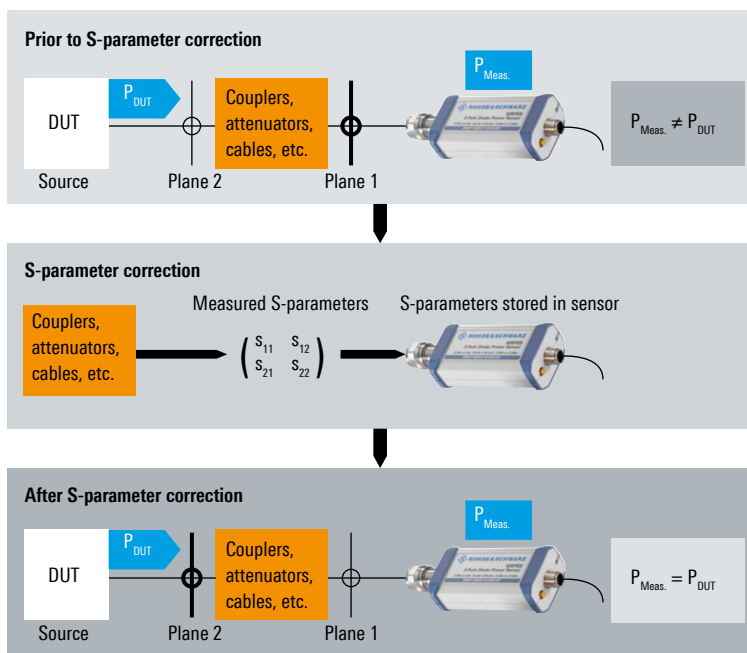



# ADDITIONAL FEATURES OF R&S®NRPxxS(N)/P/T(N)/TWG(N)/A(N)/E

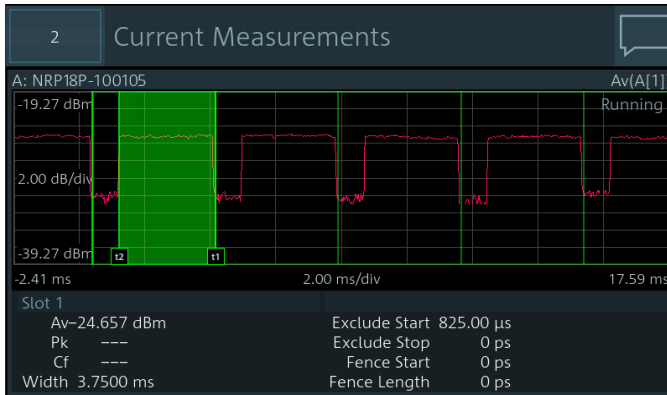

Timeslot measurement of a Bluetooth® signal with exclude start time

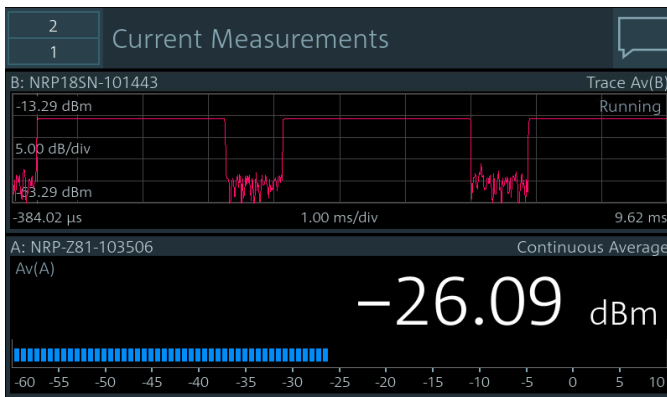

Mixed display of trace and continuous average measurement

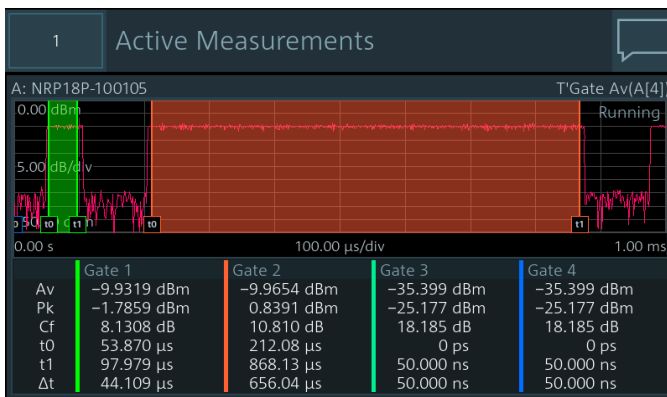

Power determination of a IEEE 802.11g Wi-Fi signal with a beacon and a data block (0.1 ms idle time) using an R&S®NRP18P pulse power sensor and the gate function

## USBTCM for easy system integration

The R&S®NRPxxS(N), R&S®NRPxxP, R&S®NRPxxT(N), R&S®NRPxxTWG(N) and R&S®NRPxxA(N) power sensors are USBTCM devices that can easily be integrated into automated test setups without having to install additional drivers.

R&S®NRPxxS(N), R&S®NRPxxT(N), R&S®NRPxxTWG(N) and R&S®NRPxxA(N) power sensors can replace R&S®NRP legacy power sensors with 100% code compatibility for remote operation.

## Built-in trigger I/O port

The R&S®NRPxxS(N), R&S®NRPxxP, R&S®NRPxxT(N), R&S®NRPxxTWG(N), R&S®NRPxxA(N) and R&S®NRPxE power sensors have integrated trigger capability. To measure power levels below the minimum trigger threshold, an external trigger signal is required. Such signals can be conveniently supplied via the built-in trigger port, which can also be used as a trigger output. In the trigger sender mode, a trigger signal is derived from the measured signal inside the power sensor and output via the trigger port. This feature can be used to determine the input and output power levels of a power amplifier when the level at the amplifier input is too low for an internally triggered measurement, yet the level at the amplifier output is sufficiently high. In this case, the R&S®NRPxxS(N), R&S®NRPxxP, R&S®NRPxxT(N), R&S®NRPxxTWG(N) and R&S®NRPxxA(N) used for measuring the output level acts as the trigger sender to trigger the input level measurement.

## Sensor status at a glance with status LED

A status LED on the sensors allows the sensor status to be viewed from different angles. This is especially advantageous in the case of production racks with many sensors. The LED lights green to indicate error-free measurements. System-related errors, e.g. the absence of a trigger signal, are also indicated by dedicated colors. This allows users to immediately see the operating status of all sensors and quickly respond to problems.

By assigning the same color (RGB value) to a measured trace and the LED of the associated sensor, users can more easily attribute a trace to a specific sensor. This is beneficial when using multiple sensors at the same time.

## Detachable cables for flexible operation

The power sensors come with various, detachable cables for connection to diverse display units. A screw connection is provided on the sensor end to prevent accidental loosening of the cable.

The R&S®NRP-ZKU USB interface cable can be used to connect a power sensor to a laptop/PC via the USB interface. This is an extremely space-saving and also cost-efficient solution that does not require a base unit. Two software tools – R&S®Power Viewer Plus and R&S®NRPV virtual power meter – are available to simplify sensor operation from a laptop/PC. These tools support all measurement functions implemented in the sensors.

The R&S®NRP-ZK6 and R&S®NRP-ZK8 interface cables are intended for operating a power sensor on the R&S®NRX base unit. The R&S®NRP-ZK6 can also be used to connect the power sensor to diverse Rohde & Schwarz signal generators and signal and spectrum analyzers to enhance these instruments with a high-performance power meter.

## Multiple ways to operate the R&S®NRP power sensors

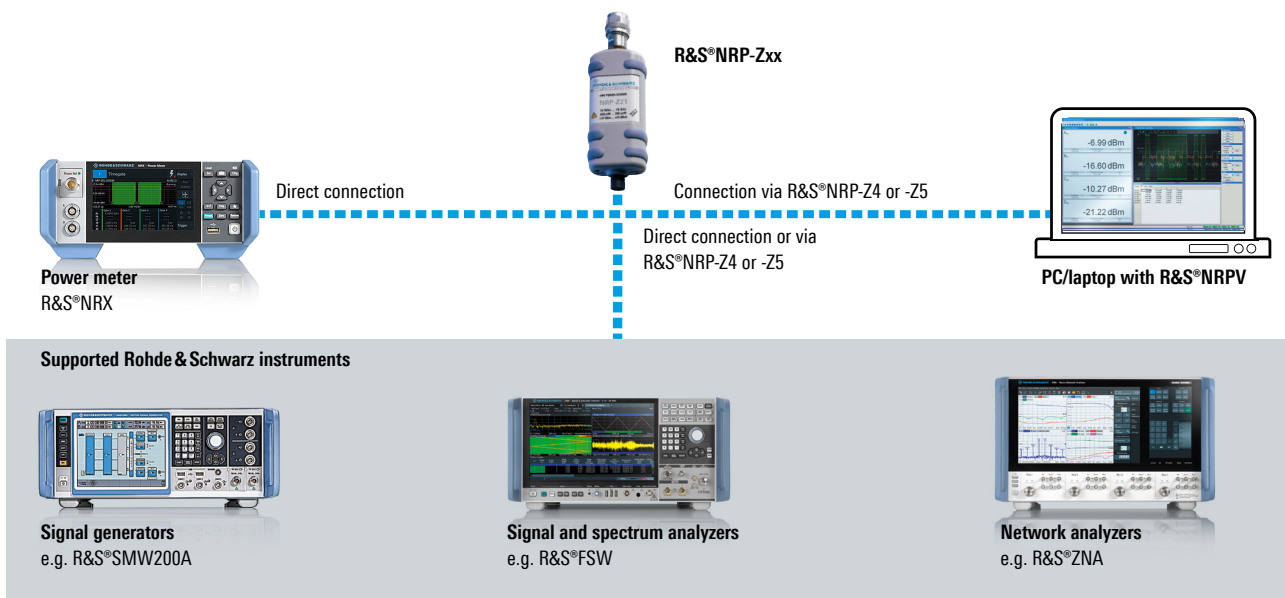
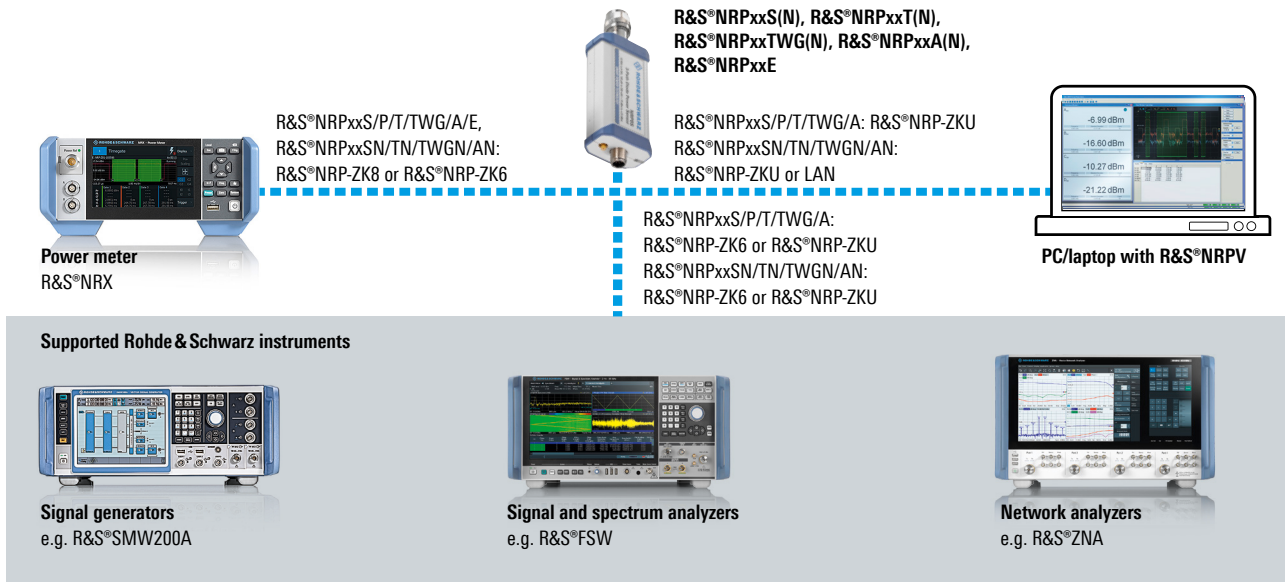

# R&S®NRX VERSATILE, USER-FRIENDLY BASE UNIT

## Straightforward numerical and graphical display of measured values, plus intuitive operation

The R&S®NRX simultaneously supports up to four power sensors of the R&S®NRP and R&S®NRQ family. Function keys on the front panel provide quick access to the most important functions. Users can open the frequency setting menu or zero the connected sensors at the push of a button.

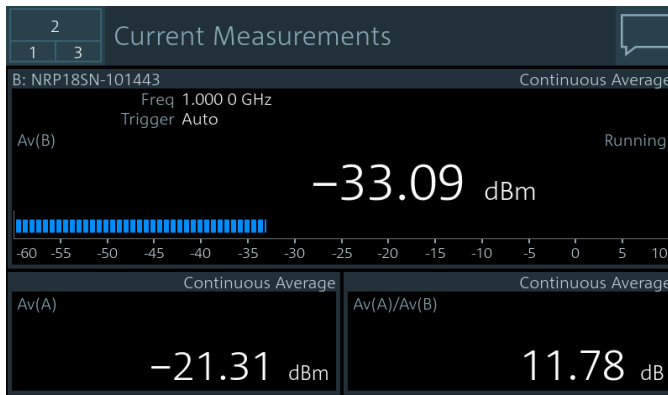

R&S®NRX displays up to four measurements simultaneously

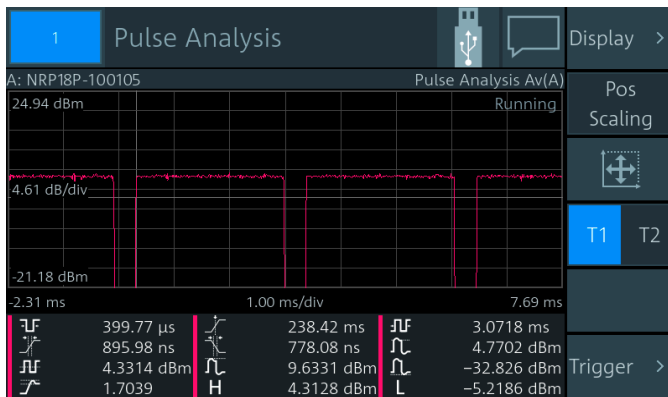

Automatic pulse analysis with the R&S®NRX and R&S®NRP18P

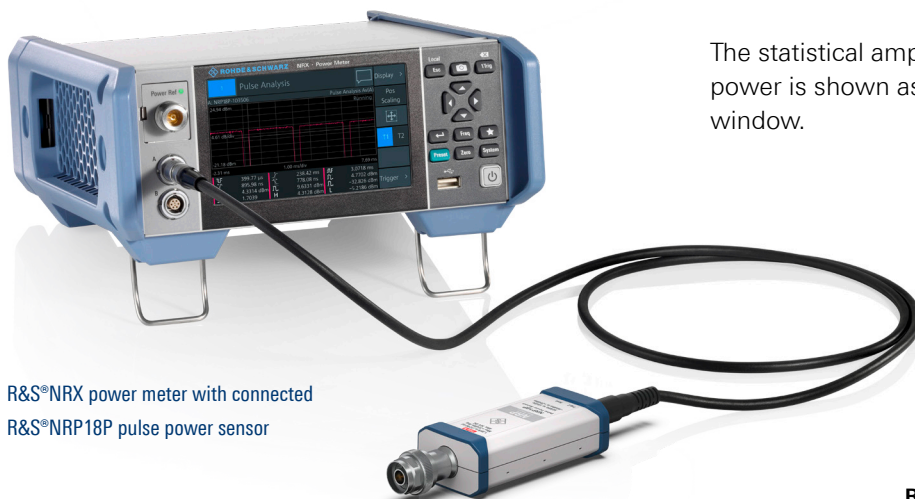

R&S®NRX power meter with connected R&S®NRP18P pulse power sensor

User-programmable save/recall memory locations allow fast access to personal settings. Presets for all major mobile radio standards, such as 3GPP LTE, 3GPP WCDMA, GSM/EDGE, WLAN and Bluetooth®, ensure correct measurement with a minimum of keystrokes.

The 5" TFT color display supports the intuitive, window based operating concept. Key parameters and functions are color-coded and can be seen at a glance.

Results are presented in numerical and graphical display windows that can be easily configured.

In the continuous average, burst average, timeslot and time gate average measurement modes, up to four numerical results can be displayed in parallel. The ratio, SWR, return loss and reflection coefficient can be calculated from two measurement channels using predefined computation functions and displayed in addition to the absolute and relative power level.

Trace measurements and statistical measurements are presented in graphical windows. The trace mode allows simultaneous display of two traces in one measurement window. Level differences and time offset can be seen at a glance and accurately measured using horizontal and vertical markers. It is also possible to display the ratio of two traces.

Timeslots and time gates as well as the associated measurement values (average, peak or crest factor) can be graphically displayed in the trace window.

All R&S®NRPxxP pulse power sensors allow automatic pulse analysis. Up to 12 of 18 user-selected pulse parameters can be displayed in addition to the measurement trace.

The statistical amplitude distribution of the envelope power is shown as CCDF, CDF or PDF in a statistics window.



### Hardware interfaces for remote control and triggering

The R&S®NRX provides three different remote interfaces for integration in automated test setups: Ethernet, USB and optionally GPIB (R&S®NRX-B8).

A trigger input on the rear panel permits external triggering for synchronized power measurements. Using an R&S®NRP18P, for example, a trigger signal can be derived from the measurement signal and output at the trigger output (trigger sender mode). A level-proportional voltage or a digital signal for limit monitoring can be output via BNC connectors.

The modular concept allows users to choose between the R&S®NRX-B9 or the R&S®NRX-B1 option.



### Expandable to up to four measurement channels

The R&S®NRX standard configuration includes one measurement channel. The base unit can be optionally expanded to two (R&S®NRX-K2, software option) or four (R&S®NRX-K2 and R&S®NRX-K4, software options) measurement channels.

### Flexible sensor interfaces

The R&S®NRX provides two sensor connectors on the front and optionally two additional sensor connectors on the rear (R&S®NRX-B4, hardware option). A USB 2.0 interface on the front and the rear provides further connectivity (USB power sensors, memory key, mouse or keyboard).

### Power reflection measurements

The R&S®NRX optionally provides the R&S®NRX-B9 interface for the R&S®NRT2 directional power sensors.

### Code emulation of the R&S®NRP2

The R&S®NRX can interpret the command set of its predecessor, the R&S®NRP2.

### Sensor check source

An optional high-precision 50 MHz/1 GHz reference source module (R&S®NRX-B1 sensor check source) can be used in CW mode to check the function of all R&S®NRP power sensors. In pulse mode, the test generator can be used to check the pulse measurement performance of the R&S®NRPxxP pulse power sensors or the R&S®NRQ frequency selective power sensor.

R&S®NRX rear view



# INTELLIGENT, LAN POWER MEASUREMENTS

## Almost every sensor available as LAN model

Almost every R&S®NRPxxS three-path diode, R&S®NRPxxA average and R&S®NRPxxT(WG) thermal sensor from the R&S®NRP product range is available as a LAN model (R&S®NRPxxSN, R&S®NRPxxAN, R&S®NRPxxTN, R&S®NRPxxTWGN). LAN models are equipped with an additional LAN interface without compromising sensor features and performance.

## Remote monitoring via LAN over any distance

The R&S®NRPxxSN, R&S®NRPxxTN, R&S®NRPxxTWGN and R&S®NRPxxAN LAN power sensors are ideal for remote monitoring applications, e.g. for satellite systems or particle accelerators, where sensors need to be placed at different points in the system. The LAN interface makes it easy to overcome large distances between the various test points and the control center.



LAN interface, trigger I/O port and detachable cable for the R&S®NRPxxSN sensors



Operation of R&S®NRPxxSN power sensor via a web browser

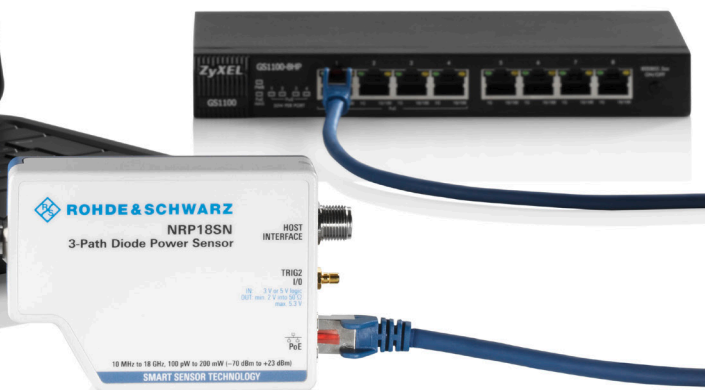



### Power supply via Power over Ethernet (PoE)

In LAN operation, the sensors are powered via a PoE-capable LAN interface on the power sensor. If the LAN used does not support the PoE standard, then the sensors are connected to the LAN via a PoE compliant switch.

### Built-in web GUI with full power measurement support

The R&S®NRPxxSN, R&S®NRPxxTN, R&S®NRPxxTWGN and R&S®NRPxxAN can be operated via a web interface. Using a PC connected to the internet, the power sensors can be conveniently controlled via a web browser – no additional software needs to be installed.

### Simultaneous, location-independent remote monitoring of multiple R&S®NRPxxSN/TN/TWGN/AN power sensors using a web browser

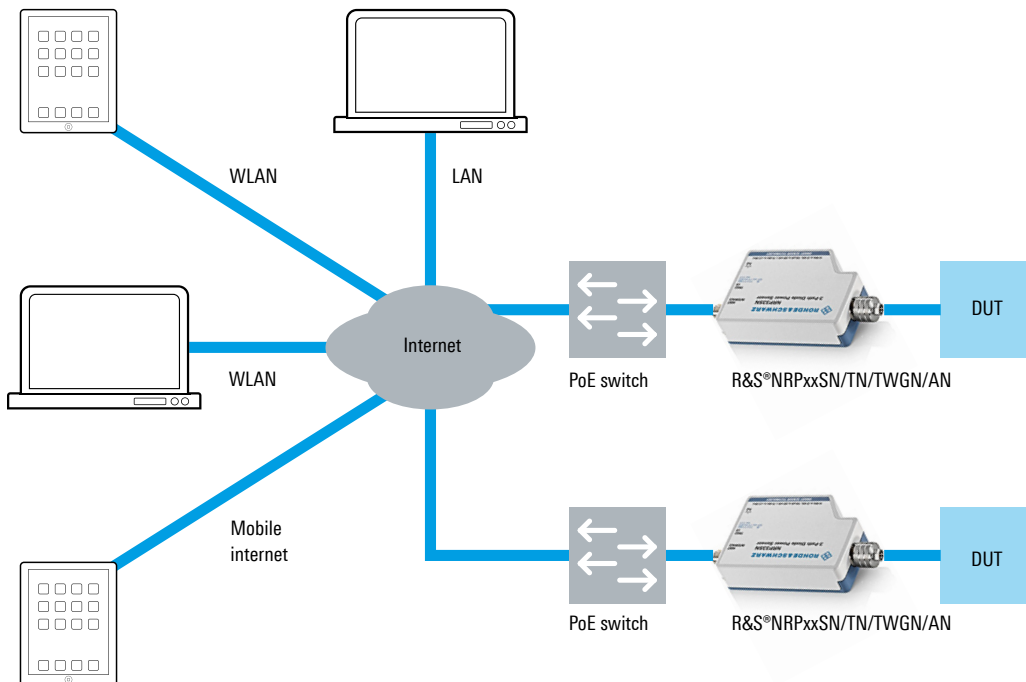

# THREE-PATH DIODE POWER SENSORS

## Ideal for universal applications

Three-path diode power sensors are suitable for numerous applications since they support continuous average, burst average, timeslot average, gate average and trace measurements. Featuring outstanding performance and unprecedented measurement speed and accuracy, the sensors can be used to perform precise average power measurements on wireless signals ranging from GSM and LTE up to 5G NR. For detailed analysis, the sensors offer additional measurement functions such as timeslot mode and trace mode with a video bandwidth of 100 kHz.

Offering a frequency range of up to 33 GHz, the R&S®NRP33S(N) is ideal for use in the automotive sector, for example in the development and production of long-range and short-range anti-collision radars (24 GHz). It is also a perfect choice for installation, maintenance and remote monitoring of ground stations for satellite systems (up to 33 GHz).

The R&S®NRP40S(N) and R&S®NRP50S(N) are ideal for measurements on microwave link systems operating at frequencies up to 50 GHz. The user benefits from short measurement times and the sensors' wide dynamic range.

The R&S®NRP67S(N) supports frequencies up to 67 GHz including IEEE 802.11ad and parts of IEEE 802.11ay as well as in-cabin radar in the automotive sector.

The R&S®NRP90S(N) is ideal for applications in or reaching into E band, such as IEEE 802.11ay, mobile back-haul, 77 GHz automotive radar or higher band satellite communications.

## 93 dB dynamic range thanks to improved three-path concept

The R&S®NRPxxS(N) power sensors use three separate diode paths, each operated in the optimum detector range. As a result, the average power can be determined with high accuracy irrespective of the modulation type. Measurement results are hardly affected by interfering signals or harmonics. The R&S®NRPxxS(N) power sensors therefore behave similar to thermal power sensors but offer significantly higher speed. They provide up to 93 dB dynamic range with an excellent lower measurement limit of -70 dBm.

Sensor type	Frequency range	Level range	Connector type
R&S®NRP8S(N)	10 MHz to 8 GHz	-70 dBm to +23 dBm	N (m)
R&S®NRP18S(N)	10 MHz to 18 GHz	-70 dBm to +23 dBm	N (m)
R&S®NRP33S(N)	10 MHz to 33 GHz	-70 dBm to +23 dBm	3.5 mm (m)
R&S®NRP40S(N)	50 MHz to 40 GHz	-70 dBm to +20 dBm	2.92 mm (m)
R&S®NRP50S(N)	50 MHz to 50 GHz	-70 dBm to +20 dBm	2.4 mm (m)
R&S®NRP67S(N)	50 MHz to 67 GHz	-70 dBm to +20 dBm	1.85 mm (m)
R&S®NRP90S(N)	50 MHz to 90 GHz	-70 dBm to +20 dBm	1.35 mm (m)/1.00 mm (m)
R&S®NRP18S-10	10 MHz to 18 GHz	-60 dBm to +33 dBm	N (m)
R&S®NRP18S-20	10 MHz to 18 GHz	-50 dBm to +42 dBm	N (m)
R&S®NRP18S-25	10 MHz to 18 GHz	-45 dBm to +45 dBm	N (m)



R&S®NRP90SN and R&S®NRP90S  
three-path diode power sensors

Unlike conventional multipath technology, adjacent diode paths in the R&S®NRPxxS(N) power sensors overlap by 6 dB. All paths are continuously and simultaneously measured. The final measurement result is achieved by appropriately weighting the measurement results of all paths. This innovative approach ensures a smooth transition between measurement paths. Problems due to hard switching between the measurement paths, such as hysteresis effects, additional measurement delays and differential nonlinearity, are eliminated. The patented sensor architecture also improves the signal-to-noise ratio and increases measurement speed in the transition region.

### Unprecedented measurement speed and accuracy even at low levels

The measurement speed is not only a function of the sampling rate. It depends to a substantial degree on the level to be measured and the desired measurement accuracy. To increase measurement accuracy, especially at low levels, it is necessary to average multiple measured values. While averaging reduces the noise component and thus increases measurement accuracy, it also slows down the measurement. The R&S®NRPxxS(N) power sensors have therefore been designed with an extremely low measurement noise in mind.

As a basic rule, it can be said that a 50% reduction in the measurement noise will reduce the measurement time by a factor of four while maintaining the same accuracy.

With a typical measurement noise of 20 pW, the R&S®NRPxxS(N) power sensors can perform measurements down to a lower limit of -70 dBm with the highest speed and accuracy currently available on the market.

### More than 50 000 readings/s

With more than 50 000 readings/s in fast continuous average mode, the R&S®NRPxxS(N) power sensors are currently the fastest sensors on the market. In buffered mode, they can transmit up to 8192 measured values per block with a minimum aperture of 10 μs. This corresponds to a continuous acquisition time of 81.92 ms. Any sporadic interference will be reliably detected.

### Innovative three-path concept

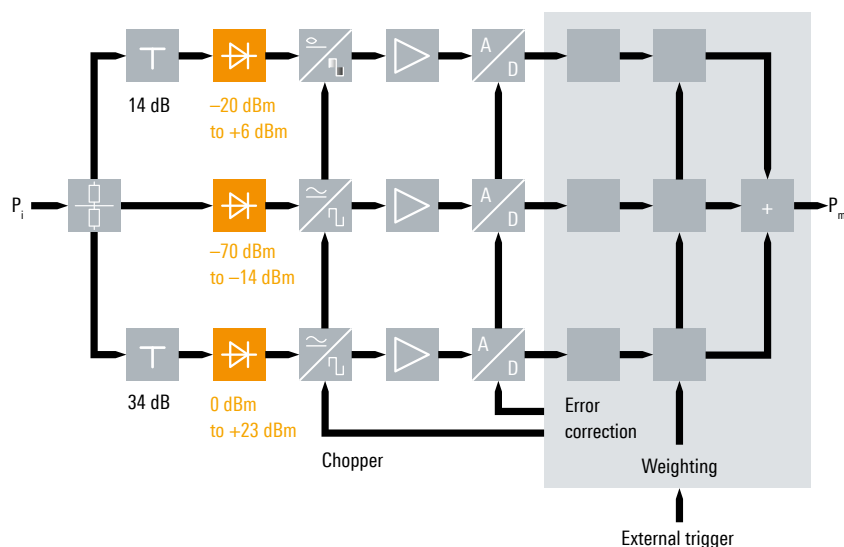

### 10 000 triggered measurements/s

In fast continuous average mode, the R&S®NRPxxS(N) power sensors can perform up to 10 000 triggered measurements/s with a minimum trigger repetition time of 100 µs without losing any measurement. This measurement speed is achieved by using the buffered mode. In buffered mode, all measured data is collected inside the sensor and transmitted in one block to the sensor's host. By exploiting the maximum buffer size, the R&S®NRPxxS(N) sensors are able to collect measured data for up to 8192 triggered measurements within 0.81 s.

### Sensors for high-power applications

The R&S®NRP18S-10, R&S®NRP18S-20 and R&S®NRP18S-25 high-power three-path diode power sensors consist of an R&S®NRP18S and a 10/20/25 dB upstream attenuator. They are able to perform power measurements up to 2 W, 15 W and 30 W.

When used with the attenuator, mismatch errors between the sensor and attenuator are automatically corrected. The S-parameters for the attenuator are determined and stored in the sensor during production. They are then automatically taken into account when performing measurements.

### Triggered measurements

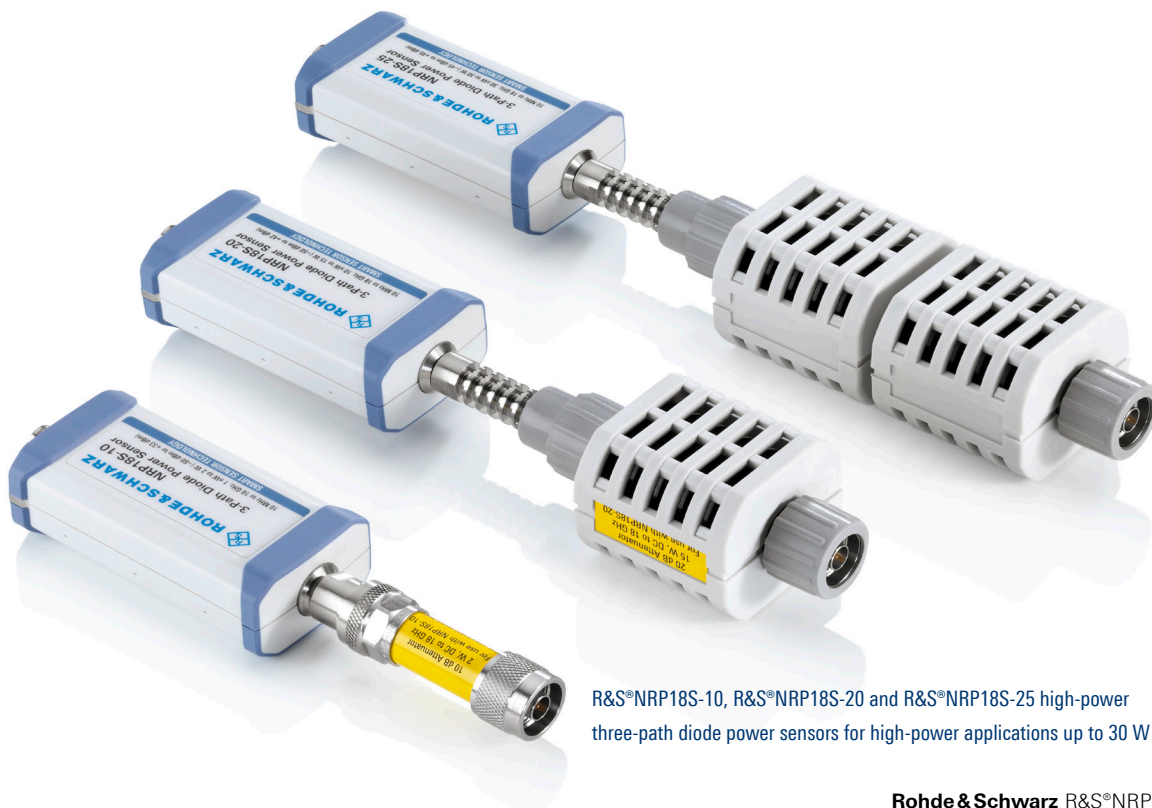
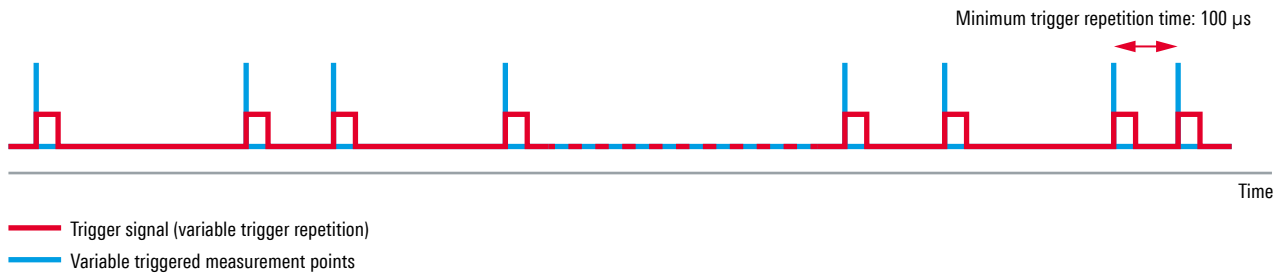

R&S®NRP18S-10, R&S®NRP18S-20 and R&S®NRP18S-25 high-power three-path diode power sensors for high-power applications up to 30 W

# TVAC-COMPLIANT THREE-PATH DIODE POWER SENSOR

## Specially designed for use in thermal vacuum (TVAC) chambers

In the satellite sector, components, subsystems and entire satellites must be qualified in a thermal vacuum (TVAC) before they can be used in space. This increasingly requires highly accurate, reliable power measurements directly on the DUT, i.e. in a TVAC chamber. Power sensors must therefore not only function in a high vacuum but also be able to withstand certain temperature fluctuations.

The R&S®NRP33SN-V and R&S®NRP67SN-V TVAC-compliant power sensors are specially designed for these requirements. All components are baked in a vacuum chamber during the production process, so outgassing is reduced to a minimum. Venting holes in the housing ensure pressure equalization between the inside of the sensor and the environment.

The R&S®NRP33SN-V and R&S®NRP67SN-V TVAC-compliant power sensors cover the satellite communications frequency range up to 67 GHz and allow fast, highly accurate power measurements over a dynamic range of up to 93 dB, independent of signal bandwidth and modulation type. Thanks to their LAN capability, the power sensors can be easily controlled and monitored from outside the chamber.

A set of dedicated, TVAC-compliant cables is available as well. The cables are made of vacuum friendly material, they are baked and come in vacuumized packaging to ensure optimal performance in TVAC environments and prevent any gassing or contamination.

Sensor type	Frequency range	Level range	Connector type
R&S®NRP33SN-V	10 MHz to 33 GHz	-70 dBm to +23 dBm	3.5 mm (m)
R&S®NRP67SN-V	50 MHz to 67 GHz	-70 dBm to +20 dBm	1.85 mm (m)



R&S®NRP67SN-V  
TVAC-compliant power sensor



# THERMAL POWER SENSORS

## Outstanding performance for reference applications

Thermal power sensors are especially used for complex measurement tasks where highest accuracy counts. They tolerate any type of modulation. To improve measurement accuracy, the hardware of the R&S®NRPxxT(N)/TWG(N) thermal power sensors is designed to reduce measurement noise to a minimum and make the sensor immune to thermal environmental effects. To achieve stable measurement results, the temperature in the thermal test cell must correspond to the applied power. When the power is increased, the sophisticated measurement cell of the R&S®NRPxxT(N)/TWG(N) thermal power sensors quickly attains a stable temperature. When the power level is decreased, the excess heat is dissipated extremely quickly. Consequently, thermal power sensors from Rohde & Schwarz are able to measure three times faster than comparable solutions on the market with triggered measurements and > 500 measurements/s in buffered mode – with top accuracy.

The R&S®NRPxxT(N) thermal power sensors feature an unparalleled linearity of 0.007 dB (0.16%) up to 67 GHz

and 0.010 dB (0.23%) between 67 GHz and 110 GHz. The R&S®NRPxxTWG(N) thermal waveguide power sensors feature a linearity of 0.010 dB (0.23%) between 50 GHz and 110 GHz – the ideal choice for performing relative measurements.

The available models cover a wide range of frequency bands. This includes a WR6.5 connector to cover D band ranging from 110 GHz to 170 GHz as well as a WR8 connector model to cover the 90 GHz to 140 GHz F band.

These sensor characteristics are particularly beneficial in reference applications and calibration labs.

## Excellent impedance matching

To a large extent, measurement uncertainty results from multiple reflections at the source and power sensor caused by mismatch. To minimize these reflections, all thermal power sensors in the R&S®NRP family are excellently matched up to high frequencies, reducing measurement uncertainty.

Sensor type	Frequency range	Level range	Connector type
R&S®NRP18T(N)	DC to 18 GHz	-35 dBm to +20 dBm	N (m)
R&S®NRP33T(N)	DC to 33 GHz	-35 dBm to +20 dBm	3.5 mm (m)
R&S®NRP40T(N)	DC to 40 GHz	-35 dBm to +20 dBm	2.92 mm (m)
R&S®NRP50T(N)	DC to 50 GHz	-35 dBm to +20 dBm	2.4 mm (m)
R&S®NRP67T(N)	DC to 67 GHz	-35 dBm to +20 dBm	1.85 mm (m)
R&S®NRP90T(N)	DC to 90 GHz	-35 dBm to +20 dBm	1.35 mm (m)
R&S®NRP110T	DC to 110 GHz	-35 dBm to +20 dBm	1 mm (m)
R&S®NRP75TWG(N)	50 GHz to 75 GHz	-35 dBm to +20 dBm	WR15
R&S®NRP90TWG(N)	60 GHz to 90 GHz	-35 dBm to +20 dBm	WR12
R&S®NRP110TWG(N)	75 GHz to 110 GHz	-35 dBm to +20 dBm	WR10
R&S®NRP140TWG(N)	90 GHz to 140 GHz	-35 dBm to +20 dBm	WR8
R&S®NRP170TWG(N)	110 GHz to 170 GHz	-35 dBm to +20 dBm	WR6.5



R&S®NRP170TWGN and R&S®NRP170TWG thermal waveguide power sensors

### R&S®NRPxxTWG(N) with waveguide interface

New, high-frequency technologies such as satellite communications, research and military radar targeting and tracking, and some non-military applications such as automotive radar create a challenging situation for the required test setup.

The R&S®NRPxxTWG(N) thermal waveguide power sensors provide a convenient and accurate solution with integrated waveguide interfaces.

Waveguide adapters and a waveguide bracket are available for the R&S®NRP110T sensor.



R&S®NRP110T thermal power sensor with waveguide adapter and bracket

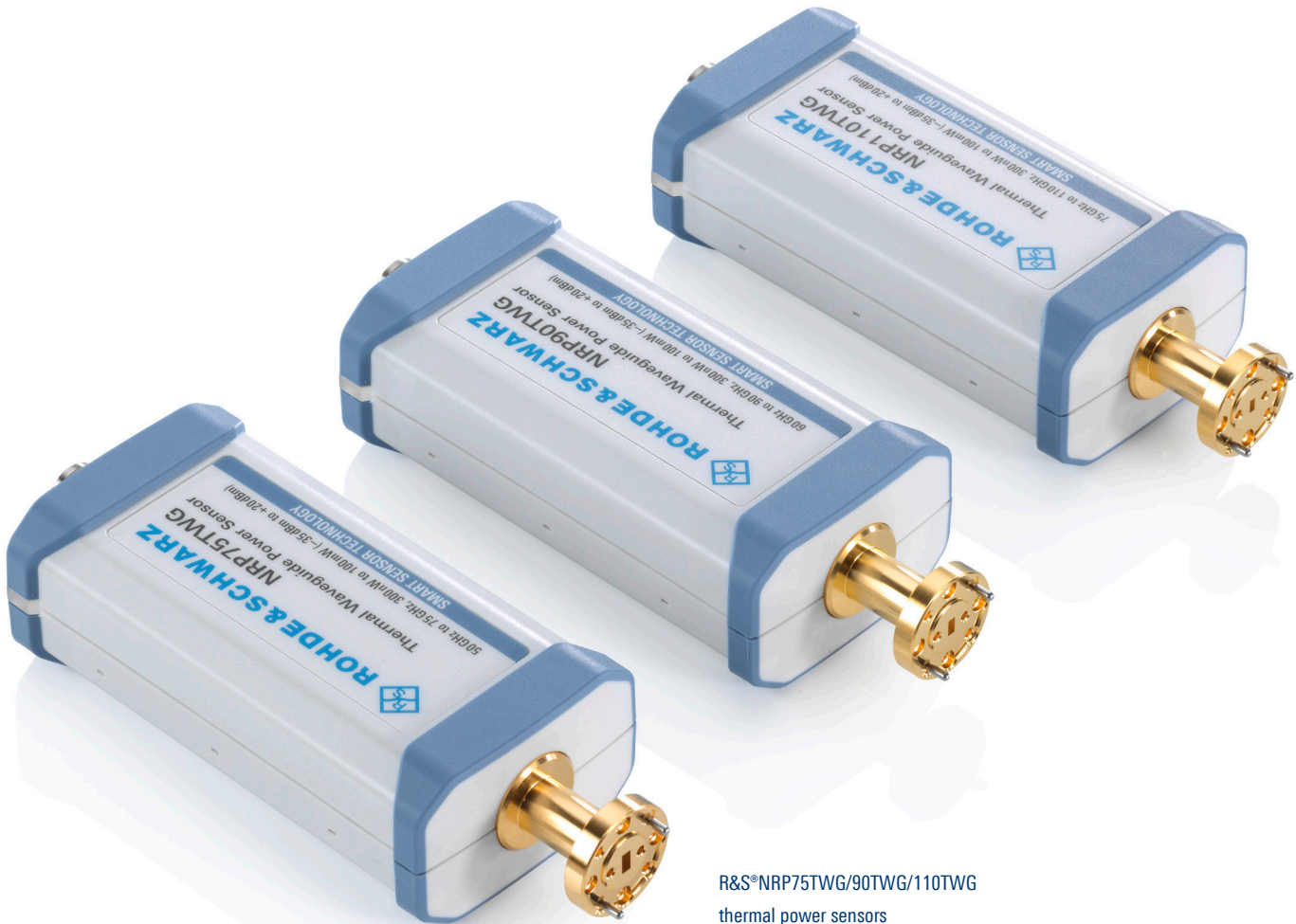

R&S®NRP75TWG/90TWG/110TWG thermal power sensors

### Sophisticated coaxial connector concept

Thanks to the innovative connector design, the sensors can be easily screw-connected to the signal source to be measured. A ball bearing in the coupling nut ensures that only the coupling nut has to be turned to tighten the sensor. The sensor body stays fixed in the required position. Contrary to conventional connecting screws, the outer conductors of the sensor and DUT are not turned relative to each other and so their mating surfaces do not rub together. This reduces wear and enhances reproducibility of measurements. The connector concept contributes to high measurement accuracy.

### Internal calibration test

Rohde & Schwarz has implemented a special verification function in the R&S®NRPxxT(N)/TWG(N) sensors. This function covers all essential components of the signal path. Using a test routine, the sensor's response to a highly stable applied DC power is measured and compared to the value stored during the previous calibration. The result provides information about the functionality and accuracy of the power sensor.

### Interior view of the connector

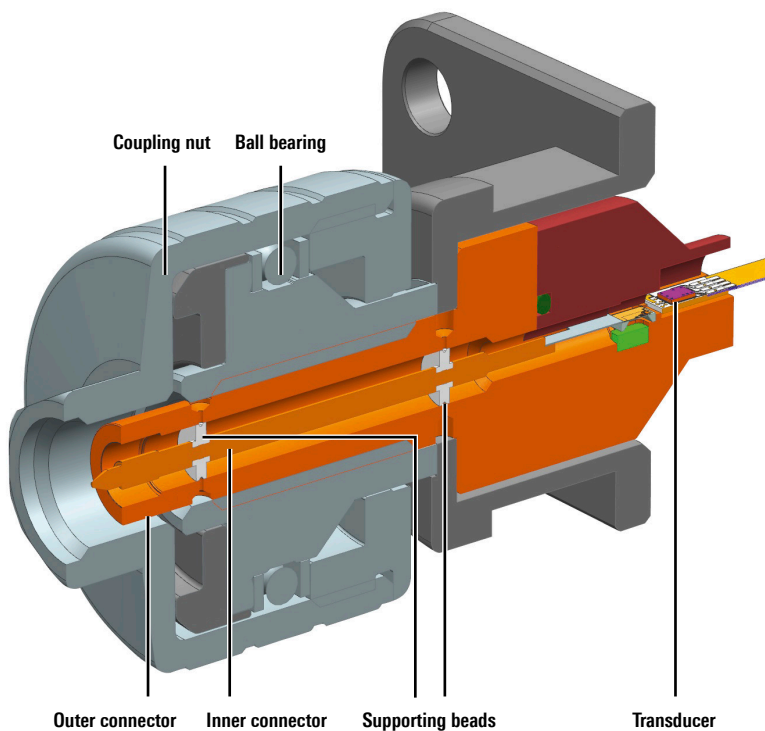

# EMC AVERAGE POWER SENSORS

## Specially designed for EMC applications

In EMC applications, usually only the average power is of interest. This is where the R&S®NRPxxA(N) average power sensors are the perfect fit. They cover measurement ranges that are used in telecommunications as well as the important lower frequency bands down to 8 kHz. Users benefit from the excellent properties of the three-path diode power sensors, including a dynamic range of up to 93 dB, very low modulation influence on measurements and outstanding impedance matching.

Sensor type	Frequency range	Level range	Connector type
R&S®NRP6A(N)	8 kHz to 6 GHz	-70 dBm to +23 dBm	N (m)
R&S®NRP18A(N)	8 kHz to 18 GHz	-70 dBm to +23 dBm	N (m)



R&S®NRP18AN and R&S®NRP18A  
EMC average power sensor



# PULSE POWER SENSORS

## Ideal for radar applications

The R&S®NRPxxP pulse power sensors are ideal for radar applications. In development or during installation and maintenance, pulse characteristics as well as output power have to be measured. Similar measurements are required in the production of radar systems and radar components. Thanks to a maximum video bandwidth of 30 MHz and a rise/fall time < 13 ns, the sensors can measure pulses with a pulse width as small as 50 ns.

## Up to 50 GHz

The R&S®NRPxxP pulse power sensors are ideal for power measurements on microwave link modules. Especially the R&S®NRP50P can be used for the development, production, installation and maintenance of the latest generation of microwave link modules. The user benefits from the sensor's high measurement speed and large dynamic range.

## Outstanding dynamic range and accuracy

The dynamic range of the R&S®NRPxxP pulse power sensors yields a lower limit of -47 dBm for envelope power measurements and -60 dBm for average power measurements. This sensitivity is unique and so far unprecedented on the market. Users benefit from enhanced reproducibility and high measurement speed.

These sensors are therefore ideal for analyzing envelope power as well as for measuring average power.

## High resolution mode

Some applications require the display of strongly magnified signal sections such as the rising edge of a pulse. To improve the graphical display in the trace mode, which has a resolution of 12.5 ns, a high density of samples is required. Equivalent time sampling with repetitive signals can achieve a time resolution of up to 100 ps.

Sensor type	Frequency range	Measurement range	Connector type
R&S®NRP18P	50 MHz to 18 GHz	-60 dBm to +20 dBm	N (m)
R&S®NRP40P	50 MHz to 40 GHz	-60 dBm to +20 dBm	2.92 mm (m)
R&S®NRP50P	50 MHz to 50 GHz	-60 dBm to +20 dBm	2.4 mm (m)



R&S®NRP50P/40P/18P pulse power sensors



## Automatic pulse analysis

Automatic pulse analysis supports users in measuring important pulse parameters. It eliminates the need for complex measurements using markers; pulse shape changes are immediately taken into account in the measurement results.

The following parameters are determined by automatic pulse analysis:

- ▶ Time parameters: rise/fall time, start/stop time, pulse width, duty cycle, pulse period, pulse off time
- ▶ Level parameters: pulse top, pulse base, peak, average, minimum, overshoot (positive and negative droop)

## Time parameters

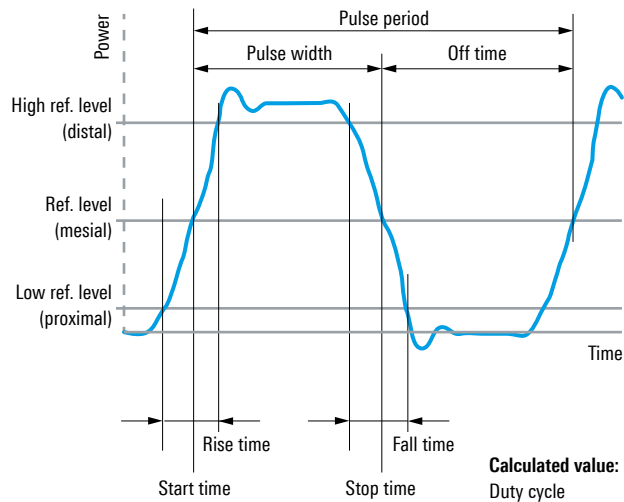

## Level parameters

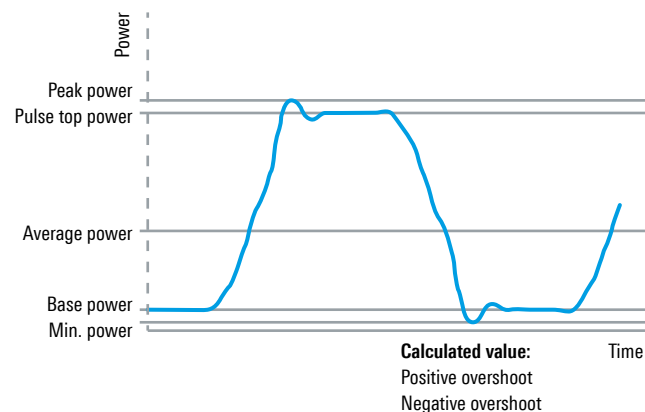

## Statistical analysis

The R&S®NRPxxP pulse power sensors permit statistical analysis of the amplitude distribution of noise-like signals to determine key parameters such as peak envelope power, average power and peak-to-average power ratio. The measurement data supports the design of components for modern OFDM or CDMA based wireless systems such as EUTRA/LTE and 3GPP FDD. Using one million samples, the R&S®NRPxxP pulse power sensors can measure the CCDF, CDF or PDF in less than 25 ms at full video bandwidth.

It is also possible to perform statistical analysis on an individually configured time gate so that only specific signal sections are observed.

## Trigger sender mode (with base unit or R&S®NRP-Z5)

Combined with the R&S®NRX base unit or the R&S®NRP-Z5 sensor hub, an R&S®NRPxxP pulse power sensor can be used as a trigger source. In the trigger sender mode, a trigger signal is derived from the measured signal inside the power sensor and forwarded to the base unit or sensor hub for further use. All other connected sensors can be externally triggered using this trigger signal. An additional external trigger source is not required. This feature can be used to determine the input and output level of power amplifiers when the level at the input is too low for an internally triggered measurement, yet the level at the output is sufficient. In this case, an R&S®NRPxxP used for measuring the output signal acts as the trigger sender to trigger the input signal measurement.

# DIODE POWER SENSORS

## Cost-effective solution for production applications

The R&S®NRP8E/18E diode power sensors combine all key characteristics relevant for their use in production. These USB sensors are cost-effective, fast and precise. The sensors support the same measurement functions as the R&S®NRPxxS three-path diode power sensors and offer the best price/performance ratio in their class.

## Mid-class sensor with tried and tested technology

The diode power sensors use the tried and tested Rohde&Schwarz multipath technology. With overlapping diode paths measured in parallel and a wide dynamic range of 80 dB, the power sensors feature high measurement accuracy and speed.

Sensor type	Frequency range	Measurement range	Connector type
R&S®NRP8E	10 MHz to 8 GHz	-60 dBm to +20 dBm	N (m)
R&S®NRP18E	10 MHz to 18 GHz	-60 dBm to +20 dBm	N (m)



R&S®NRP8E/NRP18E diode power sensors

# POWER SENSOR MODULES

## Solution for accurate level calibration

The R&S®NRP-Z27/-Z37 power sensor modules turn the R&S®FSMR and R&S®FSMR3000 measuring receivers into precision power meters with a wide dynamic range from -115 dBm to +30 dBm.

The R&S®NRP-Z27/-Z37 power sensor modules were developed especially for level calibration using the R&S®FSMR and R&S®FSMR3000 measuring receivers. These sensors act as highly accurate references for determining the absolute power level. Together with the excellent linearity of the R&S®FSMR and R&S®FSMR3000, this enables

precise power calibration over the entire level range of the measuring receiver. Using an integrated power splitter, the power is fed to the integrated R&S®NRP-Z27/-Z37 thermal power sensor module and simultaneously to the measuring receiver via a phase-stable cable.

Like all other power sensors in the R&S®NRP family, the power sensor modules are fully self-contained power meters that are remotely controlled from the R&S®FSMR, R&S®FSMR3000, R&S®NRX or any Windows PC via USB.

R&S®FSMR measuring receiver with R&S®NRP-Z27 power sensor module



## R&S®FSMR measuring receiver with R&S®NRP-Z27/-Z37 power sensor module

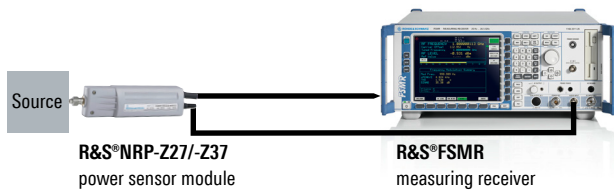

Sensor type	Frequency range	Measurement range	Connector type
R&S®NRP-Z27	DC to 18 GHz	-24 dBm to +26 dBm	N (m)
R&S®NRP-Z37	DC to 26.5 GHz	-24 dBm to +26 dBm	3.5 mm (m)



R&S®NRP-Z27/-Z37 power sensor modules

# LEVEL CONTROL SENSORS

## Feeding accurate power level to a device under test (DUT)

The R&S®NRP-Z28/-Z98 level control sensors were developed especially to feed power to the DUT and monitor the power at the same time. The sensor's integrated power splitter splits the signal into two equal power parts. One part is measured by the integrated power sensor and displayed on a Rohde&Schwarz signal generator, on the

R&S®NRX base unit or on a laptop/PC. The other part, which is identical to the measured part, is output at the sensor's RF output and can be directly fed to the DUT. The sensor is a permanent part of the test setup. To perform a power measurement, it is not necessary to disconnect the DUT from the RF source. Uncertainties caused by a mismatched load or the cable loss between the signal generator and the DUT are prevented by using the R&S®NRP-Z28/-Z98 level control sensors together with the automatic level correction feature of Rohde&Schwarz signal generators. Distances of up to 1.2 m are bridged by an integrated low-loss microwave cable.

Sensor type	Frequency range	Measurement range	Connector type
R&S®NRP-Z28	10 MHz to 18 GHz	-67 dBm to +20 dBm	N (m)
R&S®NRP-Z98	9 kHz to 6 GHz	-67 dBm to +20 dBm	N (m)



R&S®NRP-Z28/-Z98  
level control sensors

# R&S®NRPV: CONVENIENT POWER MEASUREMENTS VIA PC APPLICATION

## Sophisticated PC application

In combination with the R&S®NRPV virtual power meter software, the USB capability of the R&S®NRP power sensors can be ideally utilized. The software covers all sensor functions and supports up to four sensors connected to a laptop/PC via the R&S®NRP-Z4 USB adapter cable or the R&S®NRP-Z5 sensor hub. The sensors are automatically detected when plugged in and added to all open measurement windows (hot plugging).

This cost-effective measurement solution supports all available measurement modes. Mathematical calculations during measurements to determine the SWR, difference or ratio are possible in the continuous average, gated average and burst average numerical modes and in the graphical trace mode.

## Multifunctional trace mode window

The trace mode is supported by all three-path diode power sensors, two-path diode power sensors and pulse power sensors. Up to four trace measurements and four mathematical traces can be simultaneously displayed in one window.

## Timeslot/time gate

Timeslot and time gate measurements are performed directly in the trace window. The R&S®NRPV virtual power meter software supports up to 16 timeslots and four independent time gates. They can be transparently displayed in the trace window. Timeslot and gate length as well as their starting position are adjusted using the mouse; measured values are displayed as a table in the measurement window.

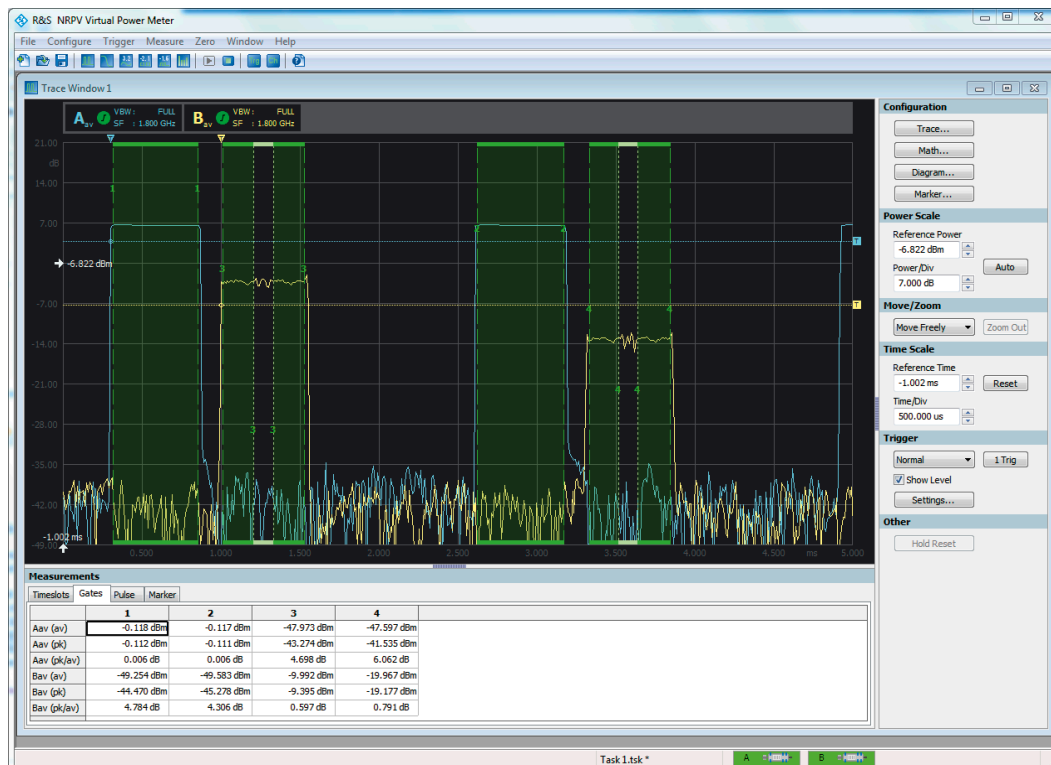

Gated measurement of two GSM/EDGE traces with the R&S®NRPxxP



## Automatic pulse analysis

The R&S®NRPxxP pulse power sensors can quickly and automatically analyze pulsed signals in trace mode to continuously determine the most important time and power parameters.

## Extremely flexible marker functions

The marker function in the trace mode supports an unlimited number of markers that can be linked together as required. In addition to single markers (to measure the level at a fixed time) and double markers (to determine the level difference after a fixed time period), other functions such as automatic peak search are available.

Each marker can be used as a reference marker and functions as a reference point to determine time and level differences. Linked markers can be combined and extended as required. Since each marker is associated with a trace, markers from different traces can also be linked. The spacing between two pulses in different traces can be accurately and continuously measured, even if the pulse spacing changes.

Complex marker settings can be stored and retrieved at any time.

## Intelligent licensing concept: dongle-free on multiple PCs

The R&S®NRPV virtual power meter software can be installed on an unlimited number of laptops/PCs. All R&S®NRPxxS(N)/P/T(N)/A(N) sensors come from the factory enabled for use with the R&S®NRPV software. Each R&S®NRP-Zxx sensor has to be activated individually using the sensor-specific R&S®NRPZ-K1 keycode option. Once activated, the sensor can be operated on any laptop/PC. This licensing concept eliminates the need for USB dongles and does not tie a license to a specific laptop/PC.

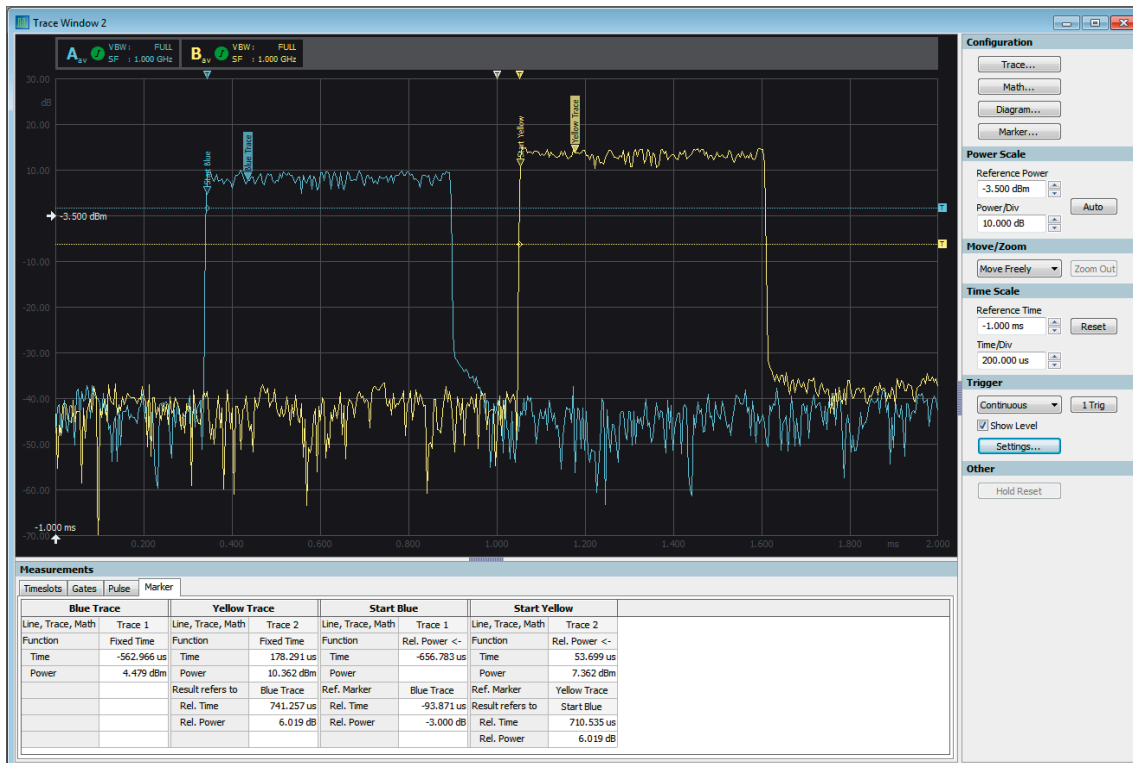

Pulse delay measurement on different traces

# APPLICATIONS

## Accurate measurement of TDMA based signals

The analysis of TDMA based signals encountered in GSM/EDGE and DECT is a common application for power measurements. The R&S®NRPxxS/xxP/-Z2xx sensors are very powerful tools for such work. The trace mode makes graphical analysis of any signal very straightforward. The ability to easily modify the time axis and the auto scaling function provide useful support during in-depth analysis of relevant signal components. The timeslot measurement in the trace mode allows simultaneous analysis of multiple equidistant timeslots.

Additionally, the R&S®NRPxxS/xxP/-Z2xx sensors support up to four independent measurement gates. Start time and length can be individually configured for each gate.

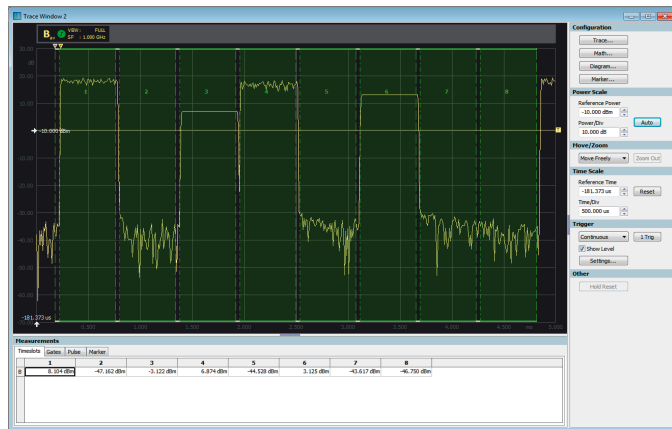

Measurement of eight timeslots in one shot with the R&S®NRPV

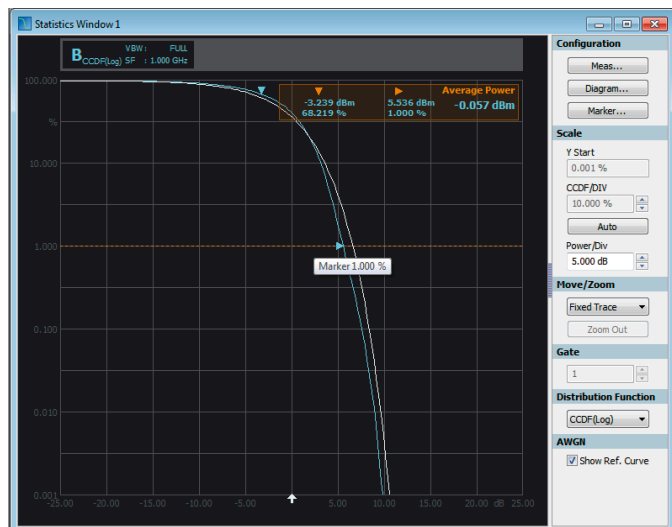

Statistical analysis of an LTE signal using the R&S®NRPV

The power sensor also provides a fence function for the timeslot and time gate modes. The fence can be configured separately for each gate or globally for all timeslots. This allows the user to keep track of the power at all times during the time segments of interest. Exclude times can be set to mask interfering signal components at the edges of a timeslot.

## Power measurements in radiocommunications standards

Radiocommunications standards such as 3GPP LTE, 3GPP FDD and CDMA2000® exhibit very different power profiles depending on their channel utilization. Assessing these power profiles is a routine job with the power sensors in the R&S®NRP family. This is true no matter whether you need to accurately measure the average power, peak power, peak-to-average ratio in the time domain or you need fast statistical analysis to precisely determine the amplitude distribution.

Average power measurements are possible with all R&S®NRP power sensors. The R&S®NRPxxT thermal power sensors are used when highest accuracy is required. The R&S®NRPxxS/xxA/-Z2xx multipath sensors perform average power measurements very quickly over a dynamic range of up to 93 dB. This is true even for signals with a high peak-to-average ratio. Thanks to the patented multipath technology, measurements are always fast and accurate even at the limits of the measurement paths. The innovative sensor architecture eliminates measurement range switching as well as the associated discontinuity in the measured values and extended measurement times.

For power analysis, the R&S®NRPxxP pulse power sensors are available. With a maximum video bandwidth of 30 MHz, these sensors are ideal for analyzing noise-like signals in statistic mode. Exact determination of the amplitude statistics permits accurate peak, average and crest factor measurements.

## Radar applications

The R&S®NRPxxP pulse power sensors with a maximum frequency of 50 GHz are ideal for time domain analysis of pulses. Automatic pulse analysis enables users to continuously monitor key pulse parameters such as rise/fall time, pulse width or pulse top without interaction. With a rise time of 13 ns, even steep edges can be measured. This performance is sufficient to measure most radar signals.

Even nonrepetitive pulse sequences where each pulse exhibits a different power level can be precisely measured.

Using the sensor's buffered mode, the measurements are performed so fast that it is possible to reliably measure the power of all pulses even in the presence of high pulse repetition rates and short pulses. This ensures reliable detection of even rarely occurring signal phenomena.

### Component tests with high throughput

In component testing, the focus is on precisely determining the input/output power, the gain, and the input impedance matching of the DUT. The R&S®NRP family provides an outstanding solution for such applications. Only one R&S®NRX base unit with up to four measurement channels is required for the simultaneous evaluation of the results delivered by the sensors. This makes it possible to correctly measure the input and output power of a power amplifier as well as to accurately determine the gain and input impedance matching since the R&S®NRX base unit automatically calculates the power ratios.



R&S®NRPxxP pulse power sensors are suitable for accurate measurement of pulsed radar systems.

### Typical test setup for multicarrier power amplifier (MCPA) tests; calculation functions of the R&S®NRX allow impedance matching and gain to be determined

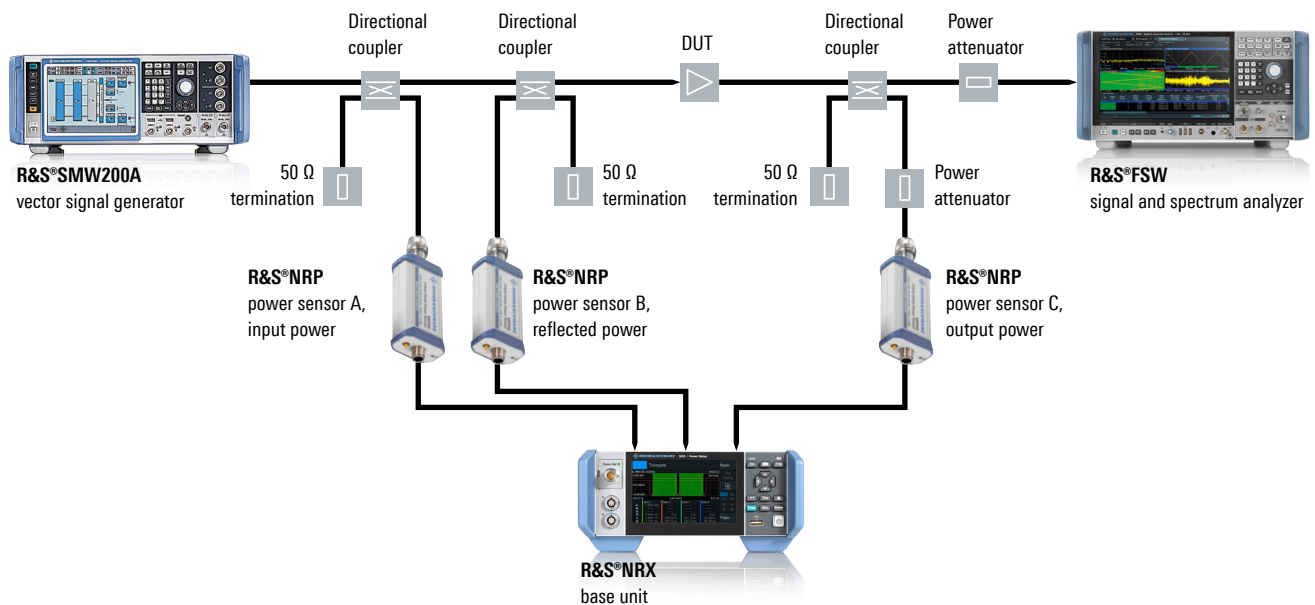

# SPECIFICATIONS IN BRIEF

Specifications in brief			
Sensor type, connector	Frequency range	Power measurement range, maximum input power	Impedance matching (SWR)
<b>Three-path diode power sensors</b>			
R&S®NRP8S(N) N (m)	10 MHz to 8 GHz	100 pW to 200 mW (-70 dBm to +23 dBm)	10 MHz to 2.4 GHz: < 1.13 > 2.4 GHz to 8.0 GHz: < 1.20
R&S®NRP18S(N) N (m)	10 MHz to 18 GHz	100 pW to 200 mW (-70 dBm to +23 dBm)	10 MHz to 2.4 GHz: < 1.13 > 2.4 GHz to 8.0 GHz: < 1.20 > 8.0 GHz to 18.0 GHz: < 1.25
R&S®NRP33S(N) 3.5 mm (m)	10 MHz to 33 GHz	100 pW to 200 mW (-70 dBm to +23 dBm)	10 MHz to 2.4 GHz: < 1.13 > 2.4 GHz to 8.0 GHz: < 1.20 > 8.0 GHz to 18.0 GHz: < 1.25 > 18.0 GHz to 26.5 GHz: < 1.30 > 26.5 GHz to 33.0 GHz: < 1.35
R&S®NRP40S(N) 2.92 mm (m)	50 MHz to 40 GHz	100 pW to 100 mW (-70 dBm to +20 dBm)	50 MHz to 2.4 GHz: < 1.13 > 2.4 GHz to 8.0 GHz: < 1.20 > 8.0 GHz to 18.0 GHz: < 1.25 > 18.0 GHz to 26.5 GHz: < 1.30 > 26.5 GHz to 33.0 GHz: < 1.35 > 33 GHz to 40.0 GHz: < 1.37
R&S®NRP50S(N) 2.4 mm (m)	50 MHz to 50 GHz	100 pW to 100 mW (-70 dBm to +20 dBm)	50 MHz to 2.4 GHz: < 1.13 > 2.4 GHz to 8.0 GHz: < 1.20 > 8.0 GHz to 18.0 GHz: < 1.25 > 18.0 GHz to 26.5 GHz: < 1.30 > 26.5 GHz to 33.0 GHz: < 1.35 > 33 GHz to 40.0 GHz: < 1.37 > 40 GHz to 50.0 GHz: < 1.40
R&S®NRP67S(N) 1.85 mm (m)	50 MHz to 67 GHz	100 pW to 100 mW (-70 dBm to +20 dBm)	50 MHz to 200 MHz: < 1.30 > 200 MHz to 2.4 GHz: < 1.13 > 2.4 GHz to 8.0 GHz: < 1.20 > 8.0 GHz to 18.0 GHz: < 1.25 > 18.0 GHz to 26.5 GHz: < 1.30 > 26.5 GHz to 33.0 GHz: < 1.35 > 33.0 GHz to 40.0 GHz: < 1.37 > 40.0 GHz to 50.0 GHz: < 1.40 > 50.0 GHz to 67.0 GHz: < 1.68
R&S®NRP90S(N) 1.35 mm (m)/1.00 mm (m)	50 MHz to 90 GHz	100 pW to 100 mW (-70 dBm to +20 dBm)	50 MHz to 200 MHz: < 1.30 > 200 MHz to 2.4 GHz: < 1.13 > 2.4 GHz to 8.0 GHz: < 1.20 > 8.0 GHz to 18.0 GHz: < 1.25 > 18.0 GHz to 26.5 GHz: < 1.30 > 26.5 GHz to 40.0 GHz: < 1.38 > 40.0 GHz to 50.0 GHz: < 1.46 > 50.0 GHz to 67.0 GHz: < 1.68 > 67.0 GHz to 90.0 GHz: < 1.98
<b>High-power three-path diode power sensor</b>			
R&S®NRP18S-10 N (m)	10 MHz to 18 GHz	1 nW to 2 W (-60 dBm to +33 dBm)	10 MHz to 2.4 GHz: < 1.14 > 2.4 GHz to 8.0 GHz: < 1.20 > 8.0 GHz to 12.4 GHz: < 1.25 > 12.4 GHz to 18.0 GHz: < 1.30
R&S®NRP18S-20 N (m)	10 MHz to 18 GHz	10 nW to 15 W (-50 dBm to +42 dBm)	10 MHz to 2.4 GHz: < 1.14 > 2.4 GHz to 8.0 GHz: < 1.25 > 8.0 GHz to 12.4 GHz: < 1.30 > 12.4 GHz to 18.0 GHz: < 1.41
R&S®NRP18S-25 N (m)	10 MHz to 18 GHz	30 nW to 30 W (-45 dBm to +45 dBm)	10 MHz to 2.4 GHz: < 1.14 > 2.4 GHz to 8.0 GHz: < 1.25 > 8.0 GHz to 12.4 GHz: < 1.30 > 12.4 GHz to 18.0 GHz: < 1.41

Rise time, video bandwidth	Uncertainty for power measurements at +20 °C to +25 °C		Sensor type, connector
	absolute (in dB)	relative (in dB)	
< 5 $\mu$ s > 100 kHz	0.053 to 0.065	0.022 to 0.050	<b>Three-path diode power sensors</b> R&S®NRP8S(N) N (m)
	0.053 to 0.094	0.022 to 0.069	R&S®NRP18S(N) N (m)
	0.053 to 0.134	0.022 to 0.136	R&S®NRP33S(N) 3.5 mm (m)
	0.073 to 0.138	0.028 to 0.142	R&S®NRP40S(N) 2.92 mm (m)
	0.073 to 0.183	0.028 to 0.184	R&S®NRP50S(N) 2.4 mm (m)
	0.073 to 0.255	0.028 to 0.266	R&S®NRP67S(N) 1.85 mm (m)
	0.073 to 0.300	0.028 to 0.320	R&S®NRP90S(N) 1.35 mm (m)/1.00 mm (m)
< 5 $\mu$ s > 100 kHz	0.083 to 0.198	0.022 to 0.087	<b>High-power three-path diode power sensor</b> R&S®NRP18S-10 N (m)
	0.083 to 0.198	0.022 to 0.087	R&S®NRP18S-20 N (m)
	0.083 to 0.219	0.022 to 0.087	R&S®NRP18S-25 N (m)



## Specifications in brief

Sensor type, connector	Frequency range	Power measurement range, maximum input power	Impedance matching (SWR)
<b>TVAC-compliant three-path diode power sensors</b>			
R&S®NRP33SN-V 3.5 mm (m)	10 MHz to 33 GHz	100 pW to 200 mW (-70 dBm to +23 dBm)	10 MHz to 2.4 GHz: < 1.13 > 2.4 GHz to 8.0 GHz: < 1.20 > 8.0 GHz to 18.0 GHz: < 1.25 > 18.0 GHz to 26.5 GHz: < 1.30 > 26.5 GHz to 33.0 GHz: < 1.35
R&S®NRP67SN-V 1.85 mm (m)	50 MHz to 67 GHz	100 pW to 100 mW (-70 dBm to +20 dBm)	50 MHz to 200 MHz: < 1.30 > 200 MHz to 2.4 GHz: < 1.13 > 2.4 GHz to 8.0 GHz: < 1.20 > 8.0 GHz to 18.0 GHz: < 1.25 > 18.0 GHz to 26.5 GHz: < 1.30 > 26.5 GHz to 33.0 GHz: < 1.35 > 33.0 GHz to 40.0 GHz: < 1.37 > 40.0 GHz to 50.0 GHz: < 1.40 > 50.0 GHz to 67.0 GHz: < 1.68
<b>Thermal power sensors</b>			
R&S®NRP18T(N) N (m)	DC to 18 GHz	300 nW to 100 mW (-35 dBm to +20 dBm)	DC to 100 MHz: < 1.03 > 100 MHz to 2.4 GHz: < 1.06 > 2.4 GHz to 12.4 GHz: < 1.13 > 12.4 GHz to 18.0 GHz: < 1.16
R&S®NRP33T(N) 3.5 mm (m)	DC to 33 GHz	300 nW to 100 mW (-35 dBm to +20 dBm)	DC to 100 MHz: < 1.03 > 100 MHz to 2.4 GHz: < 1.06 > 2.4 GHz to 12.4 GHz: < 1.13 > 12.4 GHz to 18.0 GHz: < 1.16 > 18.0 GHz to 26.5 GHz: < 1.22 > 26.5 GHz to 33.0 GHz: < 1.28
R&S®NRP40T(N) 2.92 mm (m)	DC to 40 GHz	300 nW to 100 mW (-35 dBm to +20 dBm)	DC to 100 MHz: < 1.03 > 100 MHz to 2.4 GHz: < 1.06 > 2.4 GHz to 12.4 GHz: < 1.13 > 12.4 GHz to 18.0 GHz: < 1.16 > 18.0 GHz to 26.5 GHz: < 1.22 > 26.5 GHz to 40.0 GHz: < 1.28
R&S®NRP50T(N) 2.4 mm (m)	DC to 50 GHz	300 nW to 100 mW (-35 dBm to +20 dBm)	DC to 100 MHz: < 1.03 > 100 MHz to 2.4 GHz: < 1.06 > 2.4 GHz to 12.4 GHz: < 1.13 > 12.4 GHz to 18.0 GHz: < 1.16 > 18.0 GHz to 26.5 GHz: < 1.22 > 26.5 GHz to 40.0 GHz: < 1.28 > 40.0 GHz to 50.0 GHz: < 1.30
R&S®NRP67T(N) 1.85 mm (m)	DC to 67 GHz	300 nW to 100 mW (-35 dBm to +20 dBm)	DC to 100 MHz: < 1.03 > 100 MHz to 2.4 GHz: < 1.06 > 2.4 GHz to 12.4 GHz: < 1.13 > 12.4 GHz to 18.0 GHz: < 1.16 > 18.0 GHz to 26.5 GHz: < 1.22 > 26.5 GHz to 40.0 GHz: < 1.28 > 40.0 GHz to 50.0 GHz: < 1.30 > 50.0 GHz to 67.0 GHz: < 1.35
R&S®NRP90T(N) 1.35 mm (m)	DC to 90 GHz	300 nW to 100 mW (-35 dBm to +20 dBm)	DC to 100 MHz: < 1.05 > 100 MHz to 2.4 GHz: < 1.08 > 2.4 GHz to 12.4 GHz: < 1.18 > 12.4 GHz to 18.0 GHz: < 1.23 > 18.0 GHz to 26.5 GHz: < 1.28 > 26.5 GHz to 40.0 GHz: < 1.38 > 40.0 GHz to 50.0 GHz: < 1.46 > 50.0 GHz to 67.0 GHz: < 1.56 > 67.0 GHz to 80.0 GHz: < 1.60 > 80.0 GHz to 90.0 GHz: < 1.66
R&S®NRP110T 1 mm (m)	DC to 110 GHz	300 nW to 100 mW (-35 dBm to +20 dBm)	DC to 100 MHz: < 1.05 > 100 MHz to 2.4 GHz: < 1.08 > 2.4 GHz to 12.4 GHz: < 1.18 > 12.4 GHz to 18.0 GHz: < 1.23 > 18.0 GHz to 26.5 GHz: < 1.28 > 26.5 GHz to 40.0 GHz: < 1.38 > 40.0 GHz to 50.0 GHz: < 1.46 > 50.0 GHz to 67.0 GHz: < 1.56 > 67.0 GHz to 80.0 GHz: < 1.60 > 80.0 GHz to 95.0 GHz: < 1.66 > 95.0 GHz to 110 GHz: < 1.70

Rise time, video bandwidth	Uncertainty for power measurements at +20 °C to +25 °C		Sensor type, connector
	absolute (in dB)	relative (in dB)	
< 5 $\mu$ s > 100 kHz	0.053 to 0.134	0.022 to 0.136	<b>TVAC-compliant three-path diode power sensor</b> R&S®NRP33SN-V 3.5 mm (m)
	0.073 to 0.255	0.028 to 0.266	R&S®NRP67SN-V 1.85 mm (m)
			<b>Thermal power sensors</b>
	0.040 to 0.082	0.010	R&S®NRP18T(N) N (m)
	0.040 to 0.101	0.010	R&S®NRP33T(N) 3.5 mm (m)
	0.040 to 0.108	0.010	R&S®NRP40T(N) 2.92 mm (m)
	0.040 to 0.143	0.010	R&S®NRP50T(N) 2.4 mm (m)
	0.040 to 0.209	0.010	R&S®NRP67T(N) 1.85 mm (m)
	0.040 to 0.269	0.014	R&S®NRP90T(N) 1.35 mm (m)
	0.040 to 0.290	0.014	R&S®NRP110T 1 mm (m)

## Specifications in brief

Sensor type, connector	Frequency range	Power measurement range, maximum input power	Impedance matching (SWR)
<b>Thermal waveguide power sensors</b>			
R&S®NRP75TWG(N) WR15	50 GHz to 75 GHz	300 nW to 100 mW (–35 dBm to +20 dBm)	
R&S®NRP90TWG(N) WR12	60 GHz to 90 GHz	300 nW to 100 mW (–35 dBm to +20 dBm)	
R&S®NRP110TWG(N) WR10	75 GHz to 110 GHz	300 nW to 100 mW (–35 dBm to +20 dBm)	
R&S®NRP140TWG(N) WR8	90 GHz to 140 GHz	300 nW to 100 mW (–35 dBm to +20 dBm)	
R&S®NRP170TWG(N) WR6.5	110 GHz to 170 GHz	300 nW to 100 mW (–35 dBm to +20 dBm)	
<b>Average power sensors</b>			
R&S®NRP6A(N) N (m)	8 kHz to 6 GHz	100 pW to 200 mW (–70 dBm to +23 dBm)	8 kHz to < 20 kHz: < 1.25 > 20 kHz to 2.4 GHz: < 1.13 > 2.4 GHz to 6 GHz: < 1.20
R&S®NRP18A(N) N (m)	8 kHz to 18 GHz	100 pW to 200 mW (–70 dBm to +23 dBm)	8 kHz to < 20 kHz: < 1.25 > 20 kHz to 2.4 GHz: < 1.13 > 2.4 GHz to 6 GHz: < 1.20 > 6 GHz to 18 GHz: < 1.25
<b>Pulse power sensors</b>			
R&S®NRP18P N (m)	50 MHz to 18 GHz	1 nW to 100 mW (–60 dBm to +20 dBm) max. 200 mW (AVG)/1 W (PK, 1 µs), max. 10 V (DC)	50 MHz to 2.4 GHz: < 1.16 > 2.4 GHz to 8.0 GHz: < 1.20 > 8.0 GHz to 18.0 GHz: < 1.25
R&S®NRP40P 2.92 mm (m)	50 MHz to 40 GHz	1 nW to 100 mW (–60 dBm to +20 dBm) max. 200 mW (AVG)/1 W (PK, 1 µs), max. 10 V (DC)	50 MHz to 2.4 GHz: < 1.16 > 2.4 GHz to 8.0 GHz: < 1.20 > 8.0 GHz to 18.0 GHz: < 1.25 > 18.0 GHz to 26.5 GHz: < 1.30 > 26.5 GHz to 40.0 GHz: < 1.35
R&S®NRP50P 2.4 mm (m)	50 MHz to 50 GHz	1 nW to 100 mW (–60 dBm to +20 dBm) max. 200 mW (AVG)/1 W (PK, 1 µs), max. 10 V (DC)	50 MHz to 2.4 GHz: < 1.16 > 2.4 GHz to 8.0 GHz: < 1.20 > 8.0 GHz to 18.0 GHz: < 1.25 > 18.0 GHz to 26.5 GHz: < 1.30 > 26.5 GHz to 40.0 GHz: < 1.35 > 40.0 GHz to 50.0 GHz: < 1.40
<b>Diode power sensors</b>			
R&S®NRP8E N (m)	10 MHz to 8 GHz	1.0 nW to 100 mW (–60 dBm to +20 dBm) max. 400 mW (AVG)/2 W (PK, 10 µs)	10 MHz to 2.4 GHz: < 1.13 > 2.4 GHz to 8.0 GHz: < 1.20
R&S®NRP18E N (m)	10 MHz to 18 GHz	1.0 nW to 100 mW (–60 dBm to +20 dBm) max. 400 mW (AVG)/2 W (PK, 10 µs)	10 MHz to 2.4 GHz: < 1.13 > 2.4 GHz to 8.0 GHz: < 1.20 > 8.0 GHz to 18.0 GHz: < 1.25
<b>Power sensor modules</b>			
R&S®NRP-Z27 N (m)	DC to 18 GHz	4 µW to 400 mW (–24 dBm to +26 dBm) max. 500 mW (AVG)/30 W (PK, 1 µs)	DC to 2.0 GHz: < 1.15 > 2.0 GHz to 4.2 GHz: < 1.18 > 4.2 GHz to 8.0 GHz: < 1.23 > 8.0 GHz to 12.4 GHz: < 1.25 > 12.4 GHz to 18.0 GHz: < 1.35
R&S®NRP-Z37 3.5 mm (m)	DC to 26.5 GHz	4 µW to 400 mW (–24 dBm to +26 dBm) max. 500 mW (AVG)/30 W (PK, 1 µs)	DC to 2.0 GHz: < 1.15 > 2.0 GHz to 4.2 GHz: < 1.18 > 4.2 GHz to 8.0 GHz: < 1.23 > 8.0 GHz to 12.4 GHz: < 1.25 > 12.4 GHz to 18.0 GHz: < 1.30 > 18.0 GHz to 26.5 GHz: < 1.45
<b>Level control sensors</b>			
R&S®NRP-Z28 N (m)	10 MHz to 18 GHz	200 pW to 100 mW (–67 dBm to +20 dBm) max. 700 mW (AVG)/4 W (PK, 10 µs)	10 MHz to 2.4 GHz: < 1.11 > 2.4 GHz to 4.0 GHz: < 1.15 > 4.0 GHz to 8.0 GHz: < 1.22 > 8.0 GHz to 18 GHz: < 1.30
R&S®NRP-Z98 N (m)	9 kHz to 6 GHz	200 pW to 100 mW (–67 dBm to +20 dBm) max. 700 mW (AVG)/4 W (PK, 10 µs)	9 kHz to 2.4 GHz: < 1.11 > 2.4 GHz to 4.0 GHz: < 1.15 > 4.0 GHz to 6.0 GHz: < 1.22

For more details, see specifications R&S®NRP power meter family (PD 3607.0852.22) and specifications R&S®NRPxxP pulse power sensors (PD 5216.2799.22)

Rise time, video bandwidth	Uncertainty for power measurements at +20 °C to +25 °C		Sensor type, connector
	absolute (in dB)	relative (in dB)	
	0.190	0.014	<b>Thermal waveguide power sensors</b>
	0.194	0.014	R&S®NRP75TWG(N) WR15
	0.198	0.014	R&S®NRP90TWG(N) WR12
–	0.238	0.020	R&S®NRP110TWG(N) WR10
	0.260	0.020	R&S®NRP140TWG(N) WR8
			R&S®NRP170TWG(N) WR6.5
			<b>Average power sensors</b>
	0.051 to 0.056	0.022 to 0.050	R&S®NRP6A(N) N (m)
–	0.051 to 0.094	0.022 to 0.069	R&S®NRP18A(N) N (m)
			<b>Pulse power sensors</b>
	0.053 to 0.065	0.053 to 0.065	R&S®NRP18P N (m)
< 13 ns ≥ 30 MHz	0.053 to 0.065	0.053 to 0.065	R&S®NRP40P 2.92 mm (m)
	0.053 to 0.065	0.053 to 0.065	R&S®NRP50P 2.4 mm (m)
			<b>Diode power sensors</b>
< 5 μs > 100 kHz	0.083 to 0.098	0.022 to 0.107	R&S®NRP8E N (m)
	0.083 to 0.112	0.022 to 0.109	R&S®NRP18E N (m)
			<b>Power sensor modules</b>
	0.070 to 0.112	0.032	R&S®NRP-Z27 N (m)
–	0.070 to 0.122	0.032	R&S®NRP-Z37 3.5 mm (m)
			<b>Level control sensors</b>
< 8 μs > 50 kHz	0.047 to 0.130	0.022 to 0.110	R&S®NRP-Z28 N (m)
–	0.047 to 0.083	0.022 to 0.066	R&S®NRP-Z98 N (m)

# POWER SENSOR OVERVIEW

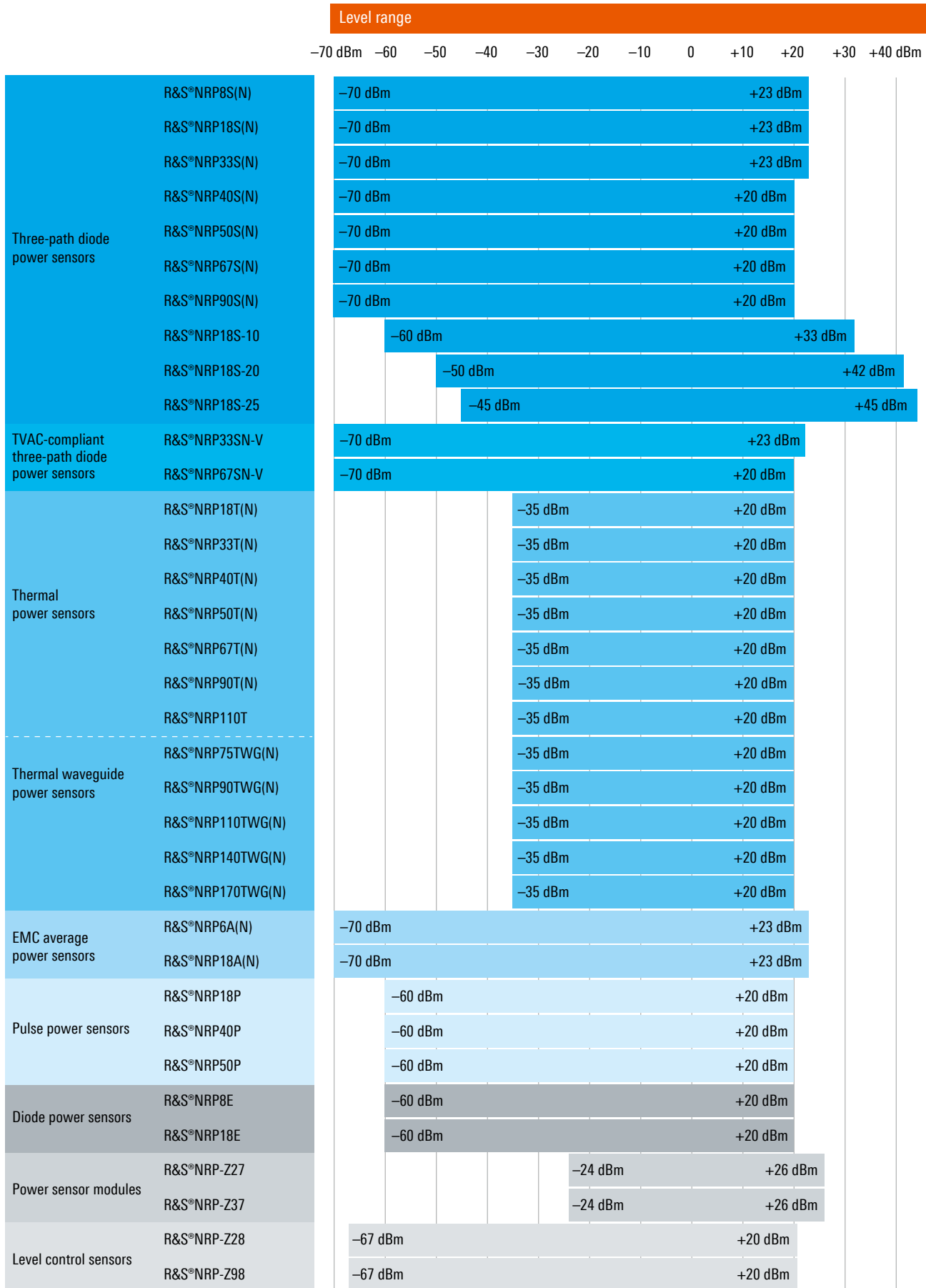



Frequency range

Connector type

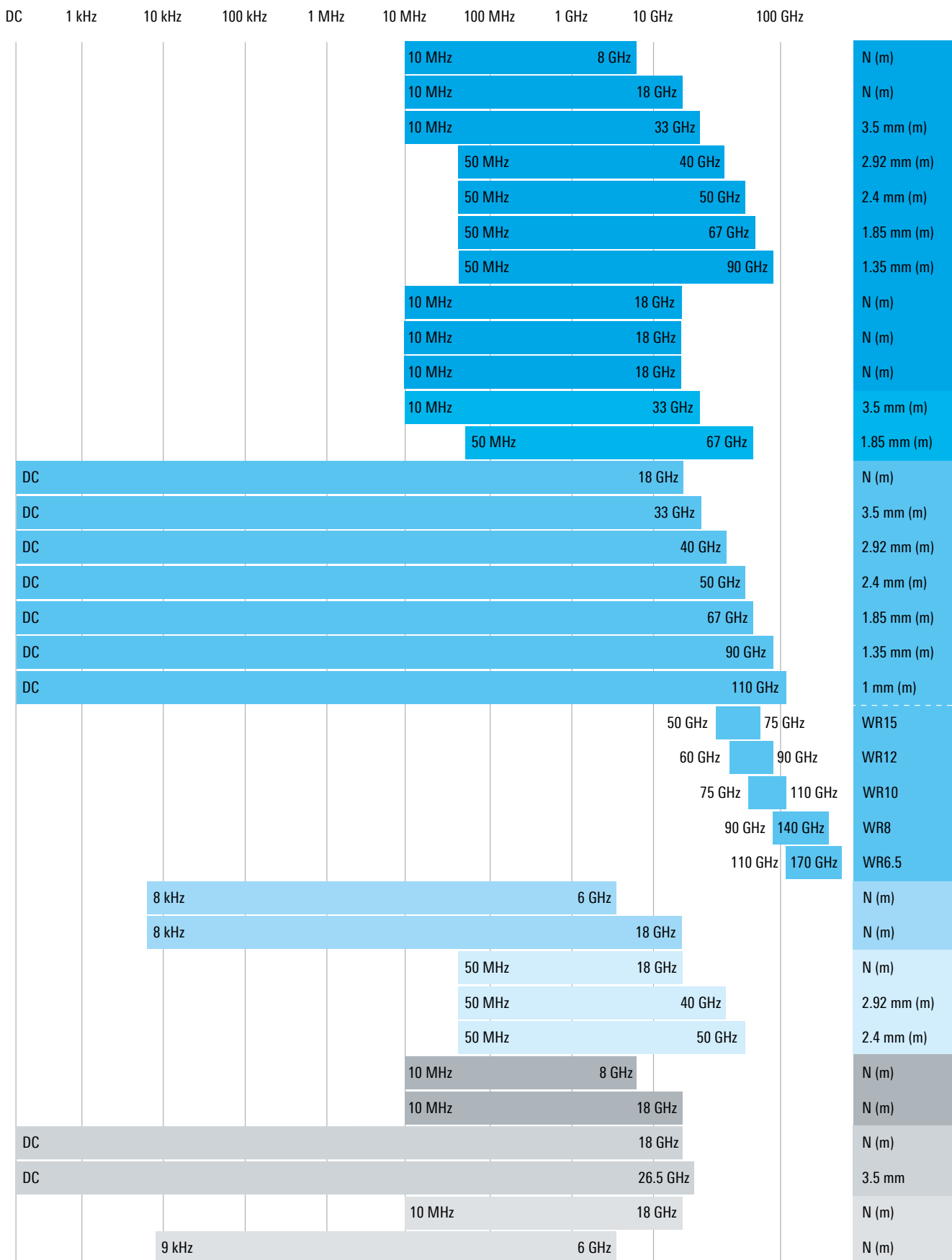

# ORDERING INFORMATION

Designation	Type	Order No.
<b>Base unit</b>		
Power meter	R&S®NRX	1424.7005.02
<b>Options</b>		
Second measurement channel	R&S®NRX-K2	1424.9208.02
Third and fourth measurement channel	R&S®NRX-K4	1424.9308.02
Sensor check source	R&S®NRX-B1	1424.7805.02
Third (C) and fourth (D) sensor connector for R&S®NRP	R&S®NRX-B4	1424.8901.02
GPIB/IEEE488 interface	R&S®NRX-B8	1424.8301.02
Sensor interface, for R&S®NRT	R&S®NRX-B9	1424.8601.02
Keysight emulation mode (N1911A/N1912A/N432A/E4418A/E4419A)	R&S®NRX-K301	1444.0041.02
<b>Three-path diode power sensor</b>		
100 pW to 200 mW, 10 MHz to 8 GHz	R&S®NRP8S	1419.0006.02
100 pW to 200 mW, 10 MHz to 8 GHz, LAN version	R&S®NRP8SN	1419.0012.02
100 pW to 200 mW, 10 MHz to 18 GHz	R&S®NRP18S	1419.0029.02
100 pW to 200 mW, 10 MHz to 18 GHz, LAN version	R&S®NRP18SN	1419.0035.02
100 pW to 200 mW, 10 MHz to 33 GHz	R&S®NRP33S	1419.0064.02
100 pW to 200 mW, 10 MHz to 33 GHz, LAN version	R&S®NRP33SN	1419.0070.02
100 pW to 100 mW, 50 MHz to 40 GHz	R&S®NRP40S	1419.0041.02
100 pW to 100 mW, 50 MHz to 40 GHz, LAN version	R&S®NRP40SN	1419.0058.02
100 pW to 100 mW, 50 MHz to 50 GHz	R&S®NRP50S	1419.0087.02
100 pW to 100 mW, 50 MHz to 50 GHz, LAN version	R&S®NRP50SN	1419.0093.02
100 pW to 100 mW, 50 MHz to 67 GHz	R&S®NRP67S	1424.6396.02
100 pW to 100 mW, 50 MHz to 67 GHz, LAN version	R&S®NRP67SN	1424.6409.02
100 pW to 100 mW, 50 MHz to 90 GHz, 1.35 mm connector	R&S®NRP90S	1424.6421.02
100 pW to 100 mW, 50 MHz to 90 GHz, 1.00 mm connector	R&S®NRP90S	1424.6421.03
100 pW to 100 mW, 50 MHz to 90 GHz, LAN version	R&S®NRP90SN	1424.6450.02
<b>High-power three-path diode power sensor</b>		
1 nW to 2 W, 10 MHz to 18 GHz	R&S®NRP18S-10	1424.6721.02
10 nW to 15 W, 10 MHz to 18 GHz	R&S®NRP18S-20	1424.6738.02
30 nW to 30 W, 10 MHz to 18 GHz	R&S®NRP18S-25	1424.6744.02
<b>TVAC-compliant three-path diode power sensor</b>		
100 pW to 200 mW, 10 MHz to 33 GHz, LAN version, TVAC-compliant	R&S®NRP33SN-V	1419.0129.02
100 pW to 100 mW, 50 MHz to 67 GHz, LAN version, TVAC-compliant	R&S®NRP67SN-V	1424.6415.02
<b>Thermal power sensors</b>		
300 nW to 100 mW, DC to 18 GHz	R&S®NRP18T	1424.6115.02
300 nW to 100 mW, DC to 18 GHz, LAN version	R&S®NRP18TN	1424.6121.02
300 nW to 100 mW, DC to 33 GHz	R&S®NRP33T	1424.6138.02
300 nW to 100 mW, DC to 33 GHz, LAN version	R&S®NRP33TN	1424.6144.02
300 nW to 100 mW, DC to 40 GHz	R&S®NRP40T	1424.6150.02
300 nW to 100 mW, DC to 40 GHz, LAN version	R&S®NRP40TN	1424.6167.02
300 nW to 100 mW, DC to 50 GHz	R&S®NRP50T	1424.6173.02
300 nW to 100 mW, DC to 50 GHz, LAN version	R&S®NRP50TN	1424.6180.02
300 nW to 100 mW, DC to 67 GHz	R&S®NRP67T	1424.6196.02
300 nW to 100 mW, DC to 67 GHz, LAN version	R&S®NRP67TN	1424.6209.02
300 nW to 100 mW, DC to 90 GHz	R&S®NRP90T	1424.6473.02
300 nW to 100 mW, DC to 90 GHz, LAN version	R&S®NRP90TN	1424.6480.02
300 nW to 100 mW, DC to 110 GHz	R&S®NRP110T	1424.6215.02

Designation	Type	Order No.
<b>Thermal waveguide power sensors</b>		
300 nW to 100 mW, 50 GHz to 75 GHz	R&S®NRP75TWG	1700.2529.02
300 nW to 100 mW, 50 GHz to 75 GHz, LAN version	R&S®NRP75TWGN	1440.5010.02
300 nW to 100 mW, 60 GHz to 90 GHz	R&S®NRP90TWG	1700.2312.02
300 nW to 100 mW, 60 GHz to 90 GHz, LAN version	R&S®NRP90TWGN	1440.5078.02
300 nW to 100 mW, 75 GHz to 110 GHz	R&S®NRP110TWG	1173.8709.02
300 nW to 100 mW, 75 GHz to 110 GHz, LAN version	R&S®NRP110TWGN	1440.5132.02
300 nW to 100 mW, 90 GHz to 140 GHz	R&S® NRP140TWG	1440.5190.02
300 nW to 100 mW, 90 GHz to 140 GHz, LAN version	R&S® NRP140TWGN	1440.5378.02
300 nW to 100 mW, 110 GHz to 170 GHz	R&S®NRP170TWG	1700.3754.02
300 nW to 100 mW, 110 GHz to 170 GHz, LAN version	R&S®NRP170TWGN	1440.5432.02
<b>Average power sensors</b>		
100 pW to 200 mW, 8 kHz to 6 GHz	R&S®NRP6A	1424.6796.02
100 pW to 200 mW, 8 kHz to 6 GHz, LAN version	R&S®NRP6AN	1424.6809.02
100 pW to 200 mW, 8 kHz to 18 GHz	R&S®NRP18A	1424.6815.02
100 pW to 200 mW, 8 kHz to 18 GHz, LAN version	R&S®NRP18AN	1424.6821.02
<b>Pulse power sensors</b>		
1 nW to 100 mW, 50 MHz to 18 GHz	R&S®NRP18P	1444.1190.02
1 nW to 100 mW, 50 MHz to 40 GHz	R&S®NRP40P	1444.1290.02
1 nW to 100 mW, 50 MHz to 50 GHz	R&S®NRP50P	1444.1390.02
<b>Diode power sensors</b>		
1 nW to 100 mW, 10 MHz to 8 GHz	R&S®NRP8E	1444.1090.02
1 nW to 100 mW, 10 MHz to 18 GHz	R&S®NRP18E	1444.1148.02
<b>Power sensor modules</b>		
4 µW to 400 mW, DC to 18 GHz	R&S®NRP-Z27	1169.4102.02
4 µW to 400 mW, DC to 26.5 GHz	R&S®NRP-Z37	1169.3206.02
<b>Level control sensors</b>		
200 pW to 100 mW, 9 kHz to 6 GHz	R&S®NRP-Z98	1170.8508.02
200 pW to 100 mW, 10 MHz to 18 GHz	R&S®NRP-Z28	1170.8008.02
<b>Recommended extras for R&amp;S®NRX</b>		
19" rack adapter (for one R&S®NRX power meter and one empty casing)	R&S®ZZA-KNA22	1177.8184.00
19" rack adapter (for two R&S®NRX power meters)	R&S®ZZA-KNA24	1177.8149.00
<b>Recommended extras for R&amp;S®NRPxxS(N)/T(N)/TWG(N)/A(N)</b>		
A minimum of one interface cable is required for power sensor operation.		
USB-A interface cable, 0.75 m	R&S®NRP-ZKU	1419.0658.02
USB-A interface cable, 1.50 m	R&S®NRP-ZKU	1419.0658.03
USB-A interface cable, 3.00 m	R&S®NRP-ZKU	1419.0658.04
USB-A interface cable, 5.00 m	R&S®NRP-ZKU	1419.0658.05
USB-C interface cable, 0.75 m	R&S®NRP-ZKC	1425.2442.02
USB-C interface cable, 1.50 m	R&S®NRP-ZKC	1425.2442.03
USB-C interface cable, 3.00 m	R&S®NRP-ZKC	1425.2442.04
6-pole interface cable, 1.50 m	R&S®NRP-ZK6	1419.0664.02
6-pole interface cable, 3.00 m	R&S®NRP-ZK6	1419.0664.03
6-pole interface cable, 5.00 m	R&S®NRP-ZK6	1419.0664.04
8-pole interface cable, 1.50 m	R&S®NRP-ZK8	1424.9408.02
8-pole interface cable, 3.00 m	R&S®NRP-ZK8	1424.9408.03
8-pole interface cable, 5.00 m	R&S®NRP-ZK8	1424.9408.04
Sensor hub	R&S®NRP-Z5	1146.7740.02
<b>Recommended extras for waveguide connectors</b>		
Torque wrench SW 3/32 (for waveguide screws)	R&S®ZCTW	1175.2014.02
<b>Recommended extras for R&amp;S®NRP110T</b>		
Waveguide bracket for R&S®NRP110T	R&S®NRP-ZBW	1700.2141.02
WR15 to 1 mm (f) adapter	R&S®WCA75	3626.1044.02
WR12 to 1 mm (f) adapter	R&S®WCA90	3626.1050.02
WR10 to 1 mm (f) adapter	R&S®WCA110	3626.1067.02

Designation	Type	Order No.
<b>Recommended extras for R&amp;S®NRP-Zxx</b>		
USB adapter cable (passive), 2 m	R&S®NRP-Z4	1146.8001.02
USB adapter cable (passive), 0.5 m	R&S®NRP-Z4	1146.8001.04
USB adapter cable (passive), 0.15 m	R&S®NRP-Z4	1146.8001.06
USB adapter cable (passive), 1 m, for panel mounting	R&S®NRP-Z4	1146.8001.11
Sensor hub	R&S®NRP-Z5	1146.7740.02
<b>Recommended extras for R&amp;S®NRPxxSN-V</b>		
Ethernet cable, air side, Micro-D (m) to RJ-45, 1.5 m	R&S®NRP-ZKASMD	1425.2420.02
Ethernet power sensor cable, air side, Micro-D (m) to RJ-45, 3 m	R&S®NRP-ZKASMD	1425.2420.03
Ethernet power sensor cable, air side, Micro-D (m) to RJ-45, 5 m	R&S®NRP-ZKASMD	1425.2420.05
Ethernet power sensor cable, air side, Micro-D (m) to RJ-45, 15 m	R&S®NRP-ZKASMD	1425.2420.15
Ethernet power sensor cable, air side, Micro-D (m) to RJ-45, 30 m	R&S®NRP-ZKASMD	1425.2420.30
Ethernet power sensor cable, air side, Micro-D (m) to RJ-45, 60 m	R&S®NRP-ZKASMD	1425.2420.60
Ethernet cable for TVAC applications, RJ-45 to Micro-D (m), 1.5 m	R&S®NRP-ZKVSMD	1425.2413.02
Ethernet cable for TVAC applications, RJ-45 to Micro-D (m), 3 m	R&S®NRP-ZKVSMD	1425.2413.03
Ethernet cable for TVAC applications, RJ-45 to Micro-D (m), 5 m	R&S®NRP-ZKVSMD	1425.2413.05
Ethernet cable for TVAC applications, RJ-45 to Micro-D (m), 15 m	R&S®NRP-ZKVSMD	1425.2413.15
Ethernet cable for TVAC applications, RJ-45 to Micro-D (m), 30 m	R&S®NRP-ZKVSMD	1425.2413.30
Ethernet cable for TVAC applications, RJ-45 to Micro-D (m), 60 m	R&S®NRP-ZKVSMD	1425.2413.60
Ethernet cable for TVAC applications, 2 × RJ-45, 1.5 m	R&S®NRP-ZKVSJR	1425.2407.02
Ethernet cable for TVAC applications, 2 × RJ-45, 3 m	R&S®NRP-ZKVSJR	1425.2407.03
Ethernet cable for TVAC applications, 2 × RJ-45, 5 m	R&S®NRP-ZKVSJR	1425.2407.05
Ethernet cable for TVAC applications, 2 × RJ-45, 15 m	R&S®NRP-ZKVSJR	1425.2407.15
Ethernet cable for TVAC applications, 2 × RJ-45, 30 m	R&S®NRP-ZKVSJR	1425.2407.30
Ethernet cable for TVAC applications, 2 × RJ-45, 60 m	R&S®NRP-ZKVSJR	1425.2407.60
<b>Documentation</b>		
Documentation of calibration values	R&S®DCV-1	0240.2187.06
Printout of DCV (in combination with DCV only)	R&S®DCV-ZP	1173.6506.02
Accredited calibration for R&S®NRX-B1, R&S®NRPxxS(N), R&S®NRPxxT(N), R&S®NRPxxTWG and R&S®NRPxxA(N)	R&S®NRP-ACA	1419.0812.00

<b>Warranty</b>		
R&S®NRX base unit, power sensors and R&S®NRP-Z5		3 years
All other items <sup>1)</sup>		1 year
<b>Service options</b>		
Extended warranty, one year	R&S®WE1	
Extended warranty, two years	R&S®WE2	
Extended warranty with calibration coverage, one year	R&S®CW1	Contact your local Rohde & Schwarz sales office.
Extended warranty with calibration coverage, two years	R&S®CW2	
Extended warranty with accredited calibration coverage, one year	R&S®AW1	
Extended warranty with accredited calibration coverage, two years	R&S®AW2	

<sup>1)</sup> For options installed, the remaining base unit warranty applies if longer than 1 year. Exception: all batteries have a 1 year warranty.

The Bluetooth® word mark and logos are registered trademarks owned by Bluetooth SIG, Inc. and any use of such marks by Rohde & Schwarz is under license. CDMA2000 is a registered trademark of the Telecommunications Industry Association (TIA-USA).

# FROM PRESALES TO SERVICE. AT YOUR DOORSTEP.

The Rohde & Schwarz network in over 70 countries ensures optimum on-site support by highly qualified experts.

User risks are reduced to a minimum at all project stages:

- ▶ Solution finding/purchase
- ▶ Technical startup/application development/integration
- ▶ Training
- ▶ Operation/calibration/repair





**Service at Rohde & Schwarz**  
You're in great hands

- ▶ Worldwide
- ▶ Local and personalized
- ▶ Customized and flexible
- ▶ Uncompromising quality
- ▶ Long-term dependability

**MAKE IDEAS REAL**  
and join our experts team  
at Rohde & Schwarz.



**Rohde & Schwarz**

The Rohde&Schwarz technology group is among the trail-blazers when it comes to paving the way for a safer and connected world with its leading solutions in test&measurement, technology systems and networks&cybersecurity. Founded 90 years ago, the group is a reliable partner for industry and government customers around the globe. The independent company is headquartered in Munich, Germany and has an extensive sales and service network with locations in more than 70 countries.

[www.rohde-schwarz.com](http://www.rohde-schwarz.com)

**Sustainable product design**

- ▶ Environmental compatibility and eco-footprint
- ▶ Energy efficiency and low emissions
- ▶ Longevity and optimized total cost of ownership

Certified Quality Management

**ISO 9001**

Certified Environmental Management

**ISO 14001**

**Rohde & Schwarz training**

[www.training.rohde-schwarz.com](http://www.training.rohde-schwarz.com)

**Rohde & Schwarz customer support**

[www.rohde-schwarz.com/support](http://www.rohde-schwarz.com/support)

