

WT5000
Precision Power Analyzer

U S E R ' S M A N U A L

List of Manuals

Thank you for purchasing the WT5000 Precision Power Analyzer. This User's Manual explains how to use the WT5000. To ensure correct use, please read this manual thoroughly before operation.

After reading this manual, keep it in a safe place. The following manuals, including this one, are provided as manuals for the WT5000. Please read all manuals.

Manual Title	Manual No.	Description
WT5000 Precision Power Analyzer Features Guide	IM WT5000-01EN	The supplied CD contains the PDF file of this manual. This manual explains all the instrument's features other than the communication interface features.
WT5000 Precision Power Analyzer User's Manual	IM WT5000-02EN	This document. The supplied CD contains the PDF file of this manual. The manual explains how to operate this instrument.
WT5000 Precision Power Analyzer Getting Started Guide	IM WT5000-03EN	This guide explains the handling precautions and basic operations of this instrument.
WT5000 Precision Power Analyzer Communication Interface User's Manual	IM WT5000-17EN	The supplied CD contains the PDF file of this manual. The manual explains the instrument's communication interface features and instructions on how to use them.
Model WT5000 Precision Power Analyzer Safety Instruction Manual	IM WT5000-92Z1 IM 00C01C01-01Z1	Document for China Safety manual (European languages)

The "EN" and "Z1" in the manual numbers are the language codes.

Contact information of Yokogawa offices worldwide is provided on the following sheet.

Document No.	Description
PIM 113-01Z2	List of worldwide contacts

Notes

- The contents of this manual are subject to change without prior notice as a result of improvements to the product's performance and functionality. Refer to our website to view our latest manuals.
- The figures given in this manual may differ from those that actually appear on your screen.
- Every effort has been made in the preparation of this manual to ensure the accuracy of its contents. However, should you have any questions or find any errors, please contact your nearest YOKOGAWA dealer.
- Copying or reproducing all or any part of the contents of this manual without the permission of YOKOGAWA is strictly prohibited.
- The TCP/IP software of this product and the documents concerning it have been developed/created by YOKOGAWA based on the BSD Networking Software, Release 1 that has been licensed from the Regents of the University of California.

Trademarks

- Microsoft, MS-DOS, Windows, Windows10, and Windows 11 are registered trademarks or trademarks of Microsoft Corporation in the United States and/or other countries.
- Adobe and Acrobat are either registered trademarks or trademarks of Adobe Systems Incorporated.
- In this manual, the ® and TM symbols do not accompany their respective registered trademark or trademark names.
- Other company and product names are trademarks or registered trademarks of their respective holders.

Revisions

- 1st Edition: September 2018
- 2nd Edition: January 2020
- 3rd Edition: February 2021
- 4th Edition: September 2021
- 5th Edition: March 2022
- 6th Edition: February 2023

Conventions Used in This Manual

Notes

The notes and cautions in this manual are categorized using the following symbols.



Improper handling or use can lead to injury to the user or damage to the instrument. This symbol appears on the instrument to indicate that the user must refer to the user's manual for special instructions. The same symbol appears in the corresponding place in the user's manual to identify those instructions. In the manual, the symbol is used in conjunction with the word "WARNING" or "CAUTION."

WARNING

Calls attention to actions or conditions that could cause serious or fatal injury to the user, and precautions that can be taken to prevent such occurrences.

CAUTION

Calls attention to actions or conditions that could cause light injury to the user or damage to the instrument or user's data, and precautions that can be taken to prevent such occurrences.

French

AVERTISSEMENT

Attire l'attention sur des gestes ou des conditions susceptibles de provoquer des blessures graves (voire mortelles), et sur les précautions de sécurité pouvant prévenir de tels accidents.

ATTENTION

Attire l'attention sur des gestes ou des conditions susceptibles de provoquer des blessures légères ou d'endommager l'instrument ou les données de l'utilisateur, et sur les précautions de sécurité susceptibles de prévenir de tels accidents.

Note

Calls attention to information that is important for the proper operation of the instrument.

Character Notations

Menu Names and Panel Keys in Bold Characters

Indicate controls such as menu commands, tabs, and buttons that appear on the screen and front panel keys

Prefixes k and K

Prefixes k and K used before units are distinguished as follows:

k	Denotes 1000. Example: 100 kHz
K	Denotes 1024. Example: 720 KB (file size)

Menu Icons

Menu Icon Types

You can control all the settings of this instrument using the *setup menu*, which is explained in chapter 1. Separate from the setup menu, dedicated icons are displayed for settings that are particularly used often. These icons are referred to as *menu icons* in this manual.

When you tap a menu icon, related settings are displayed in the sub menu area (Small menu*).

Therefore, when you use a menu icon, you can change the settings while viewing the measurement.

- * The Small menu is displayed on the right side of the screen. It can be used to configure or execute operations while viewing the measurement results on the screen.

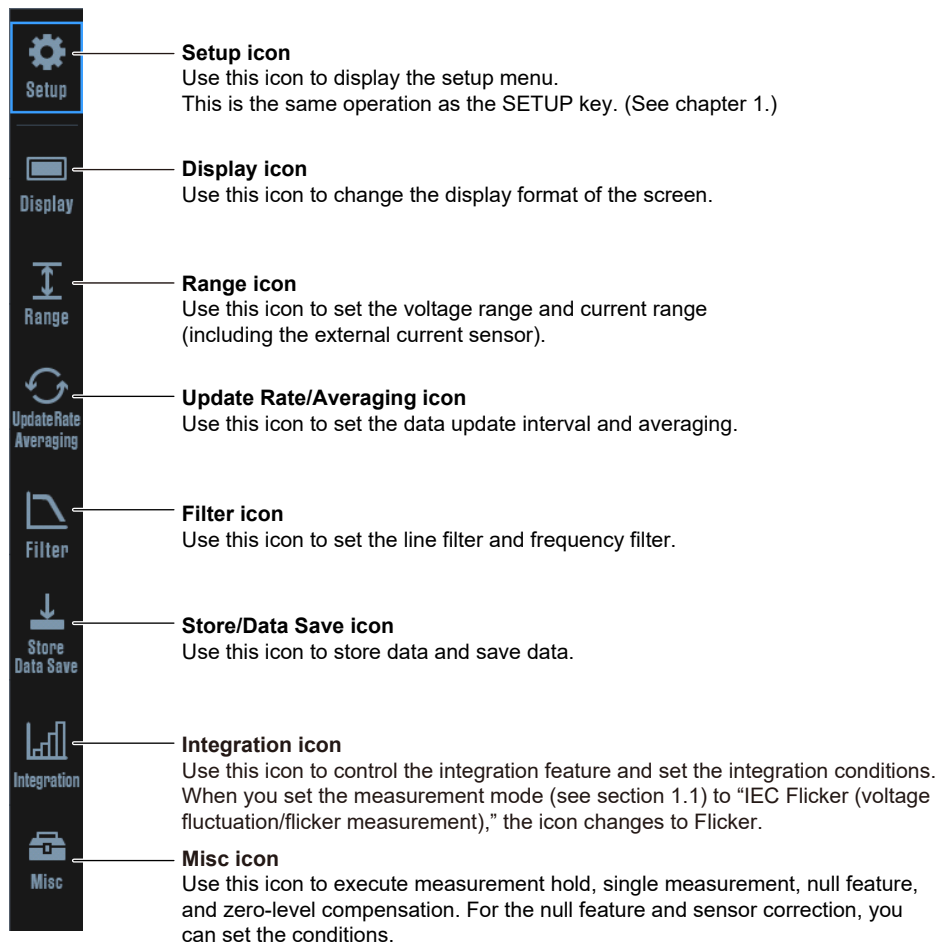

Note

Some features are disabled when the measurement mode (see section 1.1) is set to IEC harmonic measurement (IEC Harmonic) or voltage fluctuation/flicker measurement (IEC Flicker). The menu icons of disabled features appear dimmed. Menus will not appear even if you tap dimmed icons.

Display Icon

Use this icon to change the display format of the screen.



Display Menu

Closes the menu

Selects the screen display
Shows only the numeric or graphic screen in a single screen or splits the screen into top and bottom halves and shows the selected screen in each half. (See sections 3.1 or 6.1.)

Set the numeric display format (All Items, 4 Items, 8 Items, 16 Items, Matrix, Hrm List Single, Hrm List Dual, User).
Set how many measurement results to display in a single screen. Hrm List Single and Hrm List Dual are harmonic list displays (see section 5.2). If you select User, set the numeric value position, color, and so on according to the loaded background

Switches the displayed page (Page Up/Page Down)
Switches the numeric data screen shown in each display format.
This is the same as tapping ▲ and ▼ on the measurement display screen (see section 3.2).

Switches the displayed items
Switch the measured values (measurement function) shown in the screen.

Selects the display page to switch (Hrm List Single or Hrm List Dual)
Header: Switches the pages in the measurement function display area
List: Switches the pages in the harmonic data display area (See section 3.1.)

Set the graph display format (Wave, Trend, Bar, Vector) (see sections 6.2 to 6.5).

Switch the displayed group (Group1 to Group4)(see sections 6.2 to 6.5).

Switches the graph display items (see sections 6.2 to 6.5)
Select the voltage, current, or other graph to show on the screen.

Set the display format (see sections 6.2 to 6.5).
Set the divisions and time scale of the graph screen.

Displays trend values (see section 6.3)
Displays the current trend values. You can set this when the graph display format is Trend.

Cursor measurement (see chapter 12)
Register the custom display (see section 3.8).

Switching the Displayed Items (Item)

On the All Items Display

Numeric Items **Closes the menu**

All Items

Order (k) **Set the harmonic order (Total, 0-500).**
 You can set this setting only when you have selected the page of a measurement function that includes a harmonic order (pages 9 and 10). For details on how to switch pages, see page 3-1.

Display All Elements **OFF** **Turns the display of numeric data of all elements or all wiring units on and off**
 If the total number of elements or wiring units is 8 or more, set this to ON when you want to display the numeric data of all elements or all wiring units.

Turns the display frame on and off
 Scroll the screen horizontally to change the displayed element or wiring unit. You can use these when Display All Elements is set to OFF.

Note

On the All Items display, you cannot select individual displayed items and change their measurement function, element, or wiring unit. If you switch to the Matrix display, you can change the measurement functions, elements, and wiring units using the displayed table (see the previous page).

On the 4-, 8-, and 16-Value Displays

Numeric Items **Closes the menu**

4 Items

Item No. **Select the displayed item number.**
 On the 4-, 8-, and 16-value displays, the number increases from the upper left to the lower right of the screen. You can also tap the measurement display screen (see page vii).

Function
Urms **Set the displayed item.**
 Set the displayed measurement function (see section 3.1).

Element/Σ
Element 1 **Selects the input element or wiring unit to be configured**

Order (k)
Total **Selects the harmonic order to be set**
 This is for the harmonic display (see section 5.2).

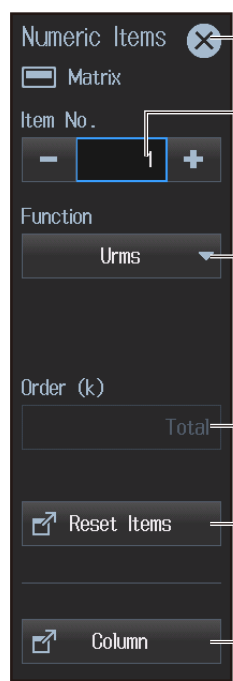

Reset Items **Resets the displayed items.**
 (See page vii.)

On the Matrix Display





Numeric Items  — **Closes the menu**

 Matrix

Item No.   — **Select the displayed item number (displayed row).**
The number increases from top to bottom on the matrix display.
Example: If you select 3, the third row from the top is displayed.
You can also tap the measurement display screen (see page vii).

Function  — **Set the displayed item.**
Set the displayed measurement function (see section 3.1).
Urms

Order (k)  — **Selects the harmonic order to be set**
This is for the harmonic display (see section 5.2).
Total

 Reset Items — **Resets the displayed items.**
(See page vii.)

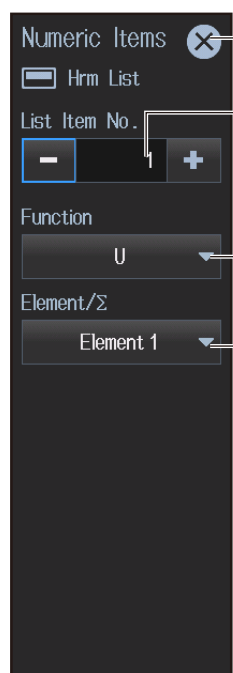

 Column — **Configure the columns to display.**
Set the number of columns to display the matrix. (See section 3.1.)

On the Hrm List Single or Hrm List Dual Display



Numeric Items  — **Closes the menu**

 Hrm List

List Item No.   — **Select the displayed harmonic data column.**
This is for Hrm List Dual.
Select 1 (left column) or 2 (right column).
You can also tap the measurement display screen (see page vii).

Function  — **Set the displayed item.**
Set the displayed measurement function (see section 3.1).
U

Element/ Σ  — **Selects the input element (Element1 to Element7) or wiring unit (ΣA , ΣB , ΣC) to be configured**
Element 1

Note

On the harmonics list displays, you can change the measurement function, element, and wiring unit for the selected list, but you cannot change these settings for each individual displayed item.

Selecting the Displayed Item Number or Displayed Harmonic Data Column

While you are changing the displayed items, you can select the displayed item or displayed harmonic data column you want shown by tapping the measurement display screen directly with a Small menu shown.

This is the same operation as selecting the displayed item number (on the 4-, 8-, and 16-value displays and matrix display) and selecting the displayed harmonic data column (on the Hrm List Single or Hrm List Dual display).

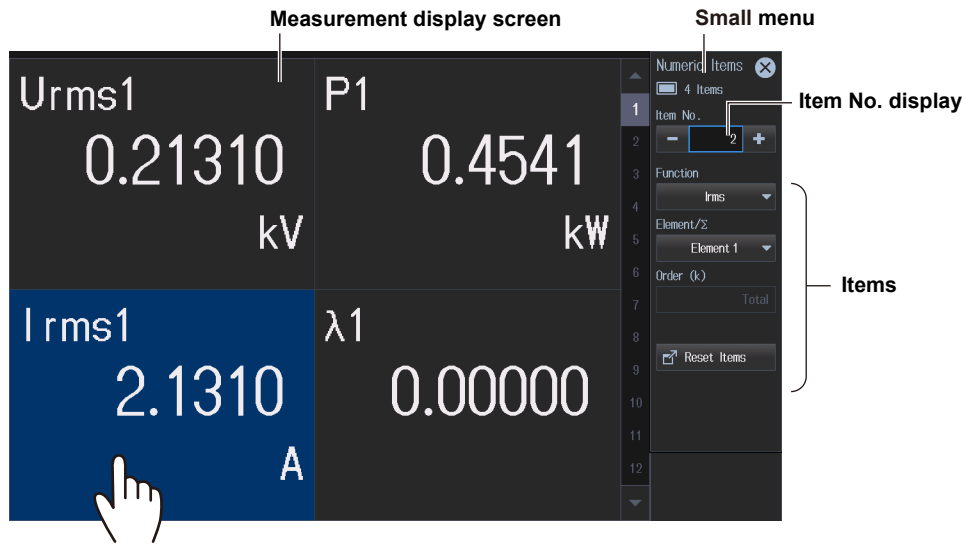

1. Tap the Item No.2 area. The Item No. display changes to 2.
2. Set the items (e.g., function).

Resetting the Displayed Items

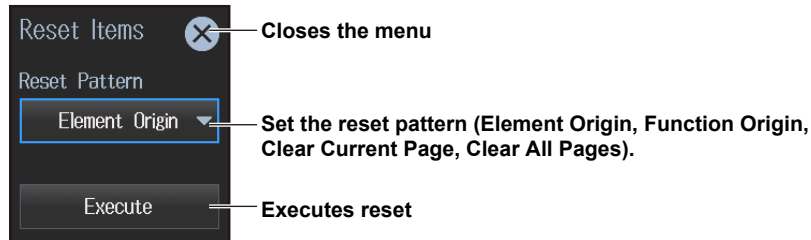

Range Icon

Use this icon to set the voltage range and current range (including the external current sensor).



Range Menu

Range ✕ Closes the menu

Σ A
Σ B No Wiring
Σ C

Elements

1 2 3
4 5 6
7

Voltage Range Auto
1000V (1500Vdc) OFF

Current Range Auto
30A OFF

Ext Sensor OFF

Sensor

Advanced

Selects the element to be configured

Selects the voltage range (see section 2.2)

Selects the current range (see section 2.2)

When the input element is a 760903 current sensor element

Configure the external current sensor.

Advanced measurement range settings (see section 2.5)

Configuring the External Current Sensor

Sensor ✕ Closes the menu

When the input element is 760901 or 760902

When the input element is 760903

Element 1 30A Element 2 30A Element 3 30A Element 4 5A Element 5 5A Element 6 CS Element 7 CS

Ext Sensor ON OFF OFF OFF OFF

Sensor Preset Others Others Others Others Others

Sensor Ratio [mV/A (mΩ)] 10.0000 10.0000 10.0000 10.0000 10.0000

Terminal

CT Preset

Input Resistance

Probe Preset

Output Voltage Rate [V/A]

Set the external current sensor on and off

Set the sensor conversion ratio (see section 2.3).

Set the sensor conversion ratio preset (see section 2.3). The sensor conversion ratio preset is currently not available.

Set the current sensor to be connected to the current measurement terminal (see section 2.2).

Update Rate/Averaging Icon

Use this icon to set the data update interval and averaging.



Update Rate/Averaging Menu

When the Update Mode is Constant or Trigger

Update Rate menu

Update Rate **Closes the menu**

Fast Slow

- 500ms + **Set the data update interval (for the parameters, see section 2.10).**

Measurement Method

Digital Filter Average **Set the measurement method (for the parameters, see section 2.10).**

Response

Mid (≥ 10Hz) **Set the response (for the parameters, see section 2.10).**
You can use this when the computing method is set to digital filter average.
You cannot use this when the computing method is set to sync source period average.

Advanced **Advanced data update interval and averaging settings**
For details on the data update interval, see section 2.10.
For details on averaging, see section 2.13.

Averaging

Turns averaging on and off

Averaging Type

Exp **Set the averaging type (for the parameters, see section 2.13).**

Averaging Count

2 **Set the attenuation constant or average count (for the parameters, see section 2.13).**

Averaging menu

When the Update Mode is Auto

Update Rate menu

Update Rate  Closes the menu

Update Rate
10ms Set the data update interval (for the parameters, see section 2.10).

Time Out
1 s Set the timeout period (for the parameters, see section 2.10).

 Advanced **Advanced data update interval and averaging settings**
For details on the data update interval, see section 2.10.
For details on averaging, see section 2.13.

Averaging
 Turns averaging on and off

Averaging Type
Exp Set the averaging type (for the parameters, see section 2.13).

Averaging Count
2 Set the attenuation constant or average count (for the parameters, see section 2.13).

Averaging menu

Filter Icon

Use this icon to set the line filter and frequency filter.



Filter Menu

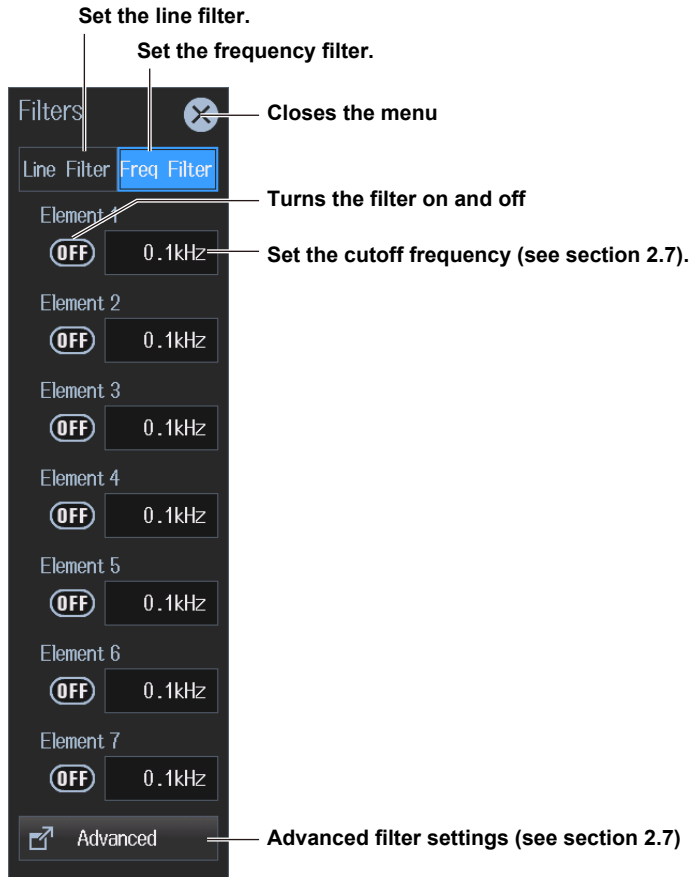

This instrument has three measurement modes (see section 1.1). A filter menu is displayed according to the measurement mode. Shown above is the menu for normal measurement mode.

Store/Data Save Icon

Use this icon to store data and save data.



Store/Data Save Menu

Store menu

The Store menu is a vertical list of options on a dark background. At the top is a close button (an 'X' in a circle). Below it is a 'User' dropdown menu. The main options are: 'Rec' (with a red dot icon), 'Pause' (with a yellow pause icon), 'End' (with a white icon), and 'Advanced' (with a white icon). Below these is a 'Data Save' section with a 'User' dropdown menu, three checked checkboxes for 'Numeric', 'Wave', and 'Image', a 'Save Exec' button, and another 'Advanced' button.

- Closes the menu**: Points to the close button (X icon).
- Storage destination drive**: Points to the User dropdown menu.
- Starts storage**: Points to the Rec button. Storage starts according to the specified storage mode (see section 7.1).
- Pauses storage**: Points to the Pause button. Storage is temporarily paused. Tap REC to resume storage.
- Ends storage**: Points to the End button. Storage stops, and the storage state is reset. Writing the stored data to the file is completed, and the file is closed.
- Configure storage (see sections 7.1 to 7.3)**: Points to the Advanced button.
- Save destination drive**: Points to the User dropdown menu in the Data Save section.
- Select the data you want to save.**
Data whose check box is selected will be saved. Points to the checked checkboxes for Numeric, Wave, and Image.
- Starts saving**: Points to the Save Exec button.
- Configure data saving (see sections 8.2 to 8.4)**: Points to the Advanced button in the Data Save section.

Data Save menu

Integration Icon

Use this icon to set integration conditions.



Integration Menu

The screenshot shows the Integration menu with the following callouts:

- Closes the menu**: Points to the close button (X icon) at the top right of the menu.
- Turns independent computation on and off**: Points to the 'ON' toggle switch under 'Independent Control'.
- Select the input elements that you want independent computation to be performed on.**
You can set this when independent computation is set to on.
Points to the 'Element Objects' section, which contains seven checkboxes labeled 1 through 7, all of which are checked.
- Collectively selects input elements to perform independent computation on.**
All ON: All input elements will be selected.
All OFF: All input elements will be unselected.
Points to the 'All ON' and 'All OFF' buttons.
- Starts integration**
Integration starts according to the specified integration conditions (see section 4.1).
The START key in the INTEGRATION area turns on.
Points to the 'Start' button (play icon).
- Stops integration**
Integration stops automatically according to the specified integration conditions.
The START key in the INTEGRATION area turns off, and the STOP key turns on.
Points to the 'Stop' button (pause icon).
- Resets the integration time and integrated value.**
All integration data is deleted, and the no-data display, "-----," appears. The STOP key in the INTEGRATION area turns off.
Points to the 'Reset' button.
- Set integration conditions (see section 4.1).**
Points to the 'Advanced' button (arrow icon).

When you set the measurement mode (see section 1.1) to "IEC Flicker," the Integration icon changes to the Flicker icon. See the next page.

Flicker Icon

Use this icon to execute voltage fluctuations/flicker measurements.



Flicker Menu

Normal voltage fluctuation/flicker measurement

Flicker Closes the menu

Measurement Mode
Flicker Set the measurement mode to Flicker.

Display Element
Element 1 Switch the element you want to display the measurement data of.

- Page 1 +
1 Scrolls the screen page

Initialize Exec Executes initialization

Start Starts a measurement

Reset Reset

Flicker Settings Set the measurement conditions and judgment conditions (see section 14.1).

Measurement of dmax caused by manual switching

Flicker Closes the menu

Measurement Mode
dmax Set the measurement mode to dmax.

Display Element
Element 1 Switch the element you want to display the measurement data of.

Initialize Exec Executes initialization

Start Starts a measurement

Reset Reset

Judge Completes the measurement and displays the judgment

Move Period Changes the observation period and measures again

Flicker Settings Set the measurement conditions and judgment conditions (see section 14.1).

Misc Icon

Use this icon to execute measurement hold, single measurement, null feature, and zero-level compensation. For the null feature and sensor correction, you can set the conditions.



Misc Menu

The image shows a vertical menu with several sections. Callouts with lines pointing to specific elements provide the following information:

- Closes the menu**: Points to a close button (X) at the top of the menu.
- Executes the holding of measured values (OFF, ON)**: Points to a toggle switch currently set to 'OFF'. A sub-note states: "When holding is in progress, the HOLD key illuminates."
- Executes single measurement**: Points to an 'Execute' button under the 'Single' section. A sub-note states: "You can execute this once while holding is in progress."
- Enables or disables the null feature (OFF, ON)**: Points to a toggle switch currently set to 'OFF'. A sub-note states: "While the null feature is enabled, the NULL key illuminates."
- Configure the null feature (see section 11.1)**: Points to an 'Advanced' button with an external link icon.
- Executes zero-level compensation (Cal) (see section 11.2)**: Points to an 'Execute' button under the 'Cal' section.
- Set the sensor correction (see section 2.6)**: Points to two buttons: 'Current Amplitude Correction' and 'Current Phase Correction', both with external link icons.

Contents

List of Manuals.....	i
Conventions Used in This Manual	iii
Menu Icons	iv
Chapter 1 Setup Menu	
1.1 Setting the Measurement Mode	1-1
1.2 Input Settings Overview	1-2
1.3 Computation and Output Settings Overview	1-9
1.4 Utility Settings Overview.....	1-15
1.5 Saving, Loading, and Initializing Setup Data.....	1-21
1.6 Current Sensor Setup Menu.....	1-24
1.7 Easy Setup Menu	1-26
Chapter 2 Setting Basic Measurement Conditions	
2.1 Setting the Wiring System	2-1
2.2 Setting the Voltage Range and Current Range	2-3
2.3 Configuring the Current Sensor.....	2-9
2.4 Setting the Voltage Transformer (VT) and Current Transformer (CT) Ratios	2-13
2.5 Setting the Valid Measurement Range	2-15
2.6 Setting the Sensor Correction	2-20
2.7 Setting the Line Filter and Frequency Filter	2-21
2.8 Set the Measurement Period.....	2-27
2.9 Setting the Crest Factor	2-29
2.10 Setting the Data Update Interval	2-30
2.11 Setting the Efficiency Equation.....	2-33
2.12 Setting the Delta Computation	2-34
2.13 Setting Averaging	2-35
2.14 Master/slave Synchronous Measurement.....	2-36
Chapter 3 Power Display (Numeric Display)	
3.1 Setting the Display Format	3-1
3.2 Displaying the Voltage, Current, Active Power, and Power Factor.....	3-9
3.3 Displaying Apparent Power, Reactive Power, and Corrected Power	3-11
3.4 Displaying the Phase Difference And Frequency (Voltage and Current).....	3-14
3.5 Displaying Computed Values (Values and Events)	3-17
3.6 Holding the Maximum Values.....	3-22
3.7 User Display	3-25
3.8 Custom Display	3-28
Chapter 4 Integrated Value Measurement (watt hours and ampere hours)	
4.1 Setting Integration Conditions	4-1
4.2 Displaying Integrated Values (numeric display).....	4-6
Chapter 5 Harmonic Measurement	
5.1 Setting Harmonic Measurement Conditions.....	5-1
5.2 Displaying Harmonic Measurements (numeric display)	5-3

Chapter 6	Graph Display	
6.1	Setting the Display Format.....	6-1
6.2	Waveform Display	6-4
6.3	Trend display	6-7
6.4	Bar Graph Display	6-11
6.5	Vector Display	6-14
Chapter 7	Storing Numeric Data	
7.1	Setting the Storage Operation.....	7-1
7.2	Setting Stored Items.....	7-6
7.3	Setting the Data Storage Destination	7-9
7.4	Starting (Rec), Pausing (Pause), and Ending (End) Storage	7-11
Chapter 8	Saving Numeric Data, Waveform Data, and Screen Images	
8.1	Connecting a USB Memory Device.....	8-1
8.2	Setting the Save Destination for Numeric Data, Waveform Data, and Screen Images....	8-3
8.3	Setting the Numeric Data Items to Save	8-6
8.4	Setting the Format of Saved Screen Images	8-9
8.5	Saving Numeric Data, Waveform Data, and Screen Images	8-11
8.6	File Operations	8-13
Chapter 9	Motor Evaluation and Auxiliary Input (Option)	
9.1	Configuring Motor Evaluation and Auxiliary Input Settings.....	9-1
9.2	Displaying the Motor Evaluation (numeric display)	9-12
Chapter 10	Holding Measured Values and Performing Single Measurements	
10.1	Holding Measured Values.....	10-1
10.2	Single Measurement	10-3
Chapter 11	Null Feature (DC offset cancelation) and Zero-Level Compensation (Cal)	
11.1	Configuring, Enabling, and Disabling the Null Feature.....	11-1
11.2	Zero-Level Compensation (Cal)	11-3
Chapter 12	Cursor Measurement	
12.1	Cursor Measurement on Waveforms.....	12-1
12.2	Cursor Measurement on Trends.....	12-3
12.3	Cursor Measurement on Bar Graphs	12-5
Chapter 13	Performing IEC Harmonic Measurements (Option)	
13.1	Setting IEC Harmonic Measurement Conditions.....	13-1
Chapter 14	IEC Voltage Fluctuation/Flicker Measurement (Option)	
14.1	Configuring IEC Voltage Fluctuation/Flicker Measurements.....	14-1
14.2	Executing IEC Voltage Fluctuation/Flicker Measurements.....	14-3
Chapter 15	Ethernet Communication	
15.1	Connecting the Instrument to a Network	15-1
15.2	Configuring the TCP/IP Settings.....	15-3
15.3	Accessing the Instrument from a PC (FTP Server)	15-5
15.4	Web Server Feature	15-6
15.5	Connecting to a Network Drive.....	15-8
15.6	Setting the Date and Time via SNTP.....	15-9

Chapter 16 Utility

16.1	Remote Control	16-1
16.2	Configuring the D/A Output (option)	16-3
16.3	Configuring the IEEE 1588 Time Synchronization	16-4
16.4	Setting the Message, Menu, and USB Keyboard Languages	16-6
16.5	Setting the Screen Brightness and Turning the Screen Off.....	16-7
16.6	Environment Settings (Preference)	16-8
16.7	Self-Test	16-10
16.8	Displaying and Saving the Message Log	16-12
16.9	Viewing the Instrument Information and Current Sensor Status	16-14
16.10	Locking the Touch Panel and Front Panel Operations	16-16

Appendix

Appendix 1	Messages and Corrective Actions	App-1
------------	---------------------------------------	-------

Index

1.1 Setting the Measurement Mode

This instrument has the following measurement modes. Configure various settings according to the measurement mode.

- **Normal measurement (Normal)**
This mode has settings required for normal power measurements and a setup menu for common features. The settings required for power measurements are also used in IEC harmonic and voltage fluctuations/flicker measurements when necessary.
- **IEC Harmonic measurement (IEC Harmonic)**
This mode has a setup menu for IEC harmonic measurements. See chapter 13.
- **IEC Voltage fluctuation/flicker measurement (Flicker)**
This mode has a setup menu for IEC voltage fluctuation/flicker measurements. See chapter 14.



Measurement Mode (Measurement Mode)

1. Tap the **Setup** icon , or press **MENU** under **SETUP**. The setup menu screen appears.

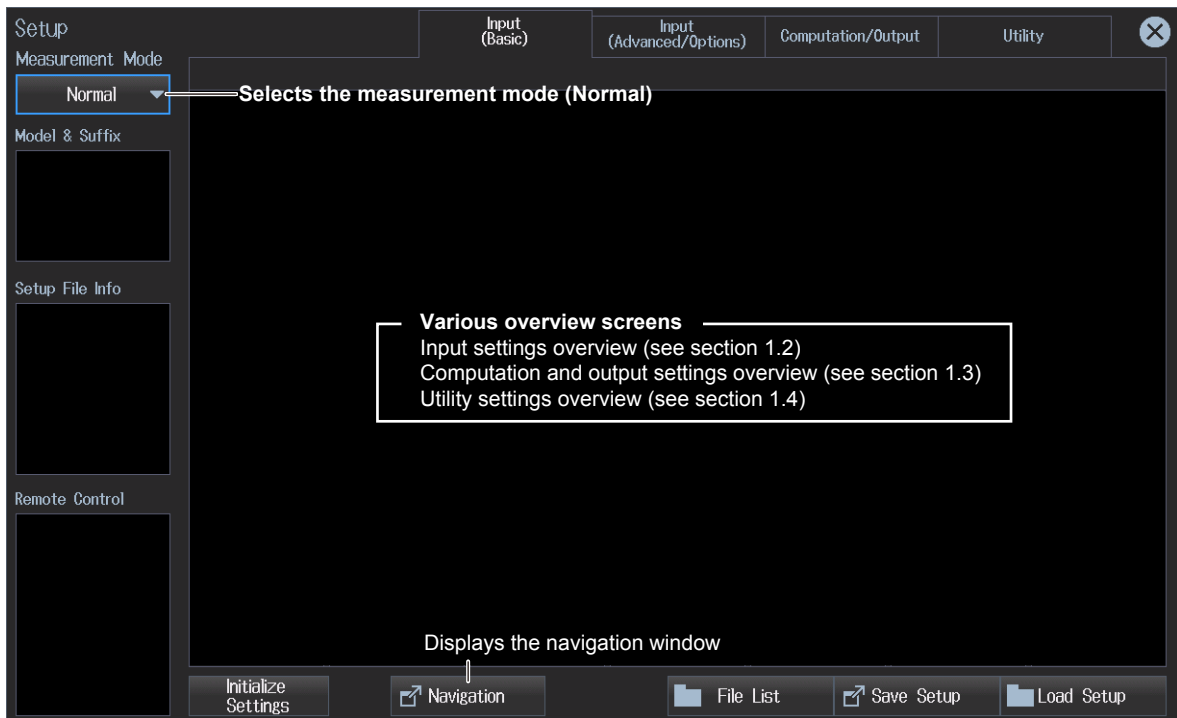

Note

You can also display the setup menu screen from the navigation window that appears immediately after power-on.

Navigation window

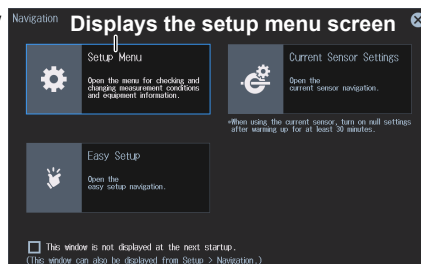

1.2 Input Settings Overview

The settings applied to the input elements and wiring units that are installed in this instrument are shown in table format. You can control all the settings from this overview screen.

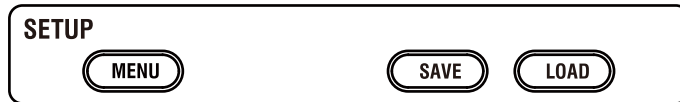

Input Settings (Basic) Overview (Input (Basic))

1. Tap the **Setup** icon  or press **MENU** under SETUP.
2. Tap the **Input (Basic)** tab. An input settings (basic measurement conditions) overview screen appears.
Pressing **ESC** closes the overview screen.

Input (Basic) tab

The screenshot shows the 'Input (Basic) tab' interface. It features a top navigation bar with tabs: 'Input (Basic)', 'Input (Advanced/Options)', 'Computation/Output', and 'Utility'. Below the navigation bar is a table with 7 columns, one for each element. Each column contains various settings such as Wiring, Voltage Range, Current Range, Ratio, Scaling, VT Ratio, CT Ratio, SF Ratio, Line Filter Cutoff, Freq Filter Cutoff, and Sync Source. Brackets at the bottom of the table indicate that elements 1-5 are for input elements 760901 or 760902, and elements 6-7 are for input element 760903. A note at the bottom states: 'Shows the settings of Element1 to Element7. You can also set the input element items.'

Element 1	Element 2	Element 3	Element 4	Element 5	Element 6	Element 7
30A	30A	30A	5A	5A	CS	CS
Wiring: 1P2W	Wiring: 1P2W	Wiring: 1P2W	Wiring: 1P2W	Wiring: 1P2W	Wiring: 1P2W	Wiring: 1P2W
Voltage Range: 1000V	Voltage Range: 1000V	Voltage Range: 1000V	Voltage Range: 1000V	Voltage Range: 1000V	Voltage Range: 1000V	Voltage Range: 1000V
Current Range: 30A	Current Range: 30A	Current Range: 30A	Current Range: 5A	Current Range: 5A	Current Range: 1A	Current Range: 1A
Ratio [mV/A]: 10.0000	Ratio [mV/A]: 10.0000	Ratio [mV/A]: 10.0000	Ratio [mV/A]: 10.0000	Ratio [mV/A]: 10.0000	CT Preset: Custom	CT Preset: Custom
Scaling: ON	Scaling: ON	Scaling: ON	Scaling: ON	Scaling: ON	Scaling: ON	Scaling: ON
VT Ratio: 1.0000	VT Ratio: 1.0000	VT Ratio: 1.0000	VT Ratio: 1.0000	VT Ratio: 1.0000	VT Ratio: 1.0000	VT Ratio: 1.0000
CT Ratio: 1.0000	CT Ratio: 1.0000	CT Ratio: 1.0000	CT Ratio: 1.0000	CT Ratio: 1.0000	CT Ratio: 1.0000	CT Ratio: 1.0000
SF Ratio: 1.0000	SF Ratio: 1.0000	SF Ratio: 1.0000	SF Ratio: 1.0000	SF Ratio: 1.0000	SF Ratio: 1.0000	SF Ratio: 1.0000
Line Filter Cutoff: 0.5kHz	Line Filter Cutoff: 0.5kHz	Line Filter Cutoff: 0.5kHz	Line Filter Cutoff: 0.5kHz	Line Filter Cutoff: 0.5kHz	Line Filter Cutoff: 0.5kHz	Line Filter Cutoff: 0.5kHz
Freq Filter Cutoff: 0.1kHz	Freq Filter Cutoff: 0.1kHz	Freq Filter Cutoff: 0.1kHz	Freq Filter Cutoff: 0.1kHz	Freq Filter Cutoff: 0.1kHz	Freq Filter Cutoff: 0.1kHz	Freq Filter Cutoff: 0.1kHz
Sync Source: I1	Sync Source: I2	Sync Source: I3	Sync Source: I4	Sync Source: I5	Sync Source: I6	Sync Source: I7

When the input element is 760901 or 760902 When the input element is 760903

Shows the settings of Element1 to Element7
You can also set the input element items.

Note

- You can also display the input settings overview screen by moving the cursor on the Input (Basic) tab using the arrow keys and then pressing SET.
- You can also display the setup menu screen from the navigation window that appears immediately after power-on.

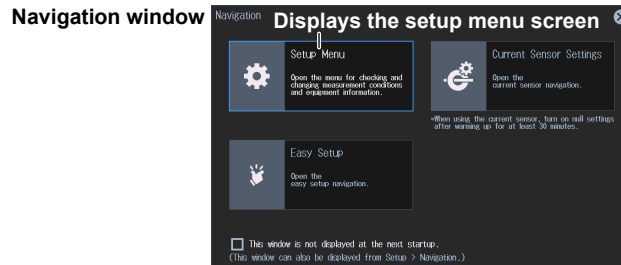

Configuring Input Elements

You can edit settings by tapping the setting buttons in each input element area of the overview screen.

When the input element is 760901 or 760902

When the input element is 760903

<p>Element 1 30A</p> <p>Wiring 1P2W</p> <p>Voltage Range 1000V</p> <p>Current Range 30A</p> <p>Ratio [mV/A] 10.0000</p> <p>Scaling ON</p> <p>VT Ratio 1.0000</p> <p>CT Ratio 1.0000</p> <p>SF Ratio 1.0000</p> <p>Line Filter ON</p> <p>Cutoff 0.5kHz</p> <p>Freq Filter ON</p> <p>Cutoff 0.1kHz</p> <p>Sync Source</p>	<p>Set the wiring system (see section 2.1). ▶ “Wiring System (Wiring)” in the features guide</p> <p>Set the voltage range (see section 2.2). ▶ “Voltage Range (Voltage)” in the features guide</p> <p>Set the current range (see section 2.2). ▶ “Current Range (Current)” in the features guide</p> <p>Configure the current sensor (see section 2.2). ▶ “Current Measurement Terminal (Terminal)” in the features guide</p> <p>Configure the external current sensor (see section 2.3). ▶ “External Current Sensor On/Off (Ext Sensor)” in the features guide</p> <p>Set the voltage transformer (VT) and current transformer (CT) ratios (see section 2.4). ▶ “Scaling (Scaling)” in the features guide</p> <p>Configure the line filter and frequency filter settings (see section 2.7). ▶ “Line Filter (Line Filter)” in the features guide</p> <p>Configure the line filter and frequency filter settings (see section 2.7). ▶ “Frequency Filter (Freq Filter)” in the features guide</p> <p>Set the sync source (see section 2.8). ▶ “Measurement Period (Sync Source)” in the features guide</p>	<p>Element 6 CS</p> <p>Wiring 1P2W</p> <p>Voltage Range 1000V</p> <p>Current Range 1A</p> <p>CT Preset Custom</p> <p>Scaling ON</p> <p>VT Ratio 1.0000</p> <p>CT Ratio 1.0000</p> <p>SF Ratio 1.0000</p> <p>Line Filter ON</p> <p>Cutoff 0.5kHz</p> <p>Freq Filter ON</p> <p>Cutoff 0.1kHz</p> <p>Sync Source</p>
---	---	---

Note

You can also edit the settings by moving the cursor on each setting button using the arrow keys and then pressing SET.

Input Settings (Advanced) Overview (Input (Advanced/Options))

1. Tap the **Setup** icon  or press **MENU** under SETUP.
2. Tap the **Input (Advanced/Options)** tab. An input settings (advanced/options) overview screen appears.
Pressing **ESC** closes the overview screen.

Advanced Wiring System Settings (Wiring) ▶ section 2.1

3. Tap **Wiring**. An advanced wiring system setup screen appears.

Wiring button **Input (Advanced/Options) tab**

The display showing the wiring diagram and wiring units changes depending on the specified wiring system.

When the input element is 760901 or 760902 When the input element is 760903

Common Measurement Range Settings (Range)

▶ sections 2.1, 2.3, 2.9

3. Tap **Range**. A setup screen appears for common measurement range items.

Range button **Input (Advanced/Options) tab**

Crest factor (see section 2.9)
Crest Factor: CF3

Range Σ link (see section 2.1)
Range Σ Link: ∞ OFF

Current Range Display Format: Direct

Current range display format (see section 2.3)

Measurement Range Configuration Settings (Range Config)

▶ section 2.5

3. Tap **Range Config**. A measurement range configuration setup screen appears.

Range config button **Input (Advanced/Options) tab**

Switches between voltage and current

Wiring: ΣA 3P3W ΣB 1P3W

Range: Element 1 30A, Element 2 30A, Element 3 30A, Element 4 5A, Element 5 5A, Element 6 CS, Element 7 CS

Currently specified valid measurement ranges

Element	1	2	3	4	5	6	7
1000V	1000V	1000V	1000V	1000V	1000V	1000V	1000V
600V	600V	600V	600V	600V	600V	600V	600V
300V	300V	300V	300V	300V	300V	300V	300V
150V	150V	150V	150V	150V	150V	150V	150V
100V	100V	100V	100V	100V	100V	100V	100V
60V	60V	60V	60V	60V	60V	60V	60V
30V	30V	30V	30V	30V	30V	30V	30V
15V	15V	15V	15V	15V	15V	15V	15V
10V	10V	10V	10V	10V	10V	10V	10V
3V	3V	3V	3V	3V	3V	3V	3V
1.5V	1.5V	1.5V	1.5V	1.5V	1.5V	1.5V	1.5V

Valid Measurement Range

Button for displaying the valid measurement range setup screen

Specify the measurement range to switch to when a peak over-range occurs.

Peak Over Jump: OFF, OFF, 300V, OFF, OFF, OFF, OFF

The background of the specified measurement range to switch to when a peak over-range occurs (Peak Over Jump) is displayed in blue.

Measurement ranges that are not valid appear dimmed.

Line Filter Settings (Line Filter) ▶ section 2.7

3. Tap **Line Filter**. A line filter setup screen appears. The following screen is an example when Advanced Settings are on. You can set the HFR, AAF, DLF (N) and DLF (H) filters separately.

Line Filter button **Input (Advanced/Options) tab**

Turns the advanced line filter settings on and off

Line Filter Advanced Settings: ON

Filter type: Line Filter Type: Butterworth

	HFR	AAF	DLF(N)	DLF(H)
All	HF Rejection	Anti-Aliasing Filter (1MHz/Bessel)	Digital Line Filter (Normal)	Digital Line Filter (Harmonics)
Element 1	-	ON	ON	0.5kHz
Element 2	-	ON	ON	0.5kHz
Element 3	-	ON	ON	0.5kHz
Element 4	-	ON	ON	0.5kHz
Element 5	-	ON	ON	0.5kHz
Element 6	ON	ON	ON	0.5kHz
Element 7	ON	ON	ON	0.5kHz

HF Rejection Anti-aliasing filter Digital line filter (for normal measurement) Digital line filter (for harmonic measurement)

Frequency Filter, Rectifier, and Cross Level Settings (Freq Filter/Rectifier/Level) ▶ sections 2.7, 2.8

3. Tap Freq Filter/Rectifier/Level. A frequency filter setup screen appears.

Frequency Measurement Filter Settings for the Sync Source (Voltage/Current Signal) (Sync Source/Freq Measurement)

The following screen is an example when Freq Filter Advanced Settings are on. You can set the HPF, Rectifier, LPF, and Level separately.

Freq Filter/Rectifier/Level button **Input (Advanced/Options) tab**

Line Filter	All	HPF		Rectifier		LPF		Level	
		Freq Filter	Cutoff	Voltage	Current	Freq Filter	Cutoff	Voltage	Current
ΣA	Element 1	ON	0.1Hz	ON	ON	ON	0.1kHz	0.0%	0.0%
	Element 2	ON	0.1Hz	ON	ON	ON	0.1kHz	0.0%	0.0%
	Element 3	ON	0.1Hz	ON	ON	ON	0.1kHz	0.0%	0.0%
ΣB	Element 4	ON	0.1Hz	ON	ON	ON	0.1kHz	0.0%	0.0%
	Element 5	ON	0.1Hz	ON	ON	ON	0.1kHz	0.0%	0.0%
	Element 6	ON	0.1Hz	ON	ON	ON	0.1kHz	0.0%	0.0%
	Element 7	ON	0.1Hz	ON	ON	ON	0.1kHz	0.0%	0.0%

Frequency filter (HPF)
Voltage/current signal rectifier
Frequency filter (LPF)
Cross level

Second Frequency Measurement Filter Settings (Freq2 Measurement)

Freq Filter/Rectifier/Level button **Freq2 Measurement button**

Line Filter	All	HPF		Level	
		Freq Filter (Freq2)	Cutoff	Voltage Level (Freq2)	Current Level (Freq2)
ΣA	Element 1	ON	0.1Hz	0.0%	0.0%
	Element 2	ON	0.1Hz	0.0%	0.0%
	Element 3	ON	0.1Hz	0.0%	0.0%
ΣB	Element 4	OFF	0.1Hz	0.0%	0.0%
	Element 5	OFF	0.1Hz	0.0%	0.0%
	Element 6	OFF	0.1Hz	0.0%	0.0%
	Element 7	OFF	0.1Hz	0.0%	0.0%

Second frequency filter (HPF)
Cross level of the second voltage/current frequency

Null Feature Settings (Null) ▶ section 11.1

3. Tap **Null**. A null feature setup screen appears.

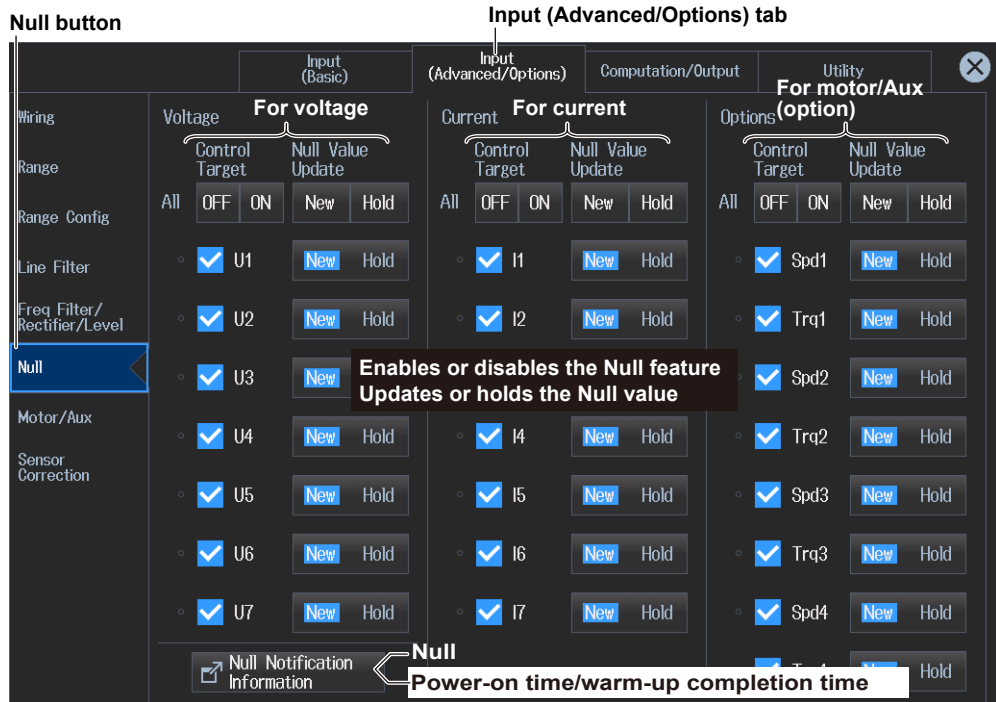

Motor Evaluation and Auxiliary Input Settings (Motor/Aux) ▶ section 9.1

3. Tap **Motor/Aux**. A Motor/Aux screen (MTR1/MTR2) appears.
The following screen is an example for a model with both the /MTR1 and /MTR2 options.

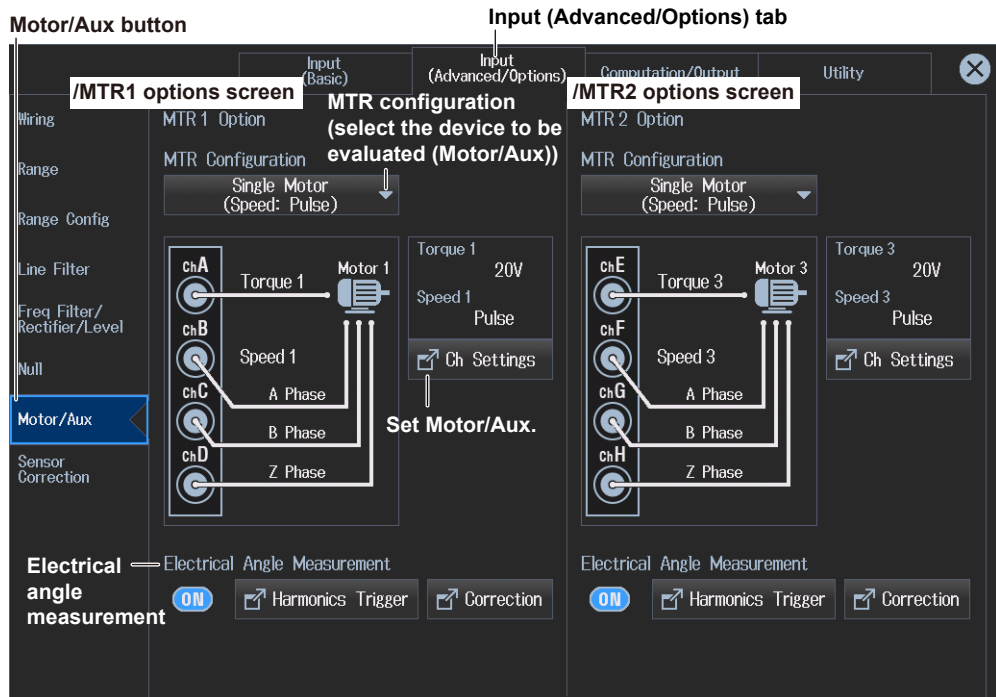

Sensor Correction Settings (Sensor Correction) ▶ section 2.6

3. Tap **Sensor Correction**. A sensor correction screen appears.

Sensor Correction button **Input (Advanced/Options) tab**

		Input (Basic)	Input (Advanced/Options)	Computation/Output	Utility				
Current amplitude correction		All	Element 1 30A	Element 2 30A	Element 3 30A	Element 4 5A	Element 5 5A	Element 6 CS	Element 7 CS
Range	Current Amplitude Correction		ON	OFF	ON	OFF	OFF	ON	OFF
Range Config	Correction Ratio		1.000000	1.000000	1.000000	1.000000	1.000000	1.000000	1.000000
Line Filter	Current Phase Correction		ON	ON	OFF	OFF	OFF	ON	OFF
Freq Filter/Rectifier/Level	Frequency		60 Hz	60 Hz	60 Hz	60 Hz	60 Hz	60 Hz	60 Hz
Null	Phase Difference Between I/O		0.000°	0.000°	0.000°	0.000°	0.000°	0.000°	0.000°
Motor/Aux	Time Difference Between I/O		0.000s	0.000s	0.000s	0.000s	0.000s	0.000s	0.000s
Sensor Correction									
Current phase correction									

1.3 Computation and Output Settings Overview

The overview screen shows in a table the various settings related to the input signal computing method, harmonic measurement, integration conditions, numeric and graphic screen displays, data saving, DA output, and so on. You can control all the settings from this overview screen.

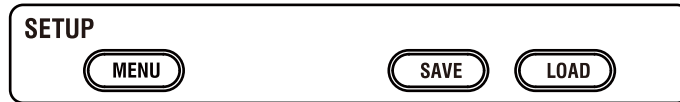

Computation and Output Settings Overview (Computation/Output)

1. Tap the **Setup** icon , or press **MENU** under SETUP.
2. Tap **Computation/Output** tab. A computation and output settings overview screen appears. Pressing **ESC** closes the overview screen.

Setting the Efficiency Equation (Efficiency) ▶ [section 2.11](#)

3. Tap **Efficiency**. An efficiency equation setup screen appears.

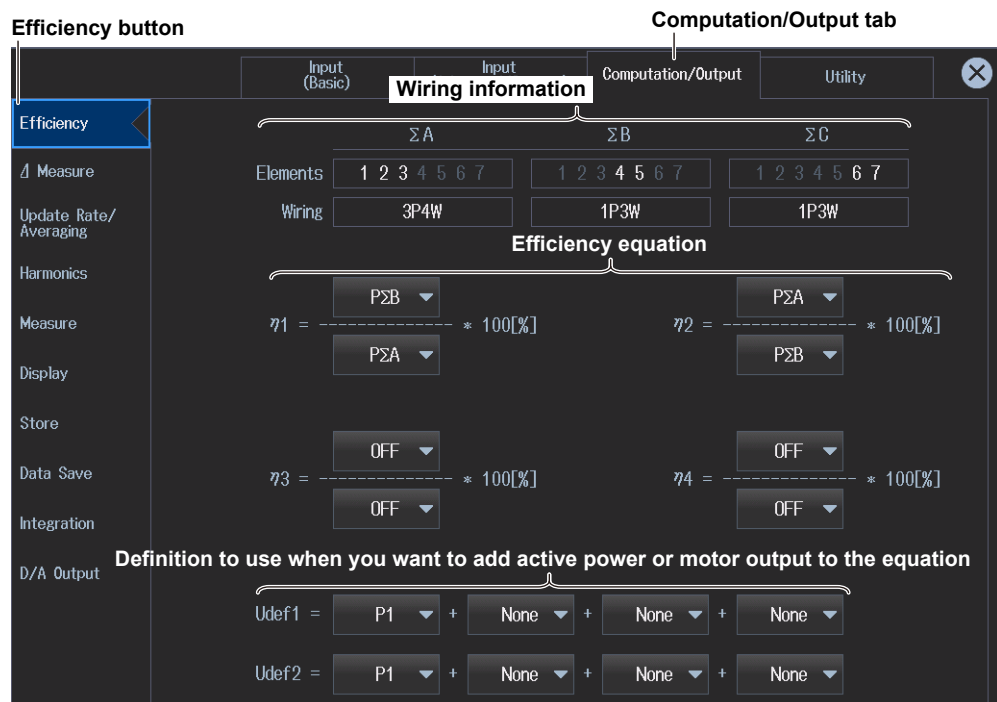

1.3 Computation and Output Settings Overview

Note

- You can also display the input settings overview screen by moving the cursor on the Computation/Output tab using the arrow keys and then pressing SET.
- You can also display the setup menu screen from the navigation window that appears immediately after power-on.

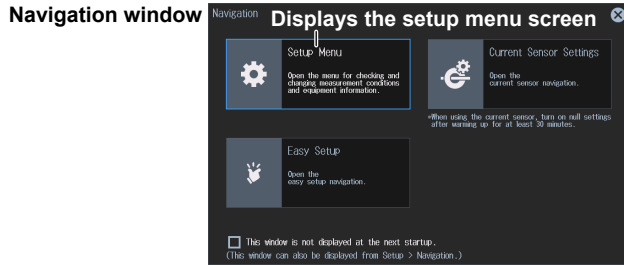

Setting the Delta Computation (Δ Measure) ▶ section 2.12

3. Tap Δ Measure. A delta computation setup screen appears.

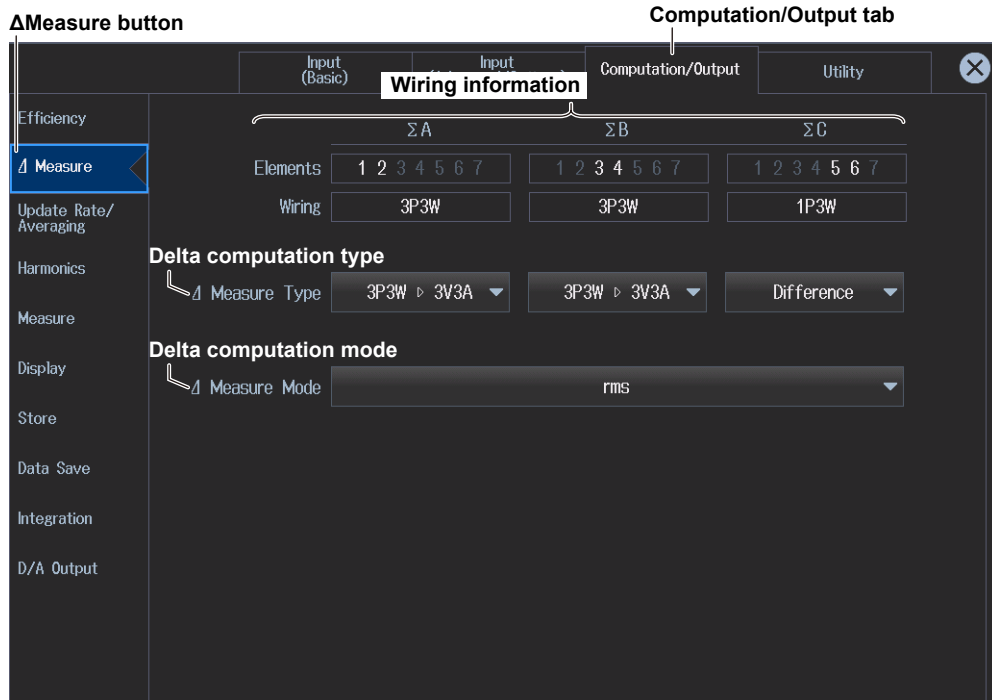

Setting the Data Update Interval and Averaging (Update Rate/Averaging) ▶ sections 2.10, 2.13

3. Tap **Update Rate/Averaging**. A data update interval/averaging setup screen appears.

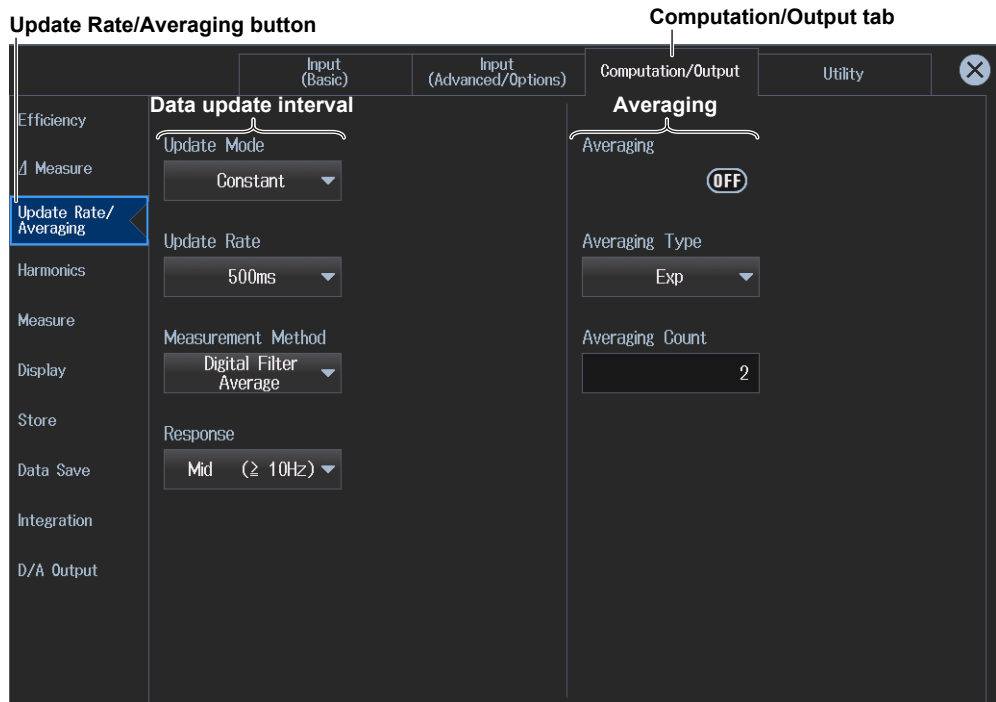

Setting the Harmonic Measurement (Harmonics) ▶ section 5.1

3. Tap **Harmonics**. A harmonic measurement setup screen appears.

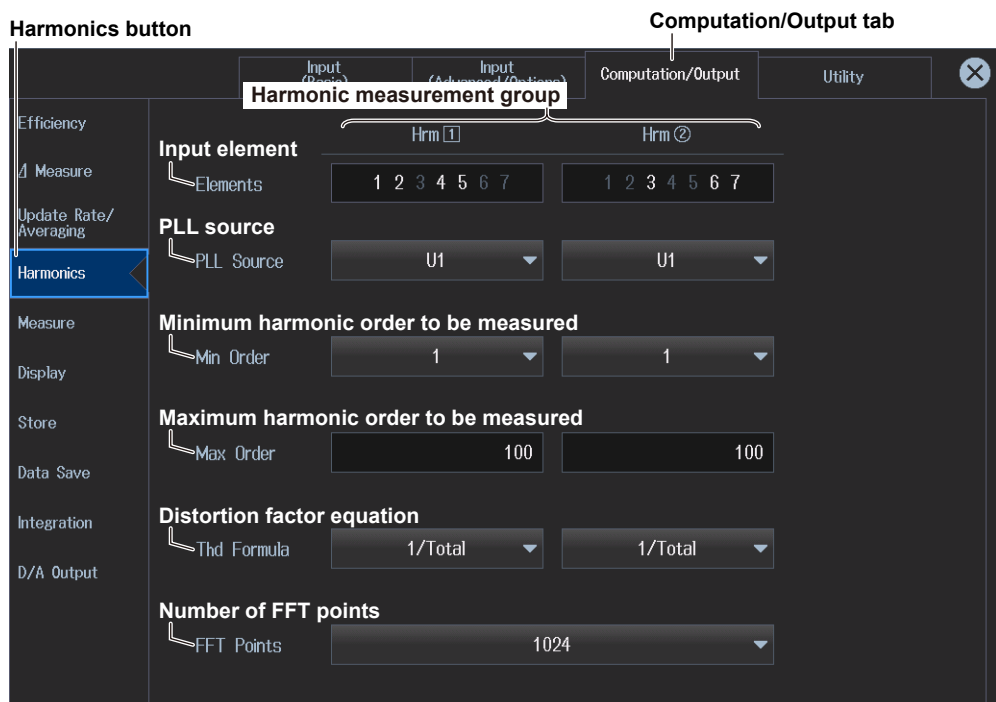

Setting the measurement (Measure) ▶ sections 2.14, 3.3, 3.4, 3.5

3. Tap **Measure**. A setup screen appears for the user-defined functions, apparent power formula, master/slave, and phase difference.

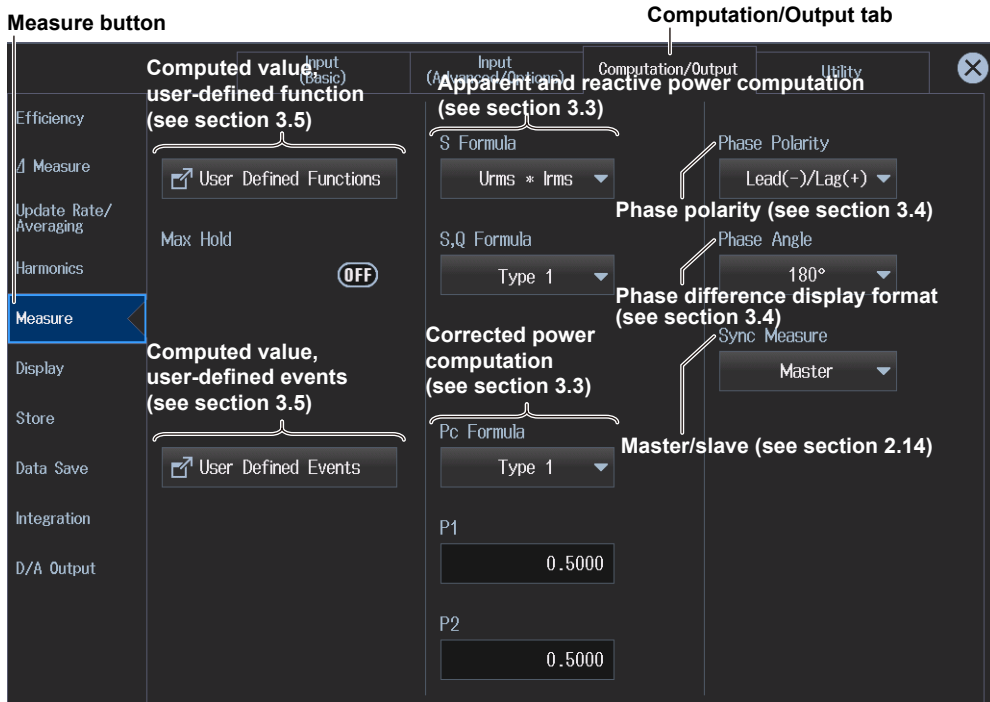

Configuring the Numeric, Custom, and Graphic Displays (Display) ▶ sections 3.1, 3.8, 6.1

3. Tap **Display**. A setup screen appears for the screen display format.

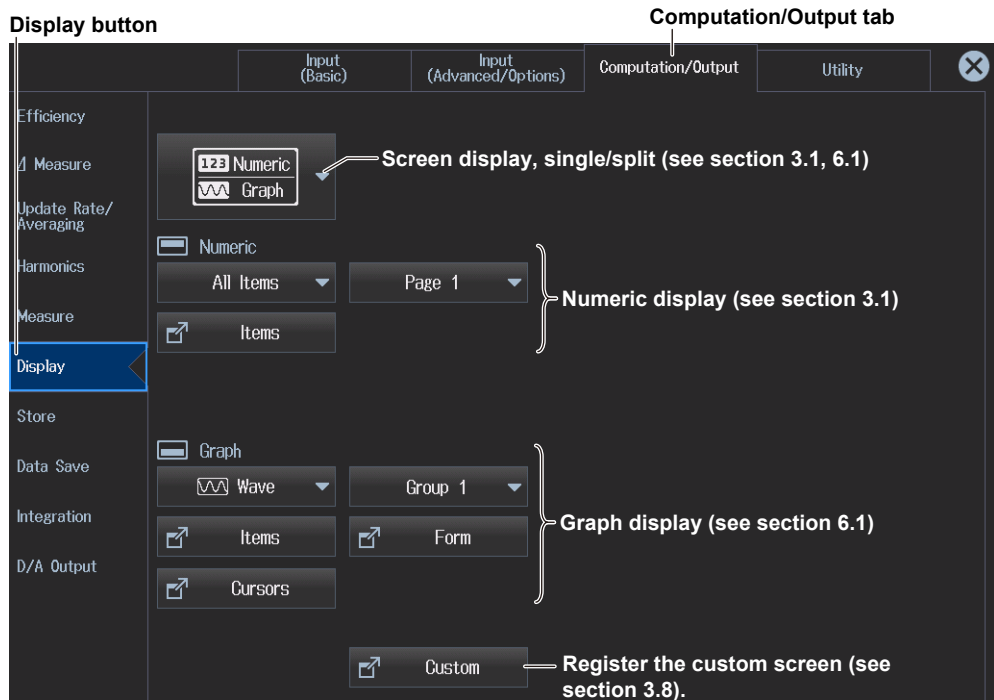

Configuring the Storage (Store) ► section 7.1, 7.2, 7.3

3. Tap **Store**. A storage setup screen appears.

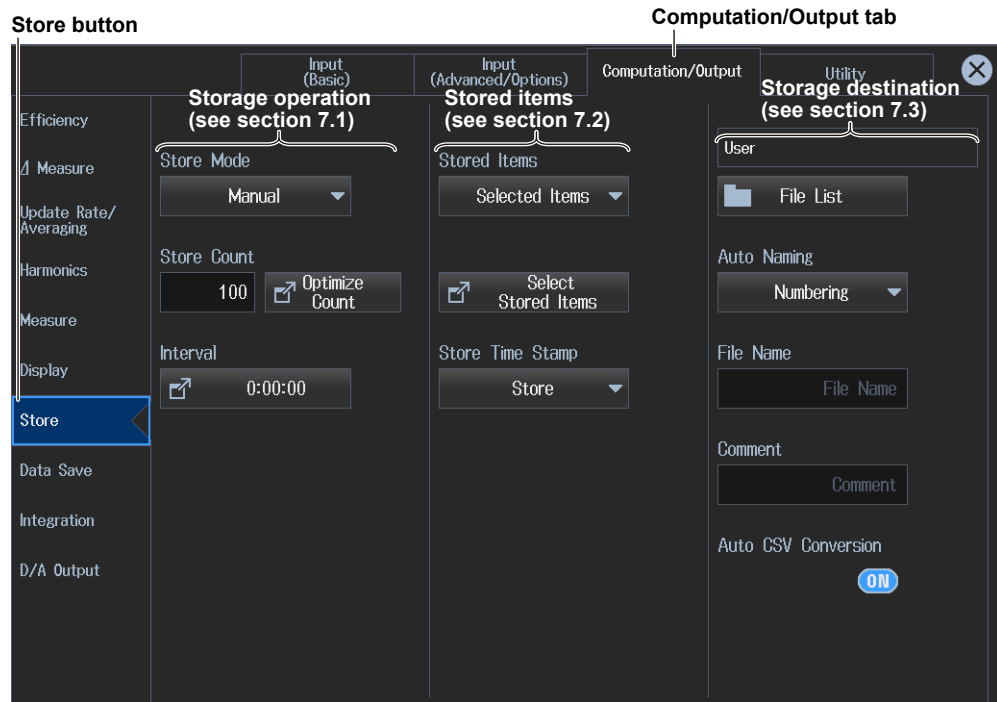

Configuring the Data Save Feature (Data Save)

► section 8.2, 8.3, 8.4, 8.5

3. Tap **Data Save**. A data save setup screen appears.

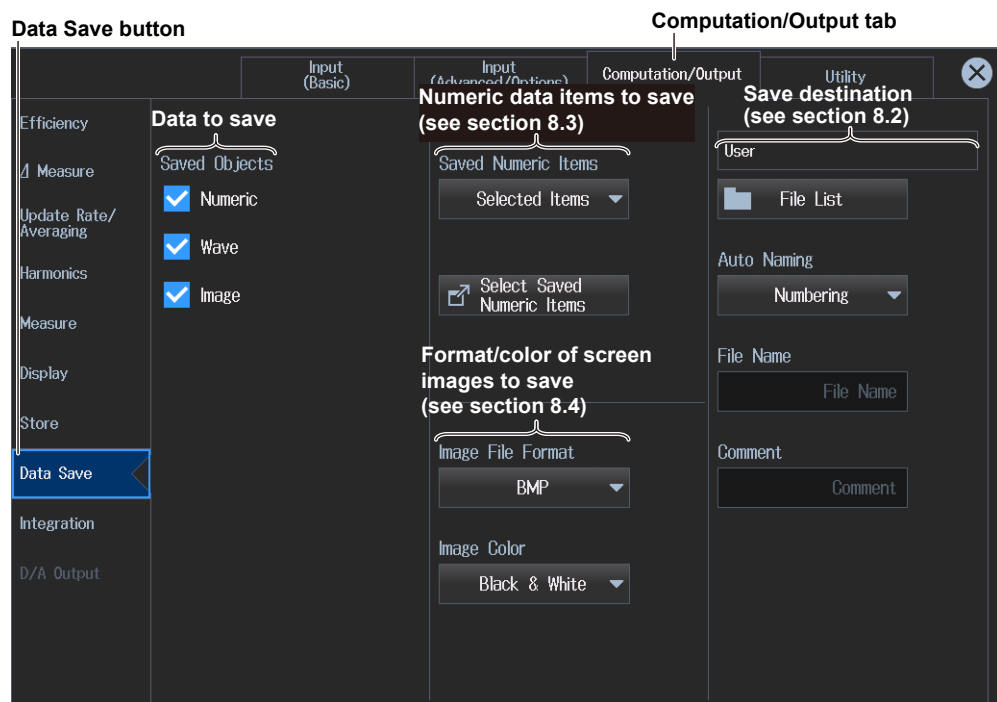

Setting the Integration Conditions (Integration) ▶ section 4.1

3. Tap **Integration**. An integration condition setup screen appears.

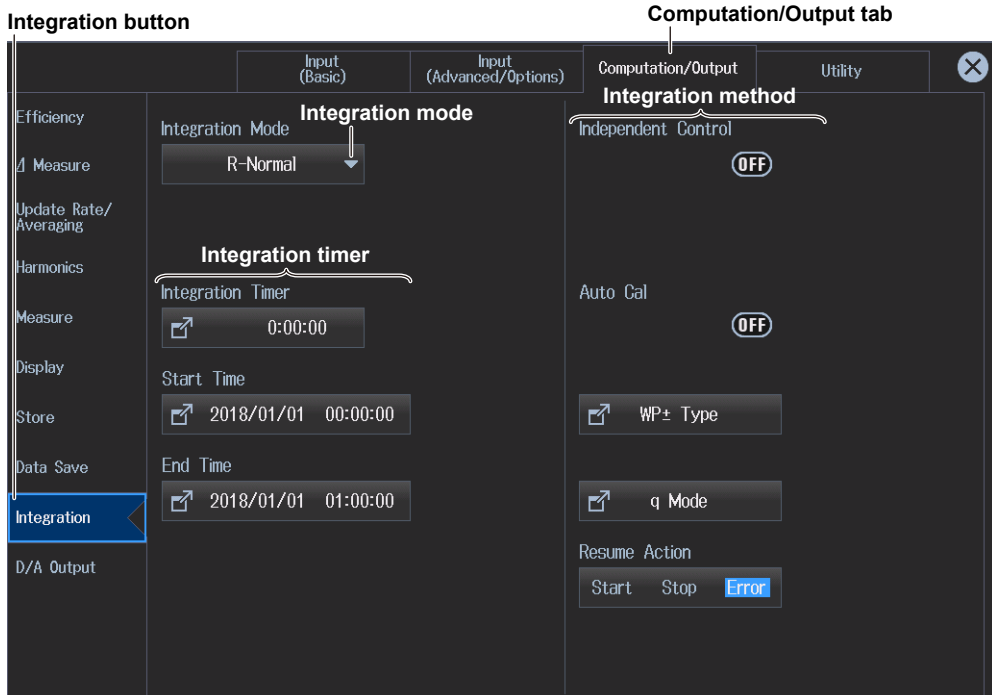

Configuring the D/A Output (D/A Output) ▶ section 16.2

3. Tap **D/A Output**. A D/A output setup screen appears.

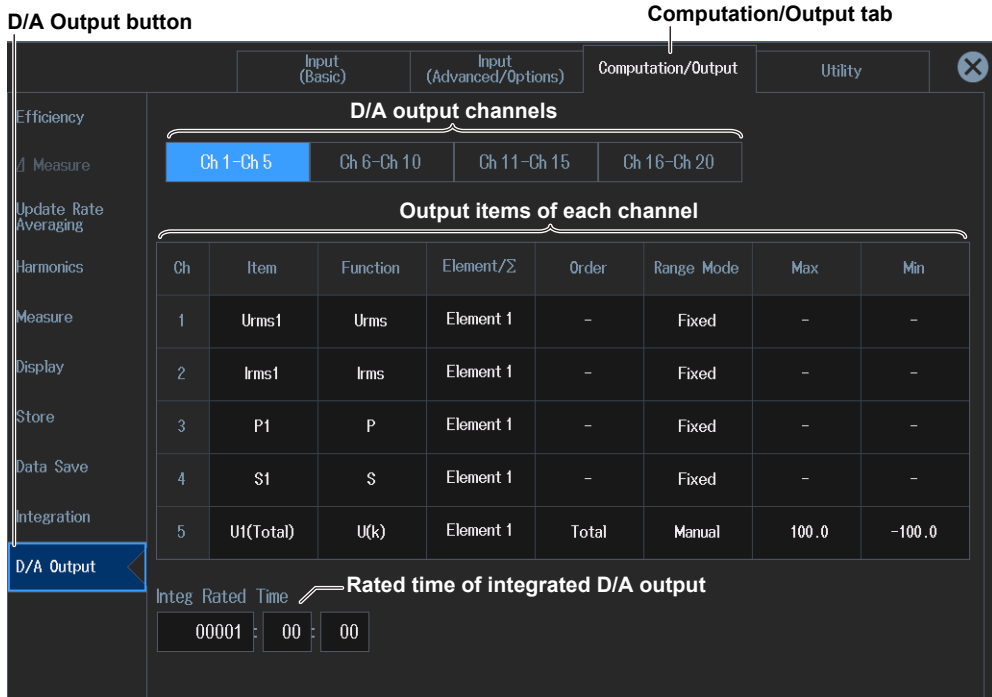

1.4 Utility Settings Overview

The system settings of this instrument are displayed in table format. You can control all the settings from this overview screen.

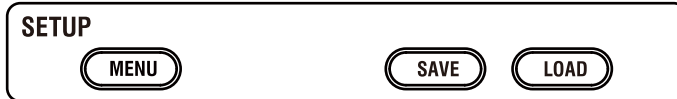

Utility Settings Overview (Utility)

1. Tap the **Setup** icon , or press **MENU** under SETUP.
2. Tap the **Utility** tab. The utility settings overview screen appears. Pressing **ESC** closes the overview screen.

System Configuration (System Configuration)

▶ [section 16.3](#), [16.4](#), [16.5](#), [16.6](#)

3. Tap **System Configuration**. A system settings overview appears.

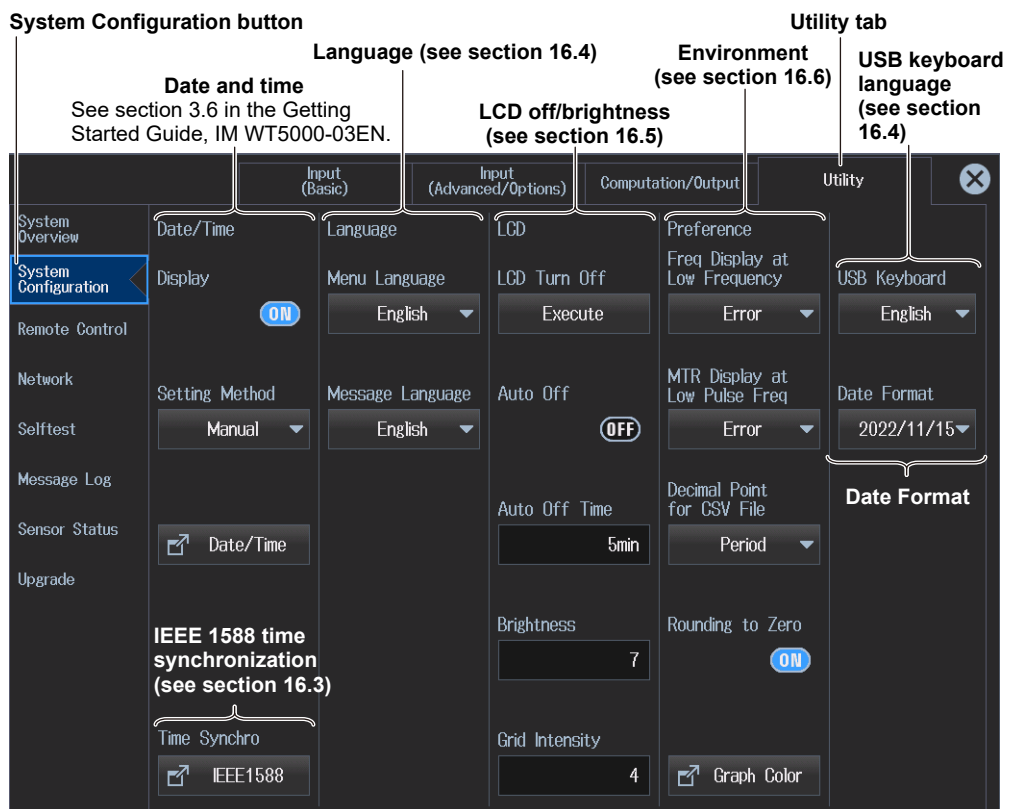

1.4 Utility Settings Overview

Note

- You can also display the input settings overview screen by moving the cursor on the Utility tab using the arrow keys and then pressing SET.
- You can also display the setup menu screen from the navigation window that appears immediately after power-on.

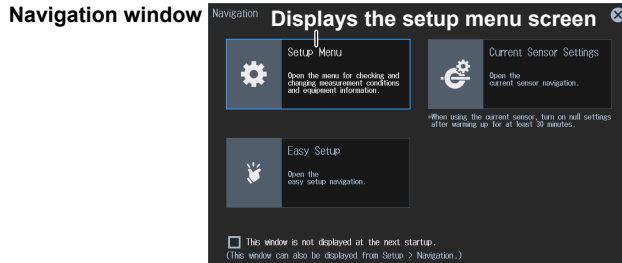

Remote Control Settings (Remote Control) ▶ section 16.1

3. Tap Remote Control.

A remote control setup screen (Network(VXI-11/GP-IB/USB(USB-TMC)) appears.

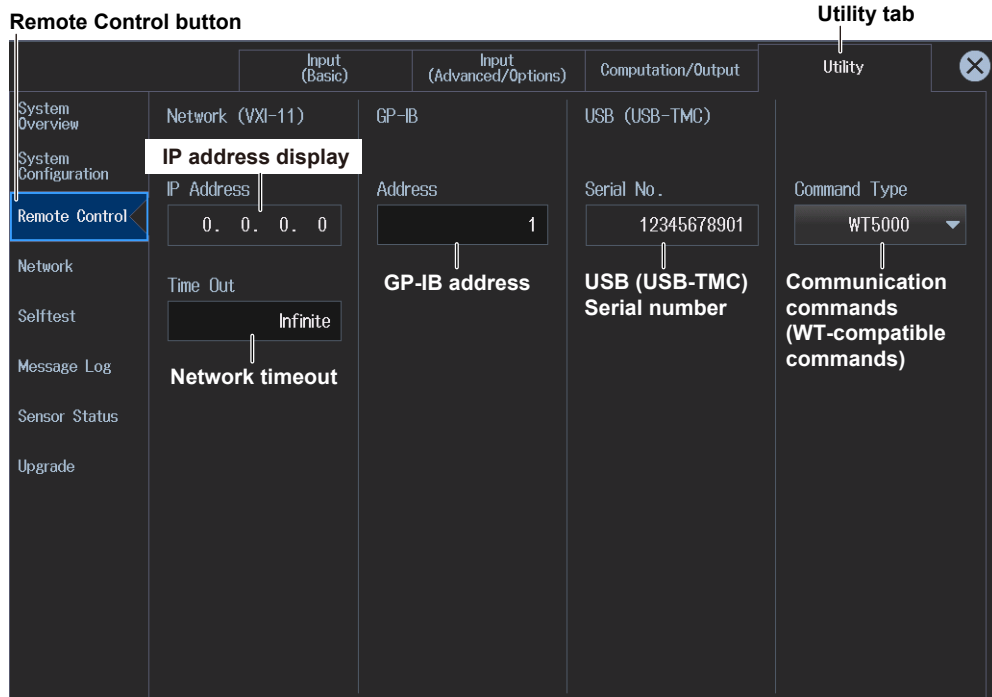

Ethernet Communication Settings (Network)

▶ section 15.2, 15.3, 15.4, 15.5, 15.6

3. Tap **Network**. A network setup screen appears.

- **TCP/IP Settings** (see section 15.2)

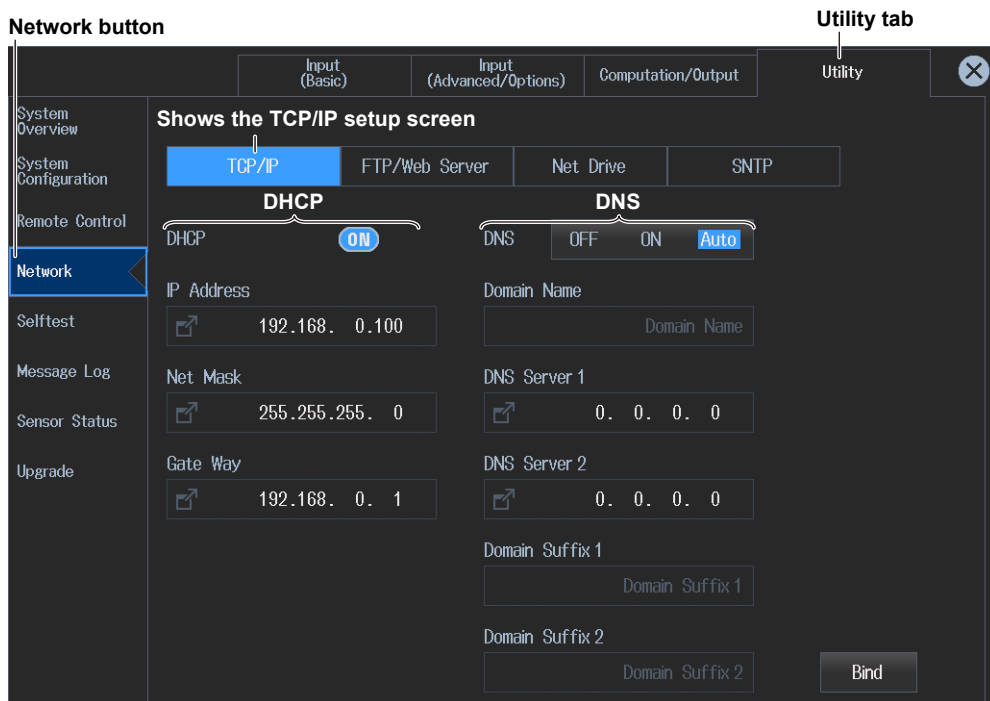

- **FTP Server Settings** (see section 15.3), **Web Server Settings** (see section 15.4)

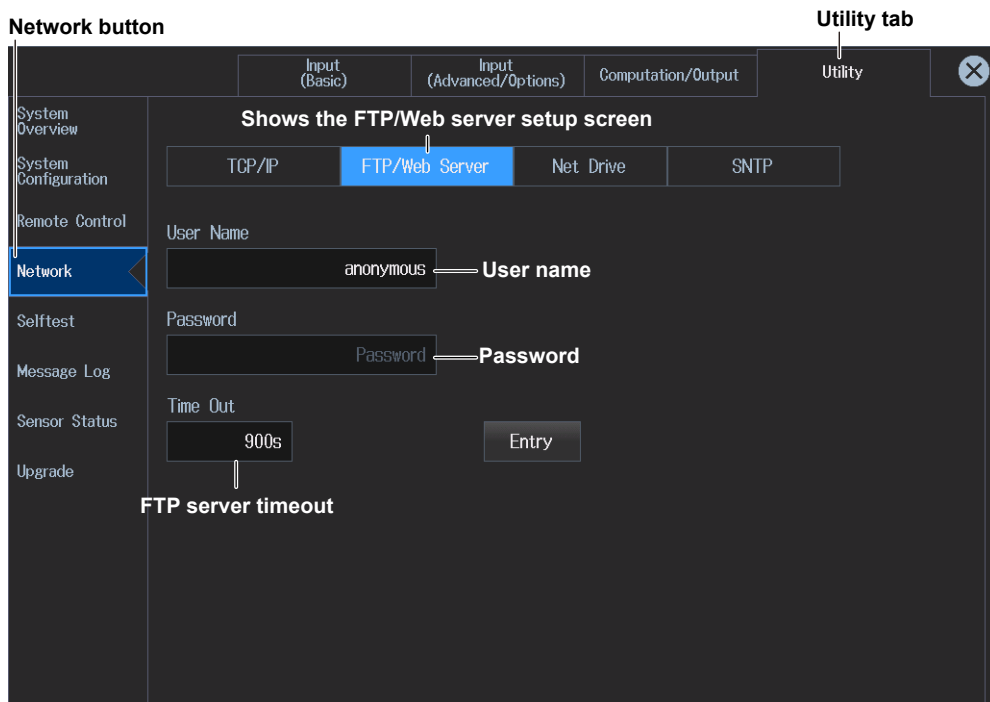

1.4 Utility Settings Overview

- Network Drive Settings (see section 15.5)

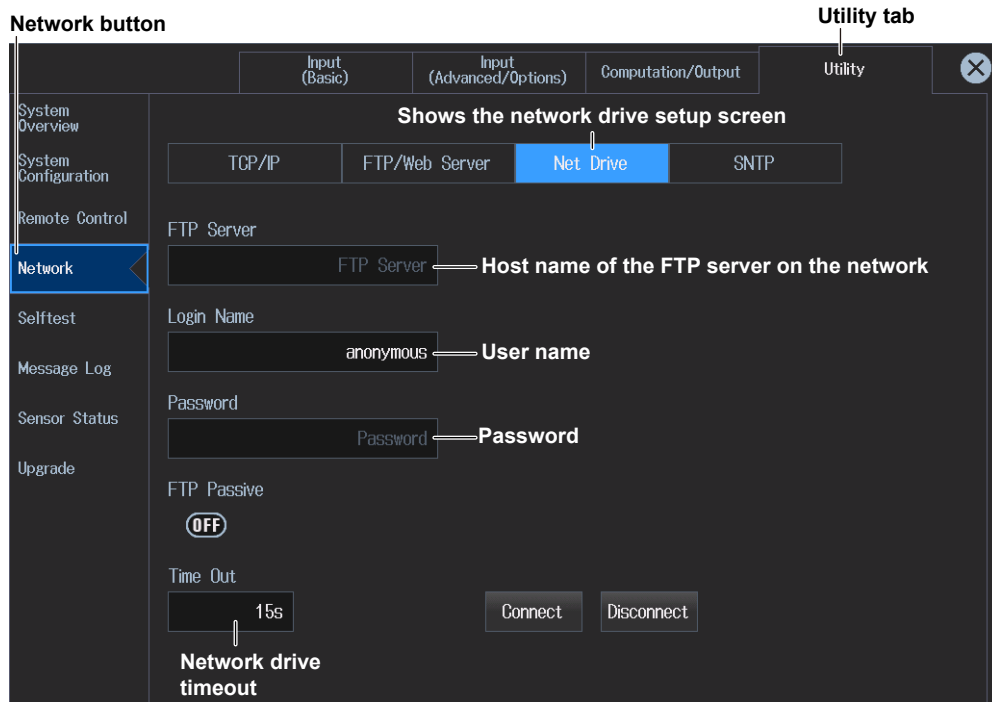

- SNTP (date and time) settings (see section 15.6)

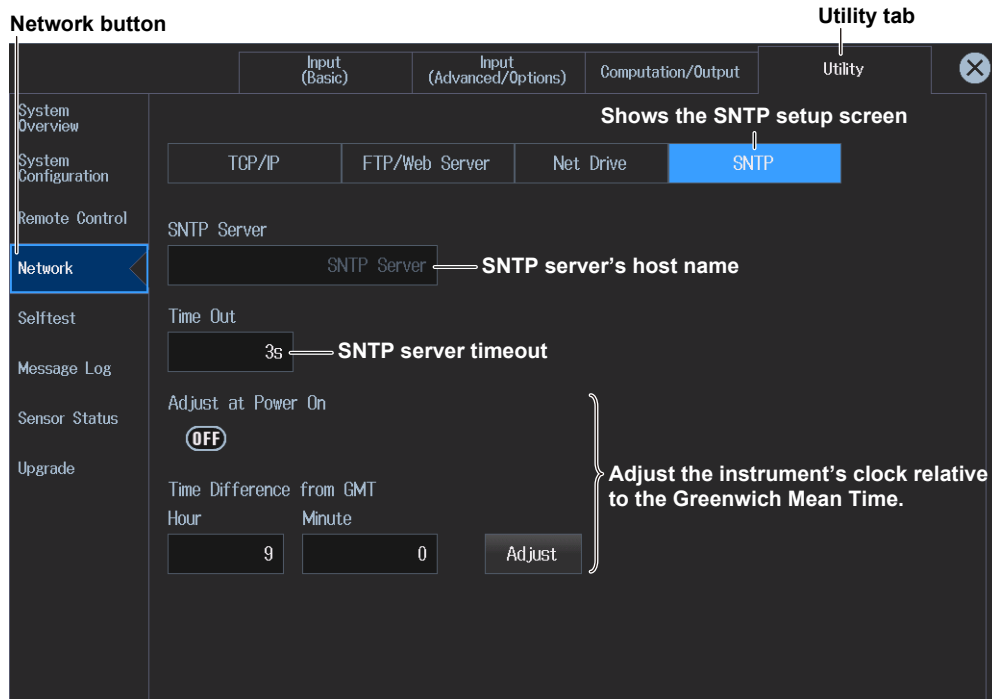

Self-test (Selftest) ▶ section 16.7

3. Tap **Selftest**. A self-test setup screen appears.

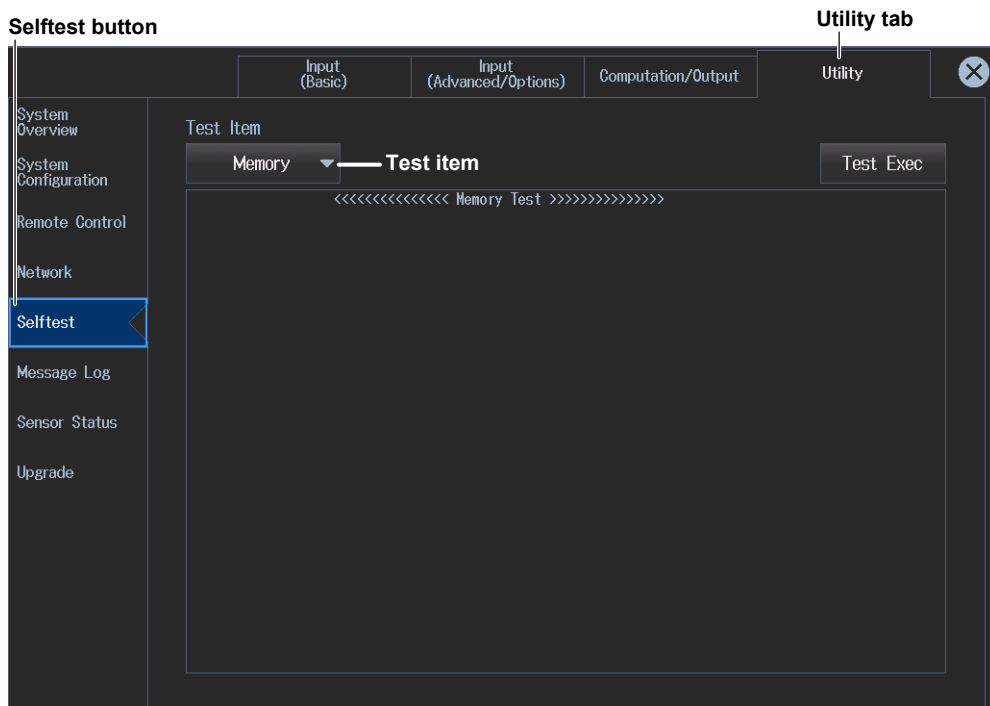

Message Log Display(Message Log) ▶ section 16.8

3. Tap **Message Log**. A message log screen appears.

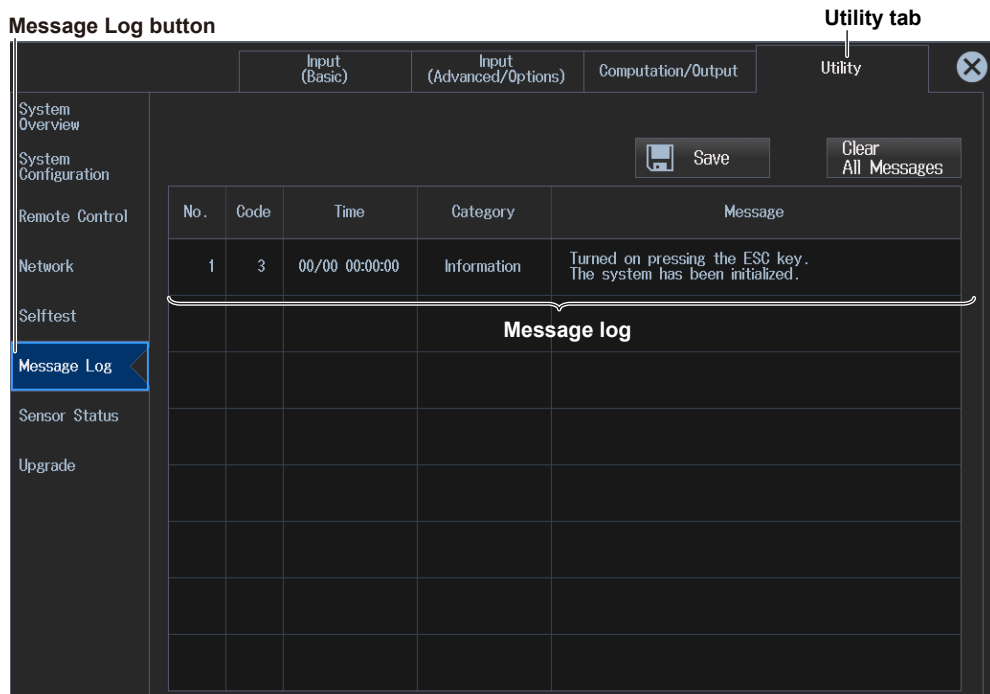

System Overview and Upgrade (System Overview/Upgrade)

▶ section 16.9

- Tap **System Overview** to display a table of instrument information.
Tap Upgrade to display the Upgrade screen.

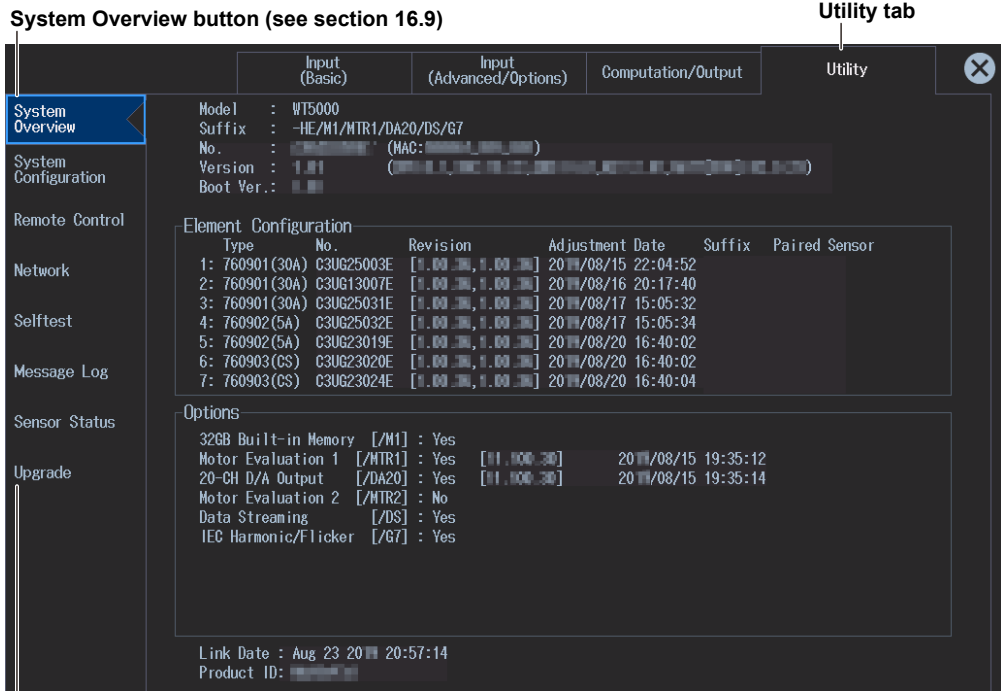

Upgrade button

Current Sensor Status Display (Sensor Status) ▶ section 16.9

- Tap **Sensor Status**. The current sensor statuses are listed.

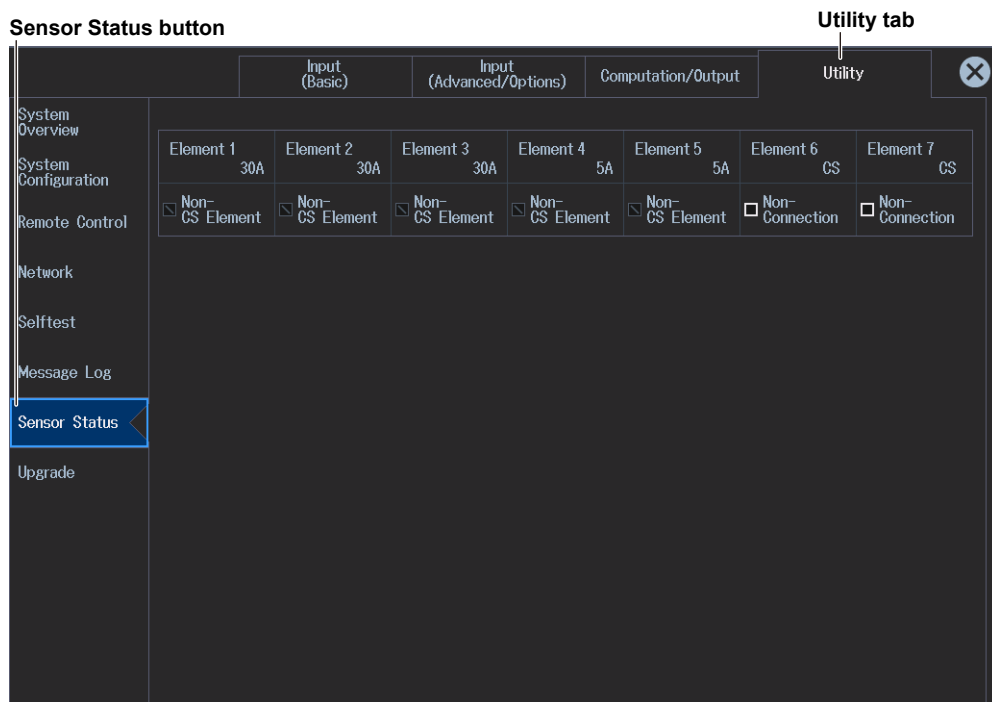

1.5 Saving, Loading, and Initializing Setup Data

- ▶ “Saving Setup Data (Save Setup)” in the features guide
- ▶ “Loading Setup Data (Load Setup)” in the features guide
- ▶ “Initialize Settings (Initialize Settings)” in the features guide

You can load, save, and initialize the system settings of this instrument.



Saving, Loading, and Initializing Setup Data (Save Setup/Load Setup/Initialize Settings)

1. Tap the **Setup** icon , or press **MENU** under **SETUP**. The setup menu screen appears.

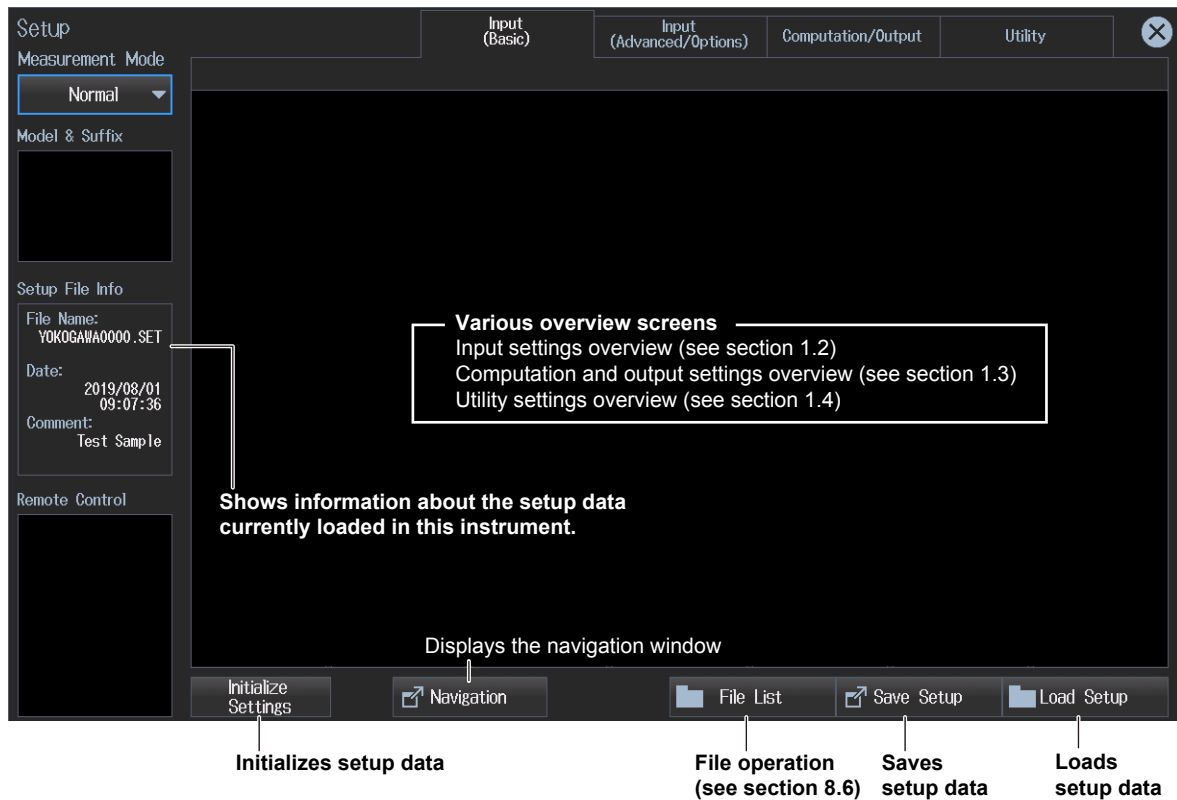

Note

You can also display the setup menu screen from the navigation window that appears immediately after power-on.

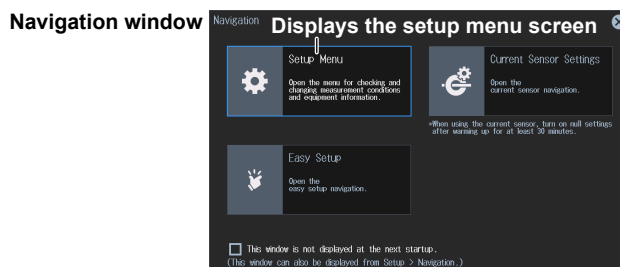

Saving Setup Data

2. Tap **Save Setup**. A Save Setup screen appears.
Pressing **ESC** closes the Save Setup screen.

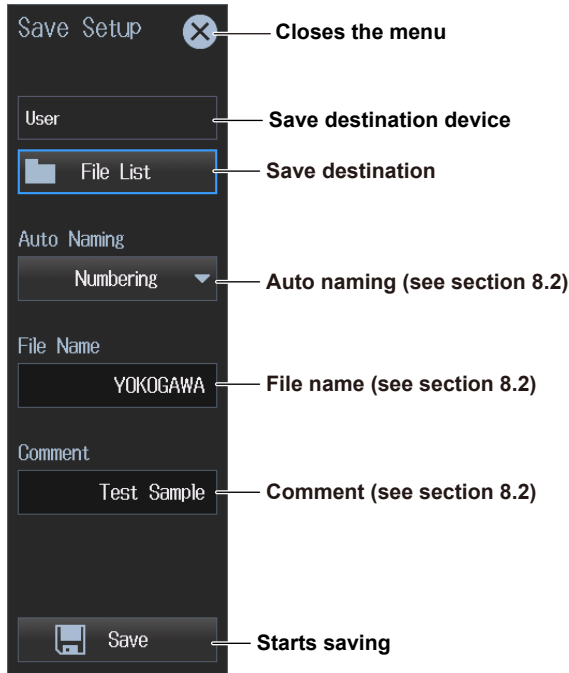

Setting the Save Destination

3. Tap **File List**. A file list appears.
Pressing **ESC** closes the file list.
4. Select the save destination from the file list.
5. Tap **Save**. The setup data is saved in the save destination folder.

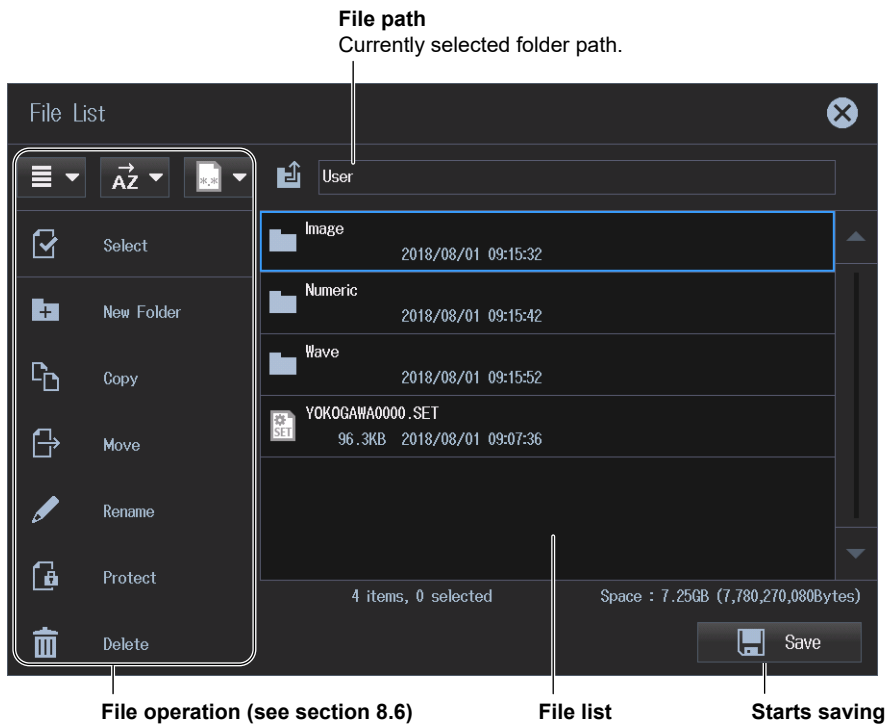

Loading Setup Data

2. Tap **Load Setup**. A file list appears.
Pressing **ESC** closes the file list.
3. Select the setup data you want to load from the file list. The extension for setup data is **.set**.
4. Tap **Load**. The setup data is loaded into the instrument.

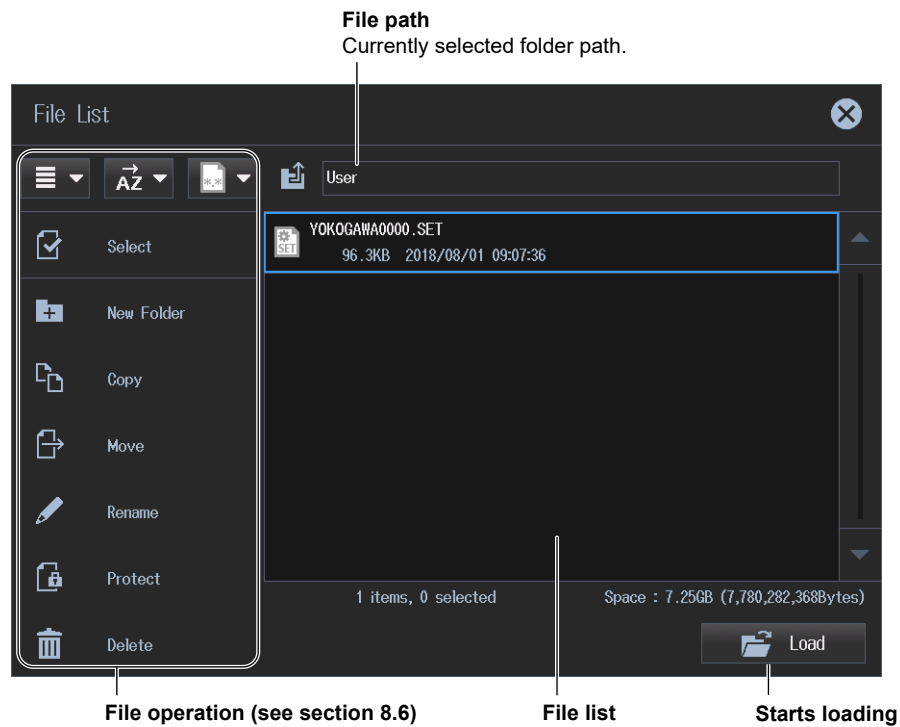

Initializing the Setup Data

2. Tap **Initialize Settings**. A confirmation screen appears for executing the initialization.
3. Tap **OK**. The setup data of this instrument will be initialized.

1.6 Current Sensor Setup Menu

► “Current Sensor Menu (Current Sensor Settings)” in the features guide

This section explains how to display only the current sensor settings and how to use the menu screen for specifying the settings.

Displaying the Current Sensor Setup Menu

You can display the current sensor setup menu by performing the following procedure.

At Instrument Startup

1. On the navigation window that appears when the instrument starts, tap **Current Sensor Settings**. The current sensor setup menu screen appears.

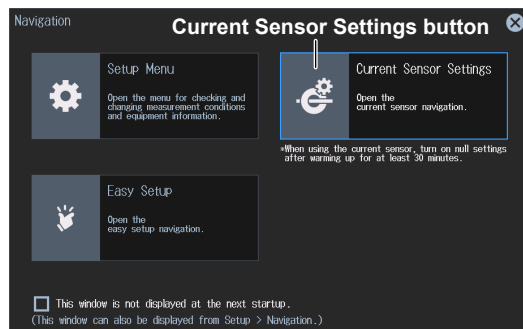

From the Setup Menu after Instrument Startup

1. Tap the **Setup** icon (), or press **MENU** under **SETUP**. The setup menu screen appears.
2. Tap **Navigation** at the bottom of the setup menu screen. A navigation window appears.



Navigation button

3. Tap **Current Sensor Settings**. The current sensor setup menu screen appears.

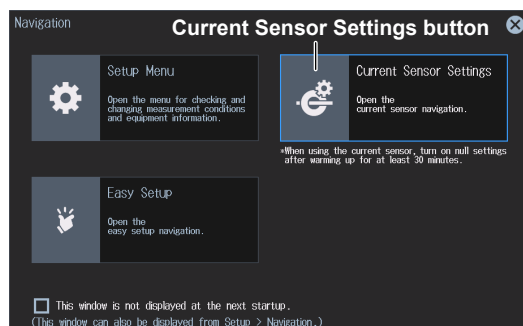

Configuring the Current Sensor

► [section 2.1](#), [2.2](#), [2.3](#), [2.5](#), [2.6](#), [2.9](#)

1. Tap **Start Setup** on the current sensor setup menu screen. The button changes to “View Settings”, and a screen appears for setting the Terminal/CT Sensor items. Tapping **View Settings**, which changed from the Start Setup button, causes the screen to return to the first setup menu screen.

Start Setup button

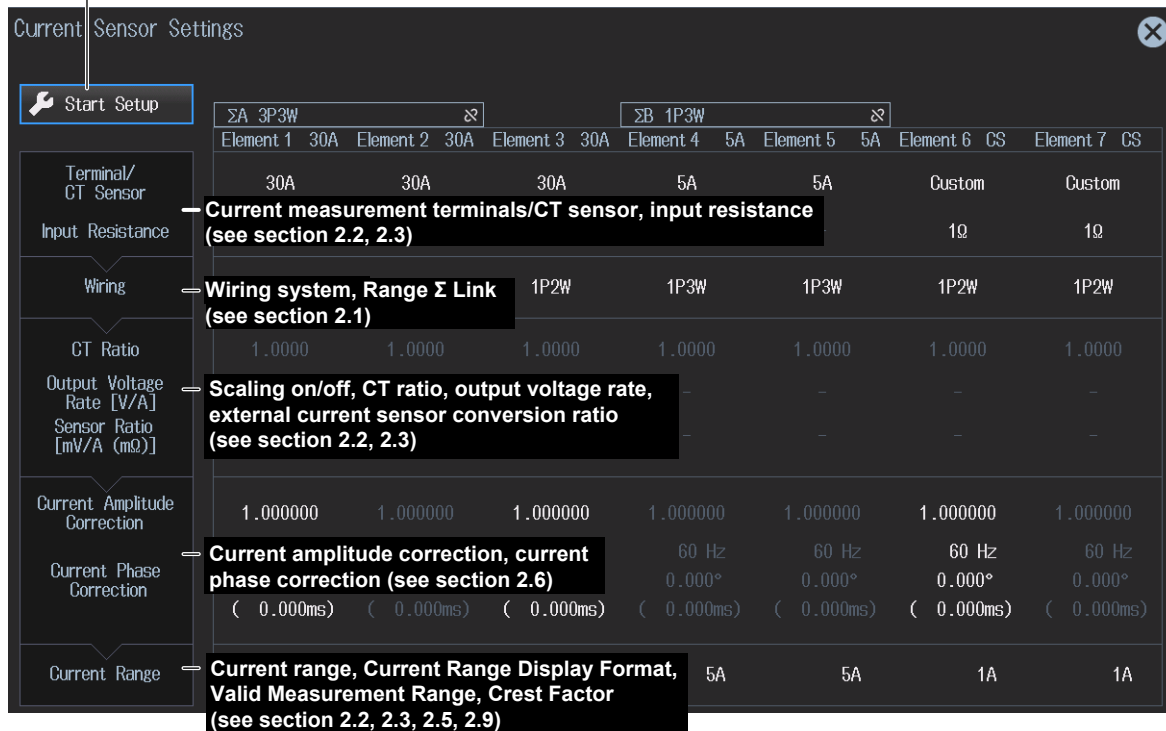

For details on the individual settings, see the respective references.

2. Tap **Next** or **Back** that appears at the bottom of the Terminal/CT Sensor and subsequent setup screens. The screen will switch to the next setup screen or previous setup screen.

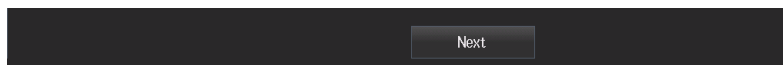

You can also tap each setting (Terminal/CT Sensor, Wiring, CT Ratio, etc.) to switch to the corresponding setup screen.

3. On the screen that you switched to, set the items.
4. Tap **Close** at the bottom of the Current Range setup screen to switch from the current sensor setup menu screen to the measurement result display screen. To display the first screen of the current sensor setup menu again, perform steps 1 to 3 on the previous page.



1.7 Easy Setup Menu

▶ “Easy Setup Menu” in the features guide

This section describes the operation of the Easy Setup menu screen, which can be used to easily set up this instrument by selecting the wiring method and measurement scene.

Displaying the Easy Setup Menu

You can display the Easy Setup menu by performing the following procedure.

At Instrument Startup

1. On the navigation window that appears when the instrument starts, tap **Easy Setup**.

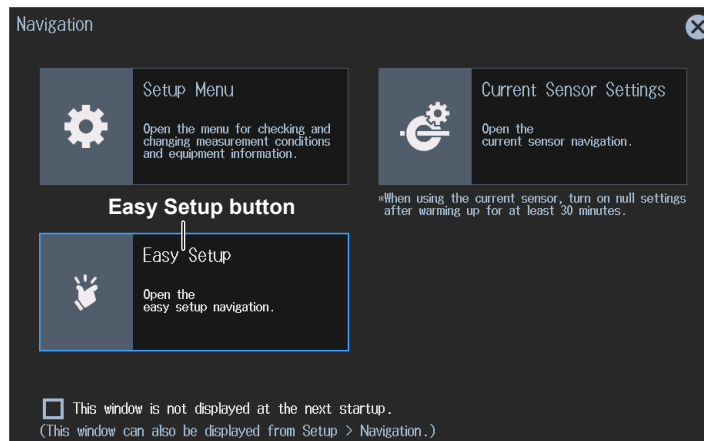

When the measurement mode is other than Normal (Normal), a confirmation screen will appear asking if you want to change to Normal (Normal).

2. Tap **OK**. The measurement mode changes to Normal (Normal), and the navigation window appears.

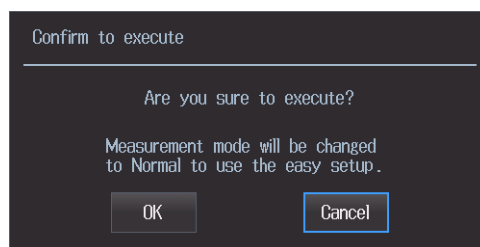

3. Tap **Easy Setup** again.

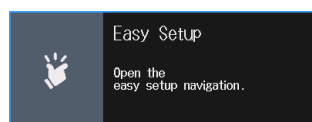

From the Setup Menu after Instrument Startup

1. Tap the **Setup** icon (), or press **MENU** under SETUP. The setup menu screen appears.
2. Tap **Navigation** at the bottom of the setup menu screen. A navigation window appears.

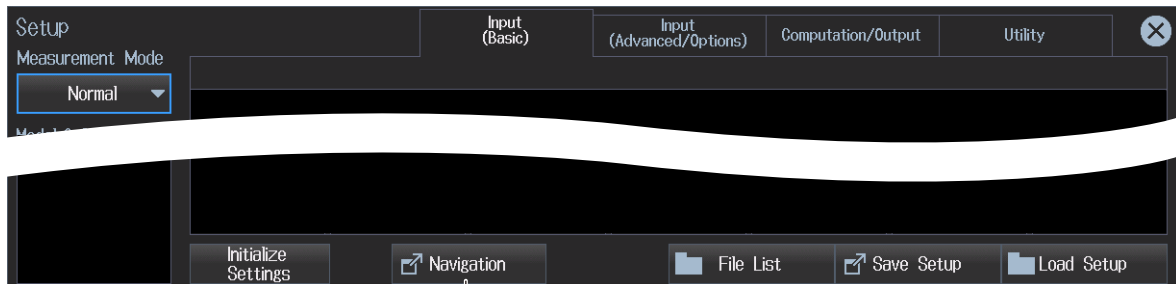

Navigation button

3. Tap **Easy Setup**.

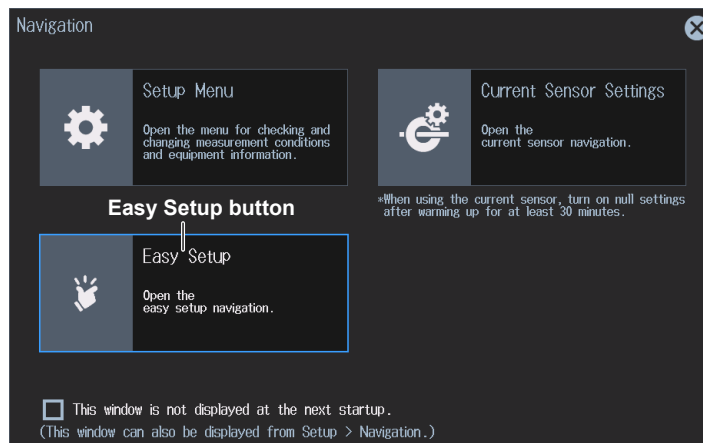

When the measurement mode is other than Normal (Normal), a confirmation screen will appear asking if you want to change to Normal (Normal).

4. Tap **OK**. The measurement mode changes to Normal (Normal), and the navigation window appears.

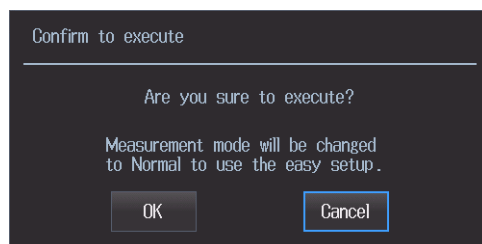

5. Tap **Easy Setup** again.

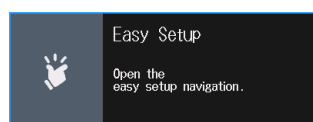

Setting the Wiring System (Wiring)

► **section 2.1**

1. On the Easy Setup menu screen, tap **Start Setup**. The button changes to “View Settings”, and a screen appears for setting the wiring system. Tapping **View Settings** (which changed from Start Setup) will show the initial setup menu screen where you can view the current states of the settings in a table.

Start Setup button

Easy Setup

Start Setup

	Element 1 5A	Element 2 5A	Element 3 5A	Element 4 5A	Element 5 30A	Element 6 30A	Element 7 30A
Wiring	Wiring system 1P2W 1P2W 1P2W 1P2W 1P2W 1P2W 1P2W						
Measurement Scene	Measurement scene None None None None None None						
Sync Source	Item list I2 I3 I4 I5 I6 I7						
Current Range	5A	5A	5A	5A	30A	30A	30A
Freq Filter LPF	OFF	OFF	OFF	OFF	OFF	OFF	OFF
Freq Filter HPF	0.1 Hz	0.1 Hz	0.1 Hz	0.1 Hz	0.1 Hz	0.1 Hz	0.1 Hz
Line Filter LPF	OFF	OFF	OFF	OFF	OFF	OFF	OFF
Common	Update Mode Constant			Update Rate 500ms			

2. Select the wiring system. For details on the wiring system, see section 2.1.

Easy Setup

View Settings

Wiring unit

Wiring unit

	ΣA 3P4W				ΣB 3P3W		
	Element 1 5A	Element 2 5A	Element 3 5A	Element 4 5A	Element 5 30A	Element 6 30A	Element 7 30A
Terminal/CT Sensor	5A	5A	5A	5A	30A	30A	30A
Wiring	3P4W	3P4W	3P4W	1P2W	3P3W	3P3W	1P2W
Figure							
Common	<p>Select the wiring system.</p> <p>Next</p>						

Setting the Measurement Scene (Measurement Scene)

1. Tap **Next** at the bottom of the wiring system (Wiring) setup screen. A window appears for setting the measurement scene.

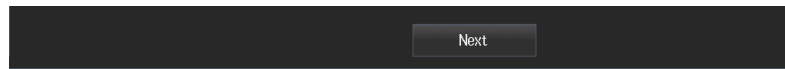

2. Select the measurement scenes for wiring units to be configured or for elements that do not comprise a wiring unit. A confirmation screen will appear asking if you want to apply the measurement scenes. If you do not select the measurement scenes, proceed to the detailed settings of each item on the next page.

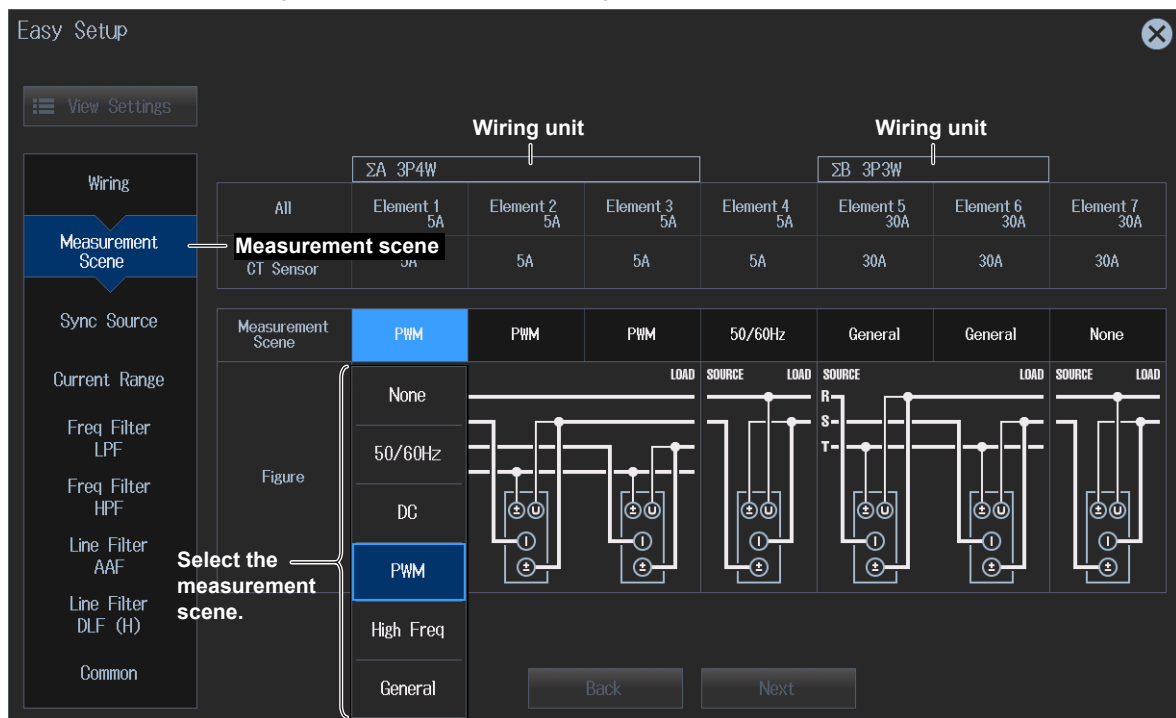

3. Tap **OK**. The measurement scenes are applied.

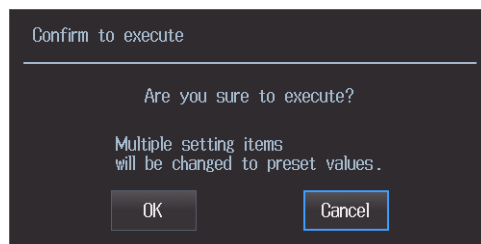

For details on the measurement scene settings, see [“Measurement Scene” in the Features Guide](#).

Note

- Set the measurement scenes (Measurement Scene) for each wiring unit and for each element that does not comprise a wiring unit.
- When you set the measurement scenes, the following will result.
 - The Freq Filter Advanced Settings (see section 2.7) will be enabled, and you will be able to separately set the HPF and LPF of the frequency filter.
 - The Line Filter Advanced Settings will be enabled (see section 2.7), and you will be able to separately set the anti-aliasing filter (AAF) and the digital line filter (DLF(H), for harmonic measurement) of the line filter.
 - You can also move to the appropriate setup screens by tapping the buttons in the item list (Wiring, Measurement Scene, Sync Source, etc.) appearing on the left side of the setup screen.

Detailed Settings of Each Item

▶ [section 2.2](#), [2.7](#), [2.8](#), [2.10](#)

1. Tap **Next** at the bottom of the measurement Scene (Measurement Scene) setup screen. A screen appears showing the detailed settings of each item.

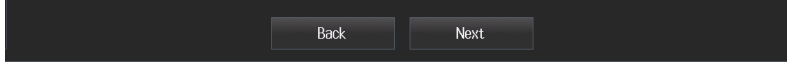

To move to the previous screen, tap **Back**.

2. Tap a detailed setting you want to edit. A screen appears showing the detailed settings of each item.

The screenshot shows the 'Detailed settings' screen for the 'Measurement Scene'. It features a table of settings for two wiring units: ΣA 3P4W and ΣB 3P3W. The table has columns for 'All', 'Element 1 5A', 'Element 2 5A', 'Element 3 5A', 'Element 4 5A', 'Element 5 30A', 'Element 6 30A', and 'Element 7 30A'. The rows include 'Measurement Scene', 'Sync Source', 'Current Range', 'Freq Filter LPF', 'Freq Filter HPF', 'Line Filter AAF', and 'Line Filter DLF (H)'. Below the table are 'Update Mode' (set to Auto) and 'Update Rate for Auto Update Mode' (set to 50ms). A legend at the bottom identifies the 'Update mode' and 'Data update rate' settings. A blue box highlights the 'Sync Source' row for Element 1.

	ΣA 3P4W	Detailed settings			ΣB 3P3W			
	All	Element 1 5A	Element 2 5A	Element 3 5A	Element 4 5A	Element 5 30A	Element 6 30A	Element 7 30A
Measurement Scene		PWM	PWM	PWM	50/60Hz	General	General	None
Sync Source		I1	I1	I1	U4	U5	U5	I7
Current Range		Auto	Auto	Auto	Auto	Auto	Auto	30A
Freq Filter LPF		2.0kHz	2.0kHz	2.0kHz	0.1kHz	OFF	OFF	OFF
Freq Filter HPF		0.1 Hz	0.1 Hz	0.1 Hz	10 Hz	0.1 Hz	0.1 Hz	OFF
Line Filter AAF		ON	ON	ON	ON	ON	ON	OFF
Line Filter DLF (H)		100.0kHz	100.0kHz	100.0kHz	100.0kHz	100.0kHz	100.0kHz	OFF

Update Mode: Auto
Update Rate for Auto Update Mode: 50ms

Update mode (see section 2.10)
Data update rate (see sec. 2.10)

3. Edit each item. For details on the individual settings, see the respective references.

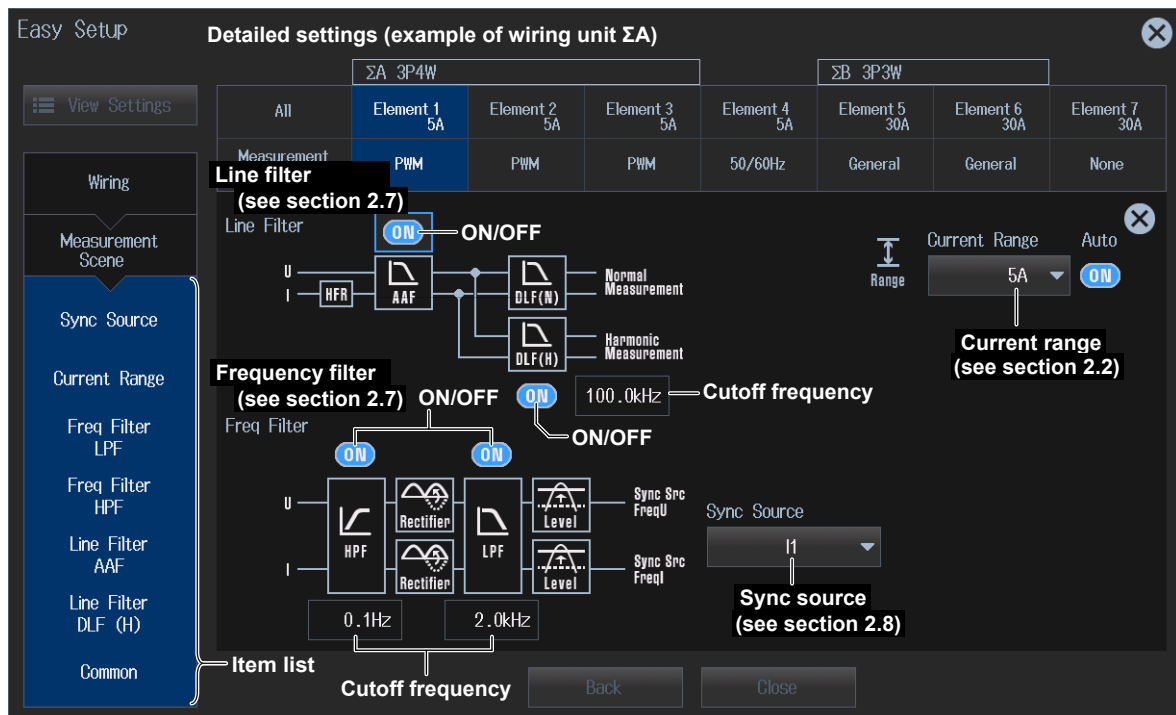

Note

- Edit the detailed settings of each item for each wiring unit and for each element that does not comprise a wiring unit.

4. To change the update mode or data update rate, tap **Update Mode** or **Update Rate** at the bottom of each item's detailed settings screen, and select the mode or rate.

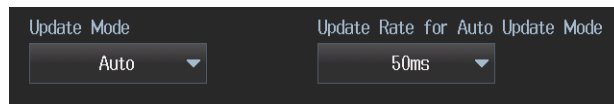

5. Tap the **Close** button at the bottom of each item's detailed settings screen to close the Easy Setup menu screen.

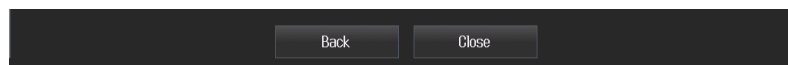

To move to the previous screen, tap **Back**.

Note

- The update mode (Update Mode) and data update rate (Update Rate) apply to all wiring units and elements. (They cannot be set separately.)
- When any of the measurement scenes in Elements 1 through 7 is set to PWM or General, the update mode (Update Mode) will be set to Auto, and the update rate (Update Rate) will be set to 50 ms. (You can then change them.)

2.1 Setting the Wiring System

This section explains operating procedures using the following setup methods.

- Procedure Using the Setup Menu (see chapter 1)
 - ▶ “Wiring System (Wiring)” in the features guide
 - ▶ “Range Σ link (Range Σ Link)” in the features guide

Procedure Using the Setup Menu

1. Tap the **Setup** icon , or press **MENU** under SETUP.
2. Tap the **Input (Basic)** tab. An input settings (basic measurement conditions) overview screen appears.
Pressing **ESC** closes the overview screen.

Set the wiring system. Input (Basic) tab



Element	Wiring	Voltage Range	Current Range	Ratio [mV/A]	Scaling	VT Ratio	CT Ratio	SF Ratio	Line Filter Cutoff	Freq Filter Cutoff	Sync Source
Element 1	30A	1000V	30A	10.0000	OFF	1.0000	1.0000	1.0000	0.5kHz	0.1kHz	I1
Element 2	30A	1000V	30A	10.0000	OFF	1.0000	1.0000	1.0000	0.5kHz	0.1kHz	I2
Element 3	30A	1000V	30A	10.0000	OFF	1.0000	1.0000	1.0000	0.5kHz	0.1kHz	I3
Element 4	5A	1000V	5A	10.0000	OFF	1.0000	1.0000	1.0000	0.5kHz	0.1kHz	I4
Element 5	5A	1000V	5A	10.0000	OFF	1.0000	1.0000	1.0000	0.5kHz	0.1kHz	I5
Element 6	CS	1000V	1A	Custom	OFF	1.0000	1.0000	1.0000	0.5kHz	0.1kHz	I6
Element 7	CS	1000V	1A	Custom	OFF	1.0000	1.0000	1.0000	0.5kHz	0.1kHz	I7

When the input element is 760901 or 760902
 When the input element is 760903

Note

You can also display the input settings (basic measurement conditions) overview screen by moving the cursor on the Input (Basic) tab using the arrow keys and then pressing SET.

Setting the Wiring System

3. Tap **Wiring** of the input element number you want to configure. A wiring system setup menu appears.

Wiring system (example of element 1)

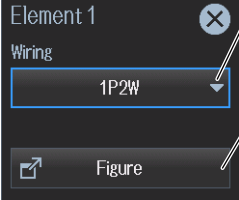

Select the wiring system (1P2W, 1P3W, 3P3W, 3P4W, 3P3W(3V3A), 3P3W(3V3AR)).
When you select an input element, the wiring systems that you can select are displayed. Select the wiring system from those displayed.

Shows the advanced wiring system setup screen
Displays a screen containing wiring system selection buttons, wiring diagram, wiring units, etc. (see section 1.2)

Wiring System Combination

- If you select 1P3W, 3P3W, 3P4W, 3P3W(3V3A), or 3P3W(3V3AR) for the wiring system, the wiring unit is set with the two or three input elements adjacent to the selected element whose element numbers are larger than the selected element.
- On models that have six or more input elements installed, up to three wiring units (ΣA , ΣB , and ΣC) are automatically set. The wiring unit symbols ΣA , ΣB , and ΣC are attached to the element numbers in order, starting with the smallest number.

Note

- You cannot set the wiring units for larger element numbers before the wiring units for smaller element numbers.
- You cannot assign different types of input element to a wiring unit.
- For the 760903 current sensor input element, when Range Σ Link is set to ON, the wiring unit cannot be set among elements whose CT Type or Input Resistance setting is different.

Range Σ Link Settings (Range Σ Link)

2. Tap the **Input (Advanced/Options)** tab. An input settings (advanced/options) overview screen appears.
Pressing **ESC** closes the overview screen.
3. Tap **Range**. A setup screen appears for common measurement range items.

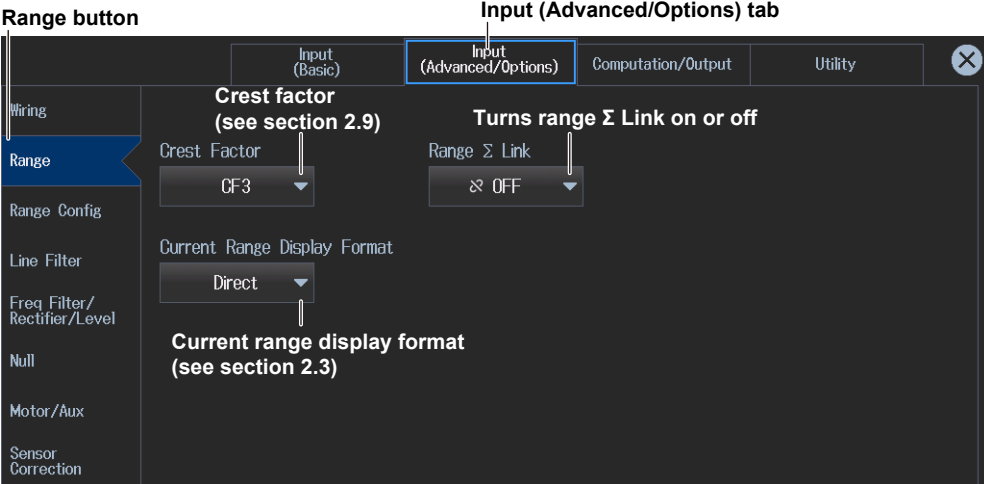

Range button

Input (Advanced/Options) tab

Input (Advanced/Options)

Crest factor (see section 2.9)
Crest Factor: CF3

Turns range Σ Link on or off
Range Σ Link: OFF

Current range display format (see section 2.3)
Current Range Display Format: Direct

Note

- When range Σ link is set to on, the measurement ranges of the input elements assigned to the same wiring unit are set to the same range. When range Σ link is set to off, the measurement ranges of the input elements can be set independently even when they are assigned to the same wiring unit.
- For the 760903 current sensor input element, when any of the wiring units is set among the elements whose CT Type or Input Resistance setting is different, Range Σ Link cannot be set to ON.

2.2 Setting the Voltage Range and Current Range

- ▶ “Voltage Range (Voltage, VOLTAGE RANGE)” in the features guide
- ▶ “Auto Voltage Range (Auto (Voltage), AUTO)” in the features guide
- ▶ “Current Range (Current, CURRENT RANGE)” in the features guide
- ▶ “Auto Current Range (Auto (Current), AUTO)” in the features guide
- ▶ “Current Measurement Terminal (Terminal)” in the features guide

This section explains operating procedures using the following setup methods.

- Procedure Using the Setup Menu (see chapter 1)
- Procedure Using the Menu Icons (see page iii)
- Procedure Using the Keys (other than SETUP) (see section 1.2 in IM WT5000-03EN)

Procedure Using the Setup Menu

1. Tap the **Setup** icon  or press **MENU** under **SETUP**.
2. Tap the **Input (Basic)** tab. An input settings (basic measurement conditions) overview screen appears.
Pressing **ESC** closes the overview screen.

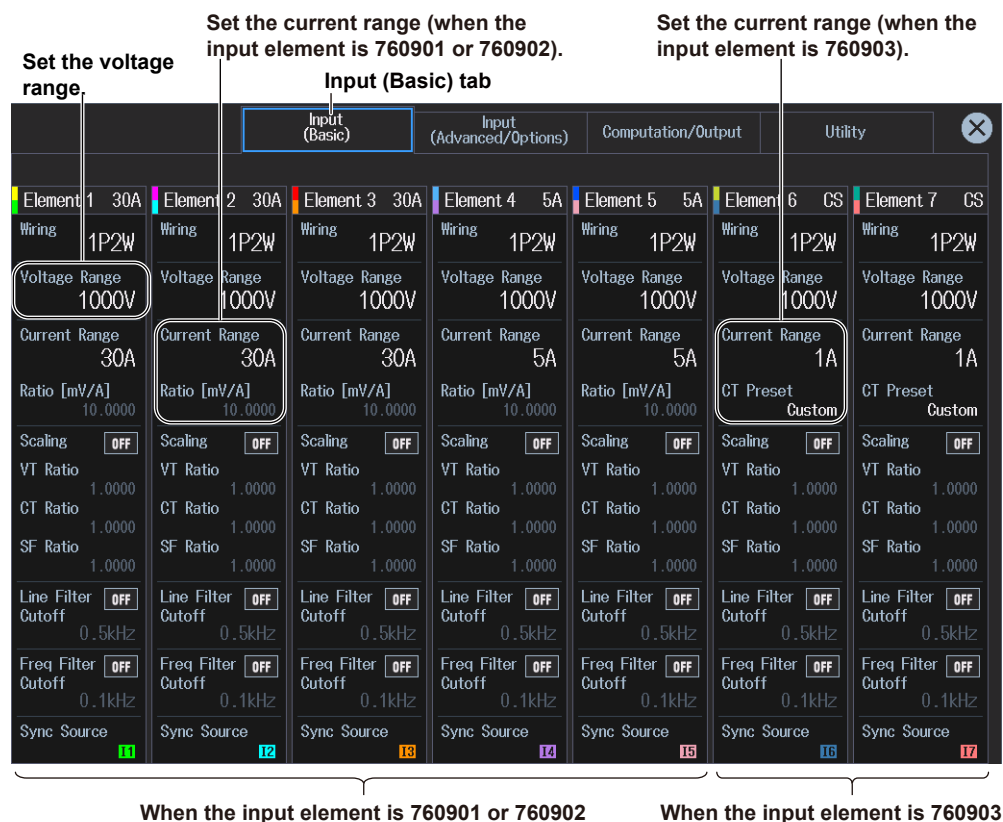

The screenshot shows the **Input (Basic)** tab with settings for seven elements. Annotations are as follows:

- Set the voltage range:** Points to the Voltage Range field for Element 1, which is set to 1000V.
- Set the current range (when the input element is 760901 or 760902):** Points to the Current Range field for Element 2, which is set to 30A.
- Set the current range (when the input element is 760903):** Points to the Current Range field for Element 6, which is set to 1A.

Element	Wiring	Voltage Range	Current Range	Ratio [mV/A]	Scaling	VT Ratio	CT Ratio	SF Ratio	Line Filter Cutoff	Freq Filter Cutoff	Sync Source	
1	30A	1P2W	1000V	30A	10.0000	OFF	1.0000	1.0000	1.0000	0.5kHz	0.1kHz	I1
2	30A	1P2W	1000V	30A	10.0000	OFF	1.0000	1.0000	1.0000	0.5kHz	0.1kHz	I2
3	30A	1P2W	1000V	30A	10.0000	OFF	1.0000	1.0000	1.0000	0.5kHz	0.1kHz	I3
4	5A	1P2W	1000V	5A	10.0000	OFF	1.0000	1.0000	1.0000	0.5kHz	0.1kHz	I4
5	5A	1P2W	1000V	5A	10.0000	OFF	1.0000	1.0000	1.0000	0.5kHz	0.1kHz	I5
6	CS	1P2W	1000V	1A	10.0000	OFF	1.0000	1.0000	1.0000	0.5kHz	0.1kHz	I6
7	CS	1P2W	1000V	1A	10.0000	OFF	1.0000	1.0000	1.0000	0.5kHz	0.1kHz	I7

When the input element is 760901 or 760902

When the input element is 760903

Note

You can also display the input settings (basic measurement conditions) overview screen by moving the cursor on the Input (Basic) tab using the arrow keys and then pressing SET.

Setting the Voltage Range (Voltage Range)

3. Tap **Voltage Range** of the input element number you want to configure. A voltage range setup menu appears.
4. Follow the instructions below to set the voltage range.
 - **Sets auto range mode**
 3. Tap **Auto**. The AUTO key illuminates.
 - **Setting the Fixed Range**

Tap **Voltage Range**. A voltage menu appears.
Tap a voltage range on the menu to set the voltage range.

Voltage range (example of element 1)

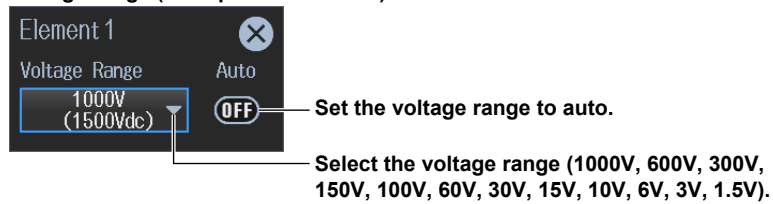

Operations in the Input Information Area

See page 2-8.

Available voltage range options

When the Crest Factor Is Set to CF3	When the Crest Factor Is Set to CF6 or CF6A
1.5 V, 3 V, 6 V, 10 V, 15 V, 30 V, 60 V, 100 V, 150 V, 300 V, 600 V, 1000 V	0.75 V, 1.5 V, 3 V, 5 V, 7.5 V, 15 V, 30 V, 50 V, 75 V, 150 V, 300 V, 500 V

Note

- When range Σ link (see section 2.1) is set to on, the voltage ranges of the input elements assigned to the same wiring unit are set to the same range. When range Σ link is set to off, the voltage ranges of the input elements can be set independently even when they are assigned to the same wiring unit.
- When the setup menu screen is overlapped on the range display of each element, press ESC. The setup menu screen will close.

Setting the Current Range (Current Range) When the Input Element Is 760901 or 760902

3. Tap **Current Range** of the input element number you want to configure. A current range setup menu appears.
4. Follow the instructions below to set the current range.
 - **Sets auto range mode**
Tap **Auto**. The AUTO key illuminates.
 - **Setting the Fixed Range**
Tap **Current Range**. A current range menu appears.
Tap a current range on the menu to set the current range.

Current range (example of element 1)

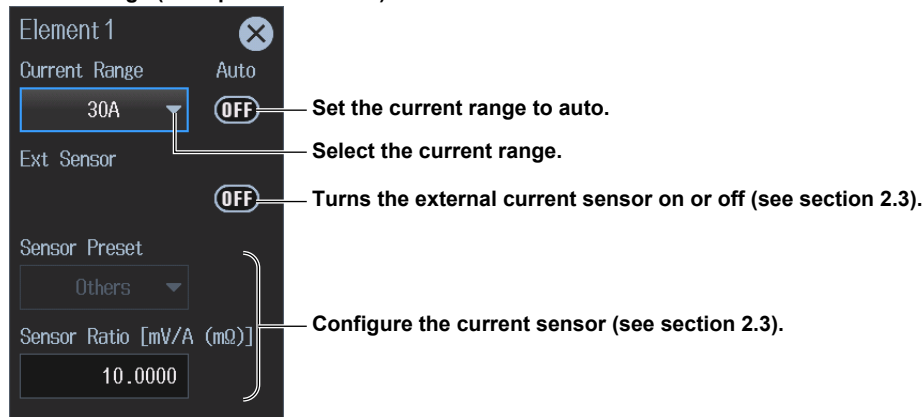

Operations in the Input Information Area

See page 2-8.

Available current range options

• 30 A Input Element 760901

When the Crest Factor Is Set to CF3	When the Crest Factor Is Set to CF6 or CF6A
500 mA, 1 A, 2 A, 5 A, 10 A, 20 A, 30 A	250 mA, 500 mA, 1 A, 2.5 A, 5 A, 10 A, 15 A

• 5 A Input Element 760902

When the Crest Factor Is Set to CF3	When the Crest Factor Is Set to CF6 or CF6A
5 mA, 10 mA, 20 mA, 50 mA, 100 mA, 200 mA, 500 mA, 1 A, 2 A, 5 A	2.5 mA, 5 mA, 10 mA, 25 mA, 50 mA, 100 mA, 250 mA, 500 mA, 1 A, 2.5 A

Note

When range Σ link (see section 2.1) is set to on, the current ranges of the input elements assigned to the same wiring unit are set to the same range. When range Σ link is set to off, the current ranges of the input elements can be set independently even when they are assigned to the same wiring unit.

Setting the Current Range (Current Range) When the Input Element Is 760903

3. Tap **Current Range** of the input element number you want to configure. A current range setup menu appears.

Current Measurement Terminal (Terminal)

4. Tap **Terminal**. The Terminal menu appears.

5. Tap **CT Series** or **Probe** to select Terminal.

If Terminal is set to CT Series, proceed to step 6. If it is set to Probe, proceed to step 11 on the next page.

Current Range (Current Range) When Terminal Is Set to CT Series

When Terminal is set to Sensor, Scaling is set to ON, and CT Ratio is set to the default value according to CT Type. Change these settings if necessary.

After selecting CT Type and input resistance, set the current range. Then, in step 16, set the CT ratio.

6. Tap **CT Preset**. The CT Preset menu appears.

7. Select the CT type.

When you change the CT type, the input resistance is set accordingly. Further, Scaling is set to ON, and CT Ratio is set to the default value according to CT Type. Change these settings if necessary.

If CT Type is set to Custom, proceed to step 8. If you do not want to change the input resistance, proceed to step 10.

8. Tap **Input Resistance**. The Input Resistance menu appears.

9. Select the input resistance.

10. Follow the instructions below to set the current range.

- **Enabling Auto Range**

Tap **Auto**. The AUTO key illuminates.

- **Setting a Fixed Range**

Tap **Current Range**. A current range menu appears.

Tap a current range on the menu to set the current range.

Current range (example of element 6)

The screenshot shows the 'Element 6' configuration menu with the following settings and annotations:

- Current Range:** 1A (dropdown menu). Annotation: "Set the current range to auto." (points to the 'Auto' button).
- Terminal:** Sensor (dropdown menu). Annotation: "Set Terminal to Sensor."
- CT Preset (Detected: Unknown):** Custom (dropdown menu). Annotation: "ID of the connected CT*" (points to the 'Detected: Unknown' text) and "Select the CT type."
- Input Resistance:** 1Ω (dropdown menu). Annotation: "Select the input resistance."
- Scaling:** ON (toggle button).
- CT Ratio:** 1.0000 (text field).

* The CT ID (e.g., product name) is displayed. If ID information is not detected, "Unknown" is displayed.

Main Current Range Options

The options vary depending on the CT type. For the current range options, see ["Current Range \(Current, CURRENT RANGE\)"](#) in the features guide.

Current Range (Current Range) When Terminal Is Set to Probe

When Terminal is set to Probe, the CT ratio is set to 1.0000. The scaling setting will not change. Change it if necessary.

11. Follow the instructions below to set the current range.

- **Enabling Auto Range**
Tap **Auto**. The AUTO key illuminates.
- **Setting a Fixed Range**
Tap **Current Range**. A current range menu appears.
Tap a current range on the menu to set the current range.

12. Tap **Probe Preset**. A Probe Preset menu appears.

13. Select the probe type.

If you change the probe type, the output voltage rate is set to its default value according to the probe type. If necessary, change the settings in step 14.

14. Tap **Output Voltage Rate [V/A]**, and set the output voltage rate.

Current range (example of element 6)

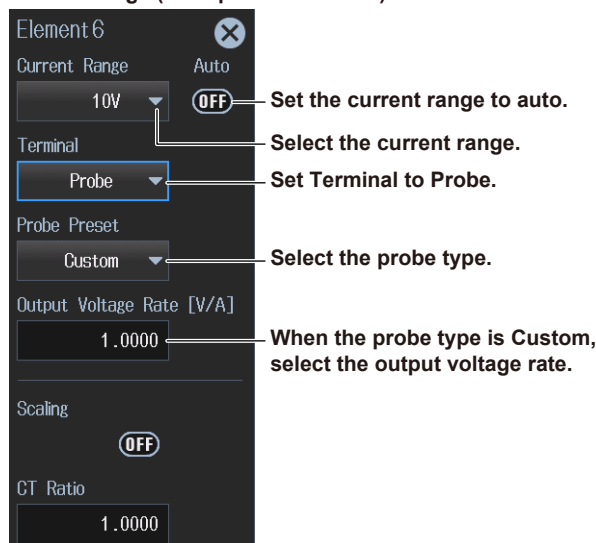

Available current range options

For the current range options, see “[Current Range \(Current, CURRENT RANGE\)](#)” in the [features guide](#).

Note

When range Σ link (see section 2.1) is set to on, the current ranges and current measurement terminal settings of the input elements assigned to the same wiring unit are set to the same settings. When range Σ link is set to off, the current ranges and current measurement terminal settings of the input elements can be set independently even when they are assigned to the same wiring unit.

Operations in the Input Information Area

See page 2-8.

Scaling Feature

This setting is linked to the scaling setting of section 2.4.

Turning Scaling On or Off

15. Tap **Scaling** to select ON or OFF.

Setting the CT Ratio

16. Tap **CT Ratio** to set the CT ratio (or the conversion ratio of the current sensor that produces current).

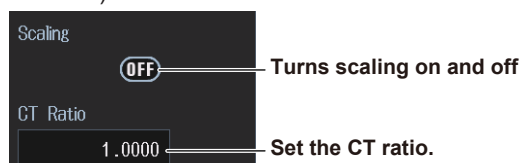

Procedure Using the Menu Icons

You can also use the menu icons shown on the right side of the screen to set the voltage range and current range.

1. Tap the **Range** menu icon . A Range menu appears in the sub menu area on the right side of the screen.
By tapping the displayed items, you can specify the same settings as when using the screen explained earlier.

Note

For details on the Range menu, see page viii.

Procedure Using Keys

You can also use the front panel keys to set the voltage range and current range.

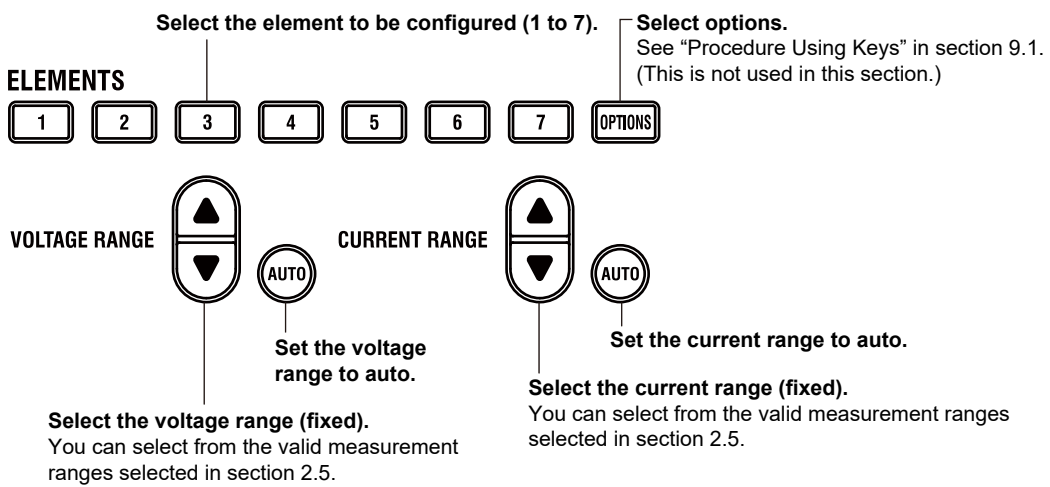

Procedure Using the Input Information Area (Elements tab)

If you use the input information area shown on the right side of the screen, you can set the voltage range and current range while viewing the measurements. The input information area is displayed when you close the overview screen.

1. Tap the **Elements** tab. An Elements menu appears in the input information area.
2. Tap the element (1 to 7) you want to configure. A range setup screen for the element appears.

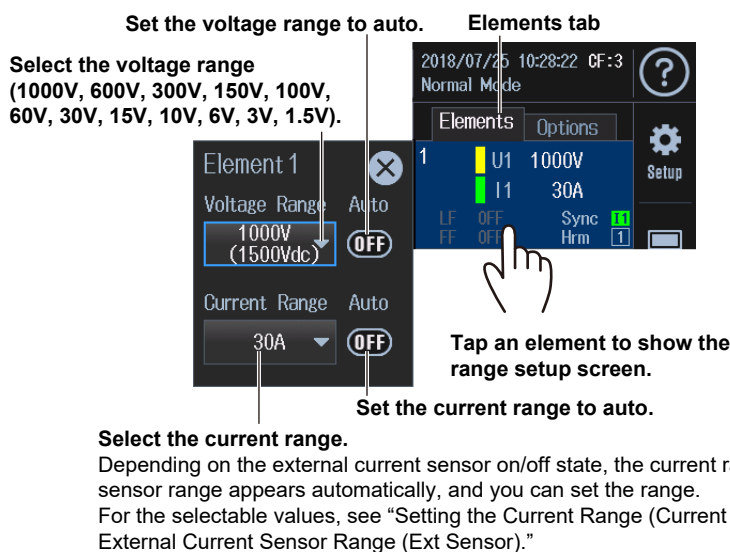

2.3 Configuring the Current Sensor

- ▶ “External Current Sensor On/Off (Ext Sensor)” in the features guide
- ▶ “External Current Sensor Conversion Ratio (Sensor Ratio)” in the features guide
- ▶ “Display Format of Current Range (Current Range Display Format)” in the features guide

This section explains operating procedures using the following setup methods.

- Procedure Using the Setup Menu (see chapter 1)
- Procedure Using the Menu Icons (see page iii)

Procedure Using the Setup Menu

1. Tap the **Setup** icon , or press **MENU** under SETUP. 2. Tap the **Input (Basic)** tab. An input settings (basic measurement conditions) overview screen appears. Pressing **ESC** closes the overview screen.

Input (Basic) tab

Set the current range.



Element 1 30A		Element 2 30A		Element 3 30A		Element 4 5A		Element 5 5A		Element 6 CS		Element 7 CS	
Wiring	1P2W	Wiring	1P2W	Wiring	1P2W	Wiring	1P2W	Wiring	1P2W	Wiring	1P2W	Wiring	1P2W
Voltage Range	1000V	Voltage Range	1000V	Voltage Range	1000V	Voltage Range	1000V	Voltage Range	1000V	Voltage Range	1000V	Voltage Range	1000V
Current Range	30A	Current Range	30A	Current Range	30A	Current Range	5A	Current Range	5A	Current Range	1A	Current Range	1A
Ratio [mV/A]	10.0000	Ratio [mV/A]	10.0000	Ratio [mV/A]	10.0000	Ratio [mV/A]	10.0000	Ratio [mV/A]	10.0000	CT Preset	Custom	CT Preset	Custom
Scaling	OFF	Scaling	OFF	Scaling	OFF	Scaling	OFF	Scaling	OFF	Scaling	OFF	Scaling	OFF
VT Ratio	1.0000	VT Ratio	1.0000	VT Ratio	1.0000	VT Ratio	1.0000	VT Ratio	1.0000	VT Ratio	1.0000	VT Ratio	1.0000
CT Ratio	1.0000	CT Ratio	1.0000	CT Ratio	1.0000	CT Ratio	1.0000	CT Ratio	1.0000	CT Ratio	1.0000	CT Ratio	1.0000
SF Ratio	1.0000	SF Ratio	1.0000	SF Ratio	1.0000	SF Ratio	1.0000	SF Ratio	1.0000	SF Ratio	1.0000	SF Ratio	1.0000
Line Filter Cutoff	0.5kHz	Line Filter Cutoff	0.5kHz	Line Filter Cutoff	0.5kHz	Line Filter Cutoff	0.5kHz	Line Filter Cutoff	0.5kHz	Line Filter Cutoff	0.5kHz	Line Filter Cutoff	0.5kHz
Freq Filter Cutoff	0.1kHz	Freq Filter Cutoff	0.1kHz	Freq Filter Cutoff	0.1kHz	Freq Filter Cutoff	0.1kHz	Freq Filter Cutoff	0.1kHz	Freq Filter Cutoff	0.1kHz	Freq Filter Cutoff	0.1kHz
Sync Source	I1	Sync Source	I2	Sync Source	I3	Sync Source	I4	Sync Source	I5	Sync Source	I6	Sync Source	I7

Note

You can also display the input settings (basic measurement conditions) overview screen by moving the cursor on the Input (Basic) tab using the arrow keys and then pressing SET.

Setting the External Current Sensor Range (Ext Sensor)

3. Tap **Current Range** of the input element number you want to configure. An current range setup menu appears.
4. Tap **Ext Sensor** to select ON. The current range display changes to the external current sensor range display.
5. Follow the instructions below to set the external current sensor range.
 - **Sets auto range mode**
Tap **Auto**. The AUTO key illuminates.
 - **Setting the Fixed Range**
Tap **Current Range**. An external current sensor range menu appears. Tap the external current sensor range on the menu, and set the range.

Current range (example of element 1)

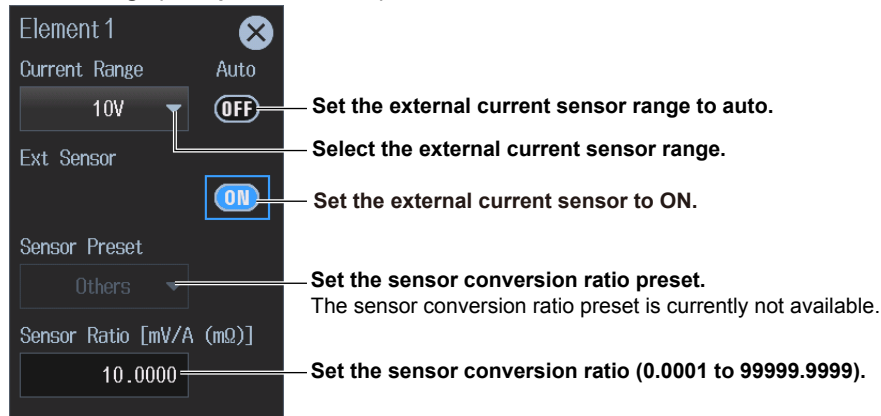

Operations in the Input Information Area

As explained in “Current Range” of section 2.2, the external current sensor range can also be set in the input information area (see page 2-8).

Available External Current Sensor Range Options

When the display format of the external current sensor range is set to Direct (see the next page), you can select the range from the available options shown in the following table (the unit is mV or V). When the display format is set to Measure, the setup range is set to the value from the following table divided by the external current sensor conversion ratio (the unit is A).

When the Crest Factor Is Set to CF3	When the Crest Factor Is Set to CF6 or CF6A
50 mV, 100 mV, 200 mV, 500 mV, 1 V, 2 V, 5 V, 10 V	25 mV, 50 mV, 100 mV, 250 mV, 500 mV, 1 V, 2.5 V, 5 V

Note

When range Σ link (see section 2.1) is set to on, the external current sensor ranges of the input elements assigned to the same wiring unit are set to the same range. When range Σ link is set to off, the external current sensor ranges of the input elements can be set independently even when they are assigned to the same wiring unit.

External Current Sensor Range and Conversion Ratio Configuration Example

When you measure a current with a maximum value of 100 A using a current sensor that produces 10 mV when 1 A of current is flowing, the maximum voltage that the current sensor produces is $10 \text{ mV/A} \times 100 \text{ A} = 1 \text{ V}$. Therefore, configure the settings as indicated below.

- External current sensor range: 1 V
- External current sensor conversion ratio: 10 mV/A

Setting the Current Range Display Format (Current Range Display Format)

3. Tap the **Input (Advanced/Options)** tab. An input settings (advanced/options) overview screen appears.
Pressing **ESC** closes the overview screen.
4. Tap **Range**. A setup screen appears for common measurement range items.

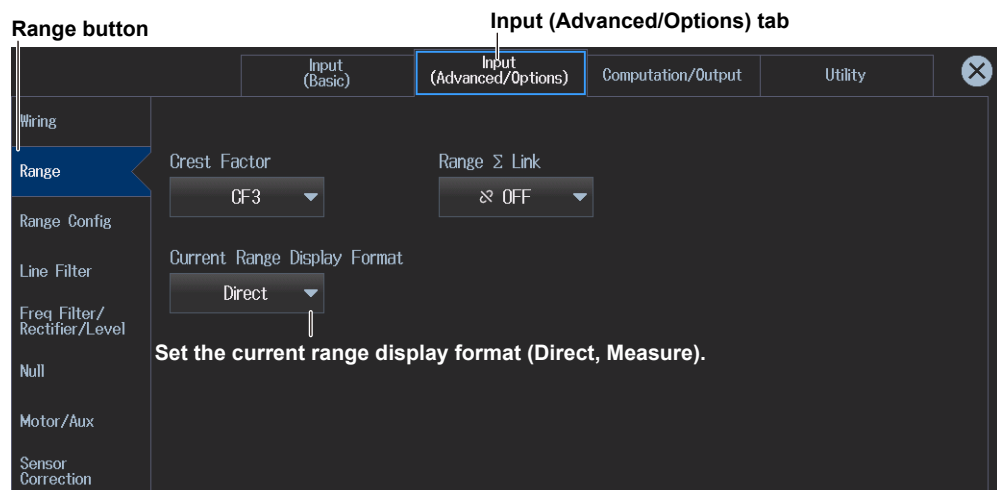

Procedure Using the Menu Icons

You can also use the menu icons shown on the right side of the screen to set the external current sensor range.

1. Tap the **Range** menu icon . A Range menu appears in the sub menu area on the right side of the screen.

By tapping the displayed items, you can specify the same settings as when using the keys explained earlier.

Note

For details on the Range menu, see page viii.

Procedure Using Keys

You can also use the front panel keys to set the external current sensor range.

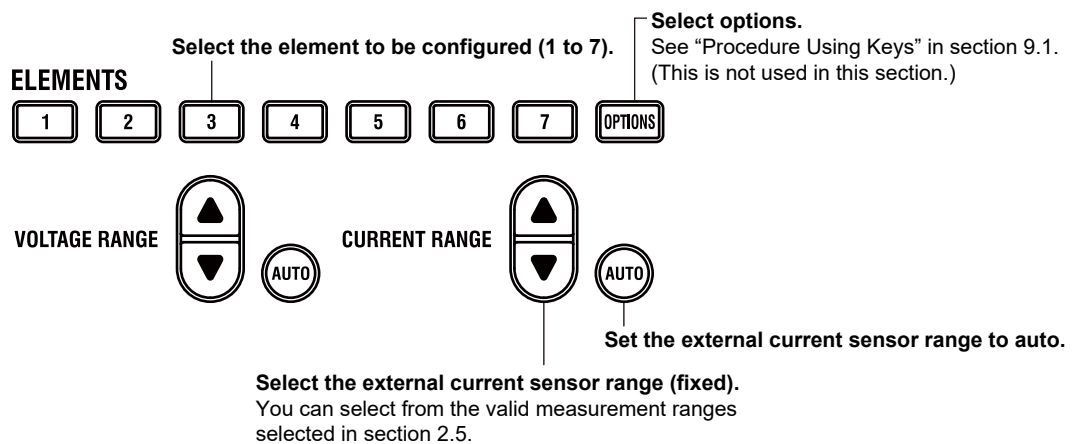

Note

To turn the external current sensor on and off or set the sensor conversion ratio and other details, use the Setup menu.

2.4 Setting the Voltage Transformer (VT) and Current Transformer (CT) Ratios

► “Scaling (Scaling)” in the features guide

This section explains operating procedures using the following setup methods.

- Procedure Using the Setup Menu (see chapter 1)

Procedure Using the Setup Menu

1. Tap the **Setup** icon , or press **MENU** under **SETUP**.
2. Tap the **Input (Basic)** tab. An input settings (basic measurement conditions) overview screen appears.

Pressing **ESC** closes the overview screen.



Set the VT ratio, CT ratio, and power coefficient.

Note

You can also display the input settings (basic measurement conditions) overview screen by moving the cursor on the Input (Basic) tab using the arrow keys and then pressing SET.

Setting the VT Ratio, CT Ratio, and Power Coefficient (Scaling)

3. Tap **Scaling** of the input element number you want to configure. A scaling setup menu appears.

VT ratio, CT ratio, and power coefficient
Input element 760901 or 760902

Input element 760903

Turns scaling on or off
When you want to multiply the external current sensor output by the conversion ratio and read the current of the circuit under measurement directly, turn the VT/CT scaling feature off. If it is turned on, the value will be further multiplied by the CT ratio.

Set the VT ratio (0.0001 to 99999.9999).

Set the CT ratio preset (CT2000A, CT1000A, CT1000, CT200, CT60, Others).
Set this when using the dedicated CT.

Set the CT ratio (0.0001 to 99999.9999).

Set the power coefficient (scaling factor) (0.0001 to 99999.9999).

Copies the coefficients

Copying VT Ratio, CT Ratio, and Power Coefficient (Exec Copy Σ)

You can copy the ratio or coefficient of the input element that is indicated by the cursor to all the input elements in that element's wiring unit.

Copy Σ

VT Ratio
Copy Exec — Copies the VT ratio

CT Ratio
Copy Exec — Copies the CT ratio

SF Ratio
Copy Exec — Copies the power coefficients

2.5 Setting the Valid Measurement Range

► “Range Configuration (Range Config)” in the features guide

► “Valid Measurement Range (Valid Measurement Range)” in the features guide

This section explains operating procedures using the following setup methods.

- Procedure Using the Setup Menu (see chapter 1)

This section explains how to set the measurement range when the crest factor (see section 2.9) is set to CF3. When the crest factor is CF6 or CF6A, set the valid measurement ranges from the available options.

Procedure Using the Setup Menu

1. Tap the **Setup** icon , or press **MENU** under **SETUP**.
2. Tap the **Input (Advanced/Options)** tab. An input settings (advanced/options) overview screen appears.
Pressing **ESC** closes the overview screen.
3. Tap **Range Config**. A measurement range configuration setup screen appears.

Range Config button **Input (Advanced/Options) tab**

Set the valid current measurement range.
Set the valid voltage measurement range.



	Element 1	Element 2	Element 3	Element 4	Element 5	Element 6	Element 7
Current	30A	30A	30A	5A	5A	CS	CS
Voltage	1000V	1000V	1000V	1000V	1000V	1000V	1000V
	600V	600V	600V	600V	600V	600V	600V
	300V	300V	300V	300V	300V	300V	300V
	150V	150V	150V	150V	150V	150V	150V
	100V	100V	100V	100V	100V	100V	100V
	60V	60V	60V	60V	60V	60V	60V
	30V	30V	30V	30V	30V	30V	30V
	15V	15V	15V	15V	15V	15V	15V
	10V	10V	10V	10V	10V	10V	10V
	6V	6V	6V	6V	6V	6V	6V
	3V	3V	3V	3V	3V	3V	3V
	1.5V	1.5V	1.5V	1.5V	1.5V	1.5V	1.5V
Peak Over Jump	OFF	OFF	OFF	OFF	OFF	OFF	OFF

Note

You can also display the input settings (advanced/options) overview screen by moving the cursor on the Input (Advanced/Options) tab using the arrow keys and then pressing SET.

Setting the Valid Voltage Measurement Range (Voltage)

4. Tap **Voltage**. A valid voltage measurement range setup screen appears.

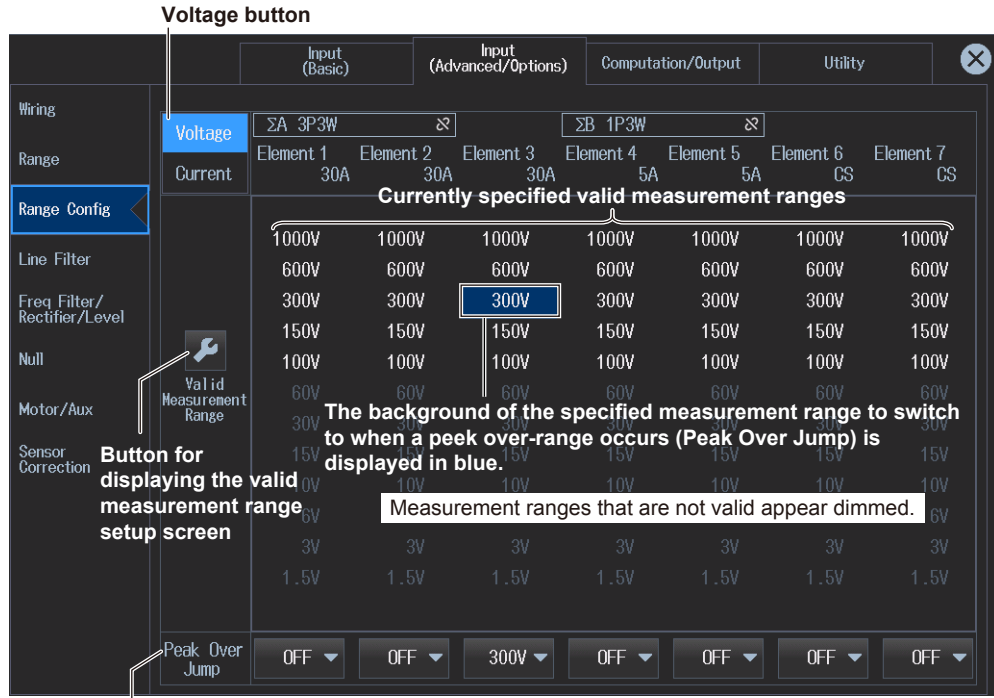

Specify the measurement range to switch to when a peak over-range occurs. (OFF, 1000V, 600V, 300V, 150V, 100V, 60V, 30V, 15V, 10V, 6V, 3V, 1.5V)

- When Range Σ Link is set to on (see section 2.1), the input elements that are assigned to the same wiring unit are set to the same range.
- If auto range is on (you can turn it on by pressing AUTO), the instrument operates as follows:
 - When a peak over-range occurs, the measurement range increases to the range specified here, skipping the ranges in between.
 - When the measurement range to switch to when a peak over-range occurs has not been selected, the measurement range increases in the order of the specified valid measurement ranges.

Setting a Valid Measurement Range for Voltage

5. Tap **Valid Measurement Range**. A valid voltage range setup screen appears.

By tapping an input element or wiring unit, you can set all ranges as valid measurement ranges (All ON).

If the measurement range to switch to when a peak over-range occurs has been selected, the range background is displayed in gray.

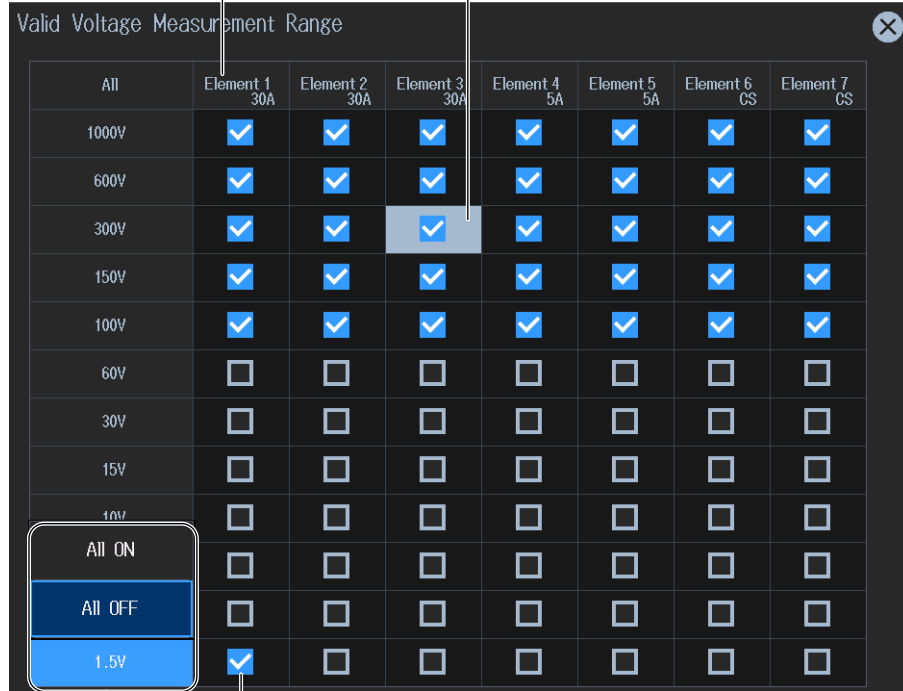

Valid measurement range

- The measurement range switches (in order) between the selected ranges.
- Ranges that are not selected are skipped.
- When Range Σ Link (see section 2.1) is set to ON, the input elements that are assigned to the same wiring unit are set to the same status.

By tapping each range display, you can collectively set or not set the applicable ranges of all input elements or wiring units as valid measurement ranges (All ON or All OFF).

Setting the Valid Current Measurement Range (Current)

4. Tap **Current**. A valid current measurement range setup screen appears.

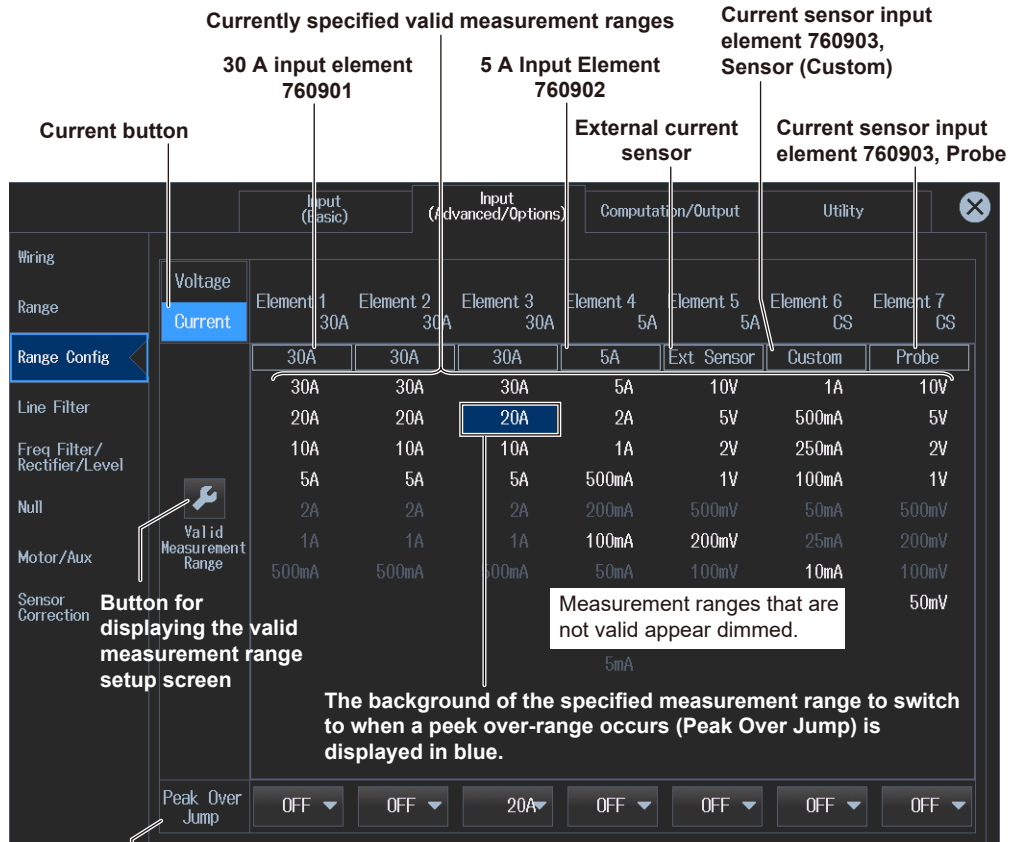

Specify the measurement range to switch to when a peak over-range occurs.

30 A input element 760901
(OFF, 30A, 20A, 10A, 5A, 2A, 1A, 500mA)

5 A input element 760902
(OFF, 5A, 2A, 1A, 500mA, 200mA, 100mA, 50mA, 20mA, 10mA, 5mA)

Input element 760901 or 760902 with external current sensor:
(OFF, 10V, 5V, 2V, 1V, 500mV, 200mV, 100mV, 50mV)

Current sensor input element 760903:
When Terminal (see section 2.2) is set to Sensor, the options vary depending on the CT type.
For the current range options, see **“Current Range (Current, CURRENT RANGE)”** in the features guide.

When Terminal is set to Probe,
(OFF, 10V, 5V, 2V, 1V, 500mV, 200mV, 100mV, 50mV)

- When Range Σ Link is set to on (see section 2.1), the input elements that are assigned to the same wiring unit are set to the same range.
- If auto range is on (you can turn it on by pressing AUTO), the instrument operates as follows:
 - When a peak over-range occurs, the measurement range increases to the range specified here, skipping the ranges in between.
 - When the measurement range to switch to when a peak over-range occurs has not been selected, the measurement range increases in the order of the specified valid measurement ranges.

Setting Valid Measurement Ranges for Current (30 A input element example)

5. Tap **Valid Measurement Range**. A valid current range setup screen appears.

Select the item to set the current range of (Terminal in Use, Direct/Sensor, Ext Sensor/Probe).

If the measurement range to switch to when a peak over-range occurs has been selected, the range background is displayed in gray.

Setting Object	30A	30A	30A	5A	5A	Custom	Others
Terminal in Use	Ext. Sensor	Ext. Sensor	Ext. Sensor	Ext. Sensor	Ext. Sensor	Probe	Probe
All	Element 1 30A	Element 2 30A	Element 3 30A	Element 4 5A	Element 5 5A	Element 6 CS	Element 7 CS
*	<input checked="" type="checkbox"/> 30A	<input checked="" type="checkbox"/> 30A	<input checked="" type="checkbox"/> 30A	<input checked="" type="checkbox"/> 5A	<input checked="" type="checkbox"/> 10V	<input checked="" type="checkbox"/> 1A	<input checked="" type="checkbox"/> 10V
*	<input checked="" type="checkbox"/> 20A	<input checked="" type="checkbox"/> 20A	<input checked="" type="checkbox"/> 20A	<input checked="" type="checkbox"/> 2A	<input checked="" type="checkbox"/> 5V	<input checked="" type="checkbox"/> 500mA	<input checked="" type="checkbox"/> 5V
*	<input checked="" type="checkbox"/> 10A	<input checked="" type="checkbox"/> 10A	<input checked="" type="checkbox"/> 10A	<input checked="" type="checkbox"/> 1A	<input checked="" type="checkbox"/> 2V	<input checked="" type="checkbox"/> 250mA	<input checked="" type="checkbox"/> 2V
*	<input checked="" type="checkbox"/> 5A	<input checked="" type="checkbox"/> 5A	<input checked="" type="checkbox"/> 5A	<input checked="" type="checkbox"/> 500mA	<input checked="" type="checkbox"/> 1V	<input checked="" type="checkbox"/> 100mA	<input checked="" type="checkbox"/> 1V
*	<input type="checkbox"/> 2A	<input type="checkbox"/> 2A	<input type="checkbox"/> 2A	<input type="checkbox"/> 200mA	<input type="checkbox"/> 500mV	<input type="checkbox"/> 50mA	<input type="checkbox"/> 500mV
*	<input type="checkbox"/> 1A	<input type="checkbox"/> 1A	<input type="checkbox"/> 1A	<input checked="" type="checkbox"/> 100mA	<input checked="" type="checkbox"/> 200mV	<input type="checkbox"/> 25mA	<input type="checkbox"/> 200mV
*	<input checked="" type="checkbox"/> 500mA	<input type="checkbox"/> 500mA	<input type="checkbox"/> 500mA	<input type="checkbox"/> 50mA	<input type="checkbox"/> 100mV	<input checked="" type="checkbox"/> 10mA	<input checked="" type="checkbox"/> 100mV
	-	-	-	<input type="checkbox"/> 20mA	<input type="checkbox"/> 50mV	-	<input checked="" type="checkbox"/> 50mV
	-	-	-	<input type="checkbox"/> 10mA	-	-	-
	-	-	-	<input type="checkbox"/> 5mA	-	-	-

Valid measurement range

- The measurement range switches (in order) between the selected ranges.
- Ranges that are not selected are skipped.
- When Range Σ Link (see section 2.1) is set to ON, the input elements that are assigned to the same wiring unit are set to the same status.

By tapping the asterisk of each range, you can collectively set or not set the applicable ranges of all input elements or wiring units as valid measurement ranges (All ON or All OFF).

2.6 Setting the Sensor Correction

► “Sensor Correction (Sensor Correction)” in the features guide

This section explains operating procedures using the following setup methods.

- Procedure Using the Setup Menu (see chapter 1)
- Procedure Using the Menu Icons (see page xiv)

Procedure Using the Setup Menu

1. Tap the **Setup** icon  or press **MENU** under **SETUP**.
2. Tap the **Input (Advanced/Options)** tab. An input settings (advanced/options) overview screen appears.
Pressing **ESC** closes the overview screen.
3. Tap **Sensor Correction**. A sensor correction setup screen appears.

Sensor Correction button

By tapping the item names in the left edge, you can collectively set all input elements (except the Time Difference between I/O item at the bottom).

Input (Advanced/Options) tab

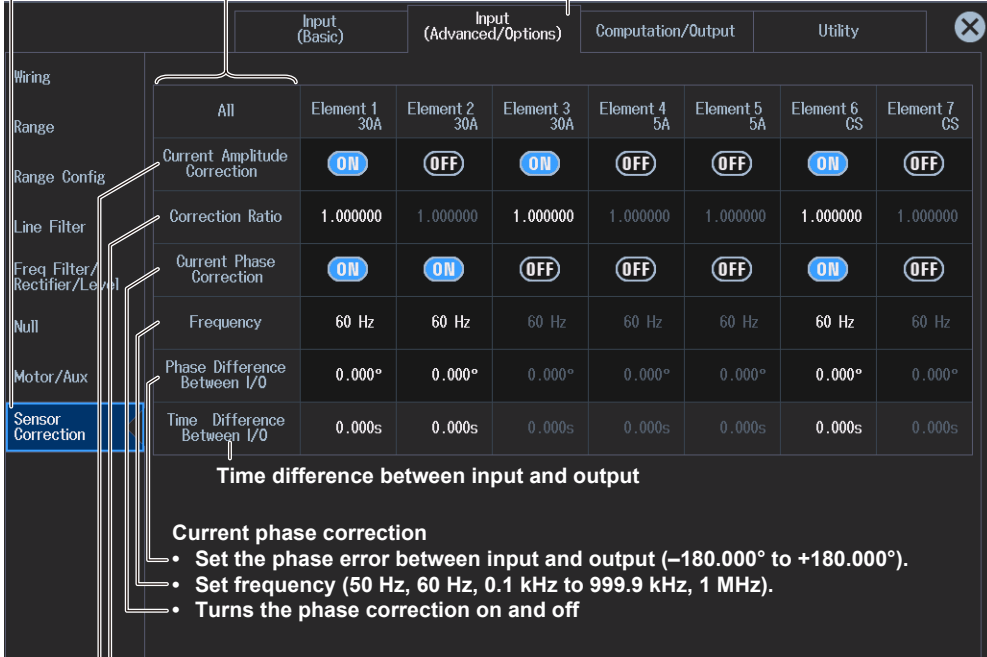

	All	Element 1 30A	Element 2 30A	Element 3 30A	Element 4 5A	Element 5 5A	Element 6 CS	Element 7 CS
Current Amplitude Correction	<input checked="" type="checkbox"/>	<input type="checkbox"/>	<input type="checkbox"/>	<input checked="" type="checkbox"/>	<input type="checkbox"/>	<input type="checkbox"/>	<input checked="" type="checkbox"/>	<input type="checkbox"/>
Correction Ratio	1.000000	1.000000	1.000000	1.000000	1.000000	1.000000	1.000000	1.000000
Current Phase Correction	<input checked="" type="checkbox"/>	<input checked="" type="checkbox"/>	<input type="checkbox"/>	<input type="checkbox"/>	<input type="checkbox"/>	<input type="checkbox"/>	<input checked="" type="checkbox"/>	<input type="checkbox"/>
Frequency	60 Hz	60 Hz	60 Hz	60 Hz	60 Hz	60 Hz	60 Hz	60 Hz
Phase Difference Between I/O	0.000°	0.000°	0.000°	0.000°	0.000°	0.000°	0.000°	0.000°
Time Difference Between I/O	0.000s	0.000s	0.000s	0.000s	0.000s	0.000s	0.000s	0.000s

Time difference between input and output

Current phase correction

- Set the phase error between input and output (-180.000° to $+180.000^\circ$).
- Set frequency (50 Hz, 60 Hz, 0.1 kHz to 999.9 kHz, 1 MHz).
- Turns the phase correction on and off

Current amplitude correction

- Set the correction ratio (0.800000 to 1.200000).
- Turns current amplitude correction on and off

Note

You can also display the input settings (advanced/options) overview screen by moving the cursor on the Input (Advanced/Options) tab using the arrow keys and then pressing SET.

Procedure Using the Menu Icons

You can also use the menu icons shown on the right side of the screen to set the sensor correction.

1. Tap the **Misc** menu icon . A Misc menu appears in the sub menu area on the right side of the screen.

By tapping the displayed items, you can specify the same settings as when using the screen explained earlier.

Note

For details on the Misc menu, see page xiv.

2.7 Setting the Line Filter and Frequency Filter

► “Line Filter (Line Filter)” in the features guide

► “Frequency Filter, Rectifier, Level (Freq Filter/Rectifier/Level)” in the features guide

This section explains operating procedures using the following setup methods.

- Procedure Using the Setup Menu (see chapter 1)
- Procedure Using the Menu Icons (see page iii)

Depending on the measurement mode or the method of computing measurement values (computing method), the settings may be different from the description in this section, the settings may be invalid, or the settings may not be configurable. For details, see the features guide.

Procedure Using the Setup Menu

1. Tap the **Setup** icon , or press **MENU** under **SETUP**.

Setting the Line Filter and Frequency Filter (Cutoff)

2. Tap the **Input (Basic)** tab. An input settings (basic measurement conditions) overview screen appears.

Pressing **ESC** closes the overview screen.



Set the line filter.

Set the frequency filter.

Note

You can also display the input settings (basic measurement conditions) overview screen by moving the cursor on the Input (Basic) tab using the arrow keys and then pressing **SET**.

Setting the Line Filter (Line Filter)

3. Tap **Line Filter**. A line filter setup screen appears.

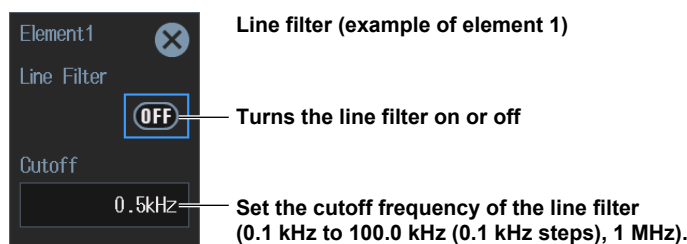

2.7 Setting the Line Filter and Frequency Filter

Setting the Frequency Filter (Freq Filter)

3. Tap **Freq Filter**. A frequency filter setup screen appears.

Frequency filter (example of element 1)

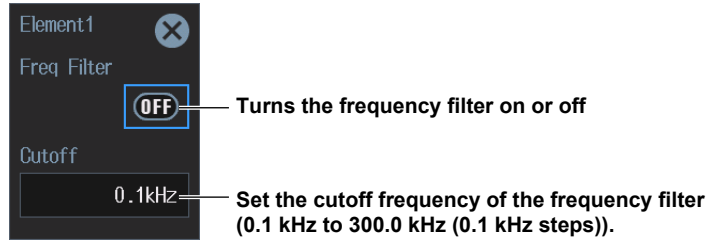

Setting the Line Filter and Frequency Filter (Advanced Settings)

2. Tap the **Input (Advanced/Options)** tab. An input settings (advanced/options) overview screen appears.
Pressing **ESC** closes the overview screen.

Setting the Line Filter (Line Filter)

3. Tap **Line Filter**. A line filter setup screen appears.

- **When Line Filter Advanced Settings Is Set to OFF**

You can set the cutoff frequency and filter type.

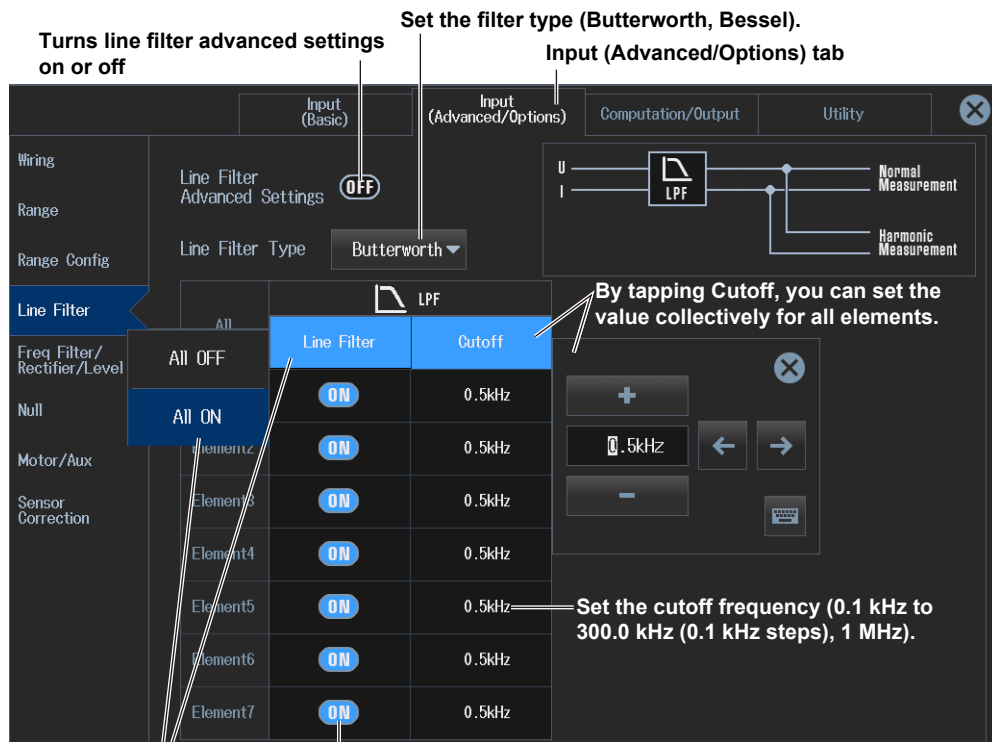

• **When Line Filter Advanced Settings Is Set to ON**

You can set the following filters separately.

- AAF (anti-aliasing filter)
- DLF (N) (normal measurement line filter)
- DLF(H) (harmonics line filter)

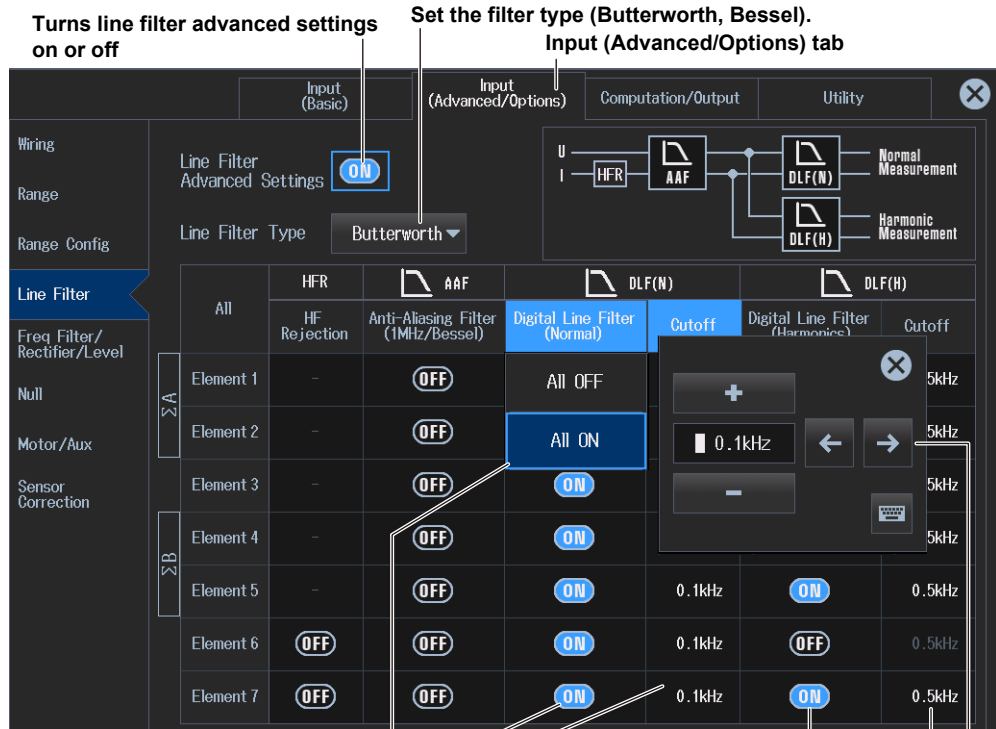

By tapping HF Rejection (input element 760903 only), Anti-Aliasing Filter, Digital Line Filter (Normal), or Digital Line Filter (Harmonics), you can turn on or off the function on all elements collectively.

Turns the digital line filter (for normal measurement) on and off

Set the cutoff frequency of the digital line filter (for normal measurement) (0.1 kHz to 300.0 kHz (0.1 kHz steps)).

Turns the digital line filter (for harmonic measurement) on and off

Set the cutoff frequency of the digital line filter (for harmonic measurement) (0.1 kHz to 300.0 kHz (0.1 kHz steps)).

By tapping Cutoff, you can set the value collectively for all elements.

2.7 Setting the Line Filter and Frequency Filter

Setting the Frequency Filter (Sync Source/Freq Measurement)

3. Tap **Freq Filter/Rectifier/Level**. A frequency filter setup screen appears.
4. Tap **Sync Source/Freq Measurement**. A Sync Source/Freq Measurement (sync source/frequency measurement) screen appears.

- **When Freq Filter Advanced Settings Is Set to OFF**

You can set the cutoff frequency of the low-pass filter (LPF).

Set sync source and frequency measurement.

Turns freq filter advanced settings on or off

Input (Advanced/Options) tab

	HPF	Freq Filter (0.1kHz)	LPF	Cutoff
All	<input checked="" type="checkbox"/>	All OFF	<input type="checkbox"/>	0.
Element1	<input checked="" type="checkbox"/>	All ON	<input type="checkbox"/>	0.
Element2	<input checked="" type="checkbox"/>	<input type="checkbox"/>	<input type="checkbox"/>	0.
Element3	<input checked="" type="checkbox"/>	<input type="checkbox"/>	<input type="checkbox"/>	0.
Element4	<input checked="" type="checkbox"/>	<input type="checkbox"/>	<input type="checkbox"/>	0.
Element5	<input checked="" type="checkbox"/>	<input type="checkbox"/>	<input type="checkbox"/>	0.1kHz
Element6	<input checked="" type="checkbox"/>	<input type="checkbox"/>	<input type="checkbox"/>	0.1kHz
Element7	<input checked="" type="checkbox"/>	<input type="checkbox"/>	<input type="checkbox"/>	0.1kHz

By tapping Cutoff, you can set the value collectively for all elements.

The high-pass filter (HPF) is fixed to on.

Set the cutoff frequency of the low-pass filter (LPF) (0.1 kHz to 300.0 kHz (0.1 kHz steps)).

By tapping Freq Filter, you can turn on or off the feature on all elements collectively.

Turns the low-pass filter (LPF) on or off

• **When Freq Filter Advanced Settings Is Set to ON**

You can set the following filters and items separately.

- High-pass filter (HPF)
- Rectifier (Rectifier)
- Low-pass filter (LPF)
- Cross level (Level)

Turns freq filter advanced settings on or off

Sync Source/Freq
Configure the measurement.

Input (Advanced/Options) tab

By tapping Cutoff, you can set the value collectively for all elements.

Line Filter	All	HPF	Rectifier	LPF	Level			
Freq Filter/Rectifier/Level	Freq Filter	Cutoff	Voltage	Current	Freq Filter	Cutoff	Voltage	Current
Element1	All OFF	ON	ON	ON	ON	0.1kHz	0.0%	0.0%
Element2	All ON	ON	ON	ON	ON	0.1kHz	0.0%	0.0%
Element3	ON	0.1Hz	ON	ON	ON	0.1kHz	0.0%	0.0%
Element4	ON	0.1Hz	ON	ON	ON	0.1kHz	0.0%	0.0%
Element5	ON	0.1Hz	ON	ON	ON	0.1kHz	0.0%	0.0%
Element6	ON	0.1Hz	ON	ON	ON	0.1kHz	0.0%	0.0%
Element7	ON	0.1Hz	ON	ON	ON	0.1kHz	0.0%	0.0%

Turns the high-pass filter (HPF) on or off

By tapping Freq Filter, you can turn on or off the feature on all elements collectively.

See section 2.8.

Turns the low-pass filter (LPF) on or off

Set the cutoff frequency of the low-pass filter (LPF) (0.1 kHz to 300.0 kHz (0.1 kHz steps)).

Set the cutoff frequency of the high-pass filter (HPF) (0.1 Hz, 1 Hz, 10 Hz, 0.1 kHz to 100.0 kHz (0.1 kHz steps)).

2.7 Setting the Line Filter and Frequency Filter

Second Frequency Measurement Settings (Freq2 Measurement)

3. Tap **Freq Filter/Rectifier/Level**. A frequency filter setup screen appears.
4. Tap **Freq2 Measurement**. A Freq2 Measurement (second frequency measurement) screen appears.

By tapping **Cutoff**, **Voltage Level (Freq2)**, or **Current Level (Freq2)**, you can set the value collectively for all elements.

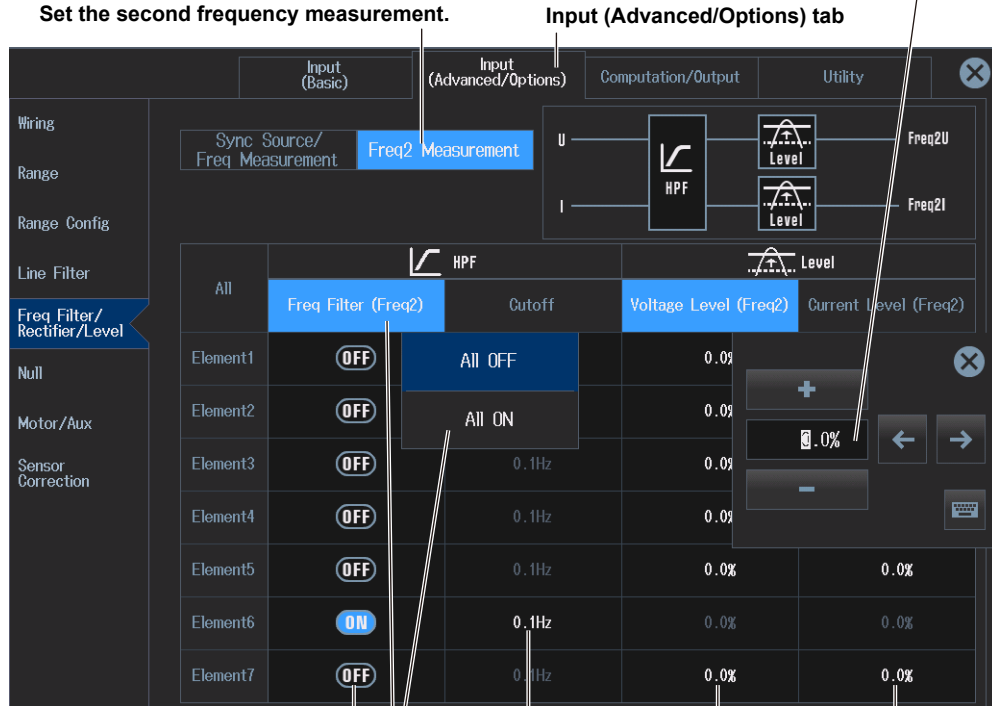

Turns the high-pass filter (HPF) on or off

By tapping **Freq Filter (Freq2)**, you can turn on or off the feature on all elements collectively.

Set the cutoff frequency of the high-pass filter (HPF) (0.1 Hz, 1 Hz, 10 Hz, 0.1 kHz to 100.0 kHz (0.1 kHz steps)).

Set the voltage cross level (0.0% to 100.0%(0.1% steps)).

Set the current cross level (0.0% to 100.0%(0.1% steps)).

You can use the voltage and current cross level settings when the high-pass filter (HPF) is set to OFF.

Procedure Using the Menu Icons

You can also use the menu icons shown on the right side of the screen to set the line filter and frequency filter.

1. Tap the **Filter** menu icon . A Filter menu appears in the sub menu area on the right side of the screen.

By tapping the displayed items, you can specify the same settings as when using the keys explained earlier.

Note

For details on the Filter menu, see page x.

2.8 Set the Measurement Period

► “Measurement Period (Sync Source)” in the features guide

This section explains operating procedures using the following setup methods.

- Procedure Using the Setup Menu (see chapter 1)

Depending on the measurement mode or the method of computing measurement values (computing method), the settings may be different from the description in this section, the settings may be invalid, or the settings may not be configurable. For details, see the features guide.

Procedure Using the Setup Menu

1. Tap the **Setup** icon , or press **MENU** under **SETUP**.
2. Tap the **Input (Basic)** tab. An input settings (basic measurement conditions) overview screen appears.

Pressing **ESC** closes the overview screen.

Input (Basic) tab

Element 1 30A	Element 2 30A	Element 3 30A	Element 4 5A	Element 5 5A	Element 6 CS	Element 7 CS
Wiring 1P2W	Wiring 1P2W	Wiring 1P2W	Wiring 1P2W	Wiring 1P2W	Wiring 1P2W	Wiring 1P2W
Voltage Range 1000V	Voltage Range 1000V	Voltage Range 1000V	Voltage Range 1000V	Voltage Range 1000V	Voltage Range 1000V	Voltage Range 1000V
Current Range 30A	Current Range 30A	Current Range 30A	Current Range 5A	Current Range 5A	Current Range 1A	Current Range 1A
Ratio [mV/A] 10.0000	Ratio [mV/A] 10.0000	Ratio [mV/A] 10.0000	Ratio [mV/A] 10.0000	Ratio [mV/A] 10.0000	CT Preset Custom	CT Preset Custom
Scaling OFF	Scaling OFF	Scaling OFF	Scaling OFF	Scaling OFF	Scaling OFF	Scaling OFF
VT Ratio 1.0000	VT Ratio 1.0000	VT Ratio 1.0000	VT Ratio 1.0000	VT Ratio 1.0000	VT Ratio 1.0000	VT Ratio 1.0000
CT Ratio 1.0000	CT Ratio 1.0000	CT Ratio 1.0000	CT Ratio 1.0000	CT Ratio 1.0000	CT Ratio 1.0000	CT Ratio 1.0000
SF Ratio 1.0000	SF Ratio 1.0000	SF Ratio 1.0000	SF Ratio 1.0000	SF Ratio 1.0000	SF Ratio 1.0000	SF Ratio 1.0000
Line Filter Cutoff OFF 0.5kHz	Line Filter Cutoff OFF 0.5kHz	Line Filter Cutoff OFF 0.5kHz	Line Filter Cutoff OFF 0.5kHz	Line Filter Cutoff OFF 0.5kHz	Line Filter Cutoff OFF 0.5kHz	Line Filter Cutoff OFF 0.5kHz
Freq Filter Cutoff OFF 0.1kHz	Freq Filter Cutoff OFF 0.1kHz	Freq Filter Cutoff OFF 0.1kHz	Freq Filter Cutoff OFF 0.1kHz	Freq Filter Cutoff OFF 0.1kHz	Freq Filter Cutoff OFF 0.1kHz	Freq Filter Cutoff OFF 0.1kHz
Sync Source I1	Sync Source I2	Sync Source I3	Sync Source I4	Sync Source I5	Sync Source I6	Sync Source I7

Set the Sync Source.

If the computing method (Measurement Method) of the data update interval setup screen (see section 2.10) is set to Digital Filter Average, the menu appears dimmed as shown in the following figure and cannot be used.

Sync Source I1	Sync Source I2	Sync Source I3	Sync Source I4	Sync Source I5	Sync Source I6	Sync Source I7
----------------	----------------	----------------	----------------	----------------	----------------	----------------

Note

You can also display the input settings (basic measurement conditions) overview screen by moving the cursor on the Input (Basic) tab using the arrow keys and then pressing SET.

Setting the Sync Source (Sync Source)

3. Tap **Sync Source**. A sync source setup screen appears.

Sync source (example of element 1)



Set the sync source (U1 to U7, I1 to I7, Ext Clk, Z Phase1 (Ch D), Z Phase3 (Ch H), None).

Setting the Cross Level (Level)

4. Tap the **Input (Advanced/Options)** tab. An input settings (advanced/options) overview screen appears.
Pressing **ESC** closes the overview screen.
5. Tap **Freq Filter/Rectifier/Level**. A frequency filter setup screen appears.
6. Tap **Sync Source/Freq Measurement**. A Sync Source/Freq Measurement (sync source/frequency measurement) screen appears.

Turns freq filter advanced settings on or off
Sync Source/Freq Configure the measurement.

Input (Advanced/Options) tab

By tapping Voltage or Current, you can set the value collectively for all elements.

	HPF		Rectifier		LPF		Level	
	Freq Filter	Cutoff	Voltage	Current	Freq Filter	Cutoff	Voltage	Current
Element1	OFF	All OFF	ON				0.0%	0.0%
Element2	OFF	All ON	ON				0.0%	0.0%
Element3	OFF	0.1Hz	ON				0.0%	0.0%
Element4	OFF	0.1Hz	ON				0.0%	0.0%
Element5	OFF	0.1Hz	ON	ON	OFF	0.1kHz	0.0%	0.0%
Element6	OFF	0.1Hz	ON	ON	OFF	0.1kHz	0.0%	0.0%
Element7	OFF	0.1Hz	ON	ON	OFF	0.1kHz	0.0%	0.0%

By tapping Voltage or Current, you can turn on or off the feature on all elements collectively.

Turns the voltage rectifier on or off
Turns the current rectifier on or off

Set the voltage or current cross level.
When the rectifier feature is off: -100.0% to 100.0%, in 0.1% steps
When the rectifier feature is on: 0.0% to 100.0%, in 0.1% steps
You can use the voltage and current cross level settings when the high-pass filter (HPF) is set to OFF or when the rectifier feature is set to ON.

2.9 Setting the Crest Factor

► “Crest Factor (Crest Factor)” in the features guide

This section explains operating procedures using the following setup methods.

- Procedure Using the Setup Menu (see chapter 1)

Procedure Using the Setup Menu

1. Tap the **Setup** icon , or press **MENU** under **SETUP**.
2. Tap the **Input (Advanced/Options)** tab. An input settings (advanced/options) overview screen appears.
Pressing **ESC** closes the overview screen.

Crest factor (Crest Factor)

3. Tap **Range**. A setup screen appears for common measurement range items.

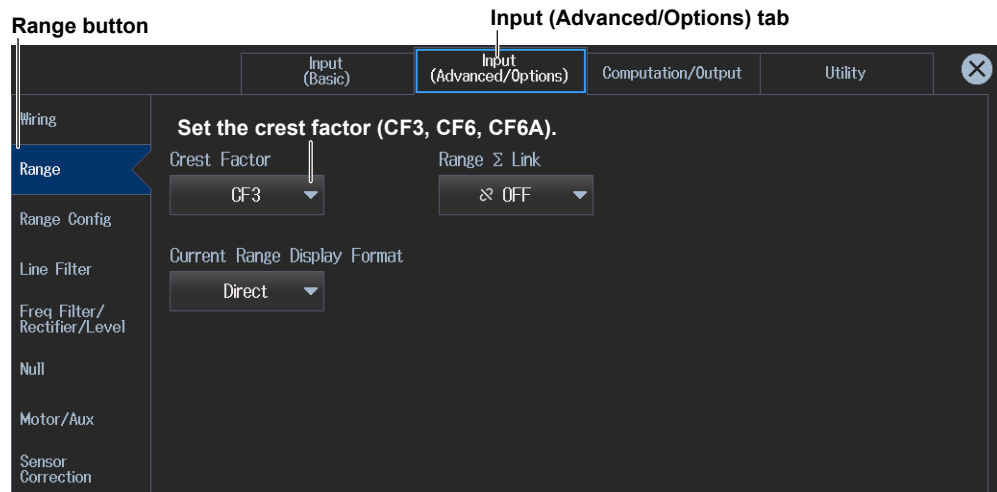

Note

You can also display the input settings (advanced/options) overview screen by moving the cursor on the Input (Advanced/Options) tab using the arrow keys and then pressing SET.

2.10 Setting the Data Update Interval

► “Data Update Interval (Update Rate)” in the features guide

This section explains operating procedures using the following setup methods.

- Procedure Using the Setup Menu (see chapter 1)
- Procedure Using the Menu Icons (see page iii)

Depending on the measurement mode or the method of computing measurement values (computing method), the settings may be different from the description in this section, the settings may be invalid, or the settings may not be configurable. For details, see the features guide.

Procedure Using the Setup Menu

1. Tap the **Setup** icon  or press **MENU** under **SETUP**.
2. Tap **Computation/Output** tab. A computation and output settings overview screen appears. Pressing **ESC** closes the overview screen.

Setting the Data Update Interval (Update Rate)

3. Tap **Update Rate/Averaging**. A drop-down list for setting the interval appears.
- **When the Update Mode Is Set to Constant**

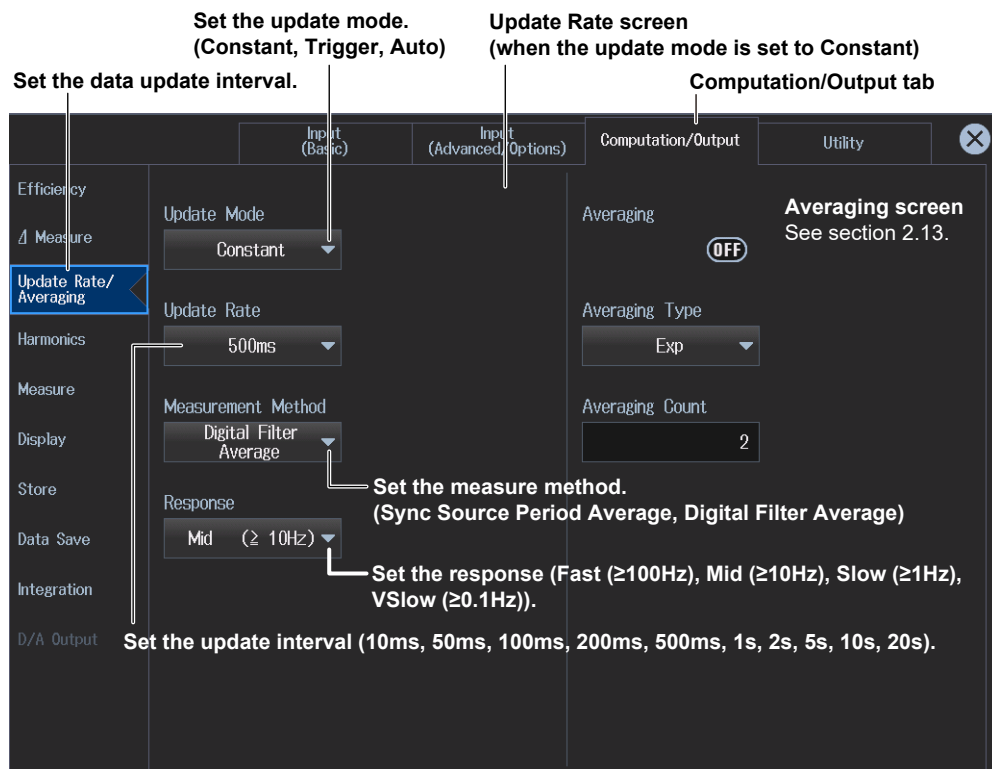

Note

You can also display the computation/output settings overview screen by moving the cursor on the Computation/Output tab using the arrow keys and then pressing SET.

- When the Update Mode Is Set to Trigger

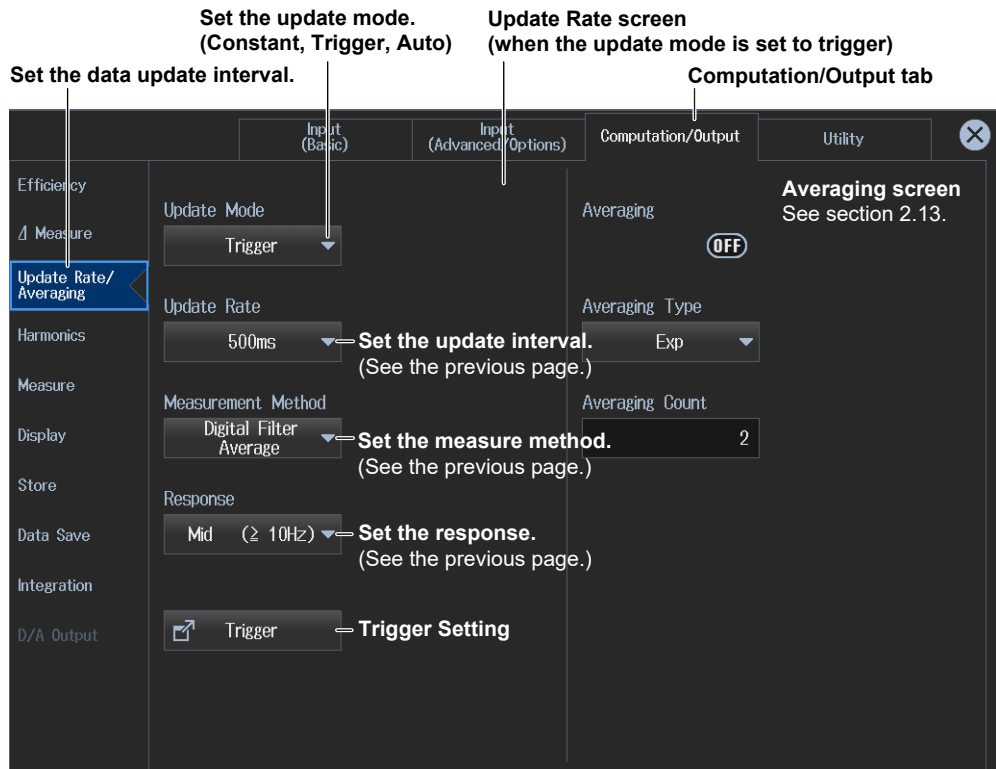

Trigger Setting

Trigger Setting

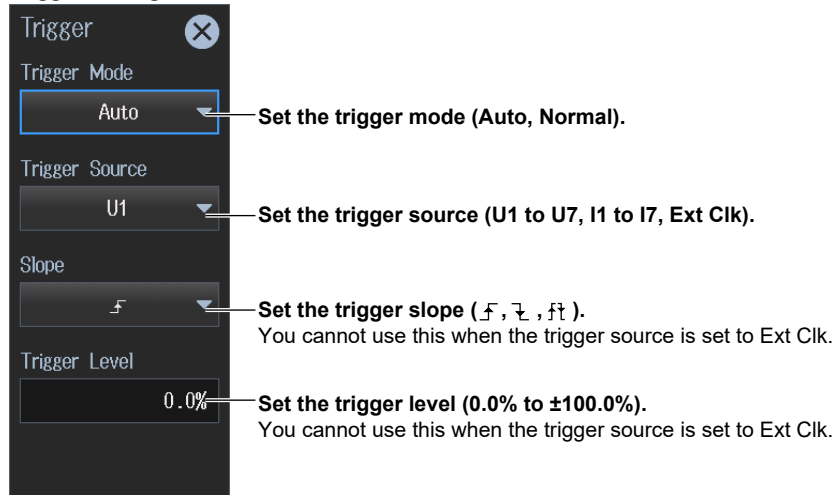

2.10 Setting the Data Update Interval

- When the Update Mode Is Set to Auto

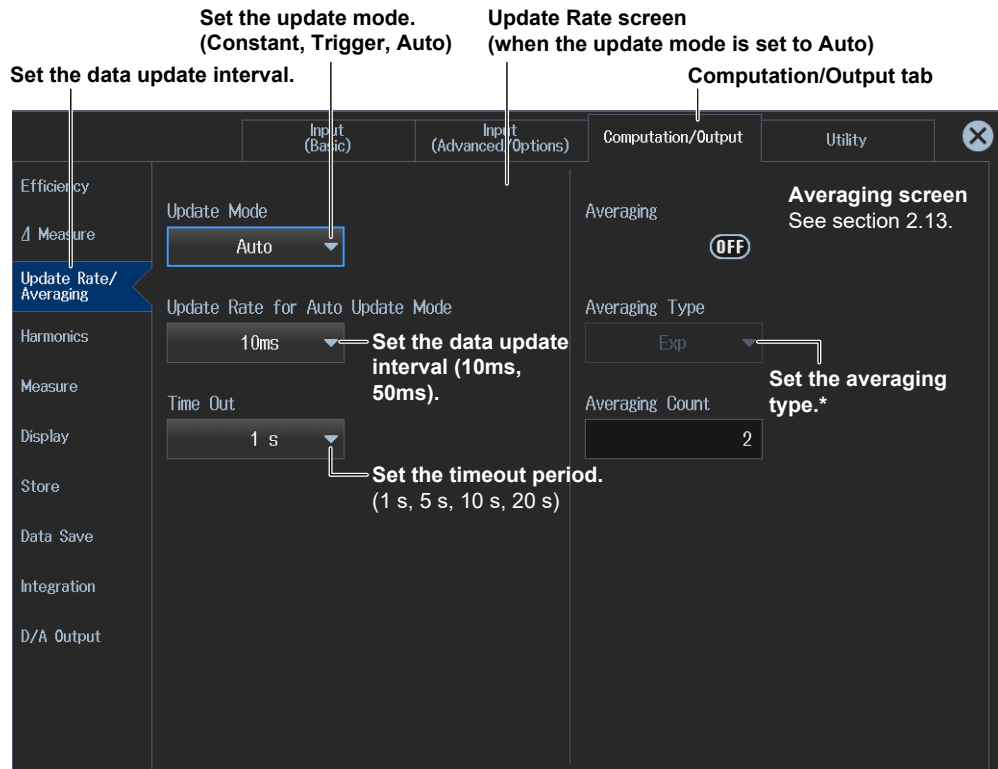

* When the update mode is Auto, the only available averaging type is Exp.

Procedure Using the Menu Icons

You can also use the menu icons shown on the right side of the screen to set the data update interval.

1. Tap the **Update Rate/Averaging** menu icon . An Update Rate./Averaging menu appears in the sub menu area on the right side of the screen.

By tapping the displayed items, you can specify the same settings as when using the keys explained earlier.

Note

- For details on the Update Rate/Averaging menu, see page ix.
- When the trigger source is set to Ext Clk, you cannot set the trigger slope (↴ fixed to falling).

2.11 Setting the Efficiency Equation

► “Efficiency Equation (Efficiency)” in the features guide

This section explains operating procedures using the following setup methods.

- Procedure Using the Setup Menu (see chapter 1)

Procedure Using the Setup Menu

1. Tap the **Setup** icon , or press **MENU** under **SETUP**.
2. Tap **Computation/Output** tab. A computation and output settings overview screen appears. Pressing **ESC** closes the overview screen.

Setting the Efficiency Equation (Efficiency)

3. Tap **Efficiency**. An efficiency equation setup screen appears.

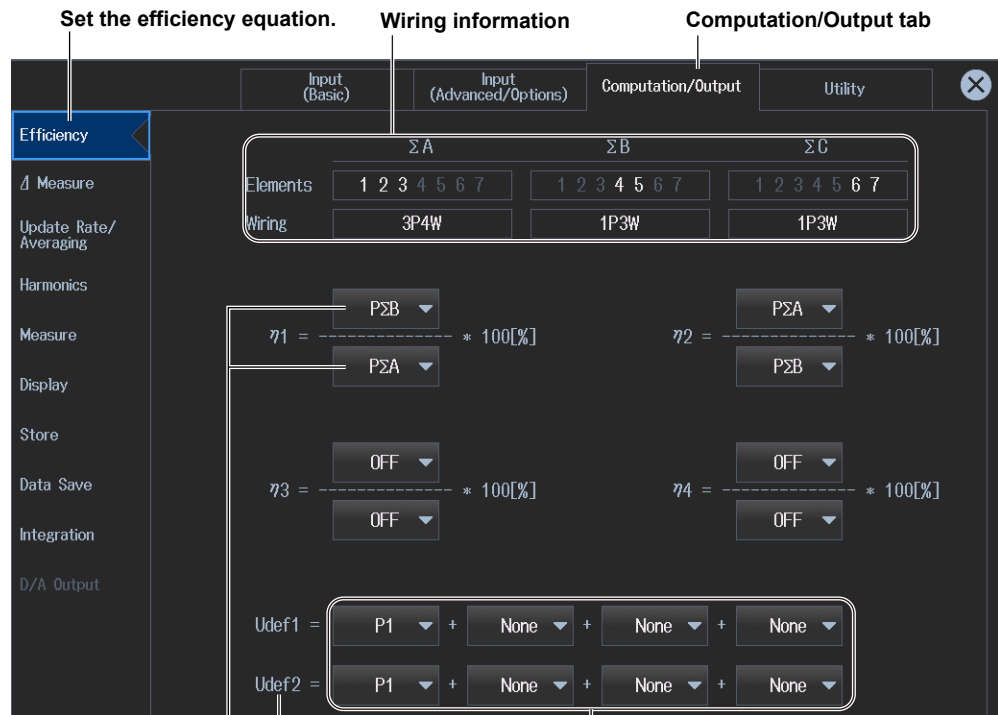

Define Udef1 and Udef2
(P1 to P7¹, PΣA to PΣC², Pm1 to Pm4³)

To add active powers and motor output and use them in efficiency equations, use Udef1 and Udef2.

Set the denominator and numerator of the efficiency equation to the active power and motor power measurement functions.

(P1 to P7¹, PΣA to PΣC², Pm1 to Pm4³, Udef1, Udef2)

You can set up to four equations: η1 to η4.

- 1 Can be set within the range of the installed input elements.
- 2 Can be set within the range of the wiring unit that is automatically determined by the installed input elements.
- 3 You can set this on models with the /MTR1 or /MTR2 option.

Note

You can also display the computation/output settings overview screen by moving the cursor on the Computation/Output tab using the arrow keys and then pressing SET.

2.12 Setting the Delta Computation

► “Delta Computation (Δ Measure)” in the features guide

This section explains operating procedures using the following setup methods.

- Procedure Using the Setup Menu (see chapter 1)

Procedure Using the Setup Menu

1. Tap the **Setup** icon  or press **MENU** under SETUP.
2. Tap **Computation/Output** tab. A computation and output settings overview screen appears. Pressing **ESC** closes the overview screen.

Setting Delta Computation (Δ Measure)

3. Tap **Δ Measure**. A delta computation setup screen appears.

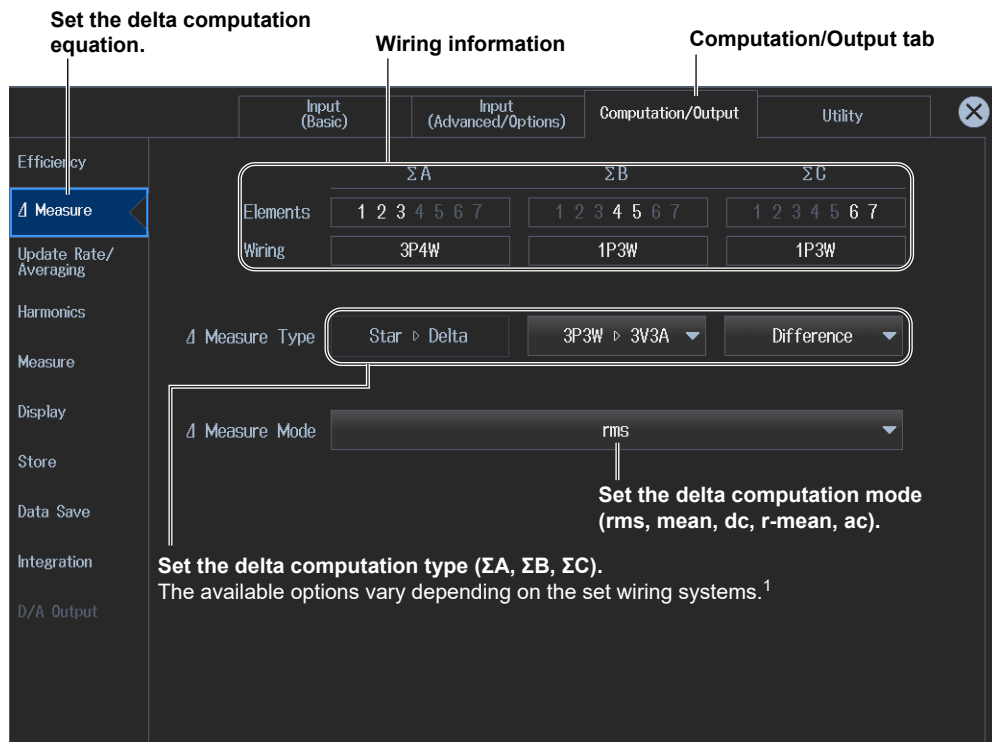

1 Delta computation type

Wiring System	Delta Computation Type
1P3W	Difference, 3P3W>3V3A
3P3W	Difference, 3P3W>3V3A
3P4W	Star>Delta
3P3W(3V3A)	Delta>Star
3P3W(3V3AR)	Delta>Star

Note

You can also display the computation/output settings overview screen by moving the cursor on the Computation/Output tab using the arrow keys and then pressing SET.

2.13 Setting Averaging

► “Averaging (Averaging)” in the features guide

This section explains operating procedures using the following setup methods.

- Procedure Using the Setup Menu (see chapter 1)

Depending on the measurement mode or the method of computing measurement values (computing method), the settings may be different from the description in this section, the settings may be invalid, or the settings may not be configurable. For details, see the features guide.

Procedure Using the Setup Menu

1. Tap the **Setup** icon , or press **MENU** under SETUP.
2. Tap **Computation/Output** tab. A computation and output settings overview screen appears. Pressing **ESC** closes the overview screen.

Setting Averaging (Averaging)

3. Tap **Update Rate/Averaging**.
A data update interval/averaging setup screen appears.

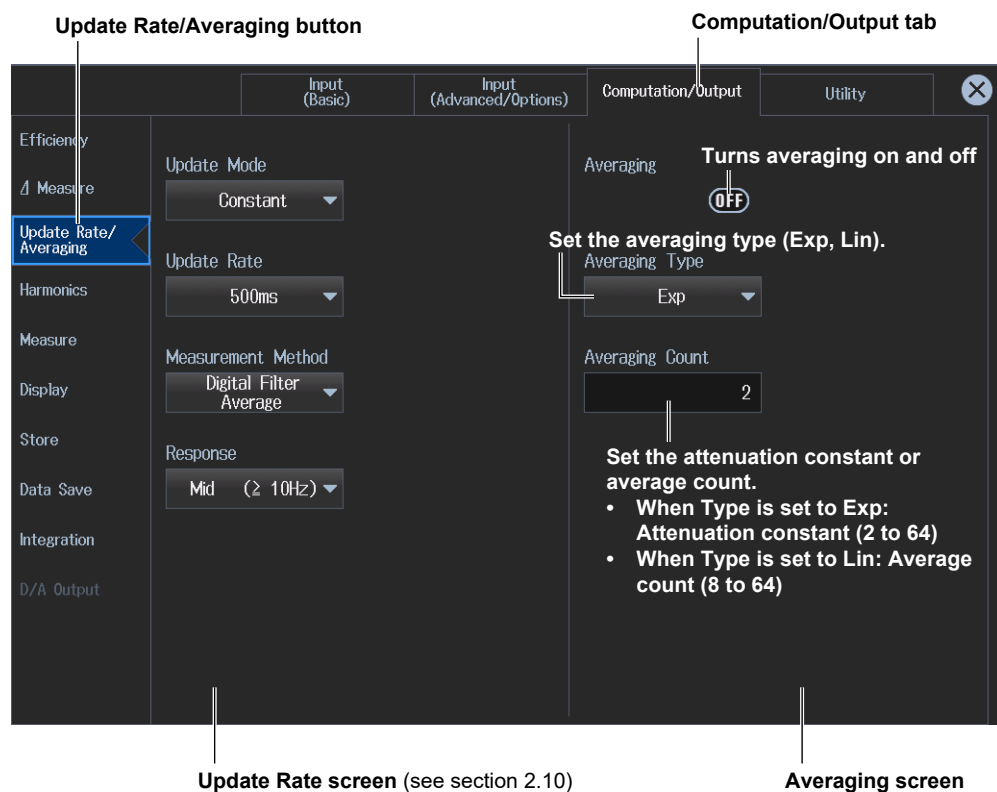

Note

- You can also display the computation/output settings overview screen by moving the cursor on the Computation/Output tab using the arrow keys and then pressing SET.
- When the update mode is Auto, the averaging type is fixed to Exp.

2.14 Master/slave Synchronous Measurement

► “Master/Slave Synchronous Measurement (Sync Measure)” in the features guide

This section explains operating procedures using the following setup methods.

- Procedure Using the Setup Menu (see chapter 1)

Procedure Using the Setup Menu

1. Tap the **Setup** icon  or press **MENU** under SETUP.
2. Tap **Computation/Output** tab. A computation and output settings overview screen appears. Pressing **ESC** closes the overview screen.

Setting the Master and Slave (Sync Measure)

3. Tap **Measure**.
An equation (computation) setup screen appears.

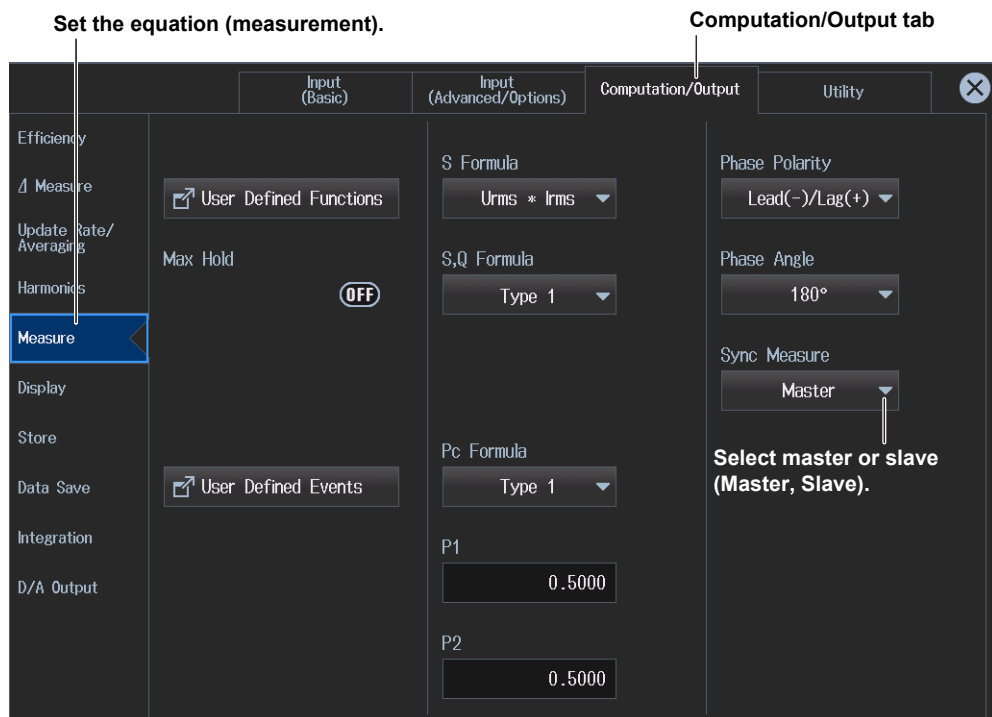

Note

You can also display the computation/output settings overview screen by moving the cursor on the Computation/Output tab using the arrow keys and then pressing SET.

3.1 Setting the Display Format

- ▶ “Display (Display)” in the features guide
- ▶ “Numeric Data Display (NUMERIC)” in the features guide
- ▶ “Switching the Displayed Page (Page Scroll)” in the features guide
 - ▶ “All display (All Items)” in the features guide
- ▶ “4-, 8-, and 16-Value Displays (4 Items/8 Items/16 Items)” in the features guide
 - ▶ “Matrix display (Matrix)” in the features guide
- ▶ “Display Items (Items, Numeric)” in the features guide

This section explains operating procedures using the following setup methods.

- Procedure Using the Setup Menu (see chapter 1)
- Procedure Using the Menu Icons (see page iii)
- Procedure Using the Keys (other than SETUP) (see section 1.2 in IM WT5000-03EN)

Depending on the measurement mode or the method of computing measurement values (computing method), the settings may be different from the description in this section, the settings may be invalid, or the settings may not be configurable. For details, see the features guide.

Procedure Using the Setup Menu

1. Tap the **Setup** icon , or press **MENU** under SETUP.
2. Tap **Computation/Output** tab. A computation and output settings overview screen appears. Pressing **ESC** closes the overview screen.

Setting the Display Format (Display)

3. Tap **Display**.
A display format setup screen appears.

Set the numeric display format
(All Items, 4 Items, 8 Items, 16 Items, Matrix, Hrm List Single, Hrm List Dual, User).
 Set how many measurement results to display in a single screen.
 For Hrm List Single and Hrm List Dual, see section 5.2. For User, see section 3.7.

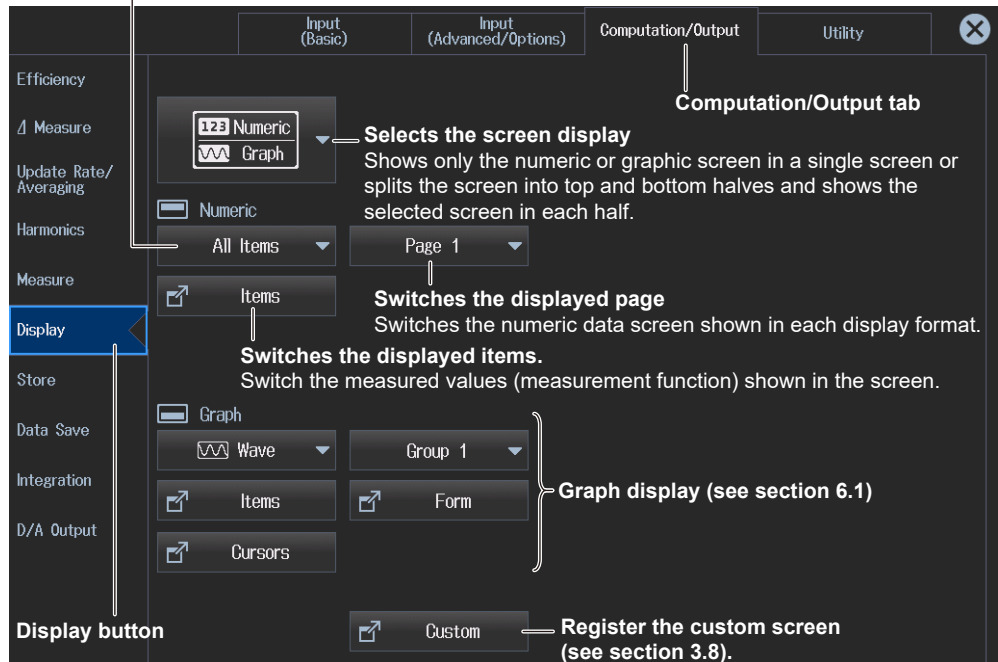

Computation/Output tab

Selects the screen display
Shows only the numeric or graphic screen in a single screen or splits the screen into top and bottom halves and shows the selected screen in each half.

Switches the displayed page
Switches the numeric data screen shown in each display format.

Switches the displayed items.
Switch the measured values (measurement function) shown in the screen.

Graph display (see section 6.1)

Register the custom screen (see section 3.8).

Display button

Note

You can also display the computation/output settings overview screen by moving the cursor on the Computation/Output tab using the arrow keys and then pressing SET.

3.1 Setting the Display Format

Setting the Screen Display

You can switch the display format of the Numeric (numeric display) and Graph (graph display) screens.

- Numeric (numeric display)**
Shows only numeric data in a single screen
- Graph (graph display)**
Shows only graphs in a single screen For details on the graph display, see chapter 6.
- Numeric (numeric display)/Numeric (numeric display)**
Shows numeric data in the top and bottom halves of the screen
- Numeric (numeric display)/Graph(graph display)**
Show numeric data in the top half of the screen and graphs (see chapter 6) in the bottom half
- Graph (graph display)/Numeric (numeric display)**
Shows graphs (see chapter 6) in the top half of the screen and numeric data in the bottom half
- Graph (graph display)/Graph (graph display)**
Shows graphs (see chapter 6) in the top and bottom halves of the screen
- Custom (custom display, see section 3.8)**
Select one of the registered screen configurations (up to five configurations) to display the screen.

Example of Numeric (numeric display)/Graph(graph display)

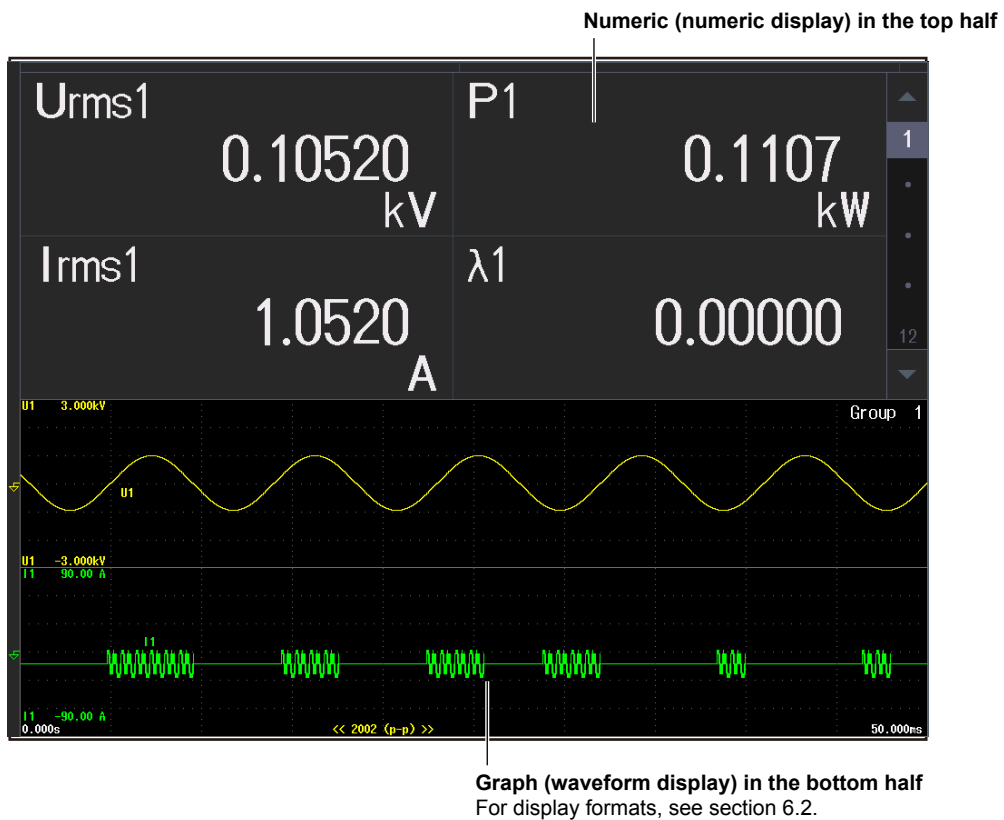

Setting the Numeric Display Format

Set how to display the measurement items on a single screen.

All Items (shows all values)

Element	1	2	3	4	5	6	7
Voltage	1000V	1000V	1000V	1000V	1000V	1000V	1000V
Current	30A	30A	30A	30A	30A	30A	30A
Urms [V]	0.10860k	0.10960k	0.11060k	0.11160k	0.11260k	0.11360k	0.11460k
Irms [A]	1.0860	2.0860	3.0860	4.0860	5.0860	6.0860	7.0860
P [W]	0.1179k	0.2286k	0.3413k	0.4560k	0.5727k	0.6914k	0.8121k
S [VA]	0.1179k	0.2286k	0.3413k	0.4560k	0.5727k	0.6914k	0.8121k
Q [var]	0.1179k	0.2286k	0.3413k	0.4560k	0.5727k	0.6914k	0.8121k
λ []	0.00000	0.00000	0.00000	0.00000	0.00000	0.00000	0.00000
φ [°]	60.000	60.000	60.000	60.000	60.000	60.000	60.000
fU [Hz]	13.277k	13.279k	13.281k	13.283k	13.285k	13.287k	13.289k
fI [Hz]	13.278k	13.280k	13.282k	13.284k	13.286k	13.288k	13.290k

Urms [V]	0.10860k	0.10960k	0.11060k	0.11160k	0.11260k	0.11360k	0.11460k
Umn [V]	0.10960k	0.11060k	0.11160k	0.11260k	0.11360k	0.11460k	0.11560k
Udc [V]	0.11060k	0.11160k	0.11260k	0.11360k	0.11460k	0.11560k	0.11660k
Urmn [V]	0.11160k	0.11260k	0.11360k	0.11460k	0.11560k	0.11660k	0.11760k
Uac [V]	0.11260k	0.11360k	0.11460k	0.11560k			
Ufnd [V]	-----	-----	-----	-----	-----	-----	-----
U+pk [V]	0.00000k	0.00000k	0.00000k	0.00000k	0.00000k	0.00000k	0.00000k
U-pk [V]	0.00000k	0.00000k	0.00000k	0.00000k	0.00000k	0.00000k	0.00000k
CfU []	0.000	0.000	0.000	0.000	0.000	0.000	0.000
Pc [W]	0.0000k	0.0000k	0.0000k	0.0000k	0.0000k	0.0000k	0.0000k
P+pk [W]	0.0000k	0.0000k	0.0000k	0.0000k	0.0000k	0.0000k	0.0000k
P-pk [W]	0.0000k	0.0000k	0.0000k	0.0000k	0.0000k	0.0000k	0.0000k

Switching the displayed page shows other items in this display area.

4 Items (4-value display)

Urms1	P1
0.10280	0.1057
kV	kW
Irms1	λ1
1.0280	0.00000
A	

8 Items (8-value display)

Urms1	Q1
0.10280	0.1057
kV	kvar
Irms1	λ1
1.0280	0.00000
A	
P1	φ1
0.1057	60.000
kW	°
S1	fU1
0.1057	22.352
kVA	kHz

16 Items (16-value display)

Urms1	Q1	fU1	I+pk1
0.10200	0.1040	26.762	0.0000
kV	kvar	kHz	A
Irms1	λ1	fI1	I-pk1
1.0200	0.00000	26.763	0.0000
A		kHz	A
P1	φ1	U+pk1	CfU1
0.1040	60.000	0.00000	0.000
kW	°	kV	
S1	Pc1	U-pk1	CfI1
0.1040	0.0000	0.00000	0.000
kVA	kW	kV	

Matrix (matrix display)

	Element 1	Element 2	Element 3	Element 4
Urms [V]	0.10410 k	0.10510 k	0.10610 k	0.10710 k
Irms [A]	1.0410	2.0410	3.0410	4.0410
P [W]	0.1084 k	0.2145 k	0.3227 k	0.4328 k
S [VA]	0.1084 k	0.2145 k	0.3227 k	0.4328 k
Q [var]	0.1084 k	0.2145 k	0.3227 k	0.4328 k
λ []	0.00000	0.00000	0.00000	0.00000
φ [°]	60.000	60.000	60.000	60.000
fU [Hz]	30.557 k	30.559 k	30.561 k	30.563 k
fI [Hz]	30.558 k	30.560 k	30.562 k	30.564 k

Measurement function Shows the measured values of each element

3.1 Setting the Display Format

Hrm List Single (single screen display of harmonics)

Order	U1 [V]	hdr [G]
Total		
1		
2		
3		
4		
5		
6		
7		
8		
9		
10		
11		
12		
13		
14		
15		
16		
17		
18		
19		
20		
21		
22		
23		
24		
25		
26		
27		
28		
29		
30		
31		
32		
33		
34		
35		
36		
37		
38		
39		
40		

Function display of each element and Σ

Shows harmonic data
Shows the harmonics (Total, DC, 1 to 500) of an item. Shows 40 harmonics per page.

Hrm List Dual (split screen display of harmonics)

Order	U1 [V]	hdr [G]
Total		
dc		
1		
2		
3		
4		
5		
6		
7		
8		
9		
10		
11		
12		
13		
14		
15		
16		
17		
18		
19		
20		

Function display of each element and Σ

Shows harmonic data
Shows the harmonics (Total, DC, 1 to 500) of two items. Shows 20 harmonics per page.

Switching the Displayed Items (Items)

You can switch the measured value (measurement function) shown in the screen.

On the All Items Display



Closes the menu

Set the harmonic order (Total, 0-500).

You can set this setting only when you have selected the page of a measurement function that includes a harmonic order. For details on how to switch pages, see page 3-1.

Turns the display of numeric data of all elements or all wiring units on and off
If the total number of elements or wiring units is 8 or more, set this to ON when you want to display the numeric data of all elements or all wiring units.

Turns the display frame on and off

Scroll the screen horizontally to change the displayed element or wiring unit. You can use these when Display All Elements is set to OFF.

Note

On the All Items display, you cannot select individual display items and change their measurement function, element, or wiring unit. If you switch to the Matrix display, you can change the measurement functions, elements, and wiring units using the displayed table (see the previous page).

On the 4-, 8-, and 16-Value Displays

Numeric Items [X] — Closes the menu

[4 Items]

Item No. [1] — Select the displayed item number.
The number increases from the upper left to the lower right of the screen.

Function [Urms] — Set the displayed items.
You can set the following items for displaying measurement functions.

- Voltage, current, active power, power factor: See section 3.2
- Apparent power, reactive power, corrected power: See section 3.3
- Phase difference, frequency (voltage, current): See section 3.4
- Computed values (numeric, event): See section 3.5
- Integrated value: See section 4.2
- Harmonics: See section 5.2
- Motor evaluation: See section 9.2
- External signal: See section 10.2

Element/Σ [Element 1] — Selects the input element or wiring unit to be configured

- Input element options
When the displayed item is set to something other than motor evaluation: Element1 to Element7
- When the displayed item is set to motor evaluation: Motor1 to Motor4
- Wiring unit options: ΣA, ΣB, ΣC

Order (k) [Total] — Selects the harmonic order to be set
This is for the harmonic orders display (see section 5.2).

[Reset Items] — Resets the displayed items.

On the Matrix Display

Numeric Items [X] — Closes the menu

[Matrix]

Item No. [1] — Select the displayed item number (displayed row).
The number increases from top to bottom on the matrix display.
Example: If you select 3, the third row from the top is displayed.

Function [Urms] — Set the displayed item.
See “On the 4-, 8-, and 16-Value Displays.”

Order (k) [Total] — Selects the harmonic order to be set
This is for the harmonic orders display (see section 5.2).

[Reset Items] — Resets the displayed items.

[Column] — Configure the columns to display.

On the Hrm List Single or Hrm List Dual Display

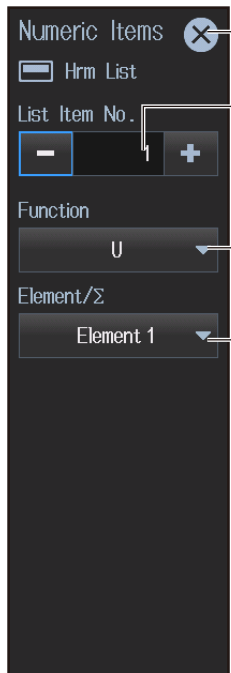

The screenshot shows a dark-themed configuration menu for 'Hrm List'. At the top is a close button (X) labeled 'Closes the menu'. Below it is a toggle for 'Hrm List'. The 'List Item No.' section has minus and plus buttons, with a callout 'Select the displayed harmonic data column. This is for Hrm List Dual. Select 1 (left column) or 2 (right column)'. The 'Function' dropdown is set to 'U', with a callout 'Set the displayed items. You can set the following items for displaying measurement functions. • Harmonics: See section 5.2'. The 'Element/ Σ ' dropdown is set to 'Element 1', with a callout 'Selects the input element or wiring unit to be configured'. Below this callout are two bullet points: '• Input element options: When the displayed item is set to something other than motor evaluation: Element1 to Element7' and '• Wiring unit options: Σ A, Σ B, Σ C'.

Note

On the harmonics list displays, you can change the measurement function, element, and wiring unit for the selected list, but you cannot change these settings for each individual display item.

Resetting the Displayed Items

You can clear the displayed items (no data "----") or return them to the preset displayed items.

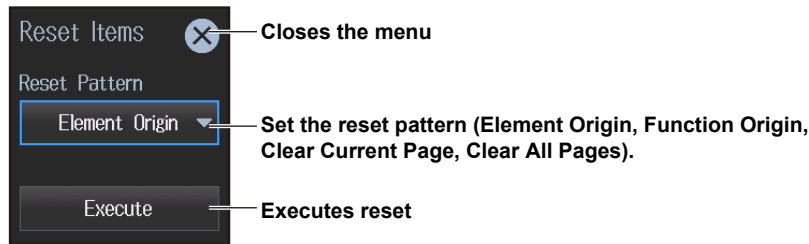

Reset Patterns

Element Origin pattern (1 element on 1 page)

The screen is a display example of element 1.

Urms1 0.17390 kV	P1 0.3024 kW
I rms1 1.7390 A	λ1 0.00000

Function Origin pattern (1 function on 1 page)

The screen is a display example of voltage.

Urms1 0.19740 kV	Urms3 0.19940 kV
Urms2 0.19840 kV	Urms4 0.20040 kV

Configuring the Columns to Display

You can configure this on the Matrix display.

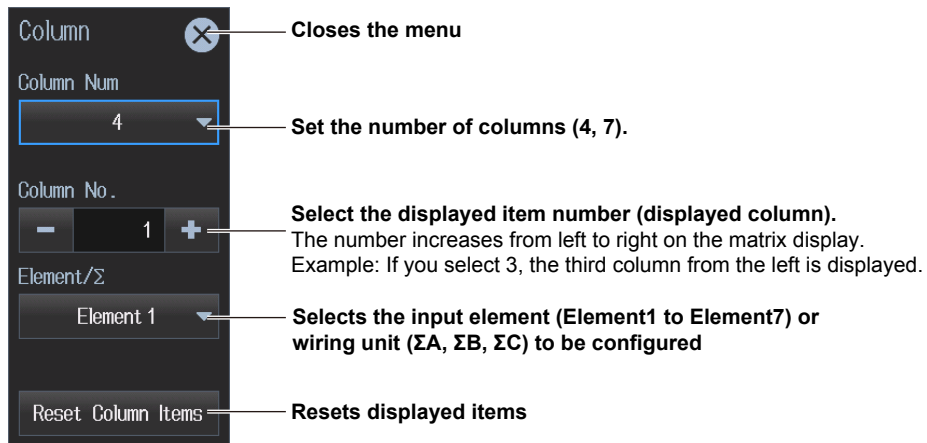

Procedure Using the Menu Icons

You can also use the menu icons shown on the right side of the screen to set the display format.

1. Tap the **Display** menu icon . A Display menu appears in the sub menu area on the right side of the screen.
By tapping the displayed items, you can specify the same settings as when using the screen explained earlier.

Note

For details on the Display menu, see page iv.

Switching the Display Format (NUMERIC key)

You can also use keys to perform “Setting the Screen Display” and “Setting the Numeric Display Format” described earlier.

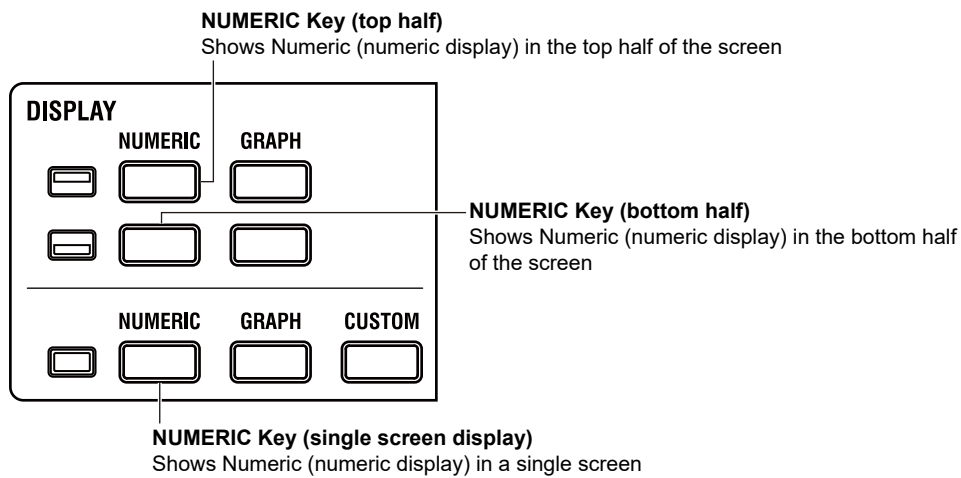

Each time you press NUMERIC, the display format switches, in order, between All Items, 4 Items, 8 Items, 16 Items, Matrix, Hrm List Single, Hrm List Dual, and User.

3.2 Displaying the Voltage, Current, Active Power, and Power Factor

This instrument shows on the screen the measurements (measurement functions) of the voltage and current applied to the input elements or wiring units.

► “Measurement Functions Used in Normal Measurement” in the features guide

The measurements of voltage, current, active power, and power factor do not require you to set equations. The measurements are simply shown on the screen. Using an example, this section explains how to display measurement results numerically.

In addition, this section explains operating procedures using the following setup methods.

- Procedure Using the Setup Menu (see chapter 1)
- Procedure Using the Menu Icons (see page iii)

Measurement Display Screen (Example of a 4 items display)

Measurement display of input element 1

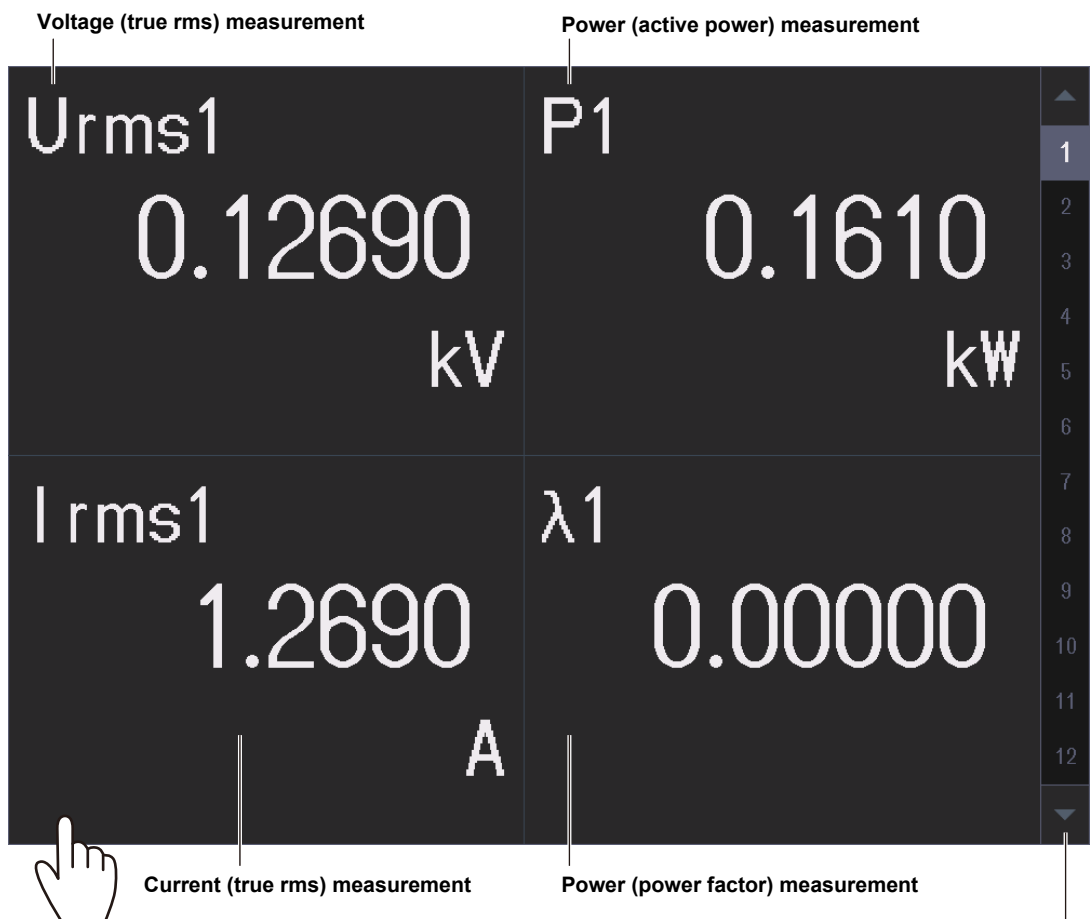

If you hold your finger down on the 4-, 8-, 16-value, matrix or harmonics display for at least 1 second, you can perform the operations described in “Switching the Displayed Items (Items),” provided later.

Switches the displayed page (Page Up/Page Down)
Switches to the measurement display of another input element
Tap ▲ or ▼ to change the displayed page in order from the current number. Tap the number directly to change to the number display page.

Note

Voltage, current, active power, and power factor values can be shown graphically.

- The waveform display feature (see section 6.2) shows voltage and current waveforms.
- The trend display (see section 6.3) shows voltage, current, active power, and power factor values graphically.

Procedure Using the Setup Menu

1. Tap the **Setup** icon  or press **MENU** under SETUP.
2. Tap **Computation/Output** tab. A computation and output settings overview screen appears. Pressing **ESC** closes the overview screen.

Switching the Displayed Items (Items)

You can switch the measured value (measurement function) shown in the screen.

3. Tap **Display**.
A display format setup screen (Numeric/Graph) appears. For details, see section 3.1.
4. Tap **Items**. The following screen appears.

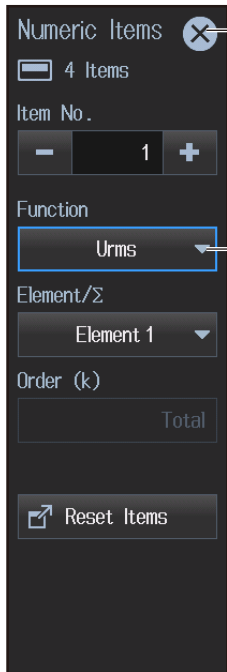

Closes the menu

Set the displayed item.

You can set the following items for displaying voltage, current, power, and power factor.

Voltage measurement (Voltage group):

- Urms** (true rms value), **Umn** (rectified mean value calibrated to the rms value),
- Udc** (simple average), **Umn** (current rectified mean value),
- Uac** (AC component), **Ufnd** (fundamental component),
- U+peak** (maximum value), **U-peak** (minimum value), **CfU** (crest factor)

Current measurement (Current group):

- Irms** (true rms value), **Imn** (rectified mean value calibrated to the rms value),
- Idc** (simple average), **Imn** (current rectified mean value), **Iac** (AC component),
- Ifnd** (fundamental component), **I+peak** (maximum value),
- I-peak** (minimum value), **CfU** (crest factor)

Measured power and power factor (Power group):

- P** (active power), **Pfnd** (fundamental active power), **P+peak** (maximum value),
- P-peak** (minimum value),
- λ** (power factor), **λfnd** (fundamental power factor)

Procedure Using the Menu Icons

You can also use the menu icons shown on the right side of the screen to switch the displayed items.

1. Tap the **Display** menu icon . A Display menu appears in the sub menu area on the right side of the screen.
By tapping the displayed items, you can specify the same settings as when using the screen explained earlier.

Note

For details on the Display menu, see page iv.

3.3 Displaying Apparent Power, Reactive Power, and Corrected Power

This instrument calculates, based on equations that are defined, apparent power (S), reactive power (Q), and corrected power (Pc) from the measurements of the voltage and current applied to the input elements or wiring units and shows calculated results on the screen.

- ▶ “Equation for Apparent Power (S Formula)” in the features guide
- ▶ “Apparent Power and Reactive Power Computation Types (S,Q Formula)” in the features guide
- ▶ “Equation for Corrected Power (Pc Formula)” in the features guide

To determine apparent power (S), reactive power (Q), and corrected power (Pc) values, you need to set equations.

Using an example, this section explains how to display computation results numerically.

In addition, this section explains operating procedures using the following setup methods.

- Procedure Using the Setup Menu (see chapter 1)
- Procedure Using the Menu Icons (see page iii)

Measurement Display Screen (Example of a 4 items display)

Measurement display of input element 1

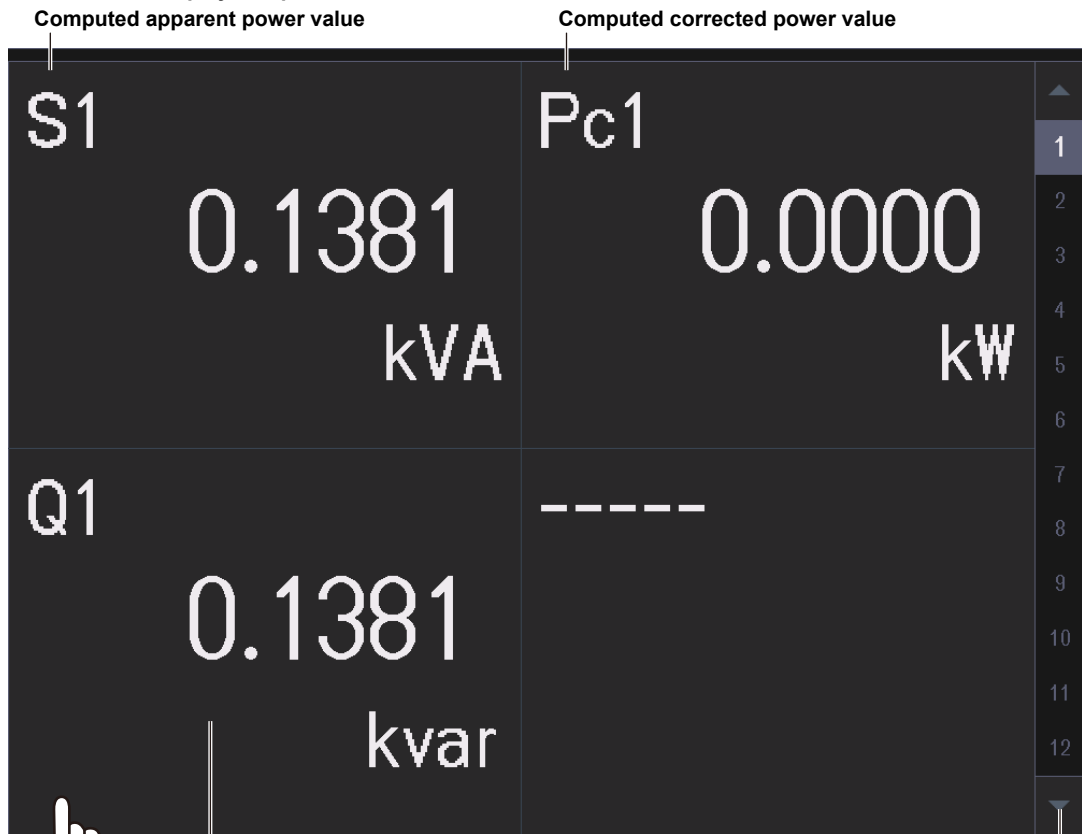

Computed reactive power value

If you hold your finger down on the 4-, 8-, 16-value, matrix or harmonics display for at least 1 second, you can perform the operations described in “Switching the Displayed Items (Items),” provided later.

Note

Apparent power, reactive power, and corrected power values can be shown graphically.

- The trend display(see section 6.3) shows apparent power, reactive power, and corrected power values graphically.

Switches the displayed page (Page Up/Page Down)

Switches to the measurement display of another input element. Tap ▲ or ▼ to change the displayed page in order from the current number. Tap the number directly to change to the number display page.

Procedure Using the Setup Menu

1. Tap the **Setup** icon  or press **MENU** under SETUP.
2. Tap **Computation/Output** tab. A computation and output settings overview screen appears. Pressing **ESC** closes the overview screen.

Setting Measurement Equations (Measure)

3. Tap **Measure**.
An equation setup screen appears.

Set the apparent power and reactive power computation type (Type 1, Type 2, Type 3).

Set the apparent power equation (Urms*Irms, Umean*Imean, Udc*Idc, Umean*Irms, Urmean*Irmean).

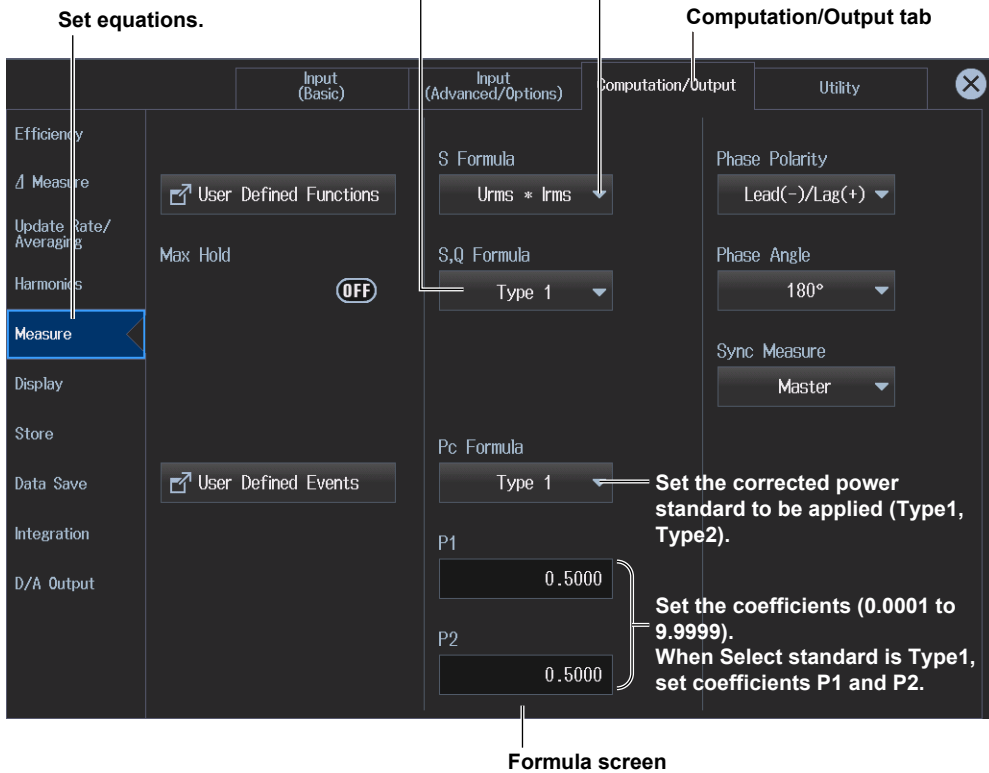

Note

You can also display the computation/output settings overview screen by moving the cursor on the Computation/Output tab using the arrow keys and then pressing SET.

Switching the Displayed Items (Items)

You can switch the measured value (measurement function) shown in the screen.

3. Tap Display.

A display format setup screen (Numeric/Graph) appears. For details, see section 3.1.

4. Tap Items. The following screen appears.

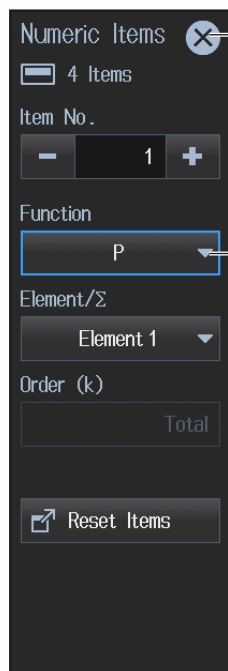

Closes the menu

Set the displayed item.

You can set the following items for displaying apparent power, reactive power, and corrected power.

Computed apparent power value (Power group):

S (apparent power), **Sfnd** (fundamental apparent power)

Computed reactive power value (Power group):

Q (reactive power), **Qfnd** (fundamental reactive power)

Computed corrected power value (Power group):

Pc (Corrected Power)

Procedure Using the Menu Icons

You can also use the menu icons shown on the right side of the screen to switch the displayed items.

1. Tap the Display menu icon . A Display menu appears in the sub menu area on the right side of the screen.

By tapping the displayed items, you can specify the same operation as explained in “Switching the Displayed Items” described earlier.

Note

For details on the Display menu, see page iv.

3.4 Displaying the Phase Difference And Frequency (Voltage and Current)

This instrument shows on the screen the measurements of the phase differences and frequencies of the voltage and current applied to the input elements or wiring units.

- ▶ “Phase Difference Polarity (Phase Polarity)” in the features guide
- ▶ “Phase Difference Display Format (Phase Angle)” in the features guide

The measurements of phase difference and frequency do not require you to set equations. The measurements are simply shown on the screen. Using an example, this section explains how to display measurement results numerically.

In addition, this section explains operating procedures using the following setup methods.

- Procedure Using the Setup Menu (see chapter 1)
- Procedure Using the Menu Icons (see page iii)

Measurement Display Screen (Example of a 4 items display)

Measurement display of input element 1

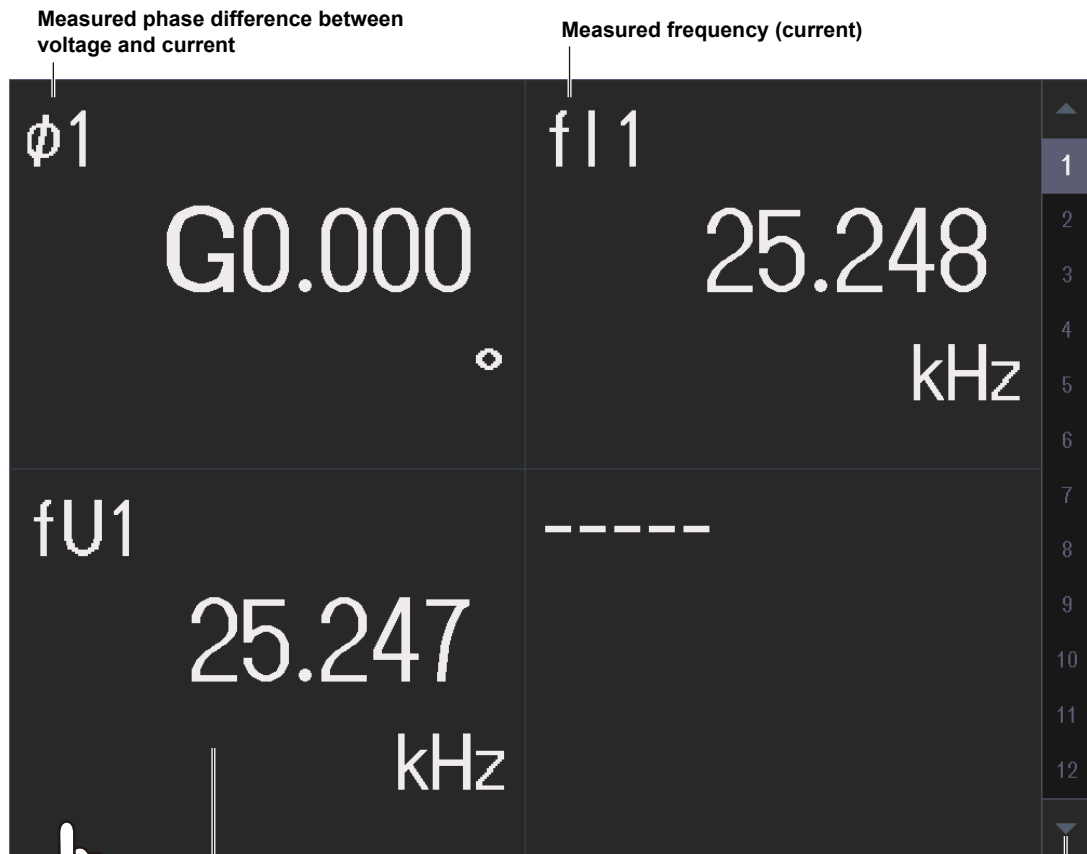

Measured frequency (voltage)

If you hold your finger down on the 4-, 8-, 16-value, matrix or harmonics display for at least 1 second, you can perform the operations described in “Switching the Displayed Items (Items),” provided later.

Switches the displayed page (Page Up/Page Down)
Switches to the measurement display of another input element. Tap ▲ or ▼ to change the displayed page in order from the current number. Tap the number directly to change to the number display page.

Note

Phase difference and frequency (voltage and current) values can be shown graphically.

- The trend display (see section 6.3) shows phase difference and frequency (voltage and current) values graphically.

Procedure Using the Setup Menu

1. Tap the **Setup** icon , or press **MENU** under **SETUP**.
2. Tap **Computation/Output** tab. A computation and output settings overview screen appears. Pressing **ESC** closes the overview screen.

Phase Difference Display Mode (Phase)

3. Tap **Measure**.
An equation setup screen appears.

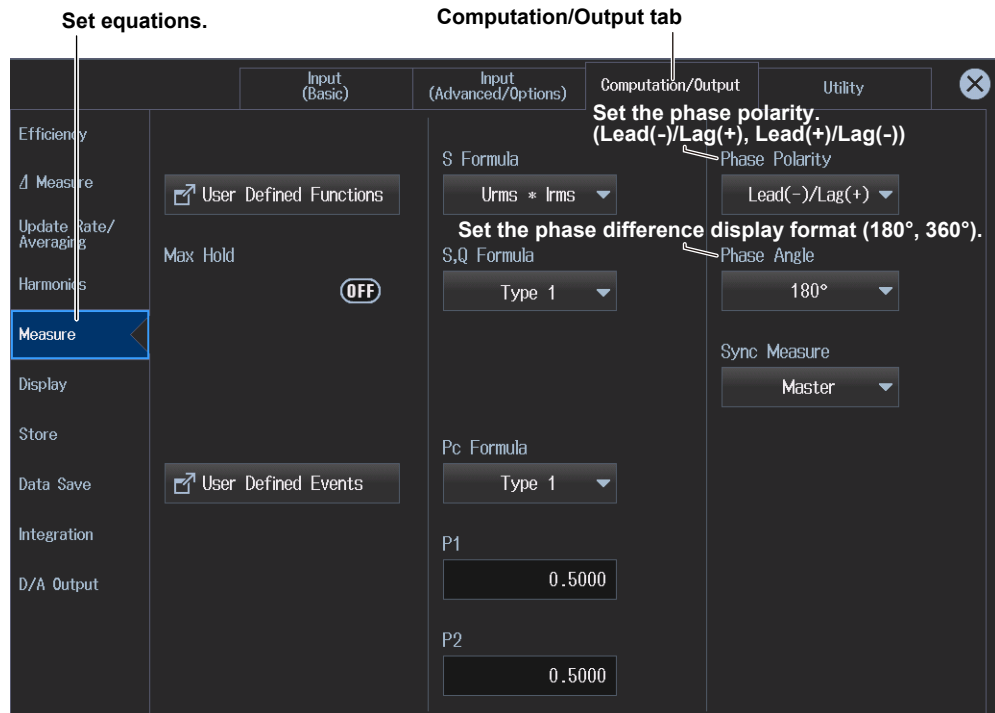

Note

You can also display the computation/output settings overview screen by moving the cursor on the Computation/Output tab using the arrow keys and then pressing SET.

3.4 Displaying the Phase Difference And Frequency (Voltage and Current)

Switching the Displayed Items (Items)

You can switch the measured value (measurement function) shown in the screen.

3. Tap Display.

A display format setup screen (Numeric/Graph) appears. For details, see section 3.1.

4. Tap Items. The following screen appears.

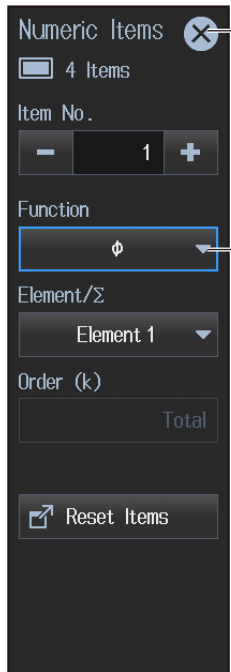

The screenshot shows a dark-themed menu titled "Numeric Items" with a close button (X) at the top right. Below the title, it says "4 Items". There is a section for "Item No." with a minus sign, the number "1", and a plus sign. The "Function" section has a dropdown menu currently showing the Greek letter ϕ . Below that is "Element/ Σ " with a dropdown showing "Element 1". The "Order (k)" section has a dropdown showing "Total". At the bottom is a "Reset Items" button with a refresh icon.

Closes the menu

Set the displayed item.
You can set the following items for displaying the phase difference, frequency (voltage), and frequency (current).
Measured phase difference (Power group):
 Φ (phase difference), Φ_{nd} (fundamental phase difference)
Measured frequency (voltage) (Frequency group):
FreqU (voltage frequency), **Freq2U** (current frequency)
Measured frequency (current) (Frequency group):
FreqI (current frequency), **Freq2I** (current frequency)

Procedure Using the Menu Icons

You can also use the menu icons shown on the right side of the screen to switch the displayed items.

1. Tap the Display menu icon . A Display menu appears in the sub menu area on the right side of the screen.

By tapping the displayed items, you can specify the same operation as explained in "Switching the Displayed Items" described earlier.

Note

For details on the Display menu, see page iv.

3.5 Displaying Computed Values (Values and Events)

You can combine function symbols to create equations and use the numeric data of the combined functions to determine the numeric data (value) of the equation. You can also define events that are used to make judgments when measurement values are compared to the range or reference value. These numeric data and the judgment results of events (true or false) are shown on the screen.

- ▶ “User-Defined Functions (User Defined Functions)” in the features guide
- ▶ “Measuring the Average Active Power” in the features guide
- ▶ “User-Defined Events (User Defined Event)” in the features guide

Using an example, this section explains how to display computation results. The following computed values are displayed as an example.

- Average active power measurement (Avg-W) and power loss (P-loss): Value example (user-defined function)
- Power measurement range (Ev1) and voltage measurement range (Ev2): Event example (user-defined event)

In addition, this section explains operating procedures using the following setup methods.

- Procedure Using the Setup Menu (see chapter 1)
- Procedure Using the Menu Icons (see page iii)

Measurement Display Screen (Example of a 4 items display)

Measurement display of input element

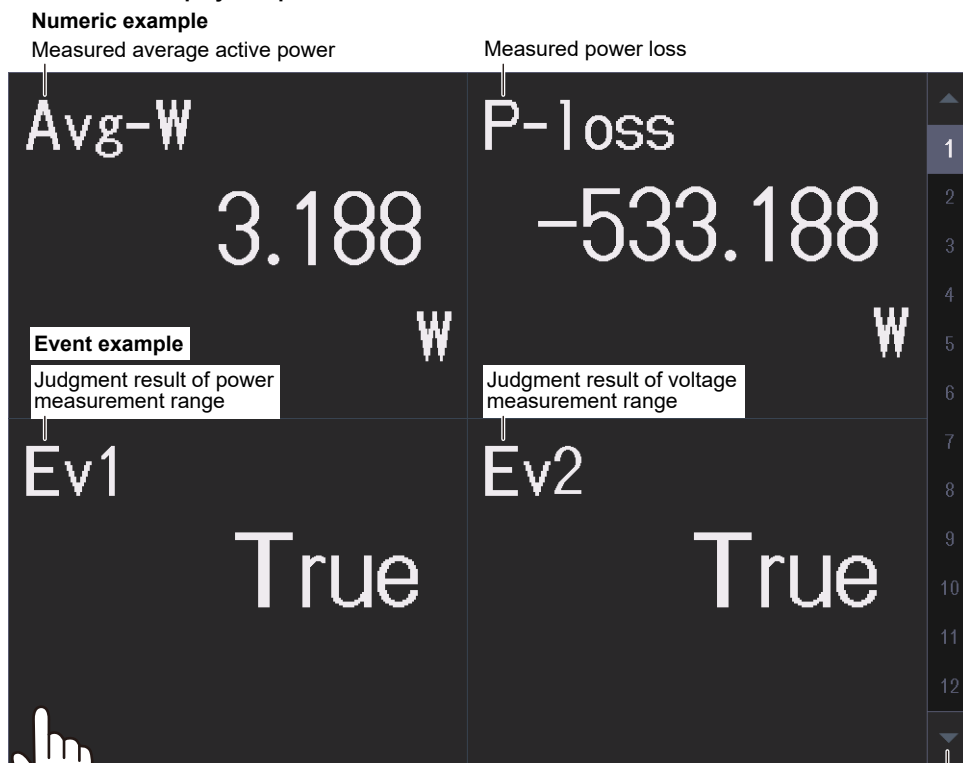

If you hold your finger down on the 4-, 8-, 16-value, matrix or harmonics display for at least 1 second, you can perform the operations described in “Switching the Displayed Items (Items),” provided later.

Switches the displayed page (Page Up/Page Down)

Switches to the measurement display of another input element. Tap ▲ or ▼ to change the displayed page in order from the current number. Tap the number directly to change to the number display page.

Note

Computed values (values and events) can be shown graphically.

- The trend display (see section 6.3) shows computed values (values and events) graphically.

Procedure Using the Setup Menu

1. Tap the **Setup** icon  or press **MENU** under SETUP.
2. Tap **Computation/Output** tab. A computation and output settings overview screen appears. Pressing **ESC** closes the overview screen.

Computed Value (Value) Display Mode (User Defined Function Settings)

3. Tap **Measure**.
An equation setup screen appears.

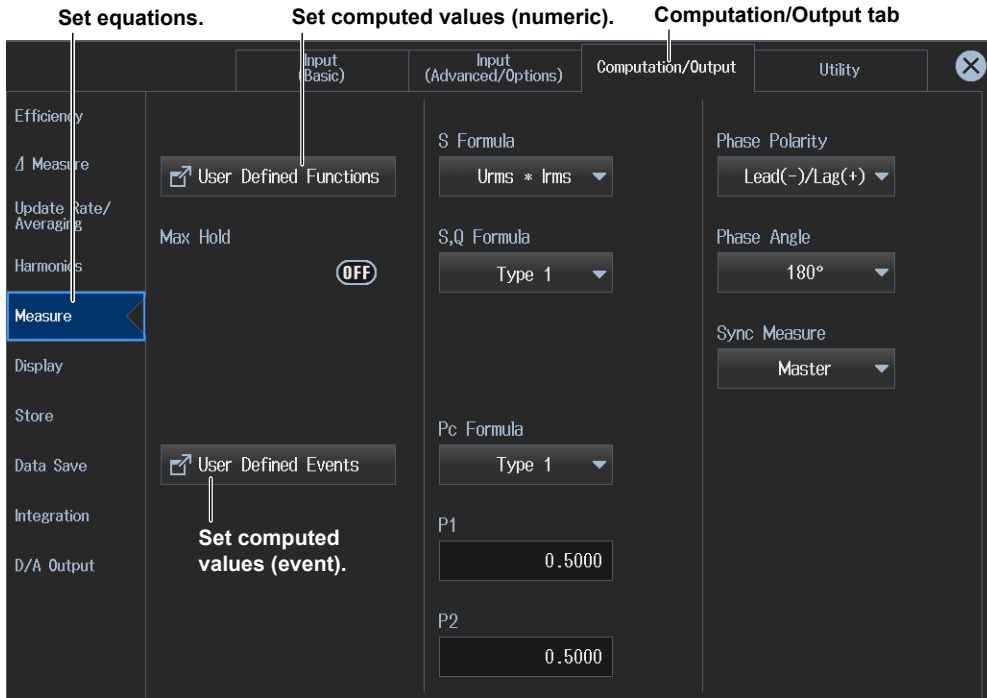

4. Tap **User Defined Functions**.
The following screen appears.

Displays the setup screen for user-defined functions (F1 to F5, F6 to F10, F11 to F15, F16 to F20)

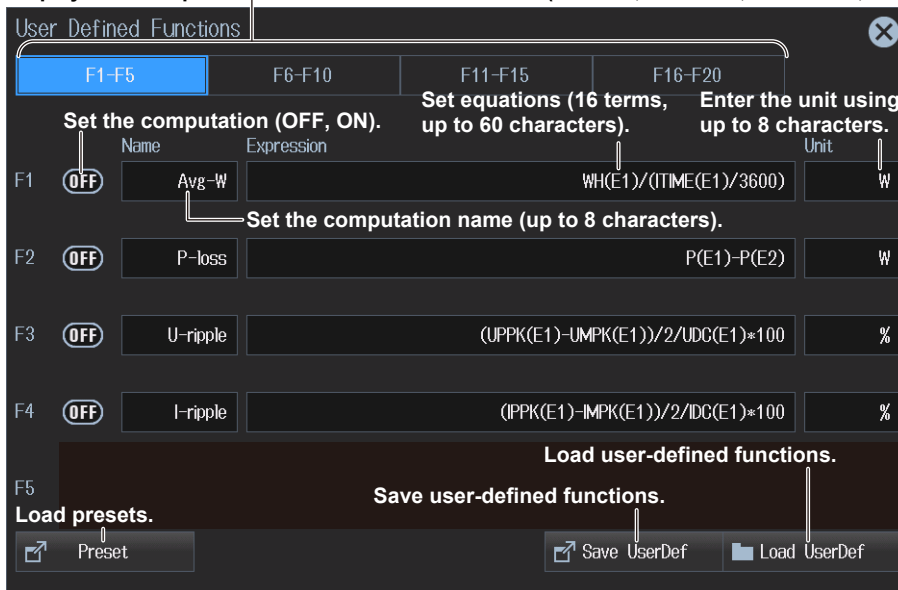

The user-defined function setup screen shows five functions per screen. Up to 20 functions can be defined. In the setup example, the computed value of average active power is set in F1 and the computed value of power loss is set in F2.

F1: Average active power Avg-W =
 Integrated power of element 1 WH(E1)/Elapsed integration time of element 1 ITIME(E1)/3600

F2: Power loss P-loss = Active power of element 1 P(E1) – Active power of element 2 P(E2)

If you set the computation setting to on, computed values are shown on the measurement display screen.

Note

- By default, the computed values of user definitions contain samples. Change them as necessary.
- You can also display the computation/output settings overview screen by moving the cursor on the Computation/Output tab using the arrow keys and then pressing SET.

Computed Value (Event) Display Mode (User Defined Event)

3. Tap Measure.

An equation setup screen appears.

4. Tap User Defined Events.

The following screen appears.

Set the event name (up to 8 characters).

Set judgment conditions (e.g., power measurement range).
 Example: Between 150 W and 160 W

Set judgment conditions (e.g., voltage measurement range).
 Example: Between 95 V and 105 V

Set judgment conditions (e.g., combination of events).
 Example: AND (logical product) of the judgment result of Ev1(measured power) and that of Ev2 (measured voltage)

Set the events (OFF, ON).

Event	Status	Name	Expression
Ev1	ON	Ev1	$P(E1) >= 150.00E+00 \text{ AND } P(E1) <= 160.00E+00$
Ev2	ON	Ev2	$URMS(E1) >= 95.000E+00 \text{ AND } URMS(E1) <= 105.00E+00$
Ev3	ON	Ev3	$EV1() \text{ AND } EV2()$
Ev4	OFF	Ev4	No Expression
Ev5	OFF	Ev5	No Expression
Ev6	OFF	Ev6	No Expression
Ev7	OFF	Ev7	No Expression
Ev8	OFF	Ev8	No Expression

Set the judgment conditions.

5. Tap Expression. The following screen appears.

3.5 Displaying Computed Values (Values and Events)

- **Setting Judgment Conditions (example: power measurement range)**

This is an explanation for defining judgment conditions using a measurement range.

Select the judgment method (Range, Condition).
To define using a range, select Range.

Set the characters (up to 6 characters) to show on the measurement display screen when the judgment conditions are met (True) and when they are not met (False).

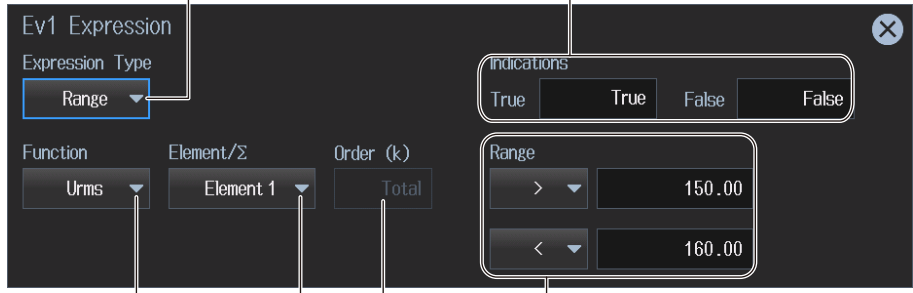

Set the numeric range (Range) (-9.9999T to 9.9999T).
The "T" attached to the number is tera ($\times 10^{12}$).
Screen setting example: Between 150 and 160 (inclusive)

Set the harmonic order (Total, 0 to 500).

Selects the input element or wiring unit to be configured

- Input element options
When the displayed item is set to something other than motor evaluation: Element1 to Element7
When the displayed item is set to motor evaluation: Motor1 to Motor4
- Wiring unit options: ΣA , ΣB , ΣC

Set the measurement function.
(For details on the various measurement functions, see "Items That This Instrument Can Measure" in the features guide.)
Example: Urms

- **Setting Judgment Conditions (example: combination of events)**

This is an explanation for defining judgment conditions using a combination of events.

Select the judgment method (Range, Condition).
To define using a combination of events, select Condition.

Inverts the judgment results (True and False) (OFF, ON)
OFF: Not inverted
ON: Inverted

Set the event combination condition.

Set the characters (up to 6 characters) to show on the measurement display screen when the judgment conditions are met (True) and when they are not met (False).



Switching the Displayed Items (Items)

You can switch the measured value (measurement function) shown in the screen.

3. Tap Display.

A display format setup screen (Numeric/Graph) appears. For details, see section 3.1.

4. Tap Items. The following screen appears.

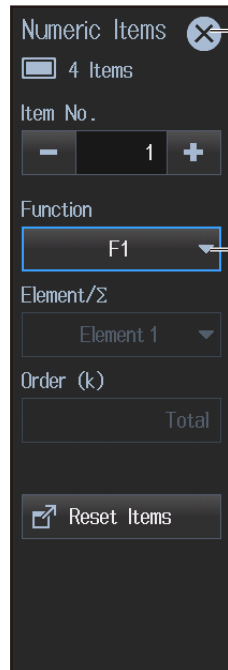

Closes the menu

Set the displayed item.

You can set the following items for displaying computed values (numeric, event).

Computed value (numeric) (User Func group):

F1 to F20 (user-defined function)

Computed value (event) (User Event group):

Ev1 to Ev8 (user-defined event)

Procedure Using the Menu Icons

You can also use the menu icons shown on the right side of the screen to switch the displayed items.

1. Tap the Display menu icon . A Display menu appears in the sub menu area on the right side of the screen.

By tapping the displayed items, you can specify the same operation as explained in “Switching the Displayed Items” described earlier.

Note

For details on the Display menu, see page iv.

3.6 Holding the Maximum Values

This instrument shows on the screen the maximum values of measurements (measurement functions) of the voltage, current, power, and the like applied to the input elements or wiring units.

► [“MAX Hold \(Max Hold\)” in the features guide](#)

Using an example, this section explains how to display the maximum values of measurements. The following maximum values are displayed as an example.

- Maximum value of the true rms voltage (Max Urms)
- Maximum value of the true rms current (Max Irms)
- Maximum value of the active power (Max P)

In addition, this section explains operating procedures using the following setup methods.

- Procedure Using the Setup Menu (see chapter 1)
- Procedure Using the Menu Icons (see page iii)

Measurement Display Screen (Example of a 4 items display)

Measurement display of input element 1



Maximum current (true rms)

If you hold your finger down on the 4-, 8-, 16-value, matrix or harmonics display for at least 1 second, you can perform the operations described in “Switching the Displayed Items (Items),” provided later.

Switches the displayed page (Page Up/Page Down)
Switches to the measurement display of another input element
Tap ▲ or ▼ to change the displayed page in order from the current number. Tap the number directly to change to the number display page.

Procedure Using the Setup Menu

- 1. Tap the **Setup** icon , or press **MENU** under **SETUP**.
- 2. Tap **Computation/Output** tab. A computation and output settings overview screen appears. Pressing **ESC** closes the overview screen.

Maximum Value Display Mode (Max Hold)

- 3. Tap **Measure**.
An equation setup screen appears.
- 4. Tap **Max Hold** to select **ON**.

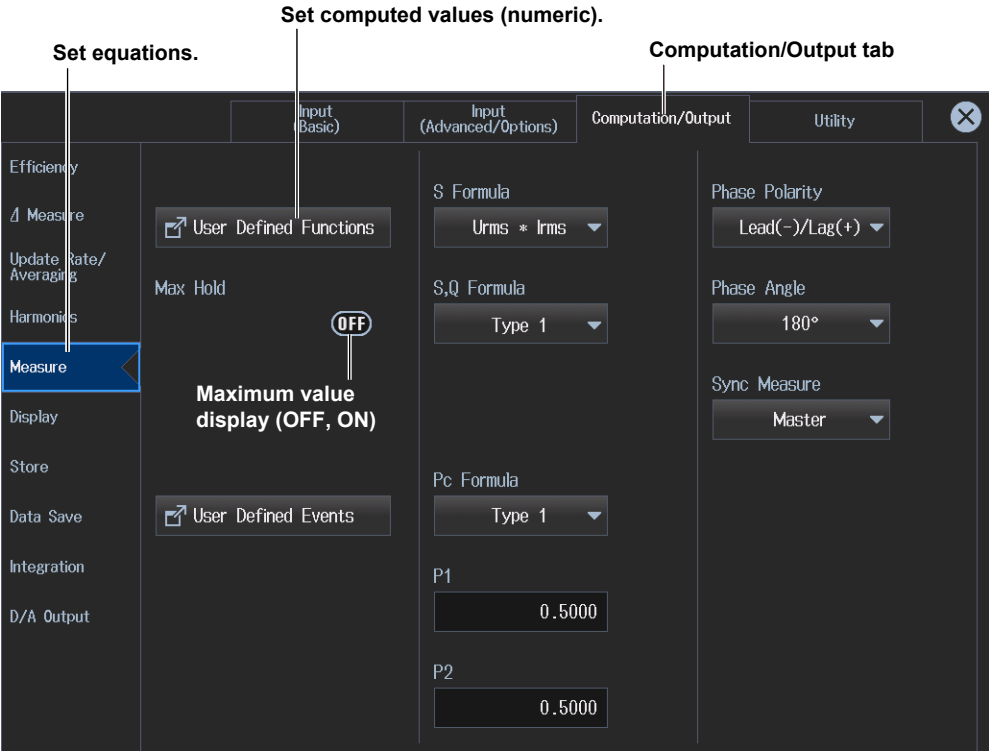

- 5. Tap **User Defined Functions**.
The following screen appears.

Displays the setup screen for user-defined functions (F1 to F5, F6 to F10, F11 to F15, F16 to F20)

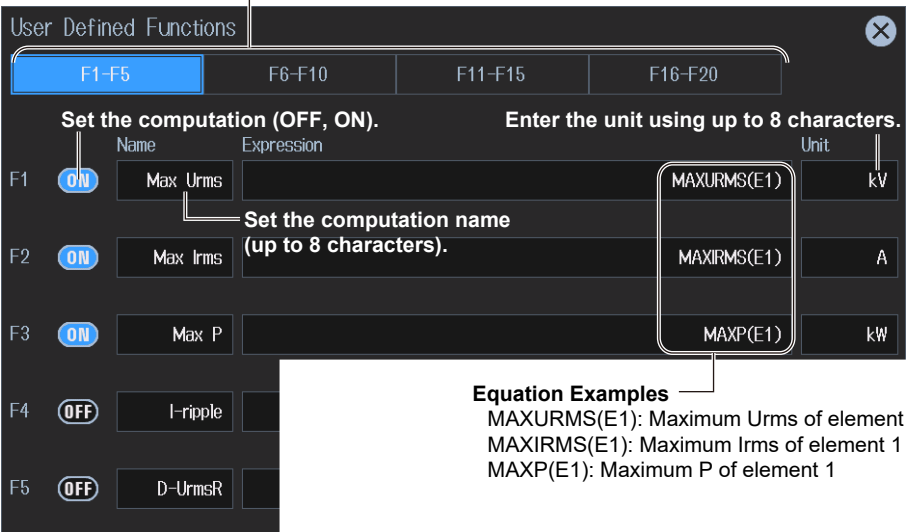

3.6 Holding the Maximum Values

The user-defined function setup screen shows five functions per screen. Up to 20 functions can be defined. In the setup example, the maximum value of the true rms voltage is set in F1, the maximum value of the true rms current is set in F2, and the maximum value of the active power is set in F3.

F1: Maximum value of the true rms voltage (element 1) Max Urms1 = MAXURMS(E1)

F2: Maximum value of the true rms current (element 1) Max Irms1 = MAXIRMS(E1)

F3: Maximum value of the active power (element 1) Max P1 = MAXP(E1)

If you set the computation setting to on, maximum values are shown on the measurement display screen.

Note

- By default, the computed values of user definitions contain samples. Change them as necessary.
- You can also display the computation/output settings overview screen by moving the cursor on the Computation/Output tab using the arrow keys and then pressing SET.

Switching the Displayed Items (Items)

You can switch the measured value (measurement function) shown in the screen.

3. Tap **Display**.

A display format setup screen (Display/Numeric/Graph) appears. For details, see section 3.1.

4. Tap **Items**. The following screen appears.

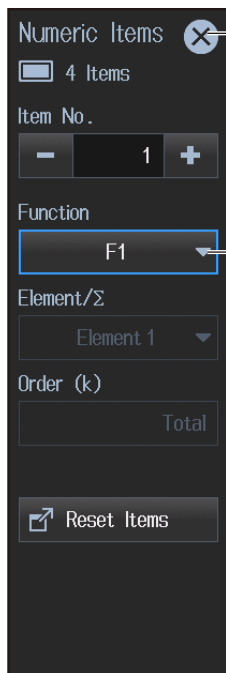

Closes the menu

Set the displayed item.

You can set the following items for displaying maximum values (MAX hold).
Maximum value (User Func group):
F1 to F20 (user-defined function)

Procedure Using the Menu Icons

You can also use the menu icons shown on the right side of the screen to switch the displayed items.

1. Tap the **Display** menu icon . A Display menu appears in the sub menu area on the right side of the screen.

By tapping the displayed items, you can specify the same operation as explained in "Switching the Displayed Items" described earlier.

Note

For details on the Display menu, see page iv.

3.7 User Display

You can display an illustration (.bmp) that you created on a PC or the like or a photo (.bmp) as a background of the screen and arrange numeric data boxes on top of the background to configure the screen.

► [“User Display \(User\)” in the features guide](#)

This section explains operating procedures using the following setup methods.

- Procedure Using the Setup Menu (see chapter 1)
- Procedure Using the Menu Icons (see page iii)
- Procedure Using the Keys (other than SETUP) (see section 1.2 in IM WT5000-03EN)

Procedure Using the Setup Menu

1. Tap the **Setup** icon , or press **MENU** under **SETUP**.
2. Tap the **Computation/Output** tab. A computation and output settings overview screen appears. Pressing **ESC** closes the overview screen.

Setting the Display Format (Display)

3. Tap **Display**.

A display format setting screen appears.

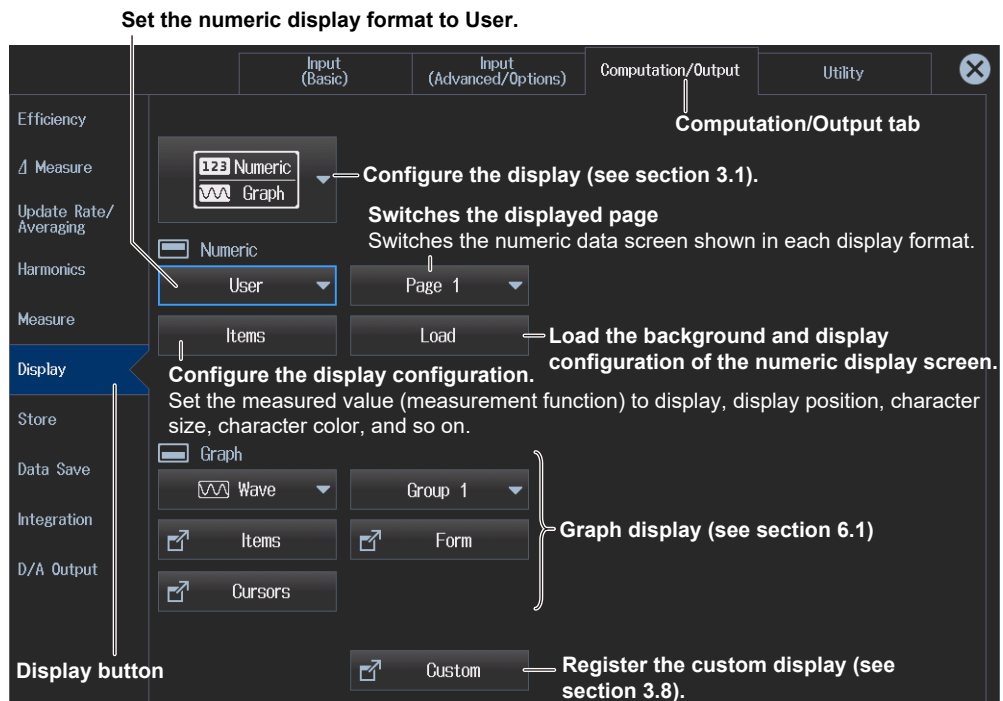

Note

You can also display the computation/output settings overview screen by moving the cursor on the Computation/Output tab using the arrow keys and then pressing SET.

Setting and Saving the Display Configuration (Items)

4. Tap **Item**. A Numeric Item menu appears.

Set the title, measured value (measurement function), display position, character size, character color, and so on.

Numeric Items [Close]

- User**
- Item No.**: [-] 1 [+]
 - Select the displayed item number.**
The number increases from the upper left to the right and lower of the screen. Use Position to change the display position.
- Function**: Urmn
 - Set the displayed item (function).**
Set the items of the measurement function. See "On the 4-, 8-, and 16-Value Displays" in section 3.1.
- Element/Σ**: Element 1
 - Selects the input element or wiring unit to be configured**
See "On the 4-, 8-, and 16-Value Displays" in section 3.1. When Function is set to None, set the text to display in the numeric data box.
- Order (k)**: Total
 - Harmonic to be configured**
Use this to specify the harmonic (see section 5.2).
- Position**: X 145 Y 30
 - Set the X and Y display positions.**
Set the horizontal (X) position and vertical (Y) position of the displayed item.
- Font Size**: 32
 - Selects the character size**
Select the character size to display.
- Font Color**: White
 - Selects the text color**
Select the text color to display.
- General**

Tap **General**.

Displays an overview. Save the display configuration.

[Close]

- Total Items**: 51
 - Total number of items**
Set the total number of numeric data boxes to display.
- Items Per Page**: 51
 - Number of items per page**
Set the number of numeric data boxes to display per page.
- Save Items**: C:/Users/00110861/...
 - Save the display configuration.**
 - File List**: [Folder Icon] File List
 - Displays the file list. Set the save destination and file name.**
Set where to save the display configuration. For information about how to configure the file list display and how to operate files and folders, see section 8.2.
 - Auto Naming**: Numbering
 - File Name**: File Name
 - Save**: [Save Icon] Save
 - Saves data**
 - Image**: [Image Icon] Image
 - Saves the background file simultaneously.**
Select whether to save the background file at the same time when the display configuration is saved.

Loading the Background and Display Configuration of the Numeric Display Screen (Load)

4. Tap **Load**. A Load User menu appears.

You can load a display configuration data file or background file that you specify on the file list. For information about how to configure the file list display and how to operate files and folders, see section 8.2.

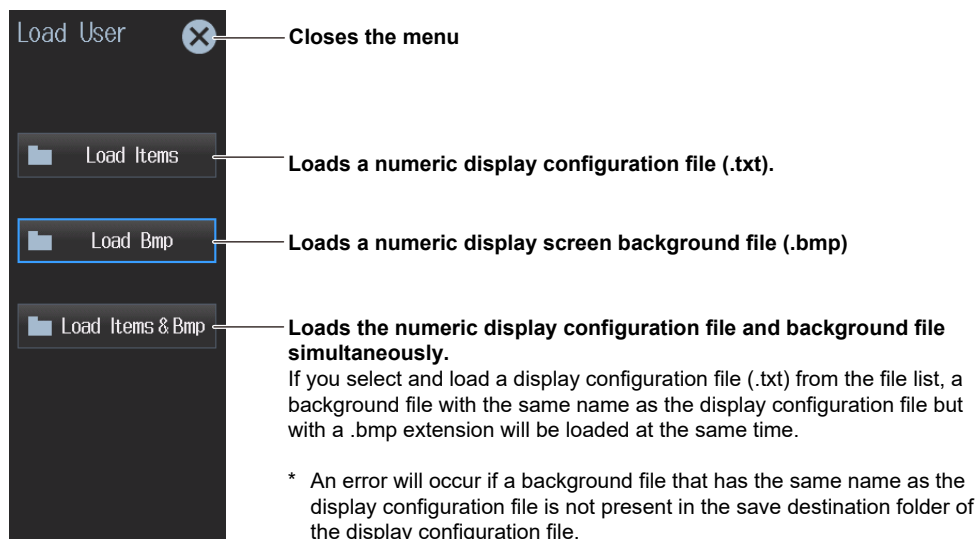

Procedure Using the Menu Icons

You can also use the menu icons shown on the right side of the screen to set the display format.

1. Tap the **Display** menu icon . A Display menu appears in the sub menu area on the right side of the screen. By tapping the displayed items, you can specify the same settings as when using the screen explained earlier.

Note

For details on the Display menu, see page iv.

Switching the Display Format (NUMERIC key)

You can also use keys to perform “Setting the Screen Display” and “Setting the Numeric Display Format” described in section 3.1.

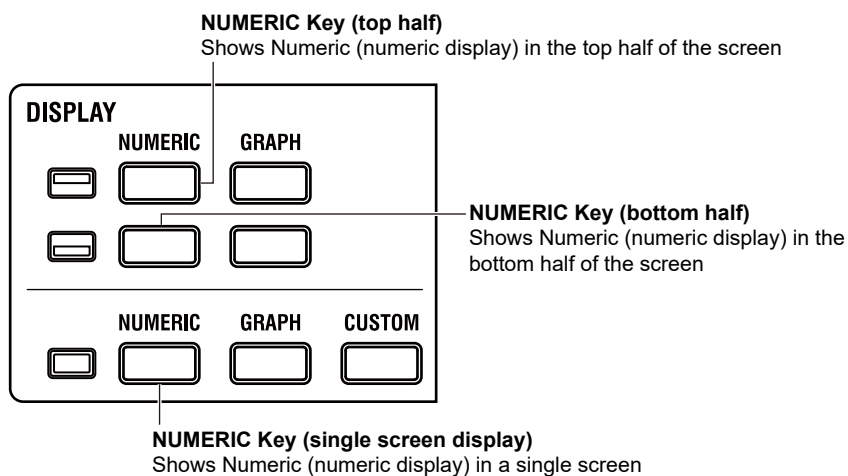

Each time you press **NUMERIC**, the display format switches, in order, between All Items, 4 Items, 8 Items, 16 Items, Matrix, Hrm List Single, Hrm List Dual, and User.

3.8 Custom Display

You can register up to five screen configurations in advance and use them as you like.

► “Custom Display (CUSTOM)” in the features guide

This section explains operating procedures using the following setup methods.

- Procedure Using the Setup Menu (see chapter 1)
- Procedure Using the Menu Icons (see page iii)
- Procedure Using the Keys (other than SETUP) (see section 1.2 in IM WT5000-03EN)

Depending on the measurement mode, the settings may be different from the description in this section, the settings may be invalid, or the settings may not be configurable. For details, see the features guide.

Procedure Using the Setup Menu

1. Tap the **Setup** icon  or press **MENU** under SETUP.
2. Tap the **Computation/Output** tab. A computation and output settings overview screen appears. Pressing **ESC** closes the overview screen.

Setting the Display Format (Display)

3. Tap **Display**.
A display format setting screen appears.

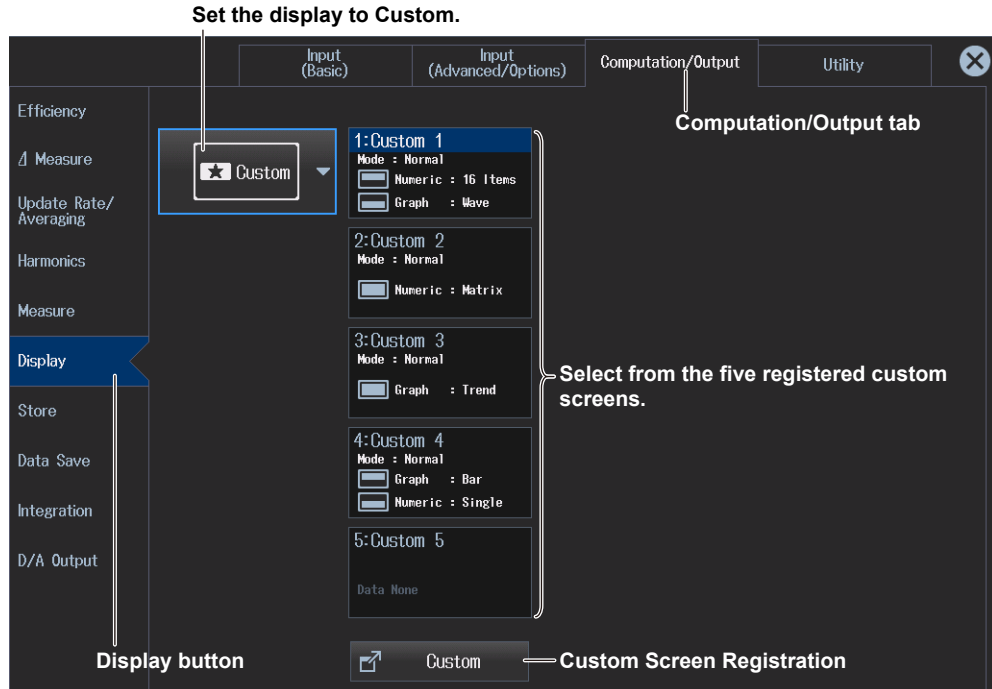

Note

You can also display the computation/output settings overview screen by moving the cursor on the Computation/Output tab using the arrow keys and then pressing SET.

Registering Custom Screens (Custom)

4. Tap **Custom**. A CUSTOM menu appears.
5. Select a registration tab. The setup menu is display for the selected tab.

Custom (Closes the menu)

1: Custom 1
Mode : Normal
Numeric : 16 Items
Graph : Wave

2: Custom 2
Mode : Normal
Numeric : Matrix

3: Custom 3
Mode : Normal
Graph : Trend

4: Custom 4
Mode : Normal
Graph : Bar
Numeric : Single

5: Custom 5
Data None

Tap a registered tab.

Custom 1 (Closes the menu)

1: Custom 1
Mode : Normal
Numeric : 16 Items
Graph : Wave

Name
Custom 1

OverWrite (Overwrite: The old configuration is overwritten with the current screen configuration.)

Clear (Delete: The registered contents are deleted.)

Tap an unregistered tab.

Custom 5 (Closes the menu)

5: Custom 5
Data None

Name
Custom 5

Register (New registration: The current screen configuration is registered as a new configuration.)

Clear

Procedure Using the Menu Icons

You can also use the menu icons shown on the right side of the screen to set the display.

1. Tap the **Display** menu icon . A Display menu appears in the sub menu area on the right side of the screen.
By tapping the displayed items, you can specify the same settings as when using the screen explained earlier.

Note

For details on the Display menu, see page iv.

Switching the Custom Screen (CUSTOM key)

You can also use keys to switch the custom screen.

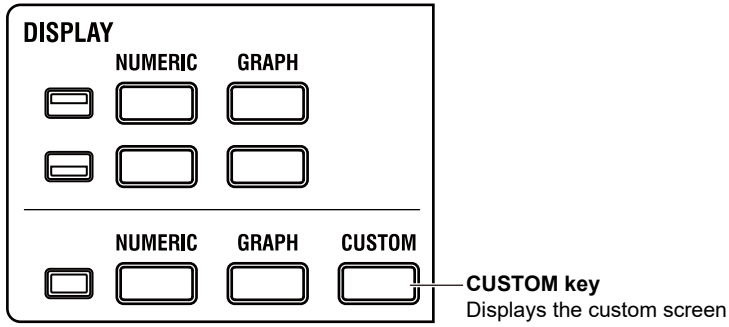

Each time you press **CUSTOM**, the screen configuration changes in order between registration tabs 1, 2, 3, 4, and 5. Unregistered tabs are skipped. If there are no screen configurations registered in any of the registration tabs, the screen does not switch to the custom screen.

4.1 Setting Integration Conditions

- ▶ “Enabling or Disabling Independent Integration (Independent Control)” in the features guide
 - ▶ “Integration Auto Calibration On/Off (Auto Cal)” in the features guide
 - ▶ “Integration Mode (Integration Mode)” in the features guide
 - ▶ “Integration Timer (Integration Timer)” in the features guide
- ▶ “Scheduled Times for Real-Time Integration (Start Time/End Time)” in the features guide
 - ▶ “Watt Hour Integration Method for Each Polarity (WP ± Type)” in the features guide
 - ▶ “Current Mode for Current Integration (q Mode)” in the features guide
 - ▶ “Rated Time for Integrated D/A Output (Integration Rated Time)” in the features guide
- ▶ “Integration resume action at power failure recovery (Resume Action)” in the features guide

This section explains operating procedures using the following setup methods.

- Procedure Using the Setup Menu (see chapter 1)
- Procedure Using the Menu Icons (see page iii)
- Procedure Using the Keys (other than SETUP) (see section 1.2 in IM WT5000-03EN)

Procedure Using the Setup Menu

1. Tap the **Setup** icon , or press **MENU** under SETUP.
2. Tap **Computation/Output** tab. A computation and output settings overview screen appears. Pressing **ESC** closes the overview screen.

Setting Integration Conditions (Integration)

3. Tap **Integration**. An integration condition setup screen appears.
- **When the Integration Mode Is Set to Normal or Continuous**

Set the integration mode.*

(Normal, Continuous, R-Normal, R-Continuous)

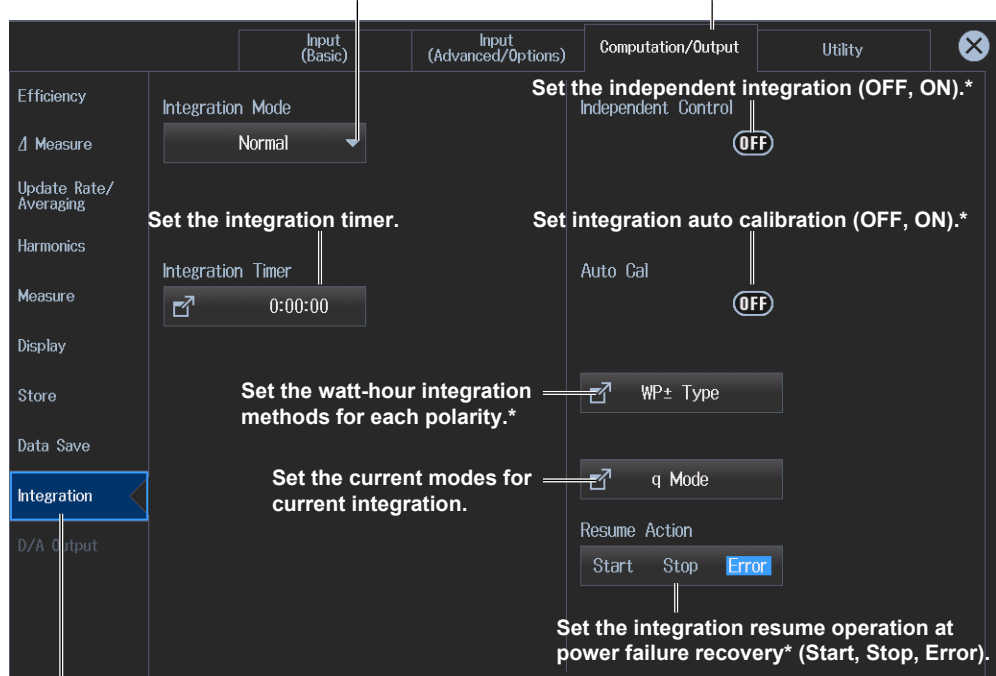

Set the integration conditions.

* You can set this when the update mode is not Auto. For details, see the appendix in the *Getting Started Guide*, IM WT5000-03EN.

4.1 Setting Integration Conditions

- When the Integration Mode Is Set to R-Normal or R-Continuous

Set the integration mode.
(Normal, Continuous, R-Normal, R-Continuous)

Computation/Output tab

Set the integration conditions.

Set the scheduled times for real-time integration.

Note

You can also display the computation/output settings overview screen by moving the cursor on the Computation/Output tab using the arrow keys and then pressing SET.

Setting the Integration Timer (Timer)

4. Tap **Integration Timer**. The following screen appears.

When independent computation is on

Select the integration timer's setup method (Each, All).
When you select Each, you can set the integration timer for each input element.

Set the integration timer.
(00000 hours : 00 minutes : 00 seconds to 10000 hours : 00 minutes : 00 seconds).
When Mode is set to Normal and the integration timer is 00000 : 00 : 00, the instrument is in manual integration mode.

When independent computation is off

Setting Scheduled Times for Real-Time Integration (Real-time Control)

4. Tap **Real-time Control**. The following screen appears.
The Real-time Control button appears when the integration mode is set to R-Normal or R-Continuous.

- **When Independent Integration Is Disabled**

Set the scheduled start and stop times
(Year/month/day, 00 hours : 00 minutes : 00 seconds to 23 hours : 59 minutes : 59 seconds).

Scheduled integration start time

Start Time
2018/01/01 00:00:00

Tap Start.

Set the scheduled time to the current time.

Real-time Control

Start 2018 / 01 / 01 00 : 00 : 00 Copy Current Time

End 2018 / 01 / 01 01 : 00 : 00 Copy Start Time

Tap End.

Set the scheduled time to the integration start time.

End Time
2018/01/01 01:00:00

Scheduled integration end time

- **When Independent Integration Is Enabled**

Real-time Control

Real-time Control

Tap Real-time Control.

Select the schedule setup method (Each, All).
When you select Each, you can set the schedule for each input element.

Real-time Control

Setting Each All

Element 1	Start	2018 / 01 / 01	00 : 00 : 00	Copy Current Time
	End	2018 / 01 / 01	01 : 00 : 00	Copy Start Time
Element 2	Start	2018 / 01 / 01	01 : 00 : 00	Copy Current Time
	End	2018 / 01 / 01	02 : 00 : 00	Copy Start Time
Element 3	Start	2018 / 01 / 01	02 : 00 : 00	Copy Current Time
	End	2018 / 01 / 01	03 : 00 : 00	Copy Start Time
Element 4	Start	2018 / 01 / 01	03 : 00 : 00	Copy Current Time
	End	2018 / 01 / 01	04 : 00 : 00	Copy Start Time
Element 5	Start	2018 / 01 / 01	04 : 00 : 00	Copy Current Time
	End	2018 / 01 / 01	05 : 00 : 00	Copy Start Time
Element 6	Start	2018 / 01 / 01	05 : 00 : 00	Copy Current Time
	End	2018 / 01 / 01	06 : 00 : 00	Copy Start Time
Element 7	Start	2018 / 01 / 01	06 : 00 : 00	Copy Current Time
	End	2018 / 01 / 01	07 : 00 : 00	Copy Start Time

Set the scheduled time to the current time.

Set the scheduled time to the integration start time.

Set the scheduled start time and scheduled end time (year/month/day, 00 hours : 00 minutes : 00 seconds-23 hours : 59 minutes : 59 seconds).

Setting Independent Integration (Independent Control)

4. Tap **Independent Control**. Element numbers appear.
5. Tap within the element number display frame. The following screen appears.

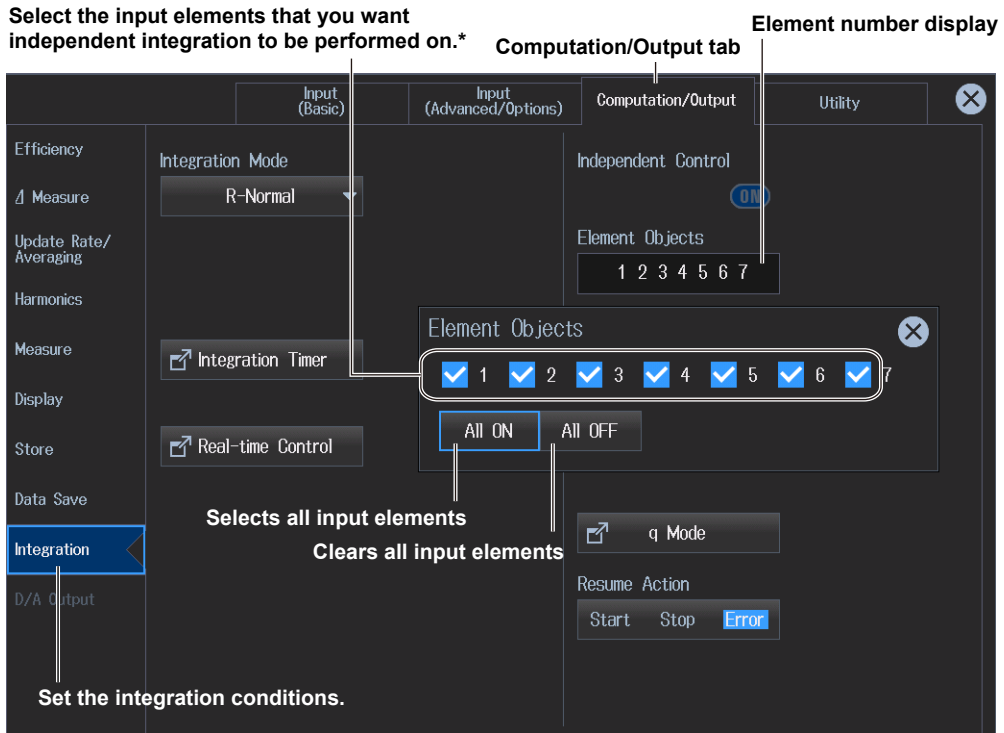

* Even if you select input elements that independent integration will be performed on, independent integration may not be performed due to the wiring system setting or the independent input element configuration (see the features guide).
When the update mode is Auto, you cannot start integration if independent computation is set to ON.

Setting the Watt-Hour Integration Method for Each Polarity (WP± Type)

4. Tap **WP± Type**. The following screen appears.

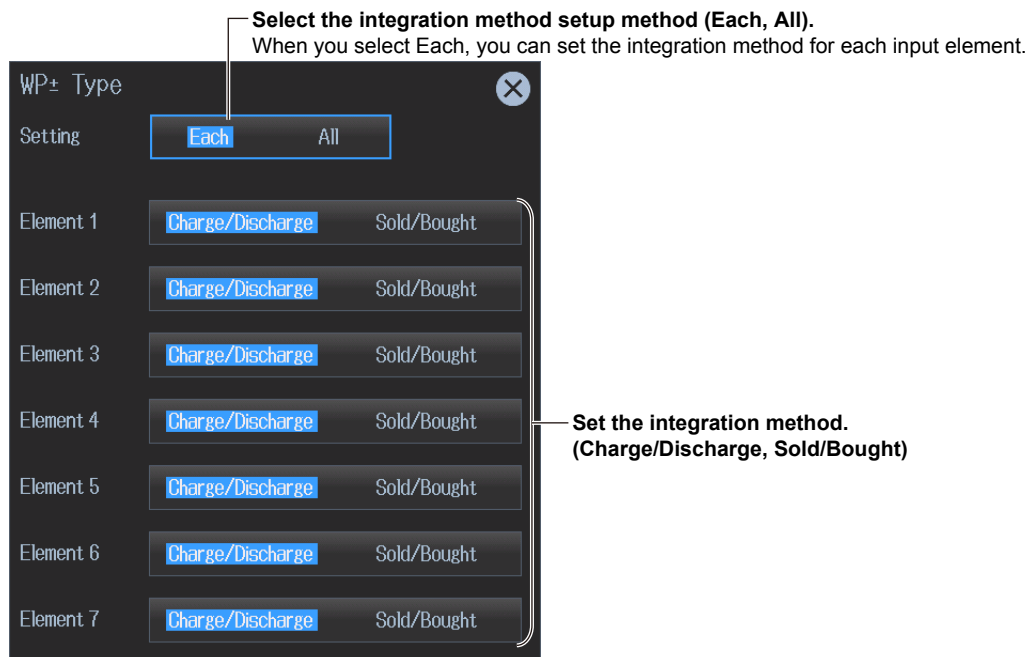

Setting the Current Mode for Current Integration (q Mode)

4. Tap **q Mode**. The following screen appears.

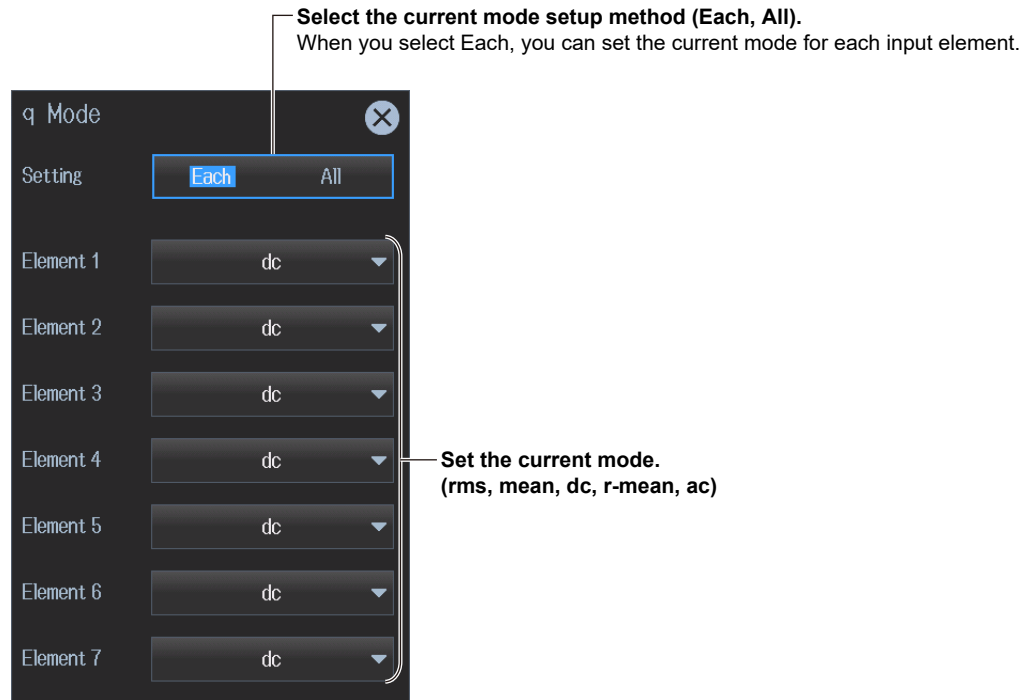

Procedure Using the Menu Icons

You can also use the menu icons shown on the right side of the screen to set the integration conditions.

1. Tap the **Integration** menu icon . An Integration menu appears in the sub menu area on the right side of the screen.
By tapping the displayed items, you can specify the same settings as when using the screen explained earlier.

Note

For details on the Integration menu, see page xii.

Procedure Using Keys

You can also use the front panel keys to set integration.



Set the integration conditions.
The Setup menu appears.

4.2 Displaying Integrated Values (numeric display)

This instrument calculates the integrated value of power (watt hours) and the integrated value of current (ampere hours) from the voltage and current applied to the input elements or wiring units and shows the measurements (measurement functions) on the screen.

► [“Starting, Stopping, and Resetting Integration” in the features guide](#)

Watt hours (WP, WP+, WP-) and ampere hours (q, q+, q-) do not require you to set equations. The values are simply shown on the screen when integration is started.

To determine the volt-ampere hours (WS) and var hours (WQ), you need to set the equations for apparent power (S) and reactive power (Q). For the setup procedure, see section 3.3.

Using an example, this section explains how to display integrated values numerically.

In addition, this section explains operating procedures using the following setup methods.

- Procedure Using the Setup Menu (see chapter 1)
- Procedure Using the Menu Icons (see page iii)
- Procedure Using the Keys (other than SETUP) (see section 1.2 in IM WT5000-03EN)

Measurement Display Screen (Example of a 4 items display)

Measurement display of input element 1

Measured sum of positive and negative watt hours Measured volt-ampere hours

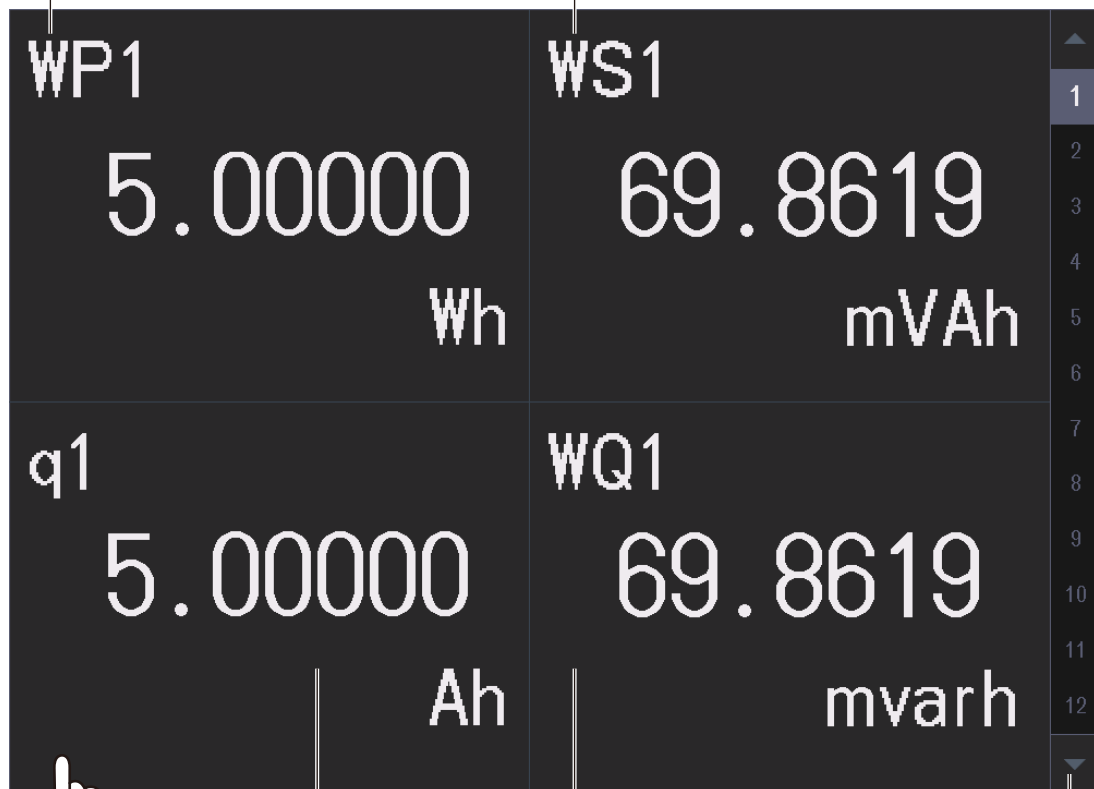

Measured sum of positive and negative ampere hours

If you hold your finger down on the 4-, 8-, 16-value, matrix or harmonics display for at least 1 second, you can perform the operations described in “Switching the Displayed Items (Items),” provided later.

Note

Integrated values can be shown graphically.

- The trend display (see section 6.3) shows integrated values graphically.

Measured var hours

Switches the displayed page (Page Up/Page Down)
Switches to the measurement display of another input element. Tap ▲ or ▼ to change the displayed page in order from the current number. Tap the number directly to change to the number display page.

Procedure Using the Setup Menu

1. Tap the **Setup** icon , or press **MENU** under SETUP.
2. Tap **Computation/Output** tab. A computation and output settings overview screen appears. Pressing **ESC** closes the overview screen.

Switching the Displayed Items (Item)

You can switch the measured value (measurement function) shown in the screen.

3. Tap **Display**.
A display format setup screen (Numeric/Graph) appears. For details, see section 3.1.
4. Tap **Items**. The following screen appears.

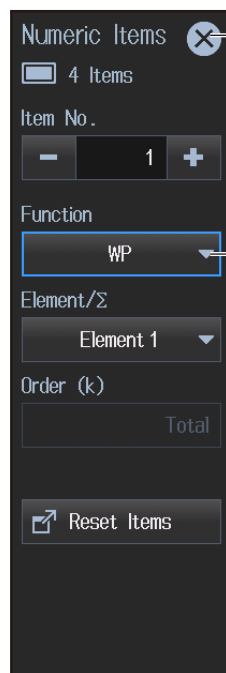

 Closes the menu

 Set the displayed item.

You can set the following items for displaying integration.

Integrated value (Integration group):

ITime (integration time), **WP** (sum of positive and negative watt hours),

WP+(sum of positive P values), **WP-** (sum of negative P values),

q (sum of positive and negative ampere hours), **q+** (sum of positive I values),

q- (sum of negative I values), **WS** (volt-ampere hour), **WQ** (var hours)

Procedure Using the Menu Icons

You can also use the menu icons shown on the right side of the screen to switch the displayed items.

1. Tap the **Display** menu icon . A Display menu appears in the sub menu area on the right side of the screen.
By tapping the displayed items, you can specify the same settings as when using the screen explained earlier.

Note

For details on the Display menu, see page iv.

Starting, Stopping, and Resetting Integration (Start/Stop/Reset)

1. Tap the **Integration** menu icon . An Integration menu appears in the sub menu area on the right side of the screen.

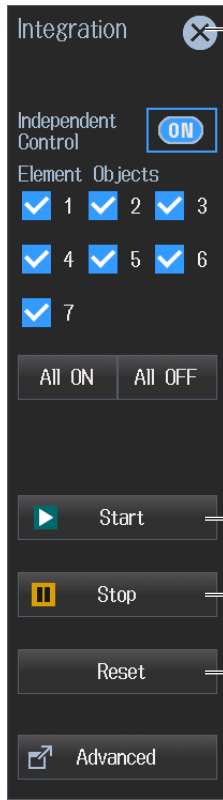

Integration ✕ **Closes the menu**

Independent Control **ON**

Element Objects

1 2 3

4 5 6

7

All ON All OFF

Start **Starts integration.**
Integration starts according to the specified integration conditions (see section 4.1). The START key in the INTEGRATION area turns on.

Stop **Stops integration.**
Integration stops automatically according to the specified integration conditions. The START key in the INTEGRATION area turns off, and the STOP key turns on.

Reset **Resets the integration time and integrated value.**
All integration data is deleted, and the no-data display, "-----," appears. The STOP key in the INTEGRATION area turns off.

Advanced

Integration Status Display

The integration status (running, paused, end), independent integration on/off state, integration time, and so on are shown at the top of the screen.

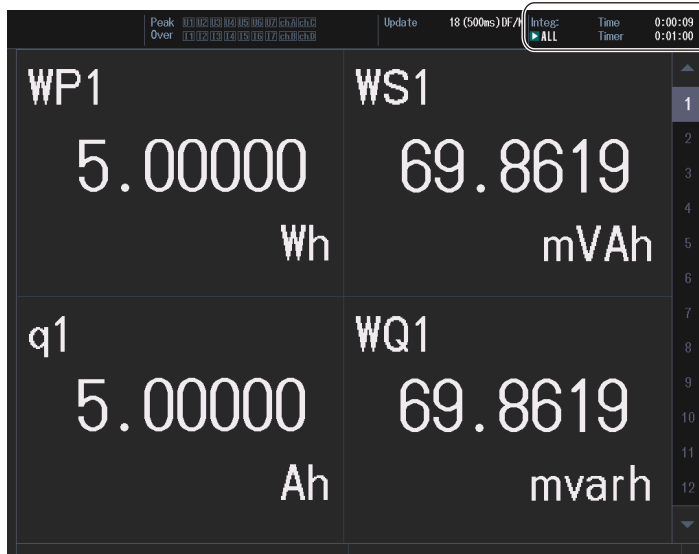

Peak Over: 01:02:03 04:05:06 07:08:09 10:11:12 13:14:15 16:17:18 19:20:21
Update: 18 (500ms) DF/n

Integ: ALL Time: 0:00:09
Timer: 0:01:00 **Integration Information**

WP1	WS1
5.00000	69.8619
Wh	mVAh
q1	WQ1
5.00000	69.8619
Ah	mvarh

Integration Information

When Independent Integration Is Disabled

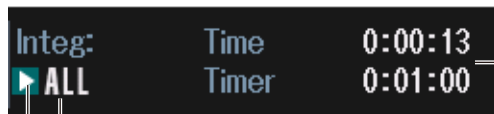

Elapsed time, timer ,etc.

All elements are controlled simultaneously, and shared information (e.g., elapsed time, timer) are shown.

Integration status display (running, paused, ended)

This is the same display as when independent integration is off (see below).

When independent integration is enabled



Selected elements are controlled independently (e.g., elapsed time, start time), and integration information (e.g., elapsed time, timer) is shown for each element. Press ELEMENTS (appropriate number) in the ELEMENTS/RANGE area to switch the displayed integration information of each element.



Example: Integration running on elements 1 to 3

When integration starts, the elements selected for integration execution show START icons.



Example: Integration paused on elements 1 to 3

When integration stops, the elements selected for integration execution show STOP icons. If you start it again, the icons change to START, and integration resumes.



Example: Integration ended on elements 1 to 3

When integration ends after the specified timer value elapses or when the scheduled real-time integration time is reached, the elements selected for integration execution show STOP icons. Unlike pausing, you need to reset the integration after it ends to start the integration again.

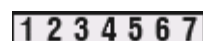

When you execute reset, the integration information is cleared, and the STOP icons return to displaying numbers.

Procedure Using Keys

You can also use the front panel keys to start, end, and reset integration.

INTEGRATION



Resets the integration status

ERROR indicator

Lights when an integration error occurs. In this situation, an error message appears at the top of the screen. For more information about how to handle error messages, see appendix 1.

Stops integration.

Starts integration.

5.1 Setting Harmonic Measurement Conditions

- ▶ “Input Element Group (Elements)” in the features guide
- ▶ “PLL Source (PLL Source)” in the features guide
- ▶ “Measured Harmonic Orders (Min Order/Max Order)” in the features guide
- ▶ “Distortion Factor Equation (Thd Formula)” in the features guide
- ▶ “Number of FFT Points (FFT Points)” in the features guide
- ▶ “Anti-Aliasing Filter” in the features guide

This section explains operating procedures using the following setup methods.

- Procedure Using the Setup Menu (see chapter 1)
 - * For the operation to perform harmonic measurements in accordance with IEC 61000-4-7, see chapter 13. In IEC Harmonic measurement, there is a limitation on the measurement functions that can be measured. See the appendix in the Getting Started Guide, IM WT5000-03EN.

Procedure Using the Setup Menu

1. Tap the **Setup** icon , or press **MENU** under **SETUP**.
2. Tap **Computation/Output** tab. A computation and output settings overview screen appears. Pressing **ESC** closes the overview screen.

Setting the Harmonic Measurement (Harmonics)

3. Tap **Harmonics**. A harmonic measurement setup screen appears.

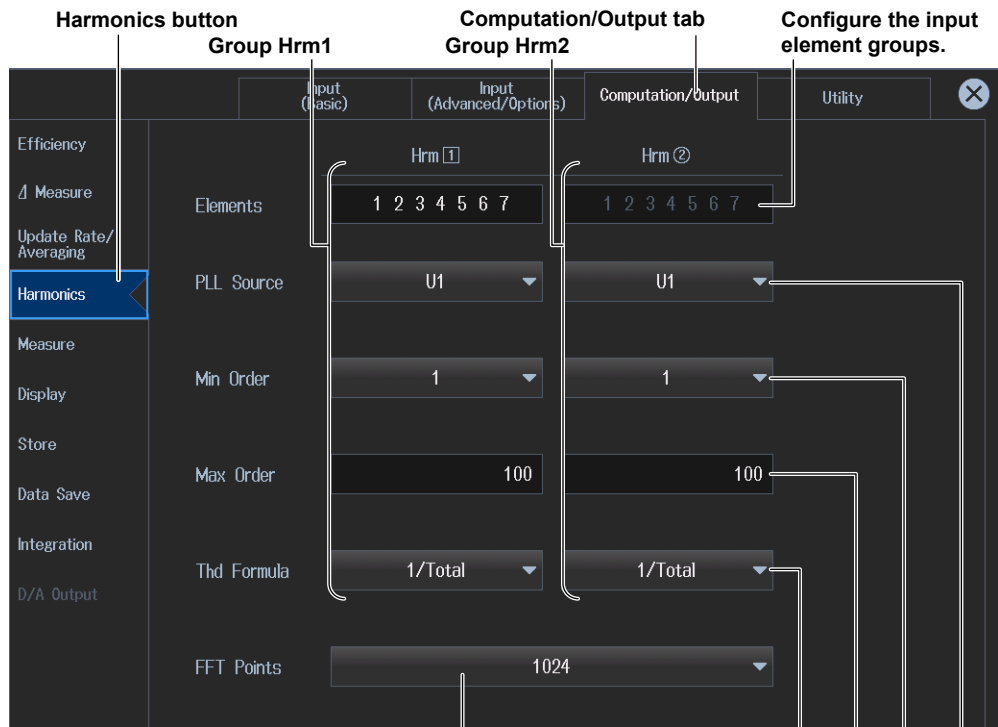

Set the number of FFT points (1024, 8192).

Set the distortion factor equation (1/Total, 1/Fundamental).

Set the maximum value of the measured harmonic order (1 to 500).

Set the minimum value of the measured harmonic order (0, 1).

Set the PLL source (U1 to U7, I1 to I7, Ext Clk).

5.1 Setting Harmonic Measurement Conditions

Note

You can also display the computation/output settings overview screen by moving the cursor on the Computation/Output tab using the arrow keys and then pressing SET.

Setting the Input Element Group (Element Set)

4. Tap **Elements**. The Element Settings screen appears.

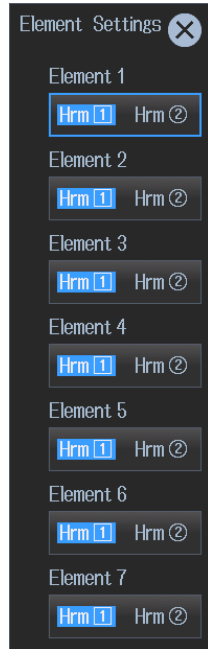

Configure the input element groups (Hrm 1, Hrm 2).
Input elements that are assigned to the same wiring unit are set to the same group.

5.2 Displaying Harmonic Measurements (numeric display)

This instrument shows on the screen the harmonic measurements (measurement functions) of the voltage and current applied to the input elements or wiring units.

Using an example, this section explains how to display harmonic measurements numerically.

In addition, this section explains operating procedures using the following setup methods.

- Procedure Using the Setup Menu (see chapter 1)
- Procedure Using the Menu Icons (see page iii)

Measurement Display Screen (Example of a 4 items display)

Measurement display of input element 1



If you hold your finger down on the 4-, 8-, 16-value, matrix or harmonics display for at least 1 second, you can perform the operations described in "Switching the Displayed Items (Items)," provided later.

Measured harmonic current (50th harmonic)

Measured harmonic power factor (50th harmonic)

Switches the displayed page (Page Up/Page Down)

Switches to the measurement display of another input element Tap ▲ or ▼ to change the displayed page in order from the current number. Tap the number directly to change to the number display page.

Note

Harmonic measurements can be shown graphically.

- The trend display (see section 6.3) shows harmonic measurements graphically.
- The bar graph display (see section 6.4) shows the magnitude of each harmonic graphically.
- The vector display (see section 6.5) shows the phase difference and the magnitude relationship between fundamental waves U(1) and I(1) of each element in the wiring unit.

Procedure Using the Setup Menu

1. Tap the **Setup** icon  or press **MENU** under SETUP.
2. Tap **Computation/Output** tab. A computation and output settings overview screen appears.
Pressing **ESC** closes the overview screen.

Switching the Displayed Items (Items)

You can switch the measured value (measurement function) shown in the screen.

3. Tap **Display**.
A display format setup screen (Numeric/Graph) appears. For details, see section 3.1.
4. Tap **Items**. The following screen appears.

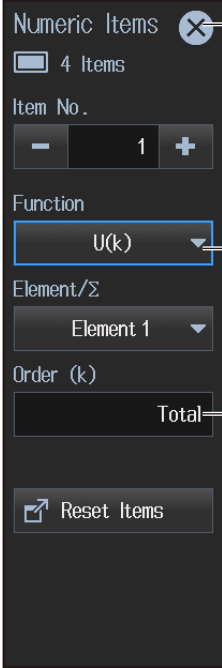

Closes the menu

Set the displayed item.
Set the displayed harmonic items. Scroll the display list, and select the displayed items from the following available items.

- Harmonic order k (Harmonics(k) Group):
 - U (k)** (rms voltage of harmonic order k), **I (k)** (rms current of harmonic order k),
 - P (k)** (active power of harmonic order k), **S (k)** (apparent power of harmonic order k),
 - Q (k)** (reactive power of harmonic order k), **λ(k)** (power factor of harmonic order k),
 - Φ(k)** (phase difference between the voltage and current of harmonic order k),
 - ΦU(k)** (phase difference between harmonic voltage U(k) and the fundamental wave U(1)),
 - ΦI(k)** (phase difference between harmonic current I(k) and the fundamental wave I(1)),
 - Z (k)** (load circuit impedance), **Rs (k)** (load circuit series resistance),
 - Xs (k)** (load circuit series reactance), **Rp (k)** (load circuit parallel resistance),
 - Xp (k)** (load circuit parallel reactance), **Uhd_f (k)** (harmonic voltage distortion factor),
 - Ihd_f (k)** (harmonic current distortion factor),
 - Phd_f (k)** (harmonic active power distortion factor),
- Harmonics (Harmonics Group):
 - Uthd** (total harmonic voltage distortion), **Ithd** (total harmonic current distortion),
 - Pthd** (total harmonic active power distortion),
 - Uthf** (voltage telephone harmonic factor),
 - Ithf** (current telephone harmonic factor)
 - Utif** (voltage telephone influence factor), **Itif** (current telephone influence factor),
 - hvf** (harmonic voltage factor), **hcf** (harmonic current factor),
 - K-factor** (K factor),
 - ΦUi-Uj** (phase difference between the fundamental voltage of element i, U_i(1), and the fundamental voltage of element j, U_j(1)),
 - ΦUi-Uk** (phase difference between U_i(1) and the fundamental voltage of element k, U_k(1)),
 - ΦUi-Ii** (phase difference between U_i(1) and the fundamental current of element i, I_i(1)),
 - ΦUj-Ij** (phase difference between U_j(1) and the fundamental current of element j, I_j(1)),
 - ΦUk-Ik** (phase difference between U_k(1) and the fundamental current of element k, I_k(1)),
- PLL source frequency (Frequency group):
 - FreqPLL1** (PLL1 frequency), **FreqPLL2** (PLL2 frequency)

Set the harmonic order (Total, 0, 1 to 500).

Procedure Using the Menu Icons

You can also use the menu icons shown on the right side of the screen to switch the displayed items.

1. Tap the **Display** menu icon . A Display menu appears in the sub menu area on the right side of the screen.
By tapping the displayed items, you can specify the same settings as when using the screen explained earlier.

Note

For details on the Display menu, see page iv.

6.1 Setting the Display Format

▶ “Switching the Displayed Page (Page Scroll)” in the features guide

This section explains operating procedures using the following setup methods.

- Procedure Using the Setup Menu (see chapter 1)
- Procedure Using the Menu Icons (see page iii)
- Procedure Using the Keys (other than SETUP) (see section 1.2 in IM WT5000-03EN)

Procedure Using the Setup Menu

1. Tap the **Setup** icon , or press **MENU** under **SETUP**.
2. Tap **Computation/Output** tab. A computation and output settings overview screen appears. Pressing **ESC** closes the overview screen.

Setting the Display Format (Display)

3. Tap **Display**.
A display format setup screen (Numeric/Graph) appears.

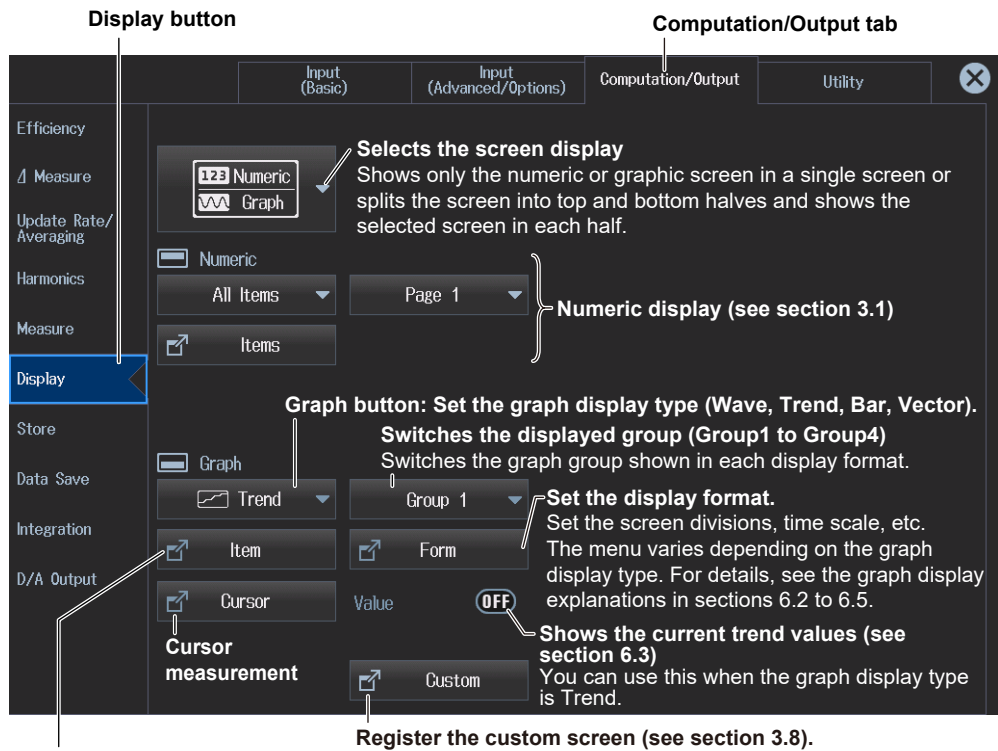

Switches the displayed items.
Select the measured values you want to graph. The menu varies depending on the graph display type. For details, see the graph display explanations in sections 6.2 to 6.5.

Note

You can also display the computation/output settings overview screen by moving the cursor on the Computation/Output tab using the arrow keys and then pressing SET.

Display settings

You can switch the display format of the Numeric (numeric display) and Graph (graph display) screens.

- Numeric (numeric display)**
Shows only numeric data in a single screen For details on the numeric display, see chapter 3.
- Graph (graph display)**
Shows only graphs in a single screen
- Numeric (numeric display)/Numeric (numeric display)**
Shows numeric data (see chapter 3) in the top and bottom halves of the screen
- Numeric (numeric display)/Graph(graph display)**
Shows numeric data (see chapter 3) in the top half of the screen and graphs in the bottom half
- Graph (graph display)/Numeric (numeric display)**
Show graphs in the top half of the screen and numeric data (see chapter 3) in the bottom half
- Graph (graph display)/Graph (graph display)**
Shows graphs in the top and bottom halves of the screen

Example of Numeric (numeric display)/Graph(graph display)

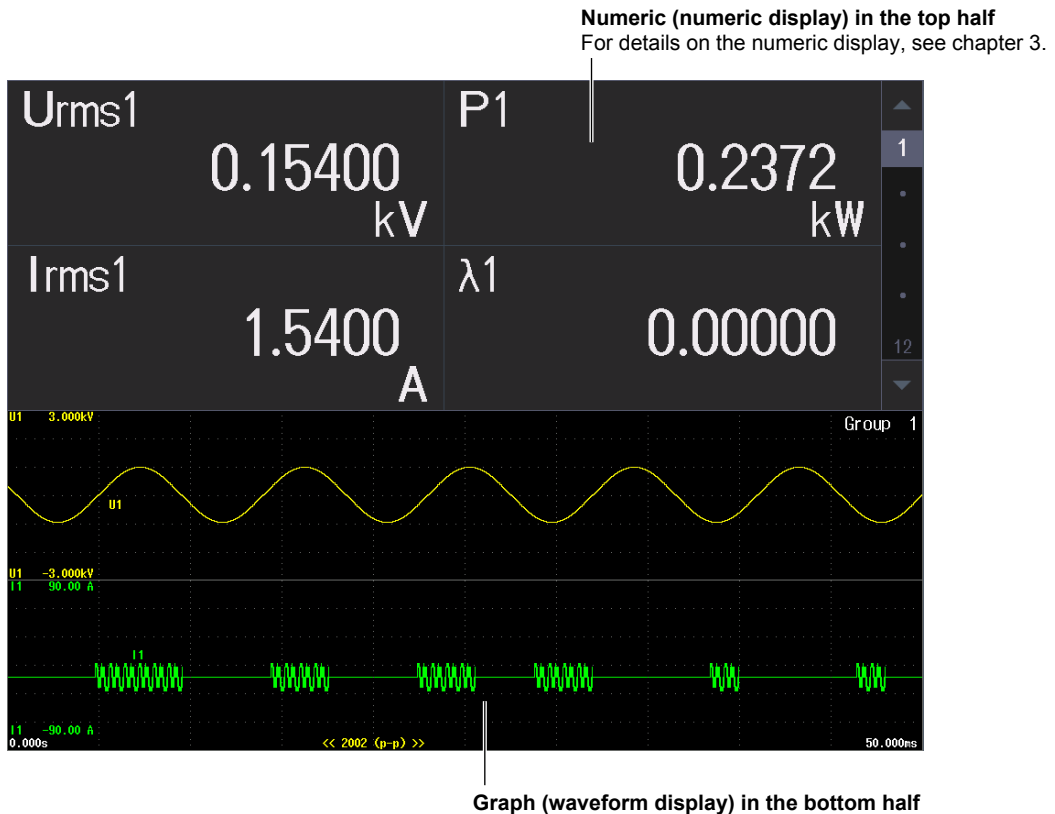

Procedure Using the Menu Icons

You can also use the menu icons shown on the right side of the screen to set the voltage range and current range.

1. Tap the **Display** menu icon . A Display menu appears in the sub menu area on the right side of the screen.

By tapping the displayed items, you can specify the same settings as when using the screen explained earlier.

Note

For details on the Display menu, see page iv.

Switching the Display Format (GRAPH key)

You can also use keys to perform “Setting the Screen Display” described earlier and “Setting the Graph Display Type.”

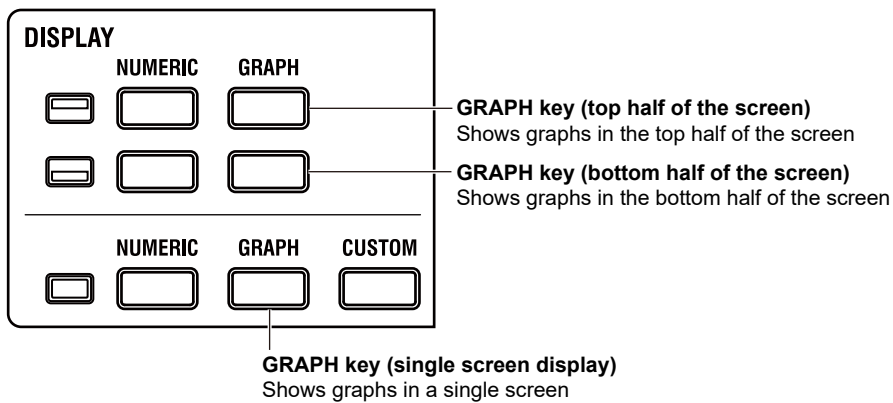

Each time you press GRAPH, the graph type switches, in order, between waveform, trend, bar graph, and vector.

6.2 Waveform Display

This instrument shows on the screen the waveforms of the voltage and current applied to the input elements or wiring units.

- ▶ “Waveform Display (Wave)” in the features guide
- ▶ “Display Format (Form, Wave)” in the features guide
- ▶ “Number of Windows (Format)” in the features guide
 - ▶ “Time Axis (Time/div)” in the features guide
 - ▶ “Vertical Axis (Amplitude)” in the features guide
- ▶ “Advanced Waveform Display Settings (Advanced)” in the features guide
- ▶ “Display Items (Items, Wave)” in the features guide

Using an example, this section explains how to display measurement results with waveforms. In addition, this section explains operating procedures using the following setup methods.

- Procedure Using the Setup Menu (see chapter 1)
- Procedure Using the Menu Icons (see page iii)

Waveform Display Screen (Example of group1 dual display)

Waveform display of input element 1

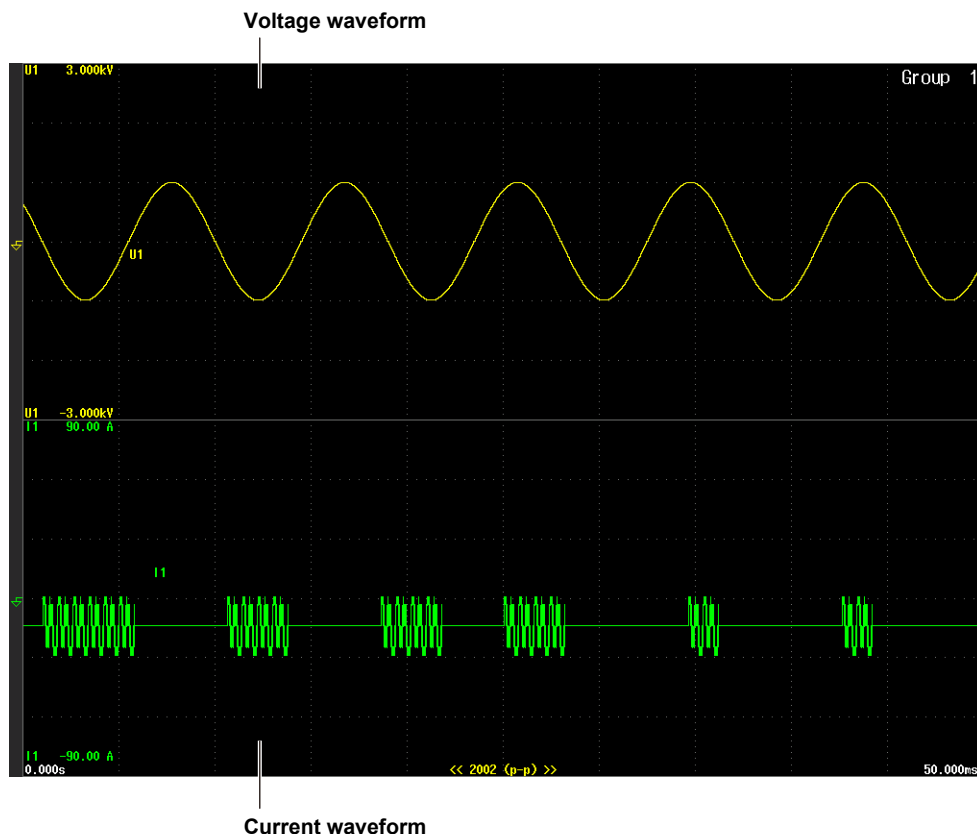

Procedure Using the Setup Menu

1. Tap the **Setup** icon  or press **MENU** under **SETUP**.
2. Tap **Computation/Output** tab. A computation and output settings overview screen appears. Pressing **ESC** closes the overview screen.
3. Tap **Display**.
A display format setup screen (Numeric/Graph) appears. For details, see section 6.1.

Setting the Graph Display Type (Graph)

- 4. Tap **Graph** to select Wave.

Switching the Displayed Group (Group)

- 5. Tap **Group** to select a group from Group1 to Group4.
You can select up to four groups. The Item and Form settings, explained later, are applied to the group numbers you select in this step.

Switching the Display Group When Displaying Graphs

Flick the Graph screen up or down to switch the display group.
The group number after switching is shown highlighted for a few seconds in the group display area in the upper right of the Graph screen.

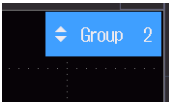

Switching the Displayed Items (Items)

Select the voltages and currents of the input elements to be displayed with waveforms.

- 6. Tap **Items**. A Wave Items screen appears.
- 7. Tap the **Display/Mapping** tab. Turn the display on or off, and map waveforms.

Display/Mapping tab Turns the preset item display on and off

Displayed item preset buttons Set waveform mapping (Auto, Fixed, User).

Item	Display	Map	Item	Display	Map	Item	Display	Map
U1	OFF	1	U5	OFF	5	Spd1	OFF	2
I1	OFF	1	I5	OFF	5	Trq1	OFF	2
U2	OFF	1	U6	OFF	6	Spd2	OFF	3

The display can be turned on or off for each item.

Waveform can be mapped for each item (windows 1 to 6).

- 7. Tap the **Zoom/Position** tab. Set the vertical zoom factor and vertical position.(U1 to U7, I1 to I7)

Zoom/Position tab

Item	Vertical Zoom	Vertical Position	Item	Vertical Zoom	Vertical Position
U1	x 1	0.000%	U5	x 1	0.000%
I1	x 1	0.000%	I5	x 1	0.000%
U2	x 1	0.000%	U6	x 1	0.000%

Set the vertical zoom factor.
(x 0.1, x 0.2, x 0.25, x 0.4, x 0.5, x 0.75, x 0.8, x 1, x 1.14, x 1.25, x 1.33, x 1.41, x 1.5, x 1.6, x 1.77, x 2, x 2.28, x 2.66, x 2.83, x 3.2, x 3.54, x 4, x 5, x 8, x 10, x 12.5, x 16, x 20, x 25, x 40, x 50, x 100)

Set the vertical position (0.000% to ±130.000%).

Setting the Display Format (Form)

Set the division of the waveform display screen and time scale (Time/div).

6. Tap **Form**. A Wave Form screen appears.

Closes the menu

Set the number of divisions of the waveform screen (Single, Dual, Triad, Quad, Hexa).

Set the time scale (0.01 ms to $\frac{\text{specified data update interval}^1}{10}$).

Configure the detailed settings of the waveform display.

1 For information on how to set the data update interval, see section 2.10.

(*): Common to All Groups
Items that are marked with (*) are shared among all groups.

Advanced Waveform Display (Advanced)

7. Tap **Advanced**. A Form screen appears.

Closes the menu

Set the display interpolation (selected, step, linear).

Set the grid (selected, none, grid).

Set the scale value display (OFF, ON).

Set the waveform label display (OFF, ON).

(*): Common to All Groups
Items that are marked with (*) are shared among all groups.

Procedure Using the Menu Icons

You can also use the menu icons shown on the right side of the screen to switch the displayed items.

1. Tap the **Display** menu icon . A Display menu appears in the sub menu area on the right side of the screen.

By tapping the displayed items, you can specify the same operation as explained in “Switching the Displayed Items” described earlier.

Note

For details on the Display menu, see page iv.

6.3 Trend display

This instrument shows on the screen the trend graphs of the voltage, current, and the like applied to the input elements or wiring units.

- ▶ “Trend Display (Trend)” in the features guide
- ▶ “Display Format (Form, Trend)” in the features guide
- ▶ “Display Items (Items, Trend)” in the features guide

Using an example, this section explains how to display measurement results with trend graphs. In addition, this section explains operating procedures using the following setup methods.

- Procedure Using the Setup Menu (see chapter 1)
- Procedure Using the Menu Icons (see page iii)

Trend Display Screen (Example of group1 dual display)

Trend display of input element 1

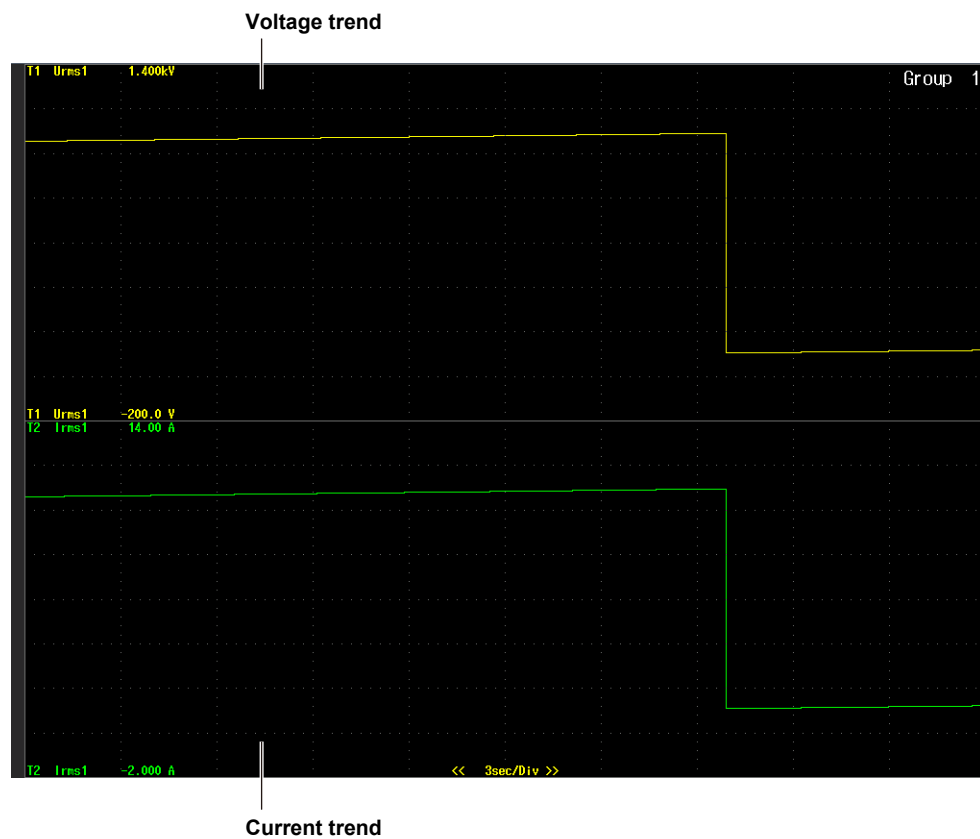

Procedure Using the Setup Menu

1. Tap the **Setup** icon , or press **MENU** under **SETUP**.
2. Tap **Computation/Output** tab. A computation and output settings overview screen appears. Pressing **ESC** closes the overview screen.
3. Tap **Display**.
A display format setup screen (Numeric/Graph) appears. For details, see section 6.1.

Setting the Graph Display Type (Graph)

4. Tap **Graph** to select Trend.

Switching the Displayed Group (Group)

5. Tap **Group** to select a group from Group1 to Group4.

You can select up to four groups. The Item and Form settings, explained later, are applied to the group numbers you select in this step.

Switching the Display Group When Displaying Trends

Like the graph display, flick to switch the display group (see section 6.2).

Switching the Displayed Items (Items)

Select the voltages and currents of the input elements to be displayed with trends.

6. Tap **Items**. A Trend Items screen appears.

Set the graphs of trend 1 to trend 8.

Set the graphs of trend 1 to trend 8.

Turns the display of all waveforms on

Turns the display of all waveforms off



Items that are marked with (*) are shared among all groups.

Set the upper and lower limits (-9.999 T to 9.999 T).

These settings can be set when vertical scale mode is set to Manual.

Select the vertical scale's setup method (Auto, Manual).

Set the harmonic order (Total, 0 to 500).

You can set this setting when the measurement function includes a harmonic order.

Selects the input element or wiring unit to be configured

- Input element options

When the displayed item is set to something other than motor evaluation: Element1 to Element7

When the displayed item is set to motor evaluation: Motor1 to Motor4

- Wiring unit options: ΣA, ΣB, ΣC

Set the measurement function (for details on the various measurement functions, see "Items That This Instrument Can Measure" in the features guide).

Select the trends that you want to display.

Setting the Display Format (Form)

Set the division of the trend display screen and time scale (Time/div).

6. Tap **Form**. A Trend Form screen appears.

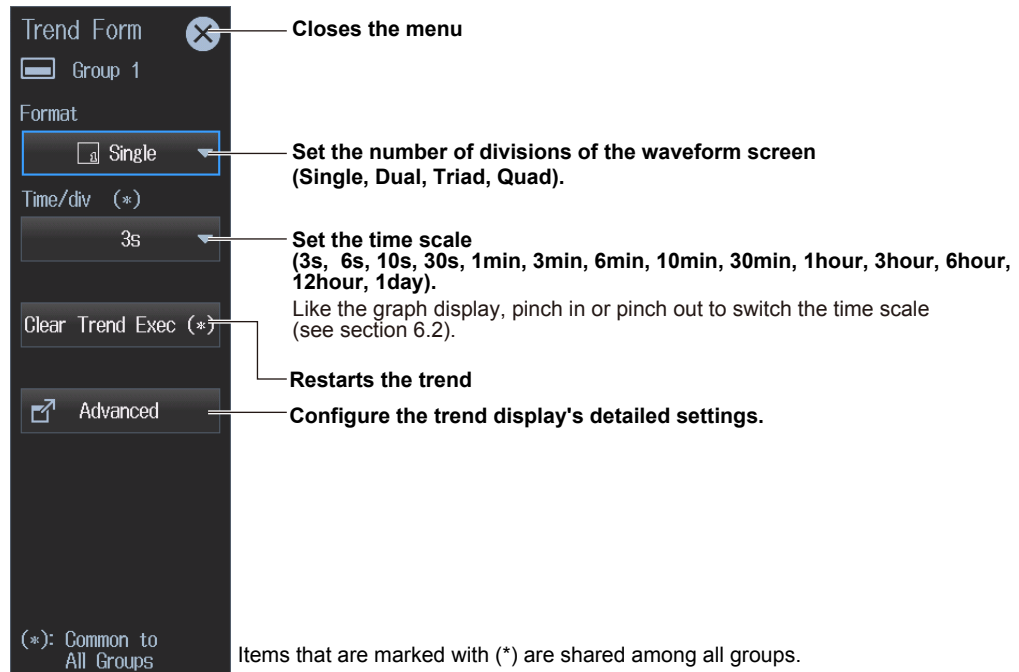

Advanced Waveform Display (Advanced)

7. Tap **Advanced**. A Form screen appears.

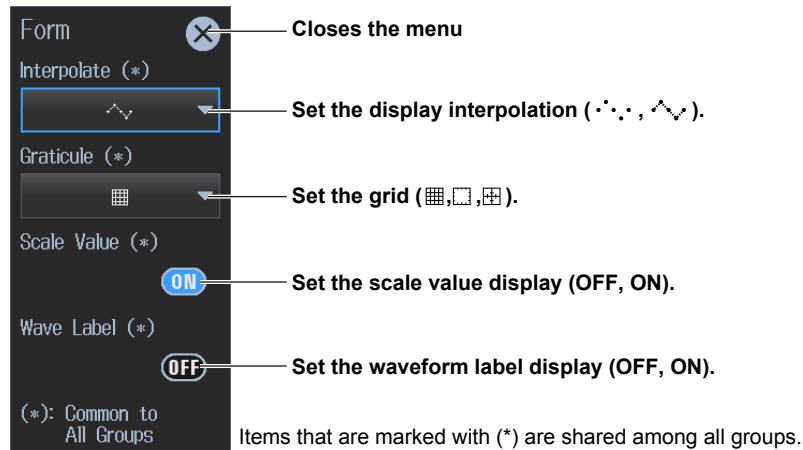

Displaying the Current Trend Values (Value)

6. Tap **Value**. The current value is displayed on the trend display. Tapping Value again clears the Value display.

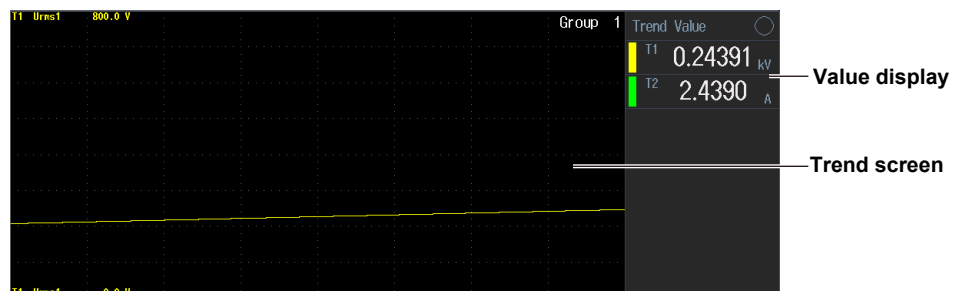

Procedure Using the Menu Icons

You can also use the menu icons shown on the right side of the screen to switch the displayed items.

1. Tap the **Display** menu icon . A Display menu appears in the sub menu area on the right side of the screen.

By tapping the displayed items, you can specify the same operation as explained in “Switching the Displayed Items” described earlier.

Note

For details on the Display menu, see page iv.

6.4 Bar Graph Display

This instrument shows on the screen the harmonic orders and magnitudes of the voltage, current, and the like applied to the input elements with bar graphs.

- ▶ “Bar Graph Display (Bar)” in the features guide
- ▶ “Display Format (Form, Bar)” in the features guide
- ▶ “Display Items (Items, Bar)” in the features guide

Using an example, this section explains how to display measurement results with bar graphs. In addition, this section explains operating procedures using the following setup methods.

- Procedure Using the Setup Menu (see chapter 1)
- Procedure Using the Menu Icons (see page iii)

Bar Graph Display Screen (example of Group1 Triad display)

Bar graph display of input element 1

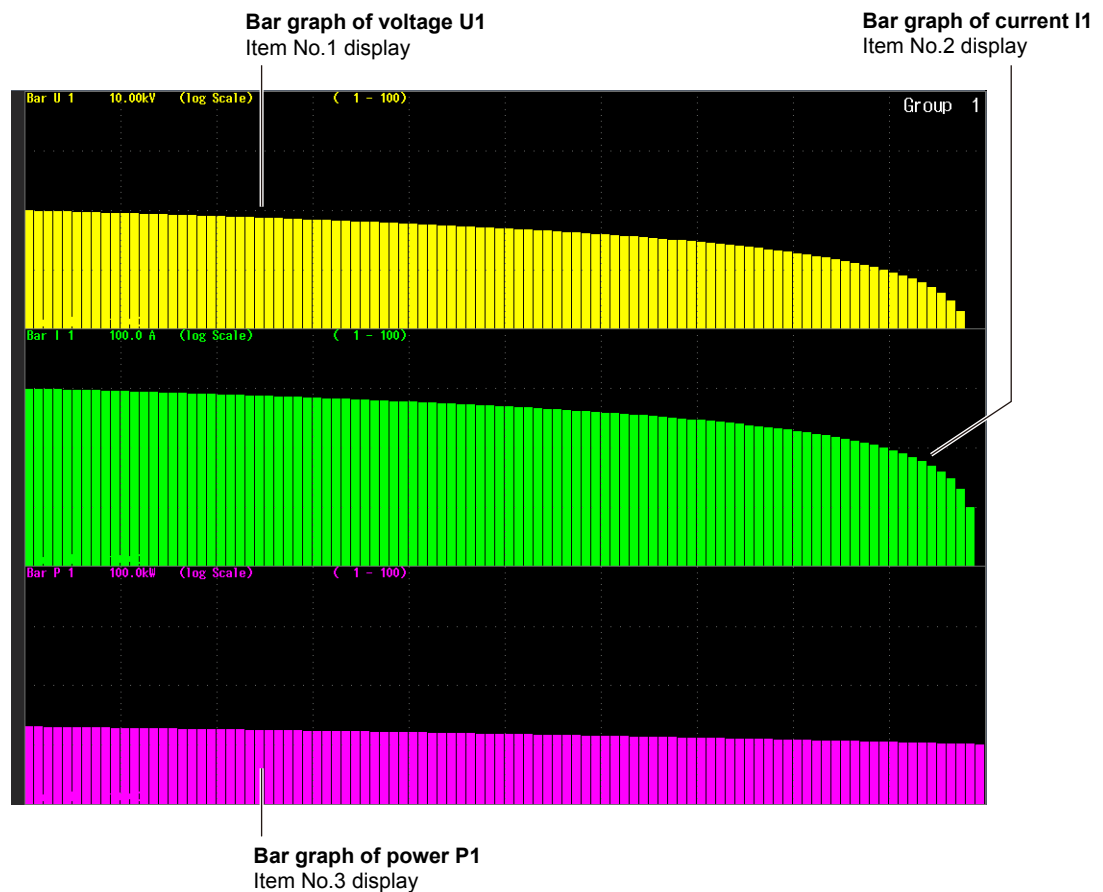

Procedure Using the Setup Menu

1. Tap the **Setup** icon , or press **MENU** under **SETUP**.
2. Tap **Computation/Output** tab. A computation and output settings overview screen appears. Pressing **ESC** closes the overview screen.
3. Tap **Display**.
A display format setup screen (Numeric/Graph) appears. For details, see section 6.1.

Setting the Bar Graph Display Type (Graph)

4. Tap **Graph** to select Bar.

Switching the Displayed Group (Group)

5. Tap **Group** to select a group from Group1 to Group4.
You can select up to four groups. The Item and Form settings, explained later, are applied to the group numbers you select in this step.

Switching the Display Group When Displaying Bar Graphs

Like the graph display, flick to switch the display group (see section 6.2).

Switching the Displayed Items (Items)

Select the voltages and currents of the input elements to be displayed with bar graphs.

6. Tap **Items**. The following screen appears.

Select the displayed item number.

The number increases from top to bottom on the bar graph screen. To show the No.2 and No.3 item numbers on the bar graph display, set the screen division to Dual or triad in the display format settings explained later.

Closes the menu

Set the displayed item.
You can set the following items for displaying measurement functions.
U (harmonic voltage), **I** (harmonic current), **P** (harmonic active power),
S (harmonic apparent power), **Q** (harmonic reactive power),
λ (harmonic power factor),
Φ (phase difference between harmonic voltage and harmonic current),
ΦU (phase difference between each harmonic voltage and the fundamental wave),
ΦI (phase difference between each harmonic current and the fundamental wave),
Z (load circuit impedance), **Rs** (load circuit series resistance),
Xs (load circuit series reactance), **Rp** (load circuit parallel resistance),
Xp (load circuit parallel reactance)

Input element to be configured (Element1 to Element7)

Select the vertical scale's setup method (Fixed, Manual).

Set the vertical scale type (Linear, Log).
This soft key is displayed when you set the vertical scale mode to Manual.

Set the upper limit (0 to 9.999 T).
This soft key is displayed when you set the vertical scale mode to Manual.

Set the X-axis position (Bottom, Center).
This soft key is displayed when you set Scale Mode to Manual and Vertical Scale to Linear.

Setting the Display Format (Form)

Set the divisions of the bar graph screen and the range of harmonic orders to display (Start Order, End Order).

6. Tap **Form**. A Bar Form screen appears.

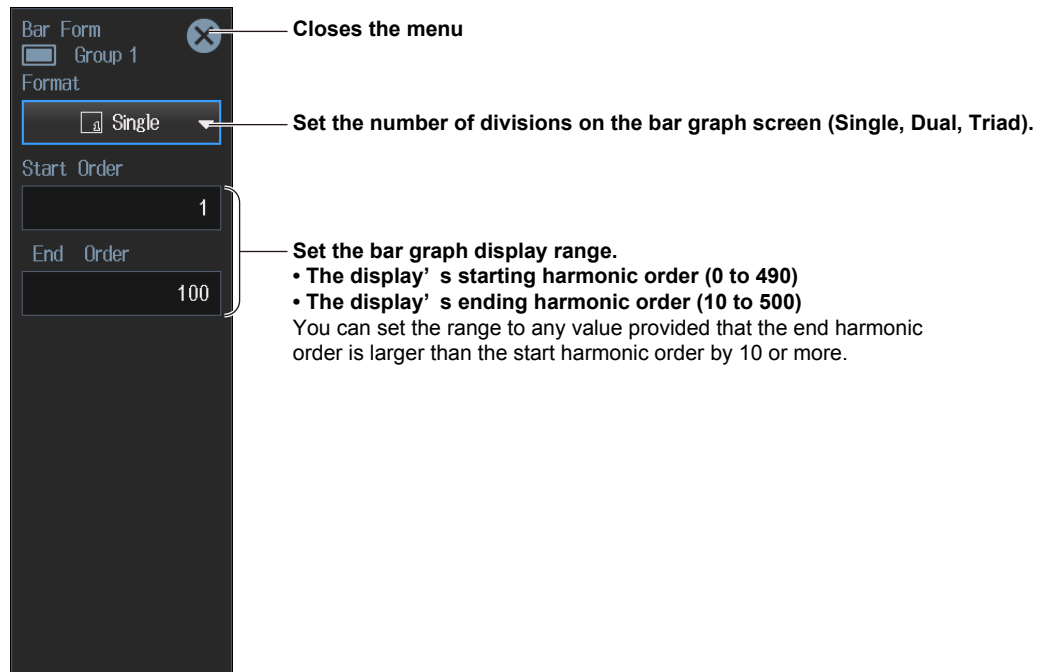

Procedure Using the Menu Icons

You can also use the menu icons shown on the right side of the screen to switch the displayed items.

1. Tap the **Display** menu icon . A Display menu appears in the sub menu area on the right side of the screen.

By tapping the displayed items, you can specify the same operation as explained in "Switching the Displayed Items" described earlier.

Note

For details on the Display menu, see page iv.

6.5 Vector Display

This instrument shows on the vector screen the phase difference and the magnitude relationship between fundamental waves and harmonic waves of the voltage, current, and the like applied to wiring units.

- ▶ “Vector Display (Vector)” in the features guide
- ▶ “Display Format (Form, Vector)” in the features guide
- ▶ “Display Items (Items, Vector)” in the features guide

Using an example, this section explains how to display measurement results with vectors.

In addition, this section explains operating procedures using the following setup methods.

- Procedure Using the Setup Menu (see chapter 1)
- Procedure Using the Menu Icons (see page iii)

Vector Display Screen (example of Group1 ΣA display)

Vector display of wiring unit A

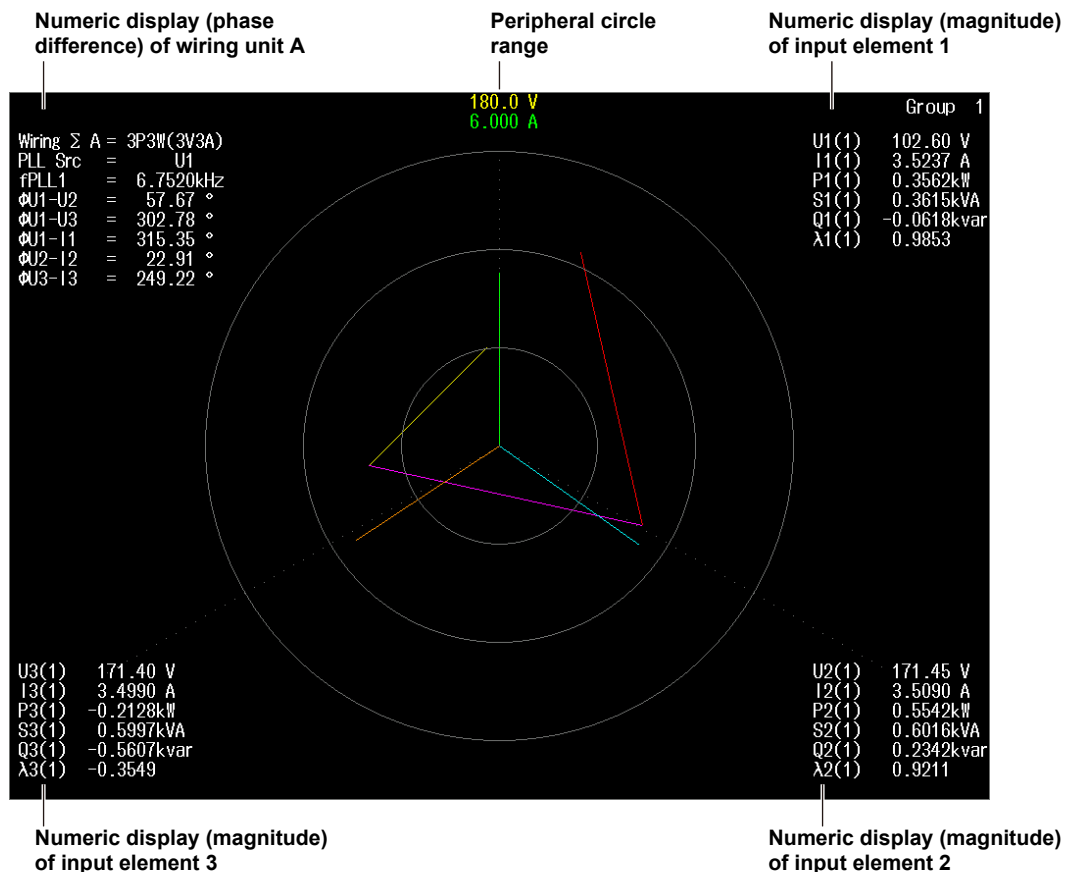

Procedure Using the Setup Menu

1. Tap the **Setup** icon  or press **MENU** under **SETUP**.
2. Tap **Computation/Output** tab. A computation and output settings overview screen appears. Pressing **ESC** closes the overview screen.
3. Tap **Display**.
A display format setup screen (Numeric/Graph) appears. For details, see section 6.1.

Setting the Graph Display Type (Graph)

4. Tap **Graph** to select Vector.

Switching the Displayed Page (Group)

5. Tap **Group** to select a group from Group1 to Group4.
You can select up to four groups. The Item and Form settings, explained later, are applied to the group numbers you select in this step.

Switching the Display Group When Displaying Vectors

Like the graph display, flick to switch the display group (see section 6.2).

Switching the Displayed Items (Items)

Select the input element or wiring unit to display the vectors of.

6. Tap **Items**. A Vector Items screen appears.

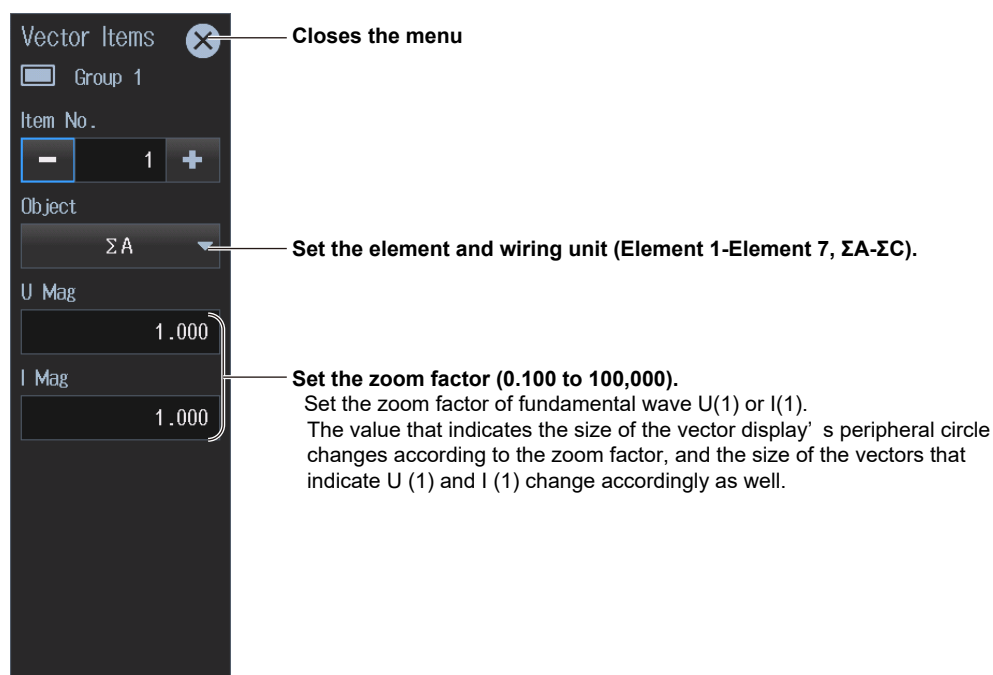

Example of a Vector Split Display

Select Graph/Graph according to “Setting the Screen Display” in section 6.1. On the split display, only the vectors of Item No.1 are displayed, so select the vectors to show in the second screen according to the group settings described earlier. If you select single screen display for Graph in “Setting the Screen Display” in section 6.1, you can also show the same split display by performing the procedure in “Setting the Display Format (Form)” described below.

Set Graph of Group1 to Vector.

Example of Item No. set to 1 and Object set to ΣA

(see “Switching the Displayed Items (Items)” on the previous page)

Set the display to Graph/Graph.

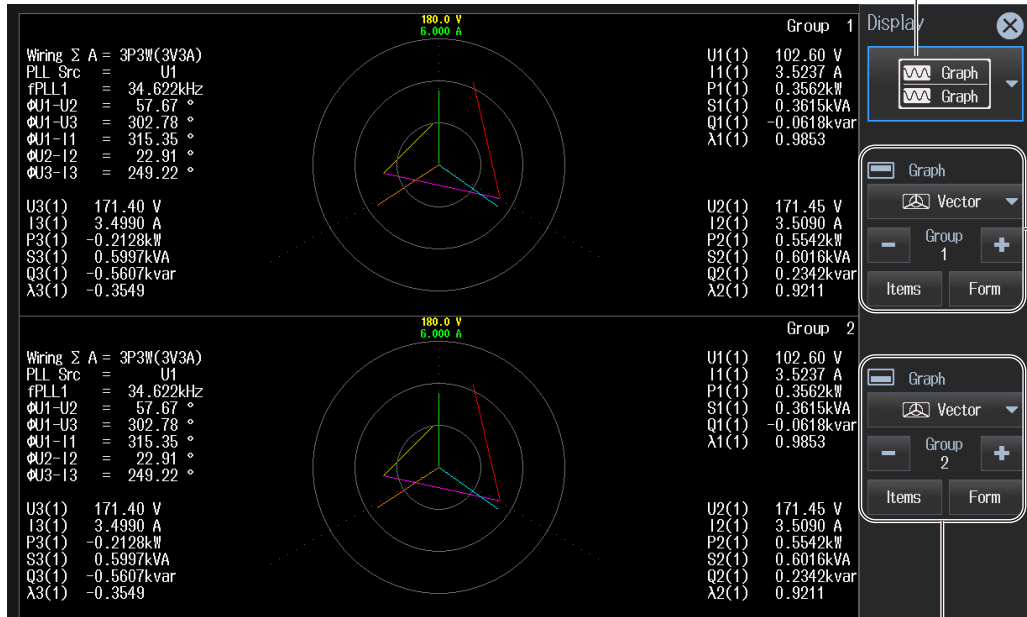

Set Graph of Group2 to Vector.

Example of Item No. set to 1 and Object set to ΣB

(see “Switching the Displayed Items (Items)” on the previous page)

Setting the Display Format (Form)

Set whether to show numeric data on the Graph screen.

6. Tap **Form**. A Vector Form screen appears.

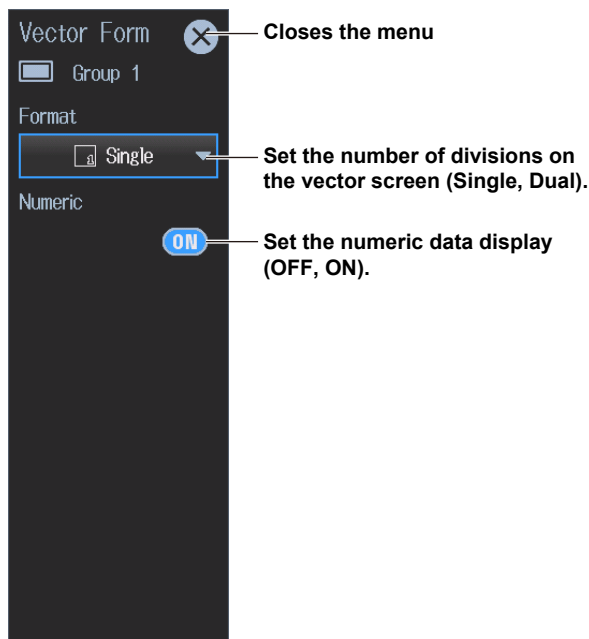

To divide the vector screen, in “Switching the Displayed Items (Items)” on page 6-15, set the object each Item No. to the item you want to show.

Setup example

Set this to 1.

Set this to 2.



Set this to ΣA .

Set this to ΣB .

Procedure Using the Menu Icons

You can also use the menu icons shown on the right side of the screen to switch the displayed items.

1. Tap the **Display** menu icon . A Display menu appears in the sub menu area on the right side of the screen.

By tapping the displayed items, you can specify the same operation as explained in “Switching the Displayed Items” described earlier.

Note

For details on the Display menu, see page iv.

7.1 Setting the Storage Operation

- ▶ “Data Storage (Store, MENU (STORE))” in the features guide
- ▶ “Storage Control” in the features guide

This section explains operating procedures using the following setup methods.

- Procedure Using the Setup Menu (see chapter 1)
- Procedure Using the Menu Icons (see page iii)
- Procedure Using the Keys (other than SETUP) (see section 1.2 in IM WT5000-03EN)

Procedure Using the Setup Menu

1. Tap the **Setup** icon , or press **MENU** under SETUP.
2. Tap **Computation/Output** tab. A computation and output settings overview screen appears. Pressing **ESC** closes the overview screen.

Configuring the Storage (Store)

3. Tap **Store**.
A Store screen appears.

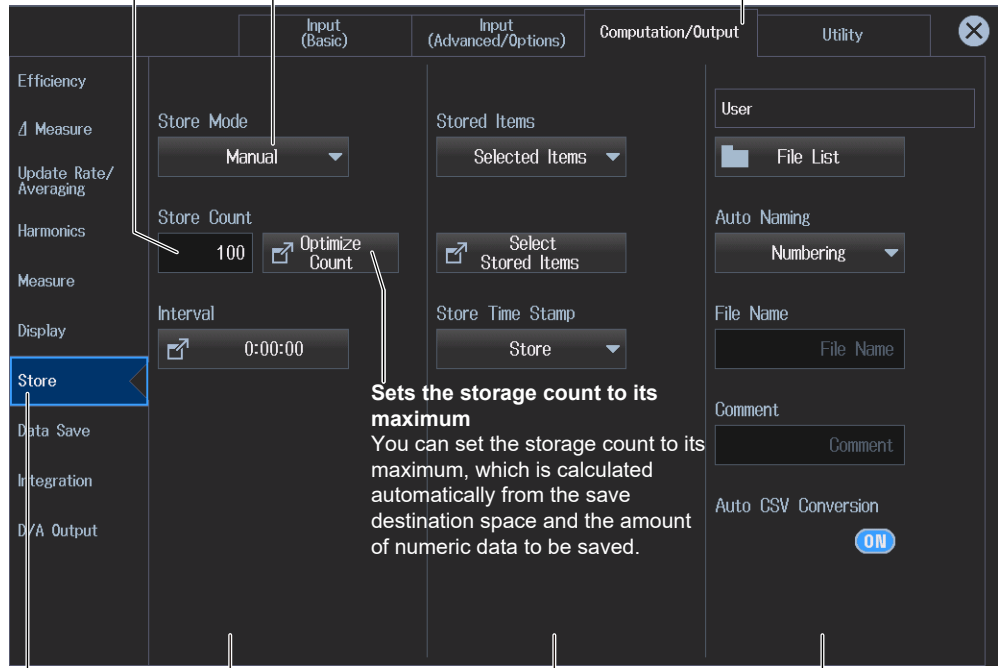

Set the storage count (Infinite, 1 to 9999999)

Set the storage mode (Manual, Real Time, Integ Sync, Event, Single Shot).

Computation/Output tab

Configure the storage.

Sets the storage count to its maximum
You can set the storage count to its maximum, which is calculated automatically from the save destination space and the amount of numeric data to be saved.

See “Configuring the Storage Control (Control Settings)” on the next page.

See section 7.2.

See section 7.3.

Note

You can also display the computation/output settings overview screen by moving the cursor on the Computation/Output tab using the arrow keys and then pressing SET.

7.1 Setting the Storage Operation

Setting the Maximum Storage Count

Tap **Optimize Count**, which is used to set the maximum storage count. An Optimize Count screen appears.

Confirms and optimizes the maximum storage count

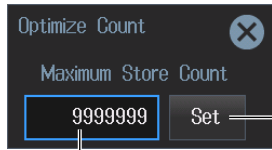

Sets the storage count

The storage count is set to the maximum storage count displayed to the left.

Maximum storage count (0-the maximum number of times that data can be stored to the save destination)

If the save destination is set to a USB memory device (drive) and you remove it, the save destination automatically changes to internal memory. If you close this screen, tap Optimize Count, and reopen this screen, the maximum storage count is changed to a value determined from the free space of the internal memory.

Note

The maximum number of times that storage can be performed depends on the number of stored items that you have set and the free space at the save destination.

For details on how to set the stored items, see section 7.2. For details on how to set the save destination, see section 7.3.

Setting the Storage Control

- When the Storage Mode Is Manual

Set the storage interval (00 hours : 00 minutes : 00 seconds-99 hours : 59 minutes : 59 seconds).
Configure the storage.

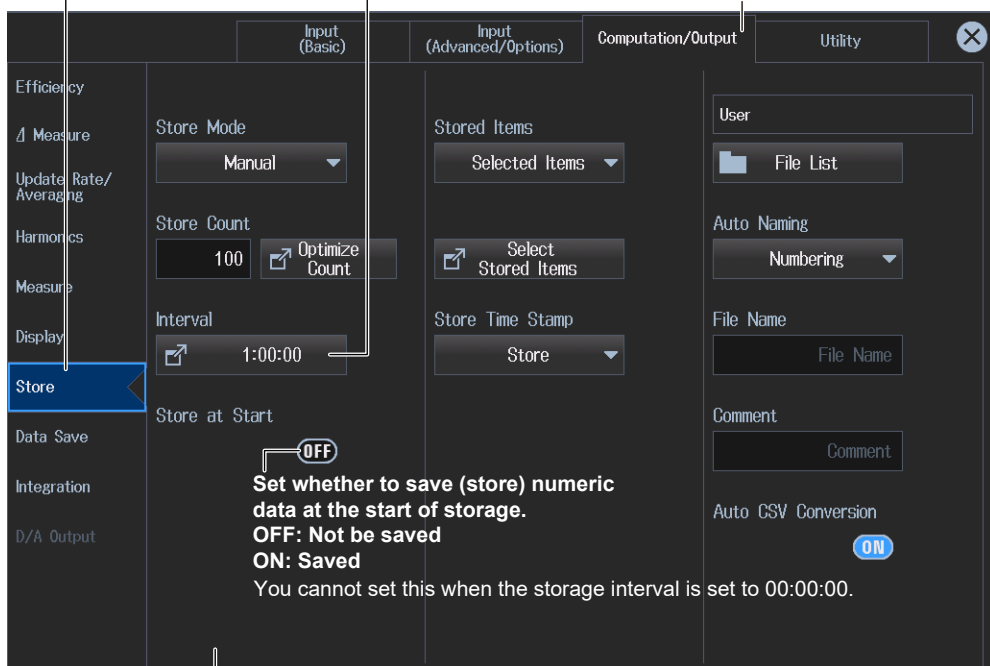

Storage control setup screen (when the storage mode is Manual)

Setting the Storage Interval

Tap **Interval**. An Interval screen appears.

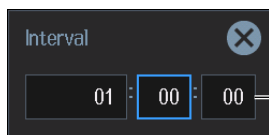

Set the storage interval

(00 hours : 00 minutes : 00 seconds-99 hours : 59 minutes : 59 seconds).

• When the Storage Mode Is Real Time

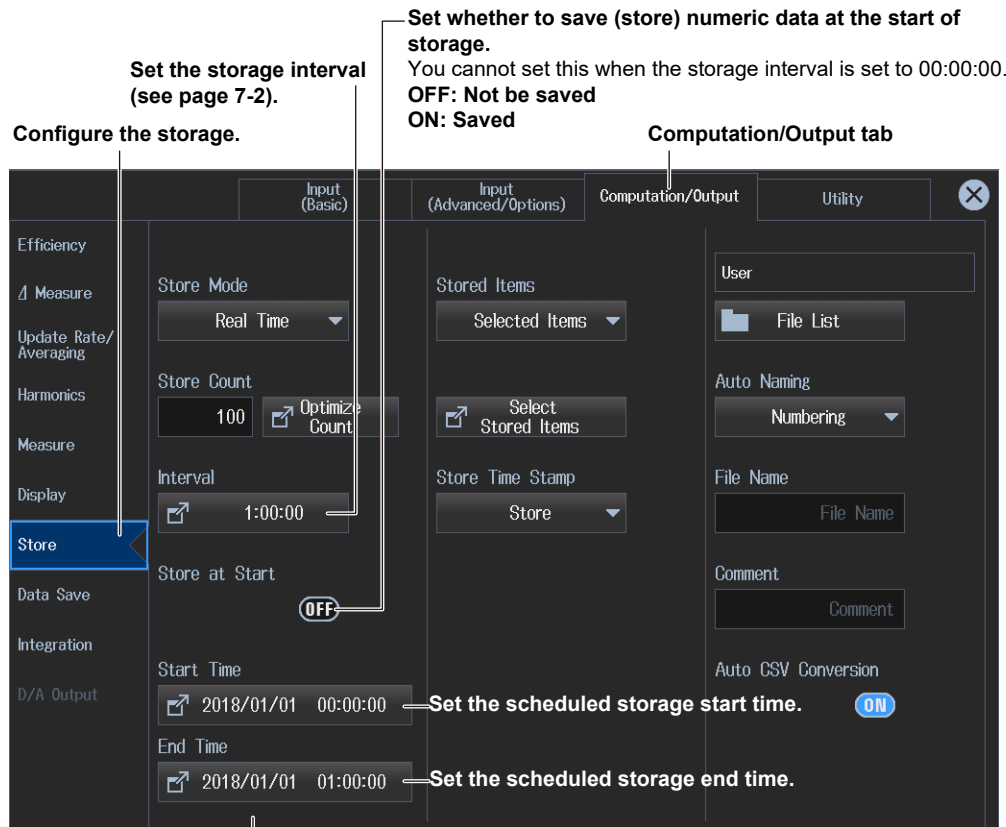

Storage control setup screen (when the storage mode is Real Time)

Setting the Scheduled Start Time

Tap **Start Time** or **End Time**. A Real-time Control screen appears.

Set the scheduled start and stop times

(Year/month/day, 00 hours : 00 minutes : 00 seconds to 23 hours : 59 minutes : 59 seconds).

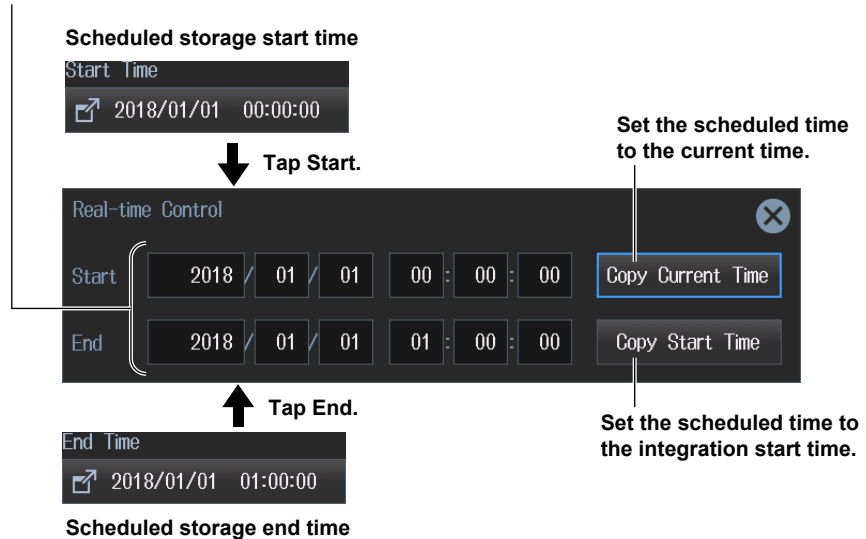

7.1 Setting the Storage Operation

- When the Storage Mode Is Integ Sync (integration synchronization)

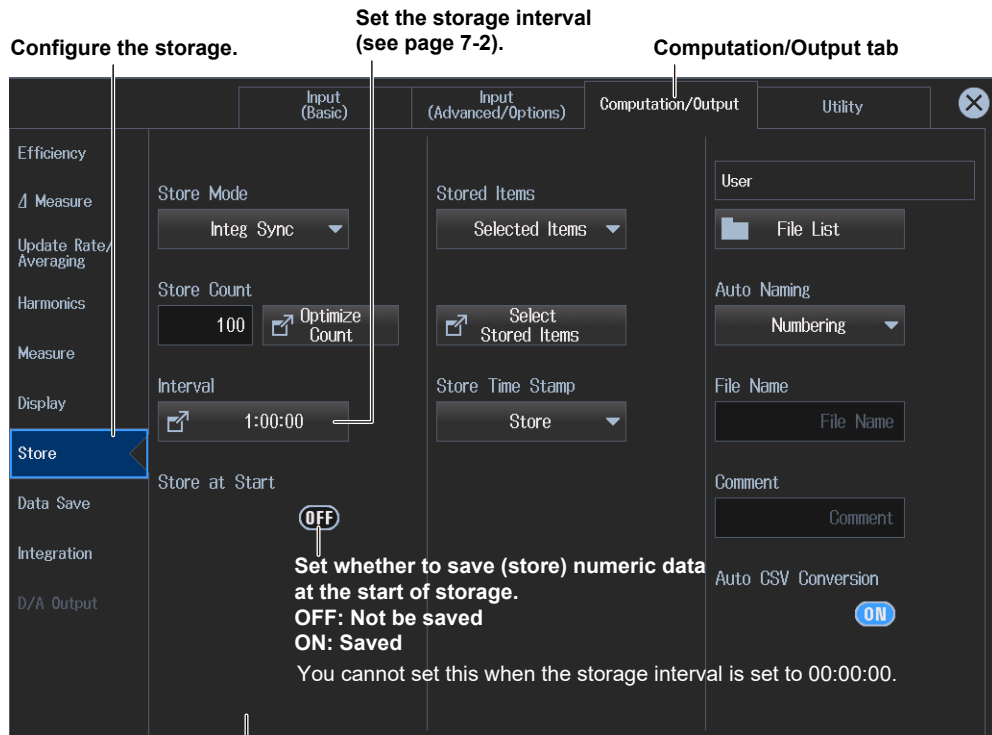

Storage control setup screen (when the storage mode is Integ Sync)

- When the Storage Mode Is Event

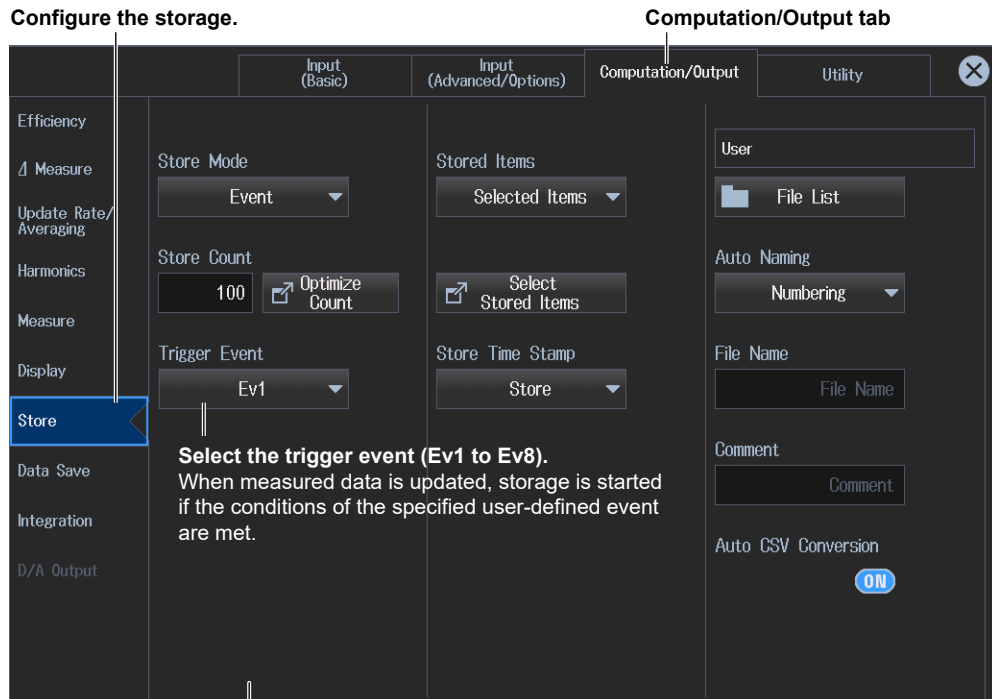

Storage control setup screen (when the storage mode is Event)

Note

When the storage mode is set to Single Shot, there are no storage control settings.

Procedure Using the Menu Icons

You can also use the menu icons shown on the right side of the screen to set the storage.

1. Tap the **Store Data Save** menu icon . A Store-Save menu appears in the sub menu area on the right side of the screen.

By tapping the displayed items, you can specify the same settings as when using the screen explained earlier.

Note

For details on the Store/Data Save menu, see page xi.

Procedure Using Keys

You can also use the front panel keys to set storage.

STORE



Configure the storage.
The Setup menu appears.

7.2 Setting Stored Items

► “Stored Items” in the features guide

This section explains operating procedures using the following setup methods.

- Procedure Using the Setup Menu (see chapter 1)
- Procedure Using the Menu Icons (see page iii)
- Procedure Using the Keys (other than SETUP) (see section 1.2 in IM WT5000-03EN)

Procedure Using the Setup Menu

1. Tap the **Setup** icon  or press **MENU** under SETUP.
2. Tap **Computation/Output** tab. A computation and output settings overview screen appears. Pressing **ESC** closes the overview screen.

Configuring the Storage (Store)

3. Tap **Store**.
A storage setup screen appears.

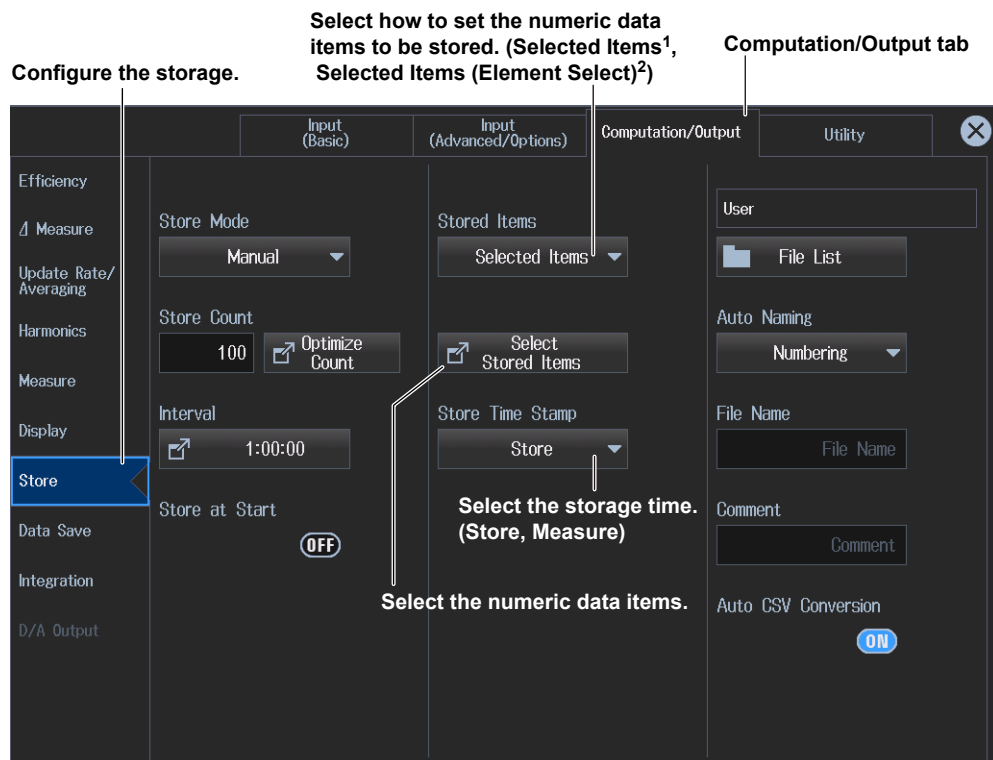

- 1 The selected numeric data items are stored.
- 2 The selected numeric data items are stored. (Element-specific selection)

Note

You can also display the computation/output settings overview screen by moving the cursor on the Computation/Output tab using the arrow keys and then pressing SET.

Selecting the Numeric Data Items (Select Stored Items)

Tap **Select Stored Items** for selecting the numeric data items. The Stored Items screen or the Stored Items (Element Select) screen will appear depending on how the numeric data item to be stored is set.

Stored Items Screen

Select the input elements and wiring units to be stored.

Measurement function group selection buttons
Switch the displayed numeric data items to be stored.

Selects all the numeric data items

Clears the selection of all the numeric data items

Selects the preset numeric data items

Select the motor evaluation and auxiliary input channels to be stored.

The screenshot shows the 'Stored Items' screen with the following elements:

- Buttons: All ON, All OFF, Preset 1, Preset 2
- Element/ Σ : 1 2 3 4 5 6 7 ΣA ΣB ΣC
- Motor: 1 2 3 4
- Aux: 1 2 3 4 5 6 7 8
- Measurement function groups:

Voltage / Current Power / Frequency	Integ / Efficiency	User User	Func / Event	Harmonics	Δ Measure	Motor/Aux	Range
<input checked="" type="checkbox"/> Urms	<input checked="" type="checkbox"/> Umn	<input checked="" type="checkbox"/> Udc	<input checked="" type="checkbox"/> Umn	<input checked="" type="checkbox"/> Uac	<input checked="" type="checkbox"/> Ufnd	<input checked="" type="checkbox"/> CfU	
<input checked="" type="checkbox"/> Irms	<input checked="" type="checkbox"/> Imn	<input checked="" type="checkbox"/> Idc	<input checked="" type="checkbox"/> Imn	<input checked="" type="checkbox"/> Iac	<input checked="" type="checkbox"/> Ifnd	<input checked="" type="checkbox"/> CfI	
<input checked="" type="checkbox"/> P	<input checked="" type="checkbox"/> S	<input checked="" type="checkbox"/> Q	<input checked="" type="checkbox"/> λ	<input checked="" type="checkbox"/> ϕ	<input checked="" type="checkbox"/> Pc		
<input checked="" type="checkbox"/> Pfnd	<input checked="" type="checkbox"/> Sfnd	<input checked="" type="checkbox"/> Qfnd	<input checked="" type="checkbox"/> λ fnd	<input checked="" type="checkbox"/> ϕ fnd			
<input checked="" type="checkbox"/> U+peak	<input checked="" type="checkbox"/> U-peak	<input checked="" type="checkbox"/> I+peak	<input checked="" type="checkbox"/> I-peak	<input checked="" type="checkbox"/> P+peak	<input checked="" type="checkbox"/> P-peak		
<input checked="" type="checkbox"/> FreqU	<input checked="" type="checkbox"/> FreqI	<input checked="" type="checkbox"/> Freq2U	<input checked="" type="checkbox"/> Freq2I				

Select the numeric items that you want to store.

7.2 Setting Stored Items

Stored Items (Element Select) Screen

Measurement function group selection buttons
Switch the displayed numeric data items to be stored.

Selects all the numeric data and element items
Clears the selection of all the numeric data and element items
Selects the preset numeric data and element items

Set the input elements and the like for the numeric data items to be stored.

Select the input element, wiring unit, motor evaluation, and auxiliary input channels for the numeric data item to be stored. If no input element or other selection is needed for the numeric data item to be stored (e.g., efficiency: η ; user-defined: F, Ev; etc.), select the check box for the numeric data item directly.

Note

The settings on the Stored Items and those on the Stored Items (Element Select) screens are independent.

Procedure Using the Menu Icons

You can also use the menu icons shown on the right side of the screen to set the storage.

1. Tap the **Store Data Save** menu icon . A Store-Save menu appears in the sub menu area on the right side of the screen.

By tapping the displayed items, you can specify the same settings as when using the screen explained earlier.

Note

For details on the Store/Data Save menu, see page xi.

Procedure Using Keys

You can also use the front panel keys to set storage.

STORE



Configure the storage.
The Setup menu appears.

7.3 Setting the Data Storage Destination

► “File Save Conditions” in the features guide

This section explains operating procedures using the following setup methods.

- Procedure Using the Setup Menu (see chapter 1)
- Procedure Using the Menu Icons (see page iii)
- Procedure Using the Keys (other than SETUP) (see section 1.2 in IM WT5000-03EN)

Procedure Using the Setup Menu

1. Tap the **Setup** icon , or press **MENU** under SETUP.
2. Tap **Computation/Output** tab. A computation and output settings overview screen appears. Pressing **ESC** closes the overview screen.

Configuring the Storage (Store)

3. Tap **Store**.
A storage setup screen appears.

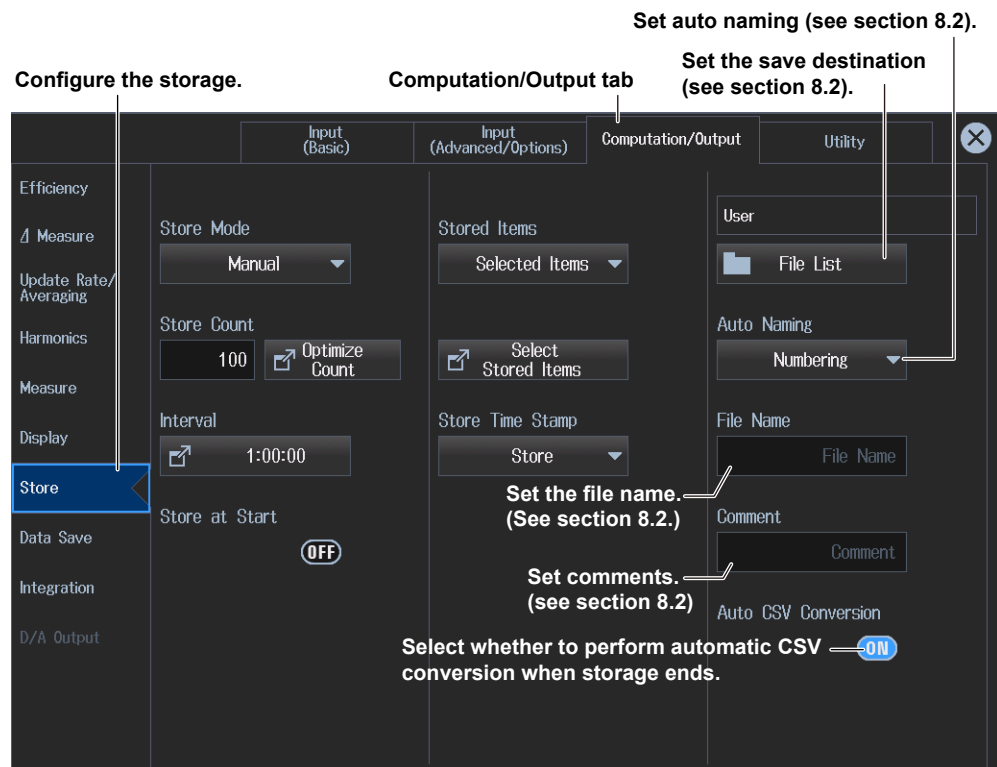

Note

You can also display the computation/output settings overview screen by moving the cursor on the Computation/Output tab using the arrow keys and then pressing SET.

Procedure Using the Menu Icons

You can also use the menu icons shown on the right side of the screen to set the storage.

1. Tap the **Store/Data Save** menu icon . A Store/Data Save menu appears in the sub menu area on the right side of the screen.
By tapping the displayed items, you can specify the same settings as when using the screen explained earlier.

Note

For details on the Store/Data Save menu, see page xi.

Procedure Using Keys

You can also use the front panel keys to set storage.

STORE



Configure the storage.
The Setup menu appears.

7.4 Starting (Rec), Pausing (Pause), and Ending (End) Storage

► [“Starting, Pausing, and Ending Storage Recording” in the features guide](#)

This section explains operating procedures using the following setup methods.

- Procedure Using the Menu Icons (see page iii)
- Procedure Using the Keys (other than SETUP) (see section 1.2 in IM WT5000-03EN)

CAUTION

During storage, the storage device is constantly being accessed, even though the icon that indicates this is not displayed. Do not remove the USB memory device or turn the power off. Doing so may damage the storage device or corrupt its data.

Storage in progress: While the REC key or PAUSE key is illuminated

French

ATTENTION

Pendant la collecte, le système a constamment accès au support de stockage, même si l'icône qui l'indique n'est pas affichée. Ne retirez pas le support de stockage USB et ne coupez pas l'alimentation. Vous risqueriez d'endommager le support de stockage ou les données qu'il contient.

Le stockage est en cours quand la touche STORE START est éclairée ou quand elle clignote, ou bien quand la touche STORE STOP clignote.

Procedure Using the Menu Icons

1. Tap the **Store/Data Save** menu icon . A Store/Data Save menu appears in the sub menu area on the right side of the screen.

Store/Data Save menu

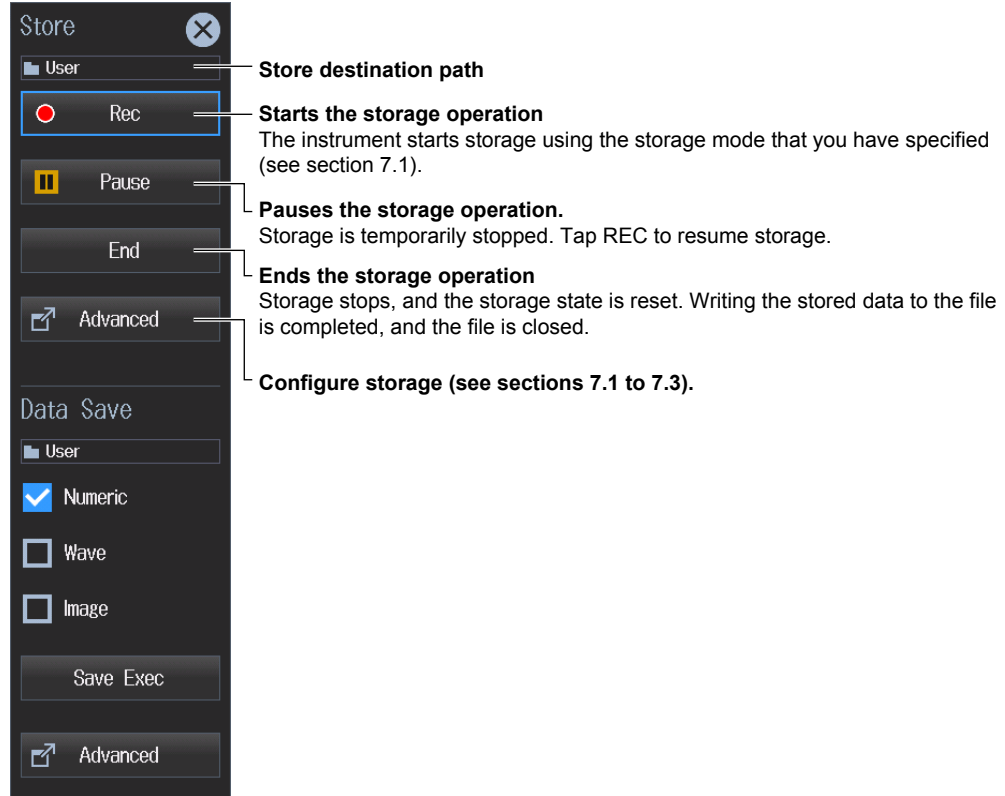

Procedure Using Keys

You can also use the front panel keys to start, pause, and end storage.

STORE



- Starts storage**
The REC LED illuminates, and the storage operation starts.
- Pauses storage**
The PAUSE LED blinks, and the storage operation is paused.
- ERROR indicator**
Blinks when storage error occurs. In this situation, an error message appears at the top of the screen. For more information about how to handle error messages, see appendix 1.
- Ends storage**
The storage state is reset.

Note

When the update mode is Auto and the storage mode is integration-synchronized, set the storage interval to 00:00:00. You cannot start storage recording if it is not set to 00:00:00.

8.1 Connecting a USB Memory Device

This section explains how to connect USB memory devices to save and load data.

If you want to use a storage device on your network (a network drive), you have to use an Ethernet cable to connect the instrument to the network. For details, see section 15.5.

► [“Storage Device” in the features guide](#)

CAUTION

- Do not remove the USB storage device or turn off the power when the device is being accessed. Doing so may damage the storage device or corrupt its data.
 - When the USB memory device is being accessed, an access indicator is displayed in the top center the screen and the USB memory device indicator blinks.
-

French

ATTENTION

- Lorsque le dispositif accède au support de stockage USB, ne retirez pas ce dernier et ne mettez pas l'alimentation hors tension. Vous risqueriez d'endommager le support de stockage ou les données qu'il contient.
 - Quand le système accède au support de stockage USB, s'affiche au centre, dans la partie supérieure de l'écran, et le voyant du support de stockage USB clignote.
-

USB Memory Devices That Can Be Used and How to Connect USB Memory Devices

Use portable USB memory devices that are compatible with USB Mass Storage Class version 1.1. Connect USB memory devices directly to the USB ports (type A) for connecting peripheral devices on the instrument's front panel.

Hot-plugging is supported: you can connect or disconnect the USB device at any time, regardless of whether the instrument is on or off. When the power is on, the instrument automatically detects the USB memory device after it is connected.

This instrument has two USB ports: USB-0 and USB-1. The port numbers are not fixed. The port at which the first USB memory device is detected becomes USB-0. The port at which the second USB memory device is detected becomes USB-1.

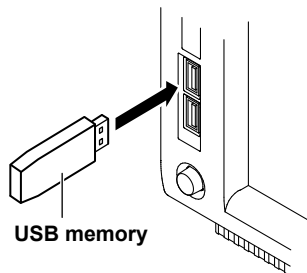

Note

- Connect USB memory devices directly to the USB ports (type A) for connecting peripheral devices. Do not connect them through a hub.
 - Use portable USB memory devices that are compatible with USB Mass Storage Class version 1.1. Do not connect incompatible USB memory devices.
 - You cannot use protected USB memory devices (such as those that contain encrypted content).
 - Do not connect and disconnect the two USB devices repetitively. Provide at least a 10-second interval between removal and connection.
-

General USB Memory Handling Precautions

Follow the general handling precautions that are included with your USB memory.

8.2 Setting the Save Destination for Numeric Data, Waveform Data, and Screen Images

▶ “File Save Conditions” in the features guide

▶ “Conditions for Saving Numeric Data” in the features guide

▶ “Conditions for Saving Screen Images” in the features guide

This section explains operating procedures using the following setup methods.

- Procedure Using the Setup Menu (see chapter 1)
- Procedure Using the Menu Icons (see page iii)
- Procedure Using the Keys (other than SETUP) (see section 1.2 in IM WT5000-03EN)

Procedure Using the Setup Menu

1. Tap the **Setup** icon , or press **MENU** under SETUP.
2. Tap **Computation/Output** tab. A computation and output settings overview screen appears. Pressing **ESC** closes the overview screen.

Setting the Save Conditions (Data Save)

3. Tap **Data Save**.
A save condition setup screen appears.

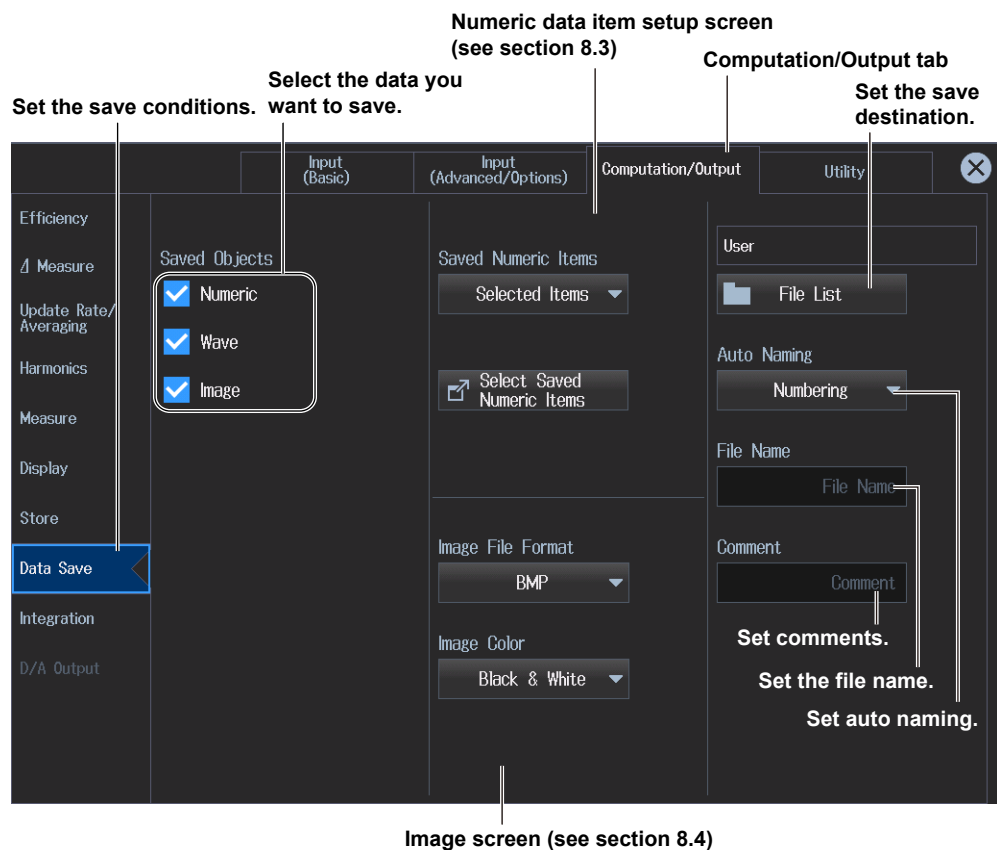

Note

You can also display the computation/output settings overview screen by moving the cursor on the Computation/Output tab using the arrow keys and then pressing SET.

Setting the Save Destination

4. Tap **File List**. A file list appears.

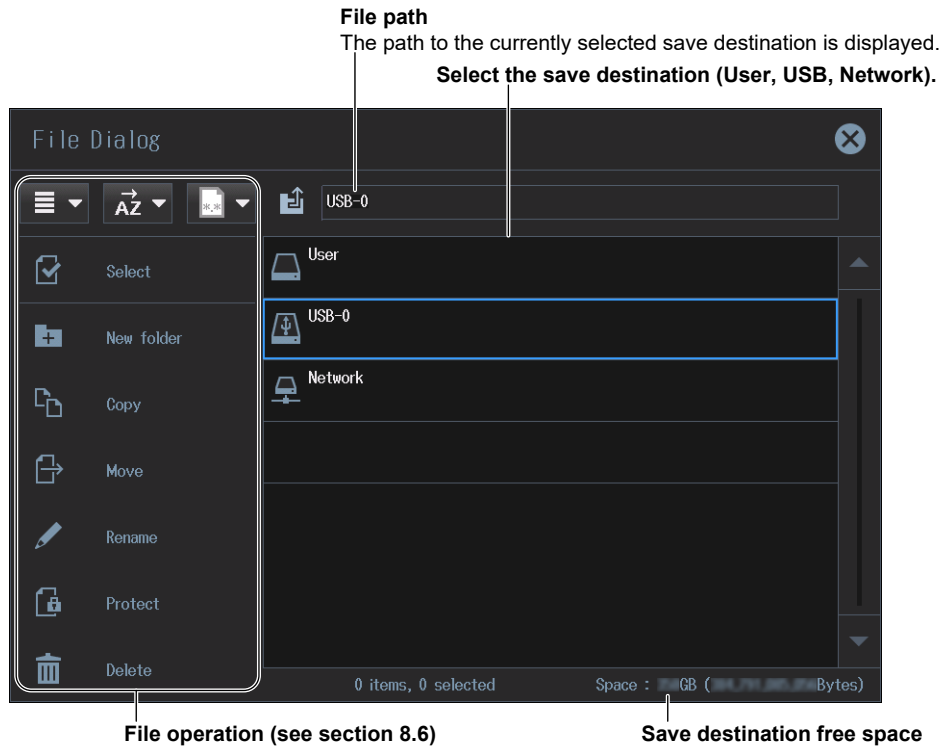

Setting Auto Naming (Auto Naming)

OFF: The auto naming feature is disabled. The name that you specified for the File Name setting is used. If there is a file with the same name in the save destination folder, you cannot save the data.

Numbering: The instrument automatically adds a four-digit number from 0000 to 0999 after the common name that you specified for the File Name setting and saves the file.

Date: The file name is the date and time (down to seconds) when the file is saved. The file name that you specified for the File Name setting is ignored.

20170930_121530_0 (2017/09/30 12:15:30)
 Y M D H Min S The sequence number (0-9, A-Z) that is appended if a file name with the exact same date and time (down to seconds) exists.

The sequence number that comes after the date and time is appended if a file name with the exact same date and time (down to seconds) exists.

The sequence number is incremented by one (0 to 9 and then A to Z) each time a file is added.

Assigning File Names (File Name)

You can set the file name that is used when Auto Naming is set to OFF. This is also used as the common file name when Auto Naming is set to Numbering. The maximum number of characters that you can use for file names and folder names is 32 characters. However, there are limitations on the type of characters and the character strings that you can use.

For instructions on how to enter text, see section 3.3 in the Getting Started Guide, IM WT5000-03EN.

Setting a Comment (Comment)

You can add a comment that consists of up to 30 characters when you save a file. You do not have to enter a comment.

All characters, including spaces, can be used in comments.

For instructions on how to enter text, see section 3.3 in the Getting Started Guide, IM WT5000-03EN.

Procedure Using the Menu Icons

You can also use the menu icons shown on the right side of the screen to set data saving.

1. Tap the **Store/Data Save** menu icon . A Store/Data Save menu appears in the sub menu area on the right side of the screen.
By tapping the displayed items, you can specify the same settings as when using the screen explained earlier.

Note

For details on the Store/Data Save menu, see page xi.

Procedure Using Keys

You can also use the front panel keys to set data saving.

DATA SAVE



Set the save destination.
The Setup menu appears.

8.3 Setting the Numeric Data Items to Save

► “Saved Numeric Items (Saved Numeric Items)” in the features guide

This section explains operating procedures using the following setup methods.

- Procedure Using the Setup Menu (see chapter 1)
- Procedure Using the Menu Icons (see page iii)
- Procedure Using the Keys (other than SETUP) (see section 1.2 in IM WT5000-03EN)

Procedure Using the Setup Menu

1. Tap the **Setup** icon  or press **MENU** under SETUP.
2. Tap **Computation/Output** tab. A computation and output settings overview screen appears. Pressing **ESC** closes the overview screen.

Setting the Save Conditions (Data Save)

3. Tap **Data Save**.
A save condition setup screen appears.

Select how to set the numeric data items to be saved.
(Displayed Numeric Items¹, Selected Items², Selected Items (Element Select)³)

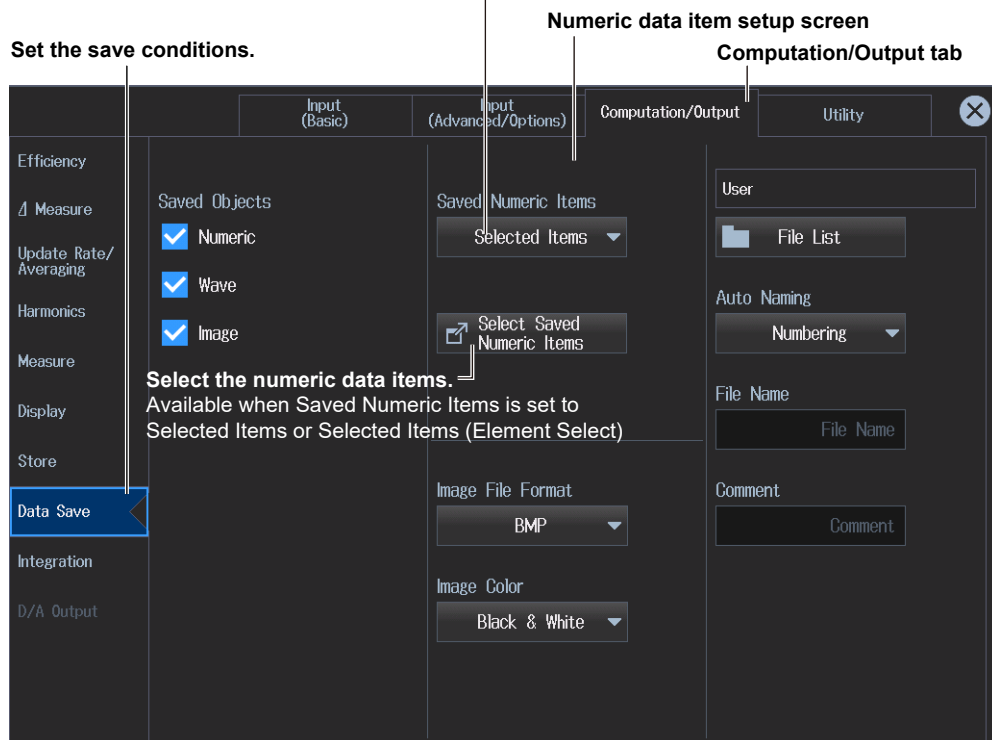

- 1 The numeric data items shown on the screen are saved.
- 2 The selected numeric data items are saved.
- 3 The selected numeric data items are saved. (Element-specific selection)

Note

You can also display the computation/output settings overview screen by moving the cursor on the Computation/Output tab using the arrow keys and then pressing SET.

Selecting Numeric Data Items (Select Saved Numeric Items)

Tap **Select Saved Numeric Items** for selecting the numeric data items. The Saved Numeric Items screen or the Saved Numeric Items (Element Select) screen will appear depending on how the numeric data item to be saved is set.

Saved Numeric Items Screen

Select the input elements and wiring units to be saved.

Measurement function group selection buttons
Switch the displayed numeric data items to be saved.

Selects all the numeric data items
Clears the selection of all the numeric data items
Selects the preset numeric data items

Select the motor evaluation and auxiliary input channels to be saved.

Select the numeric items that you want to save.

Voltage / Current	Power / Frequency	Integ / Efficiency	User / User	Func / Event	Harmonics	Δ Measure	Motor/Aux	Range
<input checked="" type="checkbox"/> Urms	<input checked="" type="checkbox"/> Umn	<input checked="" type="checkbox"/> Udc	<input checked="" type="checkbox"/> Urmn	<input checked="" type="checkbox"/> Uac	<input checked="" type="checkbox"/> Ufnd	<input checked="" type="checkbox"/> CfU		
<input checked="" type="checkbox"/> Irms	<input checked="" type="checkbox"/> Imn	<input checked="" type="checkbox"/> Idc	<input checked="" type="checkbox"/> Irmn	<input checked="" type="checkbox"/> Iac	<input checked="" type="checkbox"/> Ifnd	<input checked="" type="checkbox"/> Cfl		
<input checked="" type="checkbox"/> P	<input checked="" type="checkbox"/> S	<input checked="" type="checkbox"/> Q	<input checked="" type="checkbox"/> λ	<input checked="" type="checkbox"/> φ	<input checked="" type="checkbox"/> Pc			
<input checked="" type="checkbox"/> Pfnd	<input checked="" type="checkbox"/> Sfnd	<input checked="" type="checkbox"/> Qfnd	<input checked="" type="checkbox"/> λfnd	<input checked="" type="checkbox"/> φfnd				
<input checked="" type="checkbox"/> U+peak	<input checked="" type="checkbox"/> U-peak	<input checked="" type="checkbox"/> I+peak	<input checked="" type="checkbox"/> I-peak	<input checked="" type="checkbox"/> P+peak	<input checked="" type="checkbox"/> P-peak			
<input checked="" type="checkbox"/> FreqU	<input checked="" type="checkbox"/> FreqI	<input checked="" type="checkbox"/> Freq2U	<input checked="" type="checkbox"/> Freq2I					

8.3 Setting the Numeric Data Items to Save

Saved Numeric Items(Element Select) Screen

Measurement function group selection buttons

Switch the displayed numeric data items to be saved.

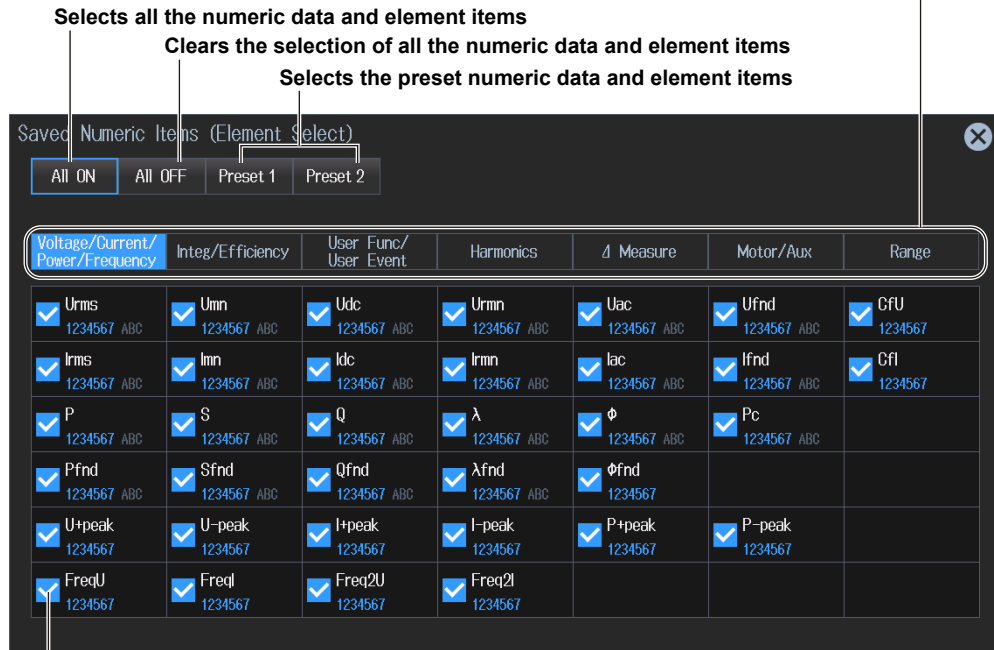

Set the input elements and the like for the numeric data items to be saved.

Select the input element, wiring unit, motor evaluation, and auxiliary input channels for the numeric data item to be saved. If no input element or other selection is needed for the numeric data item to be saved (e.g., efficiency: η ; user-defined: F, Ev; etc.), select the check box for the numeric data item directly.

Note

The settings on the Saved Numeric Items and those on the Saved Numeric Items (Element Select) screens are independent.

Procedure Using the Menu Icons

You can also use the menu icons shown on the right side of the screen to set numeric data saving.

1. Tap the **Store/Data Save** menu icon . A Store/Data Save menu appears in the sub menu area on the right side of the screen.

By tapping the displayed items, you can specify the same settings as when using the screen explained earlier.

Note

For details on the Store/Data Save menu, see page xi.

Procedure Using Keys

You can also use the front panel keys to set numeric data saving.

DATA SAVE



Set the save destination.
The Setup menu appears.

8.4 Setting the Format of Saved Screen Images

► “Conditions for Saving Screen Images” in the features guide

This section explains operating procedures using the following setup methods.

- Procedure Using the Setup Menu (see chapter 1)
- Procedure Using the Menu Icons (see page iii)
- Procedure Using the Keys (other than SETUP) (see section 1.2 in IM WT5000-03EN)

Procedure Using the Setup Menu

1. Tap the **Setup** icon , or press **MENU** under SETUP.
2. Tap **Computation/Output** tab. A computation and output settings overview screen appears. Pressing **ESC** closes the overview screen.

Setting the Save Conditions (Data Save)

3. Tap **Data Save**.
A save condition setup screen appears.



Note

You can also display the computation/output settings overview screen by moving the cursor on the Computation/Output tab using the arrow keys and then pressing SET.

Procedure Using the Menu Icons

You can also use the menu icons shown on the right side of the screen to set screen image saving.

1. Tap the **Store/Data Save** menu icon . A Store/Data Save menu appears in the sub menu area on the right side of the screen.

By tapping the displayed items, you can specify the same settings as when using the screen explained earlier.

Note

For details on the Store/Data Save menu, see page xi.

Procedure Using Keys

You can also use the front panel keys to set screen image saving.

DATA SAVE



Set the save destination.
The Setup menu appears.

8.5 Saving Numeric Data, Waveform Data, and Screen Images

- ▶ [“Conditions for Saving Numeric Data” in the features guide](#)
- ▶ [“Conditions for Saving Screen Images” in the features guide](#)
 - ▶ [“Saving \(Save Exec, EXEC\)” in the features guide](#)

This section explains operating procedures using the following setup methods.

- Procedure Using the Menu Icons (see page iii)
- Procedure Using the Keys (other than SETUP) (see section 1.2 in IM WT5000-03EN)

CAUTION

While data is being save, the storage device is constantly being accessed, even though the icon that indicates this is not displayed. Do not remove the USB memory device or turn the power off. Doing so may damage the storage device or corrupt its data.

French

ATTENTION

Pendant la collecte, le système a constamment accès au support de stockage, même si l'icône qui l'indique n'est pas affichée. Ne retirez pas le support de stockage USB et ne coupez pas l'alimentation. Vous risqueriez d'endommager le support de stockage ou les données qu'il contient.

Procedure Using the Menu Icons

1. Tap the **Store/Data Save** menu icon . A Store/Data Save menu appears in the sub menu area on the right side of the screen.

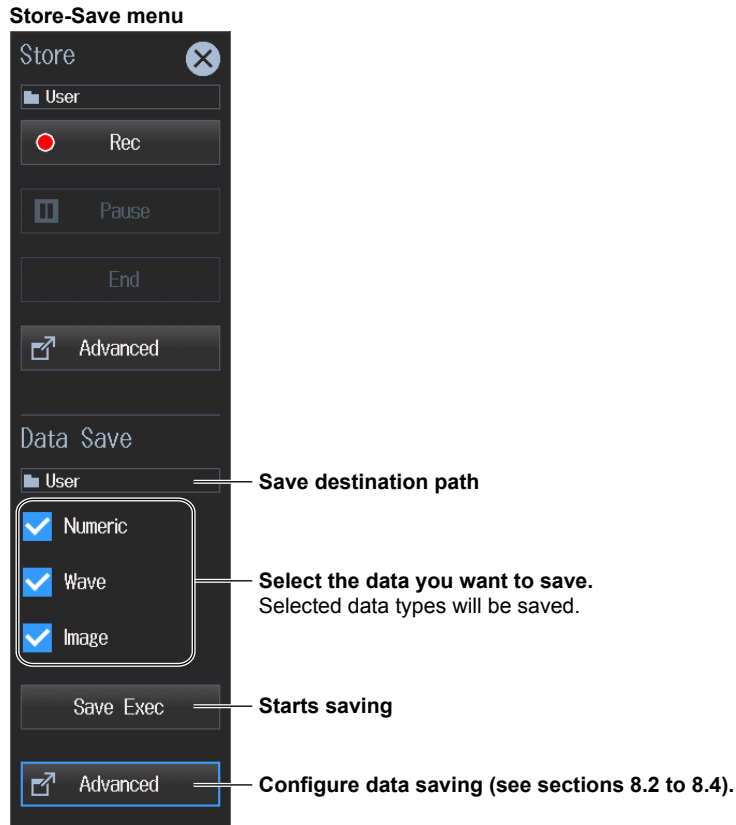

Procedure Using Keys

You can also use the front panel keys to save data.

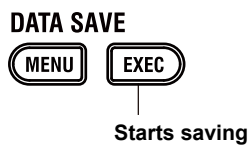

8.6 File Operations

► “File List (File List)” in the features guide

This section will explain how to operate the file list.

The file list is a feature used to manage files as explained in chapter 7, “Storing Numeric Data,” and section 8.2.

File List (File List)

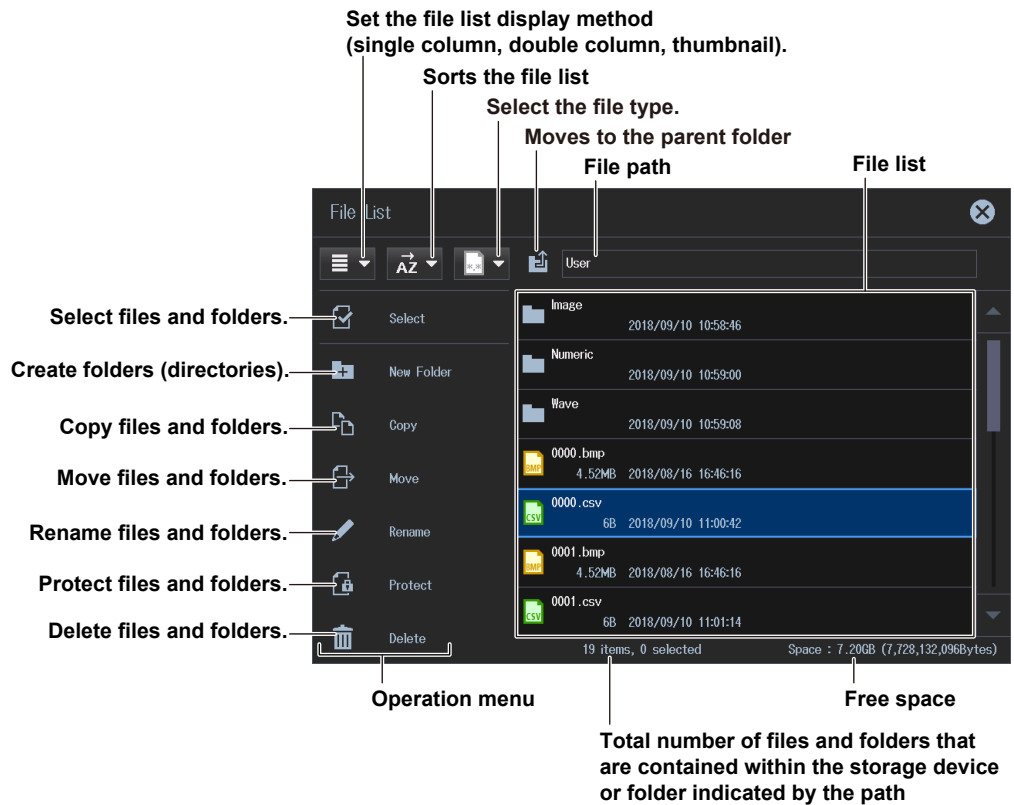

Sorting the File List (AZ)

Tap **AZ** on the operation menu. The following screen appears.

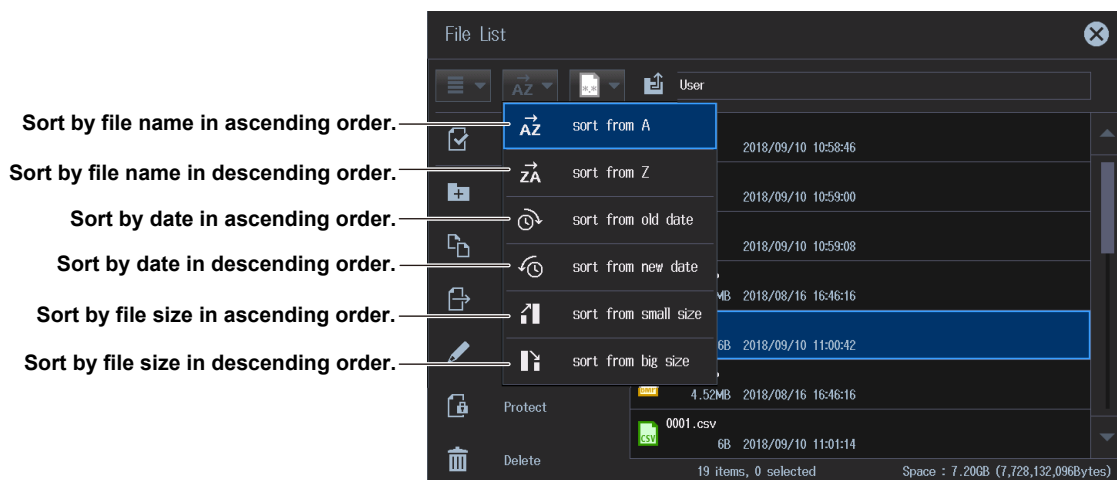

Setting the Display Format (☰, ☷, ☳)

Tap ☰, ☷, or ☳ on the operation menu. The following screen appears.

Single Column Display (☰)

The file list is shown in a single column.

Set the file list display method
(☰, ☷, ☳)

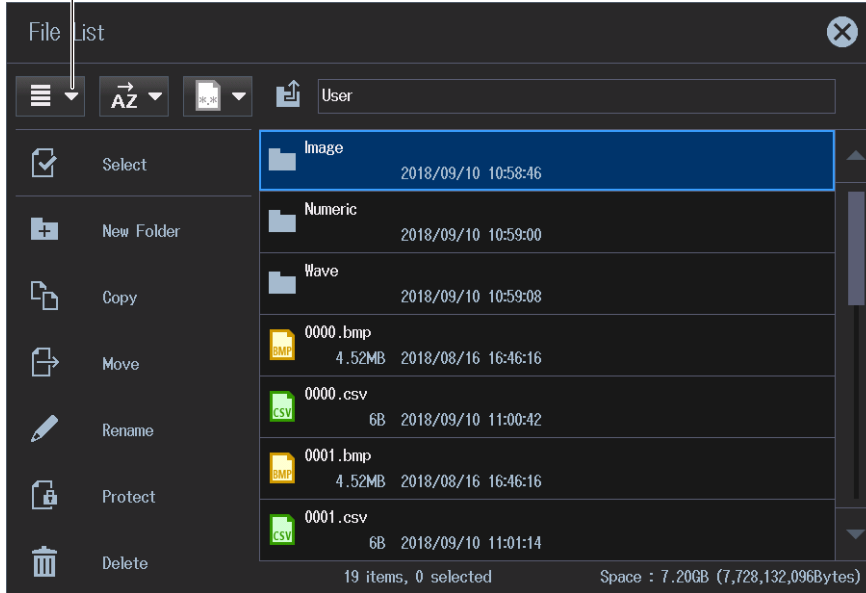

Double Column Display (☷)

The file list is shown in two columns.

Set the file list display method
(☰, ☷, ☳)

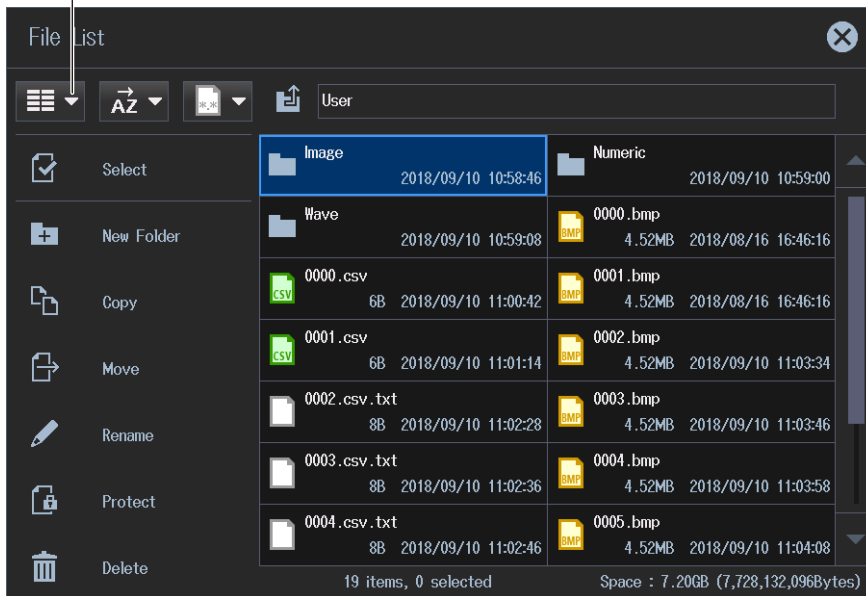

Thumbnail Display ()

The file list is shown as thumbnails.

Set the file list display method

( ,  , )

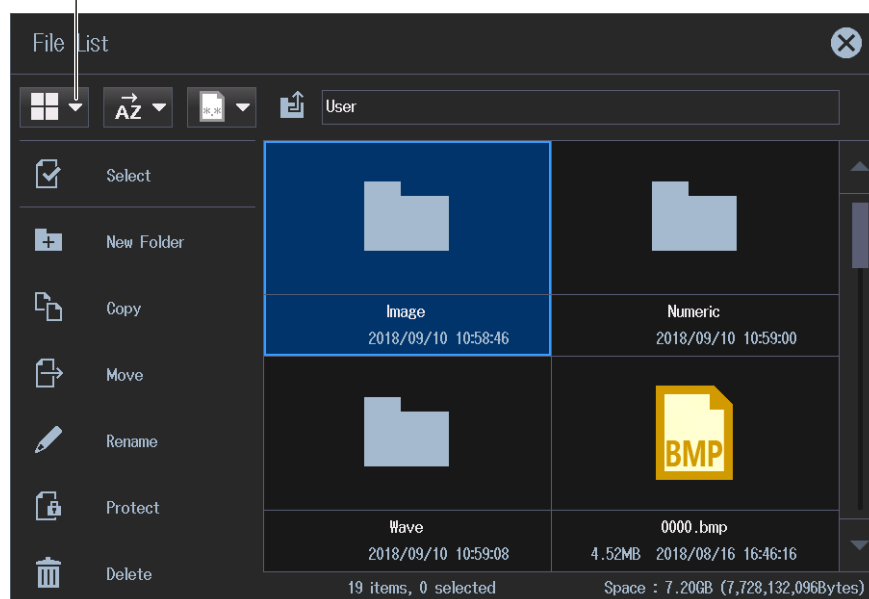

Selecting the File Type

Select the type of files to display in the file list.

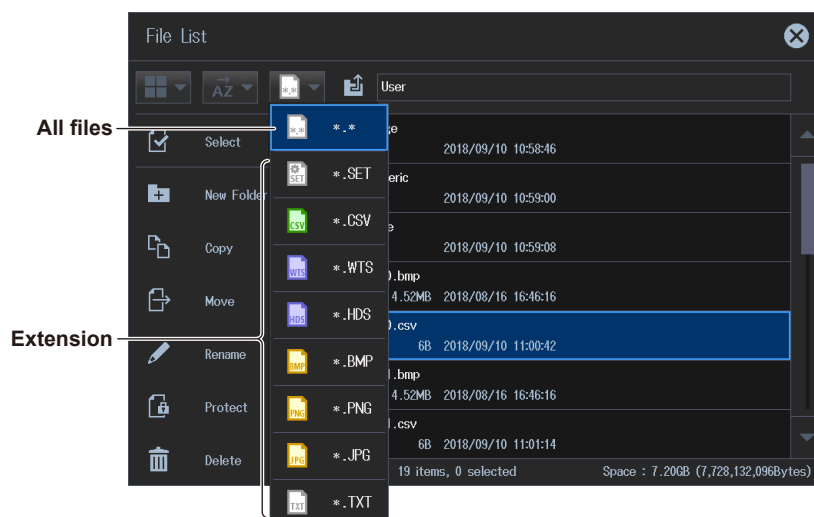

Selecting Files and Folders (Select)

To select multiple files or folders, tap **Select** on the operation menu. The following screen appears. You can return to the original screen by tapping Select again.

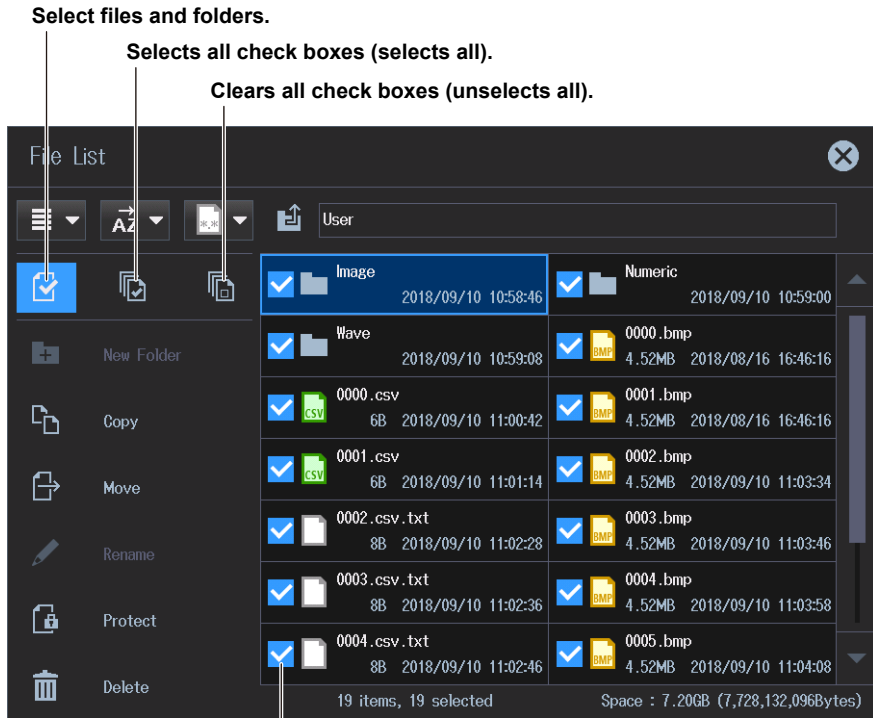

A check mark appears when you tap the check box. Tap it again to clear it.

Making Folders (New folder)

Tap **New folder** on the operation menu. The following screen appears. To make a new folder within a folder, tap the appropriate folder on the file list, and then tap New folder.

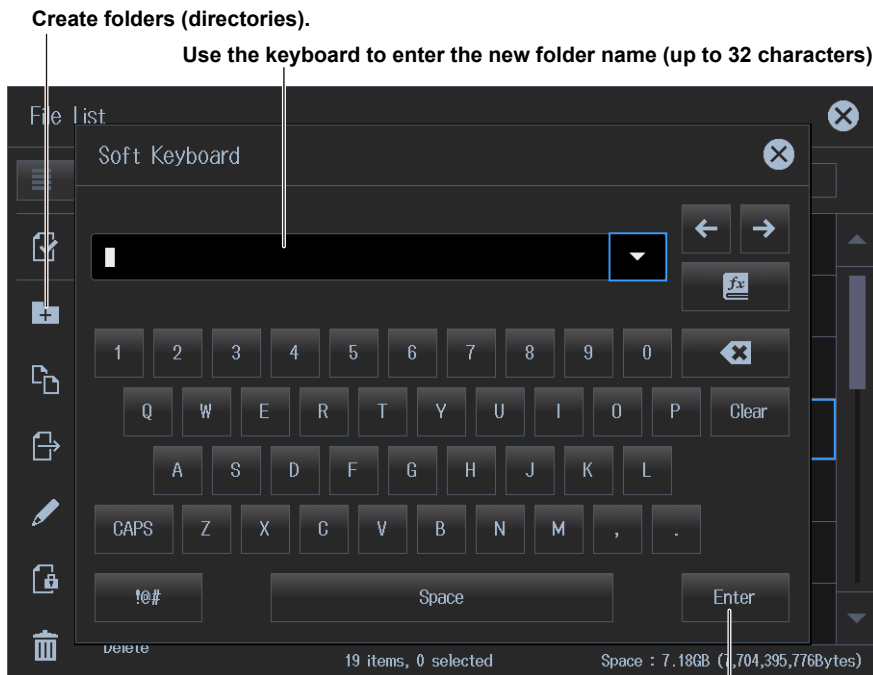

Confirms the folder name you entered.

Copying Files and Folders (Copy)

1. Tap **Select** on the operation menu.
This menu is used when copying multiple files or folders.
2. Tap the files and folders in the file list that you want to copy.
For the selection procedure, see “Selecting Files and Folders (Select)” on the previous page.
3. Tap **Copy** on the operation menu. A copy destination file list appears.

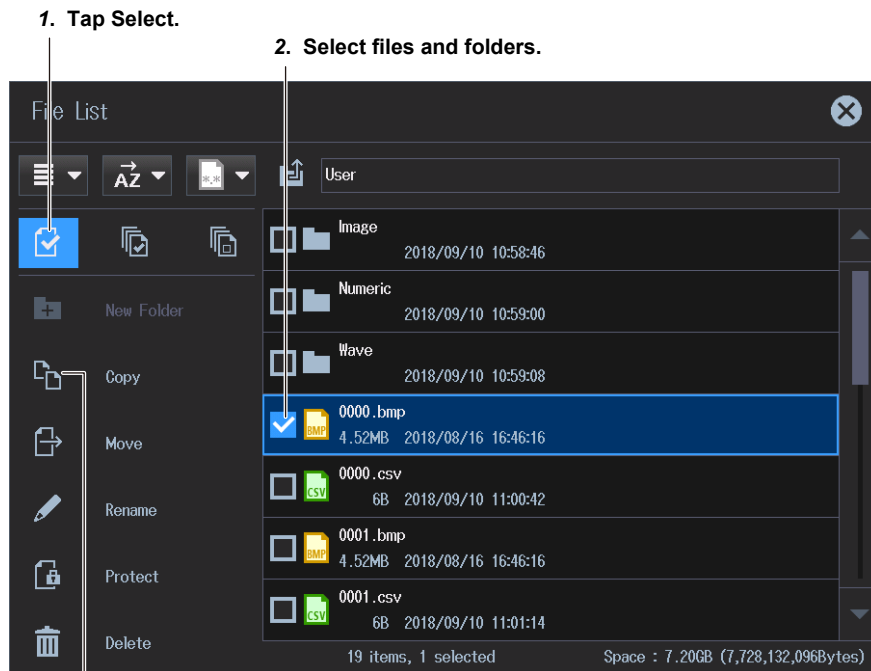

3. Tap **Copy**.

4. On this list, tap the copy destination folder.
The contents of the folder appear.

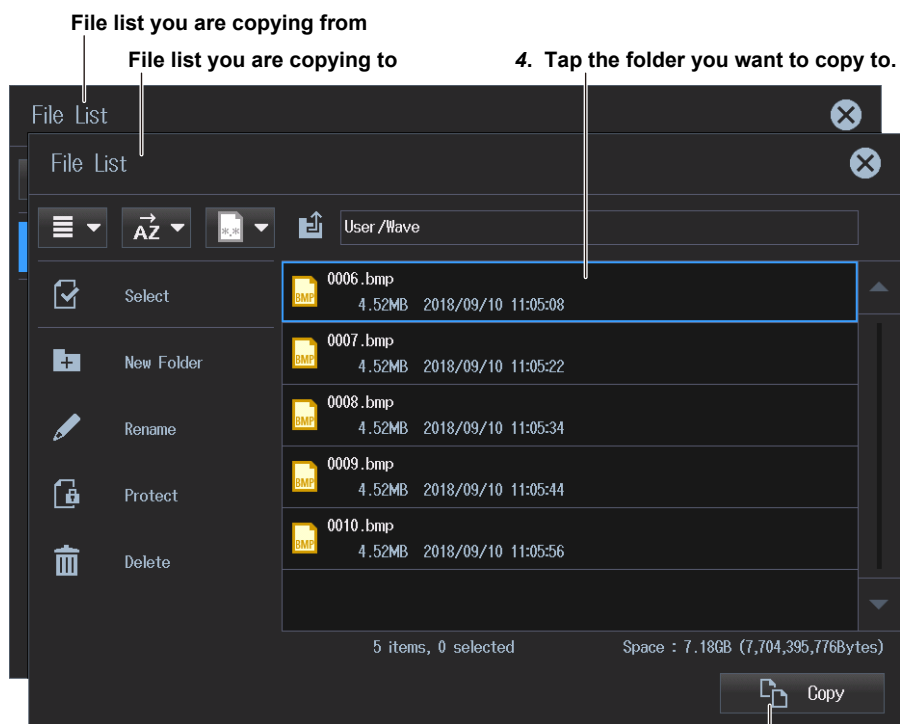

5. Executes the copy operation.

8.6 File Operations

5. Tap **Copy** in the lower right of the screen. The following screen appears.
Tap OK to copy the files and folders.

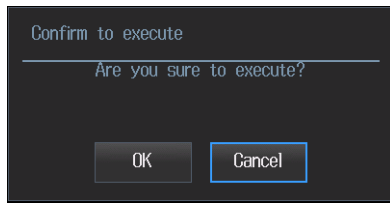

Moving Files and Folders (Move)

1. Tap **Select** on the operation menu.
This menu is used when moving multiple files or folders.
2. Tap the files and folders in the file list that you want to move.
For the selection procedure, see "Selecting Files and Folders (Select)" on the previous page.
3. Tap **Move** on the operation menu. A move destination file list appears.

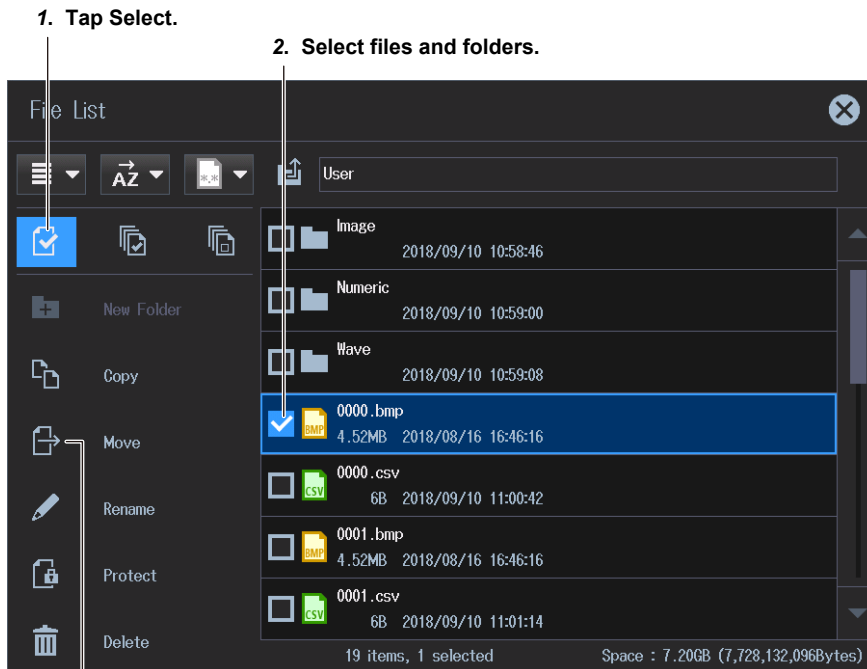

3. Tap **Move**.

4. On this list, tap the move destination folder.
The contents of the folder appear.

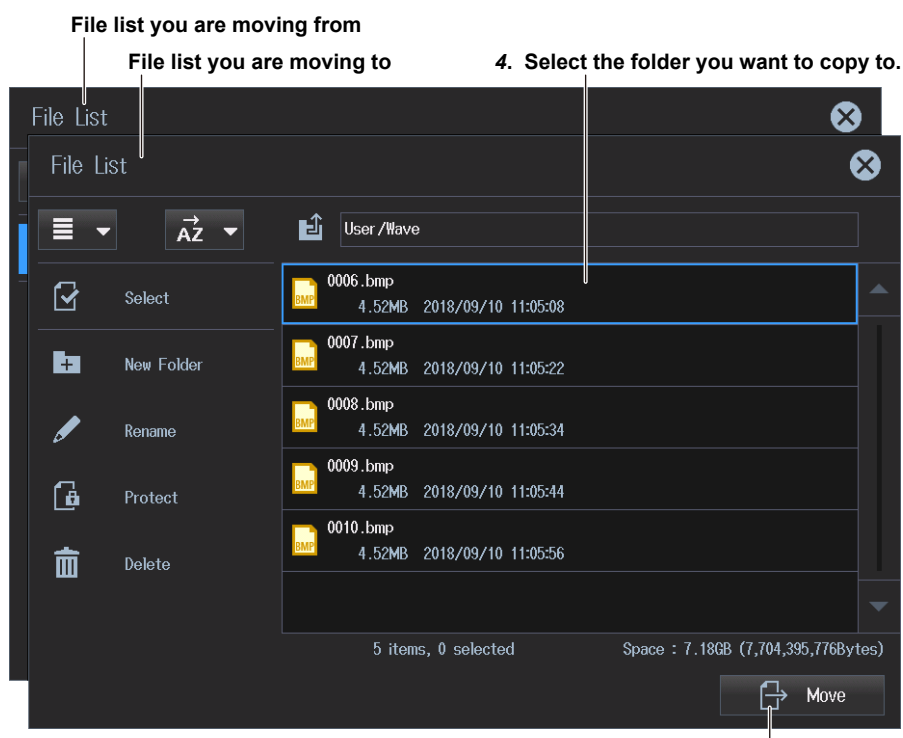

5. Executes the move operation.

5. Tap **Move** in the lower right of the screen. The following screen appears.
Tap OK to move the files and folders.

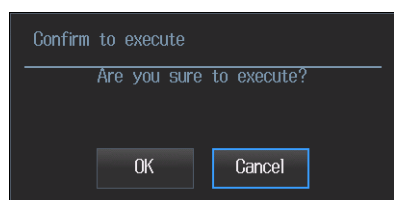

Renaming Files and Folders (Rename)

1. Tap the file or folder in the file list that you want to rename.
2. Tap **Rename** on the operation menu. The following screen appears.

Use the keyboard to enter the new folder name.

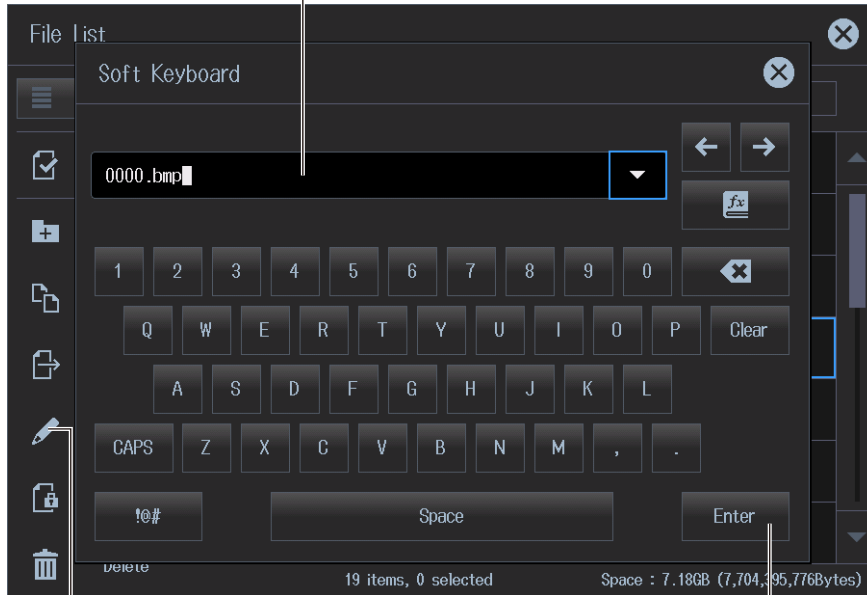

Rename files and folders.

Confirms the file or folder name you entered.

Protecting Files and Folders (Protect)

1. Tap **Select** on the operation menu.
This menu is used when moving multiple files or folders.
2. Tap the files and folders that you want to protect on the file list.
For the selection procedure, see "Selecting Files and Folders (Select)" on page 8-14.
3. Tap **Protect** on the operation menu. Protection appears on the file or folder icons.

1. Tap Select.

2. Select files and folders.

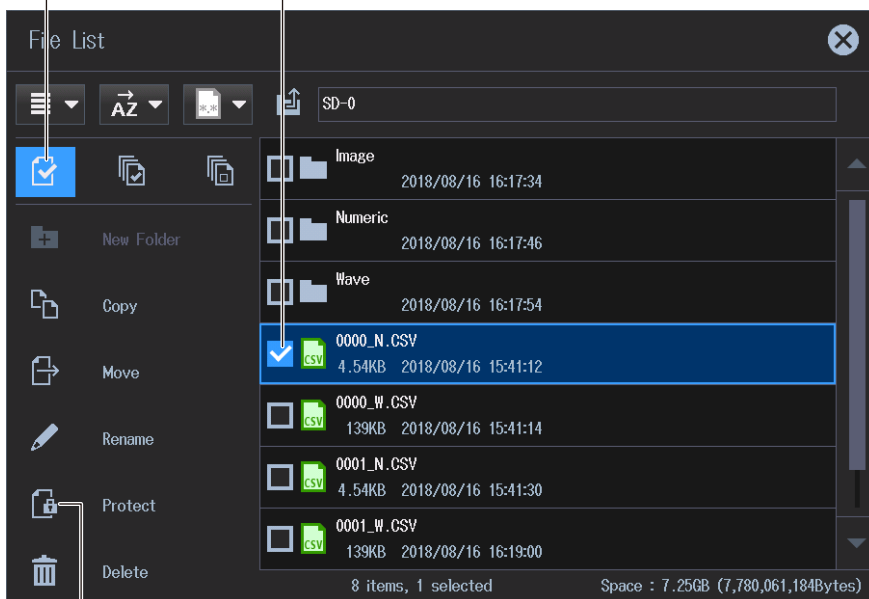

3. Tap Protect.

Deleting Files and Folders (Delete)

1. Tap Select on the operation menu.
This menu is used when deleting multiple files or folders.
2. Tap the files and folders that you want to delete on the file list.
For the selection procedure, see “Selecting Files and Folders (Select)” on the previous page.
3. Tap **Delete** on the operation menu. A delete confirmation screen appears.
Tap OK to delete the files and folders.

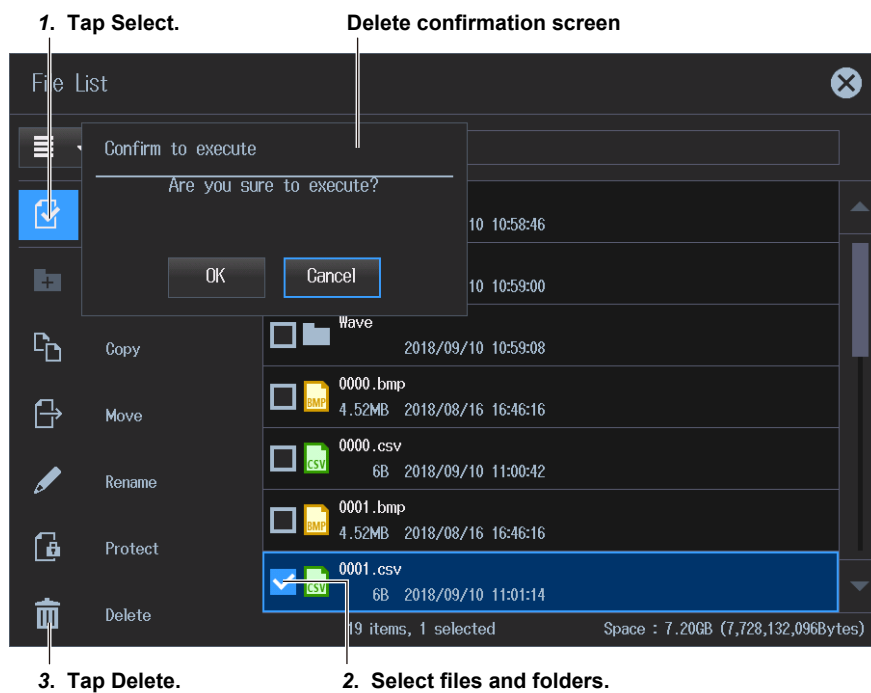

9.1 Configuring Motor Evaluation and Auxiliary Input Settings

▶ “Motor Evaluation/Auxiliary Inputs (Motor/Aux)” in the features guide

This section explains operating procedures using the following setup methods.

- Procedure Using the Setup Menu (see chapter 1)

Procedure Using the Setup Menu

1. Tap the **Setup** icon , or press **MENU** under **SETUP**.
2. Tap the **Input (Advanced/Options)** tab. An input settings (advanced/options) overview screen appears.
Pressing **ESC** closes the overview screen.

Configuring Motor Evaluation and Auxiliary Input Settings (Motor/Aux)

3. Tap **Motor/Aux**. A motor evaluation/auxiliary input setup screen appears.
The following screen is an example for a model with the /MTR2 option.

Set the MTR configuration (device to be evaluated).
(Single Motor (Speed: Pulse), Single Motor (Speed: Analog), Double Motor, Auxiliary)

A connection diagram of revolution signal and torque signals appears according to the MTR configuration.

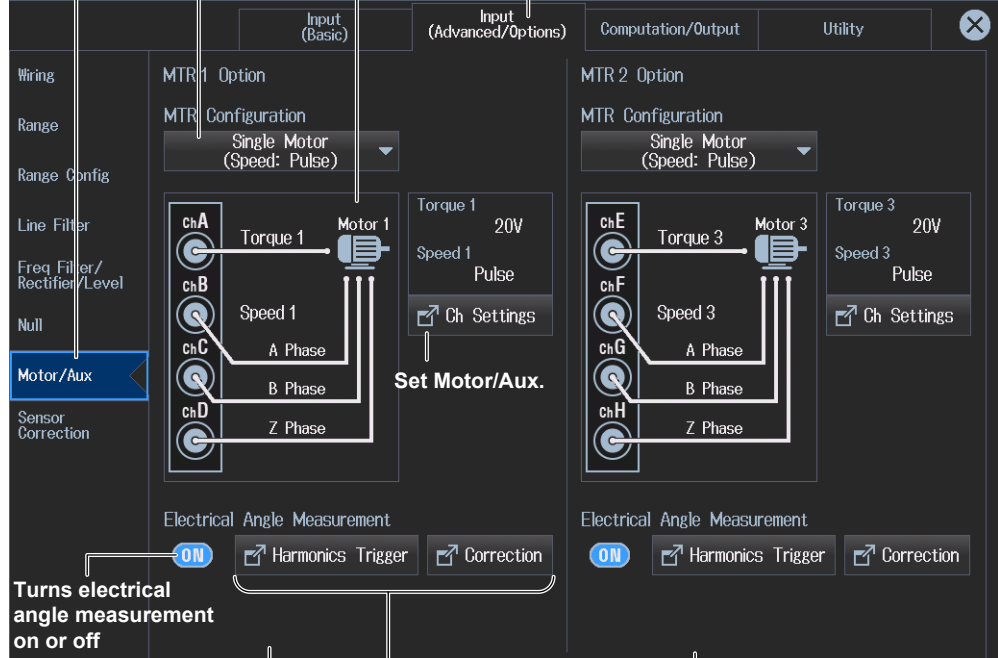

The screenshot shows the 'Input (Advanced/Options)' tab with the 'Motor/Aux' button selected. It displays two configuration screens: /MTR1 options screen and /MTR2 options screen. The /MTR1 screen shows 'MTR1 Configuration' set to 'Single Motor (Speed: Pulse)' with a wiring diagram for Motor 1 (Torque 1, Speed 1) and electrical angle measurement options (ON, Harmonics Trigger, Correction). The /MTR2 screen shows 'MTR2 Configuration' set to 'Single Motor (Speed: Pulse)' with a wiring diagram for Motor 3 (Torque 3, Speed 3) and similar electrical angle measurement options. Labels point to the 'Motor/Aux button', 'Input (Advanced/Options) tab', and 'Set Motor/Aux.' button.

Configure the electrical angle measurement.
 You can use these when the electrical angle measurement is on.

Note

- You can configure the Motor1 and Motor2 settings on models with the /MTR1 option and the Motor1 to Motor4 settings on models with the /MTR2 option.
- You can also display the input settings overview screen by moving the cursor on the Input (Advanced/Options) tab using the arrow keys and then pressing SET.

Configuring Motor/Aux Settings (Ch Settings)

The following four types of setup screens are available depending on the motor evaluation configuration setting.

Single Motor (Speed:Pulse)

4. Tap **Ch Settings**. A single motor (revolution signal: pulse) setup screen appears.

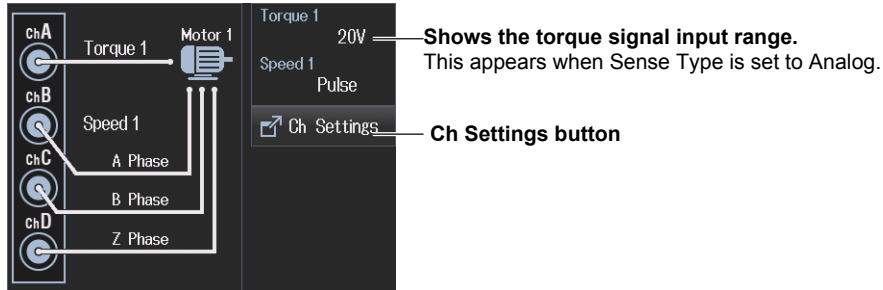

Single motor (revolution signal: pulse) setup screen

Set the unit (up to 8 characters).

Set the speed, torque, and Pm units.

Set the scaling factor (0.0001 to 99999.9999).

Set the scaling factor that is used to convert the signal from the revolution sensor or torque meter to speed (rotating speed), torque, and Pm (motor output).

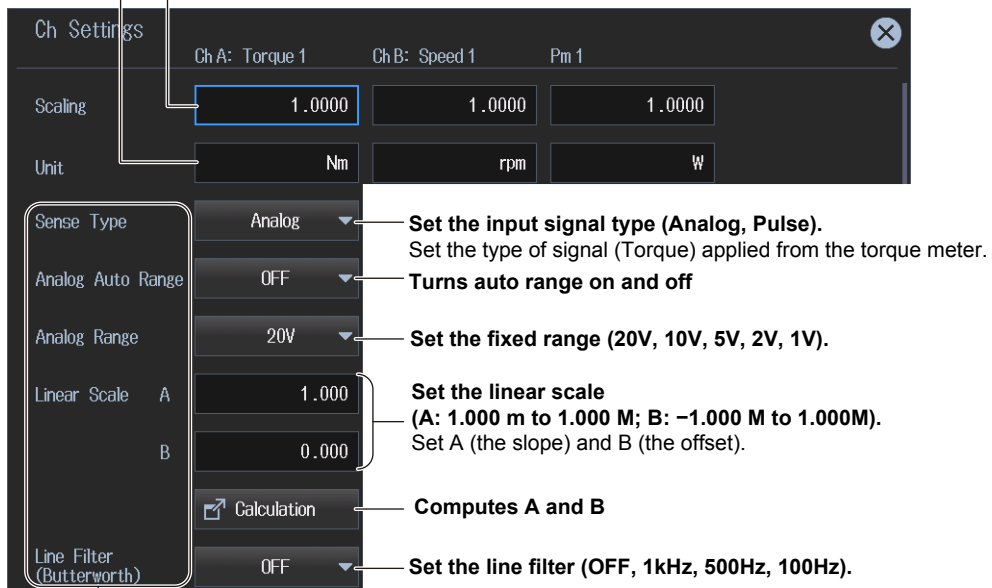

You can set these when Sense Type is set to Analog.

9.1 Configuring Motor Evaluation and Auxiliary Input Settings

Drag the screen to display the bottom area of the setup screen.

(Torque column) (Speed column) (Pm column)

Pulse Noise Filter OFF OFF

Sync Source None

Pulse Range Upper 50.0000 10000.0000

Pulse Range Lower -50.0000 0.0000

Rated Upper 50.0000

Rated Freq Upper 15000Hz

Rated Lower -50.0000

Rated Freq Lower 5000Hz

Set the pulse noise filter (OFF, 1MHz, 10kHz).

Set the sync source (U1 to U7, I1 to I7, Ext Clk, Z Phase1 (ch D), Z Phase3 (ch H), None).

Set the upper and lower limits of the torque or rotating speed.
Torque: -10000.0000 to 10000.0000 [N•m]
Rotating speed: -99999.9999 to 99999.9999 [rpm]
* You can set the torque when Sense Type is set to Pulse.

Set the upper limit of the torque signal.
Rated value : -10000.0000 to 10000.0000 [N•m]
Positive rated pulse frequency: 1 to 100000000 [Hz]

Set the lower limit of the torque signal.
Rated value : -10000.0000 to 10000.0000 [N•m]
Negative rated pulse frequency: 1 to 100000000 [Hz]

You can set these when Sense Type is set to Pulse.

Drag the screen to display the bottom area of the setup screen.

(Torque column) (Speed column) (Pm column)

Pulse N 60

Pole 2

Source I1

Set the number of pulses per revolution of the revolution signal (1 to 9999).

Set the number of motor poles that will be used to compute the synchronous speed (1 to 99).

Set the voltage or current whose frequency will be measured to compute the synchronous speed (U1 to U7, I1 to I7).

Single Motor (Speed:Analog)

4. Tap **Ch Settings**. A single motor (revolution signal: analog) setup screen appears.

Ch A Torque 1

Ch B

Ch C Speed 1

Ch D

Motor 1

Torque 1 Pulse

Speed 1 20V

Ch Settings

Shows the input ranges of the torque signal and revolution signal.
The torque signal appears when Sense Type is set to Analog.

Ch Settings button

9.1 Configuring Motor Evaluation and Auxiliary Input Settings

Single motor (revolution signal: analog) setup screen

Set the unit (up to 8 characters).

Set the speed, torque, and Pm units.

Set the scaling factor (0.0001 to 99999.9999).

Set the scaling factor that is used to convert the signal from the revolution sensor or torque meter to speed (rotating speed), torque, and Pm (motor output).

Set the input signal type (Analog, Pulse).
Set the type of signal (Torque) applied from the torque meter.

Turns auto range on and off

Set the fixed range (20V, 10V, 5V, 2V, 1V).

Set the linear scale (A: 1.000 m to 1.000 M; B: -1.000 M to 1.000M).
Set A (the slope) and B (the offset).

Computes A and B

Set the line filter. (OFF, 1kHz, 500Hz, 100Hz)

You can set the range, scale, filter, and the like of the torque signal when Sense Type is set to Analog.

Drag the screen to display the bottom area of the setup screen.

Set the pulse noise filter (OFF, 1MHz, 100kHz, 10kHz).

Set the sync source (U1 to U7, I1 to I7, Ext Clk, Z Phase1 (Ch D), Z Phase3 (Ch H), None).

Set the upper and lower limits of the torque or rotating speed.
Torque: -10000.0000 to 10000.0000 [N·m]

Set the upper limit of the torque signal.
Rated value : -10000.0000 to 10000.0000 [N·m]
Positive rated pulse frequency: 1 to 100000000 [Hz]

Set the lower limit of the torque signal.
Rated value : -10000.0000 to 10000.0000 [N·m]
Negative rated pulse frequency: 1 to 100000000 [Hz]

You can set these when Sense Type is set to Pulse.

Drag the screen to display the bottom area of the setup screen.

Set the number of motor poles that will be used to compute the synchronous speed (1 to 99).

Set the voltage or current whose frequency will be measured to compute the synchronous speed (U1 to U7, I1 to I7).

Double Motor

4. Tap Ch Settings. A double motor setup screen appears.

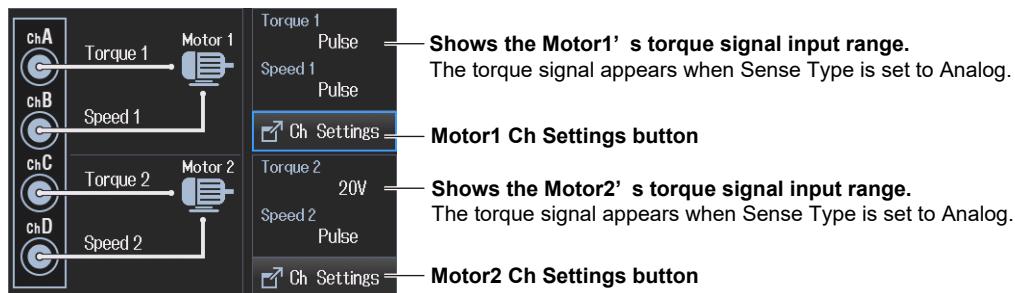

Double motor setup screen

Set the unit (up to 8 characters).

Set the speed, torque, and Pm units.

Set the scaling factor (0.0001 to 99999.9999).

Set the scaling factor that is used to convert the signal from the revolution sensor or torque meter to speed (rotating speed), torque, and Pm (motor output).

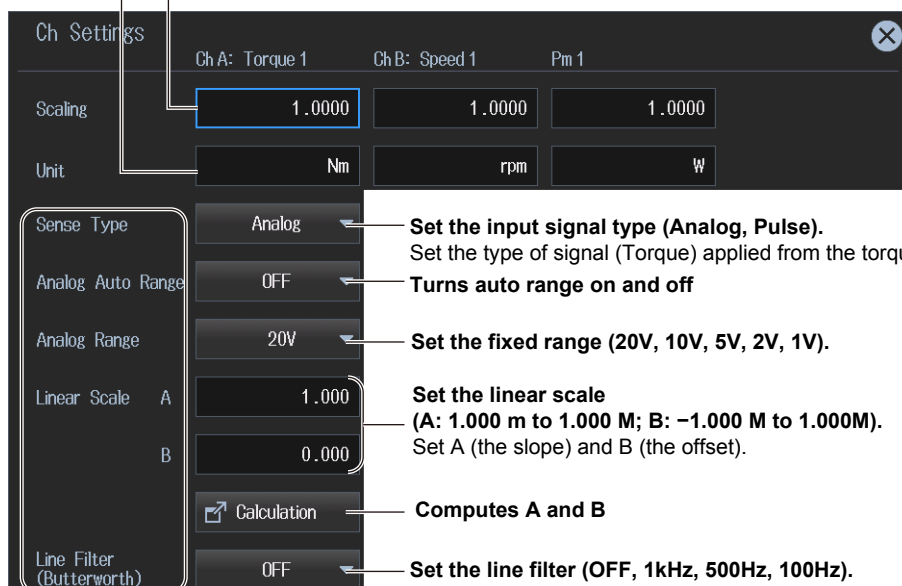

You can set these when Sense Type is set to Analog.

9.1 Configuring Motor Evaluation and Auxiliary Input Settings

Drag the screen to display the bottom area of the setup screen.

(Torque column) (Speed column) (Pm column)

Set the pulse noise filter (OFF, 1MHz, 100kHz, 10kHz).

Set the sync source (U1 to U7, I1 to I7, Ext Clk, Z Phase1 (Ch D), Z Phase3 (Ch H), None).

Set the upper and lower limits of the torque or rotating speed.
 Torque: -10000.0000 to 10000.0000 [N·m]
 Rotating speed: 0.0000 to 99999.9999 [rpm]
 * You can set the torque when Sense Type is set to Pulse.

Set the upper limit of the torque signal.
 Rated value : -10000.0000 to 10000.0000 [N·m]
 Positive rated pulse frequency: 1 to 100000000 [Hz]

Set the lower limit of the torque signal.
 Rated value : -10000.0000 to 10000.0000 [N·m]
 Negative rated pulse frequency: 1 to 100000000 [Hz]

You can set these when Sense Type is set to Pulse.

Drag the screen to display the bottom area of the setup screen.

(Torque column) (Speed column) (Pm column)

Set the number of pulses per revolution of the revolution signal (1 to 9999).

Set the number of motor poles that will be used to compute the synchronous speed (1 to 99).

Set the voltage or current whose frequency will be measured to compute the synchronous speed (U1 to U7, I1 to I7).

Auxiliary

4. Tap **Ch Settings**. An auxiliary input setup screen appears.

Shows the auxiliary signal input range.
 This appears when Sense Type is set to Analog.

Ch Settings button

Auxiliary input setup screen

Set the scaling factor (0.0001 to 99999.9999).
 Set the scaling factor for scaling or computing auxiliary signals.

Set the signal name (up to 8 characters).
 Set the signal names for Aux1 to Aux4.

Set the unit (up to 8 characters).
 Set the auxiliary signal unit.

Set the input signal type (Analog, Pulse).
 Set the auxiliary signal type.

Turns auto range on and off

Set the fixed range (20V, 10V, 5V, 2V, 1V).

Set the linear scale
(A: 0.001m to 1.000M and -0.001m to -1.000M,
B: -1.000M to 1.000M).
 Set A (the slope) and B (the offset).

Computes A and B

You can set these when Sense Type is set to Analog.

Drag the screen to display the bottom area of the setup screen.

Set the line filter (OFF, 1kHz, 500Hz, 100Hz).¹

Set the pulse noise filter
(OFF, 1MHz, 100kHz, 10kHz).

Set the upper limit of the auxiliary signal
(-10.00M to 10.00M).

Set the lower limit of the auxiliary signal
(-10.00M to 10.00M).

You can set these when Sense Type is set to Pulse.

1 You can set this when Sense Type is set to Analog.

Computing A and B (Calculation)

Compute A (slope) and B (offset) from two points on the characteristics graph of the input signal.

Torque A and B

On the Motor/Aux setup screen, tap **Calculation** under Torque. The following screen appears.

Calculation

$Y = AX + B$

Point 1 X [V] 1.000

Point 1 Y [Nm] 1.000

Point 2 X [V] -1.000

Point 2 Y [Nm] -1.000

Cancel Execute

Set the first X-axis value [V] and Y-axis value [Nm] (-1.000 T to 1.000 T).

Set the second X-axis value [V] and Y-axis value [Nm] (-1.000 T to 1.000 T).

Computes A and B

Cancels the computation

Rotating Speed A and B

On the Motor/Aux setup screen, tap **Calculation** under Speed. The following screen appears.

Calculation

$Y = AX + B$

Point 1 X [V] 1.000

Point 1 Y [rpm] 1.000

Point 2 X [V] -1.000

Point 2 Y [rpm] -1.000

Cancel Execute

Single Motor (Speed: Analog)

Set the first X-axis value [V] and Y-axis value [rpm] (-1.000 T to 1.000 T).

Set the second X-axis value [V] and Y-axis value [rpm] (-1.000 T to 1.000 T).

Computes A and B

Cancels the computation

External Signal Input A and B

On the Motor/Aux setup screen, tap **Calculation** under Aux1 to Aux4. The following screen appears.

Calculation

$Y = AX + B$

Point 1 X [V] 1.000

Point 1 Y [Unit] 1.000

Point 2 X [V] -1.000

Point 2 Y [Unit] -1.000

Cancel Execute

Set the first X-axis value [V] and Y-axis value [Unit] (-1.000 T to 1.000 T).

Set the second X-axis value [V] and Y-axis value [Unit] (-1.000 T to 1.000 T).

Computes A and B

Cancels the computation

Setting the Electrical Angle Measurement (Electrical Angle Measurement)

Selecting the Harmonic Group (Harmonics Trigger)

- Tap **ON/OFF** under Electrical Angle Measurement. The button changes to ON. The Harmonics and Correction buttons next to the ON/OFF button become available (step 7).
- Tap **Harmonics Trigger**. A Harmonics Trigger screen appears.

Set the harmonic analysis trigger.

(Hrm①: Z Phase 1 (Ch D) Hrm①: Z Phase 1 (Ch D) Hrm①: None
 Hrm②: Z Phase 1 (Ch D), Hrm②: None , Hrm②: Z Phase 1 (Ch D))

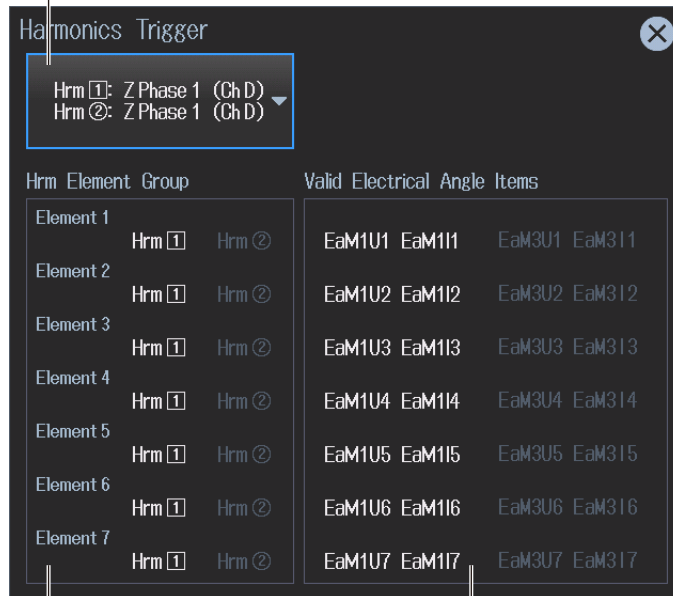

Shows harmonic element grouping

Electrical angle measurement items

These are determined and shown automatically depending on the configuration.

Hrm①: Z Phase 1 (Ch D)
Hrm②: Z Phase 1 (Ch D) : Set the Hrm1 and Hrm2 triggers to the Z phase of motor 1.

Hrm①: Z Phase 1 (Ch D)
Hrm②: None : Set the Hrm1 trigger to the Z phase of motor 1.

Hrm①: None
Hrm②: Z Phase 1 (Ch D) : Set the Hrm2 trigger to the Z phase of motor 1.

Note

The harmonic analysis trigger parameters vary depending on the /MTR1 option and /MTR2 option.

- **Electrical angle measurement of motor 1 set to on and Electrical angle measurement of motor 2 set to off**

Hrm1: Z Phase1 and Hrm2: Z Phase1
 Hrm1: Z Phase1 and Hrm2: None
 Hrm1: None and Hrm2: Z Phase1

- **Electrical angle measurement of both motor 1 and motor 2 set to on**

Hrm1: Z Phase1 and Hrm2: Z Phase3
 Hrm1: Z Phase3 and Hrm2: Z Phase1

- **Electrical angle measurement of motor 1 set to off and electrical angle measurement of motor 2 set to on**

Hrm1: Z Phase3 and Hrm2: Z Phase3
 Hrm1: Z Phase3 and Hrm2: None
 Hrm1: None and Hrm2: Z Phase3

9.1 Configuring Motor Evaluation and Auxiliary Input Settings

Setting the Electrical Angle Correction Value (Electric Angle Correction)

7. Tap **Correction**. An Electric Angle Correction screen appears.

Set the correction value (-180.00 to 180.00).

Can be set on models with the /MTR2 option.

Automatically computes the correction value
Correction Value is set to the computed value.

Set the voltage or current to automatically compute the correction value of (U1 to U7, I1 to I7).

Setting the Motor Efficiency Computation

This instrument can compute the motor efficiency (the ratio of power consumption to motor output) and total efficiency from the active power and motor output that it measures.* For information on how to set expressions, see section 2.11.

- Example in which motor efficiency is set to η1 and total efficiency to η2

$$\text{Motor efficiency } \eta_1(\%) = \frac{\text{Motor output } P_m (W)}{P_{\Sigma A}(W)} \times 100$$

$$\text{Total efficiency } \eta_2(\%) = \frac{\text{Motor output } P_m (W)}{P_{\Sigma B}(W)} \times 100$$

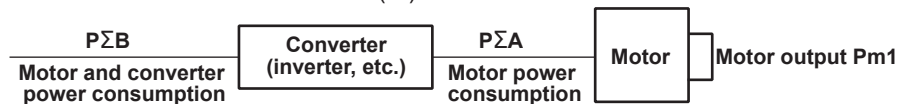

Efficiency button

Computation/Output tab

Motor efficiency setup example

Total efficiency setup example

Procedure Using the Input Information Area (Options tab)

If you use the input information area shown on the right side of the screen, you can set the analog range, line filter, and pulse noise filter while viewing the measurements. These settings are the same as those in “Configuring the Channels (Ch Settings)” described earlier.

1. Tap the **Options** tab. An Options menu appears in the input information area.
2. Tap the channel (Ch A to Ch H) you want to control. A channel setup screen appears.
The channel display and channel setup screen vary depending on the motor evaluation configuration setting.

Line filter (OFF, 1kHz, 500Hz, 100Hz)

You can use this when the input signal type is analog.

Analog range (20V, 10V, 5V, 2V, 1V)

You can use this when the input signal type is analog.

Turns analog auto range on and off

You can use this when the input signal type is analog.

Options tab

Options tab

Tap a channel to display the channel setup screen.

You can use Ch C and Ch D when the motor evaluation configuration is set to Double Motor or Auxiliary.

Can be set on models with the /MTR2 option.

You can use Ch G and Ch H when the motor evaluation configuration is set to Double Motor or Auxiliary.

pulse noise filter (OFF, 1MHz, 100kHz, 10kHz)
You can use this when the input signal type is pulse.

Procedure Using Keys

You can use the front panel keys to display the input information area and the motor evaluation condition setup screen.

1. Press **OPTIONS**. The input information area display changes to Options tab.
2. Press **OPTIONS** again. A motor evaluation condition setup screen appears.
Press **OPTIONS** yet again to return to the input information area (Options tab) display.



9.2 Displaying the Motor Evaluation (numeric display)

This instrument shows on the screen the measurements (measurement functions) of motor evaluation based on the revolution sensor or torque meter signals applied to Ch A to Ch H on the rear panel. In addition, this instrument shows on the screen the measurements (measurement functions) of the motor power consumption based on the voltage or current applied to the wiring units. Using an example, this section explains how to display motor evaluation measurements numerically. Note that to determine the motor efficiency or total efficiency values (η), you need to set equations (see sections 2.11 and 9.1).

In addition, this section explains operating procedures using the following setup methods.

- Procedure Using the Setup Menu (see chapter 1)
- Procedure Using the Menu Icons (see page iii)

Measurement Display Screen (Example of a 4 items display)

Motor evaluation measurement display

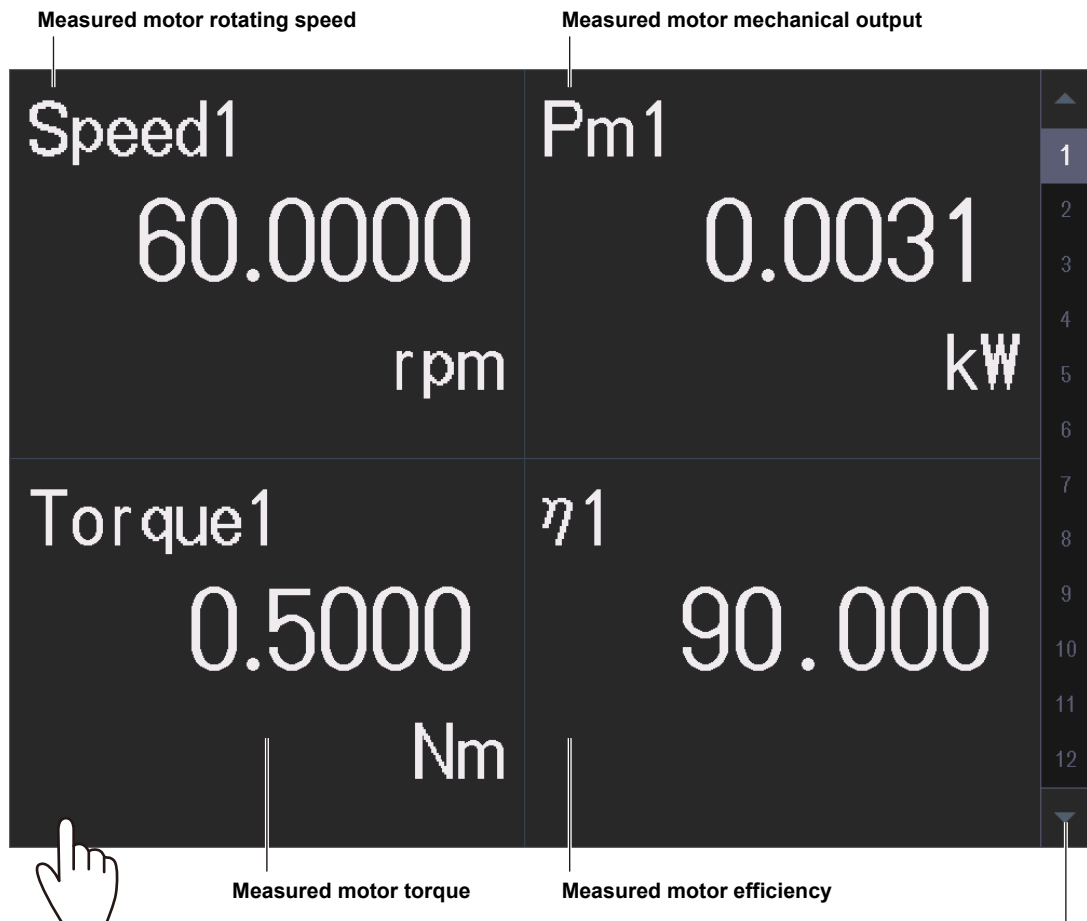

If you hold your finger down on the 4-, 8-, 16-value, matrix or harmonics display for at least 1 second, you can perform the operations described in "Switching the Displayed Items (Items)," provided later.

Switches the displayed page (Page Up/Page Down)
Switches to the measurement display of another input element
Tap ▲ or ▼ to change the displayed page in order from the current number. Tap the number directly to change to the number display page.

Procedure Using the Setup Menu

1. Tap the **Setup** icon , or press **MENU** under SETUP.
2. Tap **Computation/Output** tab. A computation and output settings overview screen appears. Pressing **ESC** closes the overview screen.

Switching the Displayed Items (Items)

You can switch the measured value (measurement function) shown in the screen.

3. Tap **Display**.
A display format setup screen (Numeric/Graph) appears. For details, see section 3.1.
4. Tap **Items**. The following screen appears.

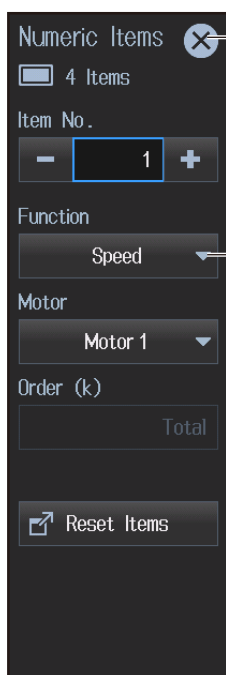

Closes the menu

Set the displayed item.

You can set the following items for displaying motor evaluation.

- Motor evaluation (Motor group):
Speed (motor rotating speed), **Torque** (motor torque),
SyncSP (sync speed), **Slip** (slip (%)),
Pm (Motor mechanical output (mechanical power)),
EaM1U1 to EaM1U7
 (electrical angle: phase angles of U1 to U7 relative to the falling edge of the Speed1 signal' s Z phase input),
EaM3U1 to EaM3U7
 (electrical angle: phase angles of U1 to U7 relative to the falling edge of the Speed3 signal' s Z phase input),
EaM1I1 to EaM1I7
 (electrical angle: phase angles of I1 to I7 relative to the falling edge of the Speed1 signal' s Z phase input),
EaM3I1 to EaM3I7
 (electrical angle: phase angles of I1 to I7 relative to the falling edge of the Speed3 signal' s Z phase input)

- Efficiency (Efficiency group):
 η 1 to η 4 (efficiency)

Procedure Using the Menu Icons

You can also use the menu icons shown on the right side of the screen to switch the displayed items.

1. Tap the **Display** menu icon . A Display menu appears in the sub menu area on the right side of the screen.
By tapping the displayed items, you can specify the same settings as when using the screen explained earlier.

Note

For details on the Display menu, see page iv.

10.1 Holding Measured Values

► “Holding Measured Values (Hold, HOLD)” in the features guide

This section explains operating procedures using the following setup methods.

- Procedure Using the Menu Icons (see page iii)
- Procedure Using the Keys (other than SETUP) (see section 1.2 in IM WT5000-03EN)

Procedure Using the Menu Icons

1. Tap the **Misc** menu icon . A Misc menu appears in the sub menu area on the right side of the screen.
2. Tap the Hold **ON/OFF** button to select ON. The HOLD key illuminates, and the displayed measured value is held.
Tap the Hold **ON/OFF** button to select OFF. This releases the held measured values. The measured data is then updated at the specified data update interval (see section 2.10).

Misc Menu

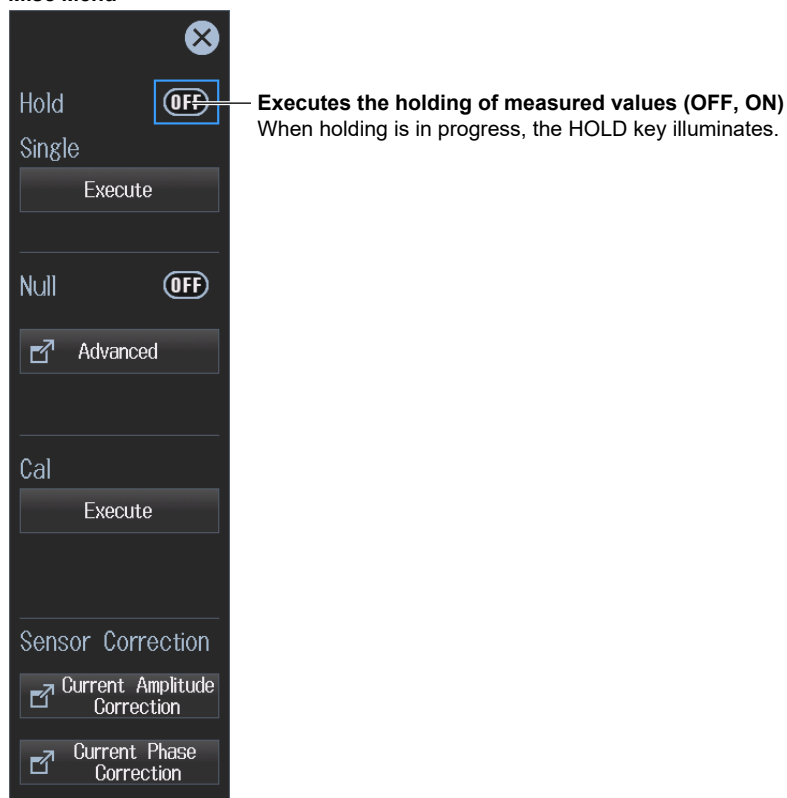

If you hold the measured value, the data update counter at the top of the screen stops.

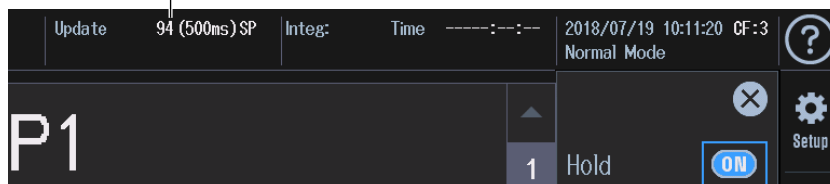

Note

Values in the numeric data list of D/A output, communication output, and the like as well as the graph display are put on hold.

Procedure Using Keys

You can also use the front panel keys to hold the measured values.



Holding Measured Values

The HOLD key LED illuminates, and the measure values are put on hold.

10.2 Single Measurement

► “Single Measurement (Single Execute, SINGLE)” in the features guide

This section explains operating procedures using the following setup methods.

- Procedure Using the Menu Icons (see page iii)
- Procedure Using the Keys (other than SETUP) (see section 1.2 in IM WT5000-03EN)

Procedure Using the Menu Icons

1. Tap the **Misc** menu icon . A Misc menu appears in the sub menu area on the right side of the screen.
2. Tap the Hold **ON/OFF** button to select ON. The HOLD key illuminates, and the displayed measured value is held.
3. Tap **Execute** under Single. A single measurement is performed at the specified data update rate, and the instrument then holds the measured value.

Misc Menu

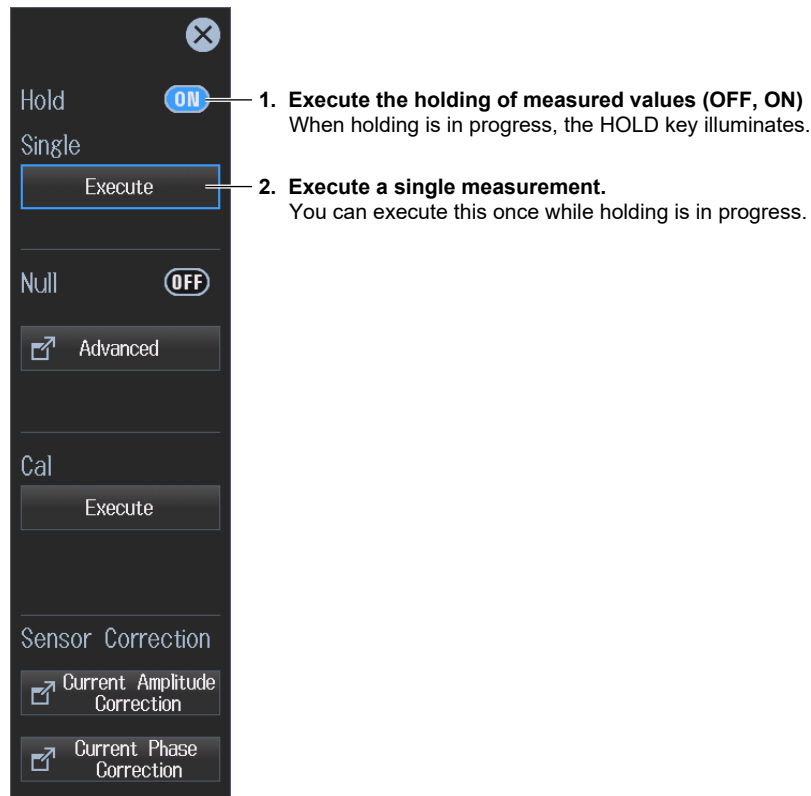

Note

- If, while the HOLD key is illuminated, you tap Hold again, the HOLD key will turn off, and the held measured values will be released. If you tap Single Execute while the hold feature is released, the measured value is updated (re-measured) when the time specified by the data update rate elapses after you tap the key.
- When the update mode is Auto, single measurement is not possible.

Procedure Using Keys

You can also use the front panel keys to perform single measurements.



Single measurement

While the HOLD key LED is illuminated, a measurement is executed once, and the display is updated.

11.1 Configuring, Enabling, and Disabling the Null Feature

▶ “Null Feature (Null)” in the features guide

▶ “Enabling and Disabling the Null Feature (Null, NULL)” in the features guide

This section explains operating procedures using the following setup methods.

- Procedure Using the Setup Menu (see chapter 1)
- Procedure Using the Menu Icons (see page iii)
- Procedure Using the Keys (other than SETUP) (see section 1.2 in IM WT5000-03EN)

Procedure Using the Setup Menu

1. Tap the **Setup** icon , or press **MENU** under **SETUP**.
2. Tap the **Input (Advanced/Options)** tab. An input settings (advanced/options) overview screen appears.
Pressing **ESC** closes the overview screen.
3. Tap **Null**. The null feature setup screen appears.

Using the menu icon or the front panel keys on the next page, enable and disable the null feature.

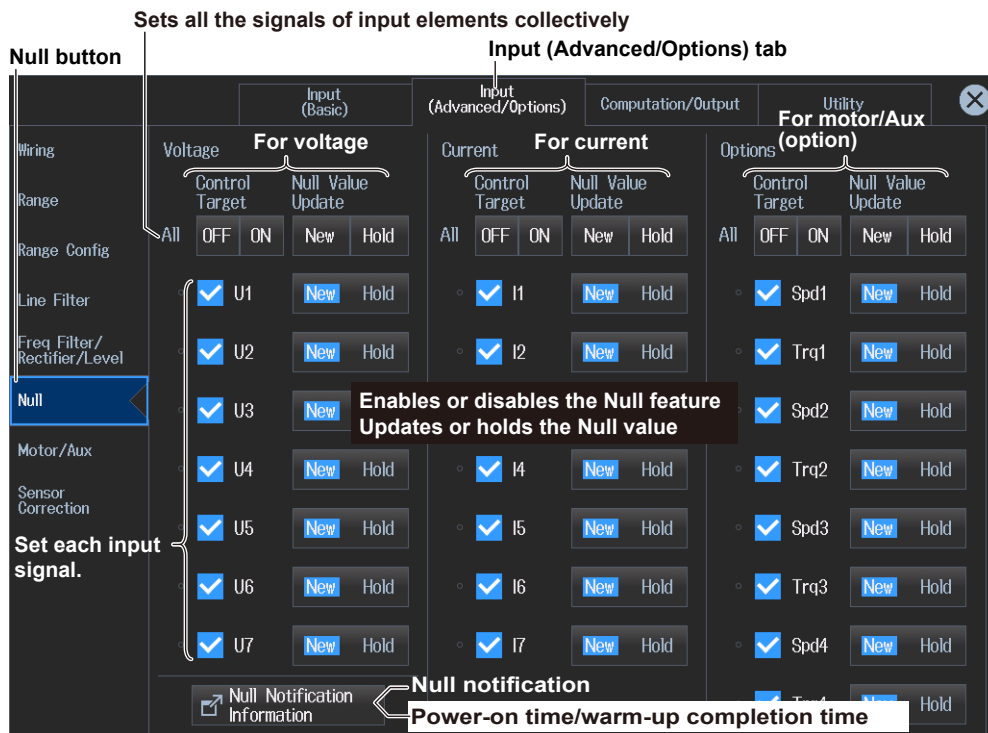

Note

You can also display the input settings (advanced/options) overview screen by moving the cursor on the Input (Advanced/Options) tab using the arrow keys and then pressing SET.

Procedure Using the Menu Icons

You can use the menu icons shown on the right side of the screen to configure, enable, and disable the null feature.

1. Tap the **Misc** menu icon . A Misc menu appears in the sub menu area on the right side of the screen.
By tapping the displayed items, you can specify the same settings as when using the tap operation explained earlier.

Configuring, Enabling, and Disabling the Null Feature

2. Tap **Advanced** under Null. The same null feature setup screen appears as shown on the previous page.
3. After configuring the feature, close the screen.
4. Tap the Null **ON/OFF** button to select ON. The NULL key illuminates, and the null feature is enabled.
 - The null value of each input signal is used for those signals whose null feature mode is set to ON.
 - If you tap the Null **ON/OFF** button and select OFF, the NULL key turns off, and the null feature is disabled.



Procedure Using Keys

You can use the front panel keys to enable and disable the null feature.



Enables or disables the null feature
While the null feature is enabled, the NULL key LED illuminates.

11.2 Zero-Level Compensation (Cal)

► “Zero-Level Compensation (Cal Execute, CAL)” in the features guide

This section explains operating procedures using the following setup methods.

- Procedure Using the Menu Icons (see page iii)
- Procedure Using the Keys (other than SETUP) (see section 1.2 in IM WT5000-03EN)

Procedure Using the Menu Icons

1. Tap the **Misc** menu icon . A Misc menu appears in the sub menu area on the right side of the screen.
2. Tap the **Execute** under Cal. Zero-level compensation is executed.

Misc menu

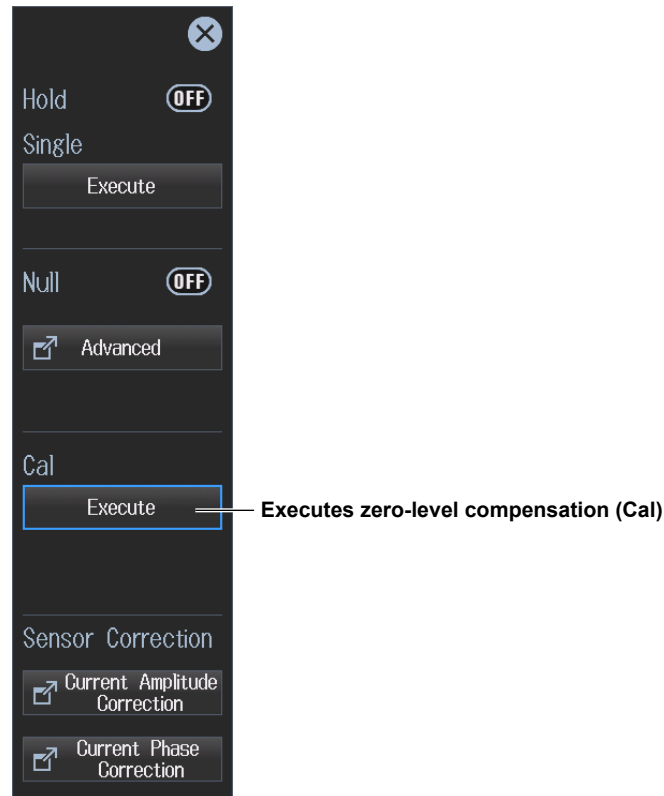

Note

- The instrument automatically performs zero-level compensation after you change the measurement range or input filter.
- To make accurate measurements, we recommend that you execute zero-level compensation after warming up the instrument for at least 30 minutes.
- If the measurement range and input filter remain the same for a long period of time, the zero level may change due to the changes in the instrument's environment. If this happens, we recommend that you execute zero-level compensation.
- The integration feature includes an auto calibration feature that automatically performs zero-level compensation.

Procedure Using Keys

You can also use the front panel keys to execute zero-level compensation (Cal).

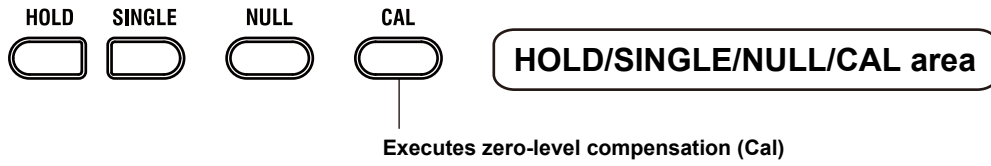

12.1 Cursor Measurement on Waveforms

This instrument shows on the screen the waveforms of the voltage and current applied to the input elements or wiring units. When you place cursors on the waveforms, the instrument shows the measured values at the cursor positions.

► [“Cursor Measurement \(Cursors\)” in the features guide](#)

Using an example, this section explains how to display waveform cursor measurement results. In addition, this section explains operating procedures using the following setup methods.

- Procedure Using the Setup Menu (see chapter 1)
- Procedure Using the Menu Icons (see page iii)

Cursor Measurement on Waveforms (Example of voltage and current)

Waveform display of input element 1

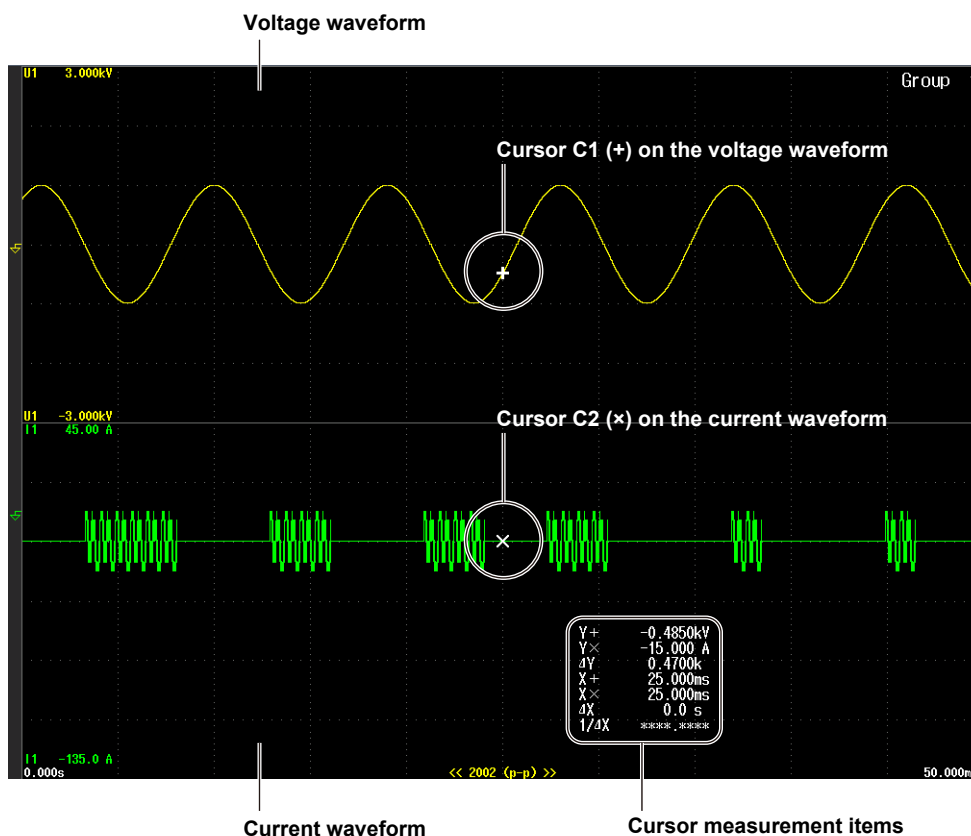

Procedure Using the Setup Menu

1. Tap the **Setup** icon , or press **MENU** under **SETUP**.
2. Tap **Computation/Output** tab. A computation and output settings overview screen appears. Pressing **ESC** closes the overview screen.
3. Tap **Display**.
A display format setup screen (Numeric/Graph) appears. For details, see section 6.1.

Setting the Graph Display Type (Graph)

4. Tap **Graph** to select Wave.

Note

For instructions on how to display the waveforms, see sections 6.1 and 6.2.

Displaying the Cursors (Cursors)

5. Tap **Cursors**. A Wave Cursors screen appears.

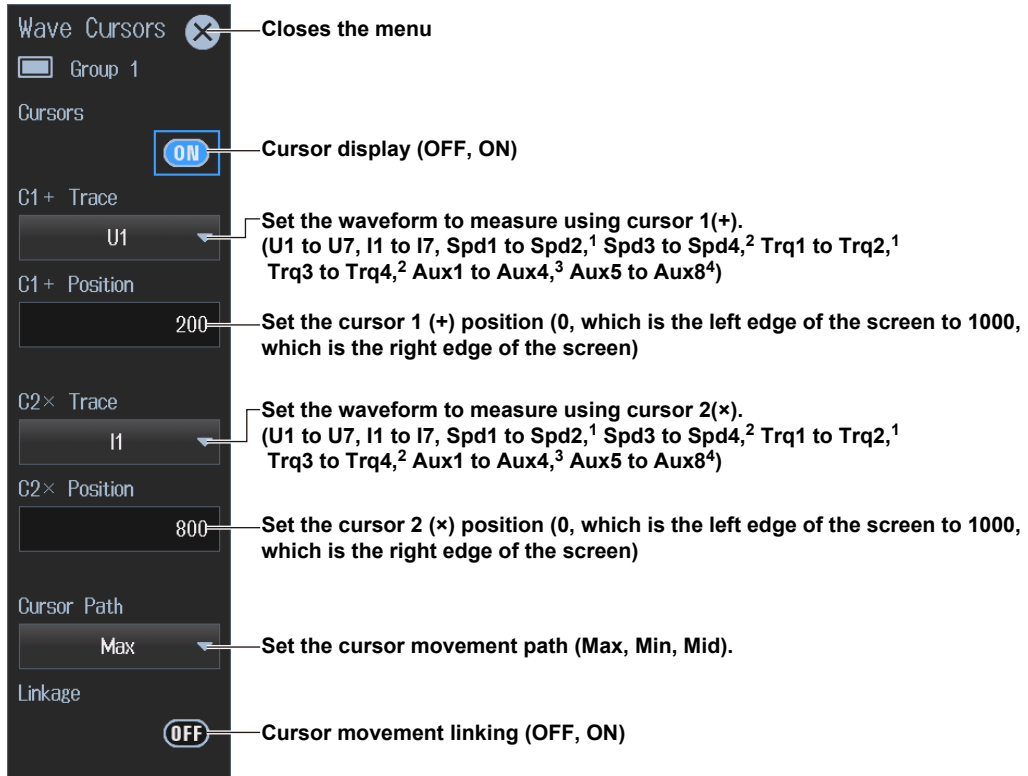

- 1 You can set this on models with the /MTR1 option when MTR Configuration is set to Single Motor or Double Motor (see section 9.1).
- 2 You can set this on models with the /MTR2 option when MTR Configuration is set to Single Motor or Double Motor (see section 9.1).
- 3 You can set this on models with the /MTR1 option when MTR Configuration is set to Auxiliary (see section 9.1).
- 4 You can set this on models with the /MTR2 option when MTR Configuration is set to Auxiliary (see section 9.1).

Procedure Using the Menu Icons

You can also use the menu icons shown on the right side of the screen to switch the displayed items.

1. Tap the **Display** menu icon . A Display menu appears in the sub menu area on the right side of the screen.

By tapping the displayed items, you can specify the same operation as explained in “Switching the Displayed Items” described earlier.

Note

For details on the Display menu, see page iv.

12.2 Cursor Measurement on Trends

This instrument shows on the screen the trends of the voltage and current applied to the input elements or wiring units. When you place cursors on the trends, the instrument shows the measured values at the cursor positions.

► “Cursor Measurement (Cursors)” in the features guide

Using an example, this section explains how to display trend cursor measurement results. In addition, this section explains operating procedures using the following setup methods.

- Procedure Using the Setup Menu (see chapter 1)
- Procedure Using the Menu Icons (see page iii)

Cursor Measurement on Trends (Example of voltage and current)

Trend display of input element 1

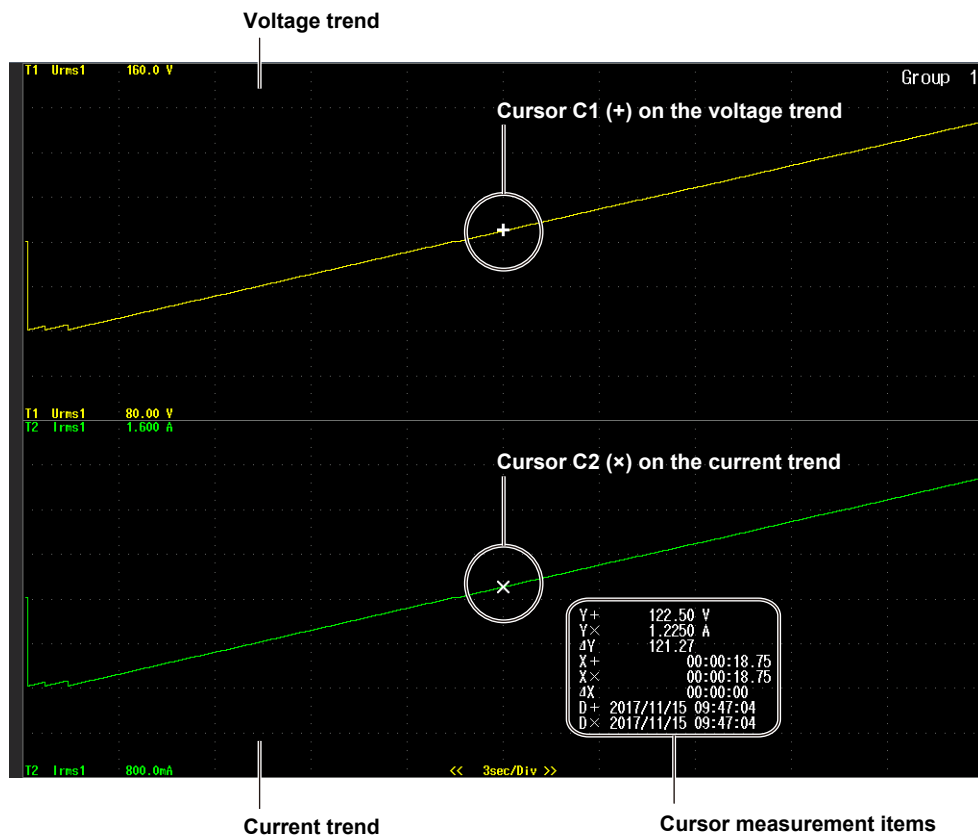

Procedure Using the Setup Menu

1. Tap the **Setup** icon , or press **MENU** under **SETUP**.
2. Tap **Computation/Output** tab. A computation and output settings overview screen appears. Pressing **ESC** closes the overview screen.
3. Tap **Display**.

A display format setup screen (Numeric/Graph) appears. For details, see section 6.1.

Setting the Graph Display Type (Graph)

4. Tap **Graph** to select Trend.

Note

For instructions on how to display the waveforms, see sections 6.1 and 6.3.

Displaying the Cursors (Cursors)

5. Tap **Cursors**. A Trend Cursors screen appears.

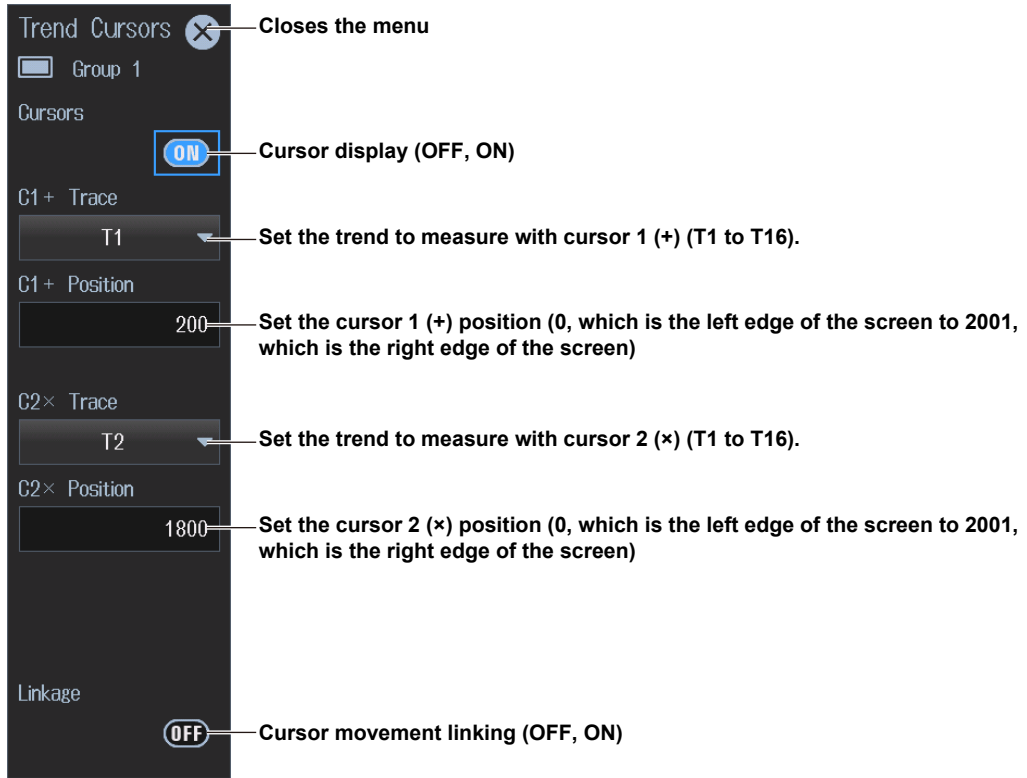

Procedure Using the Menu Icons

You can also use the menu icons shown on the right side of the screen to switch the displayed items.

1. Tap the **Display** menu icon . A Display menu appears in the sub menu area on the right side of the screen.

By tapping the displayed items, you can specify the same operation as explained in "Switching the Displayed Items" described earlier.

Note

For details on the Display menu, see page iv.

12.3 Cursor Measurement on Bar Graphs

This instrument shows on the screen the harmonic orders and magnitudes of the voltage, current, and the like applied to the input elements with bar graphs. When you place cursors on the bar graphs, the instrument shows the measured values at the cursor positions.

► [“Cursor Measurement \(Cursors\)” in the features guide](#)

Using an example, this section explains how to display bar graph cursor measurement results. In addition, this section explains operating procedures using the following setup methods.

- Procedure Using the Setup Menu (see chapter 1)
- Procedure Using the Menu Icons (see page iii)

Cursor Measurement on Bar Graphs (Example of voltage and current)

Bar graph display of input element 1

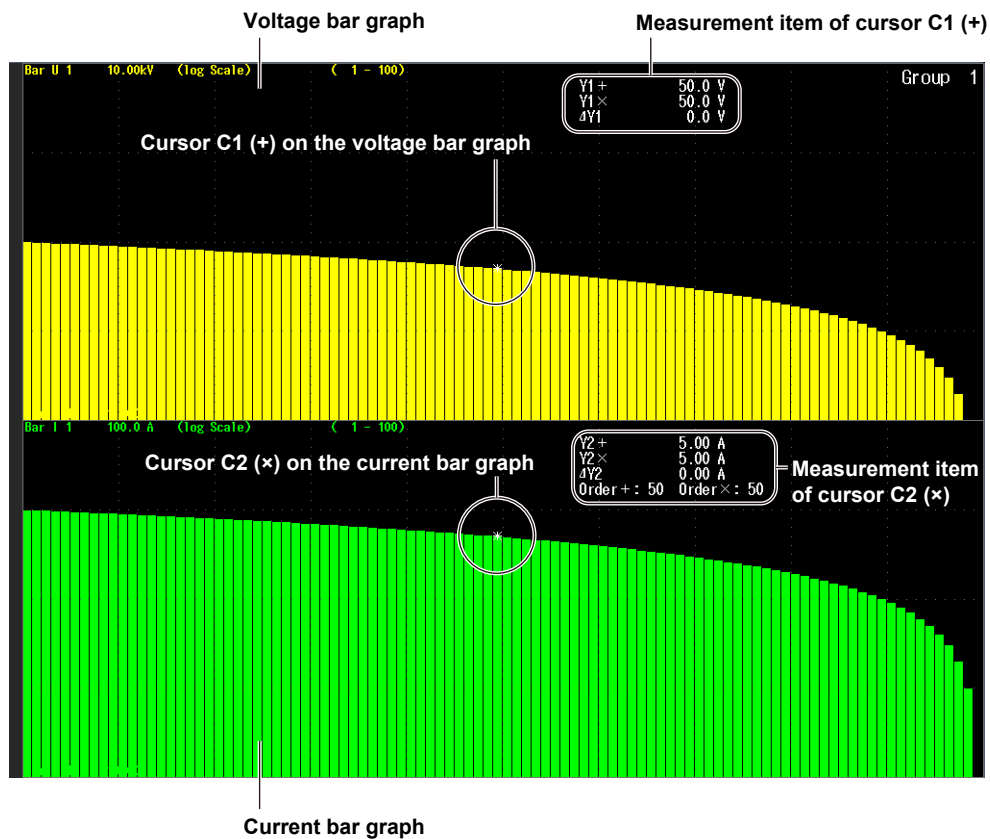

Procedure Using the Setup Menu

1. Tap the **Setup** icon , or press **MENU** under **SETUP**.
2. Tap **Computation/Output** tab. A computation and output settings overview screen appears. Pressing **ESC** closes the overview screen.
3. Tap **Display**.
A display format setup screen (Numeric/Graph) appears. For details, see section 6.1.

Setting the Graph Display Type (Graph)

4. Tap **Graph** to select Bar.

Note

For instructions on how to display the waveforms, see sections 6.1 and 6.4.

Displaying the Cursors (Cursors)

5. Tap **Cursors**. The following screen appears.

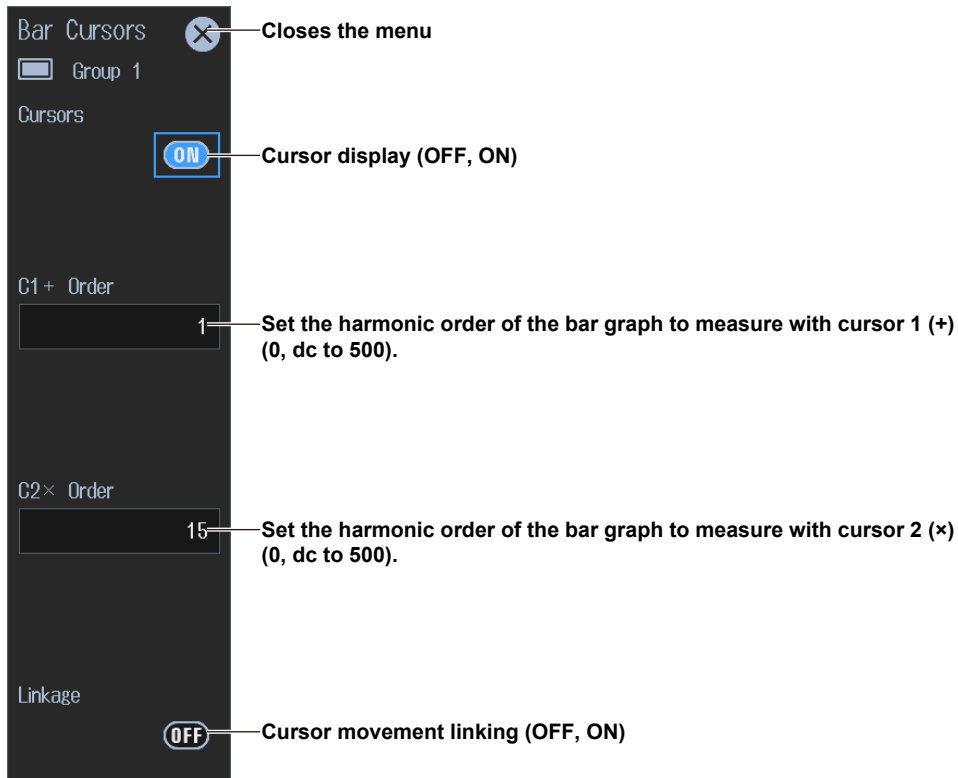

Procedure Using the Menu Icons

You can also use the menu icons shown on the right side of the screen to switch the displayed items.

1. Tap the **Display** menu icon . A Display menu appears in the sub menu area on the right side of the screen.
By tapping the displayed items, you can specify the same operation as explained in "Switching the Displayed Items" described earlier.

Note

For details on the Display menu, see page iv.

13.1 Setting IEC Harmonic Measurement Conditions

- ▶ “IEC Harmonic Measurement (Option)” in the features guide
- ▶ “Harmonic Measurement Conditions (Harmonics)” in the features guide

This section explains how to perform harmonic measurements in accordance with IEC 61000-4-7. Harmonic measurement and judgment can be performed in accordance with IEC 61000-3-2 by controlling this instrument using the Harmonic/Flicker Measurement Software (sold separately). This section explains operating procedures using the following setup methods.

- Procedure Using the Setup Menu (see chapter 1)

Note

- In IEC Harmonic measurement, there is a limitation on the instrument functions and measurement functions that can be measured. See the appendix in the *Getting Started Guide*, IM WT5000-03EN.
- While controlling this instrument with the Harmonic/Flicker Measurement Software, do not release the instrument’s remote mode and change the instrument’s settings. If you do, the instrument may not be able to perform harmonic measurement in accordance with the IEC standard. If you release the instrument’s remote mode, close the Harmonic/Flicker Measurement Software.

Procedure Using the Setup Menu

1. Tap the **Setup** icon , or press **MENU** under **SETUP**.
2. From the **Measurement Mode** pull-down menu, select IEC Harmonic. An IEC harmonic measurement setup screen appears.
Pressing **ESC** closes the setup screen.

Set this to IEC Harmonic.

Set the object under measurement (Element 1 to Element 7¹, ΣA to ΣC²).

Set the PLL source (U1 to U7,¹ I1 to I7,¹ Ext Clk).

Set the edition number of the IEC 61000-4-7. (Edition 1.0, Edition 2.0, Edition 2.0 A1)

Set the voltage grouping (OFF, Type 1, Type 2).

Set the current grouping (OFF, Type 1, Type 2).

Set the minimum value of the measured harmonic order (0, 1).

Set the maximum value of the measured harmonic order (1 to 500).

Set the distortion factor equation (1/Total, 1/Fundamental).

- 1 Can be set within the range of the installed input elements.
- 2 Can be set within the range of the wiring unit that is automatically determined by the installed input elements.

14.1 Configuring IEC Voltage Fluctuation/Flicker Measurements

- ▶ “IEC Voltage Fluctuation and Flicker Measurement (Option)” in the features guide
- ▶ “Measurement Conditions (Measured Settings)” in the features guide
- ▶ “Judgment Conditions (Limit Settings)” in the features guide

This section explains how to perform IEC voltage fluctuation/flicker measurements.

Operating procedures are explained using the following setup methods.

- Procedure Using the Setup Menu (see chapter 1)

Note

- In IEC voltage fluctuation/flicker measurement, there is a limitation on the instrument functions and measurement functions that can be measured. See the appendix in the *Getting Started Guide*, IM WT5000-03EN.
- While controlling this instrument with the Harmonic/Flicker Measurement Software, do not release the instrument’s remote mode and change the instrument’s settings. If you do, the instrument may not be able to perform voltage fluctuation/flicker measurement in accordance with the IEC standard. If you release the instrument’s remote mode, close the Harmonic/Flicker Measurement Software.

Procedure Using the Setup Menu

1. Tap the **Setup** icon , or press **MENU** under SETUP.
2. From the **Measurement Mode** pull-down menu, select IEC Flicker. A voltage fluctuation/flicker measurement setup screen appears.
Pressing **ESC** closes the setup screen.

Setting Measurement Conditions (Measured Settings)

3. Tap the **Measured Settings** tab. A measurement condition setup screen appears.

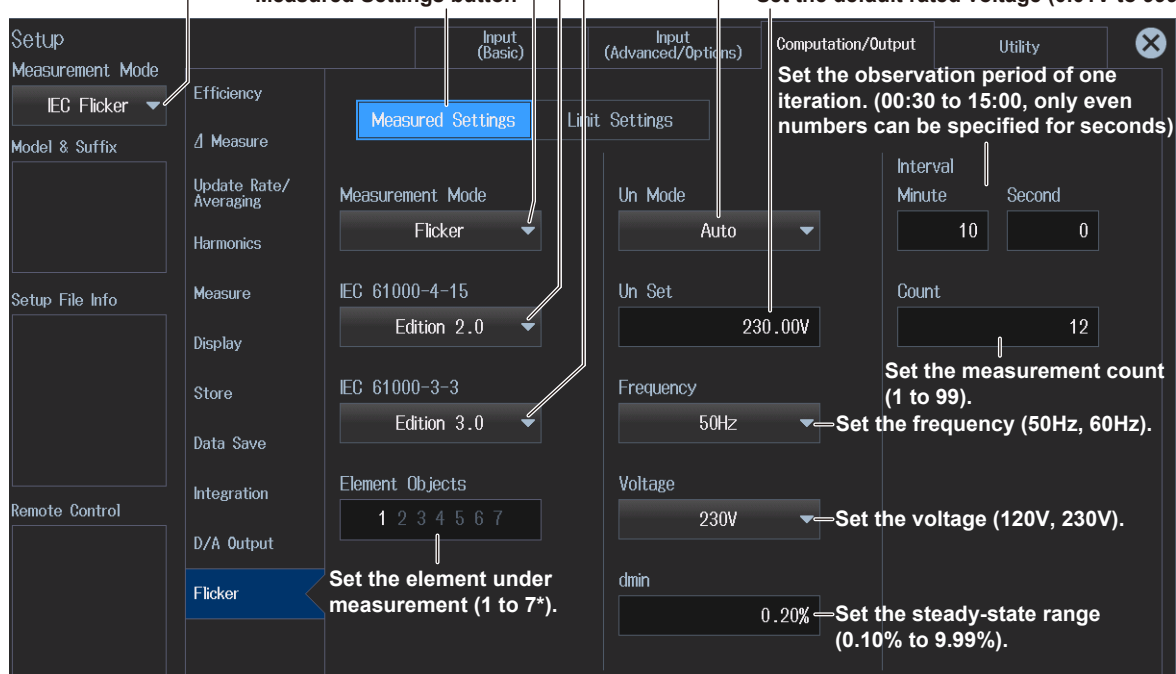

The screenshot shows the 'Measured Settings' screen for IEC Flicker measurement. The screen is divided into several sections: 'Input (Basic)', 'Input (Advanced/Options)', 'Computation/Output', and 'Utility'. Annotations with arrows point to specific settings:

- Measurement Mode:** Set to 'Flicker'.
- IEC 61000-4-15:** Set to 'Edition 2.0'.
- IEC 61000-3-3:** Set to 'Edition 3.0'.
- Un Mode:** Set to 'Auto'.
- Un Set:** Set to '230.00V'.
- Frequency:** Set to '50Hz'.
- Voltage:** Set to '230V'.
- Interval:** Set to 10 minutes and 0 seconds.
- Count:** Set to 12.
- dlmin:** Set to '0.20%'.

Additional annotations include: 'Set this to IEC Flicker.', 'Set the measurement mode (Flicker, dmax).', 'Set the edition number of IEC 61000-4-15 (Edition 1.1, Edition 2.0).', 'Set the edition number of IEC 61000-3-3 (Edition 2.0, Edition 3.0).', 'Set the rated voltage assignment method (Auto, Set).', 'Set the default rated voltage (0.01V to 999.99V).', 'Set the observation period of one iteration. (00:30 to 15:00, only even numbers can be specified for seconds)', and 'Set the measurement count (1 to 99).'. A note at the bottom states: '* Can be set within the range of the installed input elements.'

Setting Judgment Conditions (Limit Settings)

3. Tap the **Limit Settings** tab. A judgment condition setup screen appears.

Turn on or off the judgment of the period during which relative voltage change exceeds the threshold level T_{max} , set the T_{max} limit value (1 ms to 99999 ms), and set the threshold level (1.00% to 99.99%).

"d(t)" is displayed here when the IEC 61000-4-15 edition number is set to Edition 1.1 or the IEC 61000-3-3 edition number is set to Edition 2.0.

Turn on or off the judgment of the maximum relative voltage change d_{max} , and set the d_{max} limit value (1.00% to 99.99%).

Turn on or off the judgment of the relative steady-state voltage change dc , and set the dc limit value (1.00% to 99.99%).

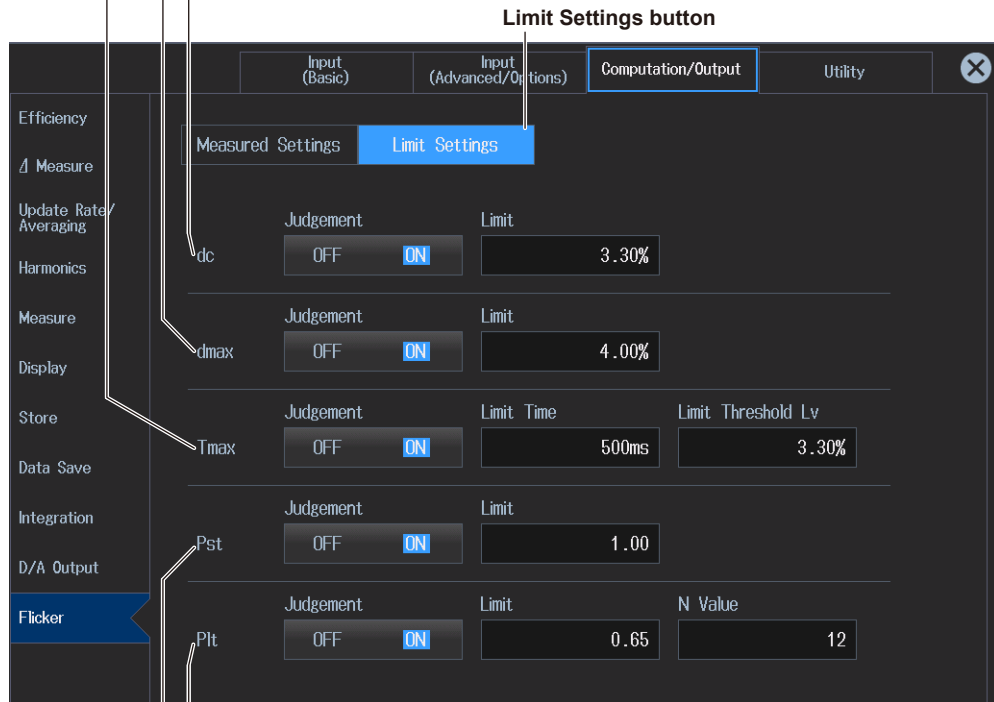

Turn on or off the judgment of the long-term flicker value Plt , set the Plt limit value (0.10 to 99.99), and set constant N of the calculation equation for long-term flicker value Plt (1 to 99).

Turn on or off the judgment of the short-term flicker value Pst , and set the Pst limit value (0.10 to 99.99).

14.2 Executing IEC Voltage Fluctuation/Flicker Measurements

- ▶ “Executing the Normal Voltage Fluctuation and Flicker Measurements” in the features guide
- ▶ “Executing the Measurement of dmax Caused by Manual Switching” in the features guide

This section explains how to perform IEC voltage fluctuation/flicker measurements. Operating procedures are explained using the following setup methods.

- Procedure Using the Menu Icons (see page iii)

For the relationships between measurement operation (transition of the flicker measurement status) and initializing, starting, and resetting, see the execution workflow of each measurement in the Features Guide.

1. Set the measurement mode to IEC Flicker according to steps 1 and 2 in section 14.1. The Integration icon at the right edge of the screen changes to the Flicker icon.
2. Tap the **Flicker** menu icon . A Flicker menu appears in the sub menu area on the right side of the screen.
3. Set the voltage fluctuation/flicker measurement mode to Flicker or dmax. A menu is displayed according to the selected measurement mode.
4. Tap **Initialize Exec** to perform initialization. Initialization takes about 30 seconds. When the flicker measurement status in the upper center of the screen changes to “Ready,” the **Start** button is enabled.
5. Tap **Start** to start measuring. In dmax measurement mode, when the measurement of a single observation period is completed, the measurement operation stops, and the flicker measurement status changes to “Ready.” To perform dmax measurement 24 times, tap **Start** every time the status becomes “Ready.”

Normal voltage fluctuation/flicker measurement

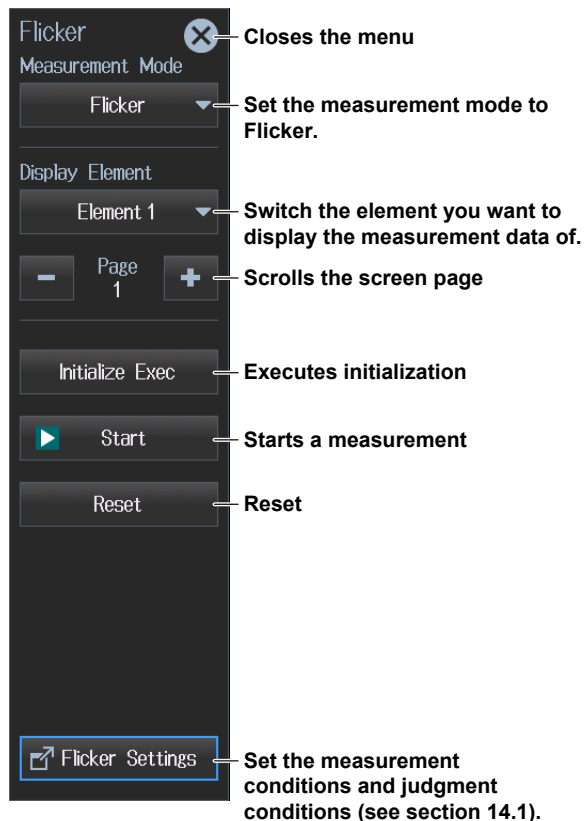

Measurement of dmax caused by manual switching

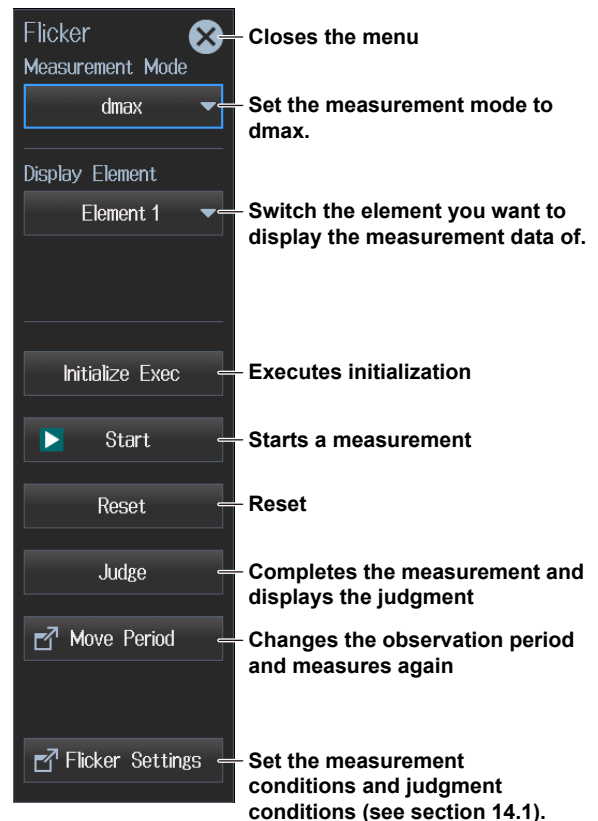

Display Example; Normal Voltage Fluctuation/Flicker Measurement (Measurement mode: Flicker)

Display during Measurement

Number of the element whose measured data is displayed **Flicker measurement status: Start** **Total elapsed measurement time**

Update 1902 **IEC61000-4-15 Ed2.0**
Flicker Start 1:03:24 **IEC61000-3-3 Ed3.0**

Edition number of the standard

Count: 6/12
 Interval: 3m24s/10m00s

Number and bar graph of the observation periods that have completed measurements

Elapsed time and bar graph within one observation period

Element 1
 Volt Range: 100V (120V/50Hz)
 Un1: 102.798 V
 FreqU1: 49.973 Hz

Element 1 Judgement: ---
 Total Judgement: ---
 (Element 1)

“d(t)” is displayed here when the IEC 61000-4-15 edition number is set to Edition 1.1 or the IEC 61000-3-3 edition number is set to Edition 2.0.

	dc[%]	dmax[%]	Tmax[ms]	Pst	Plt
Limit	3.30	4.00	500 3.30(%)	1.00	0.65 N:12
No. 1	0.48 ✓Pass	0.69 ✓Pass	0 ✓Pass	0.37 ✓Pass	
2	0.60 ✓Pass	0.64 ✓Pass	0 ✓Pass	0.25 ✓Pass	
3	0.62 ✓Pass	0.68 ✓Pass	0 ✓Pass	0.28 ✓Pass	
4	0.46 ✓Pass	0.54 ✓Pass	0 ✓Pass	0.22 ✓Pass	
5	0.62 ✓Pass	0.64 ✓Pass	0 ✓Pass	0.27 ✓Pass	
6	0.08 ✓Pass	0.52 ✓Pass	0 ✓Pass	0.15 ✓Pass	
7*	0.51	0.58	0		
8					
9					
10					
11					
12					
Result					

Limit value
 For items whose judgment is set to OFF, <OFF> is displayed to the right of the limit value.

Observation periods that have completed measurements

- The last dc, dmax, and Tmax values are compared to their limit values, and the judgments (Pass/Fail) are displayed to the right of the last values.
- Short-term flicker value Pst is calculated and compared to its limit value, and the judgment (Pass/Fail) is displayed.

Observation period in measurement

- An asterisk is displayed to the right of No., and dc, dmax, and Tmax (or d(t)) of that row display the maximum values within the observation period. The values are updated when the instantaneous values at every 2 seconds exceeds the maximum values up to that point.
- The judgments of items whose judgment is set to OFF will be blank.

Judge Display When the Measurement Is Complete

Flicker measurement status: Complete

Update 3600 **IEC61000-4-15 Ed2.0**
Flicker Cmpl 2:00:00 **IEC61000-3-3 Ed3.0**

Count: 12/12
 Interval: 10m00s/10m00s

Element 1
 Volt Range: 100V (120V/50Hz)
 Un1: 102.798 V
 FreqU1: 49.973 Hz

Element 1 Judgement: ✓Pass
 Total Judgement: ✓Pass
 (Element 1)

	dc[%]	dmax[%]	Tmax[ms]	Pst	Plt
Limit	3.30	4.00	500 3.30(%)	1.00	0.65 N:12
No. 1	0.48 ✓Pass	0.69 ✓Pass	0 ✓Pass	0.37 ✓Pass	
2	0.60 ✓Pass	0.64 ✓Pass	0 ✓Pass	0.25 ✓Pass	
3	0.62 ✓Pass	0.68 ✓Pass	0 ✓Pass	0.28 ✓Pass	
4	0.46 ✓Pass	0.54 ✓Pass	0 ✓Pass	0.22 ✓Pass	
5	0.62 ✓Pass	0.64 ✓Pass	0 ✓Pass	0.27 ✓Pass	
6	0.08 ✓Pass	0.52 ✓Pass	0 ✓Pass	0.15 ✓Pass	
7	0.56 ✓Pass	0.60 ✓Pass	0 ✓Pass	0.26 ✓Pass	
8	0.68 ✓Pass	0.70 ✓Pass	0 ✓Pass	0.24 ✓Pass	
9	0.32 ✓Pass	0.45 ✓Pass	0 ✓Pass	0.20 ✓Pass	
10	0.42 ✓Pass	0.60 ✓Pass	0 ✓Pass	0.21 ✓Pass	
11	0.54 ✓Pass	0.62 ✓Pass	0 ✓Pass	0.32 ✓Pass	
12	0.51 ✓Pass	0.64 ✓Pass	0 ✓Pass	0.32 ✓Pass	
Result	✓Pass	✓Pass	✓Pass	✓Pass	0.27 ✓Pass

Element judgment
 For elements whose measured data is displayed, the judgment is Pass if the judgments of all items whose judgment is set to ON are Pass; otherwise it is Fail.

Total judgment
 The judgment is Pass if the judgments of all elements under measurement are Pass; otherwise it is Fail.

Element under measurement

Long-term flicker value Plt is compared to its limit value, and the judgment (Pass/Fail) is displayed.

For dc, dmax, Tmax (or d(t)), and Pst, the judgment is Pass if the judgments of all observation periods are Pass; otherwise it is Fail.

Display Example; Measurement of dmax Caused by Manual Switching (Measurement mode: dmax)

Display during Measurement

Number of the element whose measured data is displayed Flicker measurement status: Start

Total elapsed measurement time: 0:16:52

Edition number of the standard: IEC61000-4-15 Ed2.0, IEC61000-3-3 Ed3.0

Count: 16/24
Interval: 0m52s/1m00s

Element: 1
Volt Range: 100V (120V/50Hz)
Un1: 102.432 V
FreqU1: 50.041 Hz

Element 1 Judgement: ----
Total Judgement: ----
(Element 1)

No.	dmax[%]	No.	dmax[%]
1	0.00	13	0.00
2	0.64	14	0.30
3	0.59	15	0.00
4	0.03	16	0.06
5	0.00	17*	0.51
6	0.07	18	-----
7	0.00	19	-----
8	0.32	20	-----
9	0.99	21	-----
10	0.48	22	-----
11	0.13	23	-----
12	0.00	24	-----

Limit: 4.00
Result (Average dmax): 0.19

Number and bar graph of the observation periods that have completed measurements
Elapsed time and bar graph within one observation period
Observation periods that have completed measurements
For the dmax values in the observation periods up to this point, "max" and "min" are displayed to the right of the maximum and minimum dmax values.
Observation period in measurement
An asterisk is displayed to the right of No., and dmax of that row displays the maximum value within the observation period. The values are updated when the instantaneous values at every 2 seconds exceeds the maximum values up to that point.
Limit value

Judge Display When the Measurement Is Complete

Flicker measurement status: Complete

Total elapsed measurement time: 0:24:00

Edition number of the standard: IEC61000-4-15 Ed2.0, IEC61000-3-3 Ed3.0

Count: 24/24
Interval: 1m00s/1m00s

Element: 1
Volt Range: 100V (120V/50Hz)
Un1: 102.432 V
FreqU1: 50.041 Hz

Element 1 Judgement: **Pass**
Total Judgement: **Pass**
(Element 1)

No.	dmax[%]	No.	dmax[%]
1	0.00	13	0.00
2	0.64	14	0.30
3	0.59	15	0.00
4	0.03	16	0.06
5	0.00	17	0.51
6	0.07	18	0.57
7	0.00	19	0.10
8	0.32	20	0.54
9	0.99	21	0.00
10	0.48	22	0.12
11	0.13	23	0.00
12	0.00	24	0.10

Limit: 4.00
Result (Average dmax): 0.21 **Pass**

Element judgment
For elements whose measured data is displayed, the judgment result of the average dmax value is displayed.
Total judgment
The judgment is Pass if the judgments of all elements under measurement are Pass; otherwise it is Fail.
Element under measurement
Judgment of the average dmax value
Of the 24 dmax values, the average of 22 data values, which excludes the maximum (max) and minimum (min) values, is displayed. The value is compared to its limit value, and the judgment (Pass/Fail) is displayed.

15.1 Connecting the Instrument to a Network

This section explains how to connect the instrument to a network.

Ethernet Interface Specifications

There is a 1000BASE-T port located on the rear panel of this instrument.

Item	Specifications
Ports	1
Electrical and mechanical specifications	IEEE802.3 compliant, Auto-MDIX
Transmission system	Ethernet(1000BASE-T/100BASE-TX/10BASE-T)
Communication protocol	TCP/IP
Supported services	Server: FTP, remote control (VXI-11, Socket), Modbus/TCP, and Web Client: DHCP, DNS, SNTP, FTP (Net Drive)
Connector type	RJ-45 connector

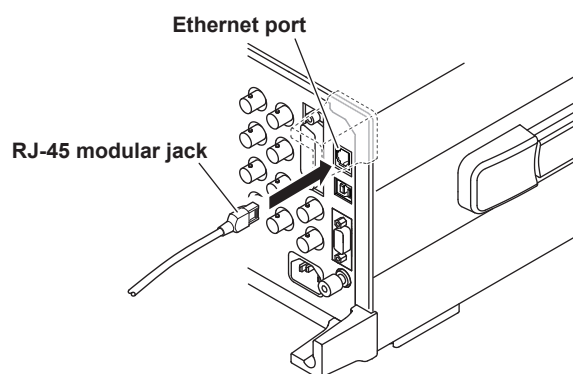

Items Required to Connect the Instrument to a Network

Cable

Use an STP (Shielded Twisted-Pair) cable that is compatible with your network environment (transmission speed).

Connection Procedure

To Connect to a PC over a Network

1. Turn off the instrument.
2. Connect one end of an STP cable to the ETHERNET 1000BASE-T port on the rear panel.
3. Connect the other end of the STP cable to a hub or router.
4. Turn on the instrument.

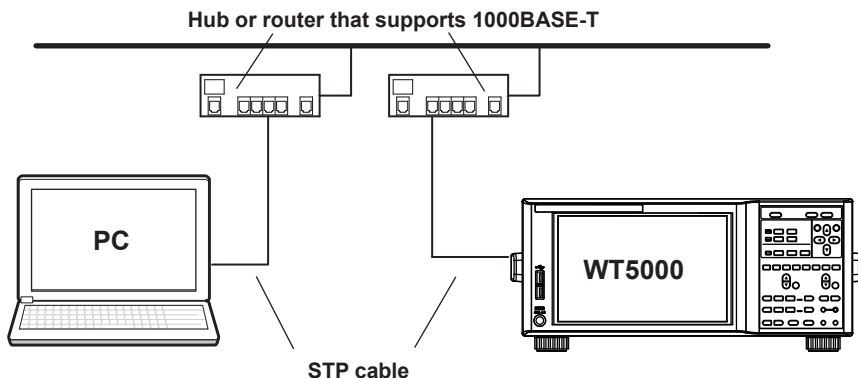

To Connect to a PC through a Hub or Router

1. Turn off the instrument and the PC.
2. Connect one end of an STP cable to the ETHERNET 1000BASE-T port on the rear panel.
3. Connect the other end of the STP cable to a hub or router.
4. Connect the PC to the hub or router in the same way.
5. Turn on the instrument.

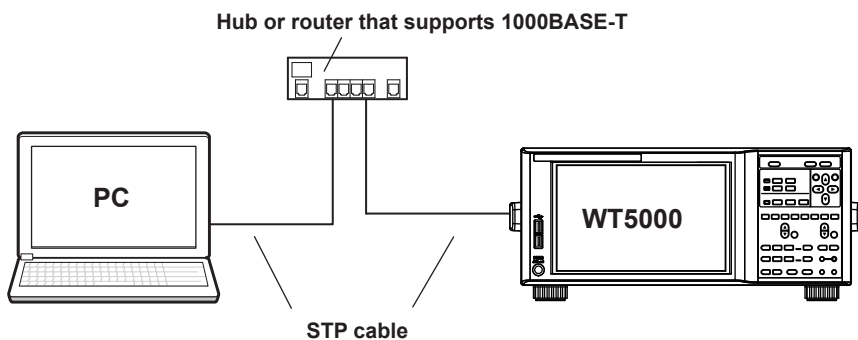

Note

- Use a hub or router that conforms to the transfer speed of your network.
 - When you connect a PC to the instrument through a hub or router, the PC must be equipped with an auto switching 1000BASE-T/100BASE-TX/10BASE-T network card.
 - Do not connect the instrument to a PC directly. Direct communication without a hub or router is not guaranteed to work.
-

15.2 Configuring the TCP/IP Settings

► “TCP/IP (TCP/IP)” in the features guide

This section explains operating procedures using the following setup methods.

- Procedure Using the Setup Menu (see chapter 1)
- Procedure Using the Keys (other than SETUP) (see section 1.2 in IM WT5000-03EN)

Procedure Using the Setup Menu

1. Tap the **Setup** icon , or press **MENU** under SETUP.
2. Tap the **Utility** tab. The utility settings overview screen appears.
Pressing **ESC** closes the overview screen.
3. Tap **Network**. An Ethernet setup screen (TCP/IP, FTP/Web Server, Net Drive, SNTP) appears.

Configuring the TCP/IP Settings (TCP/IP)

4. Tap **TCP/IP**. A TCP/IP screen appears.

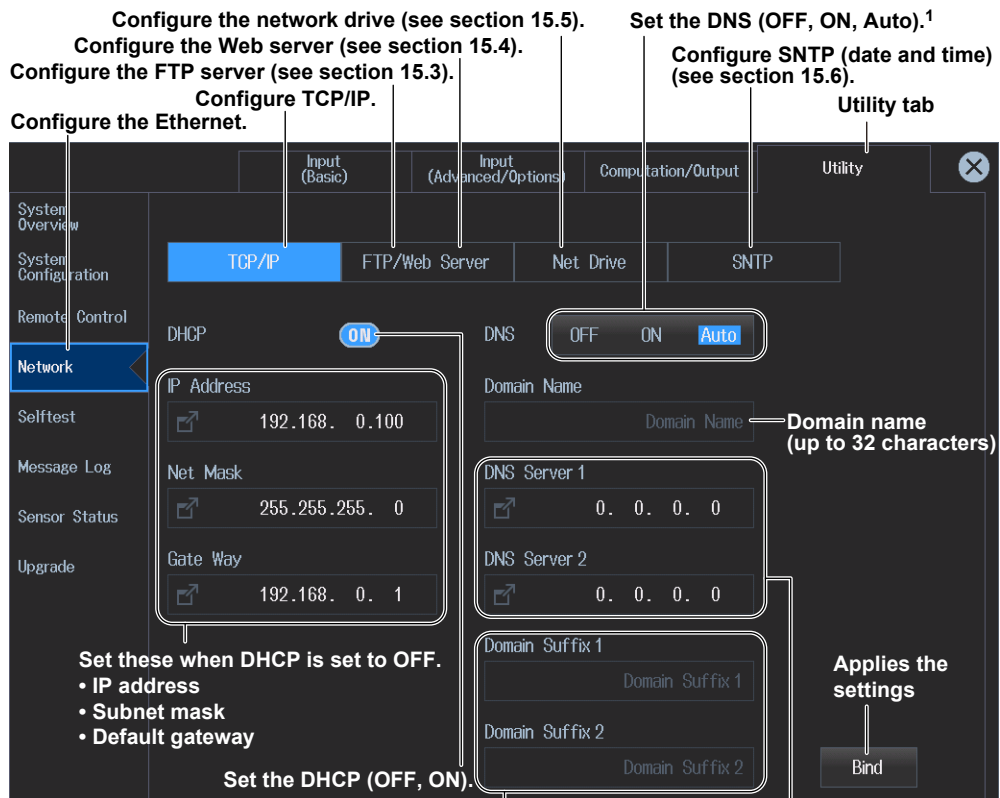

Domain suffix
(Suffix 1: primary, Suffix 2: secondary)

DNS server IP address
(Server 1: primary, Server 2: secondary)

1 Configure DNS.

- OFF: DNS is disabled.
- ON: DNS is enabled.
Set the domain name, and the DNS server's primary and secondary IP addresses and domain suffixes.
- Auto: DNS is enabled.
Set the domain suffix. The domain name and the DNS server IP addresses are set automatically.
The Auto option is only displayed when DHCP is set to ON.

15.2 Configuring the TCP/IP Settings

Note

You can also display the utility settings overview screen by moving the cursor on the Utility tab using the arrow keys and then pressing SET.

Procedure Using Keys

You can also use the front panel keys to configure Ethernet communication.

Configure Ethernet communication.

The Utility menu appears.

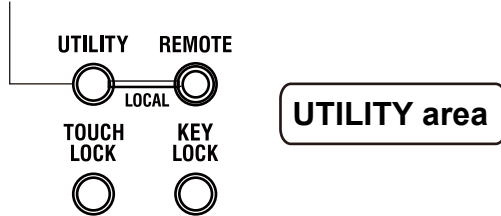

15.3 Accessing the Instrument from a PC (FTP Server)

► “FTP Server (FTP/Web Server)” in the features guide

This section explains operating procedures using the following setup methods.

- Procedure Using the Setup Menu (see chapter 1)
- Procedure Using the Keys (other than SETUP) (see section 1.2 in IM WT5000-03EN)

Procedure Using the Setup Menu

1. Tap the **Setup** icon , or press **MENU** under SETUP.
2. Tap the **Utility** tab. The utility settings overview screen appears.
Pressing **ESC** closes the overview screen.
3. Tap **Network**. An Ethernet setup screen (TCP/IP, FTP/Web Server, Net Drive, SNTIP) appears.

Configuring the FTP Server (FTP Server)

4. Tap **FTP/Web Server**. An FTP/Web Server screen appears.

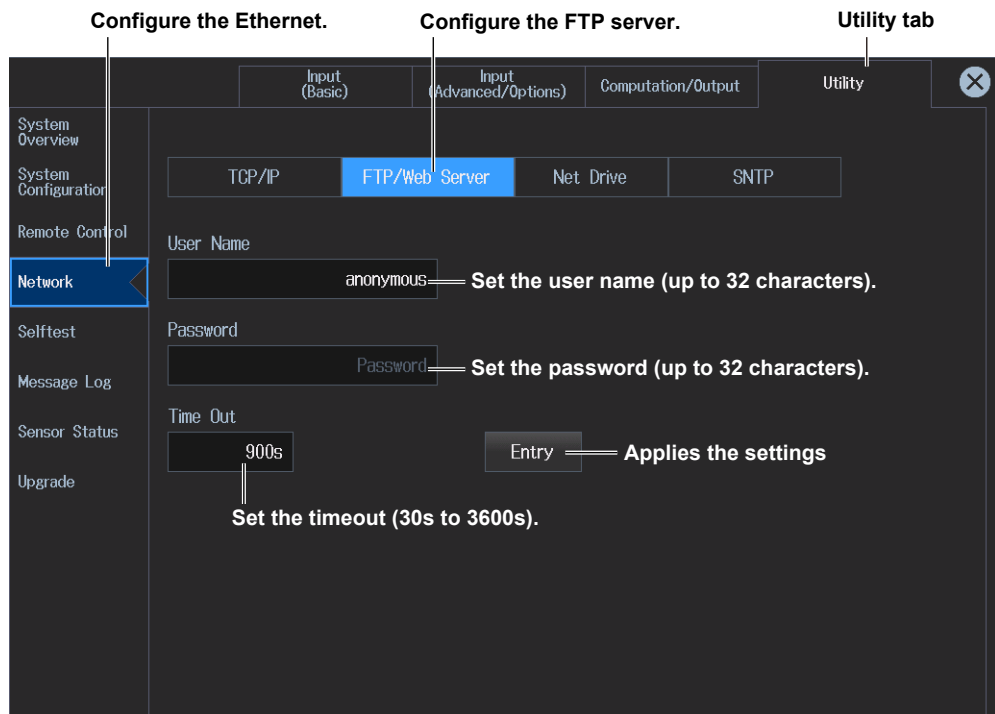

Note

- If you set the user name to “anonymous,” you can connect to the instrument without entering a password.
- You can also display the utility settings overview screen by moving the cursor on the Utility tab using the arrow keys and then pressing SET.

FTP Client Software

Start an FTP client on a PC.

Enter the user name and password that you entered on the screen shown above to connect to the instrument.

Procedure Using Keys

See section 15.2.

15.4 Web Server Feature

► “Web Server (FTP/Web Server)” in the features guide

This section explains operating procedures using the following setup methods.

- Procedure Using the Setup Menu (see chapter 1)
- Procedure Using the Keys (other than SETUP) (see section 1.2 in IM WT5000-03EN)

Procedure Using the Setup Menu

1. Tap the **Setup** icon  or press **MENU** under SETUP.
2. Tap the **Utility** tab. The utility settings overview screen appears.
Pressing **ESC** closes the overview screen.
3. Tap **Network**. An Ethernet setup screen (TCP/IP, FTP/Web Server, Net Drive, SNTP) appears.

Configuring the Web Server (Web Server)

4. Tap **FTP/Web Server**. An FTP/Web Server screen appears.
Time Out is a setting used by the FTP server feature. You do not have to set it for the Web server feature.

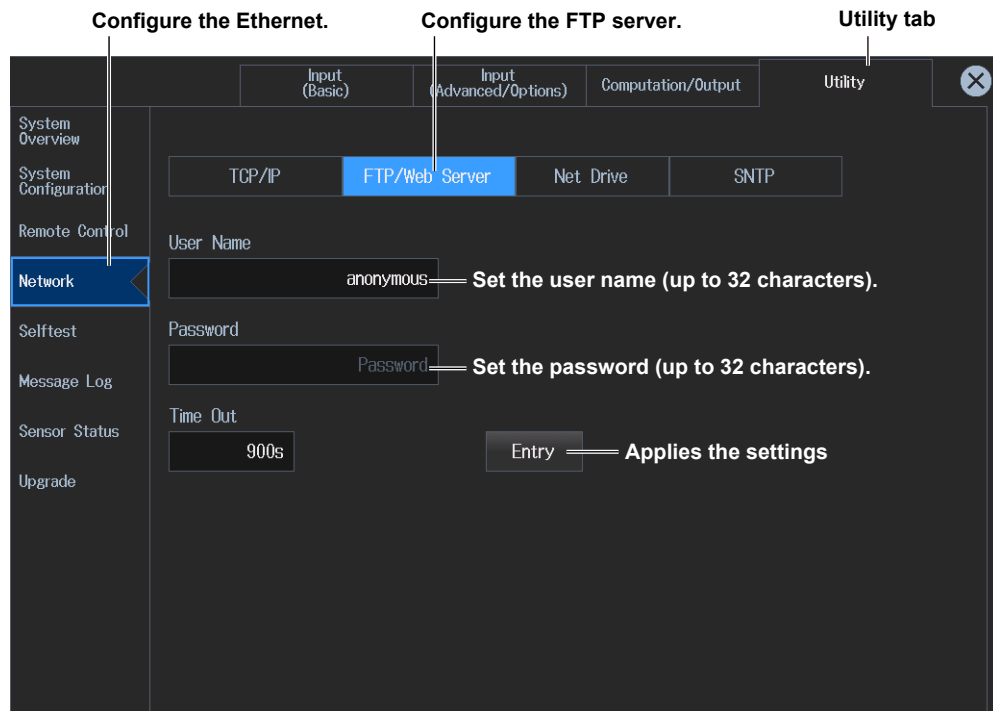

Note

You can also display the utility settings overview screen by moving the cursor on the Utility tab using the arrow keys and then pressing SET.

Procedure Using Keys

See section 15.2.

Operations on the PC

1. Open a Web browser on a PC that is connected to the network.
2. Specify the following address.
http://xxx.xxx.xxx.xxx/
(Type this instrument's IP address for xxx.xxx.xxx.xxx.)
3. Enter the user name and password that you entered on the screen shown on the previous page to connect to the instrument. The instrument's home screen appears.
If you set the user name to "anonymous," you can connect to the instrument without entering a password.
4. Click a side navigation item. The corresponding screen appears.

The instrument's IP address

Side navigation

- Home
- LAN Configuration
- Remote View
- Remote Control
- File download
- Link

Instrument Home

Device Model	WT5000
Manufacturer	Yokogawa Test & Measurement Corporation
Serial Number	11111111
Description	Precision Power Analyzer WT5000
Hostname	192.168.1.100
MAC Address	08:00:27:00:00:00
IP Address	192.168.1.100
Firmware Revision	V1.00
VISA Resource String	TCPIP::192.168.1.100::INSTR

©2018 Yokogawa Test & Measurement Corporation

Note

- Disable the pop-up blocker feature on your Web browser when you want to capture the screen image.
- While using the Web server feature, there may be a delay in response or no response depending on the network environment.

15.5 Connecting to a Network Drive

► “Network Drive (Net Drive)” in the features guide

This section explains operating procedures using the following setup methods.

- Procedure Using the Setup Menu (see chapter 1)
- Procedure Using the Keys (other than SETUP) (see section 1.2 in IM WT5000-03EN)

Procedure Using the Setup Menu

1. Tap the **Setup** icon  or press **MENU** under SETUP.
2. Tap the **Utility** tab. The utility settings overview screen appears.
Pressing **ESC** closes the overview screen.
3. Tap **Network**. An Ethernet setup screen (TCP/IP, FTP/Web Server, Net Drive, SNTP) appears.

Configuring the Network Drive (Net Drive)

4. Tap **Net Drive**. A Net Drive screen appears.

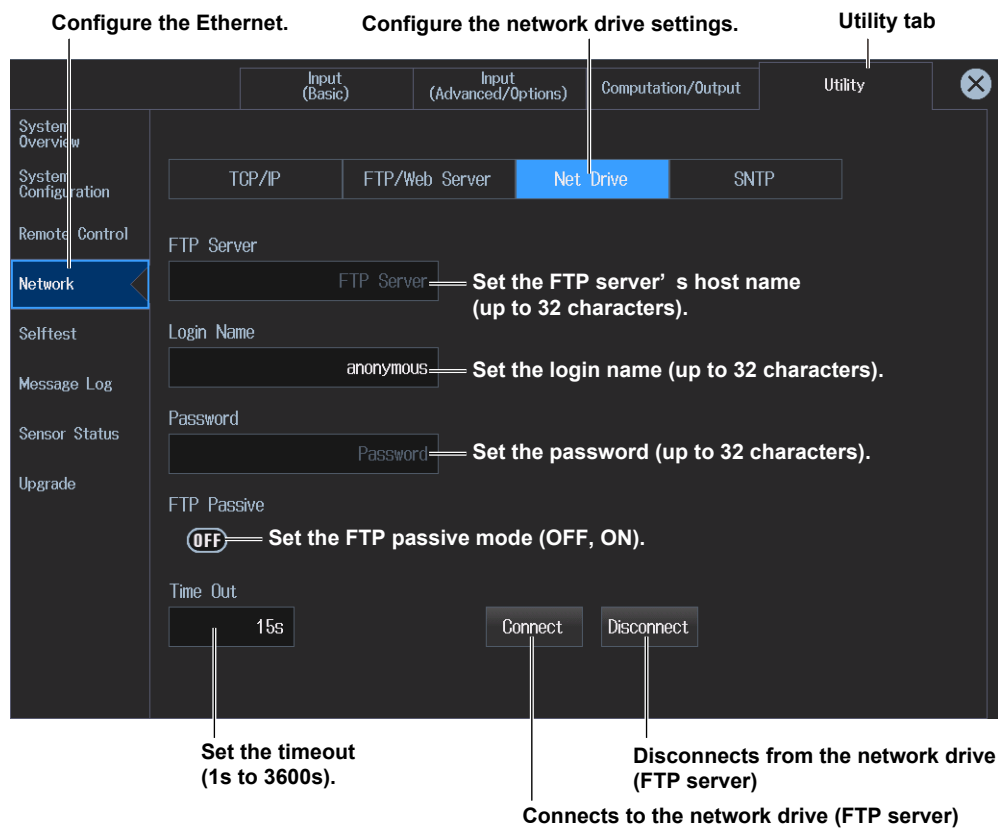

Note

You can also display the utility settings overview screen by moving the cursor on the Utility tab using the arrow keys and then pressing SET.

Procedure Using Keys

See section 15.2.

15.6 Setting the Date and Time via SNTP

► “SNTP (SNTP)” in the features guide

This section explains operating procedures using the following setup methods.

- Procedure Using the Setup Menu (see chapter 1)
- Procedure Using the Keys (other than SETUP) (see section 1.2 in IM WT5000-03EN)

Procedure Using the Setup Menu

1. Tap the **Setup** icon , or press **MENU** under SETUP.
2. Tap the **Utility** tab. The utility settings overview screen appears.
Pressing **ESC** closes the overview screen.
3. Tap **Network**. An Ethernet setup screen (TCP/IP, FTP/Web Server, Net Drive, SNTP) appears.

Configuring the SNTP Settings (SNTP)

4. Tap **SNTP**. An SNTP screen appears.

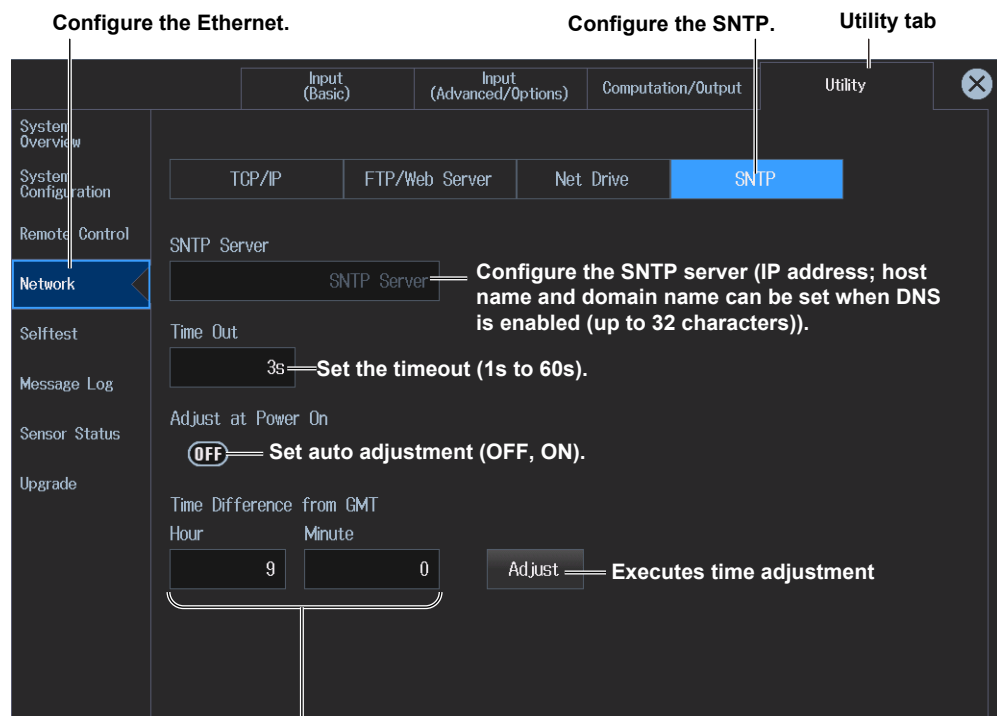

Set the time difference from Greenwich Mean Time
(-12 hours 0 minutes to 13 hours 0 minutes).

Note

You can also display the utility settings overview screen by moving the cursor on the Utility tab using the arrow keys and then pressing SET.

Procedure Using Keys

See section 15.2.

16.1 Remote Control

► “Remote Control (Remote Control)” in the features guide

This section explains operating procedures using the following setup methods.

- Procedure Using the Setup Menu (see chapter 1)
- Procedure Using the Keys (other than SETUP) (see section 1.2 in IM WT5000-03EN)

Procedure Using the Setup Menu

1. Tap the **Setup** icon , or press **MENU** under SETUP.
2. Tap the **Utility** tab. The utility settings overview screen appears.
Pressing **ESC** closes the overview screen.

Remote Control Settings (Remote Control)

3. Tap **Remote Control**. A remote control setup screen (Network(VXI-11/GP-IB/USB(USB-TMC)) appears.

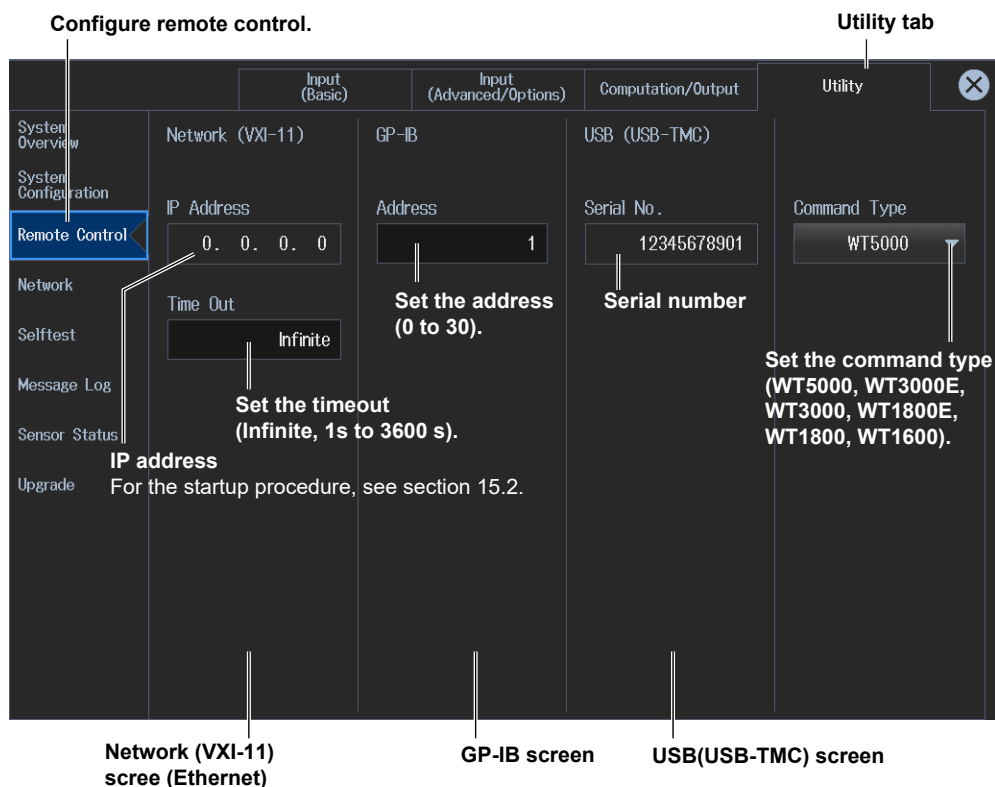

Note

- Only use one communication interface: GP-IB, USB, or Network. If you send commands simultaneously from more than one communication interface, the instrument will not execute the commands properly.
- You can also display the utility settings overview screen by moving the cursor on the Utility tab using the arrow keys and then pressing SET.

16.1 Remote Control

Network (VXI-11)

To use the Ethernet interface, you must specify the following TCP/IP settings.

- IP address
- Subnet mask
- Default gateway

For details on setting these parameters, see section 15.2.

USB Settings

- Install the YOKOGAWA USB driver on your PC. For information about how to obtain the YOKOGAWA USB driver, contact your nearest YOKOGAWA dealer. You can also access the YOKOGAWA USB driver download web page and download the driver.
<https://tmi.yokogawa.com/library/>
- Do not use USB drivers (or software) supplied by other companies.

GP-IB Settings

- When the controller is communicating with the instrument or with other devices through GP-IB, do not change the address.
- Each device that is connected in a GP-IB system has its own unique address. This address is used to distinguish between different devices. Therefore, you must assign a unique address to the instrument when connecting it to a PC or other device.

Command Type

Specify the command type compatible with this instrument or legacy models (WT3000E, WT3000, WT1800E, WT1800, WT1600).

The response to the *IDN? and *OPT? commands will be according to the model of the specified command type.

Procedure Using Keys

You can also press UTILITY on the front panel to display the utility settings overview screen.

The utility settings overview screen appears.

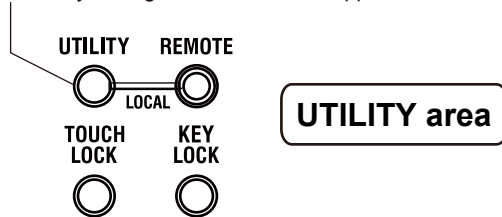

16.2 Configuring the D/A Output (option)

► “D/A Output (D/A Output, option)” in the features guide

This section explains operating procedures using the following setup methods.

- Procedure Using the Setup Menu (see chapter 1)

Procedure Using the Setup Menu

1. Tap the **Setup** icon , or press **MENU** under **SETUP**.
2. Tap **Computation/Output** tab. A computation and output settings overview screen appears. Pressing **ESC** closes the overview screen.

Configuring the D/A Output (D/A Output)

3. Tap **D/A Output**. A DA output setup screen appears.

D/A output signal name

For details on the connector pinout and the D/A output signal assignment, see section 4.5 in the Getting Started Guide, IM WT5000-03EN.

Set the measurement function (None, other functions—for details on the various measurement functions, see “Items That This Instrument Can Measure” in the Features Guide).

Output items

This display changes according to the Function, Element/ Σ , and Order settings.

Switches the channel display group

Ch 1-Ch 5: Displays Ch1 to Ch5,
Ch 6-Ch 10: Displays Ch 6 to Ch 10
Ch 11-Ch 15: Displays Ch11 to Ch15
Ch 16-Ch 20: Displays Ch 16 to Ch 20

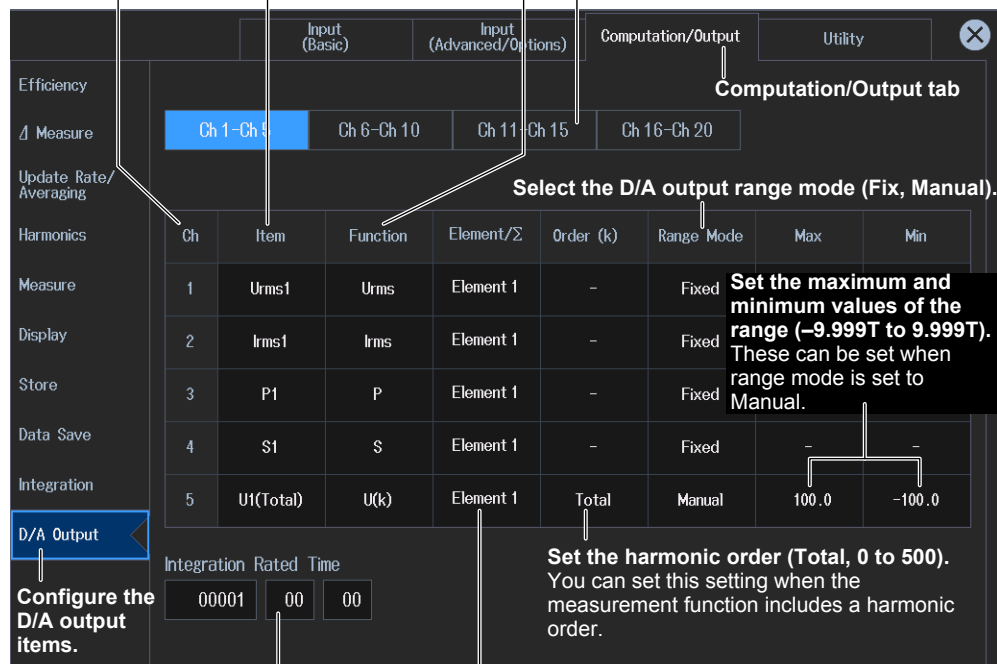

Computation/Output tab

Select the D/A output range mode (Fix, Manual).

Ch	Item	Function	Element/ Σ	Order (k)	Range Mode	Max	Min
1	Urms1	Urms	Element 1	-	Fixed		
2	Irms1	Irms	Element 1	-	Fixed		
3	P1	P	Element 1	-	Fixed		
4	S1	S	Element 1	-	Fixed		
5	U1(Total)	U(k)	Element 1	Total	Manual	100.0	-100.0

Configure the D/A output items.

Integration Rated Time: 00001 00 00

Set the rated time of integrated D/A output (00000 h : 00 min : 00 s to 10000 h : 00 min : 00 s).

Selects the input element or wiring unit to be configured

- Input element options
When the displayed item is set to something other than motor evaluation: Element1 to Element7
When the displayed item is set to motor evaluation: Motor1 to Motor4
- Wiring unit options: Σ A, Σ B, Σ C

Note

You can also display the computation/output settings overview screen by moving the cursor on the Computation/Output tab using the arrow keys and then pressing **SET**.

16.3 Configuring the IEEE 1588 Time Synchronization

► “IEEE 1588 Time Synchronization Feature (IEEE 1588)” in the features guide

This section explains operating procedures using the following setup methods.

- Procedure Using the Setup Menu (see chapter 1)
- Procedure Using the Keys (other than SETUP) (see section 1.2 in IM WT5000-03EN)

Procedure Using the Setup Menu

1. Tap the **Setup** icon  or press **MENU** under SETUP.
2. Tap the **Utility** tab. The utility settings overview screen appears.
Pressing **ESC** closes the overview screen.

Configuring the IEEE 1588 Time Synchronization

3. Tap System Configuration. A system setup (Date/Time, Language, LCD, Preference) appears.

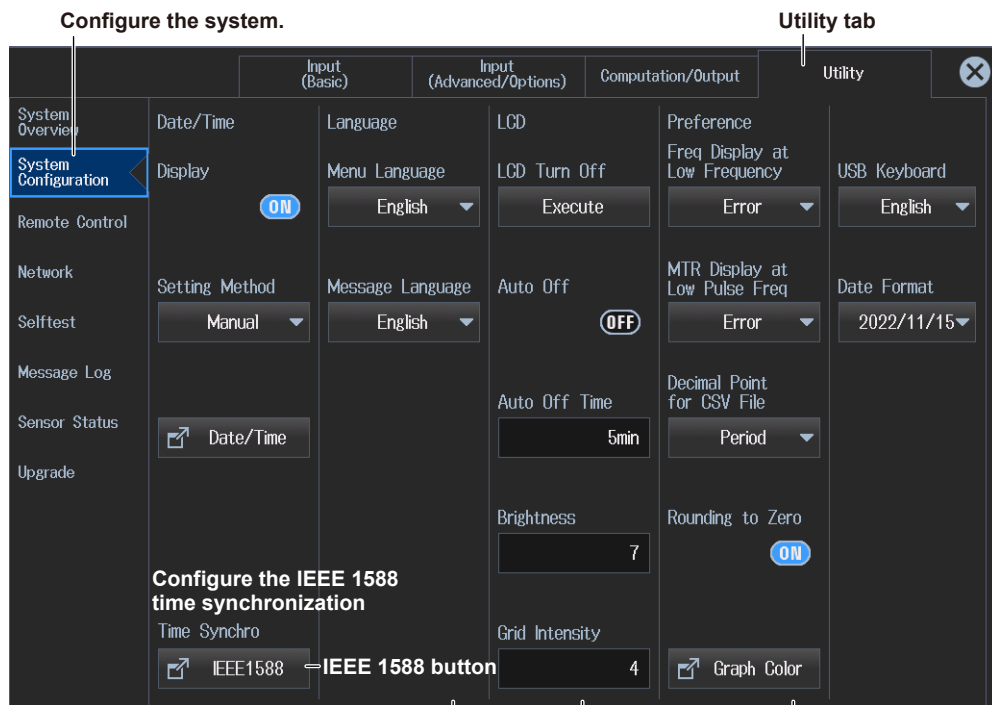

Language screen
(See section 16.4.)

LCD
(See section 16.5.)

Preference screen
(See section 16.6.)

IEEE 1588 Configuration Screen

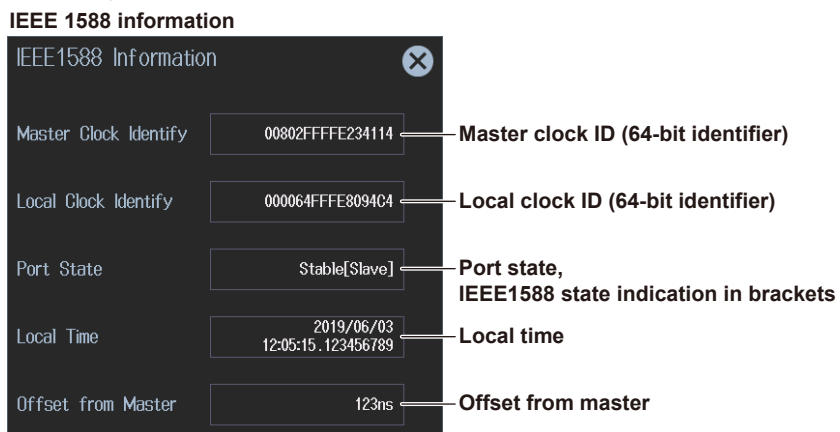
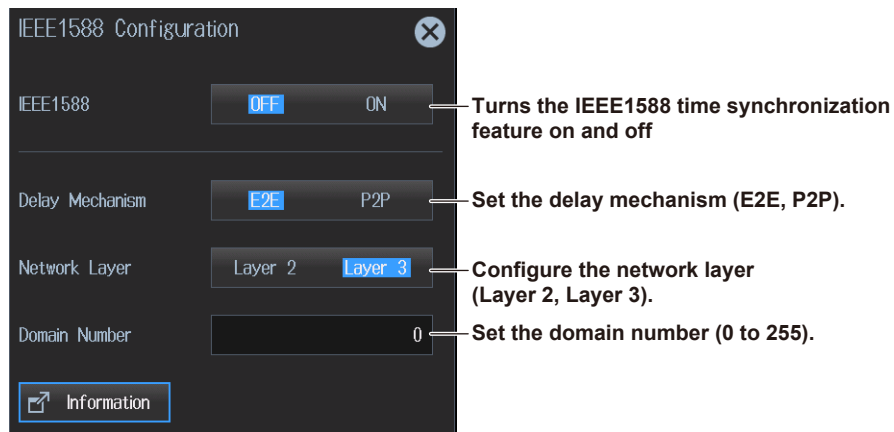

Note

You can also display the utility settings overview screen by moving the cursor on the Utility tab using the arrow keys and then pressing SET.

Procedure Using Keys

See section 16.1.

16.4 Setting the Message, Menu, and USB Keyboard Languages

► “System Configuration (System Configuration)” in the features guide

This section explains operating procedures using the following setup methods.

- Procedure Using the Setup Menu (see chapter 1)
- Procedure Using the Keys (other than SETUP) (see section 1.2 in IM WT5000-03EN)

Procedure Using the Setup Menu

1. Tap the **Setup** icon  or press **MENU** under SETUP.
2. Tap the **Utility** tab. The utility settings overview screen appears.
Pressing **ESC** closes the overview screen.

Setting the Language and USB Keyboard (Language, USB Keyboard)

3. Tap **System Configuration**. A system setup (Date/Time, Language, LCD, Preference) appears.

Configure the system.

Set the menu language.
The available languages vary depending on the suffix code.

Set the USB keyboard language.
The available languages vary depending on the suffix code.

Utility tab

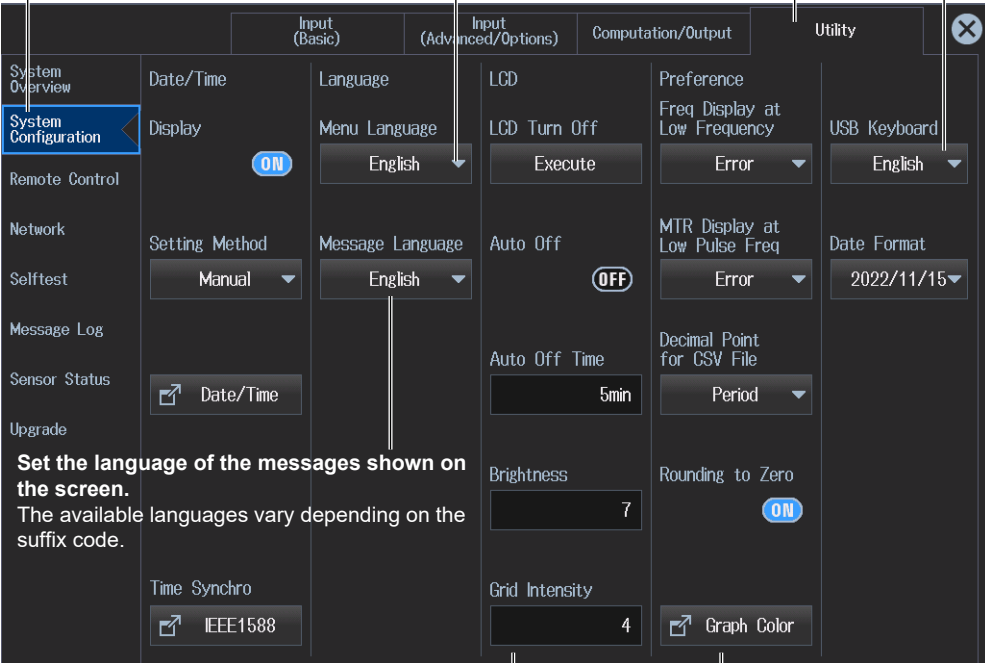

The screenshot shows the 'System Configuration' screen with the following sections and settings:

- System Configuration** (selected)
- Input (Basic)**: Date/Time, Display (ON), Setting Method (Manual), Date/Time, Time Synchro (IEEE1588)
- Input (Advanced/Options)**: Language (Menu Language: English, Message Language: English), LCD (LCD Turn Off: Execute, Auto Off: OFF, Auto Off Time: 5min, Brightness: 7, Grid Intensity: 4)
- Computation/Output**: Preference (Freq Display at Low Frequency: Error, MTR Display at Low Pulse Freq: Error, Decimal Point for CSV File: Period, Rounding to Zero: ON, Graph Color)
- Utility**: USB Keyboard (English), Date Format (2022/11/15)

Set the language of the messages shown on the screen.
The available languages vary depending on the suffix code.

LCD
(See section 16.5.)

Preference screen
(See section 16.6.)

Note

You can also display the utility settings overview screen by moving the cursor on the Utility tab using the arrow keys and then pressing SET.

Procedure Using Keys

See section 16.1.

16.5 Setting the Screen Brightness and Turning the Screen Off

► “LCD (LCD)” in the features guide

This section explains operating procedures using the following setup methods.

- Procedure Using the Setup Menu (see chapter 1)
- Procedure Using the Keys (other than SETUP) (see section 1.2 in IM WT5000-03EN)

Procedure Using the Setup Menu

1. Tap the **Setup** icon , or press **MENU** under **SETUP**.
2. Tap the **Utility** tab. The utility settings overview screen appears.
Pressing **ESC** closes the overview screen.

Setting the Screen Brightness and Turning the Screen Off (LCD)

3. Tap **System Configuration**. A system setup (Date/Time, Language, LCD, Preference) appears.

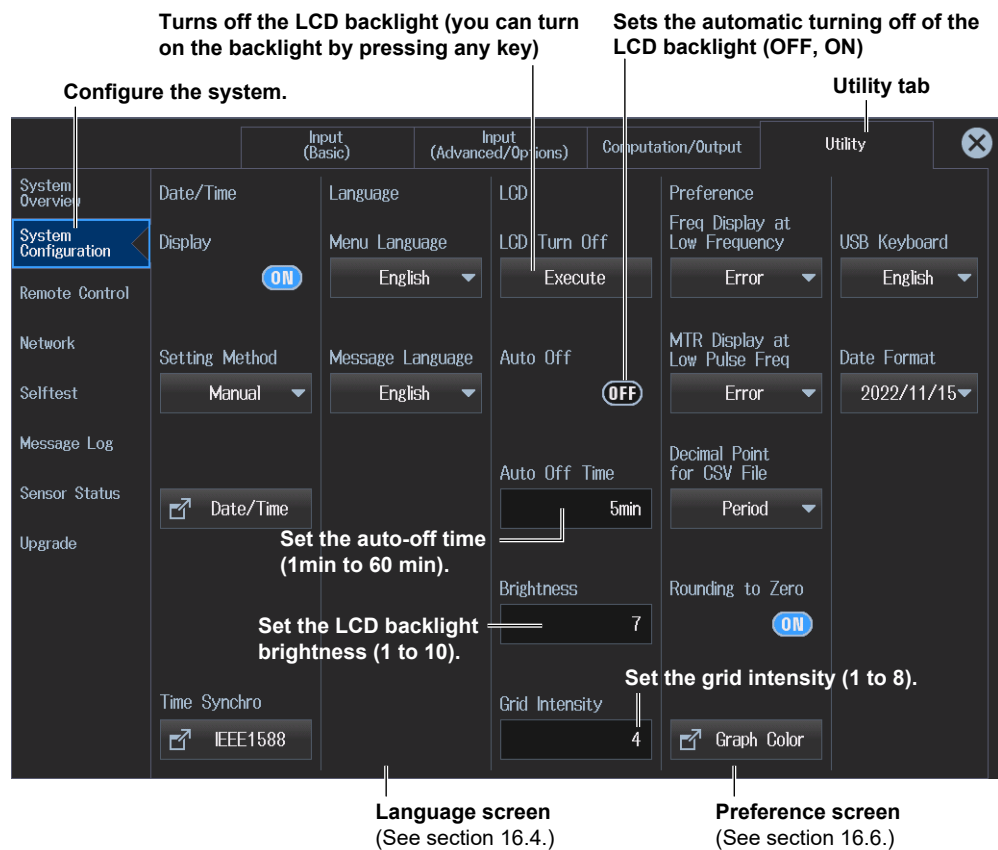

The screenshot shows the 'System Configuration' screen with the following annotations:

- Turns off the LCD backlight (you can turn on the backlight by pressing any key)**: Points to the 'LCD Turn Off' button.
- Sets the automatic turning off of the LCD backlight (OFF, ON)**: Points to the 'Auto Off' toggle switch.
- Configure the system.**: Points to the 'System Configuration' menu item.
- Utility tab**: Points to the 'Utility' tab at the top right.
- Set the auto-off time (1min to 60 min).**: Points to the 'Auto Off Time' input field.
- Set the LCD backlight brightness (1 to 10).**: Points to the 'Brightness' input field.
- Set the grid intensity (1 to 8).**: Points to the 'Grid Intensity' input field.
- Language screen (See section 16.4.)**: Points to the 'Language' section.
- Preference screen (See section 16.6.)**: Points to the 'Preference' section.

Note

You can also display the utility settings overview screen by moving the cursor on the Utility tab using the arrow keys and then pressing SET.

Procedure Using Keys

See section 16.1.

16.6 Environment Settings (Preference)

► “Environment Settings (Preference)” in the features guide

This section explains operating procedures using the following setup methods.

- Procedure Using the Setup Menu (see chapter 1)
- Procedure Using the Keys (other than SETUP) (see section 1.2 in IM WT5000-03EN)

Procedure Using the Setup Menu

1. Tap the **Setup** icon  or press **MENU** under SETUP.
2. Tap the **Utility** tab. The utility settings overview screen appears.
Pressing **ESC** closes the overview screen.

Environment Settings (Preference)

3. Tap **System Configuration**. A system setup (Date/Time, Language, LCD, Preference) appears.

On models with the /MTR option, set the motor display value when the measured pulse frequency is less than the lower limit (0, Error).

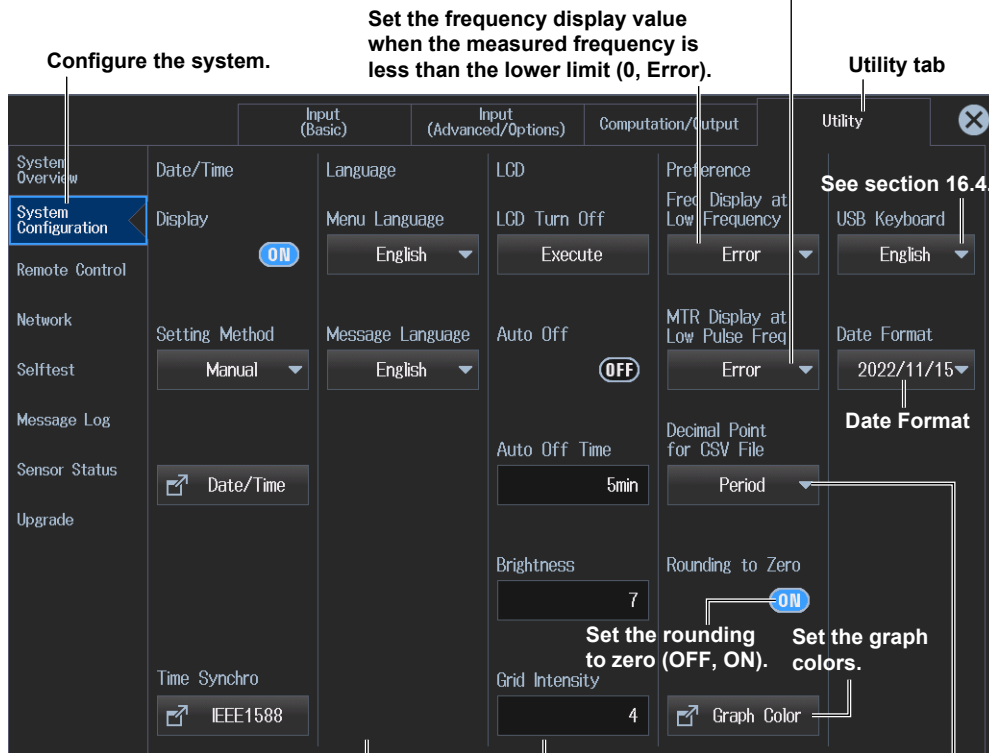

Language screen LCD
(See section 16.4.) (See section 16.5.)

Set the decimal point and separator to use when data is saved in ASCII format as a .CSV file (Period, Comma).

Note

You can also display the utility settings overview screen by moving the cursor on the Utility tab using the arrow keys and then pressing SET.

Setting the Graph Color

3. Tap **System Configuration**. A system setup (Date/Time, Language, LCD, Preference) appears.
4. Tap **Graph Color**. The following window appears.

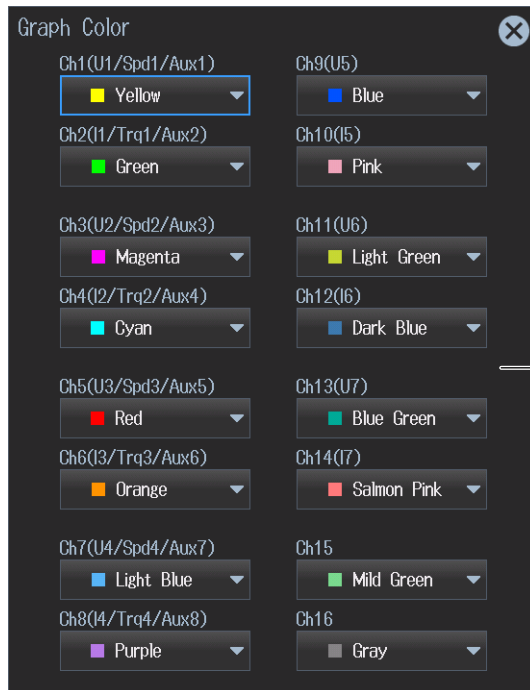

Set the graph colors for Ch1 to Ch16.

Procedure Using Keys

See section 16.1.

Executing the Soft Keyboard Test

4. Tap **Test Item** to select Key Board.
- **Front Panel Key Test**
5. Tap **Test Exec.** A front panel key test and indicator test will be executed.

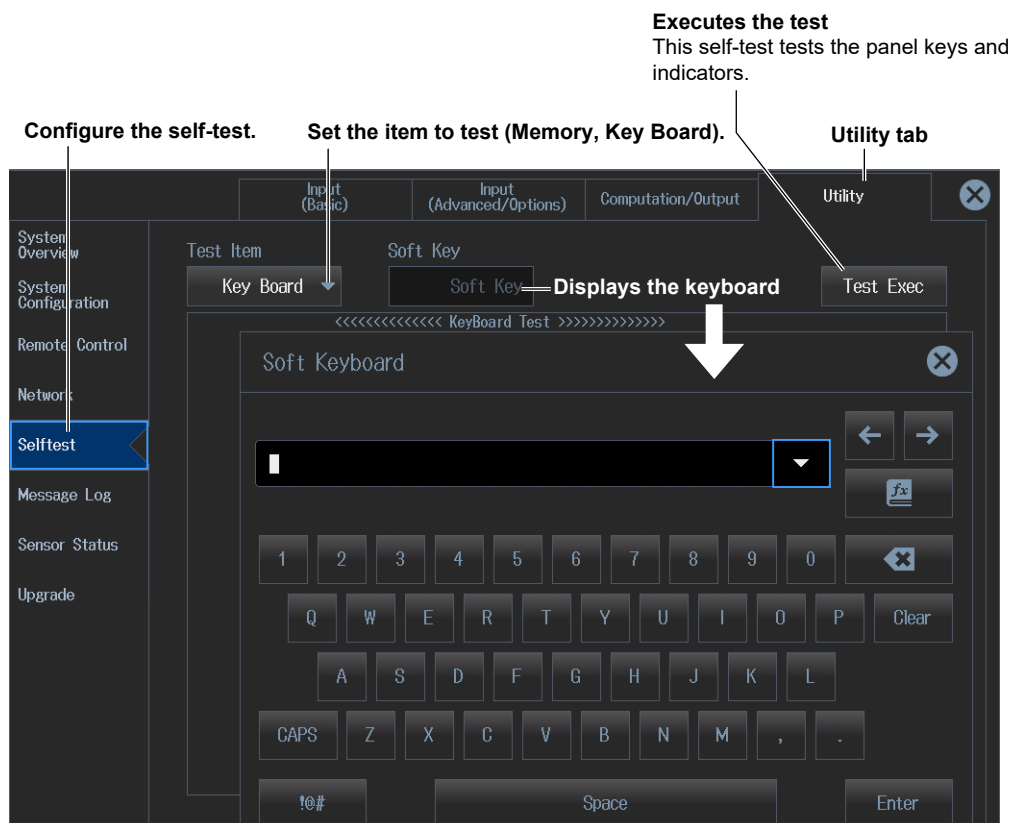

- **Onscreen Soft Keyboard Test**
5. Tap **Soft Key**. A soft keyboard appears.
 6. Tap **Test Exec**. A soft keyboard test will be executed.

Note

You can also display the utility settings overview screen by moving the cursor on the Utility tab using the arrow keys and then pressing SET.

Procedure Using Keys

See section 16.1.

16.8 Displaying and Saving the Message Log

- ▶ “Message Log Display (Message Log)” in the features guide
- ▶ “Saving Message Log Files” in the features guide

This section explains operating procedures using the following setup methods.

- Procedure Using the Setup Menu (see chapter 1)
- Procedure Using the Keys (other than SETUP) (see section 1.2 in IM WT5000-03EN)

Procedure Using the Setup Menu

1. Tap the **Setup** icon  or press **MENU** under SETUP.
2. Tap the **Utility** tab. The utility settings overview screen appears.
Pressing **ESC** closes the overview screen.

Message Log Display (Message Log)

3. Tap **Message Log**. A list is displayed containing all the messages that were indicated on the screen since the instrument was started.

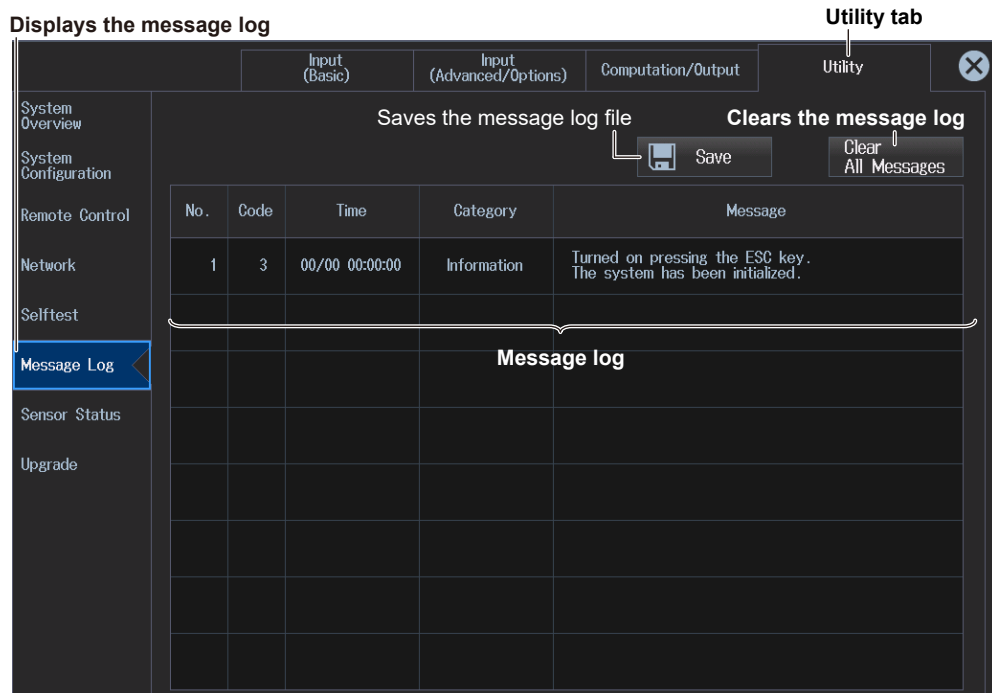

You can also tap the message log indicator in the upper left of the screen to display the list of messages.

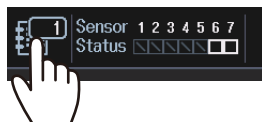

Note

You can also display the utility settings overview screen by moving the cursor on the Utility tab using the arrow keys and then pressing SET.

Saving Message Log Files (Save)

4. Tap **Save**. The message log will be saved.



Note

- The save destination is fixed to the root directory of the internal Memory (User). You cannot change the save destination.
 - File names are automatically generated ("MSGLOG" + date and time). The extension is .CSV.
 - Message logs cannot be saved in the following cases.
 - While a file is being accessed
 - When the storage state is other than Reset or Complete
 - When the flicker measurement state is other than Reset
 - For details on saved contents, see ["Saving Message Log Files \(Save\)" in the Features Guide](#).
-

Procedure Using Keys

See section 16.1.

16.9 Viewing the Instrument Information and Current Sensor Status

- ▶ “Instrument Information (System Overview)” in the features guide
- ▶ “Current Sensor Status Display (Sensor Status)” in the features guide

This section explains operating procedures using the following setup methods.

- Procedure Using the Setup Menu (see chapter 1)
- Procedure Using the Keys (other than SETUP) (see section 1.2 in IM WT5000-03EN)

Procedure Using the Setup Menu

1. Tap the **Setup** icon  or press **MENU** under SETUP.
2. Tap the **Utility** tab. The utility settings overview screen appears.
Pressing **ESC** closes the overview screen.

Viewing the Instrument Information (System Overview)

3. Tap **System Overview**. A instrument information overview appears.

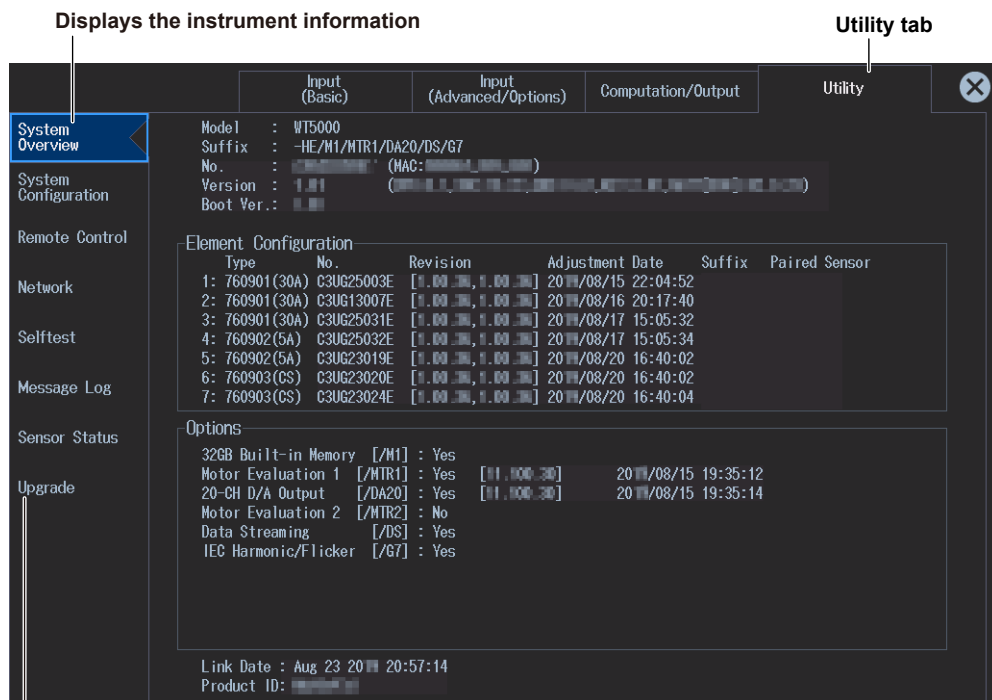

Upgrade

A screen appears for upgrading the instrument firmware and adding options. For the procedure, see the manual provided when upgrading the firmware or adding options.

Displayed Information

Model	The model number
Suffix	The suffix code
No.	The instrument number and MAC address
Version	The firmware version
Boot Ver.	The boot program version
Element Configuration	The input element types
Options	The options
Link Date	The date and time that the firmware was created
Product ID	A unique number assigned to each instrument

Current Sensor Status Display (Sensor Status)

3. Tap **Sensor Status**. The current sensor statuses are listed.

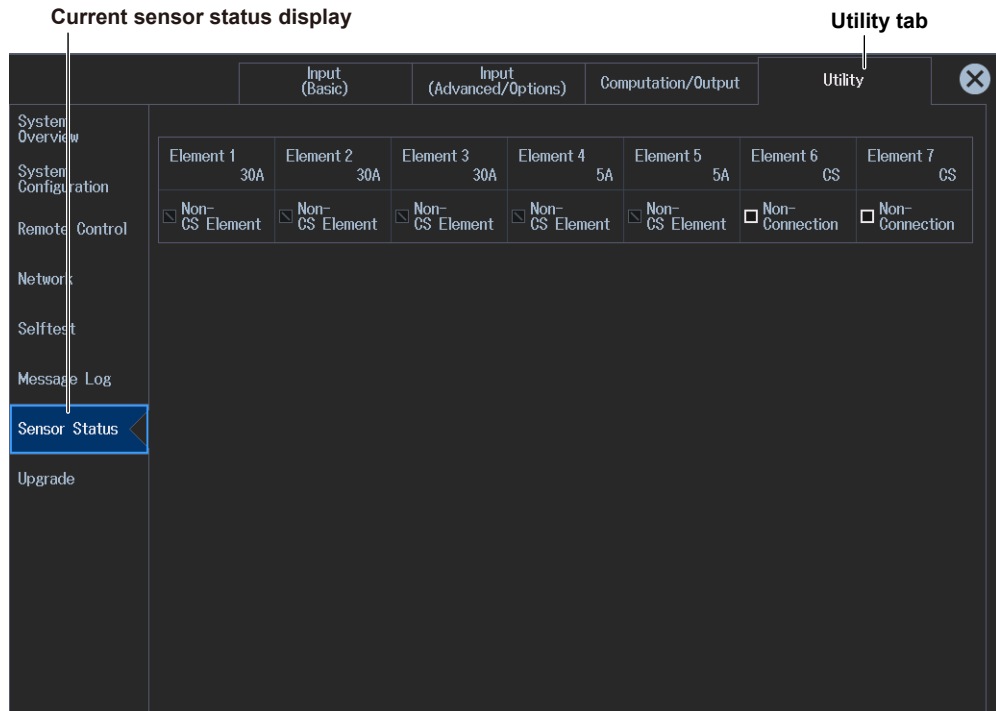

You can also tap the sensor status indicator in the upper left of the screen to display the list of current sensor statuses.

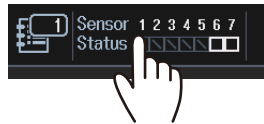

Note

You can also display the utility settings overview screen by moving the cursor on the Utility tab using the arrow keys and then pressing SET.

Procedure Using Keys

See section 16.1.

16.10 Locking the Touch Panel and Front Panel Operations

You can lock the operation of the instrument to prevent affecting the measurement operation as a result of accidentally tapping the touch panel or pressing the front panel keys.

UTILITY REMOTE



LOCAL

UTILITY area

TOUCH
LOCK

KEY
LOCK



Locks the front panel key operation

Press this key to lock the keys on the front panel. The key illuminates.
Press the key again to clear that state.

Locks the touch panel operation

Press this key to lock touch panel. The key illuminates.
Press the key again to clear that state.

Note

In remote mode (REMOTE LED lit), the front panel nor the touch panel can be used. To release remote mode, press UTILITY. For details on remote mode, see the communication interface user's manual, IM WT5000-17EN.

Appendix 1 Messages and Corrective Actions

Messages

Messages may appear on the screen while you are using this instrument. This section describes the error messages and how to respond to them. You can display the messages in the language that you specify through the operations explained in section 16.4. If servicing is necessary to solve the problem indicated by a message, contact your nearest YOKOGAWA dealer.

In addition to the following error messages, there are also communications error messages. These messages are explained in the communication interface user's manual, IM WT5000-17EN.

Warning Messages (1 to 99)

Code	Message	Chapter or Section
3	Turned on pressing the ESC key. The system has been initialized.	3.7 ¹
11	Cannot measure PLL frequency. Check input level.	5.1
12	File access slow. Too many files in directory or medium read/write speed slow.	8.6
64	File access is aborted.	—
80	System Configuration was changed. The system has been initialized.	—
81	Input element configuration was changed. The system has been initialized.	—
84	Key lock is enabled. To release the lock, press the KEY LOCK key.	1.2 ¹
85	In remote control mode, all keys are locked except LOCAL (UTILITY) key. Please hit LOCAL (UTILITY) key to exit the remote control mode.	Chapters 1 to 3 ²
86	In Local Lockout mode, all keys are locked. Please cancel the local lockout.	Chapters 1 to 3 ²
87	Firmware was changed. The system has been initialized.	—
88	Integration has started and measurement ranges are switched to fixed ranges.	2.2, 2.3
89	Processing system settings change. Please wait for a moment.	—
93	This model has neither motor evaluation function or auxiliary input. Check the specifications to see whether or not the optional motor evaluation function and the optional auxiliary input are provided.	16.9
95	Null setting is OFF. When using the current sensor, please enable the null settings.	11.1
96	If the S or Q computation is set to type 1 or 2, the following is applied to elements with the rectifier set to on. - Φ is fixed to lag (G). Displayed in the range of 0 to 180° (360 degrees format). - The sign of Q is fixed to positive. For Q Σ that includes elements with the rectifier set to on, type 2 is used.	Appendix 1 ¹ , 1.2

¹ Getting Started Guide, IM WT5000-03EN

² Communication Interface User's Manual, IM WT5000-17EN

Setup Error Messages (500 to 899)

Code	Message	Chapter or Section
600	File access failure.	—
601	Invalid file name. Check the file name.	8.2
602, 603	No USB device or no storage media inserted. Check the USB device connection, and the existence of a storage medium in the drive.	8.1
604	Media failure. Check the storage medium.	8.1
605	File not found. Check the filename and the storage medium.	—
606	Media is protected. Set the disk's(media's) write protect switch to OFF.	—
607	Media was removed while accessing. Check the storage medium.	8.1
608, 609	File already exists.	—
610	Contains invalid characters.	8.2
611, 612	Media full. Delete unnecessary file(s) or use another disk.	8.6
613	Cannot delete a directory if there are files in the directory.	8.6
614	File is protected.	—
615	Physical format error. Reformat the medium. If the same error occurs, the instrument is probably unable to execute a format on this medium.	—
616 to 620, 622 to 641	File system failure. Check using another disk. If the same message still appears, maintenance service is required.	—
621	File is damaged. Check the file.	—
643 to 653, 659, 660	Media failure. Check the medium.	—
656	Cannot save more than 256 item to the root directory. Change save destination or delete files/directories from the root directory.	8.2
662	File operation is interrupted.	—
663	File unknown format. Check the file format.	1.5
665	Cannot load this file format. File was stored on other models or other versions.	—
666	File is now being accessed. Execute after access is made.	—
668	Cannot load this bitmap file. Use file of 16bit Color or 24bit Color Mode with less or equal size 1000x720.	3.7
669	Cannot load this text file. Confirm the contents of file.	1.5
670	The image file was not saved because the original bitmap file cannot be found. Only the text file has been successfully saved. To properly execute image save, place the original image file in the original drive and folder.	3.7
675	Cannot load this file. Model/options do not conform.	—
676	Writing prohibited in this file.	—
677	An error occurred while network access. Confirm network conditions.	Chapter 15
690	Cannot execute for the directory depth is 10 or more.	—
691	Cannot execute because of source and destination are over lapped.	—
692	Cannot execute for the media itself.	—
693	Cannot store at Network Drive.	7.3
694	Trigger Event is Off.	3.5
695	File version is new. Update firmware.	—
696	The file may be damaged or an unsuccessful file close could have occurred.	—
697	Abnormal data file. Unsuccessful finish of file save is detected.	—
705	Can not operate while accessing medium. Wait until access has completed.	—

Appendix 1 Messages and Corrective Actions

Code	Message	Chapter or Section
706	Can not operate during hard copy. Wait until output has completed.	—
713	Cannot execute for All or User display mode.	—
714	Cannot execute for All display mode.	—
720	Over Run had occurred.	—
721	Can not set or execute because store is processing. Try Again.	—
722	No target Element for integration execution.	4.1
723	Can not set or execute when Integ Independent Control is on.	4.1
724	Can not set or execute because recording is processing. Try again.	—
725	File creation stopped. File size exceeded 2G bytes.	—
726	Cannot start integration. In order to start, set Time/div for wave bigger than 0.01 ms.	6.2
727	Integration cannot be started when the line filter is a Bessel filter and the cutoff frequency f is 100kHz<f<1MHz. To start integration, change the filter type to Butterworth or set the cutoff frequency to less than or equal to 100kHz or to 1MHz.	2.7
750, 751	Unable to connect to the server. Check the network settings and configuration.	Chapter 15
752	This ftp function in not supported.	—
753	FTP Error: Client Handle Confirm the network settings and connection.	Chapter 15
758	Failed to acquire time from SNTP server. Confirm the network settings and connection.	15.6
759	Failed to initialize network. Confirm the network settings.	Chapter 15
760	Cannot execute or set when IEEE 1588 is on. To execute or change this setting, turn off IEEE 1588.	16.3
761	Cannot execute or set when SNTPs "Adjust at Power On" is on. To execute or change the setting, turn off "Adjust at Power On".	15.6
762	Cannot execute when IEEE 1588 is not in the "Stable" state. To execute, wait until the state becomes "Stable" or turn off IEEE 1588.	16.3
800	Illegal date-time. Set the correct date and time.	3.6*
801	Illegal file name. The file name contains characters which are not allowed or the file name is not a valid MS-DOS file name. Enter another file name.	8.2
802	Cannot be set or executed in the Normal measurement mode.	—
803	Cannot be set or executed in the IEC Harmonic measurement mode	13.1
812	Cannot be set or executed while storing data.	—
813	Cannot be set while integration is running. Reset Integration.	4.2
814	Cannot be set or executed when NULL is on. Please turn NULL off.	11.1
815	Cannot be set or executed when the Update Mode is Auto. Change to a different Update Mode to execute.	2.10
820	Cannot be set or executed in the Flicker measurement mode.	14.1
821	Attempt made to start flicker measurement while flicker initialization is not finished.	—
822	Attempt made to start flicker measurement while flicker measurement is in progress or result of flicker judgement is displayed.	—
823	Cannot change during CAL. Wait until CAL is completed.	11.2
824	Attempt made to initialize flicker measurement while flicker measurement is in progress or result of flicker judgement is displayed.	—
825	Cannot change limit settings while flicker measurement is in progress.	—
826	Cannot be set or executed when flicker measurement is not reset.	14.2
827	Illegal math expression. Input a correct computing equation.	4.1
828	Cannot start flicker measurement when all periods of dmax measurement are finished.	—
829	Cannot judge flicker measurement until all periods of dmax measurement are finished.	—
830	Cannot move period while dmax measurement is not ready.	—
831	Processing now. Retry setting or execution again.	—
841	Attempted to start integration after integration time has reached its preset value.	4.2

* Getting Started Guide, IM WT5000-03EN

Appendix 1 Messages and Corrective Actions

Code	Message	Chapter or Section
842	Attempted to start integration while integration is in progress.	4.2
843	Measurement stopped due to overflow during integration or due to a power failure.	4.2
844	Attempted to stop integration even though integration was not in progress.	4.2
845	Attempted to reset integration even though integration was in progress or integration mode was not selected.	4.2
846	Attempted to start integration while measurement of peak overflow was in progress.	—
847	Attempted to start integration in continuous integration mode when integration preset time was set to "0".	4.1
848	Attempted made to start integration in real time counting integration mode when the end time had already passed.	4.1
849	Attempted made to start storing in real time counting storing mode when the end time had already passed.	7.1
850	Cannot be set or executed at current store state. To set or execute, reset store.	7.4
852	Stored file is illegal. Initialize memory before storing.	7.4
854	Waveform display data not found.	—
855	Data destination memory is full. Saving has been stopped.	—
856	An error has occurred while storing. Storing has been stopped.	—
857	Cannot be set while Master/Slave Synchronized Measurement is set to Slave.	2.14
858	Store process is in progress now. Execute or set setting again.	—
859	Cannot convert selected file. Select a file with an extension of WTS or HDS.	7.3
862	Numeric data not found.	—
863	Cannot be set or executed when different types of elements are installed.	—
864	This wiring cannot be set as the first selected element.	2.1
865	Cannot be set while integration is running. Stop or reset Integration.	4.2
874	Sync source, PLL source or trigger source cannot be set to Ext Clk, while Master/Slave Synchronization Measurement is set to Slave.	2.14
875	Master/Slave Synchronization Measurement cannot be set to Slave, while sync source, PLL source or trigger source is set to Ext Clk.	2.14
876	Can not calculate from present point value.	9.1
877	Can not set 0 to count.	7.1
878	Can not set 0. Set to a value other than 0.	—
880	Cannot be set or executed while initialization. Wait until status changes to "Ready".	—
881	Cannot be set or executed while measurement is in progress. To set or execute, "Stop" measurement.	—
882	Stopped measurement. Detection error of measuring interval signal. Check External Sync (MEAS START) input.	4.3*
885	Cannot be set or executed in Current Measurement Mode. Set or execute in Normal Measurement Mode.	1.1
888	Cannot start integration. Disable independent integration or change update mode to "Constant".	4.1,2.1
889	Setting and execution is not available when auto-ranging is set to ON.	—
890	Cannot start store. Change store mode to a mode other than "integration synchronization" or set store interval to zero. Otherwise, change update mode to a mode other than "Auto".	7.1,2.1
893	Invalid cutoff frequency setup. Set the cutoff frequencies so that the low pass filter's (LPF) cutoff frequency is higher than the high pass filter (HPF).	2.7
894	Cannot be executed/set in current condition. For all current inputs with in the same wiring, "CT Type" or "Input Resistance" must have the same setup.	2.1

* Getting Started Guide, IM WT5000-03EN

System Error Messages (900 to 999)

Code	Message	Chapter or Section
901	Failed to backup setup data. The system has been initialized. Maintenance service is required.	—
902	System RAM failure. Maintenance service is required.	—
903	System ROM failure. Maintenance service is required.	—
904	Internal temperature is too high. Maintenance service is required. It will shutdown automatically.	—
905	Detected Sensed disconnection of input element. Turn Off the instrument and reinsert the input element. If this error continues or frequently occurs, maintenance service is required.	—
906	Fan stopped. Power off immediately. Maintenance service is required.	—
907	Backup battery is flat. Maintenance service is required to replace the back-up battery.	—
909	Illegal SUM value. Maintenance service is required.	—
911	Software exception has occurred. A firmware update may be required. Notify maintenance service the Service No. below.	—
915	EEPROM SUM error. EEPROM may be damaged. Maintenance service is required.	—
918	Input element1 is not installed. Turn Off the instrument and insert an input element to element1.	—
919	Option board cannot be detected. Maintenance service is required.	—
921	Failed to communicate with measure component. Reboot the instrument and try again. If this error persists after rebooting, please consult with service.	—
922	Failed to communicate with measure component. Reboot the instrument and try again. If this error persists after rebooting, please consult with service.	—
923	Transmit data abnormality from devices. Maintenance service is required.	—
925	Error while synchronizing to IEEE 1588. Please turn IEEE 1588 off once to reset state.	16.3
926	The USB device's power consumption exceeded the capacity of the USB hub.	—
927	Disconnected USB device port 1, because overcurrent was detected.	—
928	Disconnected USB device port 2, because overcurrent was detected.	—
929	A USB mass storage device that is greater than 137 GB in capacity has been connected. Be careful in using this device. If an area exceeding 137 GB is accessed, the storage device may break.	—
931	Hardware configuration error occurred. Restart this machine. If it occurred again, maintenance service is required.	—
932	Error occurred while ImageFile process.	—
940	An element with an old version has been installed. The firmware may require an element version upgrade for correct measurement. Contact maintenance service for element update instructions.	—
941	A new element version or type has been installed. In order to make correct measurements or to measure with the new element types, upgrade the instrument's firmware.	—
942	Hardware mismatch error occurred. Maintenance service is required.	—
943	An overcurrent of internal shunts has been detected. The measured data is incorrect.	—
944	An overcurrent of the CT sensors or the current probes has been detected. The power of devices has been shutdown. Power off immediately.	—
945	An overcurrent has been detected. The power of sensors has been shutdown. Power off immediately.	—
946	The connection with CT series has been detected. The CT Type settings are different from the detected sensors. Please confirm them.	—
947	Detected changes in insertion and removal with the CT sensors. Please confirm them.	—
948	An Error of the sensor power supply was detected. The power to the device has been shutdown. Power off immediately. Maintenance service is required.	—

Index

Symbols

Δ Measure 1-10, 2-34

Numerics

4-value display 3-5
8-value display 3-5
16-value display 3-5

A

All Items Display 3-4
auto naming 8-4
auxiliary input (Aux) 1-7
averaging 2-35
Averaging menu x

B

background (load, of user display) 3-27

C

Cal Execute 11-3
Cal menu xvi
Ch Settings (Auxiliary) 9-6
Ch Settings (Double Motor) 9-5
Ch Settings (Single Motor (Speed:Analog)) 9-3
Ch Settings (Single Motor (Speed:Pulse)) 9-2
column settings (displayed columns) 3-7
command type 16-2
comment 8-5
Computation/Output 1-9
copy 8-17
crest factor 2-29
cross level 1-6
CT ratio 2-14
current range (760901 or 760902) 2-5
current range (760903) 2-6
Current Range Display Format 2-11
cursors (bar graph) 12-6
cursors (trend) 12-4
cursors (waveform) 12-2
custom display 3-28
CUSTOM key 3-30
custom screen 3-29

D

D/A output 1-14, 16-3
Data Save 1-13
Data Save (data format) 8-9
Data Save (items) 8-6
Data Save menu xiii
Data Save (save destination) 8-3
delete 8-21
delta computation 2-34
Delta computation 1-10
display 1-12
display configuration (load) 3-27
display configuration (user display) 3-26

displayed items, resetting 3-7
display format (file list) 8-14
display format (screen) 1-12
display (graph) 6-1
Display (graph) 3-28
Display icon v
Display menu v
display (numeric) 3-1, 3-25
Display (numeric) 3-25

E

efficiency 1-9, 2-33
electrical angle measurement 9-9
Element Set 5-2
End 7-11
expression 3-19
external current sensor conversion ratio 2-10
Ext Sensor 2-10

F

File List 1-22, 8-4, 8-13
file list, sorting 8-13
file name 8-4
Filter icon xii
Filter menu xii
flicker 14-1
Flicker Icon xv
Flicker Menu xv
Form (bar graph) 6-13
Form (trend) 6-9
Form (vector) 6-16
Form (waveform) 6-6
Freq2 Measurement 1-6
Freq2 Measurement (Advanced Settings) 2-26
Freq Filter 2-22
Freq Filter/Rectifier/Level 1-6
frequency filter for sync source (voltage/current) 1-6
FTP server 1-17, 15-5

G

GP-IB 16-2
Graph Color 16-9
Graph (graph display) 3-2, 6-2
GRAPH key 6-3

H

harmonics 1-11, 5-1
hold 10-1
Hold menu xvi
hot-plugging 8-2
Hrm List Dual 3-6
Hrm List Single 3-6

I

IEC flicker 14-1
IEC harmonic measurement 13-1
IEC voltage fluctuation 14-1
IEEE 1588 16-4
independent control 4-4
Initialize Settings 1-23

Index

Input (Advanced/Options).....	1-4
Input (Basic)	1-2
integration.....	1-14, 4-1
Integration icon.....	xiv
Integration menu.....	xiv
integration status display	4-8
integration timer.....	4-2
Item (integrated value).....	4-7
Items (apparent power, reactive power, corrected power)....	3-13
Items (bar graph).....	6-12
Items (computed value (numeric/event)).....	3-21
Items (display format).....	3-4
Items (harmonic measurement).....	5-4
Items (maximum value (user defined)).....	3-24
Items (motor evaluation).....	9-13
Items (phase difference, frequency (voltage/current)).....	3-16
Items (trend).....	6-8
Items (user display).....	3-26
Items (vector).....	6-15
Items (voltage, current, active power, power factor).....	3-10
Items (waveform).....	6-5

K Page

keyboard test.....	16-11
--------------------	-------

L Page

language.....	16-6
LCD	16-7
Level.....	1-6
level (cross level).....	2-28
Limit Settings.....	14-2
line filter	2-21, 2-22
Line Filter.....	1-5
Load Setup.....	1-23
Load (user display).....	3-27
lock.....	16-16

M Page

master and slave	2-36
matrix display.....	3-5
Max Hold	3-23
measure.....	1-12
measure (apparent power, reactive power, corrected power)	3-12
measurement mode.....	1-1
measurement range configuration.....	1-5
measurement scene.....	1-29
measuring range.....	1-4
memory test.....	16-10
menu icon.....	iv
message log	1-19, 16-12, 16-13
Misc icon.....	xvi
Misc menu	xvi
Motor/Aux.....	1-7, 9-1
motor efficiency computation.....	9-10
motor evaluation.....	1-7
move.....	8-18

N Page

Net Drive.....	15-8
network	1-17
network drive	1-18
new folder.....	8-16
null.....	1-7, 11-1
null feature.....	1-7
Null menu	xvi

NUMERIC key	3-8
NUMERIC key (user display).....	3-27
Numeric (numeric display).....	3-2, 6-2

O Page

OPTIONS key.....	9-11
Options tab	9-11

P Page

Pause	7-11
phase.....	3-15
power coefficient.....	2-14
preference	16-8
protect.....	8-20

Q Page

q Mode.....	4-5
-------------	-----

R Page

Range.....	1-4
Range Config.....	1-5
range configuration.....	1-5
Range icon	ix
Range menu.....	ix
Range Σ Link	2-2
real-time control.....	4-3
Rec	7-11
Rectifier	1-6
register (custom display)	3-29
remote control.....	1-16, 16-1
rename	8-20
reset (integration)	4-8

S Page

Save Setup.....	1-22
save (user display)	3-26
scaling	2-14
screen brightness	16-7
screen, turning off.....	16-7
second frequency filter	1-6
Selected Stored Items	7-7
Select (file list).....	8-16
Select Saved Numeric Items	8-7
Selftest.....	1-19, 16-10
Sensor Correction menu.....	xvi
Sensor Status.....	1-20, 16-15
Single Execute.....	10-3
Single menu.....	xvi
SNTP.....	1-18, 15-9
start (integration)	4-8
stop (integration).....	4-8
storage mode (Event).....	7-4
storage mode (manual)	7-2
storage mode (real time)	7-3
store.....	1-13
Store/Data Save icon.....	xiii
Store (items).....	7-6
Store menu	xiii
Store (mode).....	7-1
Store (save destination).....	7-9
storage mode (Integ Sync)	7-4
Sync Measure.....	2-36
Sync Source	2-28
Sync Source/Freq Measurement(Advanced Settings)	2-24
system configuration.....	1-15
system overview	1-20, 16-14

T	Page
TCP/IP	1-17, 15-3
time synchronization (IEEE 1588)	16-4
trend values	6-9
trigger	2-31

U	Page
Update Mode	2-30
update rate	2-30
Update Rate/Averaging	1-11
Update Rate/Averaging icon.....	x
Update Rate menu	x
Upgrade.....	1-20
USB	16-2
USB-0	8-2
USB-1	8-2
USB driver	16-2
USB keyboard	16-6
USB memory	8-2
USB ports (type A).....	8-2
User Defined Events.....	3-19
User Defined Functions	3-18
user display	3-25
utility	1-15

V	Page
valid measurement range (current)	2-18
valid measurement range (voltage).....	2-16
value	6-9
voltage fluctuation.....	14-1
voltage range.....	2-4
VT ratio	2-14
VXI-11	16-2

W	Page
Web server	1-17, 15-6
Wiring	1-4
wiring system.....	1-4, 2-2
WP± Type	4-4