



Base Station Analyzer

JD7105B/JD745A

The Base Station Analyzers JD7105B and JD745A are optimal test tools for installing and maintaining cell sites. They contain all the features and capabilities required to field test cell sites all 2G to 4G wireless technologies.

The Base Station Analyzers are equipped with one-button standards-based measurements for wireless signals and offers the full scope of BTS conformance tests. Its combined functionality includes spectrum analysis, cable and antenna analysis, power meter, interference analysis, channel scanner, E1/T1 analysis, and signal analysis.

The Base Station Analyzers are the ideal field testing solutions that combine portability and performance, due to its lightweight design and extended battery operation and its multifunction capability, respectively. In addition, its strong enclosure withstands harsh environments and its backlit key panel enables maintenance tasks in poorly lit situations.

Key Features

- Spectrum analyzer
- Cable and antenna analyzer
- Power meter
- Advanced features:
 - Interference analysis
 - Channel scanner
 - E1 and/or T1 analysis
 - GPS receiver
 - Built-in Bias Tee
 - cdmaOne/CDMA2000, EV-DO, GSM/ GPRS/ EDGE, WCDMA/ HSDPA, TD SCDMA, Mobile WiMAX, LTE FDD, and LTE TDD signal analysis

Instrument	Spectrum Analyzer	Cable and Antenna Analyzer	Power Meter
JD7105B	100 kHz to 7.2 GHz	25 MHz to 4 GHz	10 MHz to 7.2 GHz
JD745A	100 kHz to 4 GHz	5 MHz to 4 GHz	10 MHz to 4 GHz

Easy User Interface

The Base Station Analyzers have a consistent and intuitive interface through its multiple functions providing a common menu structure that is easy to use.

The Base Station Analyzers have a built in help capability which guides users through each measurement task.

A screenshot of any functions can be saved as a graphic file for report generation and traces can be saved for post analysis process into the instrument's internal memory or external USB memory device. The stored data can be easily transferred to a PC using its USB or Ethernet port. File name editing can be done with the instrument's rotary knob that also has the function of an enter button providing convenience to choose and select alphanumeric characters.



Field Useable Design

The Base Station Analyzers are compact and lightweight especially convenient for users performing field measurements. Its bright 8" color display provides visibility in daylight. And its backlight keys provide visibility on the dark.

The Base Station Analyzers have an operating temperature range from 10 to 55°Celsius; and its rugged bumper was designed to protect the instrument from drops or other external impacts exceeding the MIL PRF 28800F class 2 specification.

Automatic Measurements

The Base Station Analyzers Auto Measure function allows a complete signal profiling covering RF characterization and modulation quality parameters of up to 10 different carriers, particularly useful on the base stations are transmitting in different frequencies.

Auto Measure can be easily executed and the instrument will automatically configure and test every aspect of all the carriers regardless of their frequency or modulation type. The Base Station Analyzers configurable channel scanner can track the power level of 20 carriers in a single measurement screen, tracking the power level of each carrier.

Multilanguage user interface

The instruments' architecture allows the graphical user interface to adapt into different languages, permitting localization around the world.

JD7105B Integrated Functionality

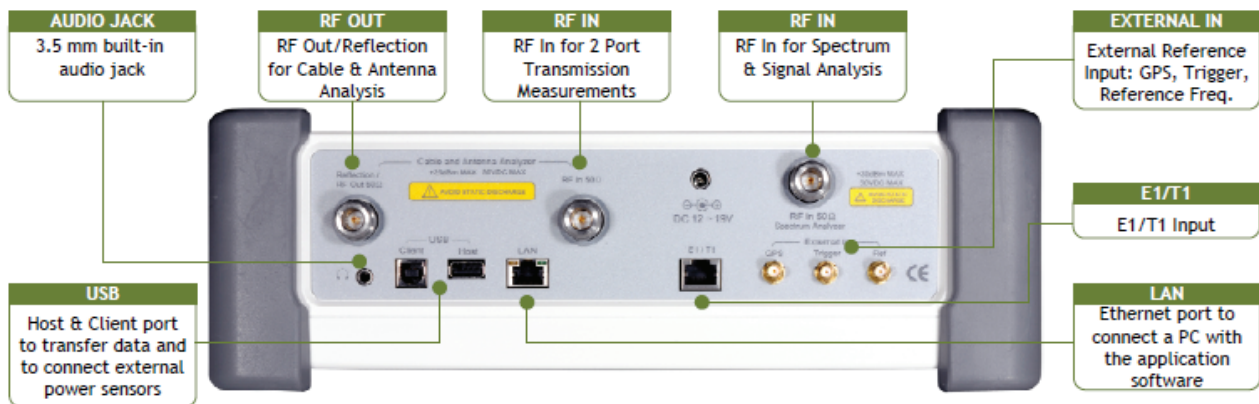

JD7105B Integrated Functionality (cont'd)

Spectrum Analyzer 100 kHz to 7.2 GHz

Locates and identifies various signals over a frequency range up to 7.2 GHz.

Built-in Pre-amplifier

Detects signal as low as -160 dBm with phase noise -100 dBc/Hz at 30 kHz offset and measurement accuracy better than 1 dB.

Zero Span with Gate Sweep

Triggers pulse or burst signal such as WiMAX, GSM, and TD-SCDMA.

Cable and Antenna Analyzer 25 MHz to 4 GHz

Provides cable and antenna characterization for proper power transfer from the radio to the antenna.

Locates failures points for an effective troubleshooting.

Verifies cable conformance specifications.

Power Meter

Integrated power meter eliminates the need of a separate instrument and provides power measurement with or without power sensors.

2-Port Transmission Measurements

Performance verification of passive and active devices such as filters and amplifiers.

Bias Tee (option 013)

Supplies up to 32 VDC built-in bias to active devices, such as amplifiers.

CW Signal Generator

Provides a sine wave or continuous wave (CW) source allowing measurements such as repeater's isolation.

E1/T1 Analyzer (options 002, 003)

Comprehensive backhaul testing that isolates problems related to the incoming traffic from the fixed network.

GPS Receiver and Antenna (option 010)

Provides geographical location and highly accurate frequency and time base enabling precise frequency measurements.

Interference Analyzer (option 011)

Provides the parameters of spectrogram and a multi-signal RSSI required to properly monitor, identify, and located interference signals. In addition it is capable of generating an audible variable tone accordingly to the signal strength.

Channel Scanner (option 012)

Intuitive graphical representation of the signal's power for each of the 20 user-definable carriers (frequencies or channels) allowing a fast identification of improper power levels.

Signal Analyzer (option 020 to 029)

Provides 3GPP/3GPP2/IEEE802.16 conformance for testing for power and spectrum, as well as modulation analysis from 2G to 4G wireless technologies.

Over the Air Analyzer (option 040 to 049)

Characterizes the transmission quality at any location providing reflective measurements and identifying signals providing from different sites.

JD745A Integrated Functionality

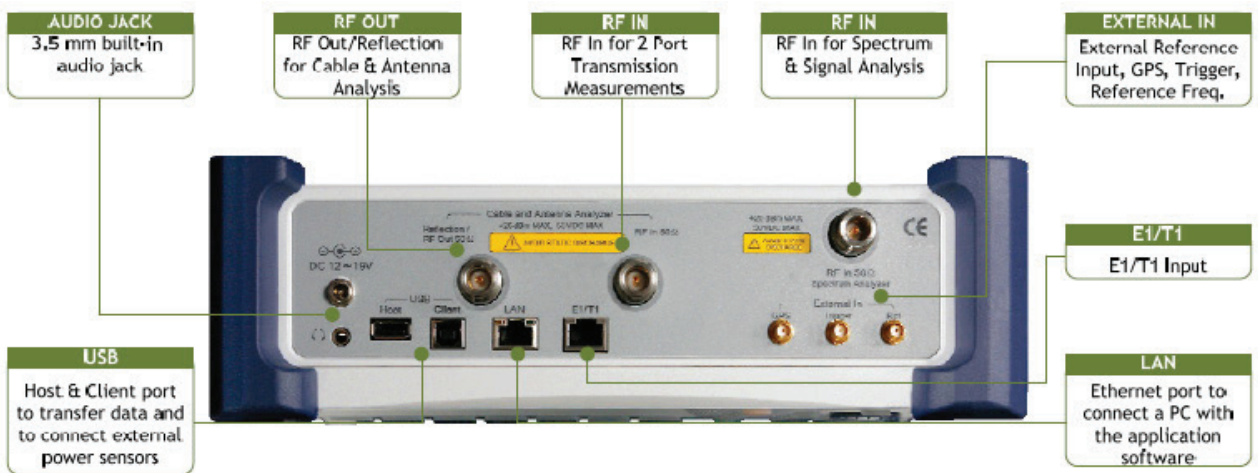

JD745A Integrated Functionality (cont'd)

Spectrum Analyzer 100 kHz to 4 GHz

Locates and identifies various signals over a frequency range up to 4 GHz.

Built-in Pre-amplifier

Detects signal as low as -155 dBm with phase noise -90 dBc/Hz at 30 kHz offset and measurement accuracy better than 1 dB.

Zero Span with Gate Sweep

Triggers pulse or burst signal such as WiMAX, GSM, and TDSCDMA.

Cable and Antenna Analyzer 5 MHz to 4 GHz

Provides cable and antenna characterization for proper power transfer from the radio to the antenna.

Locates failures points for an effective troubleshooting.

Verifies cable conformance specifications.

Power Meter

Integrated power meter eliminates the need of a separate instrument and provides power measurement with or without power sensors.

2-Port Transmission Measurements (option 001)

Performance verification of passive and active devices such as filters and amplifiers.

Bias Tee (option 002)

Supplies up to 32 VDC built-in bias to active devices, such as amplifiers.

CW Signal Generator (option 003)

Provides a sine wave or continuous wave (CW) source allowing measurements such as repeater's isolation.

E1/T1 Analyzer (options 004, 005)

Comprehensive backhaul testing that isolates problems related to the incoming traffic from the fixed network.

GPS Receiver and Antenna (option 010)

Provides geographical location and highly accurate frequency and time base enabling precise frequency measurements.

Interference Analyzer (option 011)

Provides the parameters of spectrogram and a multi-signal RSSI required to properly monitor, identify, and located interference signals. In addition it is capable of generating an audible variable tone accordingly to the signal strength.

Channel Scanner (option 012)

Intuitive graphical representation of the signal's power for each of the 20 user-definable carriers (frequencies or channels) allowing a fast identification of improper power levels.

Signal Analyzer (option 020 to 029)

Provides 3GPP/3GPP2/IEEE802.16 conformance for testing for power and spectrum, as well as modulation analysis from 2G to 4G wireless technologies.

Over the Air Analyzer (option 040 to 049)

Characterizes the transmission quality at any location providing reflective measurements and identifying signals providing from different sites.

Spectrum Analyzer

The Base Station Analyzers have a general purpose spectrum analyzer which is the most flexible test tool for RF analysis including spectrum monitoring and analysis. The spectrum analysis function provides the capability of one-button standards based power measurements for wireless signals.

- Channel Power
- Adjacent Channel Power
- Occupied Bandwidth
- Spurious Emissions
- Spectrum Emission Mask
- Field Strength

Specifications The Base Station Analyzers have one of the best sensitivity and selectivity specifications. With its builtin preamplifier, measurements can be done as low as -160 dBm^1 with a 1 Hz RBW.

Its low SSB phase noise allows detecting very low level spurs or noise signals which are close to the carrier. Its narrow (1 Hz) bandwidth ensures the identification of signals that are very close in frequency.

In addition, the narrow RBW means that the displayed noise level can be reduced improving sensitivity.

Its Auto Sweep time and Auto RBW/VBW allows an easy set up for a fast sweep time while ensuring accurate measurement.

- Frequency Range:
 - 100 kHz to 7.2 GHz (JD7105B)
 - 100 kHz to 4.0 GHz (JD745A)
- DANL (RBW 1 Hz, $f_c < 1\text{ GHz}$)
 - 145 dBm^1
 - 160 dBm with preamp¹
- Sweep Time
 - 80 ms to 1000 s
 - $24\ \mu\text{s}$ to 200 s in zero span
- RBW: 1 Hz to 3 MHz
- VBW: 1 Hz to 3 MHz
- SSB Phase Noise
 - 100 dBc/Hz at 30 kHz¹
 - 102 dBc/Hz at 100 kHz¹
 - 115 dBc/Hz at 1 MHz¹

1. JD7105B specifications

Capabilities

- Built-in Preamplifier
 - Zero Span with Gated Sweep
 - AM/FM Audio Demodulation
- Multiple Detectors
 - Normal, RMS, Sample Negative, Peak
- Advanced Marker
 - Frequency counter
 - Noise marker
- Limit Line
 - Up to 6 markers and 6 traces

Measurements

Channel power measures the power level, spectral density and peak to average ratio (PAR) of the signal in a specified channel bandwidth, showing a "Pass" or "Fail" condition according to the defined power.



Channel power

Spectrum Analyzer (cont'd)

Occupied bandwidth measures the frequency bandwidth that contains the specified percentage of the power, the total integrated power and the occupied power, showing a "Pass" or "Fail" condition according to the defined bandwidth.



Occupied bandwidth

Adjacent channel power (ACP) measures the amount of interference, or power, in adjacent frequencies and its ratios, showing a "Pass" or "Fail" condition according to the defined test condition.



Adjacent Channel Power

Spectrum emission mask (SEM) compares the total power level within the defined carrier bandwidth and the given offset frequencies to the defined mask limits with "Pass" or "Fail" result.



Spectrum emission mask

Spurious emissions identifies and determines the power level of spurious emissions in certain frequency bands, showing a "Pass" or "Fail" condition according to the defined mask limits.



Spurious emissions

Field strength offers quick and convenient field strength measurement and analysis with the userdefinable multi segment line. The field strength measurement is easy to make once the antenna factors are specified in the analyzer.

AM/FM audio demodulation allows an easy identification of interfering signals. The AM/FM signal can be demodulated into the instrument's built-in speaker or through a headset.

Spectrum analyzer can be simultaneously operated with CW signal generator. It is easily fulfilling the guideline of >100 dB required for repeater and antenna isolation measurement.

Cable and Antenna Analyzer

The Base Station Analyzers perform cable and antenna measurements for the verification of base station's infrastructure including feed-lines, connectors, antennas, cables, jumpers, amplifiers, and filters.

The distance-to-fault (DTF) function is capable of locating transmission problems up to 1,500 m (4,921 ft), at a measurements speed of 2 ms/data².

The Base Station Analyzers offer a superior analysis tools including a trace overlay feature allowing a comparison analysis of up to 6 traces, and supporting up to 6 individual markers allocated to any trace.

In addition, it includes a user-configurable marker bands enabling visual identification of uplink and downlink frequencies for compliance verification with a single measurement trace.

Capabilities

Reflection

- VSWR
- Return Loss

DTF

- VSWR
- Return Loss

Cable Loss (1 port)

- 1-Port Phase
- Smith Chart

2-Port Transmission Measurements

Insertion

- Loss
- High Gain
- Low Gain

2-Port Phase

2. JD7105B specifications

Measurements

Reflection measures the complete cell-site transmission line impedance performance across the frequency range of interest in voltage standing wave ratio (VSWR) or return loss.

Distance-to-fault (DTF) measures fault locations in the transmission system of the cell-site indicating signal discontinuities in VSWR or return loss. Use this measurement to precisely pinpoint the location of damaged or degraded antennas, connectors, amplifiers, filters, and duplexers, etc.



Reflection return loss



DTF return loss

Cable and Antenna Analyzer (cont'd)

Cable loss (1 port) measures the signal loss through a cable or other devices over a defined frequency range. It is sufficient to connect one end of the cable to the instrument measurement port. The other end of the cable is terminated with a short or left open.



Cable loss (1 port)

Smith charts and phase measures impedance and phase for proper tuning of RF devices.

Smith charts can be used to display impedance matching characteristics in cable and antenna system as well as filter and duplexers devices.



Smith chart

1-Port phase measures S11 phase in order to tune antennas and phase match cables.



1-Port phase

2-Port transmission measurements which are insertion gain/loss and 2 port phase provide real vector network analysis. Matching and transmission characteristics of filter and amplifiers can be determined quickly and highly accuracy.

Insertion gain/loss measures the characteristics of passive and active devices such as filters, jumpers, splitters, and amplifiers as well as verifies antenna isolation or sector to sector isolation.



Insertion loss

2-Port phase measures S21 phase in order to characterise transmitted device.

The optional built-in **bias tee** supplies power to active devices through the instrument's RF-In port eliminating the need of an external power supplies.

Power Meter

The Base Station Analyzers perform two different methods of power measurement; the first is an internal power measurement for standard power testing without the assistance of external power sensors and the second is interfacing with an external power sensor for high accuracy power measurements.

Internal power measurement	External power measurement	
Frequency range • 10 MHz to 7.2 GHz ³ Dynamic range • -120 to +30 dBm ³ Measurement type • RMS • Peak	Terminating power Sensor JD732A • Average power JD734A • Peak power JD736A • Average and peak power	Directional (Through Line) power sensor JD731A/JD733A • Forward average power • Forward peak power • Reverse average power • VSWR



Internal power measurement

The Power Meter function also provides a Pass/Fail condition with user-definable limits. The test results are displayed in dBm and Watts. The power measurement can be set as an absolute measurement displayed in dBm or as a relative measurement displayed in dB.

The JD7105B and JD745A display the power level in two formats, as a real-time power level value in an analog meter, and as a power level trend through time in a histogram chart.

For high-precision power measurements the JD7105B and JD745A interface with external power sensors through a USB connection. There are two types of power sensors:

- Termination power: Power sensor JD732A, JD734A, or JD736B. For out-of-service testing.
- Directional power or through line: Power sensor JD731A or JD733A. Having the advantage to perform in-service power testing.



External power measurement



3. JD7105B specifications

Interference Analyzer

The Interference Analyzer (option 11) is the most effective way to locate and identify periodic or intermittent RF interferences. The presence of interference signals are derived from licensed or unlicensed transmitters of many kinds causing dropped calls and poor quality service.

Measurements

The **spectrum analyzer** with an audible indicator is especially useful during the process of locating the interferer source with a directional antenna.



The **audible tone** is proportional to the signal power strength. In addition a built in AM/FM audio demodulator it provides a convenient identification of AM/FM signals.

Interference ID allows an automatic classification of the interfering signal providing a list of possible signal types corresponding to the signal selected.

The **spectrogram** captures spectrum activity over time indicating the power levels of the spectrum with different color identification.

The spectrogram is an effective measurement to identify periodic or intermittent signals. Post-processing analysis can be done for each measurement over time using a time cursor..

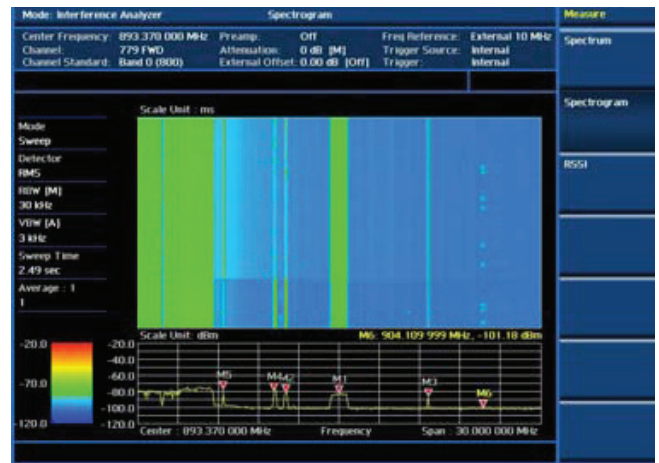

Spectrogram

Received signal strength indicator (RSSI) is a multiple signal tracking metric that is particularly useful for measuring power level variations over time.

The RSSI measurement also allows the assignment of power limit line for generating an audible alarm and increasing an alarm counter every time any signal goes beyond the limit line.

For long-term analysis the spectrogram and RSSI measurements can be automatically saved into an external USB memory. Post analysis can be done with the application software JDViewer.



Received signal strength indicator

Signal Analyzer

The signal analyzer performs 3GPP/3GPP2/IEEE802.16 standard compliance testing for power and spectrum, as well as modulation analysis; making RF parametric analysis as well as modulation quality performance of modern wireless communication systems. It performs standard-based measurements with a single-button action, indicating a Pass/Fail condition according to the standard-based or userdefined limits.

The auto measure capability in the signal analyzer lets users easily set up testing scenarios, including the programming of measurement schedules such as start time, duration, intervals and measurement parameters. Based on the user defined conditions, the JD7105B and JD745A perform the tests of up to 10 carriers and automatically store the results.

The over the air (OTA) analyzer function provides over the air measurements for quick performance characterization of the base station. This measurement capability is especially useful in testing cell sites which are not easily accessible or the cell site proactively without interrupting service.

The signal analyzer provides following measurement capabilities:

- Spectrum analysis
- RF analysis
- Modulation analysis
- Auto measure



The **modulation analysis** can be performed in any of the following wireless technologies:

- cdmaOne/CDMA2000 (option 020)
- EV-DO (option 021)
- GSM/GPRS/EDGE (option 022)
- WCDMA/HSDPA (option 023 and 024)
- TD-SCDMA (option 025)
- Mobile WiMAX (option 026)
- LTE – FDD (option 028)
- LTE – TDD (option 029)



Available **OTA analyses** are:

- cdmaOne/CDMA2000 (option 040)
- EV-DO (option 041)
- GSM/GPRS/EDGE (option 042)
- WCDMA/HSDPA (option 043)
- TD-SCDMA (option 045)
- Mobile WiMAX (option 046)
- LTE – FDD (option 048)
- LTE – TDD (option 049)

GSM/GPRS/Edge Signal Analyzer

The GSM/GPRS/EDGE Signal Analyzer performs power and spectrum measurements as well as modulation analysis in a simple and easy manner with just a few key strokes.

It makes conformance testing according to the specifications (3GPP TS 51.021) providing a simple Pass/Fail indication on each test.

RF and modulation analysis (option 22)		OTA analysis (option 42)
Channel power	Power vs time	Channel scanner
Occupied bandwidth	• Slot	Frequency scanner
Spectrum emission mask	• Frame	Multipath profile
Spurious emissions	Constellation	Modulation analyzer
	Auto measure*	

Measurements

Channel power measures the total RF power, spectral density and peak to average ratio (PAR) of the signal in a GSM channel bandwidth.

Occupied bandwidth measures the frequency bandwidth that contains 99% of the power, measuring the total integrated power and the occupied power.

The **spectrum emission mask (SEM)** compares the total power level within the defined carrier bandwidth and the given offset channels according to the standards.

Power vs. time (slot) measures the modulation envelope in the time domain showing the signal rise and fall shape of GSM format.

I-Q constellation verifies the modulation quality including phase errors and I-Q origin offsets characterizing the modulation quality of GSM.

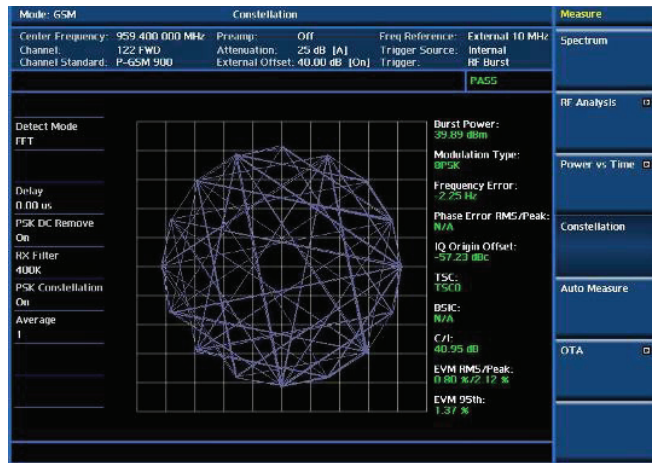

GSM constellation

The over the air (OTA) analyzer provides signal performance metrics at any point in the area served by the base station, including multipath profile indicating the strength of reflected signals; as well as carrier over interference histogram indicating the signal strength variation.

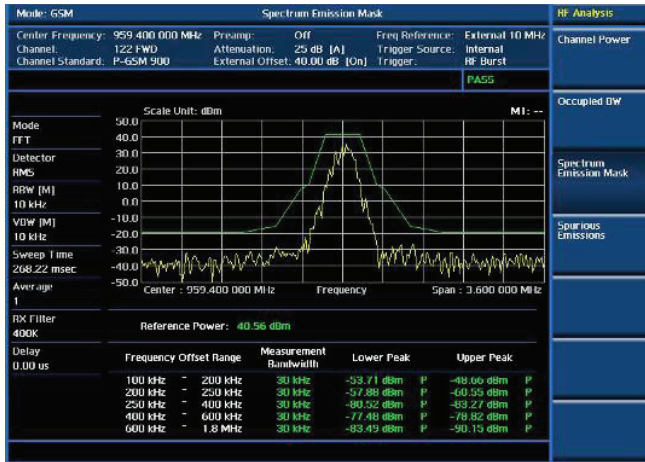

GSM spectrum emission mask

Spurious emissions identifies and determines the power level of spurious emissions in certain frequency bands.

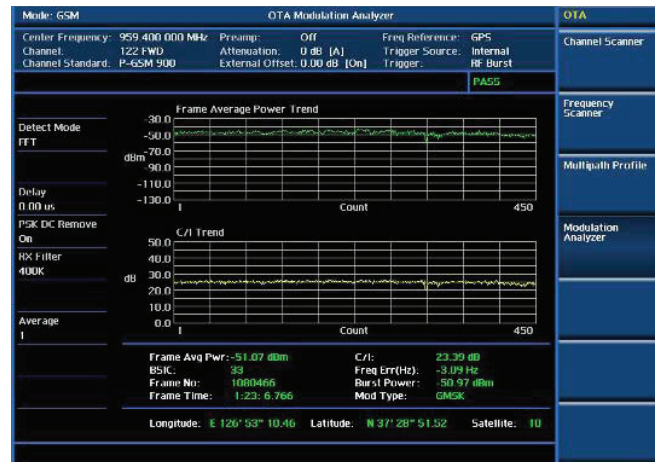

GSM OTA modulation analyzer

WCDMA/HSDPA Signal Analyzer

The WCDMA/HSDPA Signal Analyzer perform power and spectrum measurements, as well as modulation analysis in a simple and easy manner with just a few key strokes.

It performs conformance testing according to the following standards providing a simple Pass/Fail indication on each test.

- 3GPP TS 25.104. Base station radio transmission and reception (FDD)
- 3GPP TS 25.141. Base station (BS) conformance test (FDD)
- 3GPP TS 25.211. Physical channel and mapping of transport channels onto physical channels (FDD)
- 3GPP TS 25.212. Multiplexing and channel coding (FDD)
- 3GPP TS 25.213. Spreading and modulation (FDD)

RF and modulation Analysis (option23/24)		OTA analysis (option 43)
Channel power	Constellation	Channel scanner
Occupied bandwidth	Code domain power	Scramble scanner
Spectrum emission mask	Codogram	Multipath profile
ACLR	RCSI	Code domain power
Multi-ACLR	CDP table	
Spurious emissions	Auto measure	
	Power statistics CCDF	

Measurements

Channel power measures the total RF power, spectral density and peak to average ratio (PAR) of the signal in a WCDMA channel bandwidth.

Occupied bandwidth measures the frequency bandwidth that contains 99% of the power, measuring the total integrated power and the occupied power.

Spectrum emission mask (SEM) compares the total power level within the defined carrier bandwidth and the given offset frequencies on both sides of the carrier frequency to levels allowed by the standards.

Adjacent channel leakage power ratio (ACLR) measures the amount of interference, or power, in an adjacent frequency channel according to the standards.



WCDMA ACLR

Spurious emissions identifies and determines the power level of spurious emissions in certain frequency bands.

The **constellation** measurement displays the I-Q constellation diagram with modulation metrics to characterize the transmitter's modulation performance.



WCDMA channel power

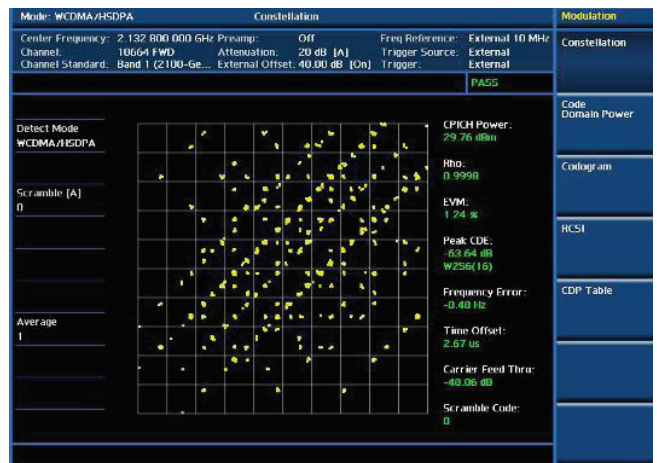

WCDMA constellation

WCDMA/HSDPA Signal Analyzer (cont'd)

Code domain power (CDP) measures power levels of the spread code channels across WCDMA RF channel, normalized to the total WCDMA power.

CDP shows the physical channels of the WCDMA signal, and identifies the various spread factors by different color types, making it easy to differentiate traffic types carried in the WCDMA signal.



WCDMA code domain power

The **codogram** displays the power variation for every code over time, presenting a clear view of the traffic load per channels at any given time.

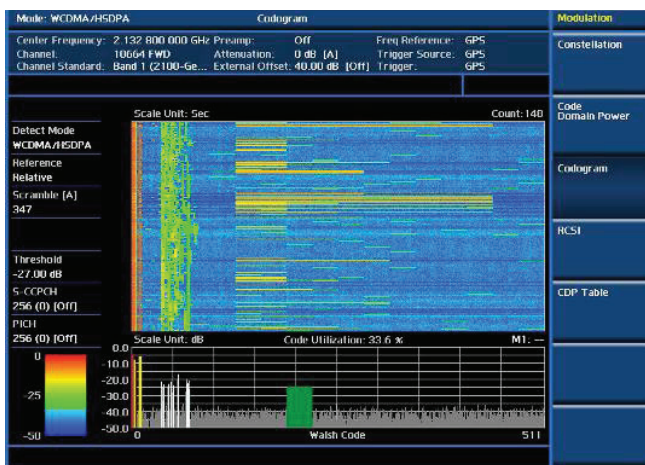

WCDMA codogram

Received code signal indicator (RCSI) shows the power variation over time of WCDMA control channels: CPICH, PCCPCH, SCCPCH, PICH, PSCH, and SSCH.

For long-term analysis the codogram and RCSI measurements can be automatically saved into an external USB memory, post-analysis can be done with the application software JDViewer.

The **complementary cumulative distribution function (CCDF)** characterizes the statistical power level distribution of WCDMA at any given time.

The **OTA analyzer** covers three key parameters: scramble scanner, multipath profile and code domain power.

The code domain power in OTA analyzer shows not only modulation performance metrics but also amplifier capacity and code utilization metrics.



WCDMA OTA code domain power

cdmaOne/CDMA2000 Signal Analyzer

The cdmaOne/CDMA2000 Signal Analyzer performs power and spectrum measurements, as well as modulation analysis in a simple and easy manner with just a few key strokes.

It performs conformance testing according to the following standards providing a simple Pass/Fail indication on each test.

- 3GPP2 C.S0002. Physical Layer Standard for CDMA2000 Spread Spectrum Systems
- 3GPP2 C.S0010. Recommended Minimum Performance Standards for CDMA2000 Spread Spectrum Base Station

RF and modulation analysis (option20)		OTA analysis (option 40)
Channel power	Constellation	Channel scanner
Occupied bandwidth	Code domain power	PN scanner
Spectrum emission mask	Codogram	Multipath profile
ACPR	RCSI	Code domain power
Multi-ACPR	CDP table	
Spurious emissions	Auto measure	
	Power statistics CCDF	

Measurements

Channel power measures the total RF power, spectral density and peak to average ratio (PAR) of the signal in a cdmaOne or CDMA2000 channel bandwidth.

Occupied bandwidth measures the frequency bandwidth that contains 99% of the power, measuring the total integrated power and the occupied power.

Adjacent Channel Power Ratio (ACPR) measures the amount of interference, or power, in adjacent frequencies and its ratios specified by the standards.

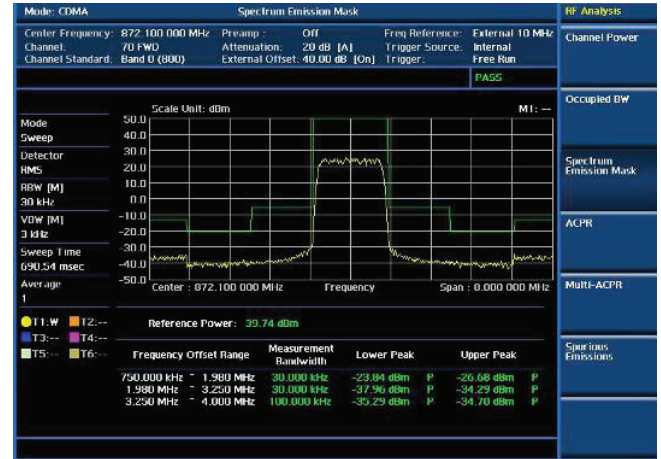

CDMA ACPR

Spurious emissions measurement identifies and determines the power level of spurious emissions in certain frequency bands.

The **constellation** measurement displays the I-Q constellation diagram with modulation metrics to characterize the transmitter's modulation performance.

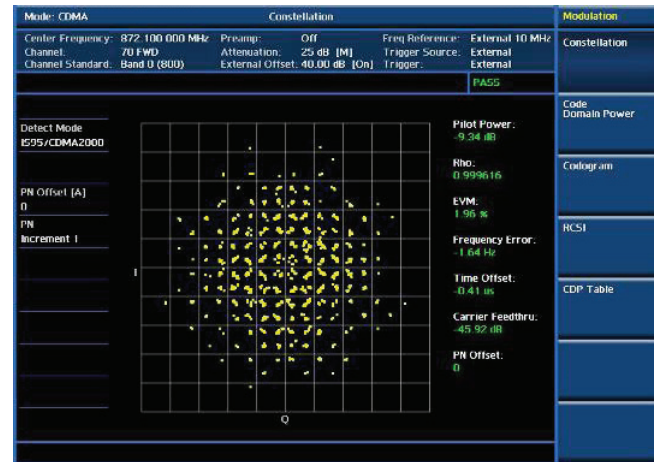

CDMA constellation

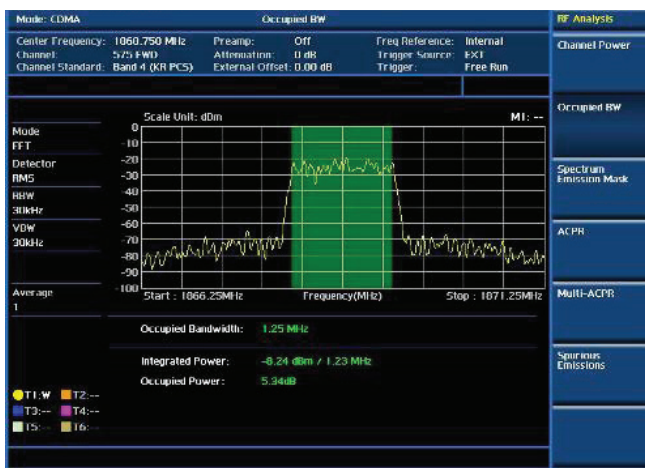

CDMA occupied bandwidth

Spectrum emission mask (SEM) compares the total power level within the defined carrier bandwidth and the given offset frequencies on both sides of the carrier frequency to levels allowed by the standards.

cdmaOne/CDMA2000 Signal Analyzer (cont'd)

Code domain power (CDP) measures power levels of the spread code channels across cdmaOne or CDMA2000 RF channel, normalized to the total CDMA power.

CDP shows the physical channels of the cdmaOne or CDMA2000, and identifies the various spread factors by different color types, making it easy to differentiate traffic types carried in the CDMA signal.

The **codogram** displays the power variation for every code over time, presenting a clear view of the traffic load per channel at any given time.

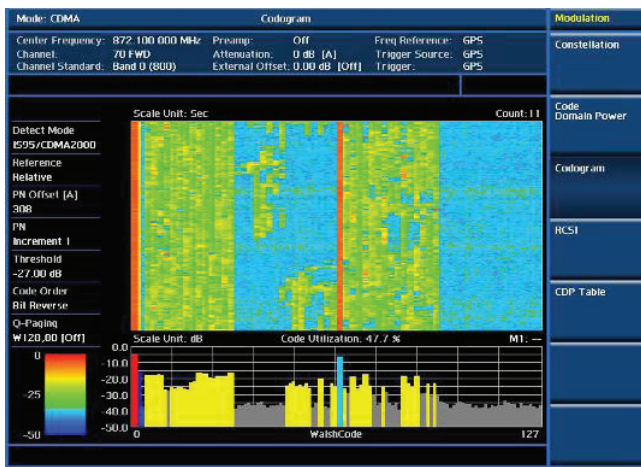

CDMA codogram

Received code signal indicator (RCSI) shows the power variation over time of cdmaOne or CDMA2000 control channels: Pilot, page, sync and quick page.

For long-term analysis the codogram and RCSI measurements can be automatically saved into an external USB memory, Post-analysis can be done with the application software JDViewer.



CDMA received code strength indicator

The **complementary cumulative distribution function (CCDF)** characterizes the statistical power level distribution of cdmaOne or CDMA2000 at any given time.

The **OTA analyzer** covers four key parameters: channel scanner, PN scanner, multipath profile and code domain power.

The code domain power in OTA analyzer shows not only modulation performance metrics but also amplifier capacity and code utilization metrics.

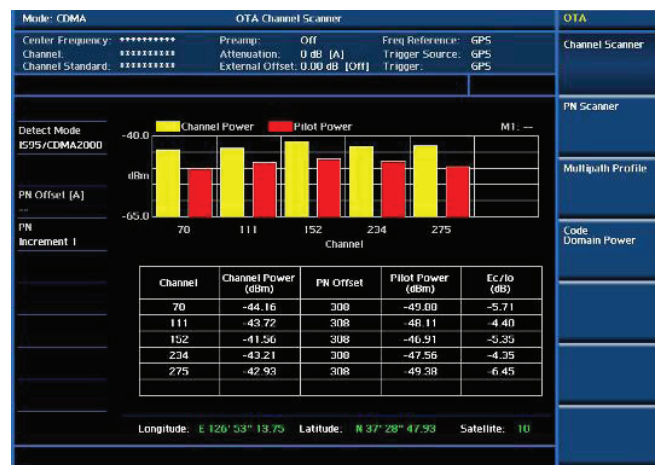

CDMA OTA channel scanner

EV-DO Signal Analyzer

The EV-DO Signal Analyzer performs power and spectrum measurements, as well as modulation analysis in a simple and easy manner with just a few key strokes.

It performs conformance testing according to the following standards providing a simple Pass/Fail indication on each test.

- 3GPP2 C.S0024-B. CDMA2000 High Rate Packet Data Air Interface Specification
- 3GPP2 C.S0032-B. Recommended Minimum Performance Standards for CDMA2000 High Rate Packet Data Access Network

RF and modulation analysis (option21)		OTA analysis (option 41)
Channel power	Constellation	Channel scanner
Occupied bandwidth	Composite 64,	PN scanner
Spectrum emission mask	Composite 128	Multipath profile
ACPR	Pilot, MAC 64, MAC	Code domain power
Multi-ACPR	128, data	
Spurious emissions	Code domain power	
Power vs. time	Pilot, MAC 64, MAC	
• Idle slot	128, data	
• Active slot	MAC codogram	
	RCSI	
	MAC CDP table	
	Auto measure	
	Power statistics CCDF	

Measurements

Channel power measures the total RF power, spectral density and peak to average ratio (PAR) of the signal in a EV-DO channel bandwidth.

Occupied bandwidth measures the frequency bandwidth that contains 99% of the power, measuring the total integrated power and the occupied power.



EV-DO occupied bandwidth

The **spectrum emission mask (SEM)** compares the total power level within the defined carrier bandwidth and the given offset frequencies on both sides of the carrier frequency to levels allowed by the standards.

Adjacent channel power ratio (ACPR) measures the amount of interference, or power, in an adjacent frequency channel specified by the standard.

Spurious emissions measurement identifies and determines the power level of spurious emissions in certain frequency bands.

Power vs. time (slot) verifies that the transmitter output power has the correct amplitude, shape, and timing for EV-DO format.



EV-DO channel power



EV-DO power vs. time (idle slot)

EV-DO Signal Analyzer (cont'd)

The **constellation** measurement displays the I-Q constellation diagram with modulation metrics to characterize the transmitter's modulation performance.

Code domain power (CDP) measures power levels of the spread code channels across EV-DO channels, normalized to the total EV-DO power.

CDP pilot/MAC displays the power of various demodulated codes in the pilot/MAC channel.

CDP data displays the power of the 16 subchannels of the data channel separately.

Received code signal indicator (RCSI) shows the power variation over time of EV-DO channels: Pilot, MAC, data, and slot.

For long-term analysis the codogram and RCSI measurements can be automatically saved into an external USB memory. Post-analysis can be done with the application software JDViewer.



EV-DO data code domain

The **MAC codogram** displays the power variation for every code over time, presenting a clear view of the traffic load per channels at any given time.



EV-DO received codestrength indicator

The **complementary cumulative distribution function (CCDF)** characterizes the statistical power level distribution of EV-DO at any given time.

The **over the air (OTA) analyzer** covers four key parameters: channel scanner, pilot scanner, multipath profile, and code domain power.



EV-DO OTA PN scanner

TD-SCDM Signal Analyzer

The TD-SCDMA Signal Analyzer performs power and spectrum measurements, as well as modulation analysis in a simple and easy manner with just a few key strokes.

It performs conformance testing according to the following standards providing a simple Pass/Fail indication on each test.

- 3GPP TS 25.105. Base Station radio transmission and reception (TDD)
- 3GPP TS 25.142. Base Station conformance testing (TDD)
- 3GPP TS 25.222. Multiplexing and channel coding (TDD)
- 3GPP TS 25.223. Spreading and modulation (TDD)

RF and modulation analysis (option 25)		OTA analysis (option 45)
Channel power	Power vs. time	Sync-DL ID scanner
Occupied bandwidth	• Slot, frame	Sync-DL ID vs. Tau
Spectrum emission mask	• Mask, timogram	Sync-DL ID multipath
ACLR	Constellation	Sync-DL ID analyzer
Multi-ACLR	Midamble power	
Spurious emissions	Code power	
	Code error	
	Auto measure	

Measurements

Channel power measures the total RF power, spectral density and peak to average ratio (PAR) of the signal in a TD-SCDMA channel bandwidth.

Occupied bandwidth measures the frequency bandwidth that contains 99% of the power, measuring the total integrated power and the occupied frequency.



TD-SCDMA spectrum emission mask

Adjacent channel power ratio (ACPR) measures the amount of interference, or power, in an adjacent frequency channel according to the standards.

Spurious emissions identifies and determines the power level of spurious emissions in certain frequency bands.

Power vs. time verifies that the transmitter output power has the correct amplitude, shape, and timing for TD-SCDMA format.

The **timogram** displays and shows how power level changes over time making it easier to see UpPTS and DwPTS activity over time, identifying interference on UpPTS by the DwPTS transmitted from adjacent base stations.



TD-SCDMA occupied bandwidth



TD-SCDMA power vs. time (frame)

The **spectrum emission mask (SEM)** compares the total power level within the defined carrier bandwidth and the given offset channels according to the standards.

TD-SCDMA Signal Analyzer (cont'd)

The **constellation** measurement displays the I-Q constellation diagram with modulation metrics to characterize the transmitter's modulation performance.

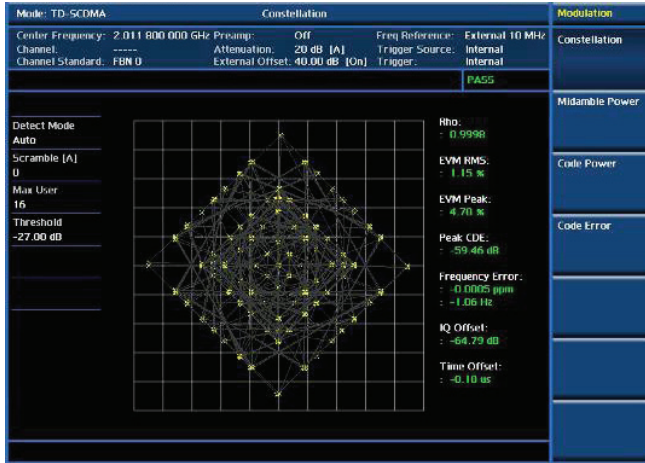

TD-SCDMA constellation

Code power provides the power data for an individual code channel and layer for a specified time slot. It displays the power of the 16 codes of a TD-SCDMA signal.



TD-SCDMA code power

Code error shows the power data and error data for an individual code channel and layer for a specified time simultaneously.

The **over the air (OTA) analyzer** provides four essential measurements: sync-DL ID scanner, sync-DL ID multipath and sync-DL ID analyzer.

The OTA provides signal performance metrics at any point in the area served by the base station, including multipath profile indicating the strength of reflected signals; as well as carrier over ID histogram indicating the signal strength variation.



TD-SCDMA OTA sync-DL ID analyzer

Mobile WiMAX Signal Analyzer

The Mobile WiMAX Signal Analyzer performs power measurements and spectrum measurements, as well as modulation analysis in a simple and easy manner with just a few key strokes.

It performs conformance testing according to the following standards providing a simple Pass/Fail indication on each test.

- IEEE 802.16e-2005
- WiBro (Korean Mobile WiMAX OFDMA Service)

RF and modulation analysis (option 26)		OTA Analysis (option 46)
Channel power	Constellation Spectral flatness EVM vs. subcarrier EVM vs. symbol Auto measure Power statistics CCDF	Preamble scanner Multipath profile Preamble power Trend
Occupied bandwidth		
Spectrum emission mask		
Spurious emissions		
Power vs. time (frame)		

Measurements

Channel power measures the total RF power, spectral density and peak to average ratio (PAR) of the signal in a Mobile WiMAX channel bandwidth.



WiMAX channel power

Occupied bandwidth measures the frequency bandwidth that contains 99% of the power, measuring the total integrated power and the occupied power.

The **spectrum emission mask (SEM)** compares the total power level within the defined carrier bandwidth and the given offset channels according to the standards.

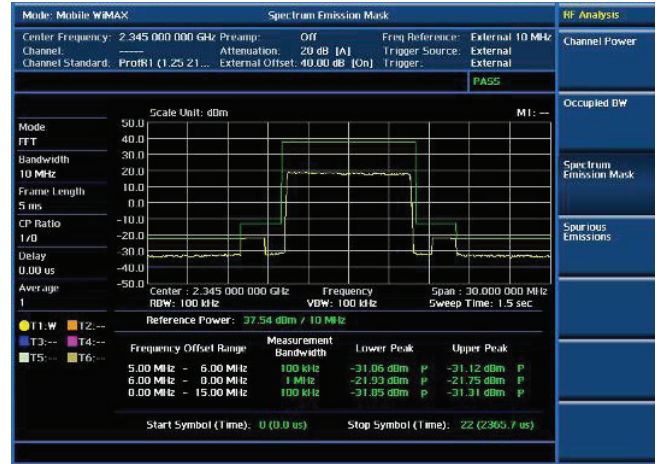

WiMAX spectrum emission mask

Spurious emissions identifies and determines the power level of spurious emissions in certain frequency bands.

Power vs. time (frame) verifies that the transmitter output power has the correct amplitude, shape, and timing according to the standards.

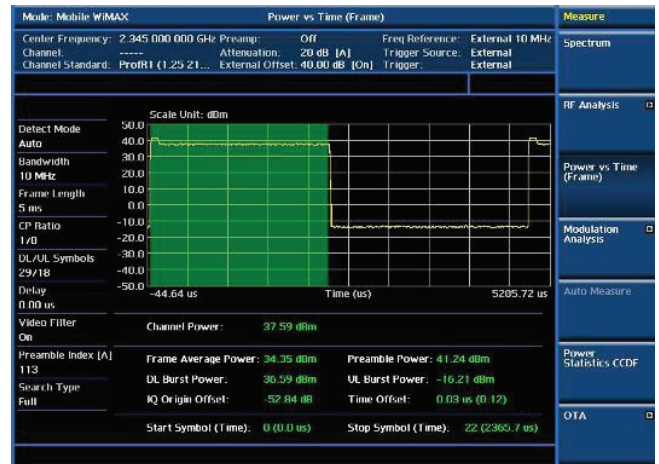

WiMAX Power vs. time (frame)

Mobile WiMAX Signal Analyzer (cont'd)

The **constellation** measurement displays the I-Q constellation diagram with modulation metrics to characterize the transmitter's modulation performance.



WiMAX constellation

EVM vs. sub-carrier shows the error vector magnitude representing the average constellation error of WiMAX OFDMA subcarriers.

EVM vs. symbol shows the error vector magnitude representing the average constellation error of WiMAX OFDMA symbols.

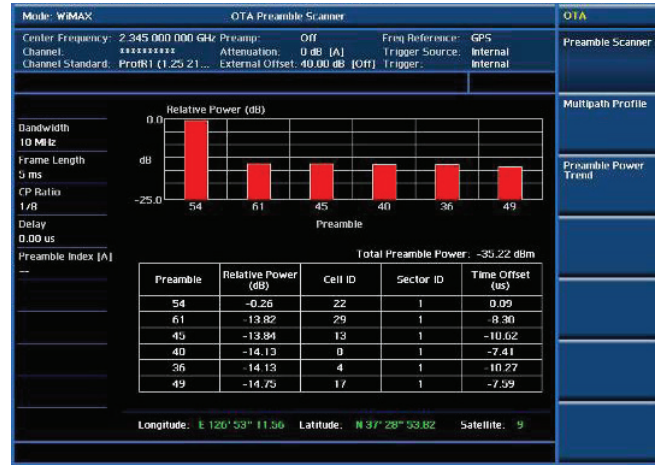

WiMAX OTA preamble scanner

Spectral flatness measures the flatness energy of the constellation according to WiMAX specification IEEE-816e.



WiMAX spectral flatness

The **complementary cumulative distribution function (CCDF)** characterizes the statistical power level distribution of WiMAX at any given time.

The **over the air (OTA) analyzer** provides three essential measurements: preamble scanner, multipath profile, and preamble power trend.

The OTA provides cell ID, sector ID and preamble at any point in the area served by the base station, including multipath profile indicating the strength of reflected signals; as well as carrier over interference histogram indicating the signal strength variation.

LTE-FDD Signal Analyzer

The LTE Signal Analyzer performs power measurements and spectrum measurements, as well as modulation analysis in a simple and easy manner with just a few key strokes.

It performs conformance testing according to the following standards providing a simple Pass/Fail indication on each test.

- 3GPP TS 36.104. Evolved Universal Terrestrial Radio Access (E-UTRA); Base Station (BS) Radio Transmission and Reception
- 3GPP TS 36.141. Evolved Universal Terrestrial Radio Access (E-UTRA); Base Station (BS) Conformance Testing
- 3GPP TS 36.211. Evolved Universal Terrestrial Radio Access (E-UTRA); Physical Channels and Modulation
- 3GPP TS 36.212. Evolved Universal Terrestrial Radio Access (E-UTRA); Multiplexing and Channel Coding.

RF and Modulation Analysis (option 28)		OTA Analysis (option 48)
Channel power	Data channel Summary	ID scanner
Occupied bandwidth	Control channel Summary	Multipath profile
Spectrum emission mask	Subframe summary	Control channel
ACLR	Frame summary	
Spurious emissions	Auto measure	
Power vs. time (Frame)	Power statistics CCDF	

Measurements

Channel power measures the power level and spectral density of the signal in a LTE channel bandwidth.

Occupied bandwidth measures the frequency bandwidth that contains 99% of the power, measuring the total integrated power and the occupied frequency.

The **spectrum emission mask (SEM)** compares the total power level within the defined carrier bandwidth and the given offset channels according to the standards.

Adjacent channel leakage power ratio (ACLR) measures the amount of interference, or power, in an adjacent frequency channel according to the standards.



LTE adjacent channel leakage power ratio

Spurious emissions identifies and determines the power level of spurious emissions in certain frequency bands.

Power vs. time (frame) measures the modulation envelope in the time domain, showing the power of each time slot in an LTE signal.



LTE channel power

LTE Signal Analyzer (cont'd)

Data channel summary measures the constellation for the specified resource block as well as the modulation accuracy of each PDSCH at the specified sub-frame.



LTE data channel summary

Control channel summary measures the constellation for the specified control channel as well as modulation accuracy of the control channel at the specified sub-frame.

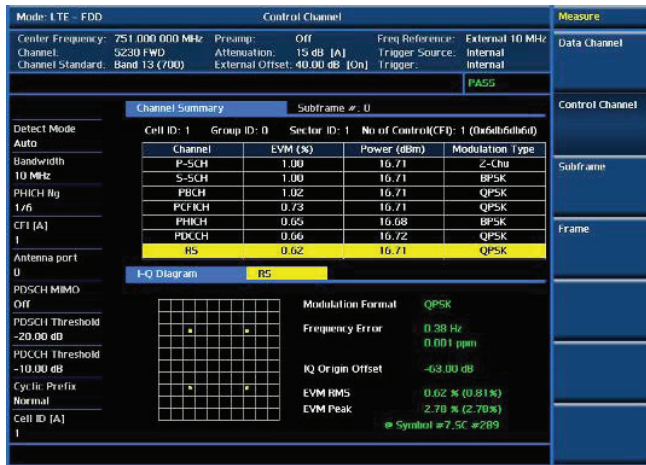

LTE control channel summary

Sub-frame summary measures the modulation accuracy of all the data and control channels at the specified sub frame.



LTE frame summary

Frame summary measures the modulation accuracy of all the data and control channels at of the frame.

The **complementary cumulative distribution function (CCDF)** characterizes the statistical power level distribution of LTE at any given time.

The **over the air analyzer** provides signal performance metrics at any point in the area served by the base station, including multipath profile indicating the strength of reflected signals; as well as RS histogram indicating the signal strength variation.



LTE OTA control channel

LTE – TDD Signal Analyzer

The LTE Signal Analyzer performs power measurements and spectrum measurements, as well as modulation analysis in a simple and easy manner with just a few key strokes.

It performs conformance testing according to the following standards providing a simple Pass/Fail indication on each test.

- 3GPP TS 36.104. Evolved Universal Terrestrial Radio Access (E-UTRA); Base Station (BS) Radio Transmission and Reception
- 3GPP TS 36.141. Evolved Universal Terrestrial Radio Access (E-UTRA); Base Station (BS) Conformance Testing
- 3GPP TS 36.211. Evolved Universal Terrestrial Radio Access (E-UTRA); Physical Channels and Modulation
- 3GPP TS 36.212. Evolved Universal Terrestrial Radio Access (E-UTRA); Multiplexing and Channel Coding

RF and Modulation Analysis (option 29)		OTA Analysis (option 49)
Channel power	Data channel Summary	ID scanner
Occupied bandwidth	Control channel Summary	Multipath profile
Spectrum emission mask	Subframe summary	Control channel
ACLR	Auto measure	
Spurious emissions	Power statistics CCDF	
Power vs. time (slot)		
Power vs. time (frame)		

Measurements

Channel power measures the total RF power, spectral density, and peak to average ratio (PAR) of the signal in a LTE channel bandwidth.

Occupied bandwidth measures the frequency bandwidth that contains 99% of the power, measuring the total integrated power and the occupied power.

Spectrum emission mask (SEM) compares the total power level within the defined carrier bandwidth and the given offset frequencies on both sides of the carrier frequency to levels allowed by the standards.



LTE spectrum emission mask

Adjacent channel leakage power ratio (ACLR) measures the amount of interference, or power, in adjacent frequencies and its ratios specified the standards.

Spurious emissions identifies and determines the power level of spurious emissions in certain frequency bands

Power vs. time (frame) measures the modulation envelope in the time domain, showing the power of each time slot in an LTE signal.

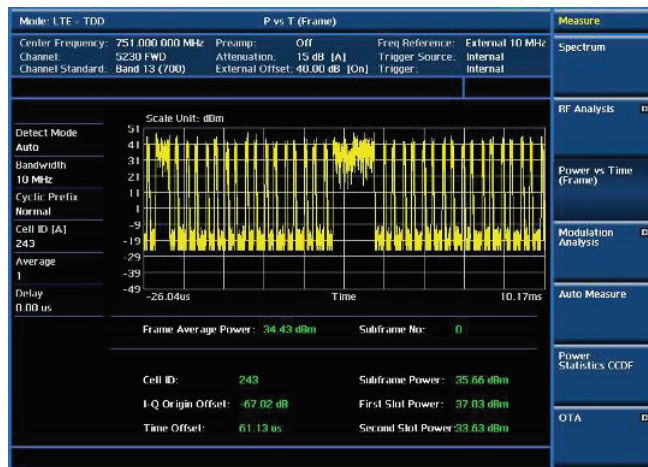

LTE power vs. time (frame)

Power vs. time (slot) measures the modulation envelope in the time domain, showing the signal rise and fall shape of LTE signal.



LTE occupied bandwidth

LTE – TDD Signal Analyzer (cont'd)

Data Channel Summary measures the constellation for the specified resource block as well as the modulation accuracy of each PDSCH at the specified subframe.



LTE data channel summary

Control channel summary measures the constellation for the specified control channels as well as modulation accuracy of the control channels at the specified subframe.

Subframe summary measures the modulation accuracy of all the data and control channels at the specified subframe.



LTE subframe summary

The **complementary cumulative distribution function (CCDF)** characterizes the statistical power level distribution of LTE at any given time.

The **over the air (OTA) analyzer** provides signal performance metrics at any point in the area served by the base station, including multipath profile indicating the strength of reflected signals; as well as RS histogram indicating the signal strength variation.



LTE OTA control channel

E1/T1 Analyzer

The JD7105B and JD745A perform a simple E1/T1 testing solution for the cell site's circuit-based backhaul.

The E1/T1 Analyzer provides enough flexibility to configure the PDH signal including its framing and coding, as well as the pattern that the instrument will be transmitting.

In addition, the JD7105B and JD745A are capable of automatically logging events.

E1 Analyzer ⁴	T1 Analyzer ⁴
Monitoring <ul style="list-style-type: none"> • Signal, sync loss • Alarm • Error BERT (PCM 31 only)	Monitoring <ul style="list-style-type: none"> • Signal, sync loss • Alarm • Error RX signal level BERT Loop



T1 RX signal level



E1 monitoring



T1 BERT



E1 BERT

4. See ordering information section for detailed options

Channel Scanner

The channel scanner function (option 12) can measure up to 20 independent channels, of any cellular technology, at any frequency channel or frequency.

The channel scanner function provides a simple view of the power level of each signal type.



Channel scanner

GPS Receiver and Antenna

The GPS Receiver (option 11) provides position location (latitude, longitude and altitude), as well as timing for highly accurate frequency measurement, allowing an independent verification of base station timing.



JD745A with GPS antenna

Application Software

The JD7105B and JD745A communicate with the PC application software JDViewer to retrieve measurements and perform post-processing analysis and reporting.

Features

- Communicates with the JD7105B and JD745A via LAN or USB.
- Retrieves measured or saved measurements.
- Exports measurement results.
- Generates and prints configurable reports.
- Edits measurement charts.
- Creates a composite file of multiple spectrogram traces.
- Analyzes measurement results allowing the assignment of multiple markers and limit lines.
- Creates user defined settings for channel power, occupied BW, spectrum emission mask, and adjacent channel power measurements.
- Registers or edits user definable cable types into the instrument's custom cable lists.
- Registers or edits user definable frequency bands into the instrument's custom bands lists.
- Creates or edits multisegment lines for insertion gain and loss measurements.
- Superimposes up to 4 traces on one measurement graph.
- Creates Auto Measure scenarios for multicarrier signal analysis.

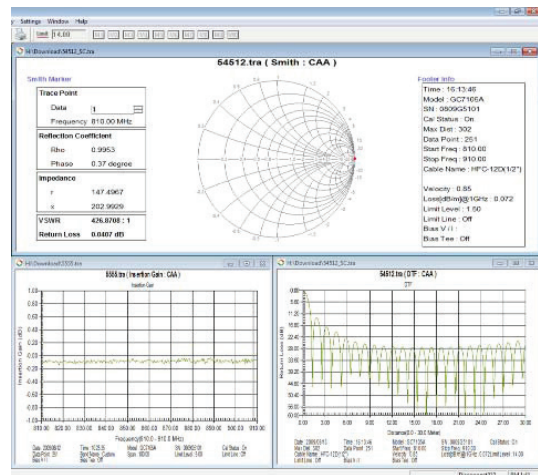

JDViewer, VSWR, DTF, Smith chart



JDViewer spectrum, demodulation

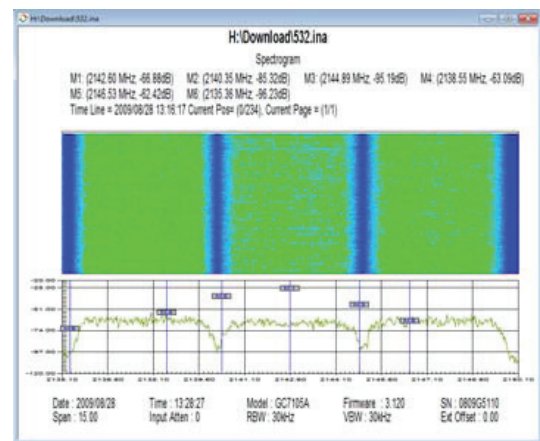

JDViewer spectrogram, RSSI

Base Station Analyzer Specifications

Features	JD7105B	JD745A
Spectrum Analyzer	100 kHz to 7.2 GHz	100 kHz to 4.0 GHz
Cable and Antenna Analyzer	25 MHz to 4.0 GHz	5 MHz to 4.0 GHz
2-Port Transmission Measurements	Standard	Option 001
Bias Tee (Internal)	Option 013	Option 002
Power Meter		
RF Power Meter (Internal)	Standard	Standard
RF Power Meter (External)	Required External Power Sensors	Required External Power Sensors
CW Signal Generator	Standard 3 dBm, -20 to -70 dBm (10 dB steps)	Option 003 0 dBm, -30 to -80 dBm (1 dB steps)
GPS Receiver and Antenna	Option 010	Option 010
Interference Analyzer	Option 011	Option 011
Channel Scanner	Option 012	Option 012
E1 Analyzer	Option 002	Option 004
T1 Analyzer	Option 003	Option 005
Signal Analyzer	20 MHz Demodulation Hardware	20 MHz Demodulation Hardware

Ordering Information

JD7105B		Notes
100 kHz to 7.2 GHz	Spectrum analyzer	
25 MHz to 4 GHz	Cable and Antenna Analyzer ¹	
10 MHz to 7.2 GHz	Power meter	Internal mode

NOTE: Upgrade options for the JD7105B use the designation JD7105BU before the respective last two-digit option number.

Options		
Description	Requirements	Part Number
E1 Analyzer ²		JD7105B002
T1 Analyzer ²		JD7105B003
GPS Receiver and Antenna		JD7108B010
Interference Analyzer ^{3,4}		JD7108B011
Channel Scanner		JD7108B012
Bias Tee		JD7105B013
cdmaOne/CDMA2000 Signal Analyzer		JD7108B020
EV-DO Signal Analyzer	Requires option 20	JD7108B021
GSM/GPRS/EDGE Signal Analyzer		JD7108B022
WCDMA Signal Analyzer		JD7108B023
HSDPA Signal Analyzer	Requires option 23	JD7108B024
TD-SCDMA Signal Analyzer		JD7108B025
Mobile WiMAX Signal Analyzer		JD7108B026
LTE - FDD Signal Analyzer		JD7108B028
LTE - TDD Signal Analyzer		JD7108B029
cdmaOne/CDMA2000 OTA Analyzer ⁴	Requires options 10 and 20	JD7108B040
EV-DO OTA Analyzer ⁴	Requires options 10 and 21	JD7108B041
GSM/GPRS/EDGE OTA Analyzer ⁴	Requires options 10 and 22	JD7108B042
WCDMA/HSDPA OTA Analyzer ⁴	Requires options 10 and 23/24	JD7108B043
TD-SCDMA OTA Analyzer ⁴	Requires options 10 and 25	JD7108B045
Mobile WiMAX OTA Analyzer ⁴	Requires options 10 and 26	JD7108B046
LTE OTA - FDD Analyzer ²	Requires options 10 and 028	JD7108B048
LTE OTA - TDD Analyzer ²	Requires options 10 and 029	JD7108B049

Standard Accessories	
Description	Part Number
JD 7100 Soft Carrying Case ⁵	JD71050341
AC/DC Power Adapter ⁵	G710550326
Cross LAN Cable (1.5 m) ⁵	G710550335
USB A to B Cable (1.8 m) ⁵	GC73050515
>1 GByte USB Memory ⁵	GC72450518
Rechargeable Lithium Ion Battery ⁵	G710550325
Automotive Cigarette Lighter 12 VCD Adapter ⁵	G710550323
JD7105B User's Manual and Application Software –CD	JD7108B361

1. Requires Calibration Kit

2. Requires Test Cable

3. Highly recommends adding JD7108B010

4. Highly recommends adding G70005035x or/and G7000-5036x

5. Standard accessories can be purchased separately.

Ordering Information (cont'd)

JD745A		Notes
100 kHz to 4 GHz	Spectrum analyzer	
5 MHz to 4 GHz	Cable and Antenna Analyzer ¹	
10 MHz to 4 GHz	Power meter,	Internal mode

Options

NOTE: Upgrade options for the JD745A use the designation JD745AU before the respective last three digit option number.

Description	Requirements	Part Number
2-Port Transmission Measurements ²		JD745A001
Bias Tee	Requires option 02	JD745A002
CW Signal Generator		JD745A003
E1 Analyzer ³		JD745A004
T1 Analyzer ³		JD745A005
GPS Receiver and Antenna		JD7108B010
Interference Analyzer ^{3,4}		JD7108B011
Channel Scanner		JD7108B012
cdmaOne/CDMA2000 Signal Analyzer		JD7108B020
EV-DO Signal Analyzer	Requires option 20	JD7108B021
GSM/GPRS/EDGE Signal Analyzer		JD7108B022
WCDMA Signal Analyzer		JD7108B023
HSDPA Signal Analyzer	Requires option 23	JD7108B024
TD-SCDMA Signal Analyzer		JD7108B025
Mobile WiMAX Signal Analyzer		JD7108B026
LTE Signal Analyzer		JD7108B028
LTE - TDD Signal Analyzer		JD7108B029
cdmaOne/CDMA2000 OTA Analyzer ⁴	Requires options 10 and 20	JD7108B040
EV-DO OTA Analyzer ⁴	Requires options 10 and 21	JD7108B041
GSM/GPRS/EDGE OTA Analyzer ⁴	Requires options 10 and 22	JD7108B042
WCDMA/HSDPA OTA Analyzer ⁴	Requires options 10 and 23/24	JD7108B043
TD-SCDMA OTA Analyzer ⁴	Requires options 10 and 25	JD7108B045
Mobile WiMAX OTA Analyzer ⁴	Requires options 10 and 26	JD7108B046
LTE - FDD OTA Analyzer ²	Requires options 10 and 028	JD7108B048
LTE - TDD OTA Analyzer ²	Requires options 10 and 029	JD7108B049

Standard Accessories

Description	Part Number
AC/DC Power Adapter ⁵	G710550326
Cross LAN Cable (1.5m) ⁵	G710550335
USB A to B Cable (1.8m) ⁵	GC73050515
>1 GByte USB Memory ⁵	GC72450518
Rechargeable Lithium Ion Battery ⁵	G710550325
Automotive Cigarette Lighter 12 VCD Adapter ⁵	G710550323
JD745A User's Manual and Application Software –CD	JD7108B361

1. Requires Calibration Kit
2. Requires Dual port Calibration Kit
3. Highly recommends adding JD7108B010
4. Highly recommends adding G70005035x or/and G7000-5036x
5. Standard accessories can be purchased separately.

Ordering Information (cont'd)

Optional Power Sensors	
Description	Part Number
Directional Power Sensor (peak and average power) Frequency: 300 MHz to 3.8 GHz Power: Average 0.15 to 150 W, Peak 4 to 400 W	JD731A
Directional Power Sensor (peak and average power) Frequency: 150 MHz to 3.5 GHz Power: Average/Peak 0.25 to 50 W	JD733A
Terminating Power Sensor (average power) Frequency: 20 MHz to 3.8 GHz Power: -30 to +20 dBm	JD732A
Terminating Power Sensor (peak power) Frequency: 20 MHz to 3.8 GHz Power: -30 to +20 dBm	JD734A
Terminating Power Sensor (peak and average power) Frequency: 20 MHz to 3.8 GHz Power: -30 to +20 dBm	JD736A
Optional Calibration Kits	
Y - Calibration Kit, Type-N(m), DC to 4 GHz, 50 Ω	JD72450509
Y - Calibration Kit DIN(m), DC to 4 GHz, 50 Ω	JD72450510
Dual Port Type-N Calibration Kit, 50 Ω Y - Calibration Kit, Type-N(m), DC to 4 GHz, 50 Ω Two Adapters Type-N(f) to Type-N(f), DC to 4 GHz, 50 Ω Two 1 m RF Test Cables, Type-N(m) to Type-N(m), DC to 18 GHz, 50 Ω	JD71050507
Dual Port DIN Calibration Kit, 50 Ω Y - Calibration Kit DIN(m), DC to 4 GHz, 50 Ω Two 1 m RF Test Cables, Type-N(m) to Type-N(m), DC to 18 GHz, 50 Ω Adapter Type-N(f) to DIN(f), DC to 4 GHz, 50 Ω Adapter Type-N(f) to DIN(m), DC to 4 GHz, 50 Ω Adapter DIN(f) to DIN(f), DC to 4 GHz, 50 Ω Adapter DIN(m) to DIN(m), DC to 4 GHz, 50 Ω	JD71050508
Optional RF Cables	
1.5 m (4.92 ft) Precision RF Cable, DC to 18 GHz N(m)-N(f), 50 Ω	G710050531
3.0 m (9.84 ft) Precision RF Cable, DC to 18 GHz N(m)-N(f), 50 Ω	G710050532
Optional Omni Antennas	
RF Omni Antenna 400 to 450 MHz	G700050351
RF Omni Antenna 450 to 500 MHz	G700050352
RF Omni Antenna 806 to 896 MHz	G700050353
RF Omni Antenna 870 to 960 MHz	G700050354
RF Omni Antenna 1710 to 2170 MHz	G700050355
Optional Yaggi Antennas	
RF Yaggi Antenna 806 to 896 MHz	G700050364
RF Yaggi Antenna 866 to 960 MHz	G700050365
RF Yaggi Antenna 1750 to 2390 MHz	G700050363

Ordering Information

Optional Adapters	
Description	Part Number
Adapter N(m) to DIN(f), DC to 4 GHz, 50 Ω	G710050571
Adapter DIN(m) to DIN(m), DC to 4 GHz, 50 Ω	G710050572
Adapter N(m) to SMA(f), DC to 18 GHz, 50 Ω	G710050573
Adapter N(m) to BNC(f), DC to 1.5 GHz, 50 Ω	G710050574
Adapter N(f) to N(f), DC to 4 GHz, 50 Ω	G710050575
Adapter N(f) to DIN(f), DC to 4GHz, 50 Ω	G710050577
Adapter N(f) to DIN(m), DC to 4 GHz, 50 Ω	G710050578
Adapter DIN(f) to DIN(f), DC to 4 GHz, 50 Ω	G710050579
Optional E1/T1 Test Cables	
RJ45 to Y Bantam Cable	G710050317
RJ45 to Y BNC Cable	G710050318
RJ45 to 4 Alligator Clips	G710050319
Miscellaneous	
Attenuator 40 dB, 100 W DC to 4 GHz (Unidirectional)	G710050581
JD740 Soft carrying-case	JD74050341
Hard carrying-case	JD71050342
JD7100 Back Pack carrying-case	JD71050343
JD740 Backpack carrying-case	JD74050343
External battery charger	G710550324
JD7105B User's Manual – Printed version	JD7105B362
JD745A User's Manual – Printed version	JD745A362



Contact Us **+1 844 GO VIAVI**
(+1 844 468 4284)

To reach the Viavi office nearest you,
visit viavisolutions.com/contacts.

© 2015 Viavi Solutions, Inc.
Product specifications and descriptions in this
document are subject to change without notice.
JD7105B-JD745A-ds-cpo-tm-ae
30168315 901 0511