

# R&S® ZNA

## VECTOR NETWORK ANALYZER

Masters the most challenging measurement tasks



Product Brochure  
Version 04.00

**ROHDE & SCHWARZ**

Make ideas real



# CONTENTS

## Overview

**At a glance**  
▶ page 4

**Key facts and benefits**  
▶ page 6

**State-of-the-art user interface**  
▶ page 8

**Rear panel connections**  
▶ page 10

## Highlights

**Unique operating concept  
with two touchscreens**  
▶ page 12

**Top-class hardware components**  
▶ page 14

**Unprecedented RF quality**  
▶ page 18

**Hardware options**  
▶ page 20

**Principle of operation of 4-port R&S®ZNA**  
▶ page 22

**Principle of operation of 2-port R&S®ZNA**  
▶ page 24

**The right calibration for every test scenario**  
▶ page 26

**System integration, personalization and  
connectivity**  
▶ page 30

## Measurement methods

**Compression point measurements**  
▶ page 33

**Intermodulation measurements on  
amplifiers and mixers**  
▶ page 34

**Noise figure measurements on  
amplifiers and mixers**  
▶ page 36

**Pulsed measurements – fast and simple**  
▶ page 38

**Mixer measurements easier than ever**  
▶ page 40

**Spectrum analysis with multichannel view**  
▶ page 42

**Time domain analysis and signal integrity  
measurements**  
▶ page 43

**Phase-controlled source measurements**  
▶ page 44

## Applications

**Passive device characterization**  
▶ page 47

**High-power amplifier and LNA testing**  
▶ page 48

**Receiver and LNB characterization**  
▶ page 49

**T/R module and radar AESA testing**  
▶ page 50

**Signal integrity testing**  
▶ page 51

**Antenna measurements – the perfect fit**  
▶ page 52

**mmWave measurements**  
▶ page 54

**TVAC testing and satellite TVAC testing**  
▶ page 58

**Multiport extensions**  
▶ page 59

## Additional information

**Ordering information**  
▶ page 60

The terms HDMI and HDMI High-Definition Multimedia Interface, and the HDMI Logo are trademarks or registered trademarks of HDMI Licensing, LLC in the United States and other countries.

# AT A GLANCE

Offering outstanding RF characteristics, a unique and comprehensive hardware architecture and a DUT oriented operation concept, the R&S®ZNA high-end vector network analyzer makes demanding measurements easier than ever before.

The R&S®ZNA features exceptional stability, low trace noise and excellent raw data, making it a perfect choice for development and production applications that require high accuracy, e.g. for developing and producing components and modules for A&D and satellite applications.

The R&S®ZNA offers four internal, phase coherent sources, allowing independent control of the signal's frequency at each port as well as phase measurements on mixers. It provides two internal local oscillator (LO) sources, a true multichannel receiver architecture, pulse generators and modulators, an internal combiner, selectable reference

signal access points, preamplifiers and comprehensive trigger and synchronization capabilities. These hardware features make the R&S®ZNA a universal, compact test system for active and passive device characterization. Even intermodulation measurements on mixers and receivers can be performed without external signal sources, minimizing test time and simplifying test configuration. Thanks to the phase coherent digital sources and receivers, no reference mixers are needed for mixer phase measurements, and test setups are configured just as easily as for non-frequency-converting S-parameter measurements.

The analyzer's DUT-centric operating concept makes it possible to achieve the desired setup at an unrivaled speed. Users can control sophisticated measurements at a glance with dedicated dialogs that show the setup schematics and all of the essential test parameters.

The R&S®ZNA characterizes low-noise amplifiers (LNA), receivers, frequency-converting DUTs and transmit/receive (T/R) modules precisely and efficiently; the DUT needs to be connected only once. The instrument provides numerous software applications, e.g. for intuitive configuration of group delay and spectrum measurements.

Various menu-based calibration procedures are available to help users calibrate even complicated setups efficiently and reliably. All the calibration methods supported by the R&S®ZNA can be expanded using a special calibration technique referred to as R&S®SMARTerCal. This technique combines system error correction with absolute power level correction, minimizing the number of calibration steps even with active DUTs, which involve considerable measurement effort.

Users can operate the R&S®ZNA via two independent touchscreens

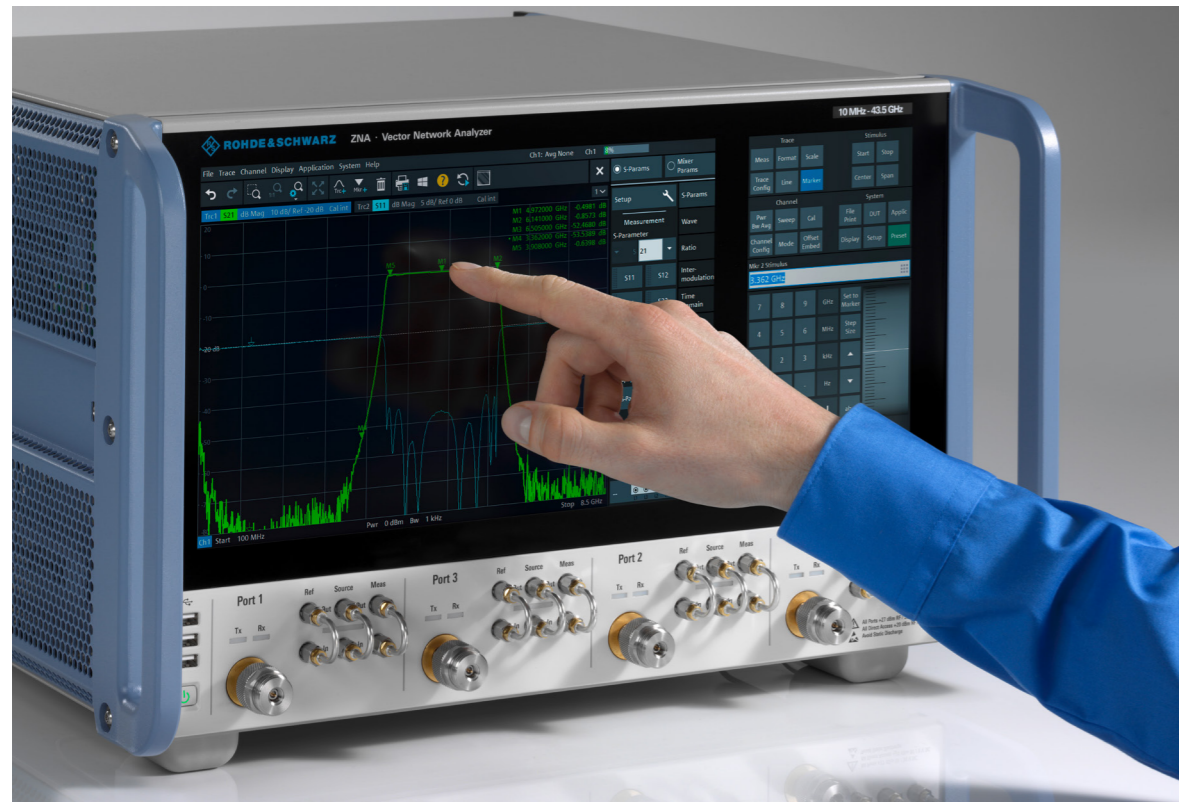

## R&S®ZNA models

	100 kHz	10 MHz	26.5 GHz	43.5 GHz	50 GHz	67 GHz	70 GHz	72 GHz	110 GHz
R&S®ZNA26-B16 direct source and receiver access		<b>R&amp;S®ZNA26</b> 2-port and 4-port, 1, 2 and 4 sources <sup>1)</sup>							
R&S®ZNA43-B16 direct source and receiver access		<b>R&amp;S®ZNA43</b> 2-port and 4-port, 1, 2 and 4 sources <sup>1)</sup>							
		<b>R&amp;S®ZNA50</b> 2-port and 4-port, 1, 2 and 4 sources <sup>1)</sup>							
		<b>R&amp;S®ZNA67</b> 2-port and 4-port, 1, 2 and 4 sources <sup>1)</sup>							
						Overrange (standard)	Overrange (optional)		<b>R&amp;S®ZNA67EXT</b> Single sweep up to 110 GHz

<sup>1)</sup> With all models, the internal (second) LO generator is optionally available at the rear panel as third or fifth source respectively (up to 26.5 GHz).

# KEY FACTS AND BENEFITS

## Four internal phase coherent sources

- ▶ Compact multiple source setups
- ▶ Convenient phase measurements on mixers
- ▶ Phase coherent DUT stimulation and true differential measurements

## Two internal LOs

- ▶ Excellent trace noise as low as 0.005 dB (spec.) and 0.002 dB (typ.) at 100 kHz IF bandwidth (IFBW)
- ▶ Fast mixer measurements
- ▶ More accurate phase results due to parallel signal sampling
- ▶ Rear panel LO output for mmWave systems and general purpose applications

## Eight truly parallel measurement receivers

- ▶ Measurements on multipath DUTs and antenna arrays, use of analyzer as a powerful core in antenna test systems

## Flexible signal routing and path access

- ▶ Internal combiner for intermodulation and embedded LO converter group delay measurements
- ▶ Reference signal access before or after source step attenuator for low trace noise even with very low stimulus signals (e.g. for high gain DUTs)
- ▶ Direct IF access for antenna test systems with external up/down conversion
- ▶ Rear panel LO output and direct IF input for compact mmWave test setups: 2/4-port mmWave converter setups with 2/4-port R&S®ZNA, without additional external source

## Four internal pulse modulators

- ▶ Two-tone and bidirectional pulsed signal measurements

## Phase measurements on mixers without reference mixers

- ▶ Simple mixer tests in a compact setup

## Noise figure measurements on amplifiers and mixers

- ▶ Internal preamplifier (R&S®ZNAxx-B302/-B312) for low-noise DUTs
- ▶ Quickset configuration dialog for fast and optimized amplifier noise figure measurements

## Spectrum analysis option

- ▶ DUT characterization and spurious search without reconnecting the DUT to a spectrum analyzer

## Group delay measurements on frequency converters with embedded LOs

- ▶ Reliable, straightforward satellite receiver measurements

## High dynamic range

- ▶ Dynamic range of 147 dB (typ.) and up to 170 dB (typ., with options)
- ▶ Characterization of high-rejection filters
- ▶ Short test times and low trace noise

## Outstanding receiver sensitivity

- ▶ Noise floor < -120 dBm (spec.)<sup>1)</sup>
- ▶ Noise level down to -157 dBm (typ., with options)<sup>2)</sup>

## Exceptional source and receiver linearity

- ▶ 0.03 dB receiver linearity in the range from -50 dBm to 0 dBm
- ▶ Accurate amplifier testing even at very high and low power levels

## Wide power sweep range

- ▶ Power sweep range of 100 dB (typ.)
- ▶ Versatile compression measurements

## Low trace noise

- ▶ Trace noise of < 0.001 dB (at 1 kHz IF bandwidth)
- ▶ Accurate, highly reproducible measurements

## DUT-centric operating concept

- ▶ Easy startup, short configuration times

## Compact instrument, quiet operation

- ▶ Acoustic noise as low as 42 dB(A)
- ▶ Small footprint, low noise pollution

<sup>1)</sup> Specification, without options, at 1 Hz IF bandwidth.

<sup>2)</sup> Applies for port 2, at 1 Hz IF bandwidth, with R&S®ZNAxx-B16 reversed coupler operation and R&S®ZNAxx-B302 preamplifier options. (xx designates the R&S®ZNA model: R&S®ZNA26, R&S®ZNA43, R&S®ZNA50 and R&S®ZNA67.)



# STATE-OF-THE-ART USER INTERFACE

## Menu bar

For operation with a mouse or finger

## Undo/Redo

Cancels or restores the last operations

## Toolbar

Frequently used functions such as zoom, new trace, new marker, print

## More than 100 channels and traces

- ▶ Straightforward display of complex measurements
- ▶ Simultaneous, independent display of multiple test setups; display of large number of traces; arrangement of traces, channels and diagrams in any desired combination

## Three front panel USB ports for connecting

- ▶ Storage media
- ▶ Keyboard and mouse
- ▶ Calibration units
- ▶ Power sensors

## Direct source monitor access (option)

- ▶ Direct reference signal access before or after internal mechanical source step attenuator
- ▶ Low trace noise even with very small output power levels

## Context-sensitive help

## 12.1" touchscreen with state-of-the-art GUI

## Softkeys and soft panel

- ▶ Logically structured menus: everything in view without scroll bar
- ▶ All parameters for a test setup presented in straightforward GUI dialogs
- ▶ Measured traces can be dragged and dropped

## Touch panel

Instrument control and display of macros

## Soft roll key with locking function

## Status LEDs

Calibration status, remote operation, etc.

## Direct source and receiver access (option)

## Status LEDs for each port indicating

- ▶ TX/RX operation
- ▶ Input active



# REAR PANEL CONNECTIONS

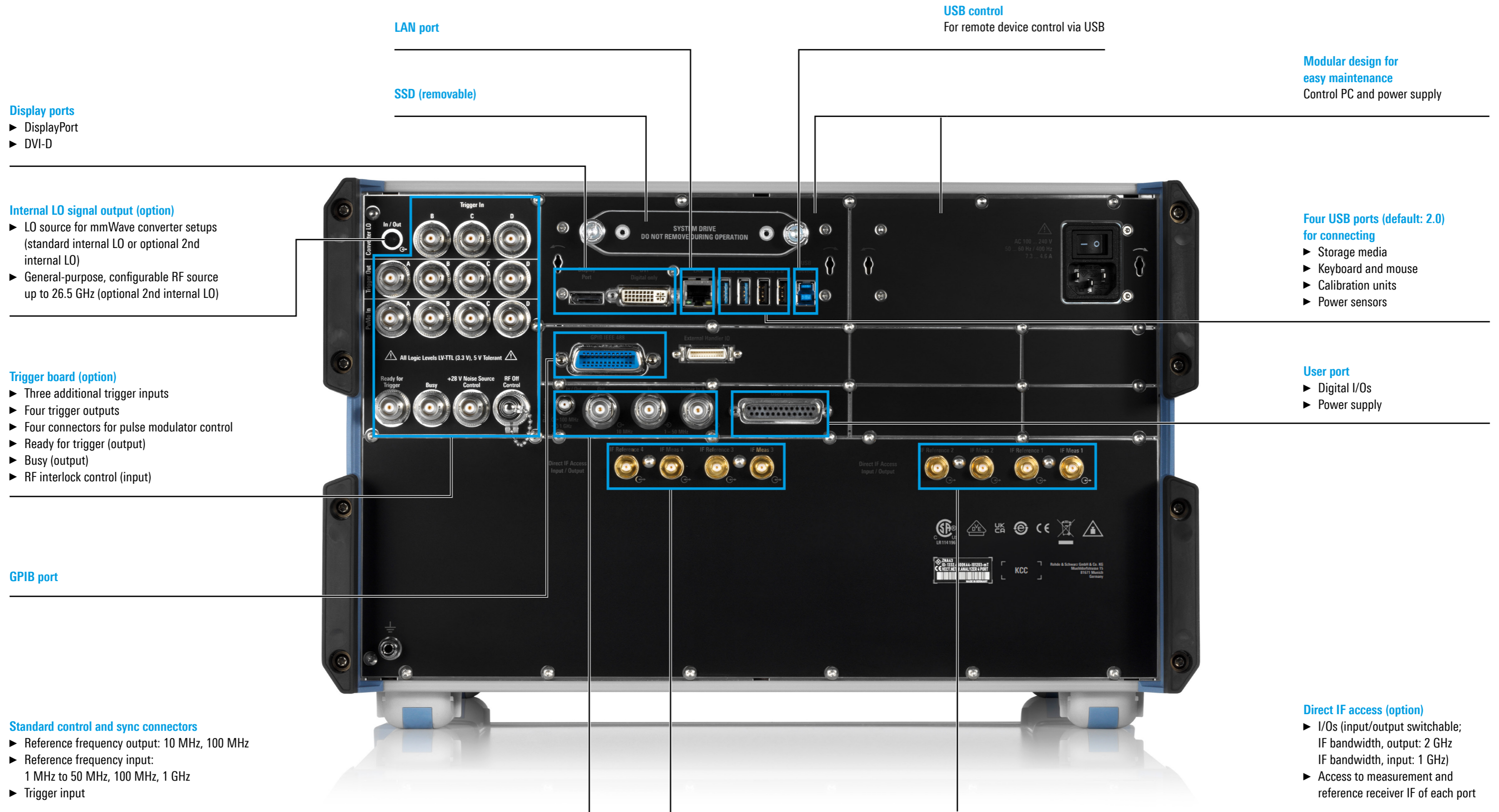

# UNIQUE OPERATING CONCEPT WITH TWO TOUCHSCREENS

Keep things in perspective with all-in-one GUIs and optimize your setups with single parameter adjustment.

## Operation using touch gestures

Users can operate the R&S®ZNA via two independent touchscreens:

- ▶ Innovative control panel on the right instead of mechanical keys which can wear out over time
- ▶ 12.1" touch display on the left for configuring and displaying measurements

The dual-screen operating concept offers utmost flexibility in configuring measurements. Touch gestures are used to zoom, move traces and add markers. Traces, channels and diagrams can be dragged and dropped to arrange them in any desired combination. The control panel on the right can, among other things, be used to display macros, remote control commands and auxiliary tools.

## Three alternatives to arrive at the desired setup

### 1. Conventional approach

For general configuration and for basic measurement quantities, such as S-parameters, power and ratios, users can take the conventional approach to configure measurements on the R&S®ZNA. They can select the parameters for a desired setup, e.g. power parameters, the number of points, and the measurement type and measurement quantity.

## Zoom function



Users can zoom with a simple finger gesture or by dragging the mouse. The background color of the screen can be configured as desired.

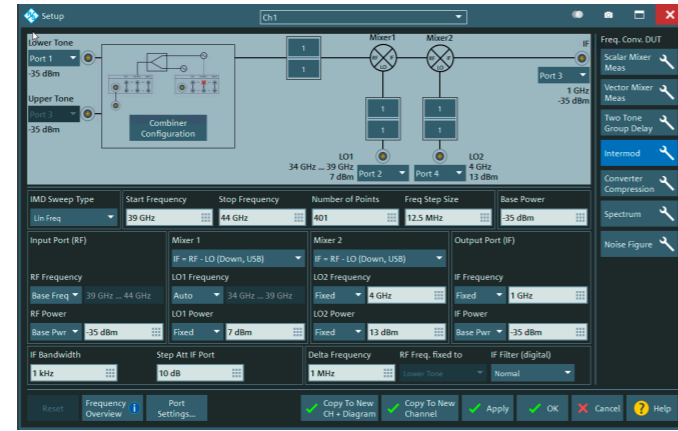

All-in-one dialog for intermodulation measurement on a double converting receiver

### 2. All-in-one dialogs – keeping track even of sophisticated setups

For complex setups, such as intermodulation on mixers and noise figure tests, all-in-one dialogs show all of the key parameters otherwise distributed among several menus on a single display. The hardware is configured interactively using graphic elements. Test parameters such as frequencies, power levels and bandwidths are set via pull-down menus and input fields. Users see all relevant information at a glance, not missing a single parameter. Measurement traces for any desired measurement quantities can then be dragged and dropped to any desired position.



Control of the R&S®ZNA via touch panel. Users benefit from all-in-one dialogs, which provide a clear overview of all key parameters and help to keep track of the overall measurement configuration.

### 3. Step by step to the desired setup: the DUT-centric wizard

Another alternative is a step-by-step, DUT-centric approach. In a first step, the user defines the type of DUT (e.g. mixer) and its key data (e.g. maximum/minimum input power level and frequency ranges). The wizard then prompts the user, in easy-to-follow steps, to define the required settings and measurement parameters, using DUT-specific terms (e.g. "Conversion Gain RF to IF" or "Feedthrough LO to IF"). The analyzer automatically creates and displays the associated channels and traces.

## DUT-centric measurement configuration

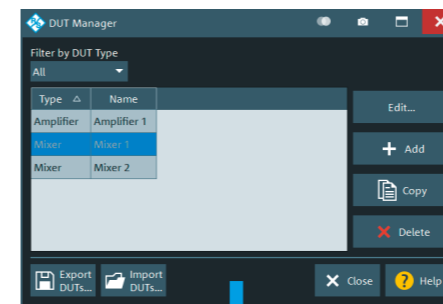

Based on the DUT type, the user is prompted to select and configure the desired measurements in a step-by-step process. The required channels and traces, e.g. for measuring LO feedthrough, are automatically created.

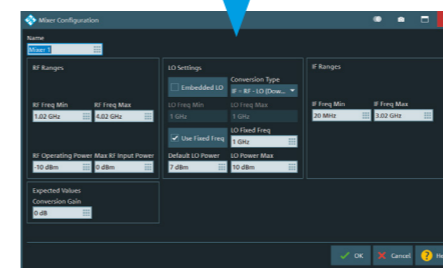

## Trace analysis functions

A wide variety of trace analysis functions provide a clear overview of key parameters:

- ▶ Ten markers per trace, including analysis functions and conversion to desired unit
- ▶ Automatic bandwidth measurement on filters
- ▶ Limit and ripple check with configurable pass/fail indication
- ▶ Statistical trace analysis including maximum, minimum, RMS, peak-to-peak and compression point
- ▶ Equation editor for complex trace mathematics

## Fast switching between instrument setups

With the R&S®ZNA, multiple setups can be kept in memory simultaneously, allowing users to switch quickly between measurement tasks. This feature is especially advantageous with DUTs that deliver a variety of complex results, as it provides a quick overview and simplifies operation.





The R&S®ZNA comes with an extensive range of hardware options

## TOP-CLASS HARDWARE COMPONENTS

The R&S®ZNA comes with an extensive range of hardware options, allowing customized configuration for the intended use.

### 4-port model with four internal sources

The R&S®ZNA is available with up to four internal sources (R&S®ZNAxx-B3<sup>1)</sup> option, 3rd and 4th internal source for 4-port models). The user benefits from a powerful, compact system that can even perform intermodulation measurements on mixers and receivers with two converter stages. The digitally controlled, phase coherent and phase repeatable sources allow phase measurements on mixers and converters without external reference mixers.

### 2-port models with two internal sources

Options for second internal RF/LO sources (R&S®ZNAxx-B52), an integrated combiner (R&S®ZNAxx-B212), the rear panel LO output connector (26.5 GHz) and preamplifiers (R&S®ZNAxx-B302/-B312/-B501/-B511) make the R&S®ZNA an extremely compact and effective tool for comprehensive characterization of DUTs with two test ports. Especially the following measurements are supported:

- ▶ Intermodulation on amplifiers
- ▶ Noise figure test
- ▶ Group delay test on (high-gain) embedded LO converters for satellite applications or T/R modules (using R&S®ZNA-K9 two-tone technique)
- ▶ Mixer test (with LO up to 26.5 GHz, rear panel LO out connector)

<sup>1)</sup> xx designates the R&S®ZNA model (R&S®ZNA26, R&S®ZNA43, R&S®ZNA50 and R&S®ZNA67).

### Direct IF access

When used as inputs, the R&S®ZNA-B26 direct IF access ports provide direct access to the internal IF signal paths. The IF frequency is selectable with 1 GHz bandwidth, which provides a high degree of freedom for system integration, especially when integrating the analyzer into antenna test systems with external mixers. When used as outputs, the R&S®ZNA-B26 ports make it possible to record and analyze data using external equipment.

### Synchronization and trigger capabilities

The R&S®ZNA offers a comprehensive range of synchronization and trigger features such as diverse trigger inputs and outputs, e.g. for test status indication, definition of criteria for logical decision-making, RF power shutdown, flexible test sequence control in pulsed measurements, synchronization of external devices, and for timing control during test sequences in production. The R&S®ZNA-B91 option (trigger and control I/O board) acts as an interface for the input and output of signals.

### Second internal LO source and mmWave converter LO output

The second internal LO source (R&S®ZNA-B5 option for 4-port models, R&S®ZNAxx-B52 second source and second LO option for 2-port models) allows two ports to receive signals at different frequencies. This means that two frequencies can be measured simultaneously, e.g. the RF and the IF signal of a mixer, making the measurement twice as fast and reducing trace noise.

The optional R&S®ZNA-B8 mmWave converter LO output makes the analyzer's internal LO available on the rear panel, e.g. for feeding mmWave converters connected to the R&S®ZNA<sup>2)</sup>. Alternatively, the second LO can be used as a general-purpose RF source, e.g. for external mixers.

<sup>2)</sup> Configuration of the R&S®ZNA-B8 output for use with mmWave converters requires the R&S®ZNA-K8 option (mmWave converter support).

(The R&S®ZNA-B8 rear panel LO output is limited to the frequency range from 10 MHz to 26.5 GHz independent from using the standard or optional second internal LO.)

### Eight internal pulse generators and four internal pulse modulators

Eight pulse generators and four modulators make it possible to generate pulsed two-tone signals and bidirectional pulsed signals, e.g. for intermodulation measurements on T/R modules. The pulse generators are enabled with any of the following options: R&S®ZNAxx-B4n (internal pulse modulator for port n) and R&S®ZNA-B91 (trigger and control I/O board). The trigger and control I/O board alone enables use of the internal pulse generators to control internal or external pulse modulators (e.g. to generate pulses with a duration of < 40 ns). Point-in-pulse measurements are delivered by the base unit; pulse profile measurements are added with the R&S®ZNA-K7 option.



### Internal combiner

A switchable internal combiner (R&S®ZNAxx-B213 for 4-port models, R&S®ZNAxx-B212 for 2-port models) combines the signals from source 1 and 3 (or a second internal source for 2-port models) to provide a two-tone signal at port 1. This enables intermodulation measurements and embedded LO group delay measurements (with R&S®ZNA-K9 option) to be carried out without additional external equipment.

### Direct source and receiver access, source monitor (reference signal) access before or after source step attenuator

The R&S®ZNAxx-B16 direct source and receiver access option provides direct access to the source and receiver paths. On the one hand, this yields highest sensitivity as the internal coupler can be bypassed, thus avoiding the coupler attenuation, on the other hand, it supports e.g. external high-power test setups. Testing

at low stimulus levels is further improved with the R&S®ZNAxx-B501/-B511 low-power spurious reduction option. An isolation amplifier provides optimized spurious reduction, delivering excellent signal purity for power levels down to -110 dBm and below.

The R&S®ZNAxx-B161 and R&S®ZNAxx-B163 direct source monitor access options make the R&S®ZNA even more versatile. They provide direct access to the reference signal, i.e. they allow the reference signal to be picked up before the internal source step attenuator. With the step attenuator set to high attenuation for very small output power levels, picking up the reference signal before the source step attenuator will provide a reference signal strong enough to deliver low-noise traces, thus providing high accuracy even with high gain DUTs such as satellite and radar modules.

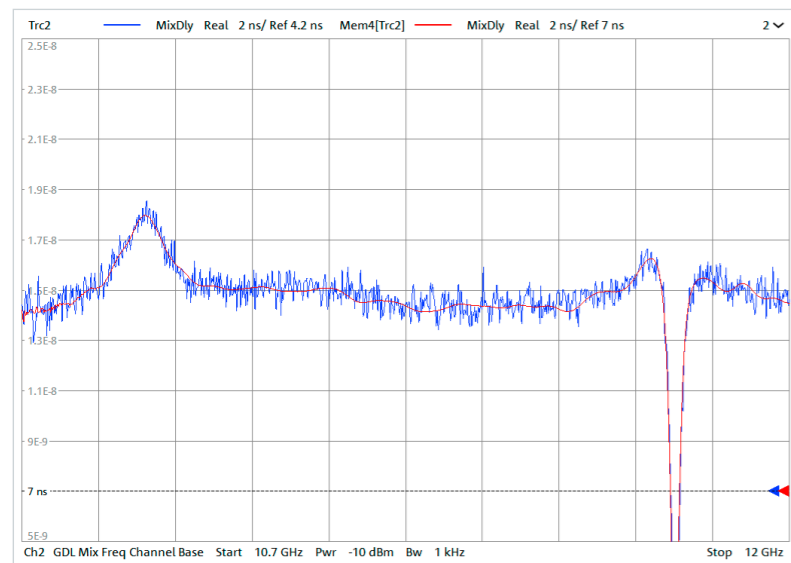

Group delay measurement on a 60 dB gain embedded LO converter (IFBW = 10 kHz for both measurements, shown as blue and red traces). Blue trace: poor trace noise with the low-level reference signal picked up after the source step attenuator. Red trace: minimized trace noise with the reference signal picked up before the source step attenuator, yielding a high signal-to-noise ratio at the reference receiver.

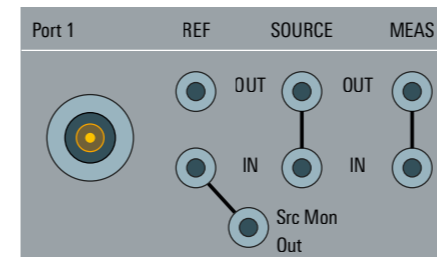

R&S®ZNAxx-B16 front panel jumper position required for direct source monitor access (R&S®ZNAxx-B161/-B163)

### Internal preamplifier supports noise figure measurements

The R&S®ZNAxx-B302/-B312 option is a switchable low-noise amplifier (LNA) with filtering inserted upstream of the port 2 measurement receiver. With selectable gain up to 30 dB, even low gain/low noise figure DUTs can be accurately characterized.

### R&S®ZNAxx-B161 and R&S®ZNAxx-B163 options

When the R&S®ZNAxx-B16 reference signal front panel jumper (ports 1 and 3) is reconnected from the standard position (Ref Out) to the direct source monitor output (R&S®ZNAxx-B161/R&S®ZNAxx-B163), the reference signal will be picked up before the source step attenuator.

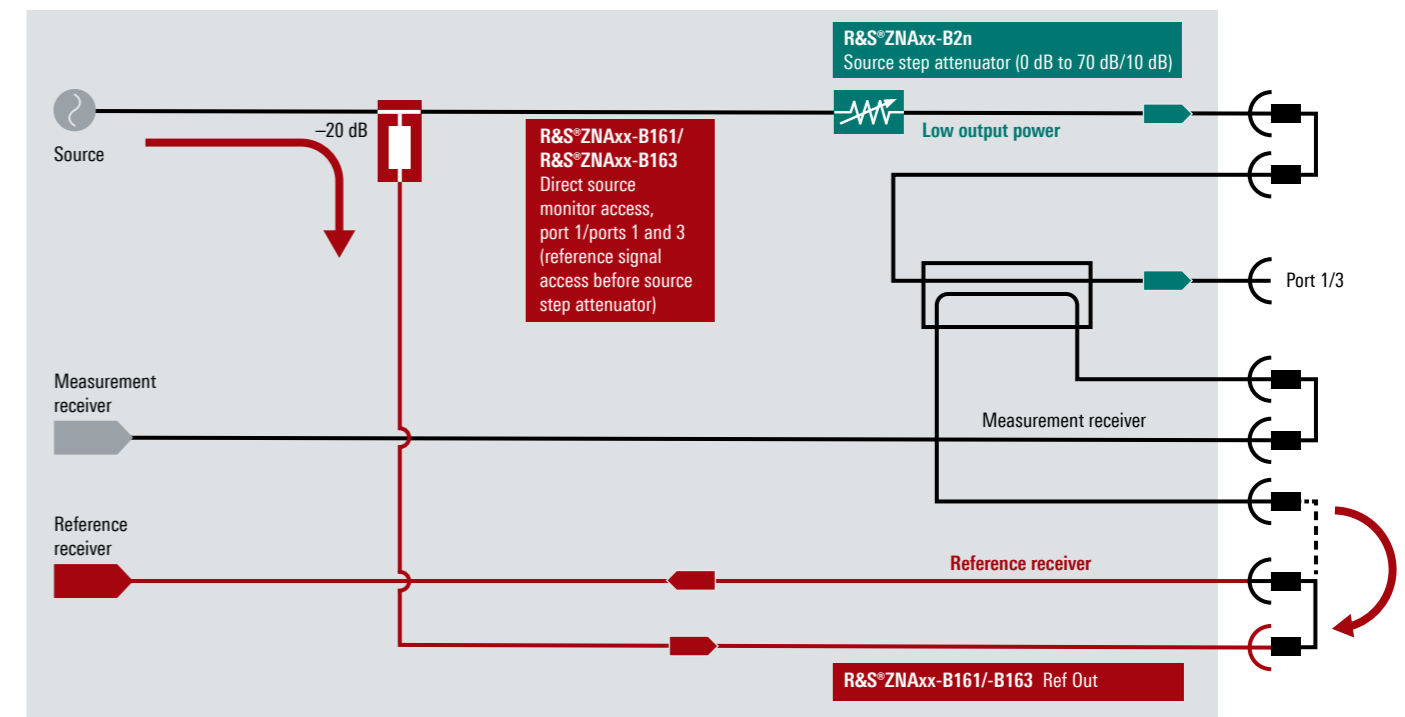

# UNPRECEDENTED RF QUALITY

Wide signal-to-noise ratio and exceptional stability for accurate results

## Wide dynamic and power sweep range

The very high dynamic range of the R&S®ZNA allows the characterization of high-rejection filters. With high output powers and a wide power sweep range, the instrument can analyze the large- and small-signal behavior of amplifiers in a single sweep:

- ▶ Dynamic range: 147 dB (typ.)<sup>1)</sup>, > 129 dB (specified, without options)
- ▶ Maximum attainable dynamic range: 170 dB (typ.)<sup>2)</sup>
- ▶ Electronically controlled power sweep range up to 100 dB (typ.), interruption-free up to 40 dB (typ.)

<sup>1)</sup> With R&S®ZNAxx-B3n option.

<sup>2)</sup> Requires: maximum output power, R&S®ZNAxx-B16 option, R&S®ZNAxx-B3n option, reversed coupler configuration at receive port, and 1 Hz IF bandwidth.

## High stability for reliable results

The R&S®ZNA test set and receivers feature excellent temperature and long-term performance stability. Combined with other decisive RF features, this offers outstanding reliability and accuracy.

- ▶ Trace noise of 0.001 dB (RMS, at 1 kHz IF bandwidth)
- ▶ Temperature stability of 0.01 dB/K and 0.1°/K
- ▶ Reliable measurement of high power levels thanks to 0.1 dB receiver compression for 10 dBm power level at test port
- ▶ High dynamic range of sources due to source step attenuators up to 70 dB and electronic power sweep range up to 100 dB
- ▶ Excellent receiver linearity of < 0.05 dB across an extremely wide range of -50 dBm to 0 dBm

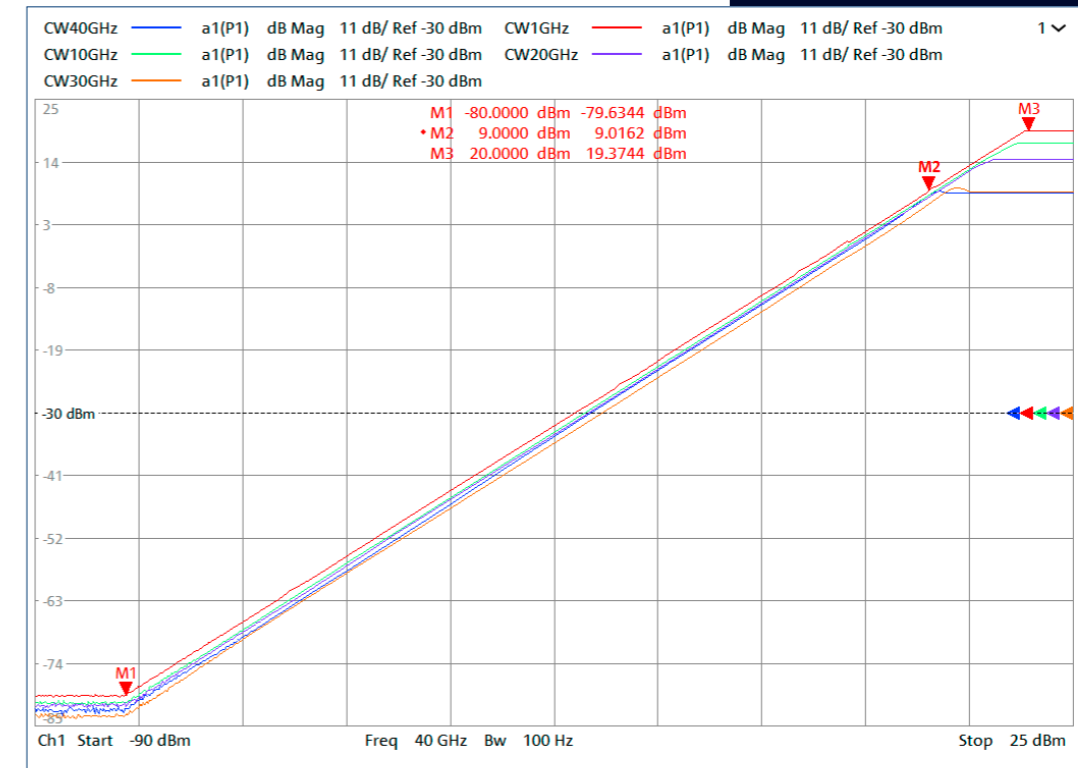

Maximum power sweep range of up to 100 dB

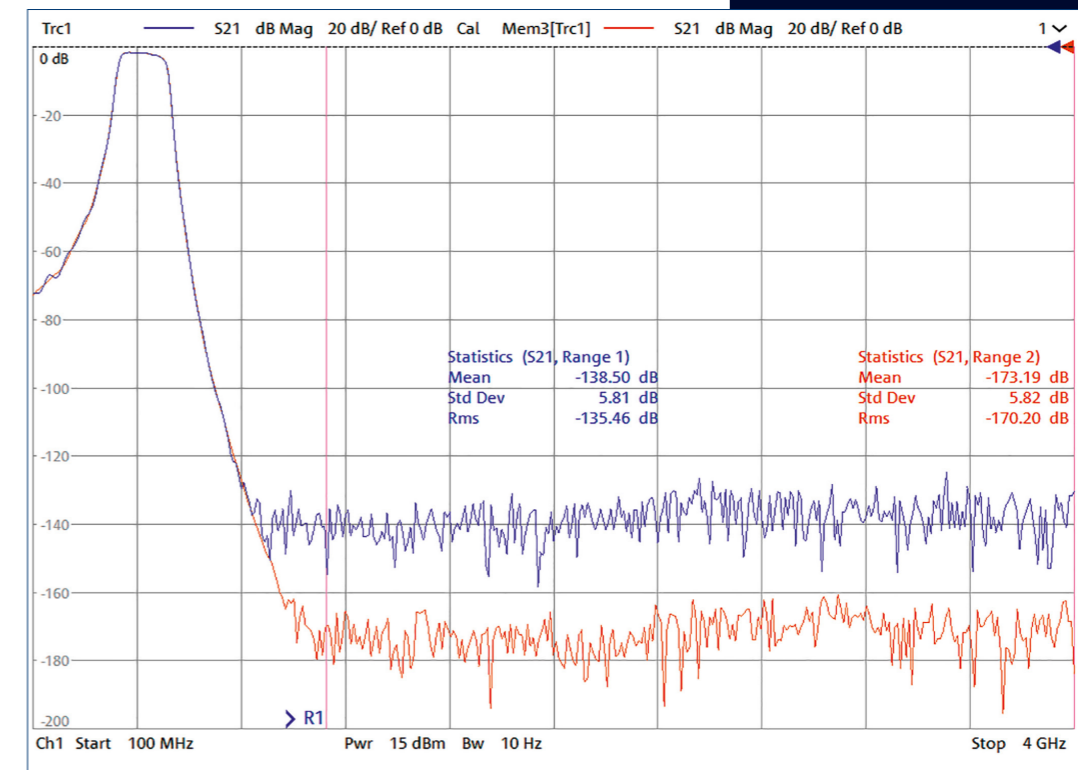
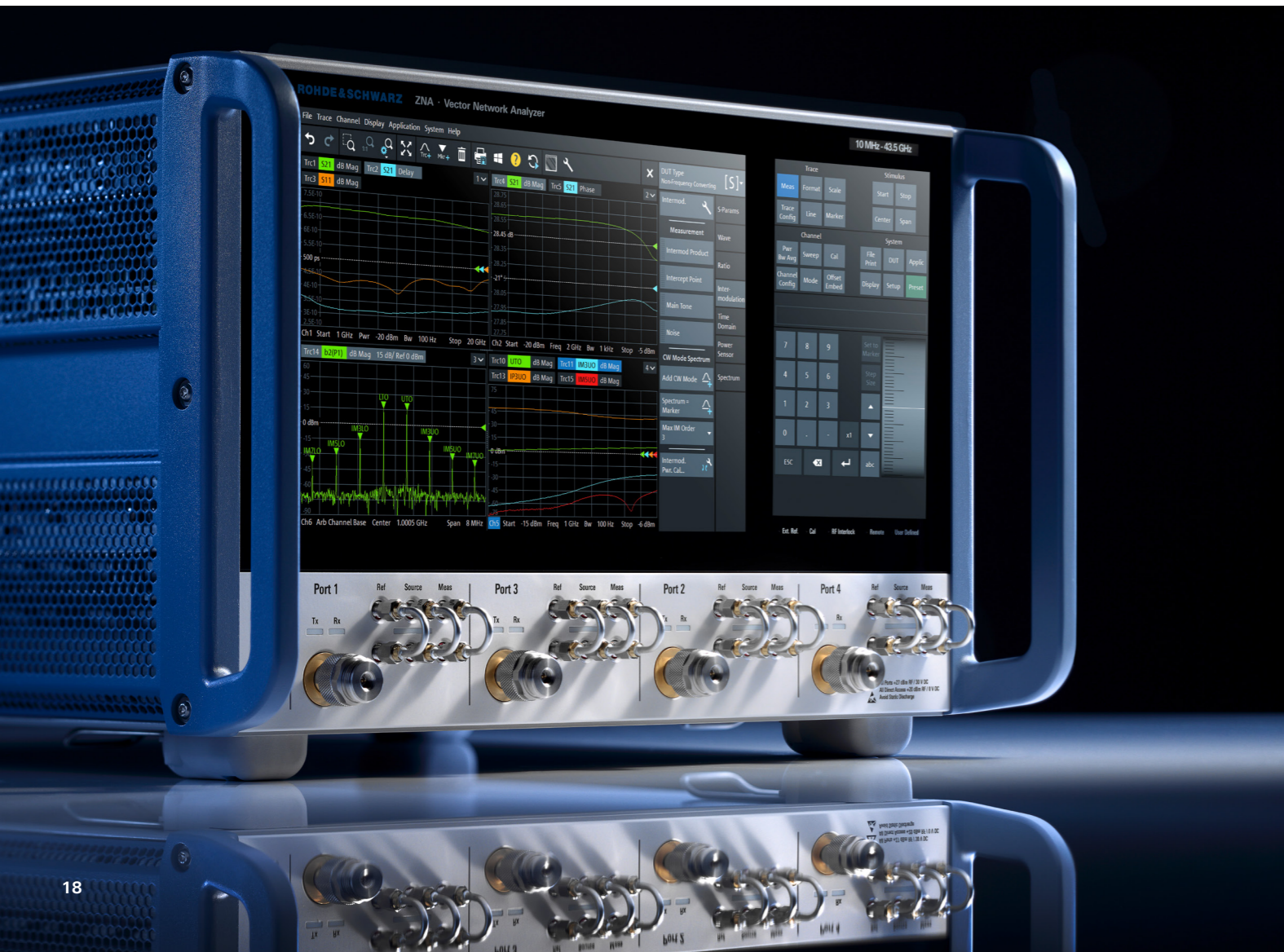

Dynamic range: at maximum specified output power, without options (blue trace: at 10 Hz IF bandwidth); at maximum specified output power, in reversed coupler mode, with receiver step attenuator set to 0 dB (red trace: at 1 Hz IF bandwidth)

# HARDWARE OPTIONS

Description	Applications and benefits	Hardware option <sup>1)</sup>
<p>Direct source and receiver access</p> <ul style="list-style-type: none"> <li>▶ With start frequency down to 100 kHz<sup>2)</sup></li> <li>▶ Supports reversed coupler configuration</li> </ul>	<ul style="list-style-type: none"> <li>▶ Facilitates external test setups for high-power measurements across a wide frequency range</li> <li>▶ Reversed coupler configuration increases dynamic range and reduces system noise figure</li> </ul>	R&S®ZNAxx-B16
R&S®ZNA 4-port model with up to four internal sources	<ul style="list-style-type: none"> <li>▶ No external sources means flexible configuration and short measurement times</li> <li>▶ Flexible-to-configure, compact test setups, e.g. for DUTs with two converter stages</li> </ul>	R&S®ZNAxx-B3 <sup>3)</sup>
<p>2nd internal LO source for 4-port R&amp;S®ZNA model</p> <ul style="list-style-type: none"> <li>▶ For simultaneous measurement of two different frequencies (e.g. RF and IF signal of mixers)</li> <li>▶ Additional RF source (in combination with R&amp;S®ZNA-B8 mmWave converter LO output)</li> </ul>	<ul style="list-style-type: none"> <li>▶ Fast mixer and converter measurements</li> <li>▶ Very low trace noise with frequency-converting measurements</li> <li>▶ General-purpose RF source up to 26.5 GHz (e.g. to provide LO signal for external mixers)</li> </ul>	R&S®ZNA-B5
2nd internal RF source and 2nd internal LO source for 2-port R&S®ZNA model	<p>R&amp;S®ZNA with 2 test ports supports:</p> <ul style="list-style-type: none"> <li>▶ Intermodulation measurements</li> <li>▶ Group delay on embedded LO (satellite) converters (LNB), T/R modules</li> <li>▶ Mixer tests (with R&amp;S®ZNA-B8 for LO)</li> </ul>	R&S®ZNA-B52 <sup>3)</sup>
Four/eight true receivers (no multiplexing)	<ul style="list-style-type: none"> <li>▶ Reliable multichannel phase and antenna measurements</li> </ul>	Provided as standard in base unit (direct receiver access requires R&S®ZNAxx-B16)
Direct IF access, I/O ports switchable as inputs or outputs, with 2 GHz analog IF bandwidth (output) and 1 GHz analog IF bandwidth (input)	<p>Enhanced flexibility and sensitivity, e.g. when used in antenna test systems</p> <ul style="list-style-type: none"> <li>▶ Provides direct access to up to eight phase coherent receivers</li> <li>▶ Supports compact mmWave converter setups</li> </ul>	R&S®ZNA-B26
Eight internal pulse generators and four internal pulse modulators	<ul style="list-style-type: none"> <li>▶ For measurements on pulsed signals and for flexible system integration</li> <li>▶ R&amp;S®ZNA-B7 increases the number of wave quantities that can be captured in parallel with R&amp;S®ZNA-K7</li> </ul>	R&S®ZNA-K7, R&S®ZNAxx-B4n <sup>4)</sup> , R&S ZNA-B7
Enhanced trigger and control functions (three additional trigger inputs, four trigger outputs, four pulse control I/O ports, ready for trigger, busy, RF interlock control) <sup>5)</sup>	<ul style="list-style-type: none"> <li>▶ Universal system adaptation and easy system integration</li> <li>▶ High reference frequency for low phase noise</li> </ul>	R&S®ZNA-B91

<sup>1)</sup> xx designates the R&S®ZNA model (R&S®ZNA26, R&S®ZNA43, R&S®ZNA50 and R&S®ZNA67).

<sup>2)</sup> Between 100 kHz and 10 MHz, the internal coupler can only be used to a limited extent. Here, external directional components and recalibration are required.

<sup>3)</sup> The 2-port R&S®ZNA models come with one RF source as standard, the 4-port R&S®ZNA models with two RF sources.

<sup>4)</sup> n designates the port number (1/2/3/4).

<sup>5)</sup> 1 GHz reference frequency input provided as standard.

Description	Applications and benefits	Hardware option <sup>1)</sup>
Source step attenuators, 0 dB to 70 dB in 10 dB steps	<ul style="list-style-type: none"> <li>▶ Generation of low-power stimulus signals down to -110 dBm</li> </ul>	R&S®ZNAxx-B2n <sup>4)</sup>
Receiver step attenuators, 0 dB to 35 dB in 5 dB steps	<ul style="list-style-type: none"> <li>▶ Compression-free measurements with input power up to destruction limit of +27 dBm</li> </ul>	R&S®ZNAxx-B3n <sup>4)</sup>
Rear panel output for internal LO signal (when the 2nd internal LO source (R&S®ZNA-B5) is installed, it is available at the output); provides up to +25 dBm output power	<ul style="list-style-type: none"> <li>▶ Support of compact mmWave converter setups (2/4-port mmWave converter setups with 2/4-port R&amp;S®ZNA) without additional external source</li> <li>▶ General-purpose RF source up to 26.5 GHz</li> <li>▶ High source power not affected by hardware options installed in the R&amp;S®ZNA frontend</li> </ul>	R&S®ZNA-B8
Switchable internal combiner, provides a two-tone signal at port 1	<ul style="list-style-type: none"> <li>▶ Intermodulation measurements</li> <li>▶ Embedded LO converter group delay measurements (R&amp;S®ZNA-K9 option)</li> <li>▶ Mixer measurements with 2-port R&amp;S®ZNA models (R&amp;S®ZNA-B8 as 26.5 GHz LO source)</li> </ul>	R&S®ZNAxx-B213 for 4-port models, R&S®ZNAxx-B212 for 2-port models
Direct source monitor (reference signal) access; when reconnecting the R&S®ZNAxx-B16 reference signal front panel jumper to the direct source monitor output (R&S®ZNAxx-B161/-B163), the signal to the reference receiver can be picked up before the source step attenuator	<ul style="list-style-type: none"> <li>▶ Low trace noise even with low output power levels as typically encountered with high gain DUTs</li> <li>▶ Monitoring of source output power simultaneously at source monitor output and test port</li> </ul>	R&S®ZNAxx-B161, R&S®ZNAxx-B163
Low-noise preamplifier at port 2 measurement receiver, switchable low-noise amplifier (LNA) with selectable gain and integrated filter	<ul style="list-style-type: none"> <li>▶ Noise figure measurements on amplifiers and converters</li> <li>▶ Up to 30 dB gain for low gain/low noise figure DUTs</li> </ul>	R&S®ZNAxx-B302 <sup>6)</sup> , R&S®ZNAxx-B312
Low-power spurious reduction, isolation amplifier at port 1 measurement receiver; low-power spurious level is reduced down to -110 dBm	<ul style="list-style-type: none"> <li>▶ Optimized spurious suppression</li> <li>▶ Signal purity with very low stimulus levels</li> <li>▶ Reliable high gain amplifier/converter testing</li> </ul>	R&S®ZNAxx-B501 <sup>6)</sup> , R&S®ZNAxx-B511
MIPI RF frontend (RFFE) and general-purpose input/output (GPIO) interface, including voltage and current measurements	<ul style="list-style-type: none"> <li>▶ Integrated, configurable control of mobile phone frontend chipsets</li> <li>▶ Additional digital and analog I/O</li> </ul>	R&S®ZNA-B15

<sup>6)</sup> R&S®ZNAxx-B302 and R&S®ZNAxx-B501 options provoke increased receiver sensitivity for other option(s). If the enhanced sensitivity conflicts with country-specific export regulations, R&S®ZNAxx-B312 and R&S®ZNAxx-B511 options can be ordered instead.

# PRINCIPLE OF OPERATION OF 4-PORT R&S®ZNA

R&S®ZNAxx-B16 option: Direct source and receiver access (frequency extension down to 100 kHz, supports reversed coupler operation)

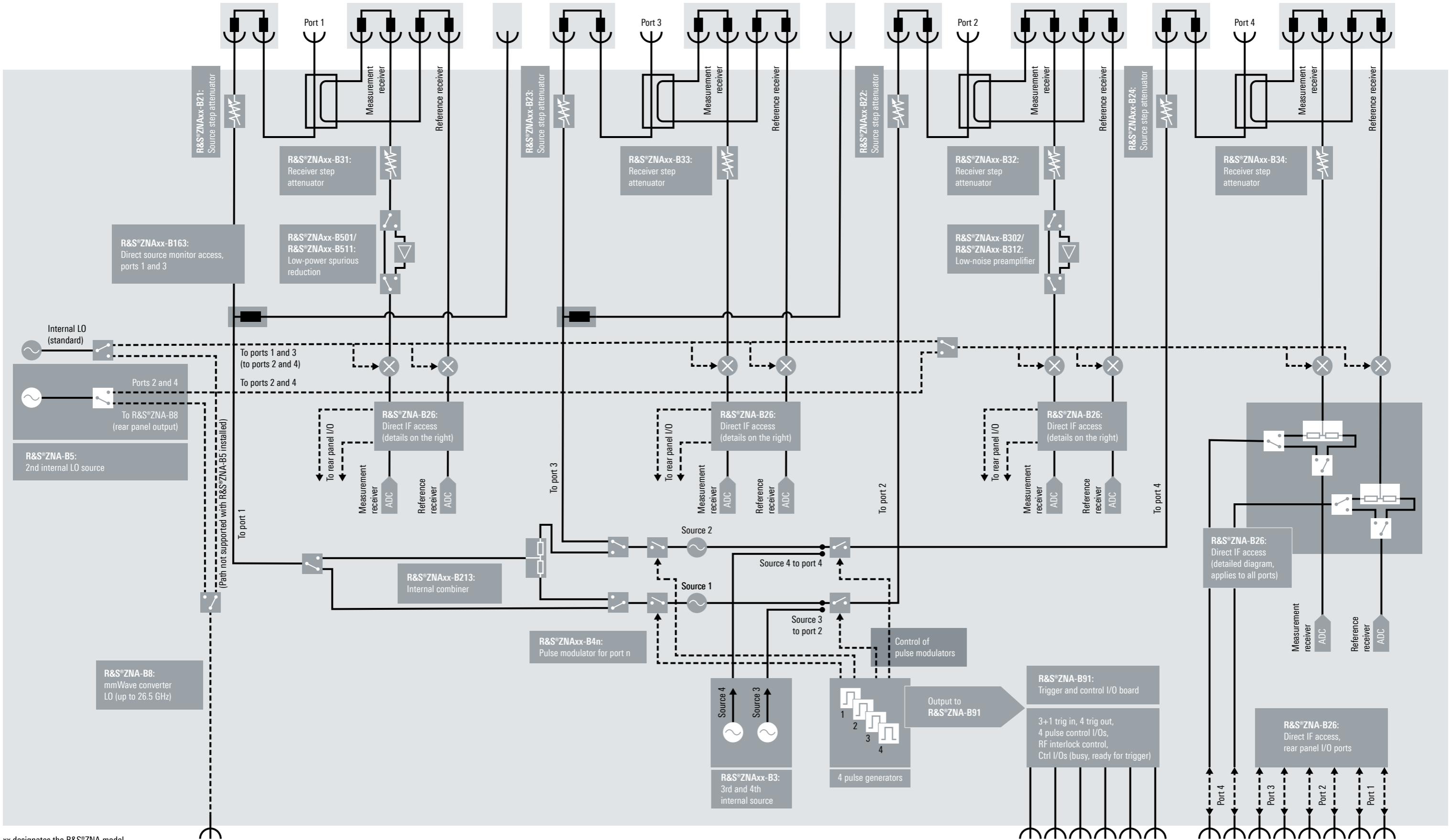

xx designates the R&S®ZNA model.  
n designates the port number (1/2/3/4).

# PRINCIPLE OF OPERATION OF 2-PORT R&S®ZNA

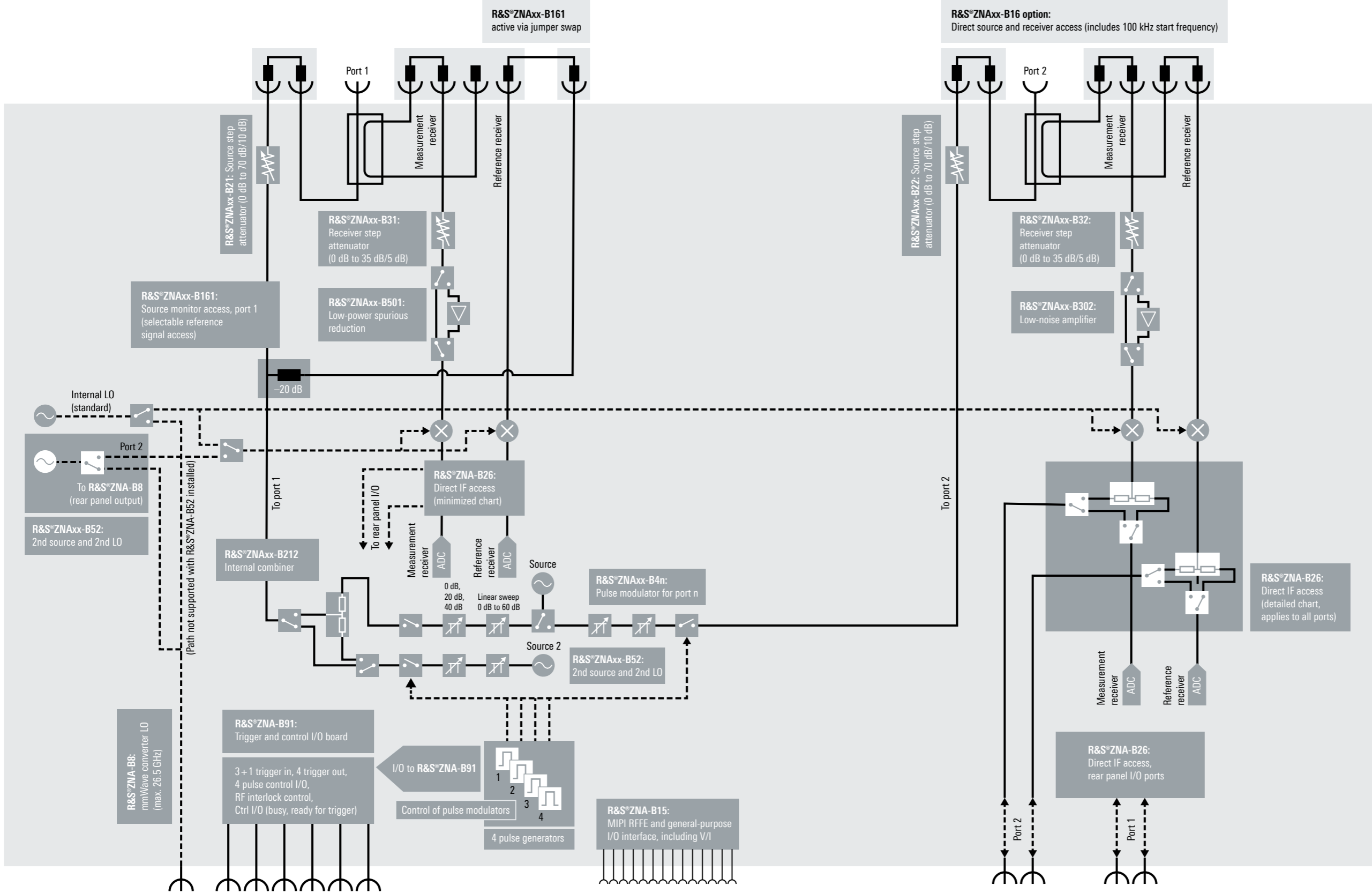

xx designates the R&S®ZNA model.  
n designates the port number (1/2).

# THE RIGHT CALIBRATION FOR EVERY TEST SCENARIO

The R&S®ZNA offers a wide range of calibration techniques for coaxial and non-coaxial systems, such as wave guides and PCBs. Various deembedding techniques offer solutions for in-fixture and on-wafer calibration. The R&S®SMARTerCal concept combines system error correction with receiver and flatness calibration, guiding the operator efficiently to the optimal result.

## Full calibration with only three standards – faster, simpler, more precise

- ▶ Through, reflect, line/line, reflect, line (TRL/LRL) for on-wafer applications, waveguides and coaxial DUTs
- ▶ Through, reflect, match (TRM) for applications in test fixtures and on wafers
- ▶ Through, short, match (TSM) and through, open, match (TOM) as alternatives to TOSM, for reduced calibration effort

## Calibration for DUTs using a mix of connectors

The classic TOSM method does not provide direct calibration of test setups for DUTs equipped with different types of connectors at the input and output. The R&S®ZNA offers two alternatives to provide this type of calibration.

## UOSM calibration

Unknown through, open, short, match (UOSM) calibration is the smartest way to overcome the above problem. It involves about the same effort as TOSM calibration. A through connection with unknown parameters is required, i.e. a reciprocal (but otherwise more or less arbitrary) two-port, e.g. a simple and cost-effective adapter.

## Adapter removal method

As an alternative, the R&S®ZNA offers classic adapter removal calibration. This method is very robust, but requires considerably more calibration steps.

## R&S®SMARTerCal – get ready for active device testing

Calibrating the absolute power levels of the sources and receivers is indispensable in order to reliably test amplifiers, mixers and T/R modules. However, this process is time-consuming. The R&S®ZNA uses a special calibration technique referred to as R&S®SMARTerCal, which radically simplifies calibration. R&S®SMARTerCal combines the information gained from system error correction (e.g. TOSM, UOSM) with the information obtained through absolute power level calibration (wave quantities in terms of amplitude and phase). This means that the absolute power levels of the sources and receivers are calibrated already during system error correction, taking into account port mismatch. For absolute output power level calibration, the power sensor needs to be connected to a test port only once. The calibration values for all other sources and receivers are derived from the calibration values for that specific test port. This significantly reduces calibration time and effort.

The calibrate all function of R&S®SMARTerCal can even combine all measurement channels and configurations of the current setup in a single user-guided calibration wizard. All calibration steps are summarized in tabular form, each calibration item (such as individual calibration standards, power meter, calibration unit) needs to be connected only once – the most efficient way to ensure reliable results with minimum effort even with extended test setups.

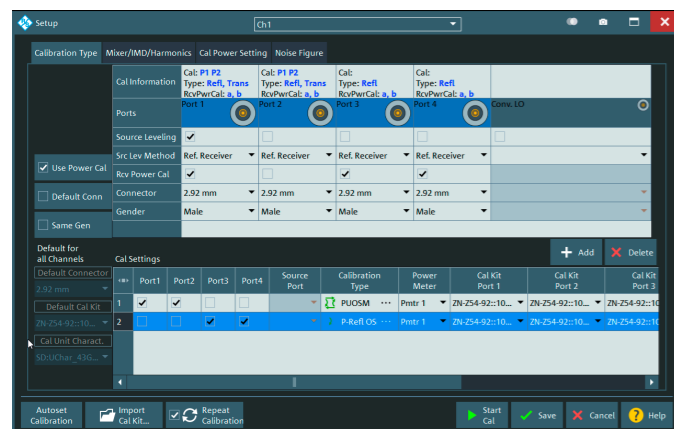

The R&S®SMARTerCal merges system error correction, receiver power calibration and absolute source level calibration.

## Digital automatic level control (ALC)

The configurable digital ALC sets the source power precisely to the target value, using a reference signal that can be derived from any point in the test setup. This means that the source power is adjusted, in a minimum of time, to the output power of a preamplifier in the test setup or to the output power of the DUT. Power fluctuations, e.g. due to drift effects, are eliminated. This provides stable, reproducible power conditions over long test cycles.

Unlike wideband diode detectors, the ALC uses the digitally filtered results delivered by the reference receivers. As a result, the source power is adjusted to the power of the wanted signal (fundamental) without any distortion otherwise introduced by harmonics, for example. Users can configure the ALC parameters, such as the ALC IF bandwidth, to achieve the optimum balance of accuracy and control time.

## ALC controlled high-power setups

With the reference signal picked up at any point in the test setup, the R&S®ZNA controls the source to keep output power from booster amplifiers stable with high precision. Settling effects are equalized in milliseconds and measurements can be triggered immediately after power changes.

## ALC ensures accuracy at very low levels

The analyzer's excellent receiver linearity of < 0.05 dB across a wide range from -50 dBm to 0 dBm results in high level accuracy even when measuring very low power levels. The receivers are calibrated at a higher power level that is optimal for the power sensor. The power level is then reduced, while power accuracy is maintained thanks to the reference receivers' high linearity and ALC control.

## Amplifier IM and converter test

For measurements requiring two or more signals, (intermodulation test, R&S®ZNA-K9 converter group delay test) all sources involved are controlled for reliable active device characterization.

## Digital automatic level control (ALC)

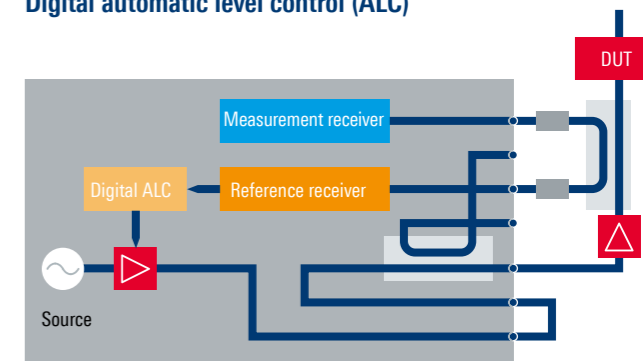

ALC operation: in a high-power setup with an external preamplifier and a directional coupler, the source power is controlled to match the preamplifier output power. This compensates for drift effects, making the output power very precise and stable.

## ALC deembedding for in-fixture and on-wafer noise figure tests

The ALC accounts for deembedded virtual networks, inserted or removed after power calibration. This way, the reference plane for the power control is shifted at the end of probes for the on-wafer test or into test fixtures. The latter is particularly useful for noise figure measurement for in-fixture/on-wafer chip tests.

## ALC with pulsed signals

The finite measurement and control time of the ALC is typically longer than the short pulse duration time. To find the optimal setting, the ALC and pulse parameters can be matched, and users can select whether to carry out ALC control and measurement on the same or on successive pulses.

## Power offset correction for short pulses

The point-wise ALC cycle may result in a total control and measurement time per point that exceeds the duration of the short pulses. As an alternative, R&S®ZNA offers a sweep-wise power offset correction, where the power is corrected after the completion of each sweep. Thus, the measurement IFBW is decisive for the time per point, without time offset.

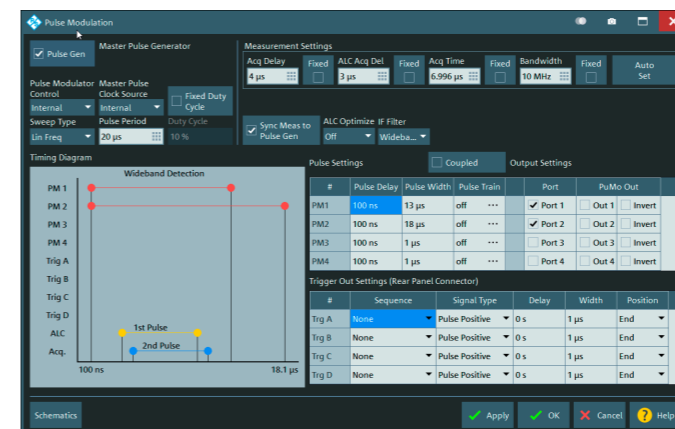

The configuration of ALC supported measurements under pulsed condition allows detailed settings to match ALC and pulse parameters. For instance, to allow short pulses, ALC control and measurement can be set to successive pulses.

## Fast deembedding for impedance matching using virtual networks

Coaxial and balanced components, such as surface acoustic wave (SAW) filters used in mobile phone frontends, are specified together with the networks that match them to the impedance of the surrounding circuit. The R&S®ZNA can embed the DUT into virtual matching networks to provide realistic conditions by simulating the DUT installed in its operational environment. The R&S®ZNA offers a choice of predefined matching network topologies. If values of individual network elements are edited, the R&S®ZNA immediately recalculates the network and embeds the DUT in the new network in real time. In addition to predefined topologies, .s2p, .s4p, .s6p and .s8p files can be read into the R&S®ZNA and used for embedding/deembedding.

## Enhanced solutions for in-fixture and PCB testing

If DUTs do not have coaxial connectors, vector network analyzer calibration often cannot be made directly in the reference planes. This is the case for in-fixture and on-wafer chip tests, measurements of PCB structures, non-coaxial connectors or cables and all non-connectorized components. In these cases, test fixtures, probes or other structures are used to adapt from the coaxial interface at the calibration plane to the device under test. The corresponding lead-ins and lead-outs need to be modelled and characterized via their S-parameters, so that they can be deembedded from the measurement results.

For such tasks, the R&S®ZNA is prepared by seamless integration of third-party tools made available as the R&S®ZNA-K210, R&S®ZNA-K220, R&S®ZNA-K230 and R&S®ZNA-K231 options. All procedures are coupon based, and differ by the type and number of applied test coupons, the incorporation of PCB impedance effects, and calculation speed. A user-friendly wizard with a graphical interface and parameter entries specific to each deembedding tool, guide the operator through the entire calibration and deembedding procedure.

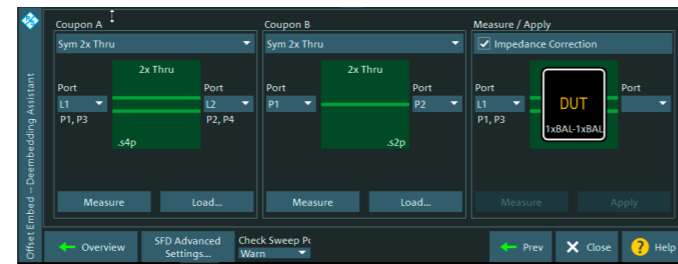

For in-fixture and PCB tests Rohde & Schwarz offers advanced coupon based deembedding options, supported by a smart configuration wizard.

## Calibration equipment

The R&S®ZN-Z1xx economy calibration kits provide robust operation up to 43.5 GHz. The R&S®ZN-Z2xx high-end calibration kits are available for more sophisticated requirements, offering calibration standards from type N through 1.0 mm (110 GHz connectors). These kits achieve very high calibration accuracy thanks to precision manufacturing combined with S-parameter based characterization of the individual calibration standards.

## Automatic calibration units

Automatic calibration units up to 67 GHz with two or four ports greatly simplify calibration, while reducing operator errors and improving calibration repeatability.

## Calibration of mixer and converter setups

With the R&S®ZNA-K4, R&S®ZNA-K5 and R&S®ZNA-K9 options, the R&S®ZNA supports comprehensive characterization of frequency translating devices, such as mixers, T/R modules, and (embedded LO) satellite receivers (LNB). For the R&S®ZNA to measure group delay and, for instance, transmission phase, the mixer used for calibration should be reciprocal in corresponding limits. Users can extend their manual kit or calibration unit with calibration mixers that meet this requirement. The R&S®ZN-ZM292 is reciprocal<sup>1)</sup> within tight limits and covers common conversion schematics up to 40 GHz.

<sup>1)</sup> Ideal reciprocity and thus the absolute phase accuracy is degraded by  $S_{21}/S_{12}$  uncertainty, and LO contributions.

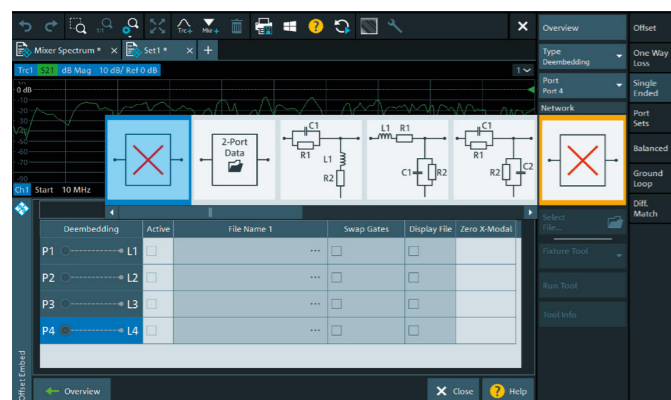

The R&S®ZNA comes with a choice of predefined matching networks whose values can be edited. If values are changed, the R&S®ZNA will immediately recalculate the network and embed the DUT in the new network in real time.



R&S®ZN-Z1xx  
economy calibration kit



R&S®ZV-Z210 and R&S®ZV-WR10  
high-end calibration kits



R&S®ZN-Z2xx high-end calibration kits



R&S®ZN-Z156 calibration unit

## Calibration of complex setups made easy – the calibrate all function

Comprehensive characterization of active DUTs, such as amplifiers and converters, usually requires a large number of parameters and settings to be defined. To calibrate a corresponding number of different channels, users need to invest an enormous amount of time and effort. This is aggravated by the risk of operator errors as different calibration standards need to be connected repeatedly. The calibrate all function in the R&S®ZNA avoids these drawbacks and lets users achieve reliable results with minimum effort.

The calibration steps required for the various channels are combined in the GUI in tabular form, and the firmware processes these steps for an overall calibration procedure covering all channels. Each calibration standard, calibration unit and power sensor needs to be connected only once. All the required data for the currently connected calibration standard/unit/power sensor is collected in the background (e.g. diverse frequency ranges for intermodulation measurements, or different sidebands for converter measurements); no user action is required. This drastically reduces the calibration effort for the overall setup.

## Results in a minimum of time

Besides very short measurement times, the R&S®ZNA offers other features that significantly speed up data acquisition. The analyzer's high dynamic range of > 129 dB (specified) provides a large signal-to-noise ratio to deliver accurate measurements, even with high IF bandwidths, along with short measurement times. During mixer measurements, RF and IF signals can be measured simultaneously, using the second internal LO source. Compared with other instrument concepts, this yields measurement speed as high as that required for non-frequency-converting S-parameter measurements. The R&S®ZNA can pick up measurement data on all of its ports simultaneously, allowing e.g. a pair of 2-port DUTs to be tested in parallel, thereby doubling the throughput.

## Real-time measurement uncertainty and verification

Uncertainty data listed on data sheets is inevitably provided for only a limited set of test parameters. With the two functionalities offered by the R&S®ZNA-K50(P) option, operators can check uncertainty under the given test conditions and verify actual RF performance:

- S-parameter traces can be displayed with error bars, calculated in real time depending on the current settings
- Verification measurements are performed to ensure that verification standards match their characterization values. Utilizing R&S®ZN-Z4xx verification kits ensures traceability of measurement results to the Swiss metrology authority METAS.

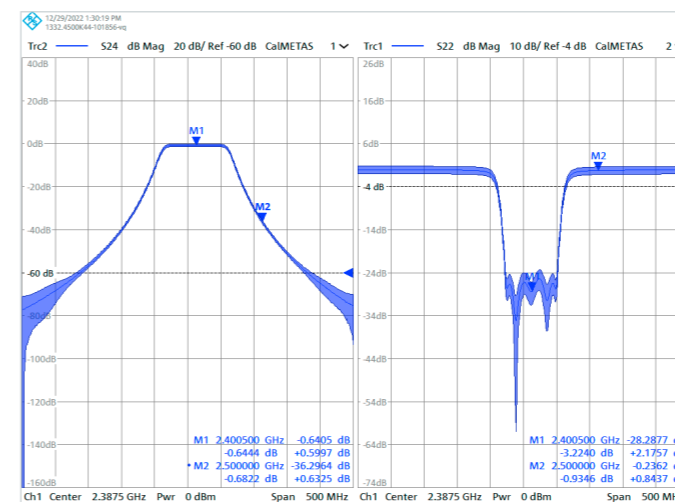

The R&S®ZNA-K50(P) option requires installation of the the VNA tool from the Swiss metrology authority METAS. This option enables operators to use the VNA tool as an additional means of individual uncertainty evaluation.

R&S®ZNA-K50(P) option adds error bars to S-parameter traces in real time, i.e. the uncertainty is calculated in real time for every sweep.

# SYSTEM INTEGRATION, PERSONALIZATION AND CONNECTIVITY

Test system completion with custom instrumentation, extended dynamic link library (DLL) based data analysis and instrument remote control

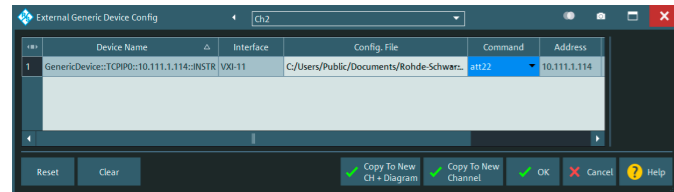

A JASON command list file is defined in the "External Generic Device Config" menu. A command or command sequence from the file can be selected for each channel.

## Generic device system integration

The R&S®ZNA supports a wide range of auxiliary instruments by default, such as Rohde&Schwarz signal generators and power test heads. If the test system needs to be extended with further instrumentation, the R&S®ZNA firmware provides the operator a powerful and flexible tool by means of external generic device configuration. With command files in JavaScript Object Notation (JSON, \*.json) format, users can set up communications to an external VISA capable device. ASCII notation can be used to define sequences of commands, and command files for different instruments can be loaded. This enables integration of a virtually unlimited number of instruments, and commands are sent specifically for each measurement channel. The code on the right offers a simple example, showing how to set the R&S®RSC step attenuator to certain attenuation values. The commands (e.g. att22) can be selected on a channel specific basis.

## Dynamic link library integration

An even more powerful and versatile tool is the integration of user-provided DLL. Besides the control of external devices, (firmware compatible) GUI windows can be created, and individual data processing and analysis can be added. A basic example is the control of an external power meter or source monitor unit for an amplifier

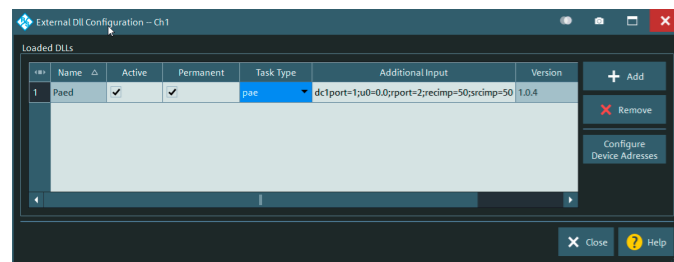

```
{
  "Header"
  {
    "File Format": 1.0
  },
  "Device Identification":
  {
    "Vendor Id": 0,
    "Device Id": 0,
    "Serial": "",
    "Settling Time": 0.03
  },
  "Commands":
  [
    { "Command Name": "att22",
      "Command List":
      [
        { "Command": "ATT1:ATT 22" }
      ]
    },
    { "Command Name": "att77",
      "Command List":
      [
        { "Command": "ATT1:ATT 77" }
      ]
    },
    { "Command Name": "reset",
      "Command List":
      [
        { "Command": "*RST" }
      ]
    }
  ]
}
```

JASON command file example

power added efficiency measurement (PAE). The DLL establishes the synchronized power readings, calculates the efficiency based on the actual DUT supply circuit and the power readings from the R&S®ZNA and forwards the PAE trace to the display. For some Rohde&Schwarz power meters, plug&play DLLs are available, and the open DLL architecture supports operators who want to integrate custom code.

Dialog for DLL integration: as an example, a custom DLL for PAE is loaded

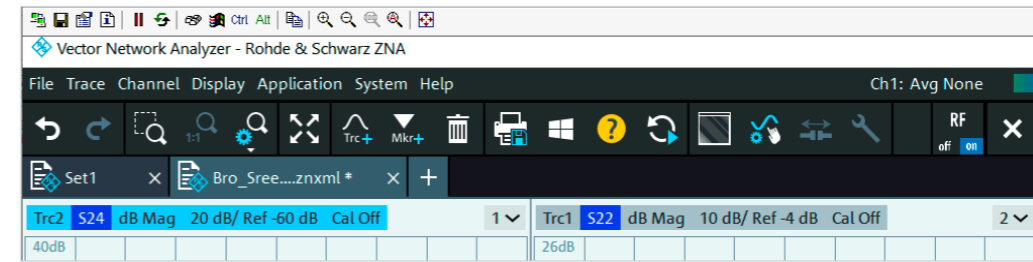

The TightVNC viewer allows full remote access and operation of an R&S®ZNA and adds valuable features such as file exchange and control command execution.

## TightVNC supports plug & play remote instrument access

Easy and convenient remote access to test equipment is a valuable and powerful tool for user support, evaluation, system setup, programming, data transfer and instrument care. To offer a standardized method, the widely known TightVNC (server) tool is factory installed on every R&S®ZNA. Installing it on the control PC gives users full remote access to the firmware, GUI and the full range of functions available to operators working at the instrument itself. Plus, the useful toolbar of the TightVNC is available to send special commands (e.g. Ctrl + Alt + Del) or to upload and download all kind of files.

## Functional schematic of HUMS

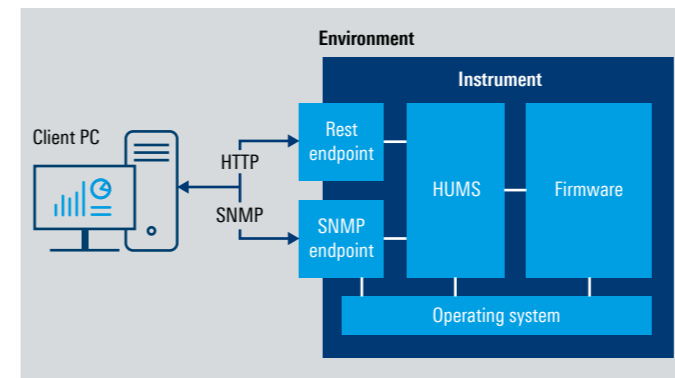

## Health and utilization monitoring service (HOMS)

For companies with a large installed instrument base and extended networks, a clear overview of the entire network and central management is crucial for ensuring effective and reliable operations across the network. The software for all of the modules needs to be kept up to date, costs and efficiency need to be optimized using statistical data, operations need to be monitored and failures recognized as soon as possible. HUMS is a service that runs locally on each instrument, collecting and storing data on that instrument. Data can be retrieved by standard plug&play browser based communications, and with application specific programming.

HOMS is available on the R&S®ZNA with the R&S®ZNA-K980 software option. HUMS opens the SNMP agent and a REST service with HTTP endpoints, which allows the HUMS data to be retrieved.

Here are some examples of parameters obtainable from a VNA:

- ▶ Hardware and software options
- ▶ Firmware version
- ▶ Detailed info on hardware components (e.g. sync, HDD)
- ▶ Status (self-test, system messages)
- ▶ Service status
- ▶ Malware status
- ▶ Storage capacity
- ▶ Utilization (e.g. general on-time, activity of hardware and software options, count number of switching cycles)

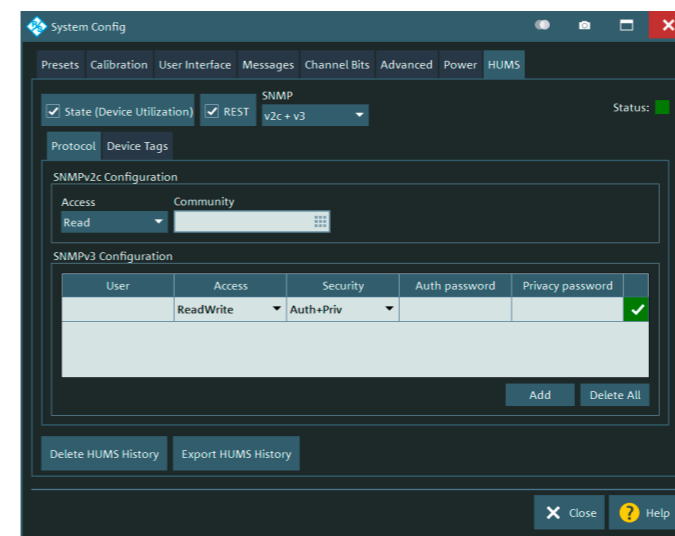

R&S®ZNA HUMS activation and configuration GUI



# MEASUREMENT MODES



# COMPRESSION POINT MEASUREMENTS

Determining the compression point is essential when characterizing active components. With the R&S®ZNA, compression point measurements can be flexibly combined with S-parameter measurements.

## Highly accurate results

Compression measurements in particular require accurate power levels for stimulation and measurement as well as port match correction. The R&S®SMARTerCal procedure combines receiver power calibration, source flatness calibration and system error correction, thus compensating for the test set response and system error. Outstanding high receiver linearity makes it possible to reduce power calibration to a single point of the power sweep, which drastically reduces calibration time.

## Power and phase sweeps for detailed insight

To find the optimum set of power sweep parameters, single power sweeps at dedicated frequencies can be combined in one display. For single power sweeps, the x dB (where x dB is typically assumed as 1 dB or 0.1 dB) compression can be flexibly referenced to single values or power ranges, thus minimizing noise effects in the small signal range. Compression power and S-parameters are shown in real time. The reverse power sweep reveals hysteresis effects of the DUT and the test time can be reduced by the swept mode.

## Compression versus frequency

Automatic compression measurement performs power sweeps in the background at each data point and directly shows the CP(f) in terms of the input/output power or as an S-parameter. To minimize measurement time, the linear range can be skipped by defining a back-off value to set a reference different from the power sweep start value.

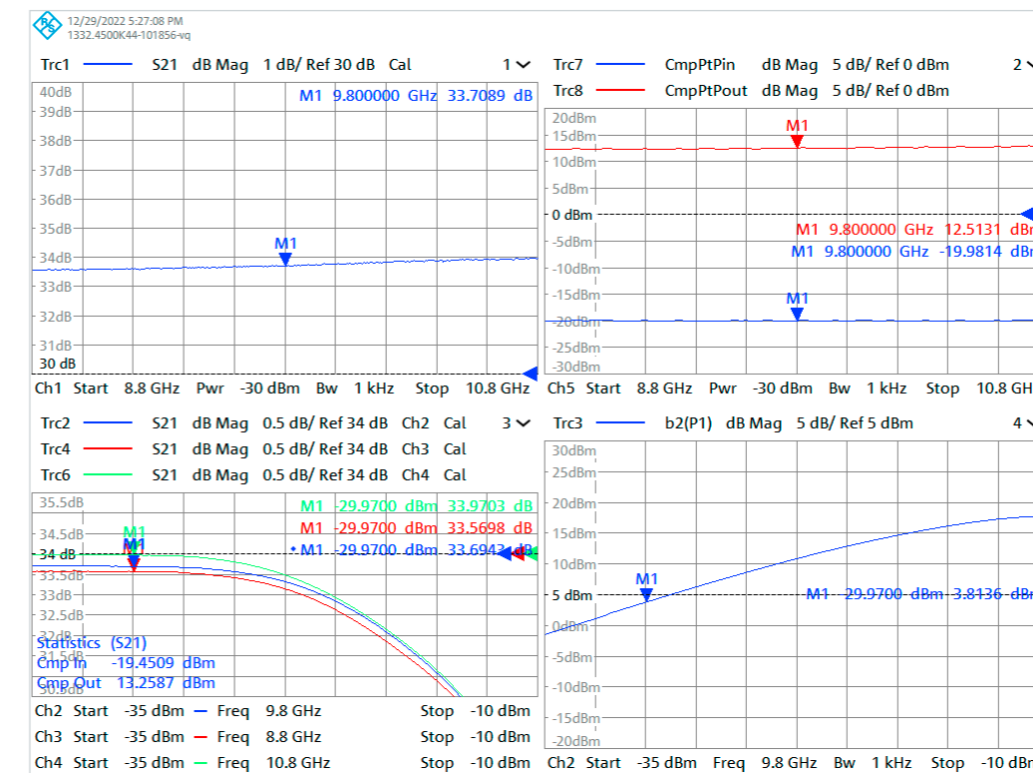

Amplifier compression measurements:

- ▶ Gain
- ▶ Compression point by measurement of power sweeps at dedicated frequencies
- ▶ Input and output power compression point versus frequency
- ▶ Absolute power

# INTERMODULATION MEASUREMENTS ON AMPLIFIERS AND MIXERS

The R&S®ZNA makes it possible to determine the intermodulation characteristics of amplifiers and mixers fast and with high accuracy.

## Frequency sweep with fixed carrier spacing

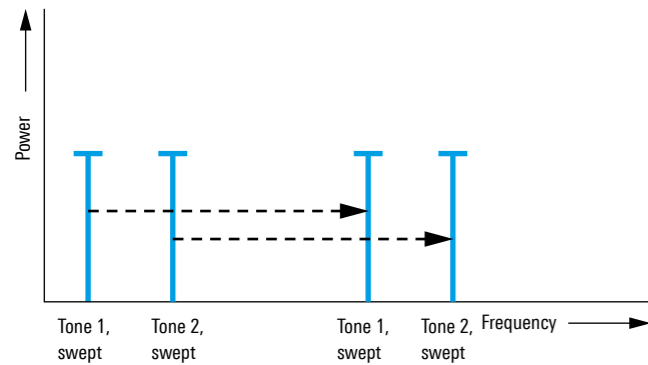

The R&S®ZNA provides the following three types of intermodulation measurements:

- ▶ Frequency sweep with fixed carrier spacing
- ▶ Frequency sweep with variable carrier spacing
- ▶ Power sweep with fixed carrier spacing

## Wide dynamic range and digital ALC for challenging intermodulation measurements

The R&S®ZNA offers major benefits especially when measuring amplifiers with very small intermodulation products. Its wide dynamic range and the excellent power handling capacity of its receivers make it possible to measure low intermodulation distortion within seconds instead of minutes.

When measuring intermodulation, precise control of the powers applied to the DUT inputs is vital. Here, the R&S®ZNA makes no compromises. Automatic level control (ALC) combined with system error correction ensures a precise amplitude for the individual carriers over the entire frequency range, regardless of the DUT's input reflection coefficient.

## High output power and flexibility

Featuring four independent sources, the R&S®ZNA can even perform intermodulation measurements on mixers without requiring an external source. The analyzer delivers high output powers of up to +20 dBm per test port. If this is not sufficient, the R&S®ZNA can flexibly loop external amplifiers into the signal path and precisely control them via ALC.

## Frequency sweep with variable carrier spacing

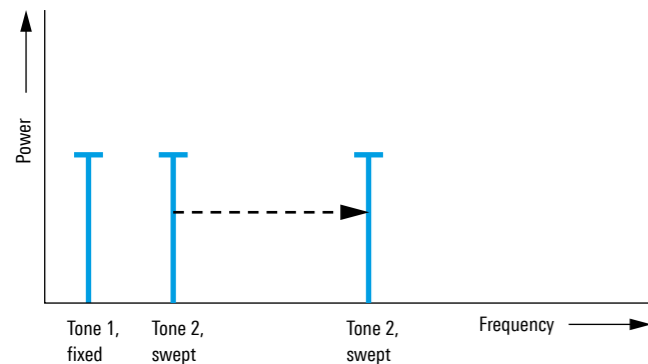

## Power sweep with fixed carrier spacing

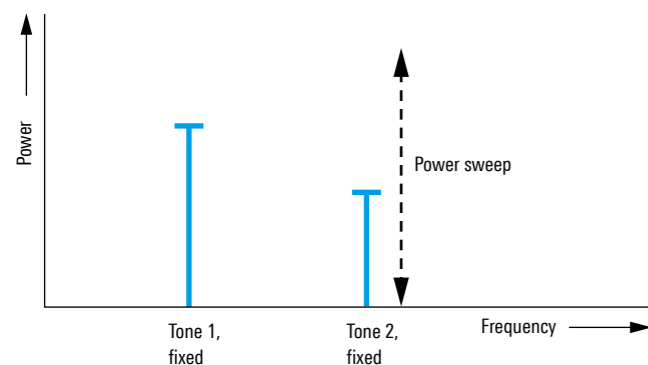

## DUT-centric approach simplifies configuration of intermodulation measurements

The DUT-centric approach of the R&S®ZNA supports intuitive navigation for intermodulation measurements. To configure a measurement, the user first selects the type of DUT and is then guided through a dialog to define the test setup, the DUT connections, the measurement quantity or type, e.g. IMx (x = 3, 5, 7, ...) versus frequency, the power at the DUT input and output, or a spectrum measurement. The configuration can be completed by a subsequent, step-by-step user guided calibration procedure.

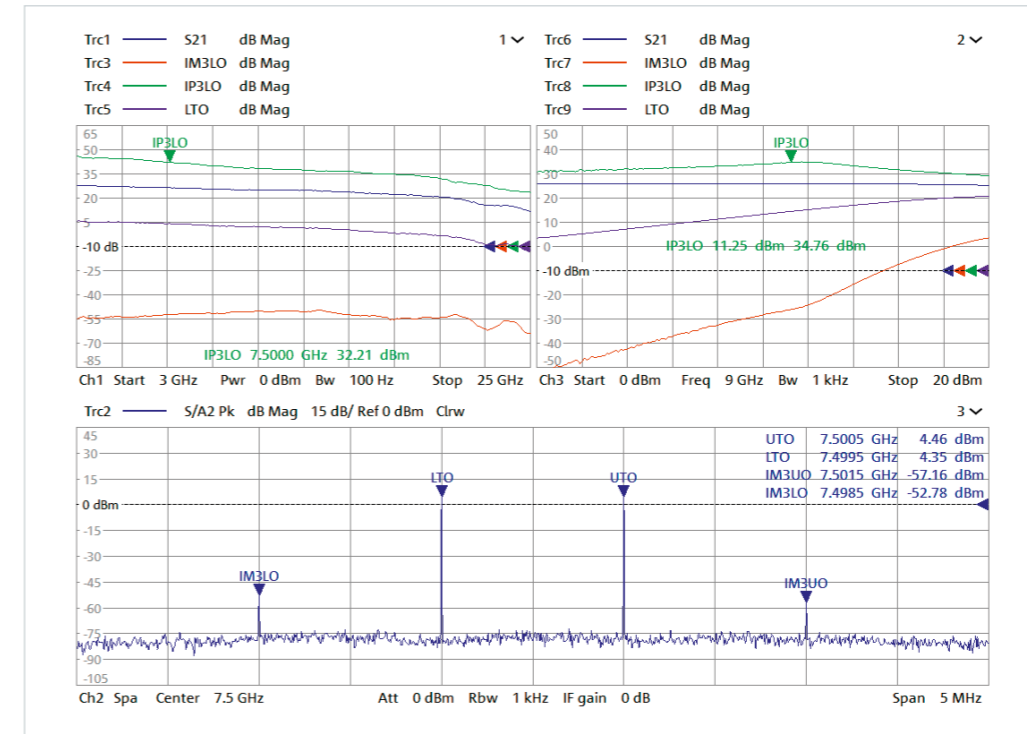

Comprehensive amplifier characterization, including intermodulation products (IP), IP versus frequency, spectral measurements and other quantities

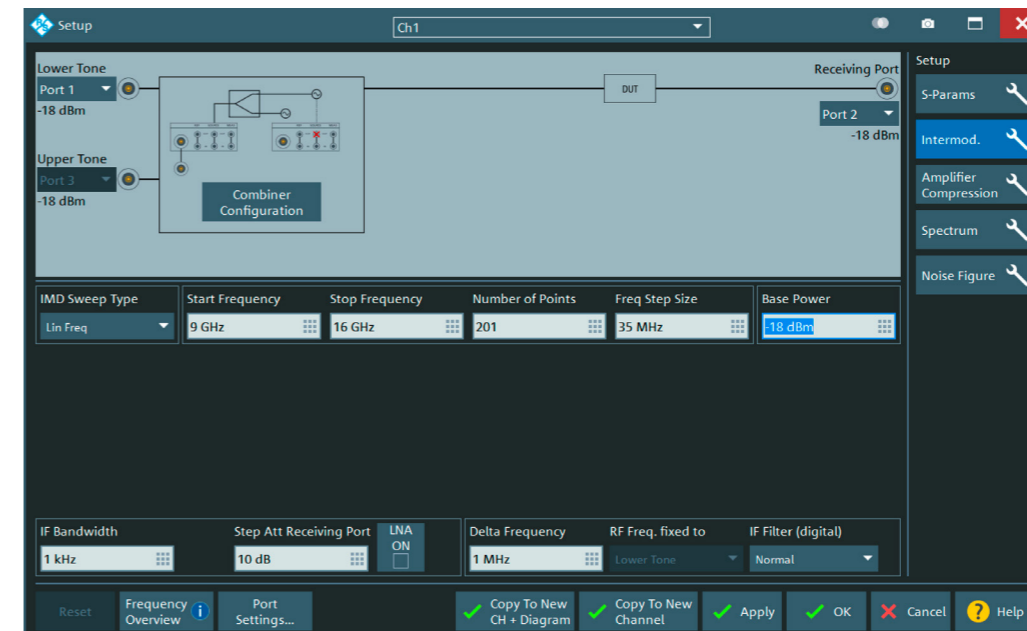

Configuration GUI for an amplifier intermodulation test

# NOISE FIGURE MEASUREMENTS ON AMPLIFIERS AND MIXERS

The R&S®ZNA-K30 noise figure measurements option further enhances the R&S®ZNA to provide a powerful and versatile test system for full characterization of amplifiers and converters.

## Noise figure measurements on amplifiers and mixers

The R&S®ZNA-K30 noise figure measurements option expands the R&S®ZNA to include noise figure analysis for amplifiers, converters and T/R modules. Hardware options can be added to further optimize this functionality, e.g. to stimulate high gain amplifiers with very low levels or to measure low gain/low noise figure LNAs with high accuracy.

## Single connection device characterization

Instead of using a noise source to determine the noise figure, the R&S®ZNA directly measures absolute noise power, based on absolute power level calibration and system error correction. Likewise, instrument calibration with a manual calibration standard, a calibration unit and a power sensor requires no extra equipment; an external noise source is not necessary. The calibration process is included in the convenient calibrate all function for the entire setup. The DUT (amplifier, converter, T/R module) needs to be connected only once to provide full device characterization, including quantities such as conversion gain/loss, intermodulation distortion, compression and group delay.

## Straightforward main GUI for amplifier and mixer test setups

The GUI shows the hardware components in the measurement path as graphic elements and helps users optimally configure all the details. Users can see all relevant settings at a glance, including source power, step attenuators, the resulting power level at the reference plane, the internal/external preamplifier gain on the receiver side, and the test parameters. The GUI also provides elements for configuring frequency-converting measurements on mixers and converters; even measurements on high gain receivers with embedded LO can be easily configured and deliver reliable results.

## Calibration features and settings

The challenge many instruments and devices are facing with this type of measurement is to handle very low stimulus powers and high measured power levels that may even differ for calibration and measurement and in the forward and reverse direction. The main GUI includes essential parameters to help users easily find the desired settings with manual configuration. Correction algorithms such as used in system error correction provide accurate and reliable results.

## Quickset – the fast and intuitive way to optimal settings

As an alternative to direct manual configuration of measurement and calibration parameters and the R&S®ZNA hardware, the extremely powerful Quickset dialog guides users interactively to the optimal setup. Based on estimated DUT characteristics such as the approximate noise figure (NF) and gain and the desired noise figure accuracy, the R&S®ZNA calculates parameters such as the measurement time and source power and displays the recommended optimal hardware configuration (e.g. use of direct source monitor access, low-noise preamplifier at receiver port 2 or reverse coupler operation). Interactive graphic elements help the user modify settings. The effects of modifications are calculated and displayed instantaneously and can be assessed by the user. This is a quick way to configure reliable noise figure measurements on amplifiers.

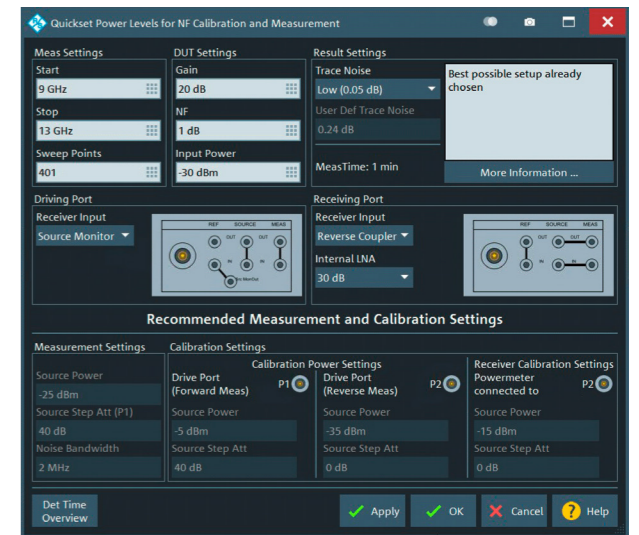

Quickset dialog for interactive and semi-automatic configuration of optimal test parameters and R&S®ZNA hardware

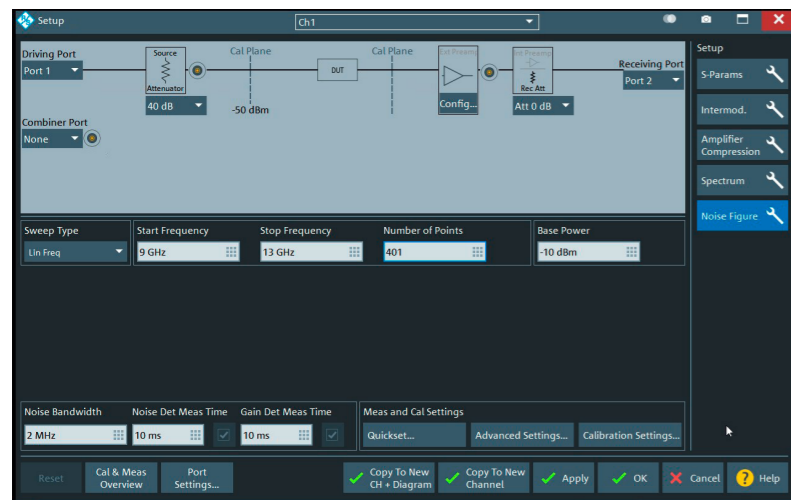

GUI for configuring noise figure measurements on amplifiers, mixers, converters and T/R modules

## Options supporting noise figure measurements

Designation	Type	Required/recommended	Comment
Noise figure measurements	R&S®ZNA-K30	required	with R&S®ZNA-K4: support of frequency-converting measurements
<b>Options for source port 1 (port 3) configuration</b>			
Direct source monitor access, port 1/port 1 and port 3	R&S®ZNAxx-B161/ R&S®ZNAxx-B163 <sup>1)</sup>	required	provides a relatively strong reference signal with very low stimulus powers, for low trace noise (requires R&S®ZNAxx-B16/-B21/-B23)
Source step attenuator, port 1/port 3	R&S®ZNAxx-B21/ R&S®ZNAxx-B23	recommended, required with R&S®ZNAxx-B161/-B163	variation of source power, for two-tone signals, attenuators at both source ports P1 and P3 are recommended
Receiver step attenuator, port 1	R&S®ZNAxx-B31	recommended	power level optimization at measurement receiver
Low-power spurious reduction, port 1	R&S®ZNAxx-B501/ R&S®ZNAxx-B511	recommended	recommended with high gain DUTs (requires R&S®ZNAxx-B31; recommended: R&S®ZNAxx-B21/-B23, R&S®ZNAxx-B16, R&S®ZNAxx-B161/-163)
<b>Options for receiver port 2 configuration</b>			
Low-noise preamplifier, port 2	R&S®ZNAxx-B302/ R&S®ZNAxx-B312	strongly recommended	switchable internal preamplifier, selectable gain steps (requires R&S®ZNAxx-B16, R&S®ZNAxx-B32)
Receiver step attenuator, port 2	R&S®ZNAxx-B32	strongly recommended, required with R&S®ZNAxx-B302/-B312	power level optimization at measurement receiver
Direct source and receiver access	R&S®ZNAxx-B16	recommended, required with R&S®ZNAxx-B302/-B312	supports reversed coupler operation for increased receiver sensitivity

<sup>1)</sup> xx designates the R&S®ZNA model.

# PULSED MEASUREMENTS – FAST AND SIMPLE

The R&S®ZNA offers pulse modulators, pulse generators and synchronization I/Os for analyzing active components under pulsed conditions. Typical DUTs include components and complete T/R modules for radar applications. S-parameters, input and output powers and intermodulation products can be measured without any external components to generate RF pulses and synchronize test sequences.

## Internal pulse modulators and pulse generators

The R&S®ZNA can be equipped with one pulse modulator (R&S®ZNAxx-B4n) per port. The pulse modulators can be controlled via external pulse sources or via the four internal pulse generators. The internal pulse generators can also be used to control external pulse modulators via the trigger board outputs. This allows special modulators for very short pulses to be integrated, for example.

Thanks to the test set architecture, once system error calibration has been performed, it remains valid for all types of pulsed measurements – versus frequency, power and time – even if the pulse duty cycle is changed. The R&S®ZNA digital section is designed so that users can configure the pulse parameters individually for each port, supported by a convenient GUI. In addition to double pulses, users can configure arbitrary pulse sequences (i.e. with arbitrary start and stop times for all pulses) in a clearly laid out table.

## Measurements versus frequency and power

The R&S®ZNA supports the common measurement techniques for pulsed applications such as point-in-pulse and pulse profile measurements. For average pulse measurements, which rely on narrow IF bandwidths, the R&S®ZNA offers highly selective IF digital filters for the carrier signal.

## Point-in-pulse measurements

Short sampling times of 32 ns are achieved for point-in-pulse measurements with IF bandwidths ranging up to 30 MHz. In addition to S-parameters, the absolute peak power can be determined in amplitude and intermodulation measurements. Flexible trigger functions support complex pulsed measurement scenarios and facilitate synchronization of measurements.

## Pulse profile analysis versus time with 8 ns resolution

Equipped with the R&S®ZNA-K7 option (measurements on pulsed signals), the R&S®ZNA supports pulse profile measurements with a time resolution of 8 ns. This technique is suitable for periodic, non-periodic and one-shot pulse scenarios.

The analyzer provides simultaneous measurement of a signal on multiple receivers and for multiple wave quantities. The maximum number of wave quantities depends on the IF bandwidth and can vary e.g. between two (at 30 MHz IF bandwidth) and eight (at 1 MHz IF bandwidth). The number of wave quantities can be doubled using the R&S®ZNA-B7 data streaming memory option.

## Wideband pulsed measurements with high dynamic range

With up to 30 MHz IF bandwidth, the R&S®ZNA provides point-in-pulse and pulse profile measurements on very short pulses. At the same time, the analyzer offers techniques to deliver extremely low-noise traces or achieve a very high dynamic range despite the wide measurement bandwidth.

Unique in the R&S®ZNA is a method for averaging complex values, which allows sensitivity in the order of –90 dBm to be achieved at an IF bandwidth of 10 MHz, for example.

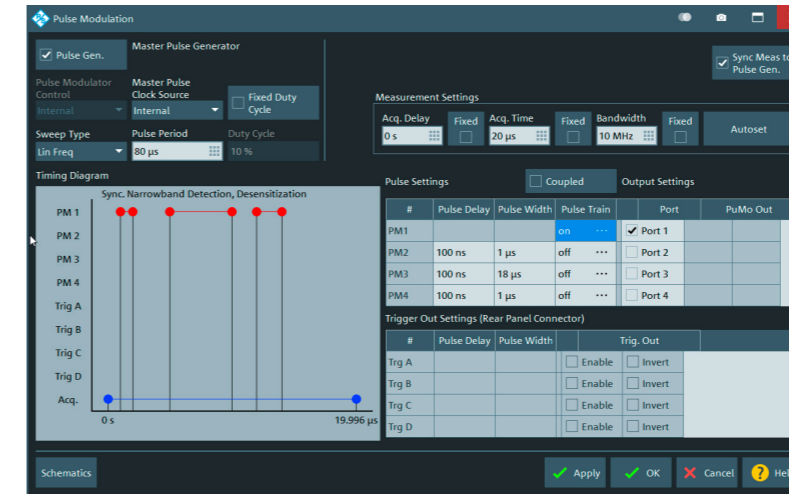

Configuration of parameters for pulsed signal measurements



Pulse profile measurement: the wideband measurement mode enables single-shot pulse sweeps without averaging. Averaging (AVG) modes are also available to achieve either a very low trace noise or a very high dynamic range (i.e. a high pulse on/off ratio) based on vector averaging. Red trace: AVG mode "flatten noise". Blue trace: AVG mode "reduce noise".

## Pulsed measurements

	Functions	Options
<b>Hardware</b>	<ul style="list-style-type: none"> <li>Four internal pulse generators with 4 ns time resolution and 8 ns minimum pulse width</li> <li>One pulse modulator per port with 40 ns minimum pulse width</li> <li>Four trigger inputs</li> <li>Four trigger outputs</li> </ul>	<p>The internal pulse generators are enabled with one of the following options: R&amp;S®ZNA-B91 (trigger and control I/O board) or R&amp;S®ZNAxx-B4n (internal pulse modulator, port n).</p> <p>The R&amp;S®ZNA-B7 (data streaming memory) increases the number of wave quantities that can be measured in parallel with the R&amp;S®ZNA-K7 (measurements on pulsed signals).</p>
<b>Pulse profile measurements</b>	<ul style="list-style-type: none"> <li>Up to 30 MHz IF bandwidth</li> <li>8 ns time resolution</li> <li>40 ns minimum pulse width</li> </ul>	R&S®ZNA-K7 (measurements on pulsed signals)
<b>Point-in-pulse measurements</b>	40 ns minimum pulse width (30 MHz IF bandwidth)	R&S®ZNA-K17 (increased IF bandwidth 30 MHz)



Pulse profile measurement with arbitrary pulse sequences. Pulse sequences can be measured on multiple receivers simultaneously. Since the receivers are phase coherent, they not only measure the amplitude of a pulse but also its phase with high stability. This allows the phase deviation of a DUT to be determined very simply and reliably.

# MIXER MEASUREMENTS EASIER THAN EVER

System error corrected mixer phase and group delay tests with up to four sources for IM on mixers and double converting receivers

## Fast setup and short measurement times with four internal sources and two internal LOs

The R&S®ZNA 4-port model comes with up to four internal sources. Swept LO measurements and intermodulation measurements versus frequency on mixers are performed up to ten times faster compared to setups that use

### DUT-centric configuration of mixer measurements

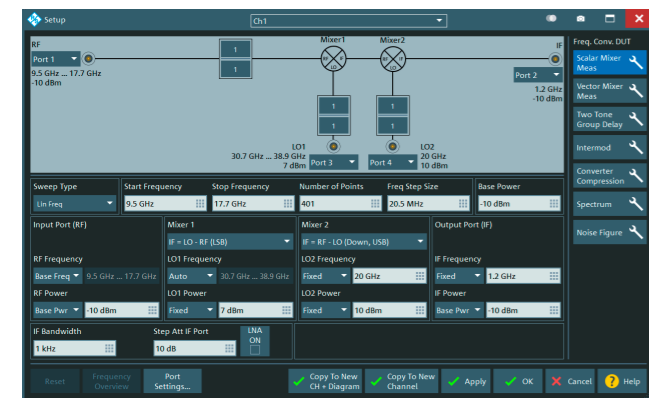

external sources. With separate sources independently configurable by port, even double-converting receivers can be characterized with the R&S®ZNA single box solution with unrestricted configuration flexibility and optimum accuracy. In addition, the rear panel local oscillator (LO) output is available as a scalar LO source up to 26.5 GHz.<sup>1)</sup> With two independent LOs for the internal receivers, the R&S®ZNA can perform simultaneous RF/IF measurements on mixers at twice the speed of a single LO while reducing trace noise during conversion loss and group delay measurements.

## High accuracy and easy configuration thanks to R&S®SMARTerCal

The R&S®ZNA determines the return loss and conversion loss of mixers and converters with high precision using R&S®SMARTerCal, a special calibration technique that combines system error correction with absolute power

<sup>1)</sup> Requires R&S®ZNA-B8 and ZNAxx-B5 options.

## Phase measurement on a mixer

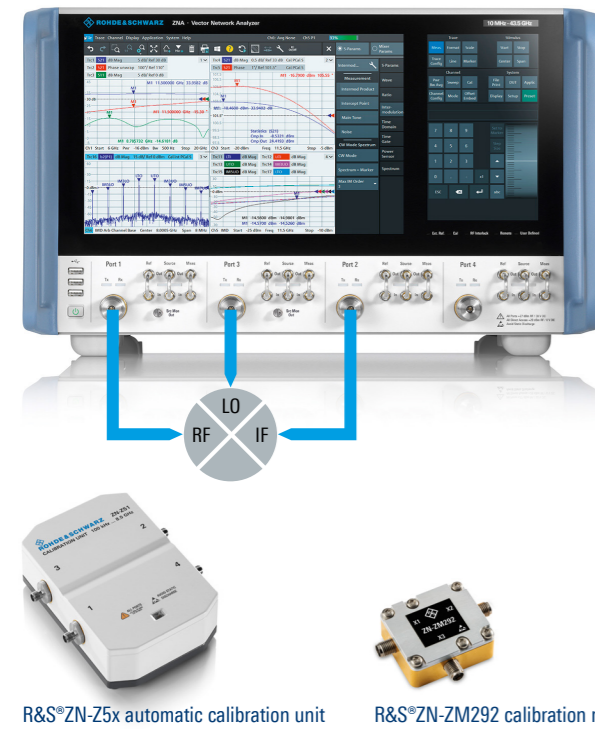

## Group delay measurement on a converter with two-tone signal applied to the mixer

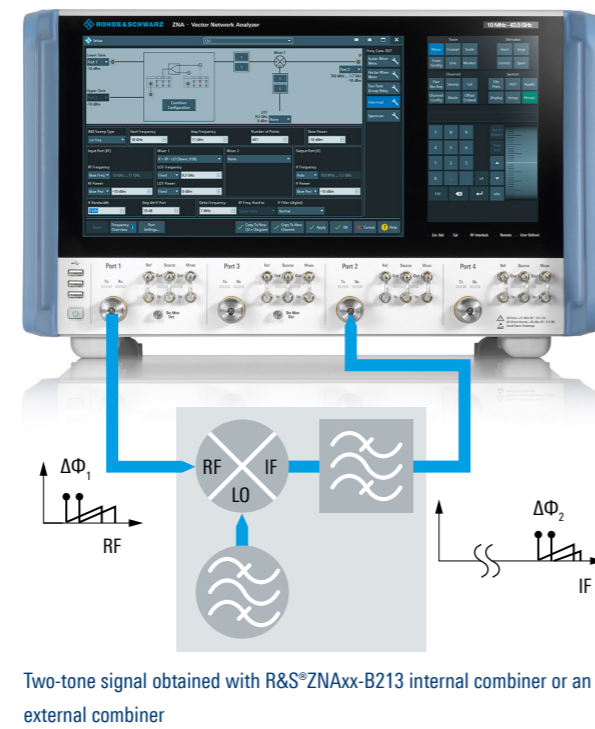

Two-tone signal obtained with R&S®ZNAxx-B213 internal combiner or an external combiner

level calibration. It corrects mismatch of the test ports and mixer; no attenuators are needed to improve port matching. Port match correction also ensures accurate results when using the R&S®ZNA-K9 option (group delay measurements on frequency converters without LO access).

## Unique approach for phase and group delay measurements on converters without LO access

The R&S®ZNA offers a special technique for measuring group delay and relative phase on frequency converters in cases where there is no access to the internal LO or the reference frequency. The analyzer uses a two-tone signal to stimulate the DUT. From the phase difference between the carriers at the input and output, the instrument

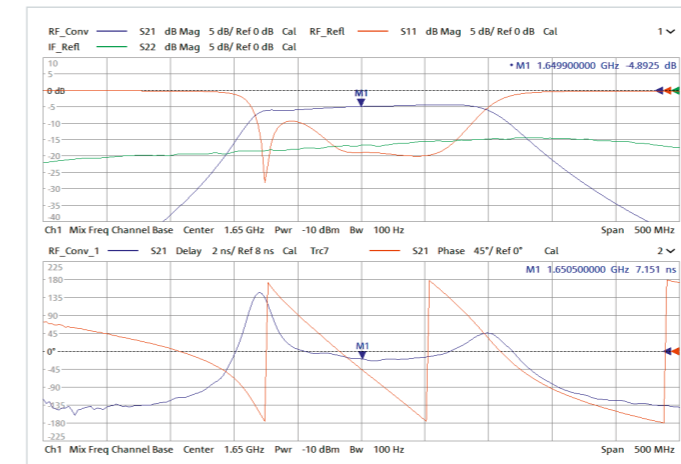

calculates the group delay and the relative phase. The frequency drift and frequency modulation of the DUT's internal LO do not affect the measurement accuracy as long as the frequency deviation lies within the analyzer's IF bandwidth used for the measurement.

## Phase measurements on frequency converters using vector error correction

Any receiving system requires a flat amplitude and phase response in order to transmit information smoothly and without disruptions. With the R&S®ZNA-K5 option (vector corrected converter measurements), the R&S®ZNA determines the magnitude and phase for the transmission parameters of mixers and converters with LO access. This measurement uses the phase coherent, phase repeatable synthesizers in the R&S®ZNA in combination with a 2-port power UOSM (PUOSM) calibration. The measurement itself does not require a reference mixer for frequency back-conversion. However, a calibration mixer such as the R&S®ZN-ZM292 can be used as an unknown through for calibration. The measurement is quick and easy to configure. It delivers the magnitude and phase for all four system error corrected S-parameters of a frequency converter, as well as its phase and group delay and AM/AM and AM/PM conversion.

Results of a converter measurement including return loss, conversion loss, phase and group delay

## Frequency-converting measurements

Type of measurement	Functions	Options
Scalar mixer and arbitrary frequency-converting measurements	<ul style="list-style-type: none"> <li>Conversion loss of mixers</li> <li>2nd source for swept LO measurements</li> <li>3rd and 4th internal source for intermodulation measurements on mixers and receivers with two converter stages</li> <li>R&amp;S®SMARTerCal for vector error corrected scalar frequency-converting measurements</li> <li>Correction of mismatch on test ports</li> <li>Scalar conversion loss and return loss</li> <li>Isolation measurement: LO → RF and LO → IF</li> <li>Intermodulation products and nth-order intercept point</li> <li>AM/AM conversion</li> </ul>	R&S®ZNA-K4, R&S®ZNAxx-B3n
Vector error corrected converter measurements	<ul style="list-style-type: none"> <li>2nd internal LO source for twice the measurement speed</li> <li>Rear panel output for internal LO signal as the 5th source (when 2nd internal LO source (R&amp;S®ZNA-B5, up to 26.5 GHz) is installed, the 2nd LO source is made available at the output)</li> <li>2-port power UOSM (PUOSM) calibration for vector error corrected conversion loss measurements</li> <li>Forward and reverse conversion loss (magnitude and phase)</li> <li>Absolute/relative group delay</li> <li>AM/AM and AM/PM conversion</li> </ul>	R&S®ZNA-B5, R&S®ZNA-B8  R&S®ZNA-K5
Measurements on frequency converters without LO access	<ul style="list-style-type: none"> <li>Calibration mixer</li> <li>Group delay and relative phase</li> <li>2nd internal LO for twice the measurement speed and for low trace noise</li> </ul>	R&S®ZN-ZM292  R&S®ZNA-K9, R&S®ZNA-B5

# SPECTRUM ANALYSIS WITH MULTICHANNEL VIEW

The R&S®ZNA-K1 spectrum analysis function provides a deeper insight into a DUT's behavior where S-parameter measurements versus frequency and power are not sufficient.

The FFT-based spectrum analysis function can be used to measure a DUT's spurious and harmonics, providing short sweep times along with high dynamic range and fine frequency resolution. It quickly detects undesired signal components (spurious) in converters and T/R modules. The marker-to-spectrum function directly gets to the root of problems in the event of unexpected S-parameter results, thus providing fast and extremely useful integrated diagnostics.

R&S®ZNA-K1 analysis functions: display of the ratio of power densities from different segments and the noise power marker function

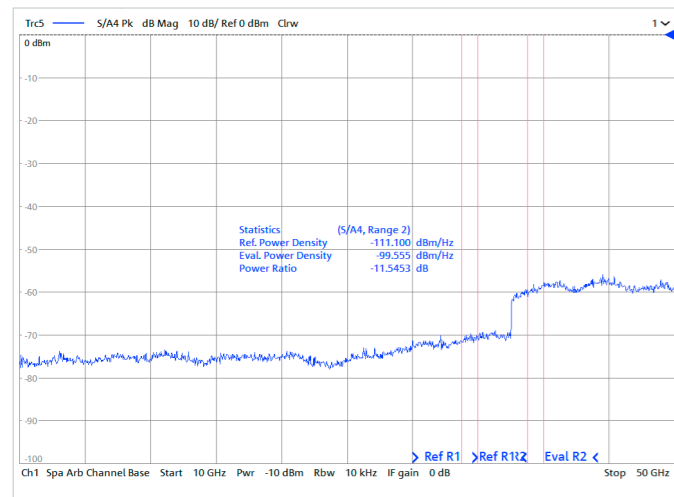

R&S®ZNA-K1 spectrum analyzer option: amplifier magnitude and phase compression measurement (at 1 GHz, top) and corresponding harmonic and spurious spectrum

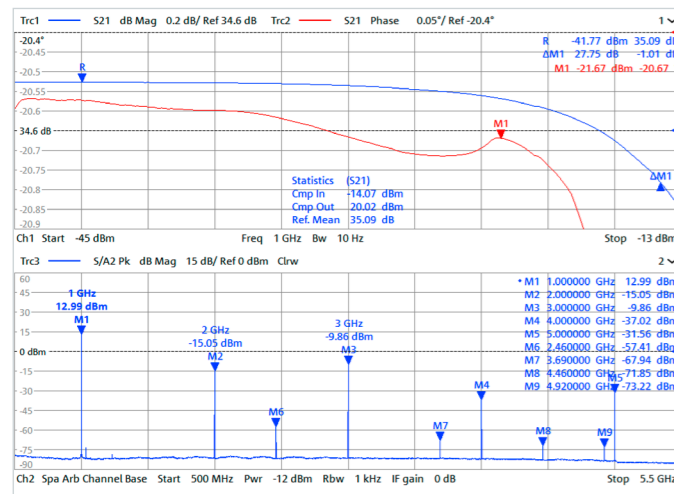

## Multichannel view of mixer measurements with harmonic and spurious search

The spectrum analysis function is available on all ports of the R&S®ZNA. It relies on system error correction (OSM port match correction), boosting accuracy and eliminating the influences of the test setup. In multichannel view, multiple results are displayed simultaneously. For example, an S-parameter measurement can be displayed along with the harmonics spectrum, or the conversion loss along with the spurious signals for a mixer. The R&S®ZNA-K1 spectrum analysis results can be displayed from all measurement and reference receivers in one setup. True parallel detection and display of the results from up to four receivers significantly reduces test time.

## Combined S-parameter and spectrum analysis with marker function

When undesired effects are detected during S-parameter measurements, the root cause of the problem can be identified with a subsequent spectrum analysis, which is performed at the press of a button. A marker is placed on the desired frequency, and spectrum analysis around this frequency will deliver conclusive information about unwanted effects. In addition, a noise marker can be used to display the normalized noise power in dBm (1 Hz).

R&S®ZNA-K1 spectrum analyzer option: output spectrum of a mixer

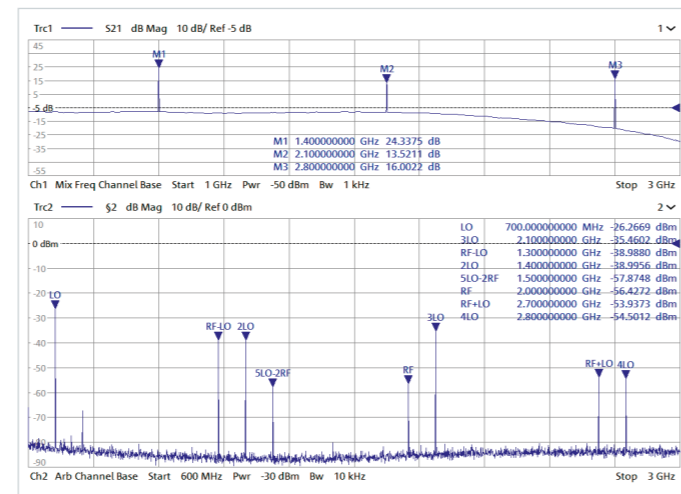

# TIME DOMAIN ANALYSIS AND SIGNAL INTEGRITY MEASUREMENTS

The R&S®ZNA-K2 and R&S®ZNA-K20 options provide a wide range of features for in-depth investigation of transmission line structures, signal transmission quality and in-fixture/PCB testing.

## Efficient time domain analysis with enhanced resolution

The R&S®ZNA offers powerful time domain analysis to measure components such as test fixtures, cables and connectors in the frequency and time domain. With up to 100 000 points per trace, the R&S®ZNA can easily measure even electrically long DUTs such as cables. Using the gating function, the analyzer can locate discontinuities and analyze them in detail.

A 4-port R&S®ZNA can be used to determine the balanced S-parameters and other quantities such as near-end and far-end crosstalk (NEXT, FEXT) on two-wire lines and differential structures. Using the Rohde&Schwarz VNA unique resolution enhancement function, the frequency range of the R&S®ZNA can be virtually extended. This yields temporal and spatial resolution substantially higher than would be expected from the DUT's and/or analyzer's frequency range.

## Distance-to-fault measurements

The R&S®ZNA-K2 time domain analysis option has a special menu for the straightforward configuration of distance-to-fault (DTF) measurements. Discontinuities in transmission lines are directly measured and displayed versus distance using S-parameter reflection measurements.

## Signal integrity at a glance with eye diagrams

Verifying the quality of a transmission path usually requires testing all of its components. The R&S®ZNA provides comprehensive analysis of cables and connectors in the time and frequency domain. The R&S®ZNA-K20 extended time domain analysis option makes it possible to compute, based on the S-parameters, the rise time, skew and eye diagrams for different bit patterns. The R&S®ZNA-K2 time domain analysis and R&S®ZNA-K20 extended time domain analysis options are integrated into the analyzer firmware. Eye diagrams and S-parameters versus frequency and time can be analyzed and displayed simultaneously, revealing the transmission quality at a glance.

## Analysis of disturbance effects and signal quality optimization

The R&S®ZNA-K20 extended time domain analysis option makes it possible to simulate the effects of disturbances such as jitter and noise on the eye diagram. The analyzer can also simulate the impact of correction algorithms, e.g. for predistortion at the transmitter end and for equalization at the receiver end. Plus, the R&S®ZNA-K20 option can be used to configure user-defined mask tests. These tests make it possible to verify compliance of the DUT's behavior with relevant standards such as USB, HDMI™ and DVI.

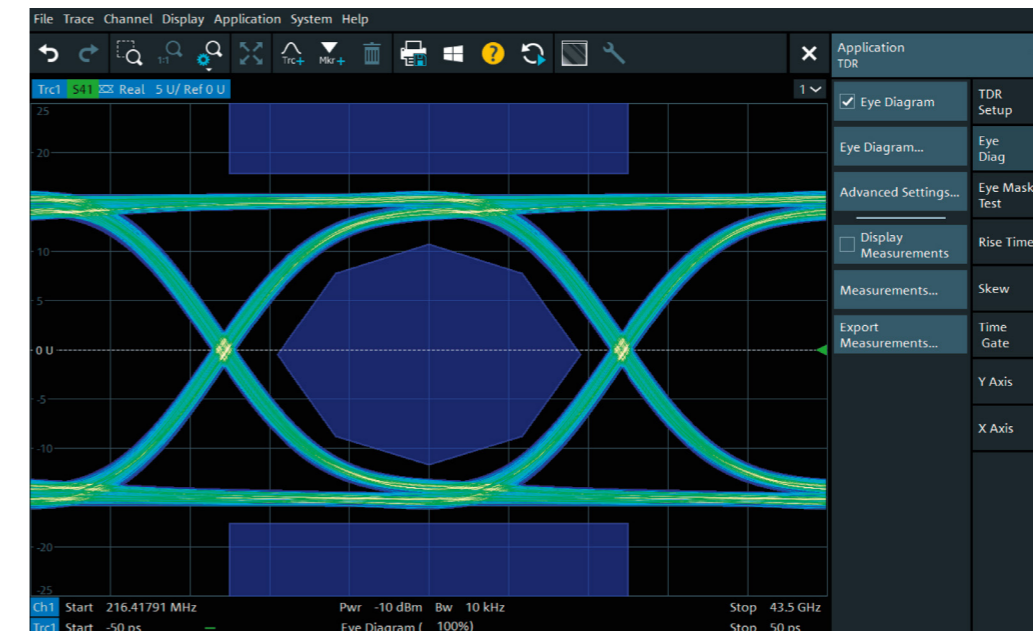

The R&S®ZNA-K20 option offers versatile signal integrity measurements, e.g. eye diagrams with a mask to verify compliance with relevant requirements. It can also be used to determine the transmission characteristics of signals with jitter or noise.

# PHASE-CONTROLLED SOURCE MEASUREMENTS

Phase control of up to eight digital RF sources enables multi-path propagation evaluation, phased antenna array/TRM testing, I/Q measurements, and fully automated true differential mode testing.

## Innovative digital LO and RF synthesizers

Thanks to R&S®ZNA digital (DAC based) synthesizers, sources can be set to dedicated phase values. This concept is the basis for well defined stimulus phase conditions in the reference planes, and unambiguous synchronous phase measurements even with the receivers at different frequencies.

A variety of advanced measurements is supported:

- ▶ Arbitrary phase source setting for I/Q applications
- ▶ Testing differential amplifiers under real operating conditions
- ▶ Evaluation of the phase and magnitude imbalance of balanced and multipath systems
- ▶ Tuning the radiation pattern of antenna arrays and subarrays (AESAs)
- ▶ Phase tuning of all RF sources allows amplifier active load pull tests
- ▶ Getting differential or mixed-mode S-parameters of differential structures with true-mode stimulation

## R&S®ZNA-K6 source-coherent mode

The R&S®ZNA-K6 option enables the phase-coherent operation of the R&S®ZNA sources. Depending on the operation mode, arbitrary phase state values can be entered for each source as required. Full n-port and level calibration ensure high-phase and level accuracy in the reference plane and minimum phase uncertainty by port match correction.

## True differential test mode

The true differential test mode benefits from the source-coherence capability of the RF sources. Alternating stimulus with two 0° in-phase and 180° out-of phase signals provides all elements of the complete mixed mode S-parameter matrix.

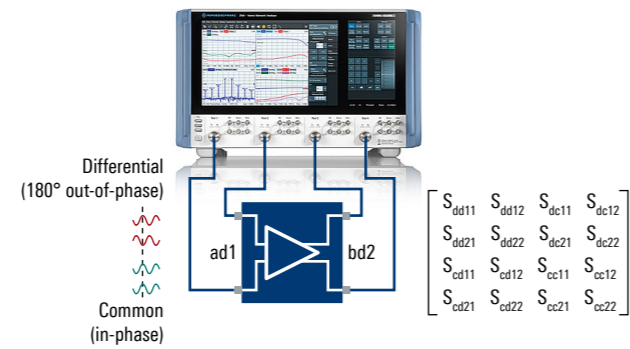

## R&S®ZNA-K61 true differential mode testing

Differential amplifiers may respond differently depending on whether they are tested with sequential single-ended or true differential mode stimulation. The use of baluns involves severe limitations: no common mode or mode conversion evaluation, band limitation, limited phase symmetry. R&S®ZNA-K61 overcomes this issue, with true-mode stimulation, and fully automated test execution, applying true common and differential signals, measuring the DUT response. As a result, all elements of the mixed-mode S-parameter matrix are available. In addition, imbalance sweeps for the phase (phase sweep at fixed frequency and power) or magnitude (magnitude sweep at fixed frequency and phase) are supported.

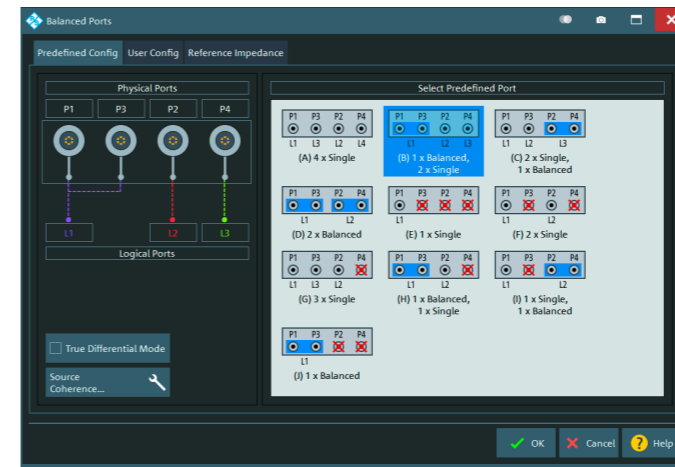

Balanced structures as well as used and unused ports are defined at a keystroke. Predefined topologies are completed with a tab offering free user configurations.

## Definition of differential structures at a keystroke

To define the balanced structure and balanced/single-ended ports of the DUT, a clear GUI allows to select the desired topology from predefined settings at a keystroke. Additional configurations are done in just a few mouse clicks.

## Application: active load pull

Tuning the magnitude and phase of all sources makes it possible to electronically tune the source at the amplifier output in parallel to the RF stimulation. This enables electronic output impedance tuning (reflection coefficient at the amplifier output). Fast tuning lets users evaluate amplifier gain, matching and efficiency in a short test time. Combining the R&S®ZNA with systems from partner companies enables even more comprehensive characterization based on hybrid load pull tuning, e.g. for noise parameter tests.

## Application: differential I/Q test

With up to four phase coherent sources, devices with I/Q input/output can flexibly be characterized. The sources can be set to arbitrary phase and magnitude values, to apply 90°/180° I/Q signals, or to perform imbalanced sweeps.

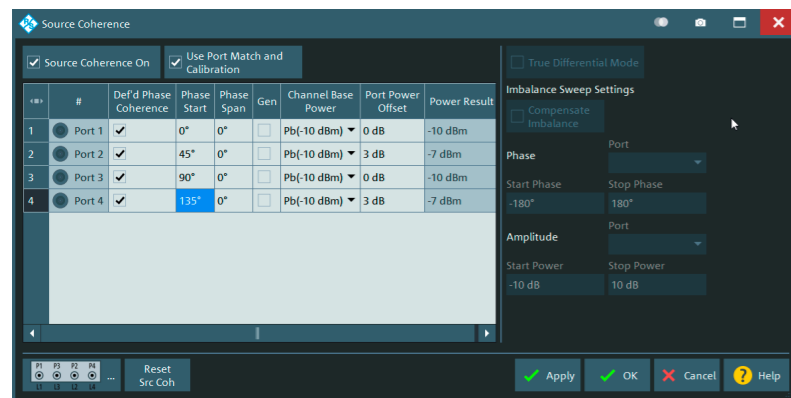

GUI for entering dedicated port specific values for phase and power. In automatic true differential measurement mode, users can enter parameters for phase and magnitude imbalance sweeps.

## R&S®ZNA based source/load pull system

The multiple source concept of the R&S®ZNA supports the RF signal plus DUT reverse stimulation and active impedance tuning, offering active source/load pull testing in a compact single-box solution.

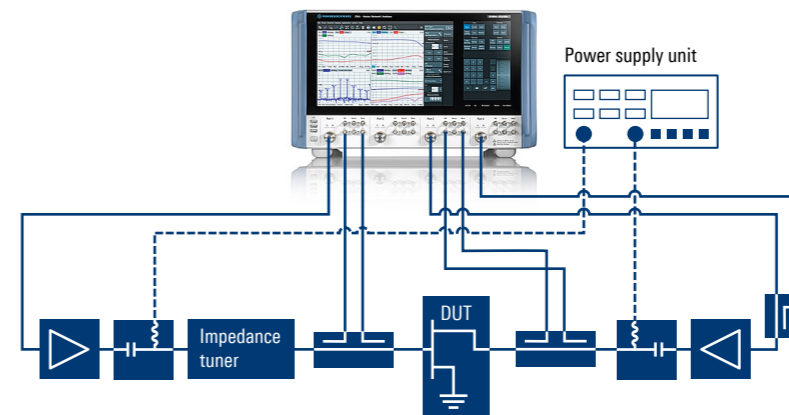

# APPLICATIONS

# PASSIVE DEVICE CHARACTERIZATION

With an exceptional dynamic range and versatile measurement and analysis features the R&S®ZNA is prepared for the characterization of challenging passive devices.

## The task

Even passive device characterization may require a wide feature set and challenging instrument specifications:

- ▶ Get maximum throughput in production
- ▶ Minimize sweep time by finding the golden optimum between accuracy and sweep speed
- ▶ Short measurement times despite high dynamic range
- ▶ Comprehensive online analysis, pass/fail
- ▶ Measurement system and handler synchronization

The online analysis functions of the R&S®ZNA enable comprehensive DUT certification without external data analysis. Preloaded setups are represented by tabs and setup swap is done at the click of a mouse. Distributed over several screens (setups), a multitude of results is clearly displayed, and the R&S®ZNA is quickly ready for a new DUT.

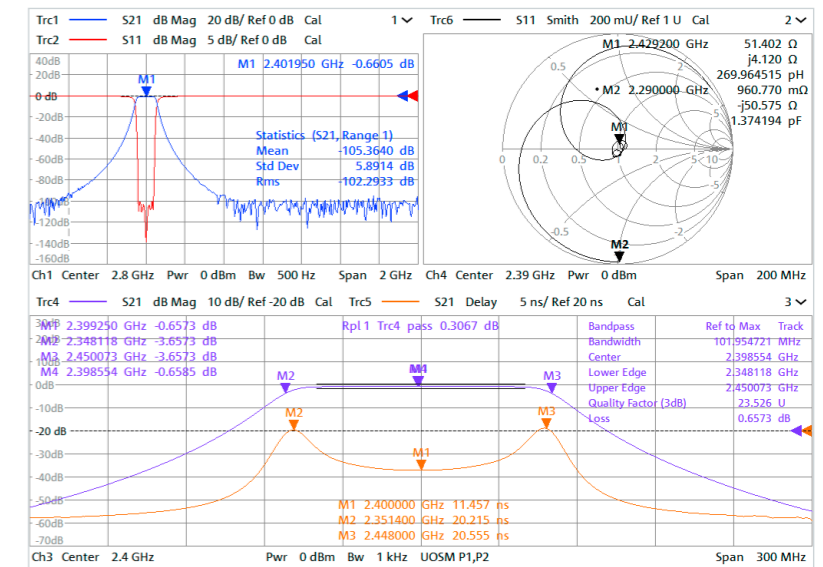

The 'Define Segments' dialog box contains a table for defining sweep segments:

On	Start	Stop	Points	Pwr (Pb)	Bandw
<input checked="" type="checkbox"/>	1.4 GHz	2.33 GHz	401	5 dBm	100 Hz
<input checked="" type="checkbox"/>	2.33 GHz	2.45 GHz	201	-10 dBm	1 kHz
<input checked="" type="checkbox"/>	2.45 GHz	3.4 GHz	401	5 dBm	100 Hz

Buttons at the bottom include: Add, Delete, Import..., Show Point List..., Insert, Delete All, Export..., Displayed Columns..., OK, Cancel, and Help.

The segmented sweep allows definition of different test parameters for subsegments of a sweep, e.g. high power and narrow IFBW in the stop band of a filter for high dynamic, and a wider IFBW and narrow frequency grid for short test time and high resolution in the pass band.

## R&S®ZNA benefits for passive device characterization with challenging DUTs

### Function/feature

- Up to 170 dB dynamic range<sup>1)</sup>
- Segmented sweep (number of points, power, IFBW, other, for subsegments of a sweep)
- Filter/marker online analysis, limit lines/ripple test
- Multiple parallel preloaded setups

### Benefits

- Provides high accuracy even with high-blocking filters
- Ensures the optimum balance of accuracy, test time, and RF performance depending on the DUT properties
- Offers a comprehensive evaluation and certification of the DUT
- ▶ Reconfigure the measurement task at a mouse click, no time-consuming setup reload required
- ▶ Smart control and clear display of numerous measurement parameters, even for multiple DUTs

<sup>1)</sup> Applies in the lower frequency range, options required, data confidence level: "measured".



# HIGH-POWER AMPLIFIER AND LNA TESTING

The R&S®ZNA enables high-power amplifier and LNA testing under real operating conditions.

## The task

The variety of test parameters and test setups for amplifier characterization calls for a wide range of personalities and configuration flexibility of the test equipment:

- ▶ Handling of very high power levels, external high-power test setups
- ▶ Ensuring stable and drift-independent power levels
- ▶ Multiple tones for intermodulation tests, even on mixers
- ▶ Measurements under pulsed conditions
- ▶ Active device with differential structures
- ▶ Evaluation of noise figure and noise parameters of unmatched DUTs under variable matching conditions

## Direct channel access option

With the direct channel access option, as well as source and receiver step attenuators, the R&S®ZNA supports external high-power test setups (with external preamplifier in forward and reverse directions, high-power couplers, attenuators and circulators)

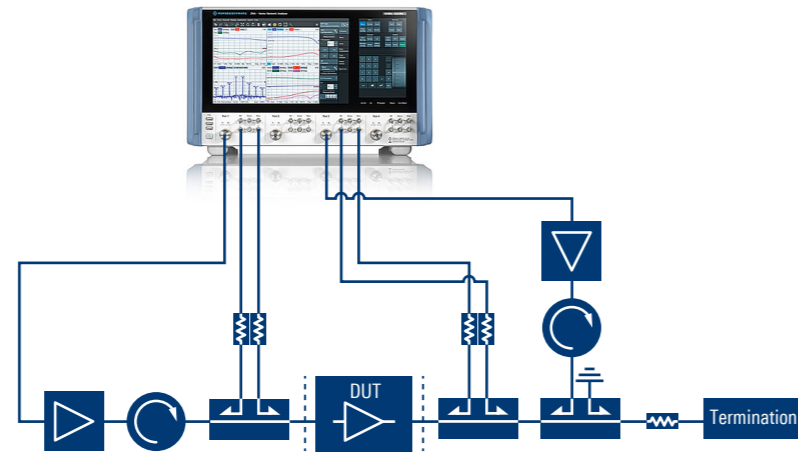

# RECEIVER AND LNB CHARACTERIZATION

The R&S®ZNA enables reliable (high-gain) receiver and LNB characterization with a simple setup.

## The task

There are several special aspects which make high-gain converter testing challenging:

- ▶ Requirement of several sources for intermodulation test with dual LO devices (with LO access)
- ▶ IF frequency offset from an internal oscillating LO
- ▶ Mixer group delay test without LO access
- ▶ Noise figure test on mixers
- ▶ High accuracy, low traces noise, and short test time despite of very low stimulation power

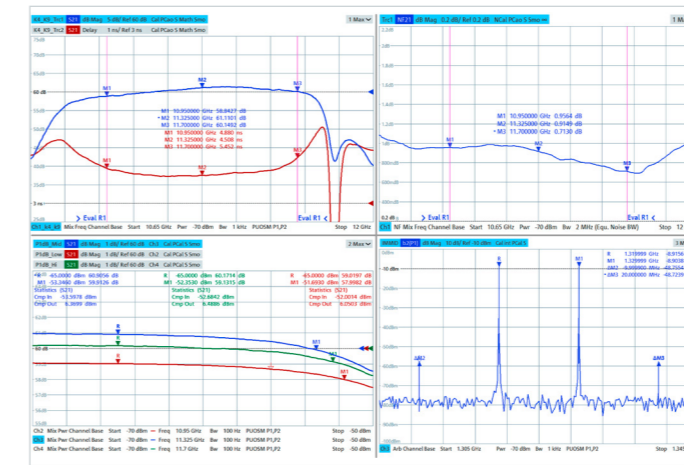

## Embedded LO converter test setup

With dedicated functions, such as LO tracking and two-tone based group delay measurement, R&S®ZNA enables a reliable and comprehensive characterization of frequency converters without access to the internal local oscillator

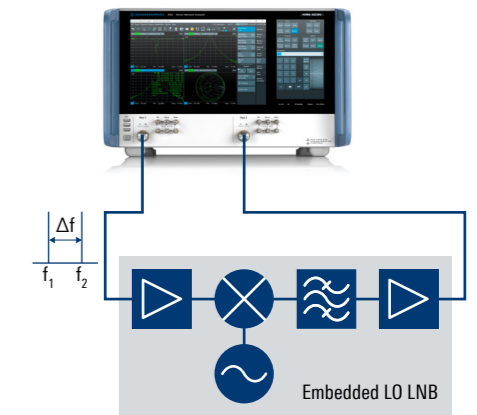

Example result screen of embedded LO converter testing: conversion gain, group delay, noise figure, compression, intermodulation

## R&S®ZNA benefits for high-power amplifier and LNA testing

Function/feature	Benefits
Up to 4 internal, independently configurable sources, internal combiner	Intermodulation testing (without external sources) at full speed and configuration flexibility, even in combination with mixers
Unique power sweep range of 100 dB, attenuators, compression point personality	Compression evaluation over wide power ranges, including real-time compression point (CP) evaluation
Combination of sweep modes	Magnitude and frequency offset swept measurements, AM/AM and AM/PM tests
Digital automatic level control (ALC), with arbitrary reference signal access	Accurate and stable stimulation power even with external preamplifiers
Control of external power supply units	Power added efficiency (PAE) test
Four integrated pulse modulators, pulse profile test option	High-power point-in-pulse test, pulse profile analysis
True differential mode	Reliable characterization of differential amplifiers without external bal-uns, mode-conversion parameters and phase/magnitude imbalance sweeps
Noise figure personality and preamplifier	Noise figure tests without reconnection and noise source
Source phase control, partner system integration (Focus Microwaves and Maury Microwave): active harmonic load pull	<ul style="list-style-type: none"> <li>▶ On-wafer chip characterization</li> <li>▶ Impedance tuning for unmatched amplifiers</li> <li>▶ Active harmonic load pull testing (with electronic and hybrid impedance tuning)</li> </ul>

## R&S®ZNA benefits for receiver and LNB characterization

Function/feature	Benefits
Up to 4 internal, independently configurable sources, internal combiner	Intermodulation testing of converters with (accessible) dual LO conversion
Unique solution for embedded LO converter group delay test (R&S®ZNA-K9) and LO tracking function	Measure converter group delay (GD) reliable despite of significant DUT LO drift, and without access to the internal LO
Flexible frequency conversion capability and mixer phase measurement option	Phase measurements on converters, LO crosstalk, etc.
Selectable reference signal access for the stimulation source signal	Get a sufficient strong reference signal despite of extremely low stimulation power for low trace noise
Port 1 isolation amplifier	Get extremely low spur free stimulation signal
Noise figure test options, combined with mixer test setup	Comprising characterization without reconnection, including noise figure test without a noise source
2-port R&S®ZNA with 2 sources and internal combiner	Get intermodulation, group delay and noise figure (NF) from embedded LO converters with a 2-port R&S®ZNA

# T/R MODULE AND RADAR AESA TESTING

The R&S®ZNA enables comprehensive transmit/receive (T/R) module and radar active electronically scanned array (AESA) testing with a single connection.

## The task

T/R modules combine both transmitting and receiving submodules, which requires the following of measurement capabilities:

- ▶ Features for amplifier testing: compression point (CP), intermodulation (IM), noise figure (NF)
- ▶ Handling of very high and very low power
- ▶ Multiple frequency conversion with embedded mixer LO
- ▶ Multiple phase-controlled sources
- ▶ Enhanced DUT control and system support

Typical elements of a radar T/R module, highlighting the challenges for the VNA to characterize single components and the entire module

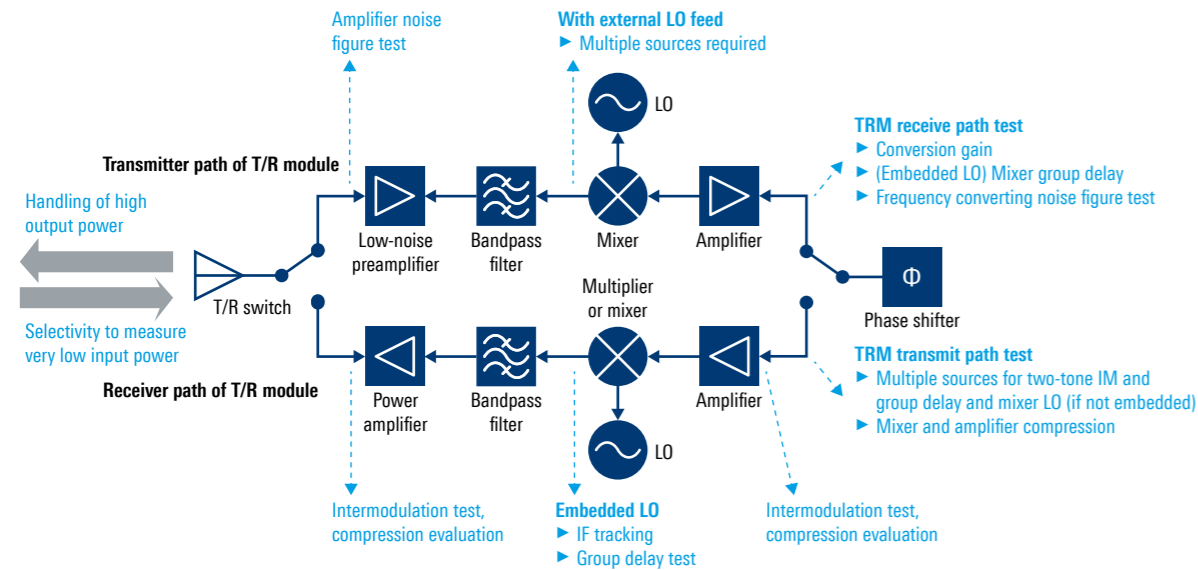

# SIGNAL INTEGRITY TESTING

With the enhanced TDR option and deembedding personalities, the R&S®ZNA enables evaluation of the signal transmission quality of lines, cables and PCB structures, including correction techniques for in-fixture, and on-PCB testing.

## The task

Increasing data volumes and bit rates demand precise characterization of cables, transmission lines and PCB structures at ever increasing frequency ranges. Simply testing in time and frequency provides reliable characterization, but in-fixture and on-board mounted DUTs call for additional deembedding functionalities:

- ▶ Combination of enhanced time domain analysis results (TDR) and S-parameters
- ▶ In-fixture calibration techniques
- ▶ Techniques for fixture and PCB structure characterization and deembedding
- ▶ Flexible single and multiport configuration

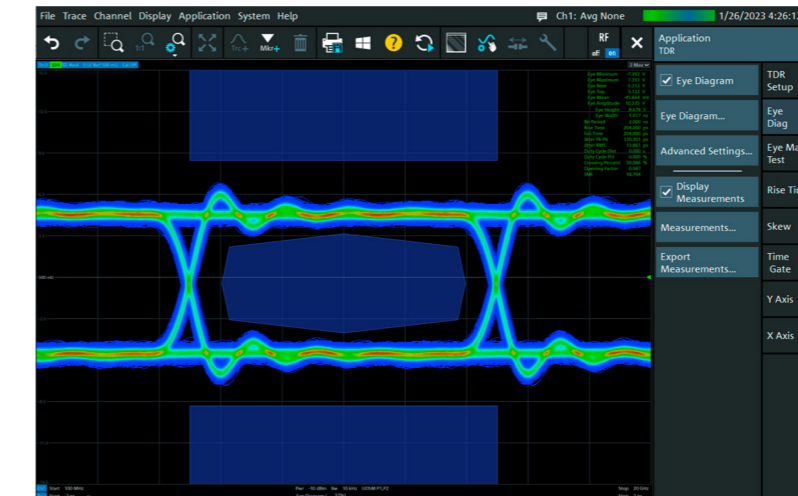

Eye diagram mask test with synthetic signal predistortion

## R&S®ZNA benefits for T/R module and radar AESA testing

Function/feature	Benefits
Up to 4 internal sources with flexible sweep mode configuration and internal combiner	<ul style="list-style-type: none"> <li>▶ Receiver intermodulation and compression testing</li> <li>▶ Frequency-converting modules with LO access: support of dual LO design</li> <li>▶ Group delay testing of embedded LO devices</li> </ul>
Phase-coherent source control	<ul style="list-style-type: none"> <li>▶ Phase measurements on converters</li> <li>▶ Radiation pattern testing with beamforming submodules</li> </ul>
Multichannel spectrum analysis option	Spur search with all R&S®ZNA receivers, effective with up to 4 receivers in parallel
Enhanced trigger and pulsed I/O	DUT synchronization and control for DUT phase and power settings with synchronized measurement
2-port R&S®ZNA with two sources and options for high/low power and noise figure tests	Comprising characterization of a 2-port T/R module with an R&S®ZNA with two test ports (IM, CP, embedded LO converter group delay)

## R&S®ZNA benefits for signal integrity testing

Function/feature	Benefits
TDR with various filter and frequency grid configurations, including distance-to-fault test and synthetic frequency extension (R&S®ZNA-K2 option)	<ul style="list-style-type: none"> <li>▶ Optimization of TDR measurement for optimal resolution and band-limited DUTs</li> <li>▶ Easy cable distortion analysis</li> <li>▶ TDR results at a higher resolution than given by DUT band-limitation and the R&amp;S®ZNA frequency range</li> </ul>
Enhanced TDR/eye diagram, including bit stream and modulation simulation (R&S®ZNA-K20 option)	Simulated eye diagram analysis for transmission characterization without real pulsed signals
Enhanced in-fixture calibration techniques: TRL/LRL, TNA, TRM, TSM, TOM (R&S®ZNA-K210, -K220, -K230, -K231 options)	Direct in-fixture calibration with custom calibration standards (partially unknown and reduced number of standards)
Enhanced deembedding personalities based on custom tools from partner company	Test coupon based in-fixture and PCB structure characterization including deembedding

# ANTENNA MEASUREMENTS – THE PERFECT FIT

With its wide range of hardware and software functions, the R&S®ZNA can be used as the high-performing core in near-field, far-field, compact range and radar cross section (RCS) antenna test systems.

## Fast antenna characterization

The outstanding receiver sensitivity of the R&S®ZNA, in combination with fast synthesizers, speeds up antenna characterization even when measuring very low signal levels. The analyzer's high sensitivity, low trace noise, wide range of selectable IF bandwidths and various averaging functions help to find the optimum balance of short test times and high accuracy.

For test systems employing external mixers, the R&S®ZNA allows flexible, independent configuration of the frequencies and powers for all sources and receivers, as well as direct IF signal path access with selectable IF frequencies.

## Measurements on antenna arrays

The R&S®ZNA can provide stimulus signals from up to four sources, making it possible to measure the directional pattern of electronically controlled antenna arrays. In addition, the internal LO signal (standard LO or second internal LO source up to 26.5 GHz) is accessible on the rear panel. This means that up to five sources are available for feeding antenna arrays or for external up/down conversion.

Featuring a true parallel receiver architecture with up to eight receivers, the analyzer reliably measures the amplitude and phase of up to eight input signals. The R&S®ZNA can therefore be used as a compact multichannel receiver to design antenna arrays and subarrays for MIMO mobile communications systems, or it can be used as part of antenna test systems employing horizontally and/or vertically polarized antennas as well as reference receiving antennas.

## RCS measurements and measurements on complete RX modules

The R&S®ZNA can perform RCS measurements and measurements on complete RX modules without any external test equipment. With up to four signal sources, up to four internal pulse modulators and generators, up to eight true receivers, and the ability to sample up to 16 wave quantities in parallel, the R&S®ZNA provides signal generation and multichannel measurements in a single, compact platform (see also "Pulsed measurements – fast and simple", page 38).

## Data streaming mode

The R&S®ZNA-K28 data streaming mode option allows continuous sweep recording and writing to a circular buffer. The controlled timing feature ensures constant measurement times for every sweep point and gapless recording. Thus, the user-defined number of sweeps and traces is merged to one common data set.

## Partner system integration

With systems from Rohde&Schwarz and its partner companies, Rohde&Schwarz provides complete free-field, far-field and RCS test systems.

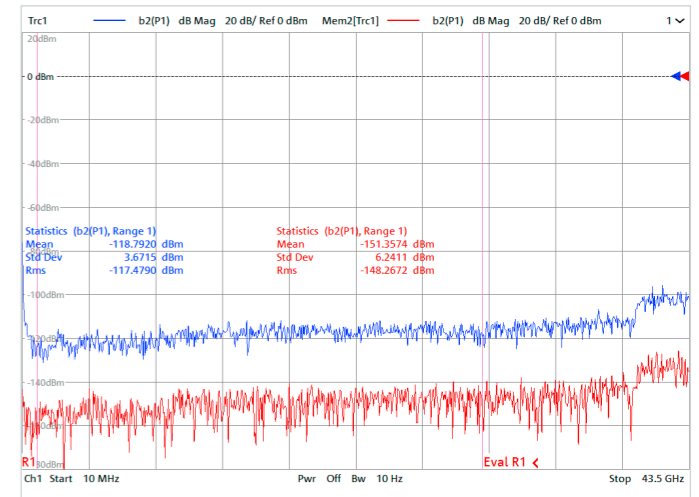

The sensitivity of the R&S®ZNA26/R&S®ZNA43 receivers can reach –150 dBm (lower frequency end, typical, at 1 Hz IFBW, direct channel access/reversed coupler, receiver step attenuator in 0 dB position). The sensitivity of the b1 and b2 receivers is increased further by using the R&S®ZNAxx-B302 and R&S®ZNAxx-B501 preamplifiers.

## R&S®ZNA benefits for antenna measurements

Function/feature	Benefits
High receiver sensitivity up to –151 dBm (1 Hz) (typ., with direct receiver access)	Short measurement times
Inputs for direct access to IF signal paths, selectable IF frequencies with 1 GHz bandwidth	Use in high-frequency test systems with external mixers Adaptation to optimal IF of test system
Identical RF design of all receivers	Identical characteristics of measurement and reference channels
Up to 5 internal sources <sup>1)</sup>	<ul style="list-style-type: none"> <li>▶ Multi-antenna stimulation</li> <li>▶ LO signals for external mixers</li> </ul>
Configuration of arbitrary frequency-converting measurements	Universal support for external mixers and mmWave systems
Reverse frequency sweep	<ul style="list-style-type: none"> <li>▶ Alternating movement of positioner (CW, CCW in azimuth, as well as movement in elevation)</li> <li>▶ Spherical near-field measurements</li> </ul>
Extended trigger functionality	<ul style="list-style-type: none"> <li>▶ Optimal synchronization of positioner, clock generators, etc.</li> <li>▶ Simple and flexible system integration</li> </ul>
Truly parallel receiver architecture	<ul style="list-style-type: none"> <li>▶ Measurements with up to eight receivers (no multiplexing)</li> <li>▶ Simultaneous measurements of multiple antenna polarizations (horizontal/vertical) and antenna arrays (MIMO)</li> </ul>
mmWave converters	Measurements in mmWave range

<sup>1)</sup> Up to four RF sources plus LO source (on rear panel output, 2nd internal LO source up to 26.5 GHz).

The R&S®ZNA forms the powerful core in antenna test systems

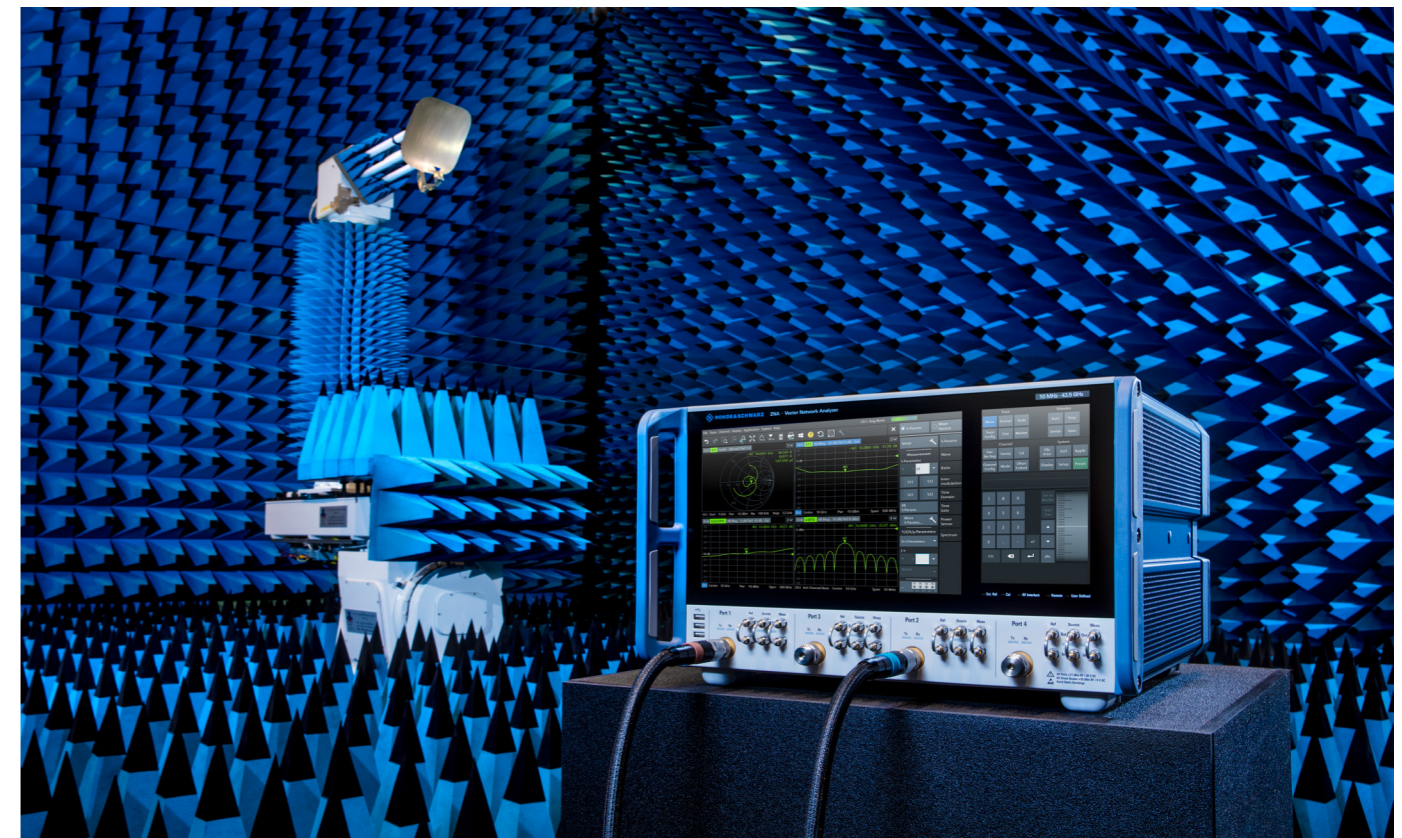

# mmWave MEASUREMENTS

Frequency bands in the mmWave and terahertz ranges are used in many applications in the mobile communications, automotive, security, semiconductor and fundamental research sectors. Automotive radar at 77 GHz/79 GHz, mobile communications in the 5G frequency bands, and radars and sensors up to and beyond 100 GHz all require the characterization of active and passive components such as filters, amplifiers, mixers and antennas.

## Frequency extension into the terahertz range

The R&S®ZVA-Zxxx and R&S®ZCxxx mmWave converters extend the R&S®ZNA frequency range up to 1.1 THz. Many applications, in particular on-wafer component characterization and antenna measurements, call for frequency converters with high output powers. The high operating frequencies of the components under test lead to significant losses in waveguides, probe tips and along the transmission path. The Rohde & Schwarz frequency converters feature high output powers and excellent dynamic range. They can be used to characterize active and passive DUTs.

## Compact systems with dedicated options

The optional R&S®ZNA-B8 mmWave converter LO output makes the analyzer's internal LO signal available at the rear panel. The signal comes from the standard LO or, when a second internal LO is installed, from the 2nd LO. It provides up to +25 dBm output power, which is sufficient to feed up to four frequency converters connected to the R&S®ZNA. Configuration of the R&S®ZNA-B8 output for use with mmWave converters requires the R&S®ZNA-K8 option (mmWave converter support). The output power can be automatically calibrated to compensate for any losses introduced by cables and splitters. With the R&S®ZNA-B26 direct IF access option installed, the converters' measurement and reference signals are directly fed to the analyzer's IF path. The R&S®ZNAxx-B16 direct source and receiver access option can be used alternatively.

## Overview of R&S®ZCxxx mmWave converters

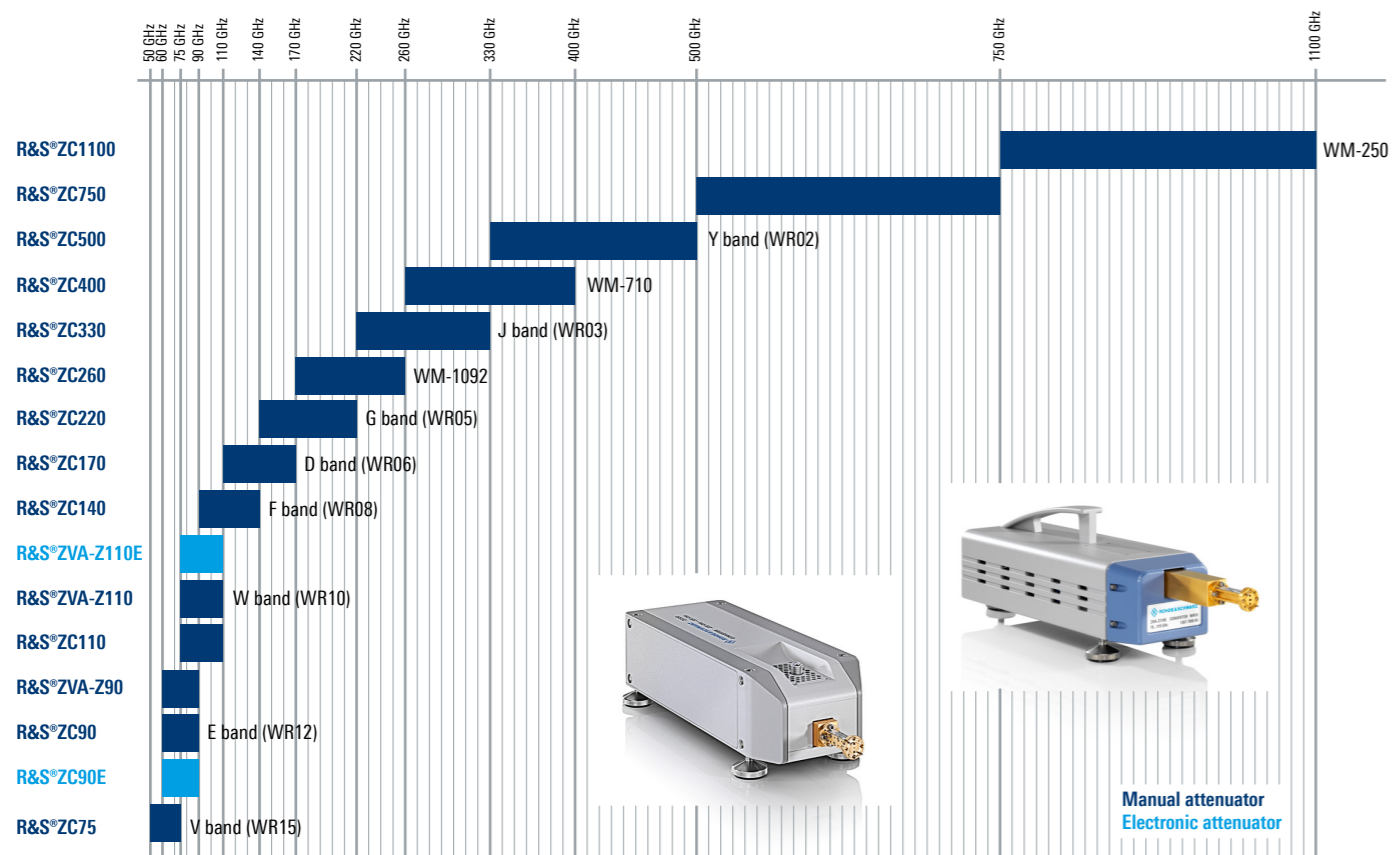

## Special features of R&S®ZVA-Zxxx and R&S®ZCxxx mmWave converters

- ▶ High output powers and wide dynamic range
- ▶ Easy configuration via straightforward dialog
- ▶ Multipoint measurements with up to four converters without an external source
- ▶ Variable output power (manual adjustment with screw and/or control of output power by varying the input power)
- ▶ Amplifier characterization, power sweeps, compression point measurements
- ▶ Intermodulation measurements using MagicT setups
- ▶ R&S®ZNA-K1 spectrum analysis support in the mmWave range
- ▶ Phase coherence stimulation
- ▶ Absolute level calibration using power test heads from Rohde & Schwarz and Eriksson PM5/PM5B
- ▶ Automatic level control (ALC) usable in the mmWave range
- ▶ Pulsed measurements
- ▶ On-wafer component characterization, integration into MPI Corporation and FormFactor (formerly Cascade Microtech) wafer prober systems
- ▶ Waveguide calibration kits (with or without sliding match) for all frequency bands of the converters
- ▶ High time and temperature stability
- ▶ Frequency-converting measurements<sup>1)</sup>
- ▶ Integration in (active) load pull test systems from Focus Microwaves and Maury Microwave
- ▶ Supported by mmWave material test systems from company SwissTo12

<sup>1)</sup> Converters with different frequency ranges can be used; external source(s) may be required, depending on setup/configuration.

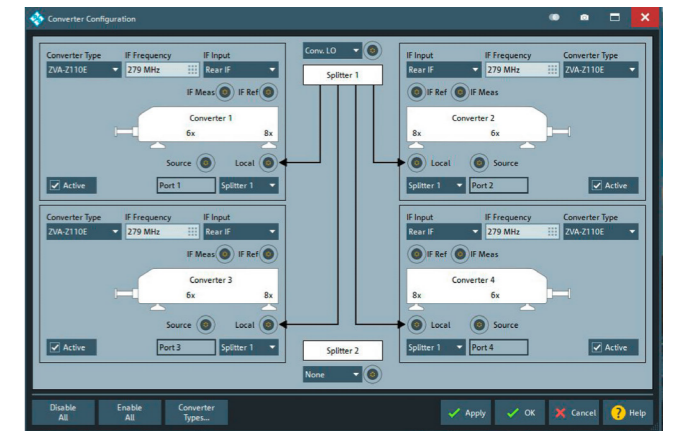

Software configuration

## Software configuration

- ▶ Straightforward dialog for configuring 1-port to 4-port mmWave converter setups
- ▶ Menu-based selection of R&S®ZVA-Zxxx converter(s); automatic detection of R&S®ZCxxx converter(s)
- ▶ Configuration of customer's mmWave converters
- ▶ Support of Rohde & Schwarz and Erickson power sensors for absolute power level calibration up to 750 GHz
- ▶ Configuration of frequency-converting measurements<sup>1)</sup>



Setup for mmWave measurements with an R&S®ZNA43 and two R&S®ZC330 mmWave converters WM-864

### Hardware configuration

- ▶ Rear panel LO output up to +25 dBm (R&S®ZNA-B8 mmWave converter LO option) reliably provides converters with desired power even with long cables and LO splitters
- ▶ Use of direct IF inputs on R&S®ZNA rear panel

- ▶ Direct IF inputs with 1 GHz bandwidth for flexible integration of customer's mmWave converters
- ▶ Compact test setups: 2/4-port mmWave converter setups with 2/4-port R&S®ZNA, no external source or adapter box required

### Hardware configuration for mmWave measurements

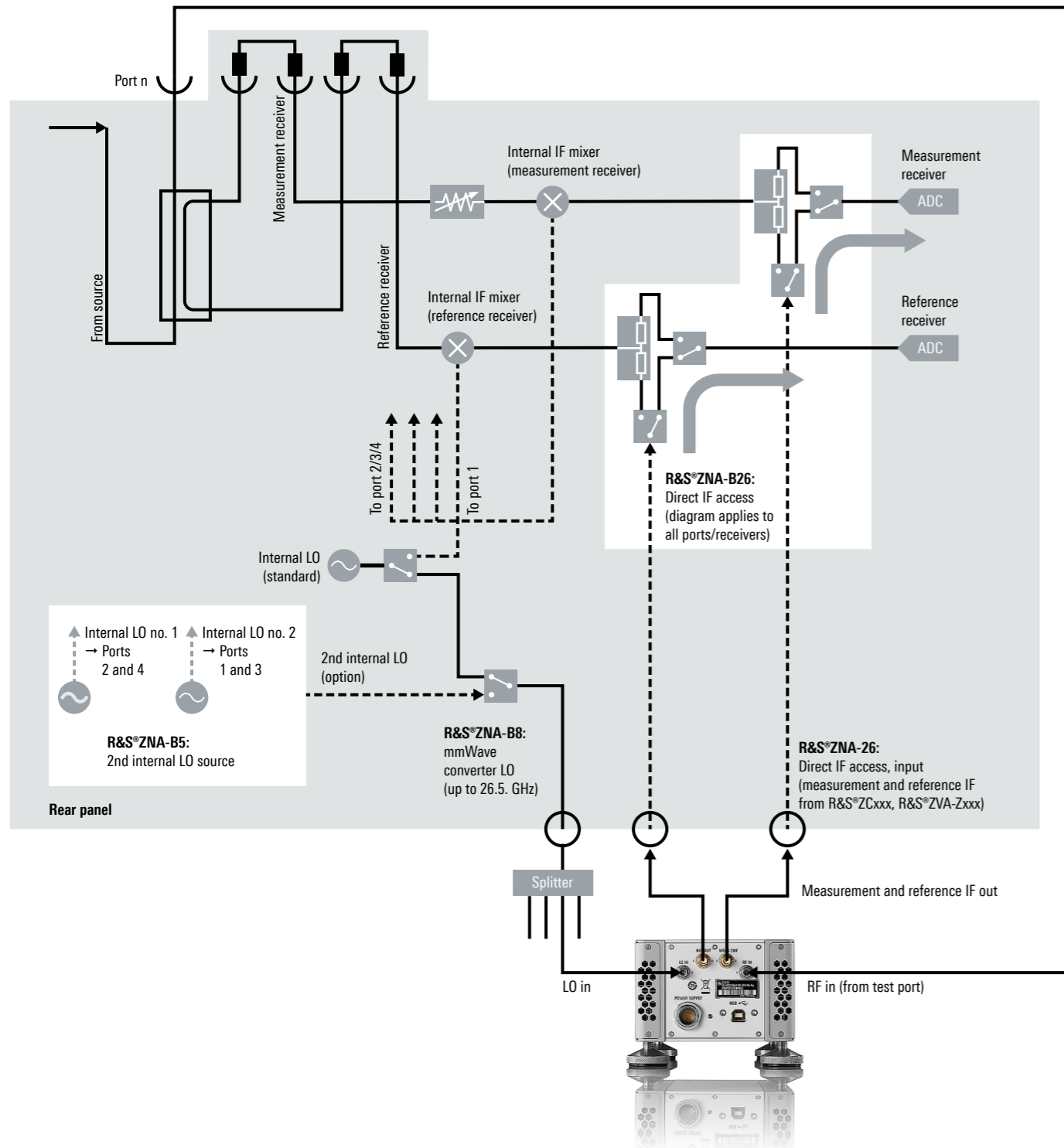

4-port R&S®ZNA67EXT single sweep system up to 110 GHz



### R&S®ZNA67EXT vector network analyzer system: single sweep system up to 110 GHz

Some applications, such as on-wafer transistor characterization, require a single sweep from 10 MHz to 110 GHz with only one probe contact. The R&S®ZNA67EXT system is an extension of the R&S®ZNA67 with converters and diplexers to allow a single sweep from 10 MHz to 110 GHz with a coaxial 1 mm connector.

The system is available with two or four 1 mm test ports. The 2-port system can be configured with a 2-port R&S®ZNA67 or a 4-port R&S®ZNA67 base unit, whereas the 4-port system always requires a 4-port R&S®ZNA67 base unit.

All systems are available in standard power configuration not subject to export control and high-power systems subject to export control.

# TVAC TESTING AND SATELLITE TVAC TESTING

The R&S®ZNA provides reliable results with thermal vacuum chamber (TVAC) testing and satellite TVAC testing.

A VNA system error correction (SEC) requires the connection of single calibration standards or an automatic calibration unit, but for subsequent measurement, the calibration equipment is disconnected and the DUT is connected instead. However, there are mainly two application cases where this procedure is not applicable: TVAC testing/satellite TVAC testing and multipoint testing/production testing.

**TVAC testing/satellite TVAC testing:** After evacuation and at every change of temperature, the RF response of test set components inside the chamber is potentially changed.

However, there is no access to the reference planes in the TVAC chamber to connect calibration equipment for a recalibration.

**Multipoint testing/production testing:** Especially in cases where there is a combination of both multipoint DUT in production and numerous cables that are continuously moved, frequent recalibration is required. The R&S®ZN-Z3xx inline calibration units are designed to stay permanently in the reference plane, thus enabling frequent remote-controlled recalibration at a keystroke, without the need to access the test setup.

## Schematic TVAC setup with Rohde & Schwarz inline calibration units

The inline calibration units (ICU) are connected to the DUT inside the chamber. Recalibration at each change of temperature and path switching is controlled by the R&S®ZNA and the R&S®ZN-Z30 ICU controller.

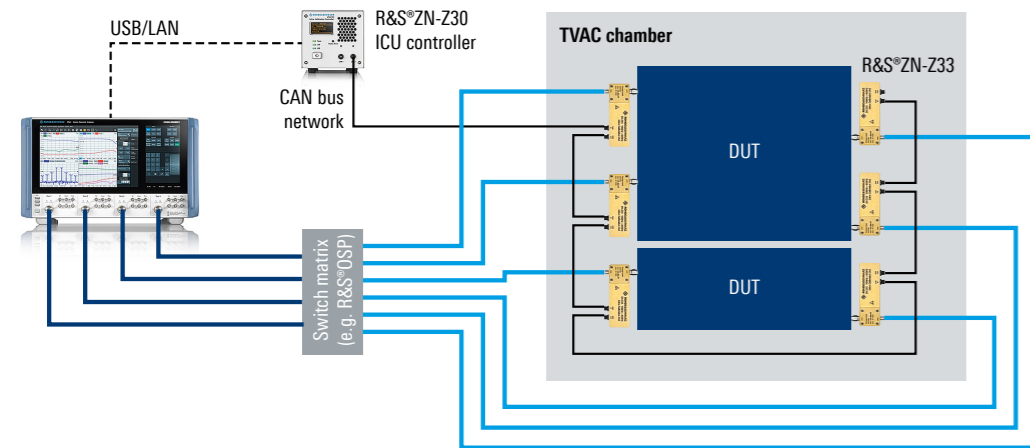

## R&S®ZNA benefits for TVAC testing/satellite TVAC testing

Function/feature	Benefits
Firmware integration	<ul style="list-style-type: none"> <li>▶ Base calibration and recalibration included in the R&amp;S®SMARTerCal environment</li> <li>▶ Calibration update in TVAC chambers and with multipoint setups in a few keystrokes</li> </ul>
CAN bus network structure	<ul style="list-style-type: none"> <li>▶ A single controller supports up to 48 modules (corresponds to 48 connections)</li> <li>▶ Distances up to 20 m possible</li> <li>▶ Plug &amp; play configuration</li> </ul>
Extended feature range: power calibration (base calibration only), deembedding, mixer measurements	<ul style="list-style-type: none"> <li>▶ Get accurate stimulation power even in TVAC chamber testing</li> <li>▶ Correct for auxiliary components (adapters, splitter)</li> <li>▶ Converter testing in TVAC</li> </ul>

# MULTIPOINT EXTENSIONS

With predefined port groups and USB auto detection, multipoint systems based on R&S®ZN-Z8x switch matrices are configured in a few key strokes. RF switch and control tasks are quick and easy to perform with the modular R&S®OSP open switch and control platform. The latest R&S®OSP generation comes with an extended range of modules, allowing an even wider variety of RF wiring configurations.

R&S®ZN-Z84 switch matrix, plug & play controlled (with 24 ports optional)



R&S®OSP220 and R&S®OSP230 open switch and control platforms

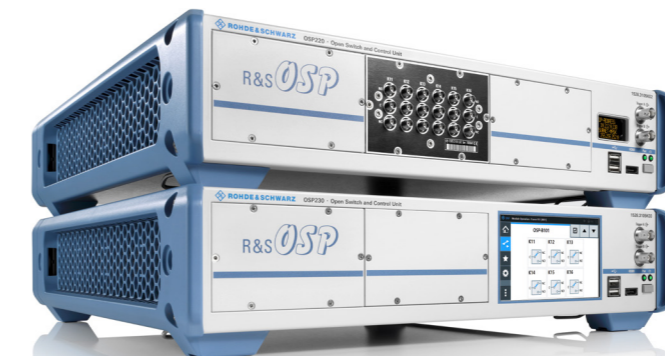

Rear view of the R&S®OSP320

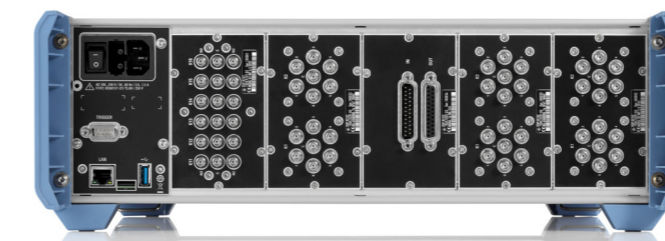

A wide range of applications – from passive distributions to antenna beamforming arrays – requires multipoint extension modules. The R&S®ZNA supports plug & play solutions as well as individually configurable switch matrices:

- ▶ The R&S®ZN-Z8x switch matrices are configurable with 6 to 24 ports and full crossbar, ranging up to 8 GHz/20 GHz
- ▶ The R&S®OSP open switch and control platform offers a freely configurable framework. Switch modules ranging from basic single pole, double throw (SPDT) to multiple I/O design can be combined in one rack frame and configured by channel as required.

## R&S®ZNA benefits using multipoint extensions

Function/feature	Benefits
R&S®ZN-Z8x switch matrix with up to 8 GHz (6 to 24 ports) or 20 GHz (6 and 12 ports)	Easy plug & play configuration of predefined sets of port groups
R&S®OSP open switch and control platform with up to 6 switch modules, combination of single pole, double throw (SPDT) and throughout multiple I/O design	<ul style="list-style-type: none"> <li>▶ Application-specific combination of switch modules</li> <li>▶ Active multipoint device testing up to 67 GHz</li> </ul>

# ORDERING INFORMATION

Designation	Type	Frequency range	Order No.	Remarks
<b>Base units</b>				
Vector network analyzer, 2 ports, 26.5 GHz, 3.5 mm connectors	R&S®ZNA26	10 MHz to 26.5 GHz	1332.4500.22	
Vector network analyzer, 4 ports, 26.5 GHz, 3.5 mm connectors	R&S®ZNA26	10 MHz to 26.5 GHz	1332.4500.24	
Vector network analyzer, 2 ports, 43.5 GHz, 2.92 mm connectors	R&S®ZNA43	10 MHz to 43.5 GHz	1332.4500.42	
Vector network analyzer, 2 ports, 43.5 GHz, 2.4 mm connectors	R&S®ZNA43	10 MHz to 43.5 GHz	1332.4500.43	
Vector network analyzer, 4 ports, 43.5 GHz, 2.92 mm connectors	R&S®ZNA43	10 MHz to 43.5 GHz	1332.4500.44	
Vector network analyzer, 4 ports, 43.5 GHz, 2.4 mm connectors	R&S®ZNA43	10 MHz to 43.5 GHz	1332.4500.45	
Vector network analyzer, 2 ports, 50 GHz, 2.4 mm connectors	R&S®ZNA50	10 MHz to 50 GHz	1332.4500.52	
Vector network analyzer, 4 ports, 50 GHz, 2.4 mm connectors	R&S®ZNA50	10 MHz to 50 GHz	1332.4500.54	
Vector network analyzer, 2 ports, 67 GHz, 1.85 mm connectors	R&S®ZNA67	10 MHz to 67 GHz	1332.4500.62	
Vector network analyzer, 4 ports, 67 GHz, 1.85 mm connectors	R&S®ZNA67	10 MHz to 67 GHz	1332.4500.64	
<b>Options</b>				
Direct source and receiver access, for R&S®ZNA26 (2 ports)	R&S®ZNA26-B16	100 kHz to 26.5 GHz	1332.4581.22	
Direct source and receiver access, for R&S®ZNA26 (4 ports)	R&S®ZNA26-B16	100 kHz to 26.5 GHz	1332.4581.24	
Direct source and receiver access, for R&S®ZNA43 (2 ports)	R&S®ZNA43-B16	100 kHz to 43.5 GHz	1332.4581.42	
Direct source and receiver access, for R&S®ZNA43 (4 ports)	R&S®ZNA43-B16	100 kHz to 43.5 GHz	1332.4581.44	
Direct source and receiver access, for R&S®ZNA50 (2 ports)	R&S®ZNA50-B16	10 MHz to 50 GHz	1332.4581.52	
Direct source and receiver access, for R&S®ZNA50 (4 ports)	R&S®ZNA50-B16	10 MHz to 50 GHz	1332.4581.54	
Direct source and receiver access, for R&S®ZNA67 (2 ports)	R&S®ZNA67-B16	10 MHz to 67 GHz	1332.4581.62	
Direct source and receiver access, for R&S®ZNA67 (4 ports)	R&S®ZNA67-B16	10 MHz to 67 GHz	1332.4581.64	
Source step attenuator, port n, for R&S®ZNA26	R&S®ZNA26-B2n	10 MHz to 26.5 GHz	1332.4630.2n	n designates the port number (1/2/3/4)
Source step attenuator, port n, for R&S®ZNA43	R&S®ZNA43-B2n	10 MHz to 43.5 GHz	1332.4646.2n	n designates the port number (1/2/3/4)
Source step attenuator, port n, for R&S®ZNA50	R&S®ZNA50-B2n	10 MHz to 50 GHz	1332.5007.2n	n designates the port number (1/2/3/4)
Source step attenuator, port n, for R&S®ZNA67	R&S®ZNA67-B2n	10 MHz to 67 GHz	1332.5013.2n	n designates the port number (1/2/3/4)
Receiver step attenuator, port n, for R&S®ZNA26	R&S®ZNA26-B3n	10 MHz to 26.5 GHz	1332.4700.3n	n designates the port number (1/2/3/4)
Receiver step attenuator, port n, for R&S®ZNA43	R&S®ZNA43-B3n	10 MHz to 43.5 GHz	1332.4717.3n	n designates the port number (1/2/3/4)
Receiver step attenuator, port n, for R&S®ZNA50	R&S®ZNA50-B3n	10 MHz to 50 GHz	1332.5020.3n	n designates the port number (1/2/3/4)
Receiver step attenuator, port n, for R&S®ZNA67	R&S®ZNA67-B3n	10 MHz to 67 GHz	1332.5036.3n	n designates the port number (1/2/3/4)
Internal pulse modulator, port n, for R&S®ZNA26	R&S®ZNA26-B4n	10 MHz to 26.5 GHz	1332.4775.4n	n designates the port number (1/2/3/4)
Internal pulse modulator, port n, for R&S®ZNA43	R&S®ZNA43-B4n	10 MHz to 43.5 GHz	1332.4781.4n	n designates the port number (1/2/3/4)
Internal pulse modulator, port n, for R&S®ZNA50	R&S®ZNA50-B4n	10 MHz to 50 GHz	1332.5088.4n	n designates the port number (1/2/3/4)
Internal pulse modulator, port n, for R&S®ZNA67	R&S®ZNA67-B4n	10 MHz to 67 GHz	1332.5094.4n	n designates the port number (1/2/3/4)
3rd and 4th internal source, for R&S®ZNA26 (4 ports)	R&S®ZNA26-B3	10 MHz to 26.5 GHz	1332.4523.02	
3rd and 4th internal source, for R&S®ZNA43 (4 ports)	R&S®ZNA43-B3	10 MHz to 43.5 GHz	1332.4617.02	
3rd and 4th internal source, for R&S®ZNA50 (4 ports)	R&S®ZNA50-B3	10 MHz to 50 GHz	1332.4981.02	
3rd and 4th internal source, for R&S®ZNA67 (4 ports)	R&S®ZNA67-B3	10 MHz to 67 GHz	1332.4998.02	

Designation	Type	Frequency range	Order No.	Remarks
2nd LO and RF source, for R&S®ZNA26 (2 ports)	R&S®ZNA26-B52	10 MHz to 26.5 GHz	1332.6503.02	
2nd LO and RF source, for R&S®ZNA40 (2 ports)	R&S®ZNA40-B52	10 MHz to 43.5 GHz	1332.6510.02	
2nd LO and RF source, for R&S®ZNA50 (2 ports)	R&S®ZNA50-B52	10 MHz to 50 GHz	1332.6526.02	
2nd LO and RF source, for R&S®ZNA67 (2 ports)	R&S®ZNA67-B52	10 MHz to 67 GHz	1332.6532.02	
Direct source monitor access, port 1, for R&S®ZNA26	R&S®ZNA26-B161	10 MHz to 26.5 GHz	1332.4823.51	2-port and 4-port R&S®ZNA, requires R&S®ZNA26-B16, R&S®ZNA26-B21
Direct source monitor access, port 1 and port 3, for R&S®ZNA26	R&S®ZNA26-B163	10 MHz to 26.5 GHz	1332.4823.53	4-port R&S®ZNA, requires R&S®ZNA26-B16, R&S®ZNA26-B21, R&S®ZNA26-B23
Direct source monitor access, port 1, for R&S®ZNA43	R&S®ZNA43-B161	10 MHz to 43.5 GHz	1332.4303.51	2-port and 4-port R&S®ZNA, requires R&S®ZNA43-B16, R&S®ZNA43-B21
Direct source monitor access, port 1 and port 3, for R&S®ZNA43 <sup>2)</sup>	R&S®ZNA43-B163	10 MHz to 43.5 GHz	1332.4830.53	4-port R&S®ZNA, requires R&S®ZNA43-B16, R&S®ZNA43-B21, R&S®ZNA43-B23
Direct source monitor access, port 1, for R&S®ZNA50	R&S®ZNA50-B161	10 MHz to 50 GHz	1332.5107.51	2-port and 4-port R&S®ZNA, requires R&S®ZNA50-B16, R&S®ZNA50-B21
Direct source monitor access, port 1 and port 3, for R&S®ZNA50	R&S®ZNA50-B163	10 MHz to 50 GHz	1332.5107.53	4-port R&S®ZNA, requires R&S®ZNA50-B16, R&S®ZNA50-B21, R&S®ZNA50-B23
Direct source monitor access, port 1, for R&S®ZNA67	R&S®ZNA67-B161	10 MHz to 67 GHz	1332.5113.51	2-port and 4-port R&S®ZNA, requires R&S®ZNA67-B16, R&S®ZNA67-B21
Direct source monitor access, port 1 and port 3, for R&S®ZNA67	R&S®ZNA67-B163	10 MHz to 67 GHz	1332.5113.53	4-port R&S®ZNA, requires R&S®ZNA67-B16, R&S®ZNA67-B21, R&S®ZNA67-B23
Low-noise preamplifier at receiver, port 2, for R&S®ZNA26	R&S®ZNA26-B302	10 MHz to 26.5 GHz	1332.4752.12	requires R&S®ZNA26-B32 and R&S®ZNA26-B16
Low-noise preamplifier at receiver, port 2, for R&S®ZNA43	R&S®ZNA43-B302	10 MHz to 43 GHz	1332.4769.12	requires R&S®ZNA43-B32 and R&S®ZNA43-B16
Low noise preamplifier at receiver, port 2, for R&S®ZNA50	R&S®ZNA50-B302	10 MHz to 50 GHz	1332.4798.12	requires R&S®ZNA50-B32 and R&S®ZNA50-B16
Low noise preamplifier at receiver, port 2, for R&S®ZNA50	R&S®ZNA50-B312	10 MHz to 50 GHz	1332.5659.02	requires R&S®ZNA50-B32 and R&S®ZNA50-B16
Low noise preamplifier at receiver, port 2, for R&S®ZNA67	R&S®ZNA67-B302	10 MHz to 67 GHz	1332.4817.12	requires R&S®ZNA67-B32 and R&S®ZNA67-B16
Low noise preamplifier at receiver, port 2, for R&S®ZNA67	R&S®ZNA67-B312	10 MHz to 67 GHz	1332.5665.02	requires R&S®ZNA67-B32 and R&S®ZNA67-B16
Low-power spurious reduction, port 1, for R&S®ZNA26	R&S®ZNA26-B501	10 MHz to 26.5 GHz	1332.5220.11	requires R&S®ZNA26-B31
Low-power spurious reduction, port 1, for R&S®ZNA43	R&S®ZNA43-B501	10 MHz to 43.5 GHz	1332.5236.11	requires R&S®ZNA43-B31
Low power spurious reduction, port 1, for R&S®ZNA50	R&S®ZNA50-B501	10 MHz to 50 GHz	1332.5242.11	requires R&S®ZNA50-B31
Low power spurious reduction, port 1, for R&S®ZNA50	R&S®ZNA50-B511	10 MHz to 50 GHz	1332.5671.02	requires R&S®ZNA50-B31
Low power spurious reduction, port 1, for R&S®ZNA67	R&S®ZNA67-B501	10 MHz to 67 GHz	1332.5259.11	requires R&S®ZNA67-B31
Low power spurious reduction, port 1, for R&S®ZNA67	R&S®ZNA67-B511	10 MHz to 67 GHz	1332.5688.02	requires R&S®ZNA67-B31
Internal combiner, port 1 and port 2, for R&S®ZNA26 (2 ports)	R&S®ZNA26-B212	10 MHz to 26.5 GHz	1332.5265.02	2-port R&S®ZNA only; requires R&S®ZNA26-B52 and R&S®ZNA26-B21
Internal combiner, port 1 and port 2, for R&S®ZNA43 (2 ports)	R&S®ZNA43-B212	10 MHz to 43.5 GHz	1332.5271.02	2-port R&S®ZNA only; requires R&S®ZNA43-B52 and R&S®ZNA43-B21
Internal combiner, port 1 and port 2, for R&S®ZNA50 (2 ports)	R&S®ZNA50-B212	10 MHz to 50 GHz	1332.5288.02	2-port R&S®ZNA only; requires R&S®ZNA50-B52 and R&S®ZNA50-B21
Internal combiner, port 1 and port 2, for R&S®ZNA67 (2 ports)	R&S®ZNA67-B212	10 MHz to 67 GHz	1332.5294.02	2-port R&S®ZNA only; requires R&S®ZNA67-B52 and R&S®ZNA67-B21
Internal combiner, port 1 and port 3, for R&S®ZNA26 (4 ports)	R&S®ZNA26-B213	10 MHz to 26.5 GHz	1332.4846.13	4-port R&S®ZNA only; requires R&S®ZNA26-B21 and R&S®ZNA26-B23
Internal combiner, port 1 and port 3, for R&S®ZNA43 (4 ports)	R&S®ZNA43-B213	10 MHz to 43.5 GHz	1332.4869.13	4-port R&S®ZNA only; requires R&S®ZNA43-B21 and R&S®ZNA43-B23
Internal combiner, port 1 and port 3, for R&S®ZNA50 (4 ports)	R&S®ZNA50-B213	10 MHz to 50 GHz	1332.5042.13	4-port R&S®ZNA only; requires R&S®ZNA50-B21 and R&S®ZNA50-B23
Internal combiner, port 1 and port 3, for R&S®ZNA67 (4 ports)	R&S®ZNA67-B213	10 MHz to 67 GHz	1332.5065.13	4-port R&S®ZNA only; requires R&S®ZNA67-B21 and R&S®ZNA67-B23
Precision frequency reference (OCXO)	R&S®ZNA-B4		1332.4530.02	
2nd internal LO source for R&S®ZNA (4 ports)	R&S®ZNA-B5		1332.4675.02	
Data streaming memory	R&S®ZNA-B7		1332.4546.02	

Designation	Type	Frequency range	Order No.	Remarks
mmWave converter LO	R&S®ZNA-B8	10 MHz to 26.5 GHz	1332.4652.02	
RFFE GPIO interface	R&S®ZNA-B15		1332.4575.02	
RFFE GPIO interface, including voltage/current measurement	R&S®ZNA-B15		1332.4575.03	
Direct IF access	R&S®ZNA-B26		1332.4598.02	
Trigger and control I/O board	R&S®ZNA-B91		1332.4800.02	
Spectrum analyzer mode	R&S®ZNA-K1		1332.5320.02	
Time domain analysis (TDR)	R&S®ZNA-K2		1332.5336.02	
Extended time domain analysis (including eye diagram)	R&S®ZNA-K20		1332.4746.02	requires R&S®ZNA-K2
Continuous data recording	R&S®ZNA-K28		1332.5613.02	
Scalar mixer and arbitrary frequency-converting measurements	R&S®ZNA-K4		1332.5342.02	
Vector corrected converter measurements (without reference mixer and phase reference)	R&S®ZNA-K5		1332.5359.02	requires R&S®ZNA-K4
Phase coherent source control	R&S®ZNA-K6		1332.5413.02	
True differential mode	R&S®ZNA-K61		1332.5442.02	
Measurements on pulsed signals	R&S®ZNA-K7		1332.5371.02	requires R&S®ZNA-K17
Increased IF bandwidth 30 MHz	R&S®ZNA-K17		1332.5459.02	
mmWave converter support	R&S®ZNA-K8		1332.5388.02	
Group delay measurements on frequency converters without LO access	R&S®ZNA-K9		1332.5394.02	requires R&S®ZNA-K4 and options to generate a two-tone signal; 2-port R&S®ZNA: R&S®ZNAxx-B52, R&S®ZNAxx-B21, R&S®ZNAxx-B212 4-port R&S®ZNA: R&S®ZNAxx-B16 and R&S®ZNAxx-Z9 cable set or R&S®ZNAxx-B213 internal combiner, ZNAxx-B21/B23
1 MHz frequency resolution	R&S®ZNA-K19		1332.5513.02	
Noise figure measurements	R&S®ZNA-K30		1332.5465.02	
Uncertainty analysis	R&S®ZNA-K50		1332.5542.02	METAS tool user provided
Uncertainty analysis, preinstalled	R&S®ZNA-K50P		1332.5594.02	METAS tool preinstalled
Security write protection	R&S®ZNA-K51		1332.5559.02	
Data streaming memory	R&S®ZNA-B7		1332.4546.02	increases the number of receivers that can be used in parallel for pulse profile measurements (depending on IF bandwidth)
Easy deembedding	R&S®ZNA-K210		1339.3897.02	
In-situ deembedding	R&S®ZNA-K220		1339.3900.02	
Smart fixture deembedding	R&S®ZNA-K230		1339.3916.02	
Delta-L PCB characterization	R&S®ZNA-K231		1339.3922.02	
Health and utilization monitoring service (HUMS)	R&S®ZNA-K980		1332.5607.02	
<b>mmWave converters</b>				converters require R&S®ZNA-K8
Converter WR15, one module	R&S®ZC75	50 GHz to 75 GHz	1323.8259.02	
Converter WR12, one module	R&S®ZVA-Z90	60 GHz to 90 GHz	1322.3024.02	
Converter WR10, one module	R&S®ZVA-Z110	75 GHz to 110 GHz	1307.7000.03	
Converter WR10, one module	R&S®ZVA-Z110E	75 GHz to 110 GHz	1307.7000.40	
Converter WR12, one module	R&S®ZC90	60 GHz to 90 GHz	1323.7600.02	
Converter WR12, one module	R&S®ZC90E	60 GHz to 90 GHz	1323.7600.04	
Converter WM-2540, one module	R&S®ZC110	75 GHz to 110 GHz	1323.7617.02	
Converter WM-2032, one module	R&S®ZC140	90 GHz to 140 GHz	1323.7623.02	
Converter WM-1651, one module	R&S®ZC170	110 GHz to 170 GHz	1323.7630.02	
Converter WM-1651, one module	R&S®ZC170	110 GHz to 170 GHz	1323.7630.03	only for R&S®ZNA43, R&S®ZNA50, R&S®ZNA67
Converter WM-1295, one module	R&S®ZC220	140 GHz to 220 GHz	1323.7646.02	
Converter WM-1092, one module	R&S®ZC260	170 GHz to 260 GHz	3628.5682.02	
Converter WM-864, one module	R&S®ZC330	220 GHz to 330 GHz	1323.7669.02	
Converter WM-710, one module	R&S®ZC400	260 GHz to 400 GHz	3656.9220.02	
Converter WM-570, one module	R&S®ZC500	330 GHz to 500 GHz	1323.7681.02	
Converter WM-570, one module	R&S®ZC500	330 GHz to 500 GHz	1323.7681.03	only for R&S®ZNA43, R&S®ZNA50, R&S®ZNA67
Converter WM-750, one module	R&S®ZC750	500 GHz to 750 GHz	1323.7717.02	
Converter WM-250, one module	R&S®ZC1100	750 GHz to 1100 GHz	1323.7723.02	

Designation	Type	Frequency range	Order No.	Remarks
<b>mmWave receivers</b>				converters require R&S®ZNA-K8
Receiver WR12, one module	R&S®ZRX90	60 GHz to 90 GHz	3658.5368.02	
Receiver WM-2540 (WR10), one module	R&S®ZRX110	75 GHz to 110 GHz	3637.1511.02	
Receiver WM-2032 (WR08), one module	R&S®ZRX140	90 GHz to 140 GHz	3637.1528.02	
Receiver WM-1651 (WR6.5), one module	R&S®ZRX170	110 GHz to 170 GHz	3622.0737.02	
Receiver WM-1295 (WR5.1), one module	R&S®ZRX220	140 GHz to 220 GHz	3622.0743.02	
Receiver WM-1092 (WR4.3), one module	R&S®ZRX260	170 GHz to 260 GHz	3622.0750.02	
Receiver WM-864 (WR3.4), one module	R&S®ZRX330	220 GHz to 330 GHz	3622.0766.02	
Receiver WM-710 (WR2.8), one module	R&S®ZRX400	260 GHz to 400 GHz	3658.5374.02	
Receiver WM-570, one module	R&S®ZRX500	330 GHz to 500 GHz	3622.0772.02	
Receiver WM-380 (WR1.5), one module	R&S®ZRX750	500 GHz to 750 GHz	3658.5745.02	
Receiver WM-250 (WR1.0), one module	R&S®ZRX1100	750 GHz to 1100 GHz	3658.5868.02	
<b>mmWave mini receivers</b>				converters require R&S®ZNA-K8
Mini receiver WM-2540 (WR10), one module	R&S®ZRX110L	75 GHz to 110 GHz	3642.6918.02	
Mini receiver WM-1651 (WR6.5), one module	R&S®ZRX170L	110 GHz to 170 GHz	3688.8113.02	
Mini receiver WM-1295 (WR5.1), one module	R&S®ZRX220L	140 GHz to 220 GHz	3688.8107.02	
Mini receiver WM-864 (WR3.4), one module	R&S®ZRX330L	220 GHz to 330 GHz	3642.6924.02	
Mini receiver WM-570, one module	R&S®ZRX500L	330 GHz to 500 GHz	3642.7108.02	
Mini receiver WM-380 (WR1.5), one module	R&S®ZRX750L	500 GHz to 750 GHz	3665.9265.02	
<b>Calibration and verification</b>				
<b>Calibration kits (manual calibration)</b>				
Calibration kit, 3.5 mm, 50 Ω	R&S®ZN-Z235	0 Hz to 26.5 GHz	1336.8500.02	
Calibration kit, 2.92 mm, 50 Ω	R&S®ZN-Z229	0 Hz to 43.5 GHz	1336.7004.02	
Calibration kit, 2.4 mm, 50 Ω	R&S®ZN-Z224	0 Hz to 50 GHz	1339.5002.02	
Calibration kit, 1.85 mm, 50 Ω	R&S®ZN-Z218	0 Hz to 67 GHz	1337.3502.02	
Calibration kit, 1.0 mm, 50 Ω	R&S®ZV-Z210	0 Hz to 110 GHz	1354.3407.02	
<b>Waveguide calibration kits</b>				
Waveguide calibration kit WR15 (without sliding match)	R&S®ZV-WR15	50 GHz to 75 GHz	1307.7500.30	
Waveguide calibration kit WR15 (with sliding match)	R&S®ZV-WR15	50 GHz to 75 GHz	1307.7500.31	
Waveguide calibration kit WR12 (without sliding match)	R&S®ZV-WR12	60 GHz to 90 GHz	1307.7700.10	
Waveguide calibration kit WR12 (with sliding match)	R&S®ZV-WR12	60 GHz to 90 GHz	1307.7700.11	
Waveguide calibration kit WR10 (without sliding match)	R&S®ZV-WR10	75 GHz to 110 GHz	1307.7100.10	
Waveguide calibration kit WR10 (with sliding match)	R&S®ZV-WR10	75 GHz to 110 GHz	1307.7100.11	
Waveguide calibration kit WR08 (without sliding match)	R&S®ZV-WR08	90 GHz to 140 GHz	1307.7900.10	
Waveguide calibration kit WR08 (with sliding match)	R&S®ZV-WR08	90 GHz to 140 GHz	1307.7900.11	
Waveguide calibration kit WR06 (without sliding match)	R&S®ZV-WR06	110 GHz to 170 GHz	1311.8807.10	
Waveguide calibration kit WR06 (with sliding match)	R&S®ZV-WR06	110 GHz to 170 GHz	1311.8807.11	
Waveguide calibration kit WR05 (without sliding match)	R&S®ZV-WR05	140 GHz to 220 GHz	1307.8106.10	
Waveguide calibration kit WR05 (with sliding match)	R&S®ZV-WR05	140 GHz to 220 GHz	1307.8106.11	
Waveguide calibration kit WR03 (without sliding match)	R&S®ZV-WR03	220 GHz to 325 GHz	1307.7300.30	
Waveguide calibration kit WR03 (with sliding match)	R&S®ZV-WR03	220 GHz to 325 GHz	1307.7300.31	
Waveguide calibration kit WR02 (without sliding match)	R&S®ZV-WR02	325 GHz to 500 GHz	1314.5550.10	
Waveguide calibration kit WM-1092	R&S®ZCWM-1092	170 GHz to 260 GHz	3628.5699.02	
Waveguide calibration kit WM-710	R&S®ZCWM-710	260 GHz to 400 GHz	1339.4070.02	
Waveguide calibration kit WM-570	R&S®ZCWM-570	330 GHz to 500 GHz	1322.3099.10	



Designation	Type	Frequency range	Order No.	Remarks
Waveguide calibration kit WM-380	R&S®ZCWM-380	500 GHz to 750 GHz	1322.3101.02	
Waveguide calibration kit WM-250	R&S®ZCWM-250	750 GHz to 1100 GHz	1322.3118.02	
<b>Calibration units (automatic calibration)</b>				
Calibration unit, 2 ports, 3.5 mm (f)	R&S®ZN-Z50	9 kHz to 26.5 GHz	1335.6904.32	
Calibration unit, 4 ports, 3.5 mm (f)	R&S®ZN-Z52	100 kHz to 26.5 GHz	1335.6991.30	
Calibration unit, 2 ports, 3.5 mm (f)	R&S®ZN-Z53	100 kHz to 26.5 GHz	1335.7046.32	
Calibration unit, 2 ports, 2.92 mm (f)	R&S®ZN-Z54	9 kHz to 43.5 GHz	1335.7117.92	
Calibration unit, 2 ports, 2.4 mm (f)	R&S®ZN-Z55	9 kHz to 50 GHz	1335.7181.42	
Calibration unit, 2 ports, 1.85 mm (f)	R&S®ZN-Z156	5 GHz to 67 GHz	1332.7239.03	
<b>Inline calibration units (automatic calibration)</b>				
Inline calibration unit controller	R&S®ZN-Z30		1328.7609.02	
Inline calibration unit, 40 GHz	R&S®ZN-Z33		1328.7644.02	
Inline calibration unit, 40 GHz, TVAC	R&S®ZN-Z33		1328.7644.03	
<b>Verification kits</b>				
T-check verification device, 3.5 mm (f to m)	R&S®ZV-Z335	45 MHz to 26.5 GHz	1319.1018.02	
T-check verification device, 2.92 mm (f to m)	R&S®ZV-Z329	45 MHz to 40 GHz	1319.1024.02	
T-check verification device, 2.4 mm (f to m)	R&S®ZV-Z324	45 MHz to 50 GHz	1319.1030.02	
Verification kit, 3.5 mm	R&S®ZV-Z435	45 MHz to 26.5 GHz	1319.1060.02	
Verification kit, 2.92 mm	R&S®ZV-Z429	45 MHz to 40 GHz	1319.1076.02	
Verification kit, 2.4 mm	R&S®ZV-Z424	45 MHz to 50 GHz	1319.1082.02	
<b>Test cables</b>				
3.5 mm (f) to 3.5 mm (m), length: 0.6 m/1 m	R&S®ZV-Z93	0 Hz to 26.5 GHz	1301.7595.25/38	
2.92 mm (f) to 2.92 mm (m), length: 0.6 m/1 m	R&S®ZV-Z95	0 Hz to 40 GHz	1301.7608.25/38	
2.4 mm (f) to 2.4 mm (m), length: 0.6 m	R&S®ZV-Z97	0 Hz to 50 GHz	1301.7637.25	
3.5 mm (f) to 3.5 mm (m), length: 0.6 m/0.9 m/1.5 m	R&S®ZV-Z193	0 Hz to 26.5 GHz	1306.4520.24/36/60	
2.92 mm (f) to 2.92 mm (m), length: 0.6 m/0.9 m	R&S®ZV-Z195	0 Hz to 40 GHz	1306.4536.24/36	
1.85 mm (f) to 1.85 mm (m), length: 0.6 m/0.9 m	R&S®ZV-Z196	0 Hz to 67 GHz	1306.4559.24/36	
<b>Hardware add-ons</b>				
Calibration mixer, 2.92 mm (f)	R&S®ZN-ZM292	10 MHz to 40 GHz	1339.3800.02	
Calibration mixer, 2.92 mm (f), delivery without wooden storage box	R&S®ZN-ZM292	10 MHz to 40 GHz	1339.3800.03	
Torque wrench for 3.5/2.92/2.4/1.85 mm connector, 8 mm width, 0.9 Nm torque	R&S®ZN-ZTW		1328.8534.35	
Torque wrench for R&S®ZNA test port connector, 19 mm width, 0.9 Nm torque	R&S®ZN-ZTW		1328.8534.19	
Additional removable hard disk	R&S®ZNA-B19		1332.4600.02	
19" rack adapter	R&S®ZZA-KN6		1175.3056.00	
Cable sets (to combine the signals from port 1 and port 3 of an R&S®ZNA (4 ports) to produce a two-tone signal, required for intermodulation measurements and embedded LO group delay measurements with R&S®ZNA-K9 option; required, if no internal combiner is installed)				
Cable set for R&S®ZNA-K9 (3.5 mm for R&S®ZNA26)	R&S®ZNA26-Z9		1332.4730.26	
Cable set for R&S®ZNA-K9 (2.92 mm for R&S®ZNA43)	R&S®ZNA43-Z9		1332.4730.43	
Cable set for R&S®ZNA-K9 (2.4 mm for R&S®ZNA43)	R&S®ZNA43-Z9		1332.4730.44	
Cable set for R&S®ZNA-K9 (1.85 mm for R&S®ZNA50)	R&S®ZNA50-Z9		1332.4730.50	
Cable set for R&S®ZNA-K9 (1.85 mm for R&S®ZNA67)	R&S®ZNA67-Z9		1332.4730.67	

Designation	Type	Frequency range	Order No.	Remarks
<b>Tools</b>				
License dongle, PC software	R&S®ZNPC		1325.6601.02	
R&S®ZNA simulation	R&S®ZNXSIM-K2		1338.1626.02	
Time domain analysis (TDR) for simulation	R&S®ZNXSIM-K22		1338.1632.02	
<b>Vector network analyzer systems</b>				
Vector network analyzer system, 110 GHz, 2 test ports, complete system based on R&S®ZNA67, 2-port model, standard power	R&S®ZNA67EXT	10 MHz to 110 GHz	1352.1888.02	
Vector network analyzer system, 110 GHz, 2 test ports, complete system based on R&S®ZNA67, 4-port model, standard power	R&S®ZNA67EXT	10 MHz to 110 GHz	1352.1888.03	
Vector network analyzer system, 110 GHz, 4 test ports, complete system based on R&S®ZNA67, 4-port model, standard power	R&S®ZNA67EXT	10 MHz to 110 GHz	1352.1888.04	
Vector network analyzer system, 110 GHz, 2 test ports, complete system based on R&S®ZNA67, 2-port model, high power	R&S®ZNA67EXT	10 MHz to 110 GHz	1352.1888.05	
Vector network analyzer system, 110 GHz, 2 test ports, complete system based on R&S®ZNA67, 4-port model, high power	R&S®ZNA67EXT	10 MHz to 110 GHz	1352.1888.06	
Vector network analyzer system, 110 GHz, 4 test ports, complete system based on R&S®ZNA67, 4-port model, high power	R&S®ZNA67EXT	10 MHz to 110 GHz	1352.1888.07	
<b>Option</b>				
Continuous sweep up to 110 GHz	R&S®ZNA67-K110	10 MHz to 110 GHz	1332.5642.02	
<b>Hardware add-ons</b>				
RF cable set gore for R&S®ZNA67EXT, 2-port system	R&S®ZN-ZCASGO		1352.1659.02	
RF cable set gore for R&S®ZNA67EXT, 4-port system	R&S®ZN-ZCASGO		1352.1659.04	

#### Hardware upgrade options

Hardware options can be retrofitted either with a B option (R&S®ZNA-Bx/-Bxx, R&S®ZNAxx-Bx/-Bxx/-Bxxx) or with a U (upgrade) option. U options are required for the following upgrades:

- ▶ Direct source monitor access: R&S®ZNAxx-U161/R&S®ZNAxx-B163. These options additionally require R&S®ZNAxx-U16 and R&S®ZNAxx-U21/R&S®ZNAxx-U23 unless the corresponding B options (R&S®ZNAxx-B16, R&S®ZNAxx-B21/R&S®ZNAxx-B23) are already installed.
- ▶ All source and receiver step attenuators: R&S®ZNAxx-U2n, R&S®ZNAxx-U3n

For further information, contact your local Rohde&Schwarz sales office.

Warranty		
Base unit		3 years
All other items <sup>1)</sup>		1 year
Options		
Extended warranty, one year	R&S®WE1	Please contact your local Rohde & Schwarz sales office.
Extended warranty, two years	R&S®WE2	
Extended warranty with calibration coverage, one year	R&S®CW1	
Extended warranty with calibration coverage, two years	R&S®CW2	
Extended warranty with accredited calibration coverage, one year	R&S®AW1	
Extended warranty with accredited calibration coverage, two years	R&S®AW2	

<sup>1)</sup> For options that are installed, the remaining base unit warranty applies if longer than 1 year.  
Exception: All batteries have a 1 year warranty.

# FROM PRESALES TO SERVICE. AT YOUR DOORSTEP.

The Rohde & Schwarz network in over 70 countries ensures optimum on-site support by highly qualified experts.

User risks are reduced to a minimum at all project stages:

- ▶ Solution finding/purchase
- ▶ Technical startup/application development/integration
- ▶ Training
- ▶ Operation/calibration/repair

Your local Rohde & Schwarz expert will help find the best solution for you.

To find your nearest Rohde & Schwarz representative, visit [www.sales.rohde-schwarz.com](http://www.sales.rohde-schwarz.com)

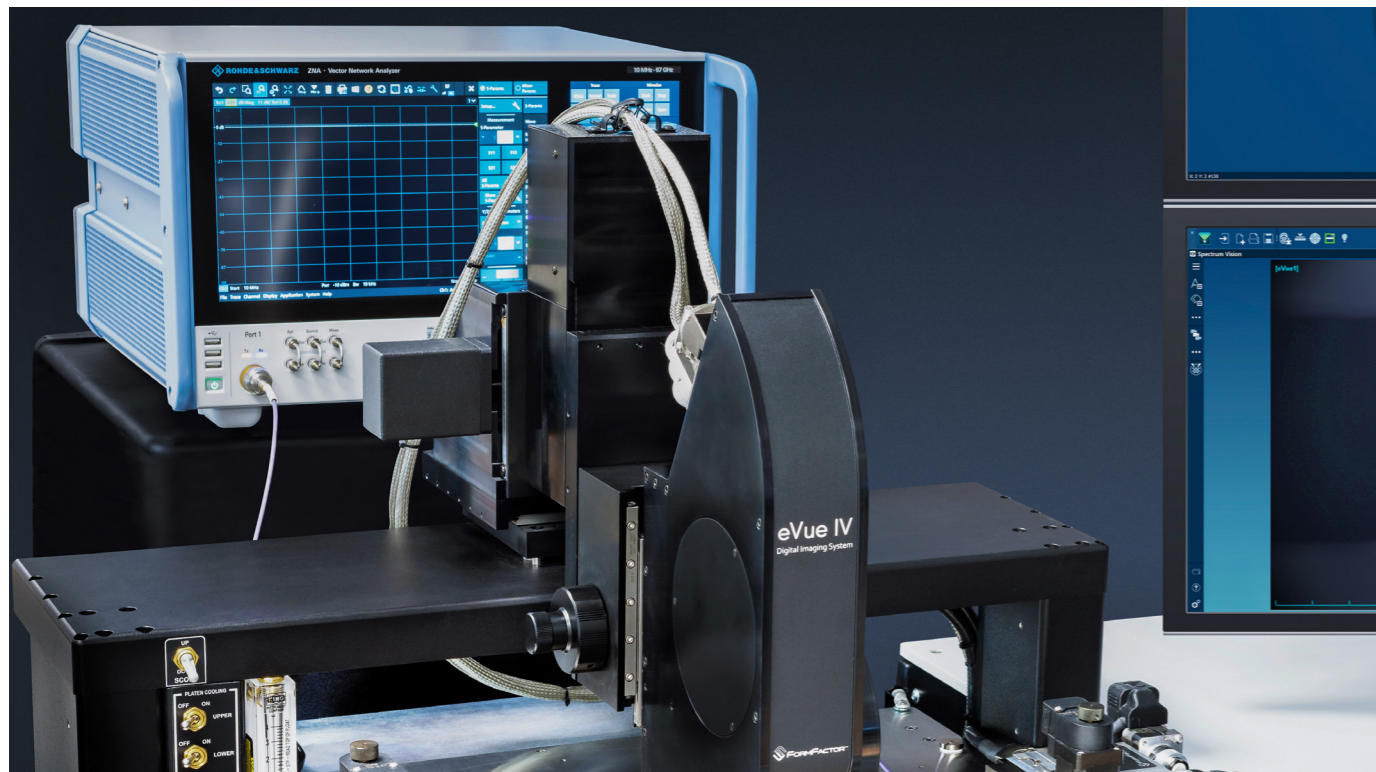

**Service at Rohde & Schwarz**  
**You're in great hands**

- ▶ Worldwide
- ▶ Local and personalized
- ▶ Customized and flexible
- ▶ Uncompromising quality
- ▶ Long-term dependability

**MAKE IDEAS REAL**  
and join our experts team  
at Rohde & Schwarz.



**Rohde & Schwarz**

The Rohde & Schwarz technology group is among the trail-blazers when it comes to paving the way for a safer and connected world with its leading solutions in test & measurement, technology systems and networks & cybersecurity. Founded more than 85 years ago, the group is a reliable partner for industry and government customers around the globe. The independent company is headquartered in Munich, Germany and has an extensive sales and service network with locations in more than 70 countries.

[www.rohde-schwarz.com](http://www.rohde-schwarz.com)

**Sustainable product design**

- ▶ Environmental compatibility and eco-footprint
- ▶ Energy efficiency and low emissions
- ▶ Longevity and optimized total cost of ownership

Certified Quality Management  
**ISO 9001**

Certified Environmental Management  
**ISO 14001**

**Rohde & Schwarz training**

[www.training.rohde-schwarz.com](http://www.training.rohde-schwarz.com)

**Rohde & Schwarz customer support**

[www.rohde-schwarz.com/support](http://www.rohde-schwarz.com/support)

