

N1501A Dielectric Probe Kit

10 MHz to 50 GHz

Swept Broadband Dielectric Measurements

The Keysight Technologies, Inc. N1501A dielectric probe kit determines the dielectric properties, or complex permittivity, of many materials. A material's dielectric properties are determined by its molecular structure. If the molecular structure changes, so will the dielectric properties. Measurements of the dielectric properties of a material can be used to indirectly measure other properties of the material that are also correlated to the molecular structure, and can be a valuable alternative when the property of interest is difficult to measure directly.

Measurements are made by simply immersing the probe into liquids or semi-solids no special fixtures or containers are required. Measurements are non-destructive and can be made in real time. These important features allow the dielectric probe kit to be used in process analytic technologies.

The complete system is based on a Keysight network or impedance analyzer, which measures the material's response to RF or microwave energy. The probe transmits a signal into the material under test (MUT). Depending on the Keysight analyzer and probe used, frequencies can extend from 10 MHz to 50 GHz.

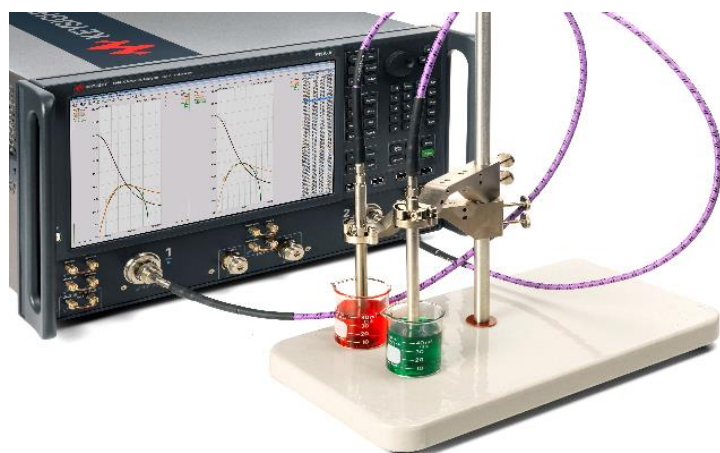



The N1500A materials measurement suite (not included) controls the analyzer and guides you through easy setup and measurement steps. In seconds, it calculates and displays complex permittivity in a variety of formats, including dielectric constant, dielectric loss factor, loss tangent or Cole-Cole.

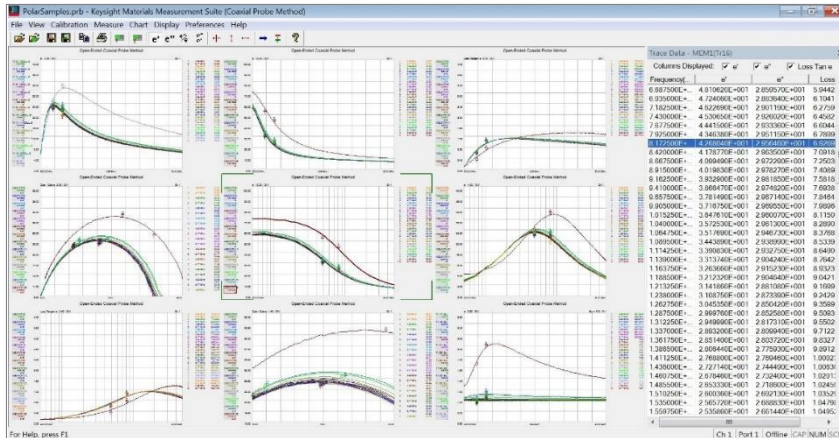

Figure 1. Example of coaxial probe measurement results with N1500A materials measurement suite.

Features

- Measures complex permittivity
- Designed to work with Keysight N1500A materials measurement suite, with Option 004 coaxial probe method
- Best for measuring liquids and conformable solids
- Flexible option configuration allows you to choose the probes and accessories you need, anytime you want, and to fit your budget

Calibration Refresh Reduces Drift Errors

The automated electronic calibration refresh feature recalibrates the system automatically, in seconds, just before each measurement is made. This virtually eliminates cable instability and system drift errors. See N1500A Technical Overview part number 5992-0263EN for more details.



Figure 2. Ecal module connected in line for electronic calibration refresh.

New Options Allow You to Configure a Kit to Meet Your Needs

Three probe designs to choose from

Each comes in a kit with a calibration short and depending on probe kit, some small accessories

Performance probe

Combines rugged, high temperature, and frequency performance in a slim design

- Frequency range 500 MHz to 50 GHz
- 2.4 mm male connector

For your most demanding applications, this probe features rugged, high temperature and frequency performance in a slim design. The probe is sealed on both the probe tip and the connector end, which makes it our most rugged probe. The probe withstands a wide $-40\text{ }^{\circ}\text{C}$ to $+200\text{ }^{\circ}\text{C}$ temperature range, which allows measurements versus frequency and temperature.

The performance probe can be autoclaved, making it an excellent choice for applications in the food, medical, and chemical industries where sterilization is a must. The slim design allows it to fit easily in fermentation tanks, chemical reaction chambers, or other equipment with small apertures. It is useful for measuring liquid, semi-solid, as well as flat surfaced solid materials. The performance probe kit comes complete with a calibration short.

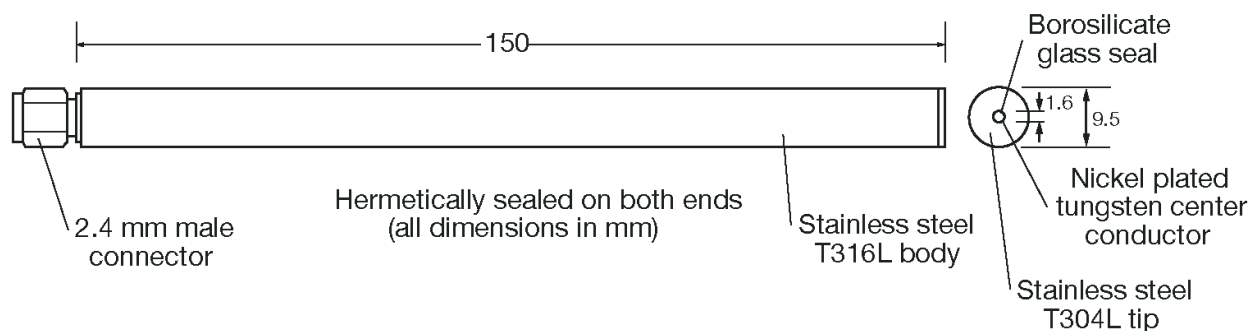

Figure 3. Performance probe drawing



Table 1. N1501A Option 104 performance probe kit contents

#	Description
1	Performance probe
2	Performance probe short

High temperature probe

Survives corrosive chemicals and high temperatures

- Frequency range: 200 MHz to 20 GHz with a network analyzer
- 10 MHz to 3 GHz with an impedance analyzer
- 3.5 mm male connector

Rugged in design, this probe features a hermetic glass-to-metal seal, which makes it resistant to corrosive or abrasive chemicals. The probe withstands a wide $-40\text{ }^{\circ}\text{C}$ to $+200\text{ }^{\circ}\text{C}$ temperature range, which allows measurements versus frequency and temperature. The large flange makes it easier to measure flat surfaced solid materials, in addition to liquids and semi-solids. The 3.5 mm aperture has a larger sensing volume than the other N1501A probes.

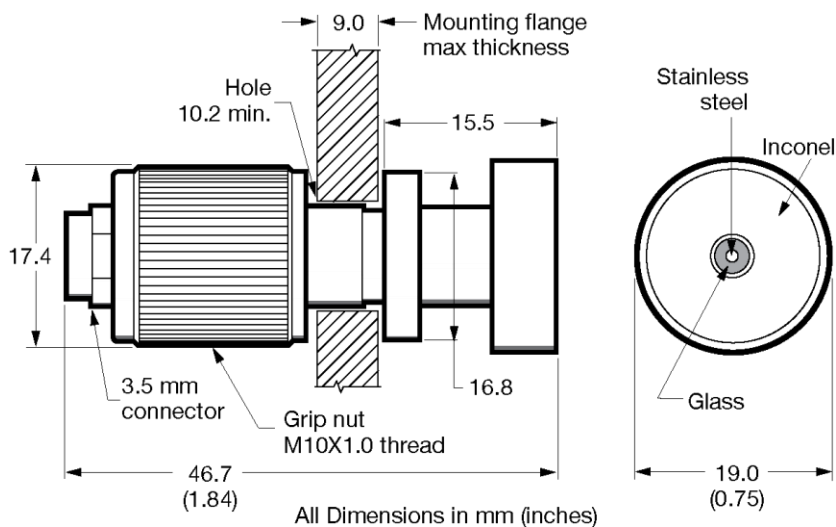

Figure 4. High temperature probe drawing



Table 2. N1501A Option 101 High temperature probe kit contents

#	Description
3	High temperature short
4	High temperature probe
5	Conductive elastomer disk – optional use adds cushion between high temperature probe and short

Slim form probe

Smaller diameter fits into tight spaces

- Frequency range 500 MHz to 50 GHz
- 2.4 mm male connector

This probe features a slim design, which allows it to fit easily in fermentation tanks, chemical reaction chambers, or other equipment with small apertures. The slim design also allows it to be used with smaller sample sizes. Best used for liquids and soft semi-solids. For castable solids, the probe is economical enough to be cast into the material and left in place. Because of the consumable nature of this design, these probes are offered in sets of three. The slim form probe kit comes with a sealed slim form holder that adapts 2.2 mm outer diameter to 10 mm inner diameter bracket included in the kit as well as commercially available “Midi” sized adapters and bushings.

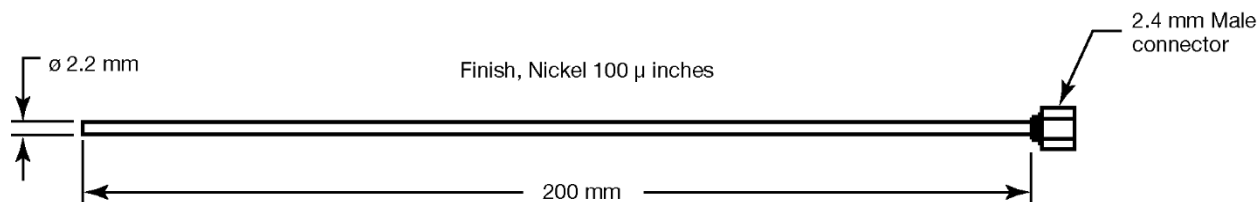

Figure 5. Slim form probe drawing

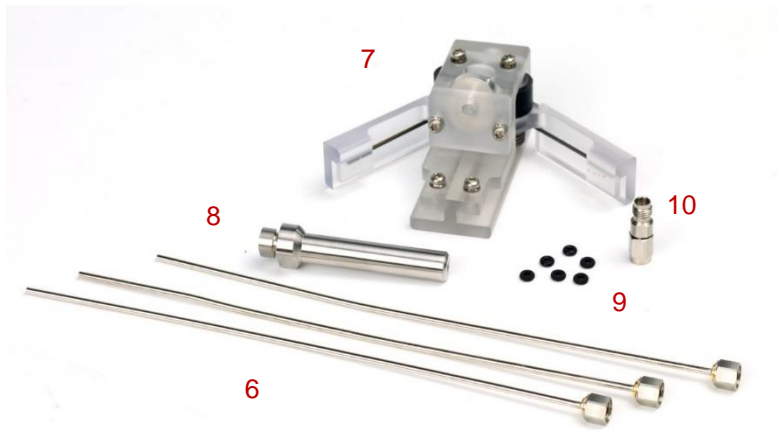

Table 3. N1501A Option 102 Slim form probe kit contents

#	Description
6	Slim form probe (quantity 3)
7	Slim form short
8	Slim form probe holder – Connects slim form probe to 10 mm holder and probe stand bracket.
9	O-rings (quantity 6) – inserted between inner and outer parts of slim form probe holder.
10	Connector saver adapter – protects slim form probe when connecting to 2.4 mm PSC connector.

Table 4. N1501A Option 103 Slim form probe replenishment kit contents

#	Description
6	Slim form probe (quantity 3)
9	O-rings (quantity 6) inserted between inner and outer parts of slim form probe holder.

Probe Characteristics and Specifications

Specifications describe the warranted performance with N1500A materials measurement suite, option 004, and over the temperature range 0 to 55 °C. Supplemental characteristics are intended to provide information useful in applying the instrument, by giving typical but non-warranted performance parameters. These are denoted as “typical,” “nominal,” or “approximate.”

Table 5. Probe Characteristics

	Performance Probe	Slim Form Probe	High Temperature Probe
Frequency Range (nominal)	500 MHz to 50 GHz	500 MHz to 50 GHz	200 MHz to 20 GHz with network analyzer
	Maximum limited by MUT properties $f_{max} < \frac{ 285-125j }{\sqrt{ \epsilon_r^* }} \text{ GHz}$ where j indicates a complex value	Maximum limited by MUT properties $f_{max} < \frac{ 285-125j }{\sqrt{ \epsilon_r^* }} \text{ GHz}$ where j indicates a complex value	10 MHz to 3 GHz with E4991A/E4991B Impedance analyzer with option 10. Maximum limited by MUT properties $< \frac{100 \text{ GHz}}{\sqrt{ \epsilon_r^* }}$
Temperature range	−40 to +200 °C	0 to +125 °C	−40 to +200 °C
Temperature slew rate	< 10 degrees/minute	< 10 degrees/minute	< 10 degrees/minute
Immersable length (approximate)	140 mm	200 mm	35 mm
Connector	2.4 mm male	2.4 mm male	3.5 mm male
Repeatability and resolution	Two to four times better than accuracy	Two to four times better than accuracy	Two to four times better than accuracy
Material Under Test (assumptions)	Material is “infinite” in size, non-magnetic ($\mu^* = 1$), isotropic (uniform orientation), and homogeneous (uniform composition) ² . Solids have a single, smooth, flat ³ surface with gap-free contact at the probe face.	Liquid or soft semi-solid. Material is “infinite” in size, non-magnetic ($\mu^* = 1$), isotropic (uniform orientation), and homogeneous (uniform composition) ² .	Material is “infinite” in size, non-magnetic ($\mu^* = 1$), isotropic (uniform orientation), and homogeneous (uniform composition) ² . Solids have a single, smooth, flat ³ surface with gap-free contact at the probe face.
Sample size (requirements)	Minimum 5 mm insertion and 1 mm around tip of probe	Minimum 5 mm insertion and 5 mm around tip of probe	Diameter: > 20 mm Thickness: $> \frac{20}{\sqrt{ \epsilon_r^* }} \text{ mm}$ Granule size ⁴ : < 0.3 mm
Expected Value (requirements)	Maximum recommended $\epsilon_r' < 100$	Maximum recommended $\epsilon_r' < 100$	Maximum recommended $\epsilon_r' < 100$
	Minimum recommended loss tangent > 0.05	Minimum recommended loss tangent > 0.05	Minimum recommended loss tangent > 0.05

	Not recommended for low loss (loss tangent < 0.5) materials with $\epsilon_r' > 5$	Not recommended for low loss (loss tangent < 0.5) materials with $\epsilon_r' > 5$	Not recommended for low loss (loss tangent < 0.5) materials with $\epsilon_r' > 5$
Accuracy (typical) ¹	Dielectric constant, $\epsilon_r' = \epsilon_r'$ $\pm 0.05 \epsilon_r^* $. $\epsilon_r'' = \epsilon_r''$ $\pm 0.05 \epsilon_r^* $	Dielectric constant, $\epsilon_r' = \epsilon_r'$ $\pm 0.1 \epsilon_r^* $. $\epsilon_r'' = \epsilon_r''$ $\pm 0.1 \epsilon_r^* $	Dielectric constant, $\epsilon_r' = \epsilon_r'$ $\pm 0.05 \epsilon_r^* $. $\epsilon_r'' = \epsilon_r''$ $\pm 0.05 \epsilon_r^* $

1. Practical frequency range, accuracy and resolution depend on properties of the MUT. Value indicates typical accuracy at 23 ± 3 °C, not including effects of probe contact and cable flexure.
2. If the material is not homogeneous, the result is an average value weighted by the intensity of the E-field, which is highest at the center conductor of the probe tip.
3. Sample must be as flat as the probe face, which is lapped to ± 100 μ inches.
4. Measurement repeatability for granular materials is dependent on density variation.

Accessories

A variety of accessories are orderable separately so you can configure a kit with exactly what you need and nothing else.



Table 6. Accessories

#	Option	Description
	N1501A-001	Walnut storage box and foam pad set (shown below)
	N1501A-002	Probe stand (not shown)
11	N1501A-003	Probe stand bracket
12	N1501A-004	ECal bracket – connects optional ECal module to probe stand bracket (not compatible with 4-port ECal modules)
13	N1501A-005	10 mm holder and key set – connects performance probe and slim form holder to probe stand bracket.
14	N1501A-006	Type N (male) to 3.5 mm (male) adapter
15	11901D	2.4 mm (PSC female) to 3.5 mm (male) adapter

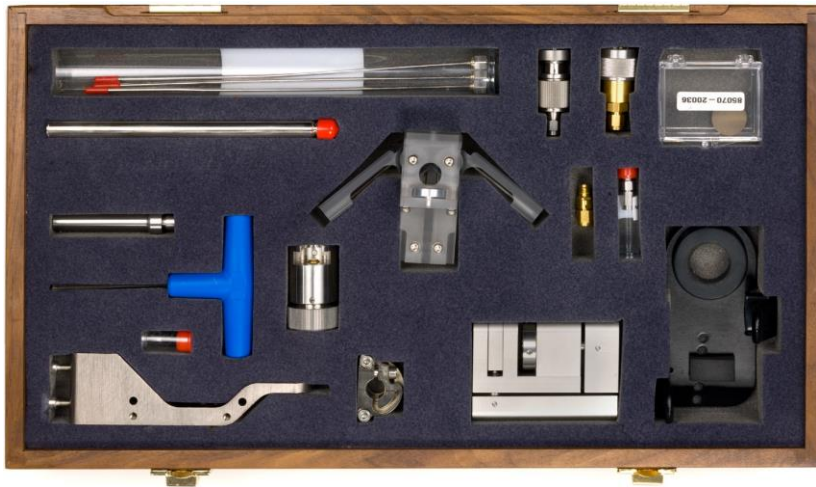

Figure 6. Walnut storage box with foam pad, probes kits and accessories.

Cables

High temperature cable

Use with high temperature or performance probe for high temperature applications from $-40\text{ }^{\circ}\text{C}$ to $+200\text{ }^{\circ}\text{C}$. SMA female connectors connect directly to high temperature probe. When connecting to slim form and performance probes, an additional 11901D adapter will be needed (located under configuration guide).

20 GHz flexible cable

Choose this cable when temperature performance is not critical. SMA female connectors connect to high temperature probe. When connecting to slim form or performance probes, an additional 11901D adapter will be needed (see configuration guide).

50 GHz flexible cable

Choose this cable for high frequency applications. 2.4 mm female connectors connect directly to slim form and performance probes

Table 7. Cable characteristics table

Option	Description	Length (m)	Connectors	Maximum frequency (GHz)	Typical VSWR	Typical insertion Loss (dB)	Typical phase stability ¹ (± °)	Operating temperature (°C)
N1501A-201	High temperature cable	1	SMA female	26.5	1.50:1	3.50	Not specified	-40 to +200
N1501A-202	20 GHz flexible cable	1	3.5mm female	26.5	1.45:1	2.24	3	-40 to +125
N1501A-203	50 GHz flexible cable	1	2.4mm female	50.0	1.43:1	4.20	6	-40 to +85

1. Typical phase stability bent around a mandrel of 2.25 in. radius approximately half way down the length of the cable.

Configuration Guide

Choose one of our recommended configurations



Figure 7. Two port configuration with PNA and performance probe kit

N1501A Option 101 High temperature probe kit

	Model number	Description	Quantity recommended for multi-port configurations
Recommended accessories	N1501A-001	Walnut storage box	One per system
	N1501A-002	Probe stand	One per system
	N1501A-003	Probe stand bracket	One per probe
Recommended cables	N1501A-202 or N1501A-201	20 GHz Flexible cable or High temperature cable	One cable per probe

N1501A Option 102 Slim form probe kit

	Model number	Description	Quantity recommended for multi-port configurations
Recommended accessories	N1501A-001	Walnut storage box	One per system
	N1501A-002	Probe stand	One per system
	N1501A-003	Probe stand bracket	One per probe
	N1501A-005	10 mm Holder and key set	One per probe
Recommended cables	N1501A-202 or N1501A-201	50 GHz flexible cable or High temperature cable with 2.4 mm to 3.5 mm adapter.	One cable per probe

N1501A Option 104 Performance probe kit

	Model number	Description	Quantity recommended for multi-port configurations
Recommended accessories	N1501A-001	Walnut storage box	One per system
	N1501A-002	Probe stand	One per system
	N1501A-003	Probe stand bracket	One per probe
	N1501A-005	10 mm Holder and key set	One per probe
Recommended cables	N1501A-203 or N1501A-201 and 11901D	50 GHz flexible cable or High temperature cable with 2.4 mm to 3.5 mm adapter.	One cable per probe

For optional electronic calibration refresh, add

- N1501A Option 004 Ecal bracket (requires probe stand and bracket)
- N469xA Series or 8509xC Series ECal module. N443x Series (ports a and b only) can also be used but is not compatible with Ecal bracket.

Also required but not included

- N1500A Option 004 Materials measurement suite with coaxial probe method option
 - Internet access for N1500A software license redemption.
 - PC (optional with ENA and PNA series network analyzers when N1500A software is installed directly on the analyzer).
 - Windows XP, Windows 7 or Windows 8 operating system
 - Keysight IO Libraries Suite 16.1 or later
 - GPIB, LAN or USB interface depending on network analyzer. For network analyzer interface information, please see <http://na.support.keysight.com/materials/docs/N1500A-VNAs.pdf>
- Keysight network or impedance analyzer. For a complete list of supported models, please see <http://na.support.keysight.com/materials/docs/N1500A-VNAs.pdf>

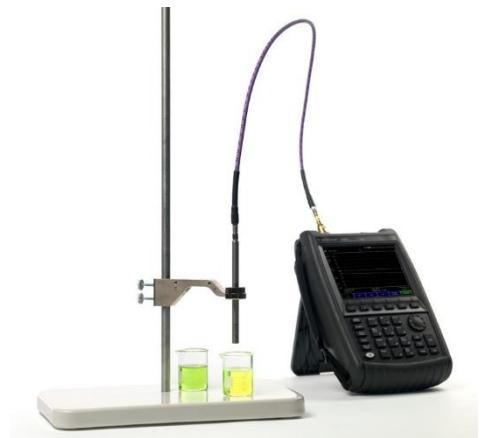

Figure 8. FieldFox network analyzer and dielectric probe kit

Or, customize your own

Choose any or all

Probes

Model number	Description
N1501A-101	High temperature probe kit
N1501A-102	Slim form probe kit
N1501A-103	Slim form replenishment kit
N1501A-104	Performance probe kit

Accessories

Model number	Description
N1501A-001	Walnut storage box and foam pad set
N1501A-002	Probe stand
N1501A-003	Probe stand bracket
N1501A-004	ECal bracket
N1501A-005	10 mm Holder and key set
N1501A-006	Type N (male) to 3.5 mm (male) Adapter
11901D	2.4 mm (PSC female) to 3.5 mm (male) Adapter

Cables

Model number	Description
N1501A-201	High temperature cable
N1501A-202	20 GHz Flexible cable
N1501A-203	50 GHz Flexible cable

Adapter selection guide

Some configurations may require adapters. The Keysight adapter part numbers are charted below.

Network analyzer port to cable

Network analyzer port connector	High temperature cable	20 GHz flexible cable	50 GHz flexible cable
Type-N female	N1501A-006	N1501A-006	11903A
3.5 mm male	None needed	None needed	11901C
2.4 mm male	11901D	11901D	None needed

Probe to cable

Probe type	High temperature cable	20 GHz flexible cable	50 GHz flexible cable
High temperature probe	None needed	None needed	11901C
Slim form probe	11901D	11901D	None needed
Performance probe	11901D	11901D	None needed

Adapters needed when using automated electronic calibration refresh

ECal module to cable

ECal module connector	High temperature cable	20 GHz flexible cable	50 GHz flexible cable
Type-N male	1250 to 1750	1250 to 1750	11903C
Type-N female	N1501A-006	N1501A-006	11903A
3.5 mm male	None needed	None needed	11901C
3.5 mm female	1250-1748	1250-1748	11901A
2.4 mm male	11901D	11901D	None needed
2.4 mm female	11901C	11901C	11900A

ECal module to probe

ECal module connector	High temperature cable	Performance and slim form probes
Type-N male	1250 to 1745	11903B
Type-N female	1259 to 1744	11903D
3.5 mm male	83059B	11901B
3.5 mm female	None needed	11901D
2.4 mm male	11901B	11900B
2.4 mm female	11901C	None needed

Replacement parts

These parts can also be ordered individually from Keysight Service Parts Organization.

Model number	Description	Part number
N1501A-101	High temperature short	85070-60003
	High temperature probe	8710-2036
	Conductive elastomer short disk	85070-20036
N1501A-102	Slim form probe (quantity 3)	85070-20037
	Slim form short	85070-60004
	Slim form probe holder	85070-60007
	O-rings (quantity 6)	0905-1605
	Connector saver adapter	1250-3449
N1501A-104	Performance probe	85070-60010
	Performance probe short	85070-60012
N1501A-201	High temperature cable	8120-6286
N1501A-202	20 GHz Flexible cable	8120-6192
N1501A-203	50 GHz Flexible cable	8121-1290
N1501A-002	Probe stand	9301-1298
N1501A-003	Probe stand bracket	85070-20028
N1501A-004	ECal bracket	85070-60008
N1501A-005	10 mm Holder and key set	85070-60011
N1501A-006	Type N (male) to 3.5 mm (male) Adapter	1250-1743
11901D	2.4 mm (PSC female) to 3.5 mm (male) Adapter	11901-60004

Comparison between 85070E and N1501A model number structure

85070E products	Description	N1501A replacement	Description	Comments
85070E	Dielectric probe kit	N1501A	Dielectric probe kit hardware base model	
		N1501A-001	Walnut box	Accessories are now orderable separately.
		N1501A-003	Probe stand bracket	
		N1501A-004	ECal Bracket	
		N1501A-005	10 mm Holder	
		N1501A-006	Type N – 3.5 adapter	
		11901D	3.5 to 2.4 adapter	
		N1500A	Materials measurement software suite base model	The software is now ordered separately from the probe hardware
		N1500A-UL8	USB hardware key	
		N1500A-004	Open ended coaxial probe method	
85070E-001	Probe stand	N1501A-002	Probe stand	
85070E-002	High temperature cable	N1501A-201 or 8120-6286	High temperature cable	
85070E-020	High temperature probe kit	N1501A-101	High temperature probe kit	
85070E-021	High temperature probe upgrade kit			Probe kits are now orderable separately, so upgrade kit is no longer required
85070E-022	20 GHz flexible cable	N1501A-202	20 GHz flexible cable	
85070E-030	Slim form probe kit	N1501A-102	Slim form probe kit	
85070E-031	Slim form probe upgrade kit	N1501A-102		Probe kits are now orderable separately, so upgrade kit is no longer required

85070E products	Description	N1501A replacement	Description	Comments
85070E-032	50 GHz flexible cable	N1501A-203	50 GHz flexible cable	
85070E-033	Slim form replenishment kit	N1501A-103	Slim form Replenishment kit	
85070E-050	Performance probe kit	N1501A-104	Performance probe kit	
85070E-051	Performance probe upgrade kit	N1501A-104		

Learn more at: www.keysight.com

For more information on Keysight Technologies' products, applications or services, please contact your local Keysight office. The complete list is available at: www.keysight.com/find/contactus

