

Keysight 2-Port and 4-Port PNA Network Analyzer

N5224B 900 Hz to 43.5 GHz

N5225B 900 Hz to 50 GHz

Data Sheet and
Technical
Specifications

Documentation Warranty

THE MATERIAL CONTAINED IN THIS DOCUMENT IS PROVIDED "AS IS," AND IS SUBJECT TO BEING CHANGED, WITHOUT NOTICE, IN FUTURE EDITIONS. FURTHER, TO THE MAXIMUM EXTENT PERMITTED BY APPLICABLE LAW, KEYSIGHT DISCLAIMS ALL WARRANTIES, EITHER EXPRESS OR IMPLIED WITH REGARD TO THIS MANUAL AND ANY INFORMATION CONTAINED HEREIN, INCLUDING BUT NOT LIMITED TO THE IMPLIED WARRANTIES OF MERCHANTABILITY AND FITNESS FOR A PARTICULAR PURPOSE. KEYSIGHT SHALL NOT BE LIABLE FOR ERRORS OR FOR INCIDENTAL OR CONSEQUENTIAL DAMAGES IN CONNECTION WITH THE FURNISHING, USE, OR PERFORMANCE OF THIS DOCUMENT OR ANY INFORMATION CONTAINED HEREIN. SHOULD KEYSIGHT AND THE USER HAVE A SEPARATE WRITTEN AGREEMENT WITH WARRANTY TERMS COVERING THE MATERIAL IN THIS DOCUMENT THAT CONFLICT WITH THESE TERMS, THE WARRANTY TERMS IN THE SEPARATE AGREEMENT WILL CONTROL.

U.S. Government Rights

U.S. Government Rights. The Software is "commercial computer software," as defined by Federal Acquisition Regulation ("FAR") 2.101. Pursuant to FAR 12.212 and 27.405-3 and Department of Defense FAR Supplement ("DFARS") 227.7202, the U.S. government acquires commercial computer software under the same terms by which the software is customarily provided to the public. Accordingly, Keysight provides the Software to U.S. government customers under its standard commercial license, which is embodied in its End User License Agreement (EULA), a copy of which can be found at <http://www.keysight.com/find/sweula>. The license set forth in the EULA represents the exclusive authority by which the U.S. government may use, modify, distribute, or disclose the Software. The EULA and the license set forth therein, does not require or permit, among other things, that Keysight: (1) Furnish technical information related to commercial computer software or commercial computer software documentation that is not customarily provided to the public; or (2) Relinquish to, or otherwise provide, the government rights in excess of these rights customarily provided to the public to use, modify, reproduce, release, perform, display, or disclose commercial computer software or commercial computer software documentation. No additional government requirements beyond those set forth in the EULA shall apply, except to the extent that those terms, rights, or licenses are explicitly required from all providers of commercial computer software pursuant to the FAR and the DFARS and are set forth specifically in writing elsewhere in the EULA. Keysight shall be under no obligation to update, revise or otherwise modify the Software. With respect to any technical data as defined by FAR 2.101, pursuant to FAR 12.211 and 27.404.2 and DFARS 227.7102, the U.S. government acquires no greater than Limited Rights as defined in FAR 27.401 or DFARS 227.7103-5 (c), as applicable in any technical data.

Dynamic Range	9
System Dynamic Range	10
Table 1a. System Dynamic Range at Test Port (dB), Options 200 or 400.....	10
Table 1b. System Dynamic Range at Test Port (dB), Options 201 or 401	11
Table 1c. System Dynamic Range at Test Port (dB), Options 217, 417, 219, 419.....	12
Table 1d. System Dynamic Range at Test Port (dB), Option 205, 405	13
Table 1e. System Dynamic Range at Test Port (dB), Option 220, 420.....	14
Table 1f. System Dynamic Range at Test Port (dB), All LFE Options (LFE Enabled)	15
Extended Dynamic Range	16
Table 2a. Extended Dynamic Range at Direct Receiver Access Input (dB) – Typical	16
Table 2b. Extended Dynamic Range at Direct Receiver Access Input (dB) – Typical.....	17
Receiver Dynamic Range	18
Table 3a. Receiver Dynamic Range, N5224B, Option 200 or 400.....	18
Table 3b. Receiver Dynamic Range, N5225B, Option 200 or 400.....	18
Table 3c. Receiver Dynamic Range (dB), All Ports, All LFE Options (LFE Enabled).....	19
Corrected System Performance, All Options.....	20
Table 4a. N5224B and N5225B with 85056A Calibration Kit	20
Table 4b. N5224B and N5225B with 85056D Calibration Kit	23
Table 4c. N5224B and N5225B with N4693A 2-Port Electronic Calibration Module.....	26
Table 4d. N5224B and N5225B with N4693D 2-Port Electronic Calibration Module	29
Table 4e. N5224B and N5225B with 85056A Calibration Kit, All LFE Options (LFE Enabled) ...	32
Table 4f. N5224B and N5225B with N4693D Calibration Kit, All LFE Options (LFE Enabled) ...	33
Uncorrected System Performance	35
Table 5a. Error Terms (dB), All Ports, All Options - Specifications	35
Table 5b. Error Terms (dB), All Ports, All LFE Options (LFE Enabled) - Specifications.....	35
Table 5c. Error Terms (dB), All Ports, All Options - Typical.....	36
Table 5d. Error Terms (dB), All Ports, All LFE Options (LFE Enabled) - Typical	37
Test Port Output.....	38
Table 6. Frequency Information, All Options.....	38
Table 7a. Maximum Leveled Power (dBm), All Ports - Specification	38
Table 7b. Maximum Leveled Power (dBm), All Ports - Typical.....	39
Table 7c. Maximum Leveled Power (dBm) – All LFE Options - Specification	40
Table 7d. Maximum Leveled Power (dBm) –All LFE Options - Typical	41
Table 7e. Maximum Power (dBm), All Ports – All LFE Options (LFE Enabled)	41
Table 8a. Power Level Accuracy (dB) at Nominal Power ¹ , All Options.....	42

Table 8b. Power Level Accuracy (dB), All Ports, All LFE Options (LFE Enabled)	42
Table 9a. Power Level Linearity ¹ (dB), All Options - Specification	43
Table 9b. Power Level Linearity ¹ (dB), All Options - Specification	43
Table 9c. Power Level Linearity ¹ (dB), All Ports, All LFE Options (LFE Enabled).....	43
Table 10a. Power Sweep Range (dB), All Ports - Specification	44
Table 10b. N5224 and N5225B Power Sweep Range (dB), All Ports - Typical.....	45
Table 10c. Power Sweep Range (dB) – All LFE Options - Specification	46
Table 10d. Power Sweep Range (dB) – All LFE Options - Typical.....	47
Table 10e. Power Sweep Range (dB) – All LFE Options (LFE Enabled)	48
Table 11. Nominal (Preset) Power (dBm).....	48
Table 12. Power Resolution and Maximum/Minimum Settable Power, All Models and Options	48
Table 13a. 2 nd and 3 rd Harmonics at Max Specified Power (dBc) All Options - Typical.....	49
Table 13b. 2 nd and 3 rd Harmonics at Max Specified Power (dBc), All Ports, All LFE Options (LFE Enabled) - Typical.....	49
Table 14. Non-Harmonic Spurs ¹ at Nominal Power (dBc), All Models and Options – Typical...	50
Table 15a. Phase Noise (dBc/Hz), All Options, with UNY, Port 1, 3 - Typical	51
Table 15b. Phase Noise (dBc/Hz), All Options, with UNY, Port 2, 4 - Typical	52
Table 15c. Phase Noise (dBc/Hz), All Options, with UNY, All Ports – Supplemental Performance Data.....	52
Table 15d. Phase Noise (dBc/Hz) All LFE Options (LFE Enabled), with UNY, All Ports - Typical	53
Table 15e. Phase Noise (dBc/Hz), All Options, without UNY, All Ports - Typical	53
Table 15f. Phase Noise (dBc/Hz), All Options, without UNY, All Ports – Supplemental Performance Data.....	54
Test Port Input	55
Table 16a. Test Port Noise Floor (dBm) @ 10 Hz IFBW, All Options	55
Table 16b. Test Port Noise Floor (dBm) @ 10 Hz IFBW, All LFE Options (LFE Enabled).....	56
Table 17. Direct Receiver Access Input Noise Floor (dBm), Option 201, 205, 217, 219, 220, 401, 405, 417, 419, 420	57
Table 18a. 0.1 dB Receiver Compression at Test Port (dBm), Option 201, 217, 219, 401, 417, 419, and All LFE Options - Typical.....	57
Table 18b. 0.1 dB Compression, All Ports, All LFE Options (LFE Enabled) - Typical.....	58
Table 18c. Receiver Compression at Test Power - Specification	58
Table 18d. Compression, All Ports, All LFE Options (LFE Enabled) - Specification.....	59
Table 19a. Trace Noise ¹ Magnitude (dB rms)	59
Table 19b. Trace Noise ¹ Magnitude (dB rms), All Ports, All LFE Options (LFE Enabled)	60
Table 20a. Trace Noise ¹ Phase (deg rms)	60

Table 20b. Trace Noise ¹ Phase (deg rms), All Ports, All LFE Options (LFE Enabled)	61
Table 21. Reference Level Magnitude, All Models and Options - Specification	61
Table 22a. Stability, All Options - Typical	62
Table 22b. Stability ¹ , All LFE Options (LFE Enabled)- Typical	62
Table 23. Damage Input Level, All ports	62
Dynamic Accuracy	63
Table 24. N5224B and N5225B Dynamic Accuracy	63
Table 25. Group Delay - Typical.....	68
General Information	69
Table 26. Miscellaneous Information	69
Table 27. Front Panel Information, All Options.....	69
Table 27. (Continued) Front Panel Information, All Options.....	70
Table 28. Rear Panel Information, All Options.....	70
Table 28. (Continued) Rear Panel Information, All Options.....	71
Table 28. (Continued) Rear Panel Information, All Options.....	72
Table 28. (Continued) Rear Panel Information, All Options.....	73
Table 29. Analyzer Dimensions and Weight	74
Regulatory and Environmental Information	74
Measurement Throughput Summary	75
Table 30a. Typical Cycle Time (ms) for Measurement Completion, All Models and Options	75
Table 30b. N5224B Typical Cycle Time (ms) for Full-Span Measurement Completion.....	76
Table 30c. N5225B Typical Cycle Time (ms) for Full-Span Measurement Completion	76
Table 31. Cycle Time vs. IF Bandwidth - Typical	77
Table 32. Cycle Time vs. Number of Points - Typical	78
Table 33. Data Transfer Time (ms) - Typical.....	79
Specifications: Front-Panel Jumpers	80
Table 34. Measurement Receiver Inputs (dBm) - Typical.....	80
Table 35. Reference Receiver Inputs and Reference Source Outputs (dBm) - Typical	81
Table 36. Reference Receiver Inputs and Reference Receiver Outputs (dBm) - Typical.....	82
Table 37. Source Outputs (dBm) - Typical.....	83
Table 38. Coupler Inputs (dB) - Typical	84
Table 39. Damage Level - Typical.....	84

Test Set Block Diagrams.....	85
Figure 1. N5224B and N5225B Option 200 (2-port base model)	85
Figure 2. N5224B and N5225B Option 201	85
Figure 3. N5224B and N5225B LFE Options	86
Figure 4. N5224B and N5225B Option 217	86
Figure 5. N5224B and N5225B Option 219	87
Figure 6. N5224B and N5225B Option 400 (4-port base model)	87
Figure 7. N5224B and N5225B Option 401	88
Figure 8. N5224B and N5225B Option 417	88
Figure 9. N5224B and N5225B Option 419	89
Figure 10. Receiver Block Diagram	89

This is a complete list of the technical specifications for the N5224B and N5225B PNA network analyzers with the following options. See block diagrams on page 51 for all models and options.

2-Port Models

Option 200 - 2-port base model with standard test set.

Option 201 - To base model, adds front-panel jumpers and R1 receiver switch.

Option 217 - To base model, adds front-panel jumpers, R1 receiver switch, and source and receiver attenuators (extended power range).

Option 219 - To base model, adds front-panel jumpers, R1 receiver switch, source and receiver attenuators (extended power range), and bias-tees.

4-Port Models

Option 400 - 4-port base model with standard test set.

Option 401 - To base model, adds front-panel jumpers and R1 receiver switch.

Option 417 - To base model, adds front-panel jumpers, R1 receiver switch, and source and receiver attenuators (extended power range).

Option 419 - To base model, adds front-panel jumpers, R1 receiver switch, source and receiver attenuators (extended power range), and bias-tees.

Low Frequency Extension (LFE) Options

Option	Description
2-Port Model	
205	2-port standard test set (includes six front-panel access loops), R1 receiver switch, and low frequency extension (LFE) hardware.
220	2-port standard test set (includes six front-panel access loops), R1 receiver switch, source and receiver attenuators (extended power range), bias-tees, and low frequency extension (LFE) hardware.
4-Port Models	
405	4-port standard test set (includes six front-panel access loops), R1 receiver switch, and low frequency extension (LFE) hardware.
420	4-port standard test set (includes six front-panel access loops), R1 receiver switch, source and receiver attenuators (extended power range), bias-tees, and low frequency extension (LFE) hardware.

Notes

This document provides technical specifications for the 85056A and N4693A calibration kits.

Please download our free Uncertainty Calculator from http://www.keysight.com/find/na_calculator to generate the curves for your calibration kit and PNA setup.

For all tables in this data sheet, the specified performance at the exact frequency of a break is the degraded value of the two specifications at that frequency.

Definitions

All specifications and characteristics apply over a $25\text{ }^{\circ}\text{C} \pm 5\text{ }^{\circ}\text{C}$ range (unless otherwise stated) and 90 minutes after the instrument has been turned on.

Specification (spec.): Warranted performance. Specifications include guardbands to account for the expected statistical performance distribution, measurement uncertainties, and changes in performance due to environmental conditions.

Characteristic (char.): A performance parameter that the product is expected to meet before it leaves the factory, but that is not verified in the field and is not covered by the product warranty. A characteristic includes the same guardbands as a specification.

Typical (typ.): Expected performance of an average unit which does not include guardbands. It is not covered by the product warranty.

Nominal (nom.): A general, descriptive term that does not imply a level of performance. It is not covered by the product warranty.

Supplemental performance data (SPD): Represents the value of a parameter that is most likely to occur; the expected mean or average.

Calibration: The process of measuring known standards to characterize a network analyzer's systematic (repeatable) errors.

Corrected (residual): Indicates performance after error correction (calibration). It is determined by the quality of calibration standards and how well "known" they are, plus system repeatability, stability, and noise.

Uncorrected (raw): Indicates instrument performance without error correction. The uncorrected performance affects the stability of a calibration.

Standard: When referring to the analyzer, this includes no options unless noted otherwise.

Standard and LFE measurements: With an LFE option, which adds low frequency extension (LFE) hardware, the LFE measurement range overlaps with the standard measurement range from 10 MHz to 100 MHz. With LFE Enabled, measurements from 500 Hz to 100 MHz use LFE hardware. With LFE Disabled, measurements from 10 MHz to 100 MHz use standard hardware. To measure below 10 MHz, LFE must be enabled. All measurements above 100 MHz use standard hardware, regardless of the LFE Enabled/Disabled setting.

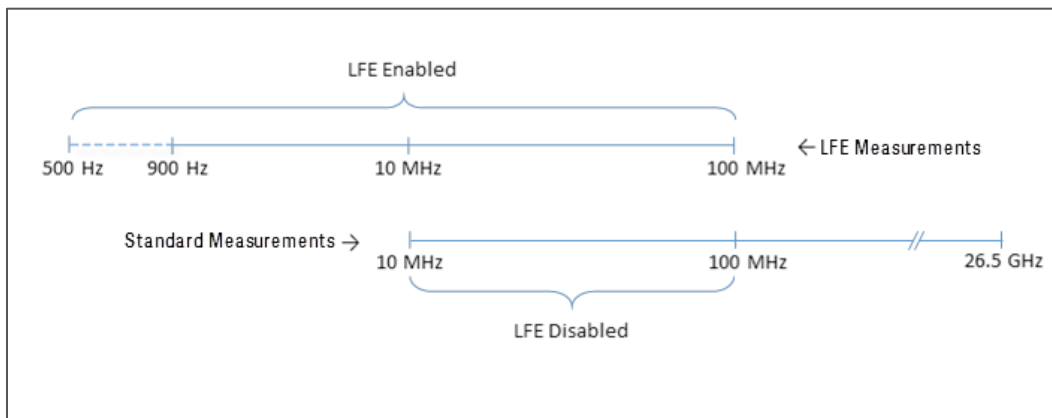

Dynamic Range

The specifications in this section apply for measurements made with the N5224B and N5225B PNA network analyzers with the following conditions:

- 10 Hz IF bandwidth
- No averaging applied to data
- Isolation calibration with an averaging factor of 8
- **System Dynamic Range** is defined as the measured source maximum output power (spec) minus the measured noise floor (spec).
- **Extended Dynamic Range at Direct Access Input** is defined as the system dynamic range (typical) less the nominal loss associated with the test port coupler.
- **Receiver Dynamic Range** is defined as the test port compression at 0.1 dB (typical) minus the noise floor (typical).

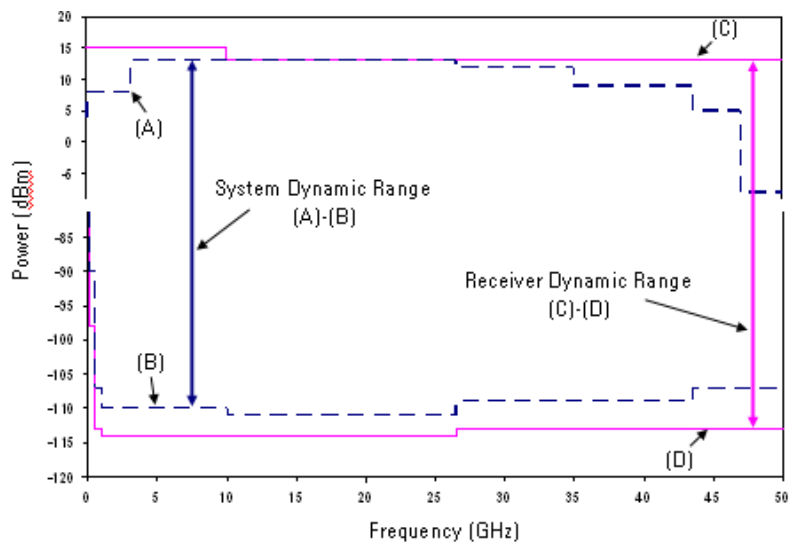

NOTE

The effective dynamic range must take measurement uncertainties and interfering signals into account. This set-up should only be used when the receiver input will never exceed its maximum receiver input. When the analyzer is in segment sweep mode, it can have predefined frequency segments which will output a higher power level when the extended dynamic range is required (i.e. devices with high insertion loss), and reduced power when the maximum receiver input level will occur (i.e. devices with low insertion loss). The extended range is only available in one-path transmission measurements.

It may typically be degraded at particular frequencies below 500 MHz due to spurious receiver residuals.

System Dynamic Range

Table 1a. System Dynamic Range at Test Port (dB), Options 200 or 400

Description	Specification		Typical	
	Ports ¹ 1, 3	Ports ¹ 2, 4	Ports ¹ 1, 3	Ports ¹ 2, 4
10 MHz to 50 MHz	87	85	95	94
50 MHz to 100 MHz	103	101	111	110
100 MHz to 250 MHz	110	110	125	125
250 MHz to 500 MHz	119	119	128	128
500 MHz to 1 GHz	127	128	136	137
1 GHz to 2 GHz	133	134	141	141
2 GHz to 3.2 GHz	131	132	138	140
3.2 GHz to 10 GHz	135	132	142	139
10 GHz to 13.5 GHz	130	130	138	137
13.5 GHz to 16 GHz	130	130	138	140
16 GHz to 20 GHz	130	130	138	140
20 GHz to 24 GHz	132	132	140	140
24 GHz to 26.5 GHz	132	131	139	139
26.5 GHz to 30 GHz	127	127	136	136
30 GHz to 32 GHz	128	128	136	136
32 GHz to 35 GHz	128	128	136	137
35 GHz to 40 GHz	123	124	132	132
40 GHz to 43.5 GHz	123	124	132	133
43.5 GHz to 47 GHz	123	124	133	133
47 GHz to 50 GHz	114	116	127	128

¹ Either port can be used as the source port. Any other port can be used as the receiver port.

Table 1b. System Dynamic Range at Test Port (dB), Options 201 or 401

Description	Specification		Typical	
	Ports ¹ 1, 3	Ports ¹ 2, 4	Ports ¹ 1, 3	Ports ¹ 2, 4
10 MHz to 50 MHz	87	86	95	94
50 MHz to 100 MHz	102	101	110	110
100 MHz to 250 MHz	109	109	123	123
250 MHz to 500 MHz	117	117	127	127
500 MHz to 1 GHz	127	128	135	137
1 GHz to 2 GHz	132	132	140	140
2 GHz to 3.2 GHz	130	132	137	140
3.2 GHz to 10 GHz	135	132	141	139
10 GHz to 13.5 GHz	128	128	137	137
13.5 GHz to 16 GHz	128	128	137	137
16 GHz to 20 GHz	128	128	137	137
20 GHz to 24 GHz	130	130	139	138
24 GHz to 26.5 GHz	129	129	137	138
26.5 GHz to 30 GHz	124	125	134	134
30 GHz to 32 GHz	126	126	135	134
32 GHz to 35 GHz	127	127	135	135
35 GHz to 40 GHz	121	122	130	131
40 GHz to 43.5 GHz	122	122	131	131
43.5 GHz to 47 GHz	122	122	131	132
47 GHz to 50 GHz	113	114	125	125

¹ Either port can be used as the source port. Any other port can be used as the receiver port.

Table 1c. System Dynamic Range at Test Port (dB), Options 217, 417, 219, 419

Description	Specification		Typical	
	Ports ¹ 1, 3	Ports ¹ 2, 4	Ports ¹ 1, 3	Ports ¹ 2, 4
10 MHz to 50 MHz	86	85	95	93
50 MHz to 100 MHz	102	101	110	109
100 MHz to 250 MHz	110	110	125	125
250 MHz to 500 MHz	121	120	129	128
500 MHz to 1 GHz	126	129	135	138
1 GHz to 2 GHz	132	132	140	140
2 GHz to 3.2 GHz	129	131	137	139
3.2 GHz to 10 GHz	135	132	142	139
10 GHz to 13.5 GHz	132	128	141	137
13.5 GHz to 16 GHz	130	128	139	136
16 GHz to 20 GHz	128	128	136	136
20 GHz to 24 GHz	130	130	138	138
24 GHz to 26.5 GHz	129	129	137	137
26.5 GHz to 30 GHz	123	122	131	131
30 GHz to 32 GHz	121	123	131	131
32 GHz to 35 GHz	124	124	132	132
35 GHz to 40 GHz	117	118	126	127
40 GHz to 43.5 GHz	117	118	126	126
43.5 GHz to 47 GHz	117	116	126	126
47 GHz to 50 GHz	108	105	119	118

¹ Either port can be used as the source port. Any other port can be used as the receiver port.

Table 1d. System Dynamic Range at Test Port (dB), Option 205, 405

Description	Specification		Typical	
	Ports ² 1, 3	Ports ² 2, 4	Ports ² 1, 3	Ports ² 2, 4
10 MHz to 50 MHz ¹	80	79	88	87
50 MHz to 100 MHz ¹	98	97	106	106
100 MHz to 250 MHz	105	105	119	119
250 MHz to 500 MHz	113	113	123	123
500 MHz to 1 GHz	124	125	132	134
1 GHz to 2 GHz	129	129	137	137
2 GHz to 3.2 GHz	127	129	134	137
3.2 GHz to 10 GHz	133	130	139	137
10 GHz to 13.5 GHz	126	126	135	135
13.5 GHz to 16 GHz	126	126	135	135
16 GHz to 20 GHz	123	123	135	135
20 GHz to 24 GHz	125	125	137	136
24 GHz to 26.5 GHz	124	124	135	136
26.5 GHz to 30 GHz	122	123	132	132
30 GHz to 32 GHz	124	124	133	132
32 GHz to 35 GHz	125	125	133	133
35 GHz to 40 GHz	119	120	128	129
40 GHz to 43.5 GHz	120	120	129	129
43.5 GHz to 47 GHz	120	120	127	130
47 GHz to 50 GHz	113	114	125	125

¹ With Option 205, 405 installed and LFE disabled, applied to frequencies <= 100 MHz. Above 100 MHz, performance is the same for both LFE enabled or disabled.

² Either port can be used as the source port. Any other port can be used as the receiver port.

Table 1e. System Dynamic Range at Test Port (dB), Option 220, 420

Description	Specification		Typical	
	Ports ² 1, 3	Ports ² 2, 4	Ports ² 1, 3	Ports ² 2, 4
10 MHz to 50 MHz ¹	79	78	88	86
50 MHz to 100 MHz ¹	98	97	106	105
100 MHz to 250 MHz	106	106	121	121
250 MHz to 500 MHz	117	116	125	124
500 MHz to 1 GHz	123	126	132	135
1 GHz to 2 GHz	129	129	137	137
2 GHz to 3.2 GHz	126	128	134	136
3.2 GHz to 10 GHz	133	129	140	137
10 GHz to 13.5 GHz	130	126	139	135
13.5 GHz to 16 GHz	128	126	137	134
16 GHz to 20 GHz	126	126	134	134
20 GHz to 24 GHz	128	128	136	136
24 GHz to 26.5 GHz	127	127	135	135
26.5 GHz to 30 GHz	121	120	129	129
30 GHz to 32 GHz	120	122	130	130
32 GHz to 35 GHz	123	123	131	131
35 GHz to 40 GHz	116	117	125	126
40 GHz to 43.5 GHz	116	117	125	125
43.5 GHz to 47 GHz	116	115	125	125
47 GHz to 50 GHz	107	104	118	117

¹ With Option 220, 420 installed and LFE disabled, applied to frequencies <= 100 MHz. Above 100 MHz, performance is the same for both LFE enabled or disabled.

Table 1f. System Dynamic Range at Test Port (dB), All LFE Options (LFE Enabled)

Description	Specification		Typical	
	Ports 1, 3	Ports 2, 4	Ports 1, 3	Ports 2, 4
500 Hz to 900 Hz	--	--	105	105
900 Hz to 1 kHz	100	102	109	110
1 kHz to 10 kHz	103	105	110	111
10 kHz to 100 kHz	113	115	120	121
100 kHz to 1 MHz	120	121	124	125
1 MHz to 5 MHz	121	122	126	127
5 MHz to 10 MHz	112	114	118	119
10 MHz to 50 MHz	110	112	116	117
50 MHz to 100 MHz	110	112	116	117

Extended Dynamic Range

Table 2a. Extended Dynamic Range at Direct Receiver Access Input (dB) – Typical

Description	201, 401		217, 417, 219, 419	
	Ports ¹ 1, 3	Ports ¹ 2, 4	Ports ¹ 1, 3	Ports ¹ 2, 4
10 MHz to 50 MHz	139	138	139	137
50 MHz to 100 MHz	140	140	140	139
100 MHz to 250 MHz	153	153	155	155
250 MHz to 500 MHz	147	147	149	148
500 MHz to 1 GHz	150	152	150	153
1 GHz to 2 GHz	155	155	155	155
2 GHz to 3.2 GHz	152	155	152	154
3.2 GHz to 10 GHz	156	154	157	154
10 GHz to 13.5 GHz	152	152	156	152
13.5 GHz to 16 GHz	152	152	154	151
16 GHz to 20 GHz	152	152	151	151
20 GHz to 24 GHz	153	152	152	152
24 GHz to 26.5 GHz	151	152	151	151
26.5 GHz to 30 GHz	148	148	145	145
30 GHz to 32 GHz	149	148	145	145
32 GHz to 35 GHz	149	149	146	146
35 GHz to 40 GHz	144	145	140	141
40 GHz to 43.5 GHz	143	143	138	138
43.5 GHz to 47 GHz	143	144	138	138
47 GHz to 50 GHz	137	137	131	130

¹ Either port can be used as the source port. Any other port can be used as the receiver port.

Table 2b. Extended Dynamic Range at Direct Receiver Access Input (dB) – Typical

Description	205, 405		220, 420	
	Ports ¹ 1, 3	Ports ¹ 2, 4	Ports ¹ 1, 3	Ports ¹ 2, 4
10 MHz to 50 MHz	132	131	132	130
50 MHz to 100 MHz	136	136	136	135
100 MHz to 250 MHz	149	149	151	151
250 MHz to 500 MHz	143	143	145	144
500 MHz to 1 GHz	147	149	147	150
1 GHz to 2 GHz	152	152	152	152
2 GHz to 3.2 GHz	149	152	149	151
3.2 GHz to 10 GHz	154	152	155	152
10 GHz to 13.5 GHz	150	150	154	150
13.5 GHz to 16 GHz	150	150	152	149
16 GHz to 20 GHz	150	150	149	149
20 GHz to 24 GHz	151	150	150	150
24 GHz to 26.5 GHz	149	150	149	149
26.5 GHz to 30 GHz	146	146	144	144
30 GHz to 32 GHz	147	146	144	144
32 GHz to 35 GHz	147	147	145	145
35 GHz to 40 GHz	142	143	139	140
40 GHz to 43.5 GHz	141	141	137	137
43.5 GHz to 47 GHz	141	142	137	137
47 GHz to 50 GHz	137	137	130	129

¹ Either port can be used as the source port. Any other port can be used as the receiver port.

Receiver Dynamic Range

Table 3a. Receiver Dynamic Range, N5224B, Option 200 or 400

Description	Typical
10 MHz to 50 MHz	90
50 MHz to 100 MHz	106
100 MHz to 250 MHz	112
250 MHz to 500 MHz	119
500 MHz to 1 GHz	124
1 GHz to 10 GHz	130
10 GHz to 26.5 GHz	132
26.5 GHz to 35 GHz	128
35 GHz to 40 GHz	128
40 GHz to 43.5 GHz	124

Table 3b. Receiver Dynamic Range, N5225B, Option 200 or 400

Description	Typical
10 MHz to 50 MHz	90
50 MHz to 100 MHz	106
100 MHz to 250 MHz	112
250 MHz to 500 MHz	119
500 MHz to 1 GHz	124
1 GHz to 10 GHz	130
10 GHz to 26.5 GHz	132
26.5 GHz to 35 GHz	128
35 GHz to 40 GHz	128
40 GHz to 43.5 GHz	124
43.5 GHz to 47 GHz	126
47 GHz to 50 GHz	126

Table 3c. Receiver Dynamic Range (dB), All Ports, All LFE Options (LFE Enabled)

Description	Typical
500 Hz to 900 Hz	106
900 Hz to 1 kHz	109
1 kHz to 10 kHz	109
10 kHz to 100 kHz	118
100 kHz to 1 MHz	123
1 MHz to 5 MHz	123
5 MHz to 10 MHz	119
10 MHz to 50 MHz	120
50 MHz to 100 MHz	120

Corrected System Performance, All Options

For any S_{ii} reflection measurement:

- $S_{jj} = 0$.

For any S_{ij} transmission measurement:

- $S_{ji} = S_{ij}$ when $S_{ij} \leq 1$
- $S_{ji} = 1/S_{ij}$ when $S_{ij} > 1$
- $S_{kk} = 0$ for all k

Applies to the N5224B/5A Option 200, 201, 205, 217, 219, 400, 401, 405, 417, 419, or 420 analyzers, 85133F flexible test port cable set, and a full 2-port calibration. Also applies to the following condition:

Environmental temperature $23^\circ \pm 3^\circ \text{C}$, with $< 1^\circ \text{C}$ deviation from calibration temperature

Table 4a. N5224B and N5225B with 85056A Calibration Kit

Description	Specification (dB)						
	10 MHz to 50 MHz ¹	50 MHz to 2 GHz ¹	2 GHz to 10 GHz	10 GHz to 20 GHz	20 GHz to 30 GHz	30 GHz to 40 GHz	40 GHz to 50 GHz
Directivity	41	41	41	41	37	37	35
Source Match	41	41	37	37	33	33	31
Load Match	41	41	41	41	37	37	35
Reflection Tracking Mag	± 0.0015	± 0.0015	± 0.0082	± 0.0082	± 0.021	± 0.021	± 0.028
Phase (°)	± 0.0093	± 0.0093	± 0.055	± 0.055	± 0.14	± 0.14	± 0.19
Transmission Tracking Mag	± 0.046	± 0.021	± 0.036	± 0.052	± 0.13	± 0.13	± 0.17
Phase (°)	± 0.31	± 0.14	± 0.24	± 0.34	± 0.82	± 0.82	± 1.1

¹ With an LFE option installed and LFE disabled, applied to frequencies ≤ 100 MHz. Above 100 MHz, performance is the same for both LFE enabled or disabled.

Transmission Uncertainty, All Options

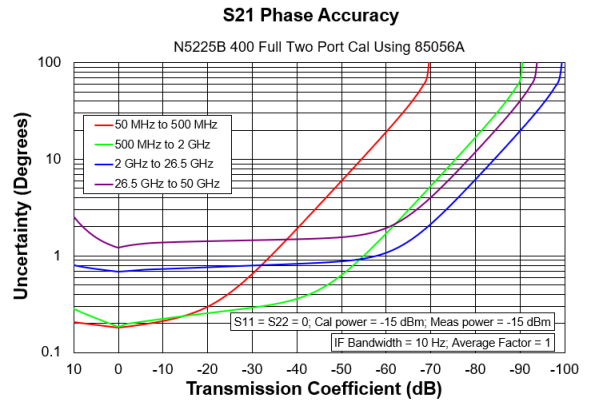
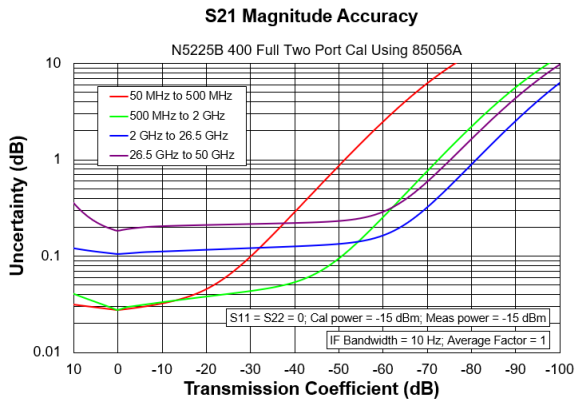
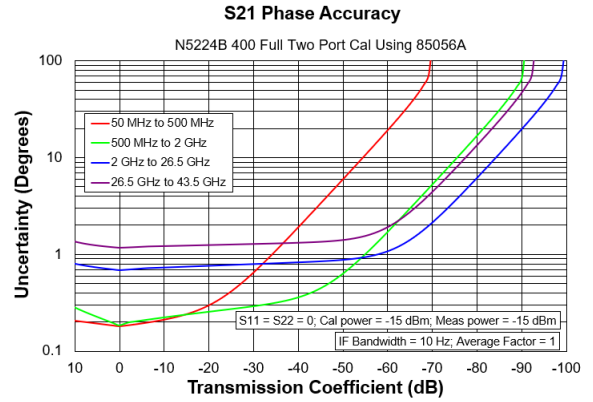
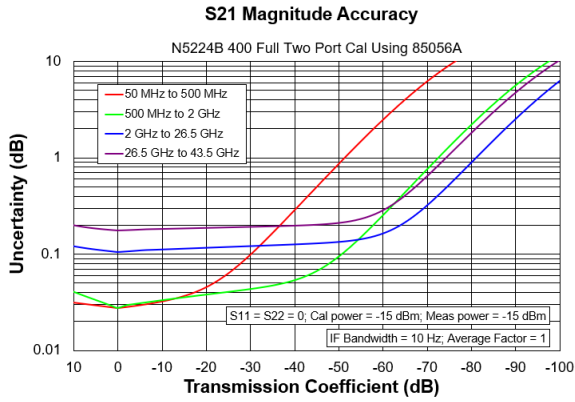

Reflection Uncertainty, All Options

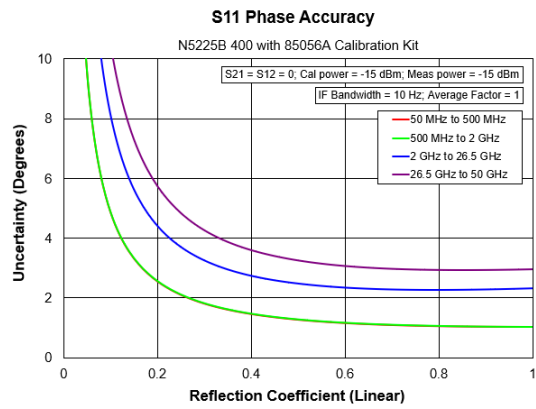
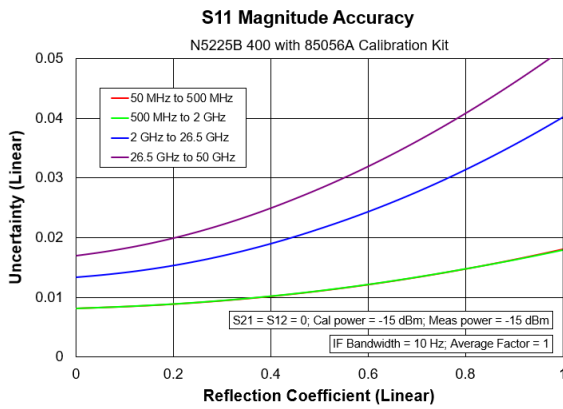
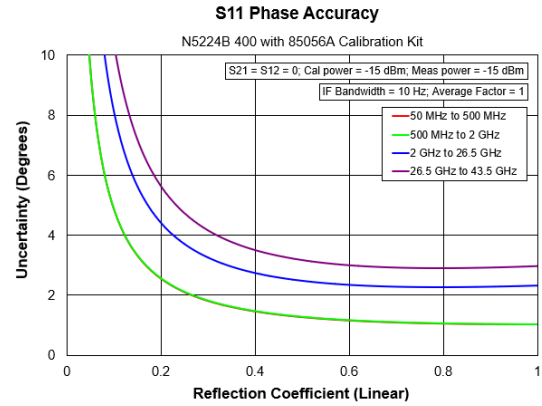
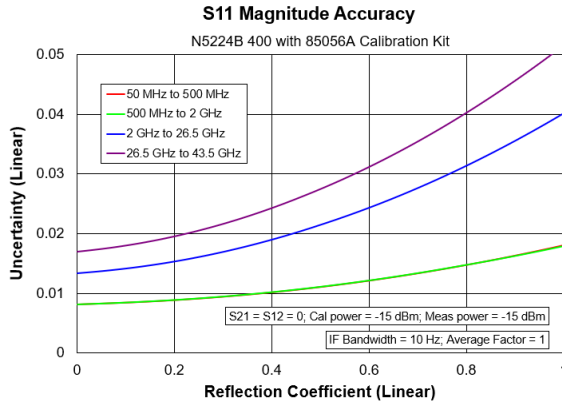
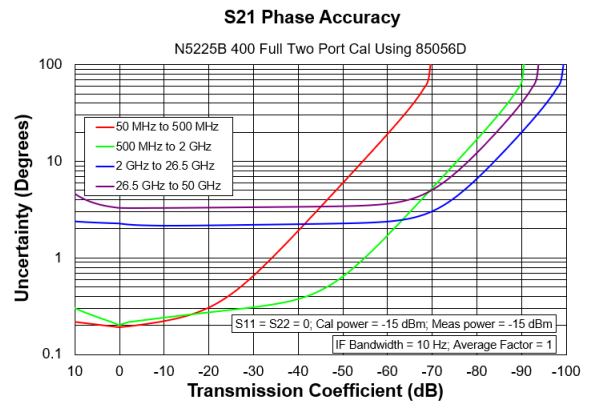
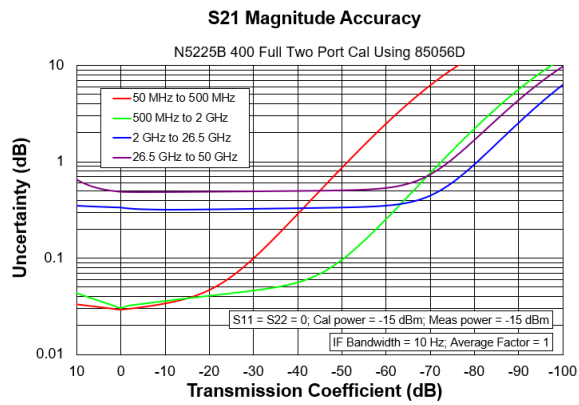
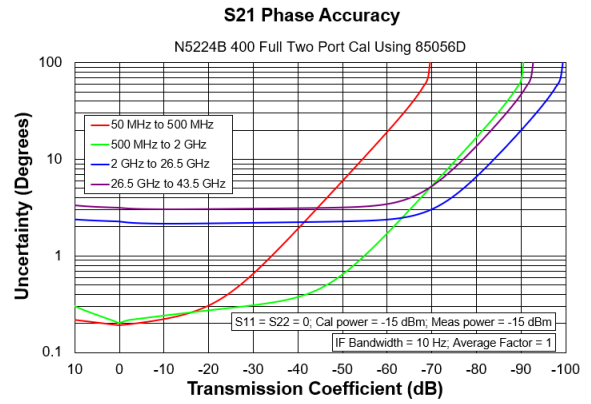
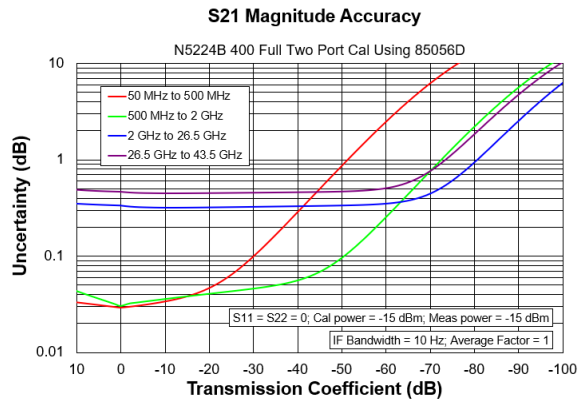

Table 4b. N5224B and N5225B with 85056D Calibration Kit

Description	Specification (dB)						
	10 MHz to 50 MHz ¹	50 MHz to 2 GHz ¹	2 GHz to 10 GHz	10 GHz to 20 GHz	20 GHz to 30 GHz	30 GHz to 40 GHz	40 GHz to 50 GHz
Directivity	41	41	33	33	25	25	25
Source Match	39	39	30	30	23	23	23
Load Match	41	41	33	33	25	25	25
Reflection Tracking Mag	±0.0025	±0.0025	±0.029	±0.029	±0.080	±0.080	±0.075
Phase (°)	±0.016	±0.016	±0.19	±0.19	±0.53	±0.53	±0.50
Transmission Tracking Mag	±0.051	±0.024	±0.088	±0.13	±0.41	±0.41	±0.45
Phase (°)	±0.34	±0.16	±0.58	±0.84	±2.8	±2.8	±3.1

¹ With an LFE option installed and LFE disabled, applied to frequencies <= 100 MHz. Above 100 MHz, performance is the same for both LFE enabled or disabled.

Transmission Uncertainty, All Options



Reflection Uncertainty, All Options

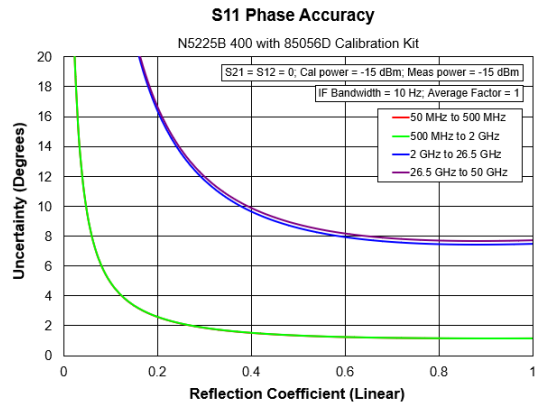
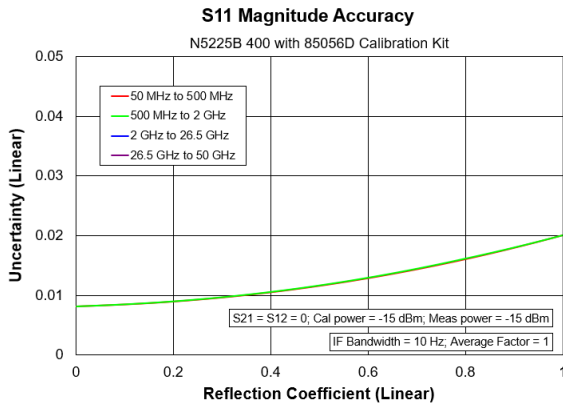
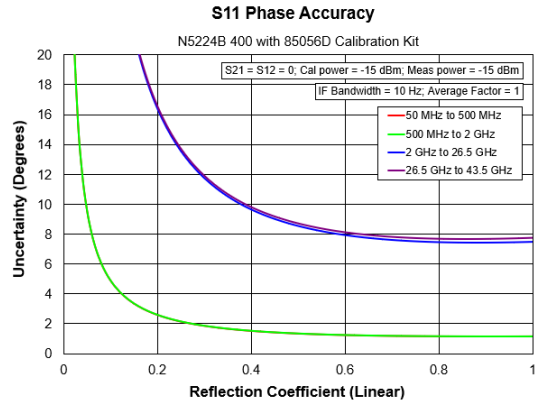
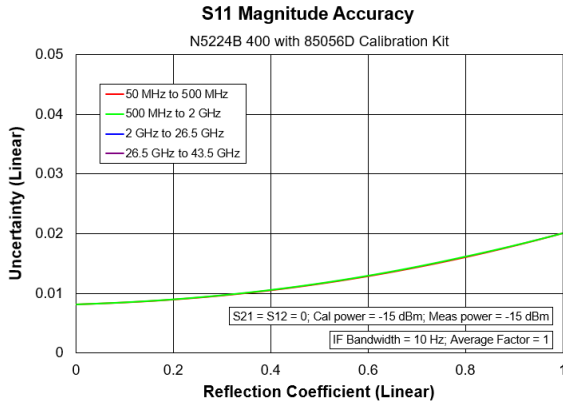
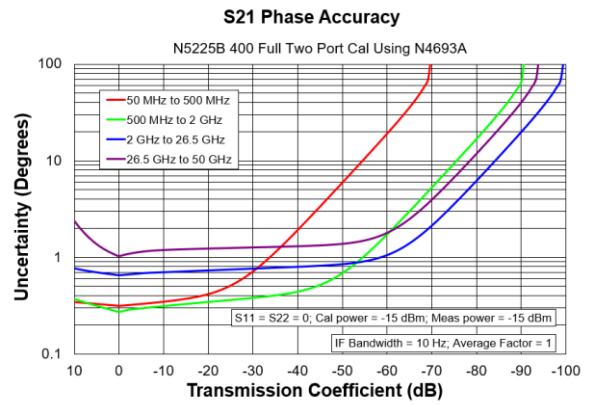
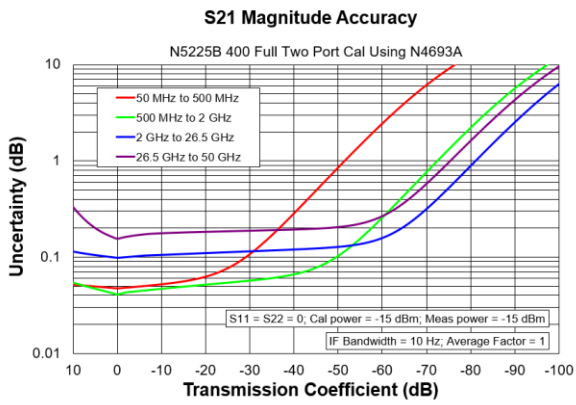
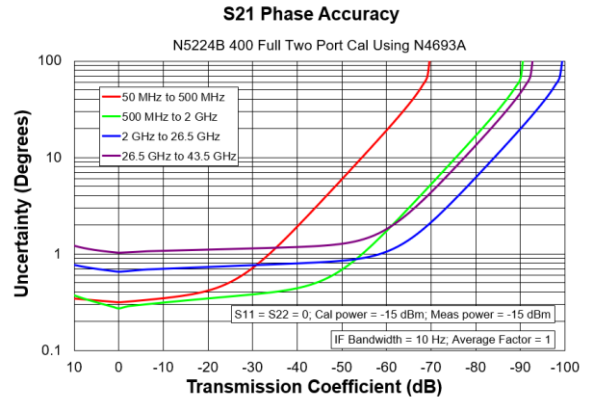
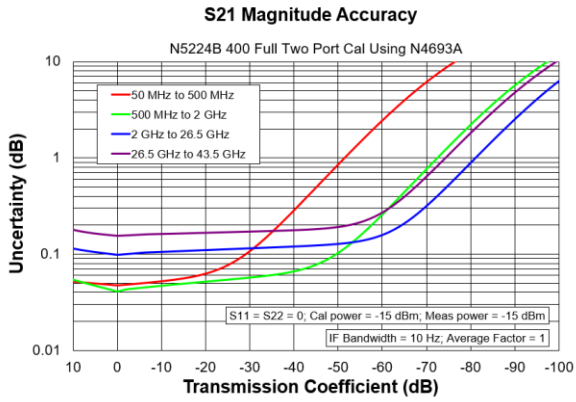

Table 4c. N5224B and N5225B with N4693A 2-Port Electronic Calibration Module

Description	Specification (dB)						
	10 MHz to 50 MHz ¹	50 MHz to 2 GHz ¹	2 GHz to 10 GHz	10 GHz to 20 GHz	20 GHz to 30 GHz	30 GHz to 40 GHz	40 GHz to 50 GHz
Directivity	32	42	49	45	41	41	36
Source Match	25	44	42	37	35	35	32
Load Match	24	43	40	35	33	33	30
Reflection Tracking Mag	±0.051	±0.031	±0.041	±0.051	±0.061	±0.061	±0.081
Phase (°)	±0.34	±0.20	±0.27	±0.34	±0.40	±0.40	±0.54
Transmission Tracking Mag	±0.12	±0.038	±0.047	±0.066	±0.091	±0.091	±0.14
Phase (°)	±0.79	±0.25	±0.31	±0.44	±0.61	±0.61	±0.90

¹ With an LFE option installed and LFE disabled, applied to frequencies <= 100 MHz. Above 100 MHz, performance is the same for both LFE enabled or disabled.

Transmission Uncertainty, All Options



Reflection Uncertainty, All Options

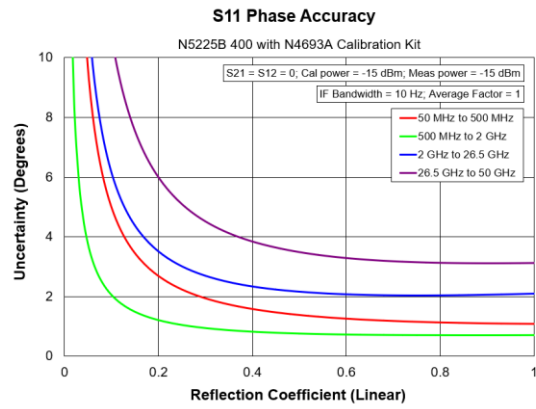
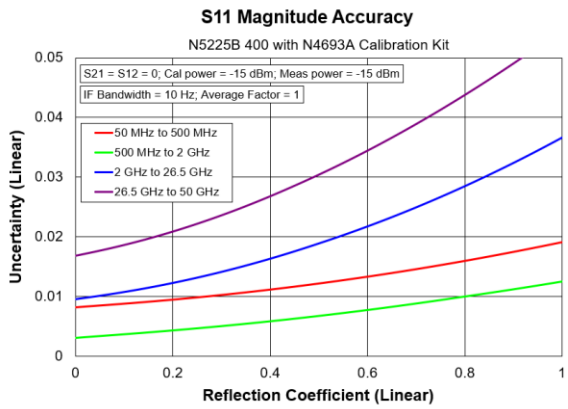
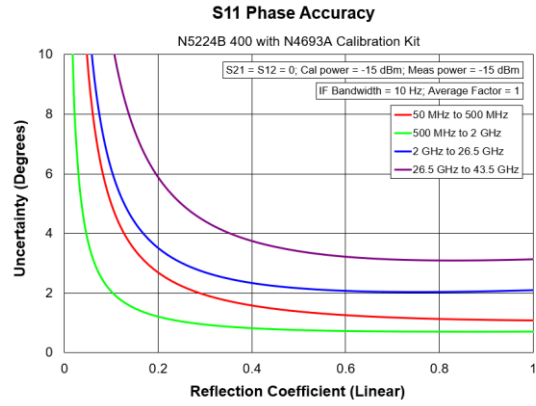
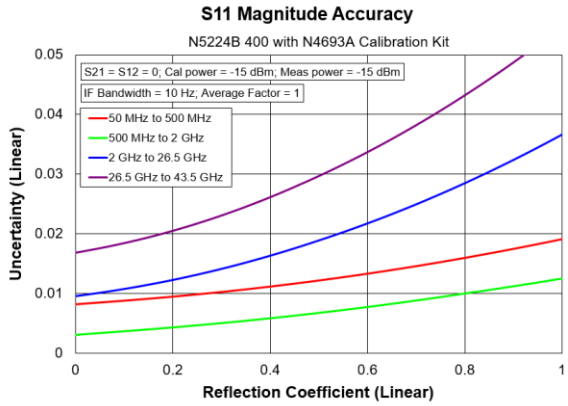
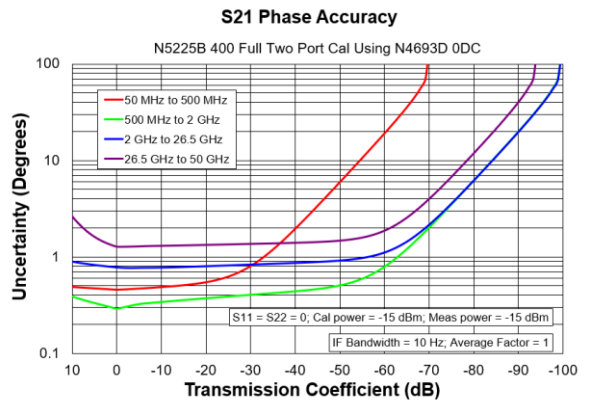
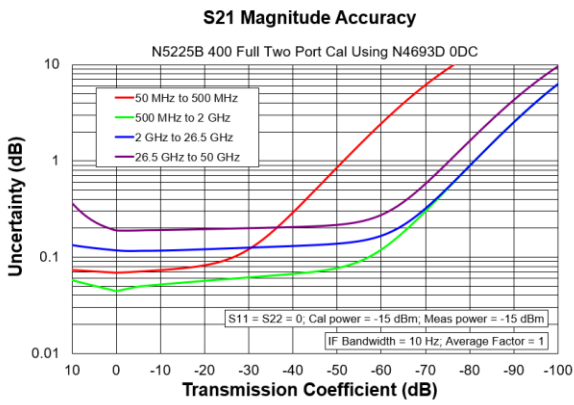
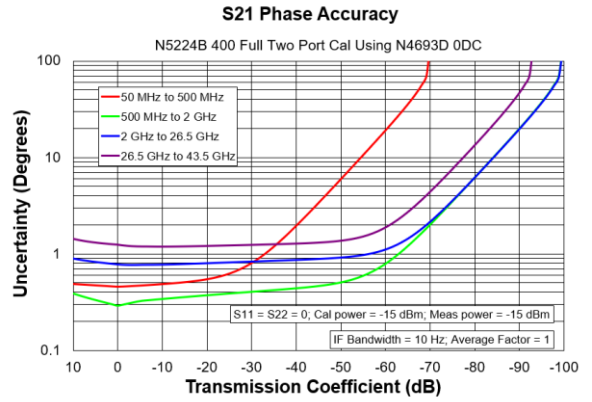
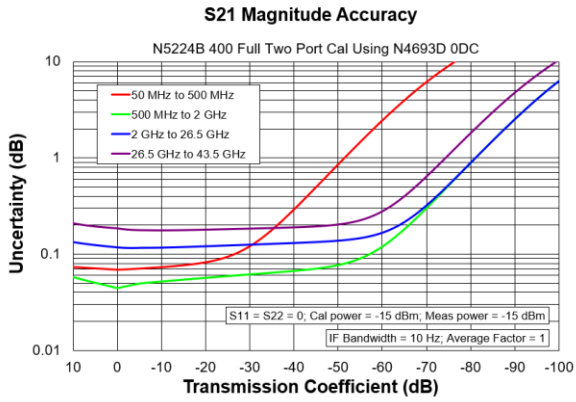

Table 4d. N5224B and N5225B with N4693D 2-Port Electronic Calibration Module

Description	Specification (dB)						
	10 MHz to 50 MHz ¹	50 MHz to 2 GHz ¹	2 GHz to 10 GHz	10 GHz to 20 GHz	20 GHz to 30 GHz	30 GHz to 40 GHz	40 GHz to 50 GHz
Directivity	40	40	47	44	38	38	34
Source Match	38	44	42	37	35	35	32
Load Match	36	43	40	35	33	33	30
Reflection Tracking Mag	±0.051	±0.051	±0.041	±0.051	±0.061	±0.061	±0.081
Phase (°)	±0.34	±0.34	±0.27	±0.34	±0.40	±0.40	±0.54
Transmission Tracking Mag	±0.078	±0.060	±0.049	±0.068	±0.11	±0.11	±0.15
Phase (°)	±0.52	±0.40	±0.33	±0.45	±0.69	±0.69	±0.99

¹ With an LFE option installed and LFE disabled, applied to frequencies <= 100 MHz. Above 100 MHz, performance is the same for both LFE enabled or disabled.

Transmission Uncertainty, All Options



Reflection Uncertainty, All Options

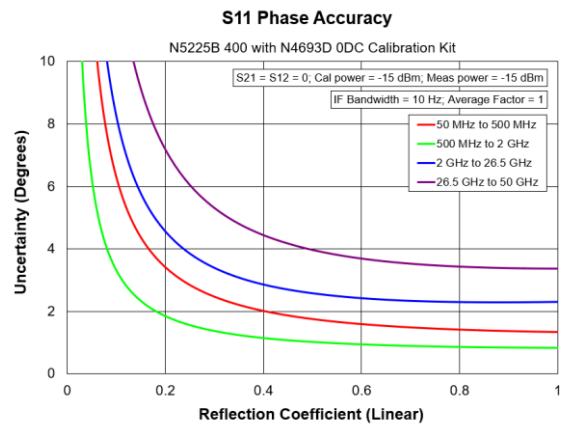
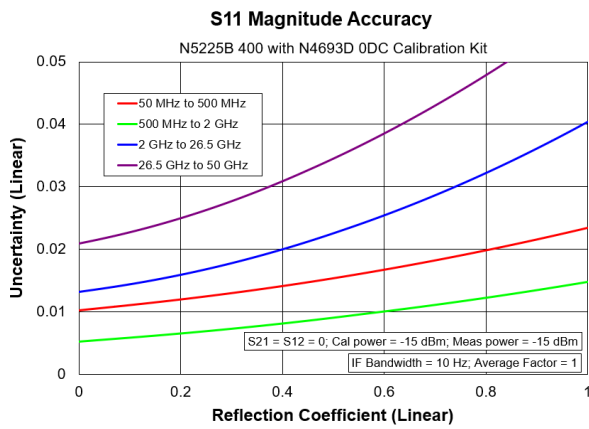
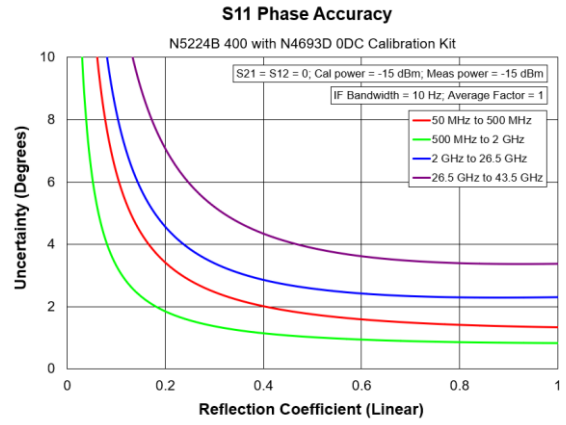
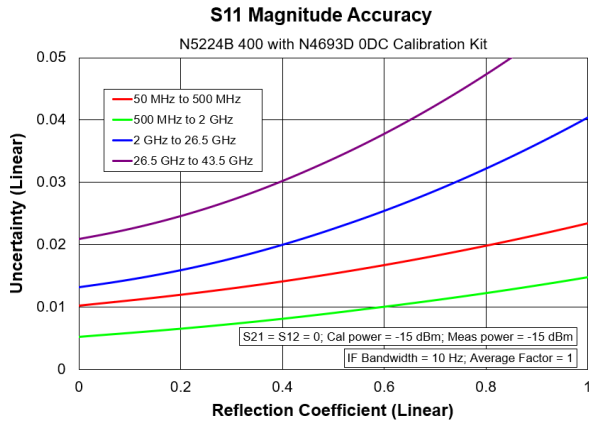
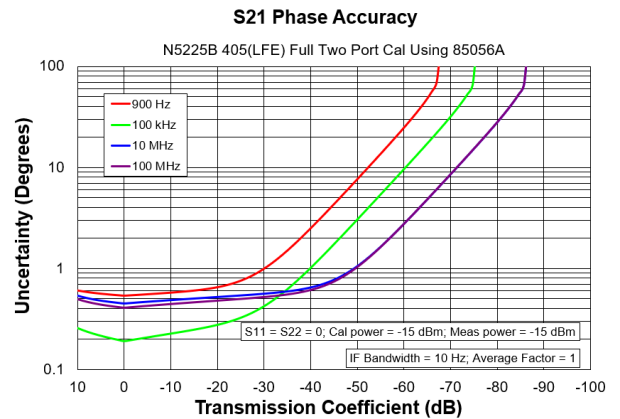
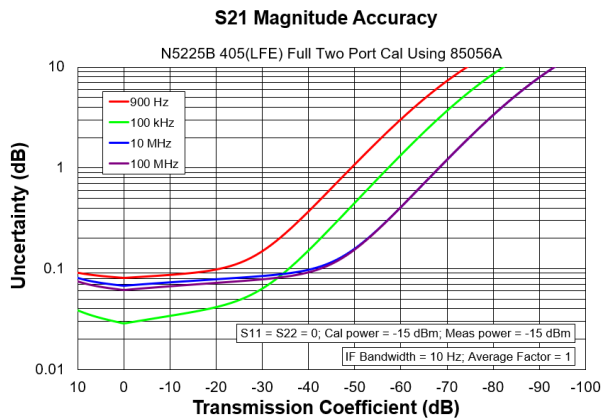

Table 4e. N5224B and N5225B with 85056A Calibration Kit, All LFE Options (LFE Enabled)

Description	Specification (dB)				
	1 kHz to 10 kHz	10 kHz to 1 MHz	1 MHz to 5 MHz	5 MHz to 50 MHz	50 MHz to 100 MHz
Directivity	41	41	41	41	41
Source Match	41	41	41	41	41
Load Match	41	41	41	41	41
Reflection Tracking Mag	±0.0015	±0.0015	±0.0015	±0.0015	±0.0015
Phase (°)	±0.0093	±0.0093	±0.0093	±0.0093	±0.0093
Transmission Tracking Mag	±0.065	±0.021	±0.046	±0.061	±0.055
Phase (°)	±0.43	±0.14	±0.31	±0.41	±0.36

Transmission Uncertainty, All LFE Options

NOTE The plots are valid for all LFE options.



Reflection Uncertainty, All LFE Options

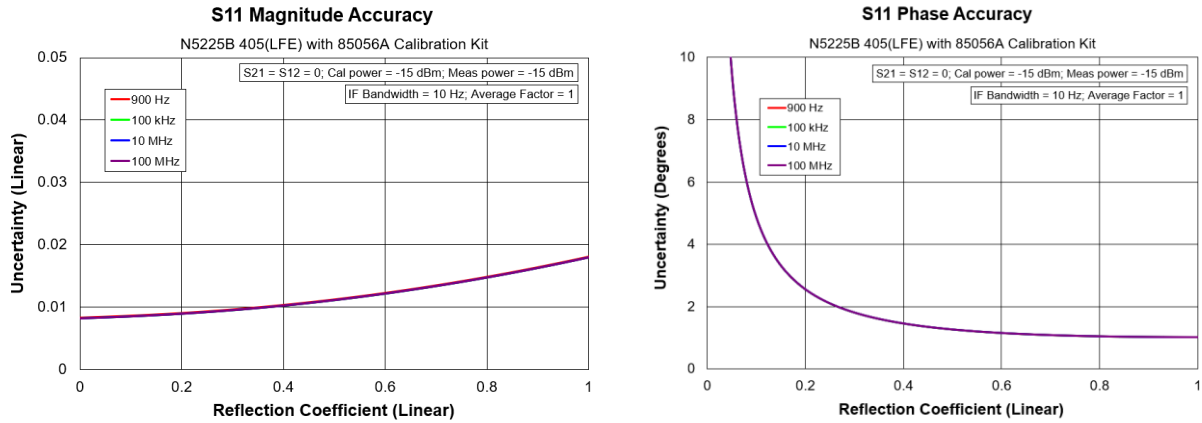
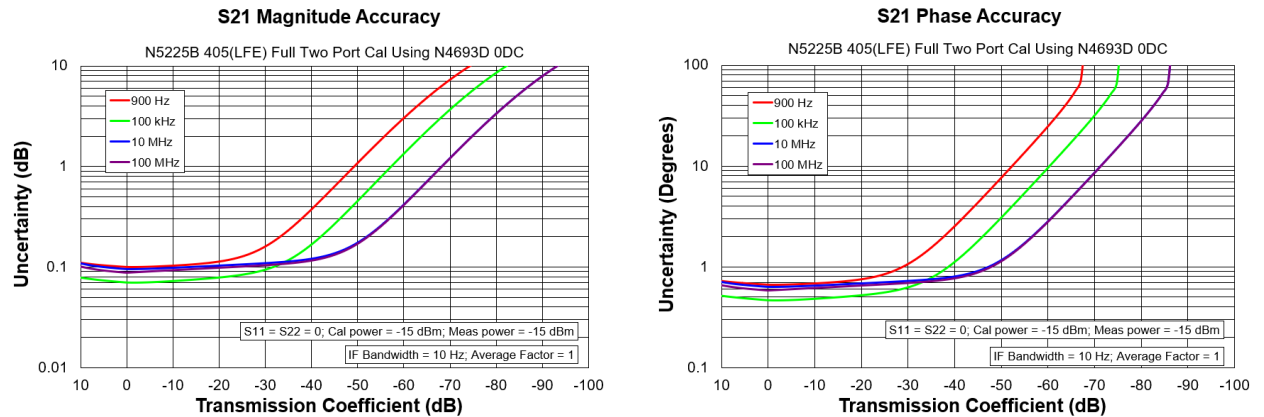

Table 4f. N5224B and N5225B with N4693D Calibration Kit, All LFE Options (LFE Enabled)

Description	Specification (dB)				
	1 kHz to 10 kHz	10 kHz to 1 MHz	1 MHz to 5 MHz	5 MHz to 50 MHz	50 MHz to 100 MHz
Directivity	40	40	40	40	40
Source Match	38	38	38	38	44
Load Match	36	37	36	36	41
Reflection Tracking Mag	±0.051	±0.051	±0.051	±0.051	±0.051
Phase (°)	±0.34	±0.34	±0.34	±0.34	±0.34
Transmission Tracking Mag	±0.089	±0.060	±0.075	±0.085	±0.081
Phase (°)	±0.59	±0.40	±0.50	±0.56	±0.54

Transmission Uncertainty, All LFE Options

NOTE The plots are valid for all LFE options.



Reflection Uncertainty, All LFE Options

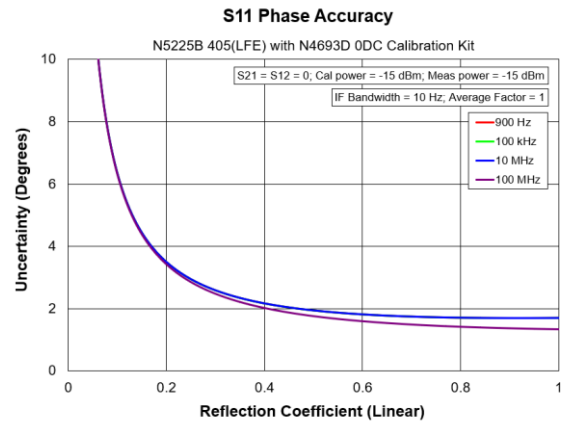
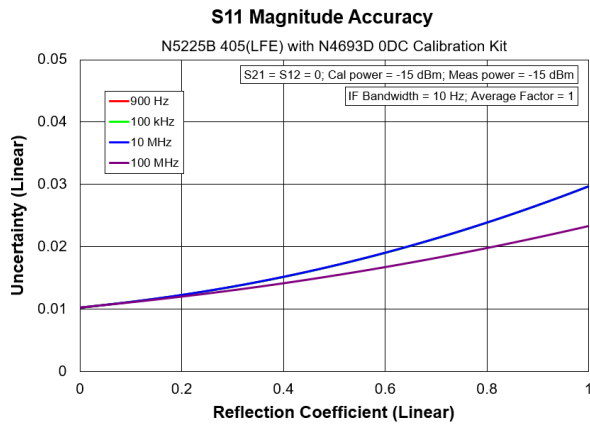

Uncorrected System Performance

Specifications apply to following conditions:

- Cable loss not included in Transmission Tracking.
- Crosstalk measurement conditions: normalized to a thru, measured with shorts on all ports, 10 Hz IF bandwidth, averaging factor of 8, alternate mode, source power set to the specified maximum power.

Table 5a. Error Terms (dB), All Ports, All Options - Specifications

Description	Directivity	Source Match	Load Match	Transmission Tracking	Reflection Tracking	Crosstalk
10 MHz to 50 MHz ¹	18 (18)	10 (8)	10 (8)	--	--	--
50 MHz to 200 MHz ¹	22 (22)	21 (6)	19 (7)	--	--	--
200 MHz to 500 MHz	24 (24)	21 (6)	18 (7)	--	--	--
500 MHz to 3.2 GHz	25 (25)	18 (7)	16 (6)	--	--	--
3.2 GHz to 10 GHz	22 (22)	16 (9)	13 (8)	--	--	--
10 GHz to 13.5 GHz	18 (18)	13 (10)	11 (8)	--	--	--
13.5 GHz to 20 GHz	18 (18)	13 (9)	10 (7)	--	--	--
20 GHz to 26.5 GHz	16 (16)	12 (7)	10 (6)	--	--	--
26.5 GHz to 43.5 GHz	16 (16)	8 (7)	8 (6)	--	--	--
43.5 GHz to 50 GHz	15 (15)	7 (6)	8 (6)	--	--	--

() With an LFE option installed.

¹ With an LFE option installed and LFE disabled, applied to frequencies ≤ 100 MHz. Above 100 MHz, performance is the same for both LFE enabled or disabled. For LFE enabled performance ≤ 100 MHz, see Table 5b.

Table 5b. Error Terms (dB), All Ports, All LFE Options (LFE Enabled) - Specifications

Description	Directivity	Source Match	Load Match	Transmission Tracking	Reflection Tracking	Crosstalk
1 kHz to 10 kHz	1	7	7	--	--	--
10 kHz to 1 MHz	16	15	19	--	--	--
1 MHz to 5 MHz	16	9	11	--	--	--
5 MHz to 50 MHz	5	7	8	--	--	--
50 MHz to 100 MHz	5	8	9	--	--	--

Table 5c. Error Terms (dB), All Ports, All Options - Typical

Description	Directivity	Source Match	Load Match	Transmission Tracking	Reflection Tracking	Crosstalk
10 MHz to 50 MHz ¹	21	15 (11)	15 (11)	±1.0	±0.7	-82
50 MHz to 200 MHz ¹	28	31 (10)	26 (10)	±1.0	±0.7	-85
200 MHz to 500 MHz	33	29 (8)	24 (9)	±1.0	±0.7	-110
500 MHz to 3.2 GHz	30	25 (8)	20 (8)	±1.0	±0.7	-120
3.2 GHz to 10 GHz	25	22 (13)	17 (12)	±1.0	±0.7	-120
10 GHz to 13.5 GHz	23	21 (13)	15 (12)	±1.0	±0.7	-120
13.5 GHz to 16 GHz	20	20 (13)	14 (12)	±1.0	±0.7	-120
16 GHz to 20 GHz	19	18 (13)	16 (12)	±1.0	±0.7	-120
20 GHz to 24 GHz	20	17 (10)	14 (10)	±1.0	±0.7	-120
24 GHz to 26.5 GHz	21	17 (10)	15 (10)	±1.0	±0.7	-120
26.5 GHz to 35 GHz	19	15 (10)	13 (10)	±1.0	±0.7	-120
35 GHz to 43.5 GHz	19	15 (9)	13 (9)	±1.0	±0.7	-115
43.5 GHz to 46 GHz	19	14 (9)	14 (9)	±1.0	±0.7	-105
46 GHz to 50 GHz	19	13 (9)	13 (9)	±1.0	±0.7	-100

() With an LFE option installed.

¹ With an LFE option installed and LFE disabled, applied to frequencies ≤ 100 MHz. Above 100 MHz, performance is the same for both LFE enabled or disabled. For LFE enabled performance ≤ 100 MHz, see Table 5d.

Table 5d. Error Terms (dB), All Ports, All LFE Options (LFE Enabled) - Typical

Description	Directivity	Source Match	Load Match	Transmission Tracking	Reflection Tracking	Crosstalk
500 Hz to 900 Hz	--	--	--	--	--	-102
900 Hz to 1 kHz	4	8	9	±1.5	±1.5	-106
1 kHz to 10 kHz	5	9	8	±1.5	±1.5	-100
10 kHz to 100 kHz	23	19	23	±1.5	±1.5	-106
100 kHz to 1 MHz	23	19	23	±1.5	±1.5	-126
1 MHz to 5 MHz	26	13	14	±1.5	±1.5	-121
5 MHz to 10 MHz	11	9	10	±1.5	±1.5	-121
10 MHz to 50 MHz	11	9	10	±1.5	±1.5	-117
50 MHz to 100 MHz	11	11	11	±1.5	±1.5	-117

Test Port Output

See Block diagrams for all models and options.

Table 6. Frequency Information, All Options

Description	Specification	Typical
N5224B Frequency Range	10 MHz to 43.5 GHz	--
N5225B Frequency Range	10 MHz to 50 GHz	--
N5224B Frequency Range (LFE Options)	900 Hz to 43.5 GHz	500 Hz to 900 Hz
N5225B Frequency Range (LFE Options)	900 Hz to 50 GHz	500 Hz to 900 Hz
Frequency Resolution	1 Hz	--
Frequency Accuracy	±0.7 ppm	--
Initial Frequency Accuracy ¹	±0.2 ppm	±0.1 ppm
Frequency Stability	--	±0.05 ppm, -10° to 70° C ² ±0.5 (first year) ³

¹ Verified after Factory Frequency Reference adjustment, or after adjustment at a Keysight Service Center.

² Assumes no variation in time.

³ Assumes no variation in temperature.

Table 7a. Maximum Levelled Power (dBm), All Ports - Specification

Description	Option 200, 400	Option 201, 401	Option 217, 417, 219, 419
10 MHz to 50 MHz	12	12	10
50 MHz to 16 GHz	13	13	11
16 GHz to 26.5 GHz	13	13	10
26.5 GHz to 30 GHz	13	12	9
30 GHz to 32 GHz	13	11	7
32 GHz to 35 GHz	13	12	9
35 GHz to 43.5 GHz	10	9	4
43.5 GHz to 47 GHz	6	5	-1
47 GHz to 50 GHz	-2	-5	-11

Table 7b. Maximum Leveled Power (dBm), All Ports - Typical

Description	Option 200, 400	Option 201, 401	Option 217, 417, 219, 419
10 MHz to 1 GHz	18	18	18
1 GHz to 2 GHz	19	19	19
2 GHz to 3.2 GHz	18	18	17
3.2 GHz to 10 GHz	20	20	20
10 GHz to 13.5 GHz	18	18	17
13.5 GHz to 16 GHz	20	19	18
16 GHz to 20 GHz	18	18	17
20 GHz to 24 GHz	18	18	16
24 GHz to 26.5 GHz	18	17	15
26.5 GHz to 30 GHz	19	18	16
30 GHz to 35 GHz	18	17	14
35 GHz to 43.5 GHz	15	14	11
43.5 GHz to 47 GHz	12	10	7
47 GHz to 50 GHz	8	5	4

Table 7c. Maximum Levelled Power (dBm) – All LFE Options - Specification

Description	Option 205, 405	Option 220, 420
10 MHz to 50 MHz ¹	5	3
50 MHz to 16 GHz ¹	9	7
16 GHz to 26.5 GHz	8	8
26.5 GHz to 30 GHz	10	8
30 GHz to 32 GHz	9	6
32 GHz to 35 GHz	10	8
35 GHz to 43.5 GHz	7	3
43.5 GHz to 47 GHz	3	-2
47 GHz to 50 GHz	-5	-12

¹ With an LFE option installed and LFE disabled, applied to frequencies <= 100 MHz. Above 100 MHz, performance is the same for both LFE enabled or disabled. For LFE enabled performance <= 100 MHz, see Table 7e.

Table 7d. Maximum Levelled Power (dBm) –All LFE Options – Typical

Description	Option 205, 405	Option 220, 420
10 MHz to 1 GHz	11	11
1 GHz to 2 GHz	16	16
2 GHz to 3.2 GHz	15	14
3.2 GHz to 10 GHz	18	18
10 GHz to 13.5 GHz	16	15
13.5 GHz to 16 GHz	17	16
16 GHz to 20 GHz	16	15
20 GHz to 24 GHz	16	14
24 GHz to 26.5 GHz	15	13
26.5 GHz to 30 GHz	16	15
30 GHz to 35 GHz	15	13
35 GHz to 43.5 GHz	12	10
43.5 GHz to 47 GHz	8	6
47 GHz to 50 GHz	5	3

¹ With an LFE option installed and LFE disabled, applied to frequencies ≤ 100 MHz. Above 100 MHz, performance is the same for both LFE enabled or disabled. For LFE enabled performance ≤ 100 MHz, see Table 7e.

Table 7e. Maximum Power (dBm), All Ports – All LFE Options (LFE Enabled)

Description	Specification	Typical ¹
500 Hz to 900 Hz	--	12
900 Hz to 1 kHz	10	13
1 kHz to 10 kHz	12	13
10 kHz to 100 kHz	12	14
100 kHz to 1 MHz	12	14
1 MHz to 5 MHz	10	13
5 MHz to 10 MHz	9	11
10 MHz to 50 MHz	8	10
50 MHz to 100 MHz	8	10

¹ Values apply to all ports. Ports 2 and 4 typically 1 dB higher.

Table 8a. Power Level Accuracy (dB) at Nominal Power¹, All Options

Description	Specification	Typical
10 MHz to 50 MHz ²	±1.5	±0.5
50 MHz to 1 GHz ²	±1.0	±0.4
1 GHz to 3.2 GHz	±1.2	±0.1
3.2 GHz to 13.5 GHz	±1.5	±0.3
13.5 GHz to 20 GHz	±1.5	±0.2
20 GHz to 26.5 GHz	±1.8	±0.2
26.5 GHz to 43.5 GHz	±2.2	±0.3
43.5 GHz to 50 GHz	±3.2	±0.5

¹ Level accuracy at power other than nominal power, Power Level Accuracy (dB) at Nominal Power + Power Level Linearity (dB).

² With an LFE option installed and LFE disabled, applied to frequencies ≤ 100 MHz. Above 100 MHz, performance is the same for both LFE enabled or disabled. For LFE enabled performance ≤ 100 MHz, see Table 8b.

Table 8b. Power Level Accuracy (dB), All Ports, All LFE Options (LFE Enabled)

Description	Specification	Typical
500 Hz to 900 Hz	--	±0.1
900 Hz to 1 kHz	±1.0	±0.1
1 kHz to 10 kHz	±1.0	±0.1
10 kHz to 100 kHz	±1.0	±0.1
100 kHz to 1 MHz	±1.0	±0.15
1 MHz to 5 MHz	±1.0	±0.15
5 MHz to 10 MHz	±1.0	±0.2
10 MHz to 50 MHz	±1.0	±0.2
50 MHz to 100 MHz	±1.0	±0.2

Table 9a. Power Level Linearity¹ (dB), All Options - Specification

Description	Port 1 or 3 ² -25dBm ≤ P < -20dBm	Port 1 or 3 ² -20dBm ≤ P < -15dBm	Port 1 or 3 ² P ≥ -15dBm
10 MHz to 50 MHz ³	±2.5	±1.5	±1.5
50 MHz to 500 MHz ³	±2.0	±1.5	±1.5
500 MHz to 50 GHz	±1.5	±1.5	±1.5

¹ Referenced to nominal power.

² Either port can be used as the source port.

³ With an LFE option installed and LFE disabled, applied to frequencies ≤ 100 MHz. Above 100 MHz, performance is the same for both LFE enabled or disabled. For LFE enabled performance ≤ 100 MHz, see Table 9c.

Table 9b. Power Level Linearity¹ (dB), All Options - Specification

Description	Port 2 or 4 ² -25dBm ≤ P < -20dBm	Port 2 or 4 ² -20dBm ≤ P < -15dBm	Port 2 or 4 ² P ≥ -15dBm
10 MHz to 50 MHz ³	±2.5	±1.5	±1.5
50 MHz to 3.2 GHz ³	±2.0	±1.5	±1.5
3.2 GHz to 50 GHz	±1.5	±1.5	±1.5

¹ Referenced to nominal power.

² Either port can be used as the source port.

³ With an LFE option installed and LFE disabled, applied to frequencies ≤ 100 MHz. Above 100 MHz, performance is the same for both LFE enabled or disabled. For LFE enabled performance ≤ 100 MHz, see Table 9c.

Table 9c. Power Level Linearity¹ (dB), All Ports, All LFE Options (LFE Enabled)

Description	Specification
500 Hz to 900 Hz	--
900 Hz to 100 MHz	±1.0

¹ Referenced to nominal power, from -25 dBm to max power.

Table 10a. Power Sweep Range (dB), All Ports - Specification

Description	Option 200, 400	Option 201, 401	Option 217, 219, 417, 419
10 MHz to 50 MHz	37	37	35
50 MHz to 16 GHz	38	38	36
16 GHz to 26.5 GHz	38	38	35
26.5 GHz to 30 GHz	38	37	34
30 GHz to 32 GHz	38	36	32
32 GHz to 35 GHz	38	37	34
35 GHz to 43.5 GHz	35	34	29
43.5 GHz to 47 GHz	31	30	24
47 GHz to 50 GHz	23	20	14

Table 10b. N5224 and N5225B Power Sweep Range (dB), All Ports - Typical

Description	Option 200, 400	Option 201, 401	Option 217, 219, 417, 419
10 MHz to 1 GHz	45	45	45
1 GHz to 2 GHz	46	46	46
2 GHz to 3.2 GHz	45	45	44
3.2 GHz to 10 GHz	47	47	47
10 GHz to 13.5 GHz	45	45	44
13.5 GHz to 16 GHz	47	46	45
16 GHz to 20 GHz	45	45	44
20 GHz to 24 GHz	45	45	43
24 GHz to 26.5 GHz	45	44	42
26.5 GHz to 30 GHz	46	45	43
30 GHz to 35 GHz	45	44	41
35 GHz to 43.5 GHz	42	41	38
43.5 GHz to 47 GHz	39	37	34
47 GHz to 50 GHz	35	32	31

Table 10c. Power Sweep Range (dB) – All LFE Options - Specification

Description	Option 205, 405	Option 220, 420
10 MHz to 50 MHz ¹	30	28
50 MHz to 16 GHz ¹	34	32
16 GHz to 26.5 GHz	33	33
26.5 GHz to 30 GHz	35	32
30 GHz to 32 GHz	34	30
32 GHz to 35 GHz	35	32
35 GHz to 43.5 GHz	32	28
43.5 GHz to 47 GHz	28	23
47 GHz to 50 GHz	20	13

¹ With an LFE option installed and LFE disabled, applied to frequencies ≤ 100 MHz. Above 100 MHz, performance is the same for both LFE enabled or disabled. For LFE enabled performance ≤ 100 MHz, see Table 10e.

Table 10d. Power Sweep Range (dB) – All LFE Options – Typical

Description	Option 205, 405	Option 220, 420
10 MHz to 1 GHz ¹	38	38
1 GHz to 2 GHz	43	43
2 GHz to 3.2 GHz	42	41
3.2 GHz to 10 GHz	45	45
10 GHz to 13.5 GHz	43	42
13.5 GHz to 16 GHz	44	43
16 GHz to 20 GHz	43	42
20 GHz to 24 GHz	43	41
24 GHz to 26.5 GHz	42	40
26.5 GHz to 30 GHz	43	42
30 GHz to 35 GHz	42	40
35 GHz to 43.5 GHz	39	37
43.5 GHz to 47 GHz	35	33
47 GHz to 50 GHz	32	30

¹ With an LFE option installed and LFE disabled, applied to frequencies ≤ 100 MHz. Above 100 MHz, performance is the same for both LFE enabled or disabled. For LFE enabled performance ≤ 100 MHz, see Table 10e.

Table 10e. Power Sweep Range (dB) – All LFE Options (LFE Enabled)

Description	Specification	Typical
500 Hz to 900 Hz	--	39
900 Hz to 1 kHz	35	40
1 kHz to 10 kHz	37	40
10 kHz to 100 kHz	37	41
100 kHz to 1 MHz	37	41
1 MHz to 5 MHz	35	40
5 MHz to 10 MHz	34	38
10 MHz to 50 MHz	33	37
50 MHz to 100 MHz	33	37

Table 11. Nominal (Preset) Power (dBm)

Description	N5224B	N5225B
Option 200, 201, 205, 400, 401, 405	0	-5
Option 217, 219, 220, 417, 419, 420	-5	-15

Table 12. Power Resolution and Maximum/Minimum Settable Power, All Models and Options

Description	Specification (dB)	Typical (dBm)
Power Resolution	0.01	
Maximum Settable Power	--	30
Minimum Settable Power		
Option 200, 201, 205, 400, 401, 405	--	-30
Option 217, 219, 220, 417, 419, 420	--	-90

Table 13a. 2nd and 3rd Harmonics at Max Specified Power (dBc) All Options - Typical

Listed frequency is fundamental frequency; test at max specified power.

Description	2 nd Harmonic	3 rd Harmonic
10 MHz to 50 MHz ¹	-15	-15
50 MHz to 2 GHz ¹	-21	-15
2 GHz to 13.5 GHz	-18	-19
13.5 GHz to 16.7 GHz	-60	-65
16.7 GHz to 25 GHz	-60	--

¹ With an LFE option installed and LFE disabled, applied to frequencies <= 100 MHz. Above 100 MHz, performance is the same for both LFE enabled or disabled. For LFE enabled performance <= 100 MHz, see Table 13b.

Table 13b. 2nd and 3rd Harmonics at Max Specified Power (dBc), All Ports, All LFE Options (LFE Enabled) - Typical

Listed frequency is fundamental frequency; test at max specified power.

Description	2 nd Harmonic	3 rd Harmonic
500 Hz to 900 Hz	-32	-31
900 Hz to 1 kHz	-22	-23
1 kHz to 10 kHz	-22	-23
10 kHz to 100 kHz	-22	-23
100 kHz to 1 MHz	-25	-22
1 MHz to 5 MHz	-28	-24
5 MHz to 10 MHz	-27	-22
10 MHz to 33 MHz	-28	-21
33 MHz to 50 MHz	-28	--

Table 14. Non-Harmonic Spurs¹ at Nominal Power (dBc), All Models and Options – Typical

Listed frequency is Source CW frequency, tested at 0 dBm.

Description	Non-Harmonic	±600 MHz Tracking Spur
10 MHz to 1 GHz	-80	-80
1 GHz to 10 GHz	-85	-81
10 GHz to 20 GHz	-82	-75
20 GHz to 31 GHz	-80	-70
31 GHz to 50 GHz	-77	-67

¹ Non-harmonic spurs are negligible with Option 425 installed and LFE enabled.

Tracking Spurs (Linear Frequency Scale)

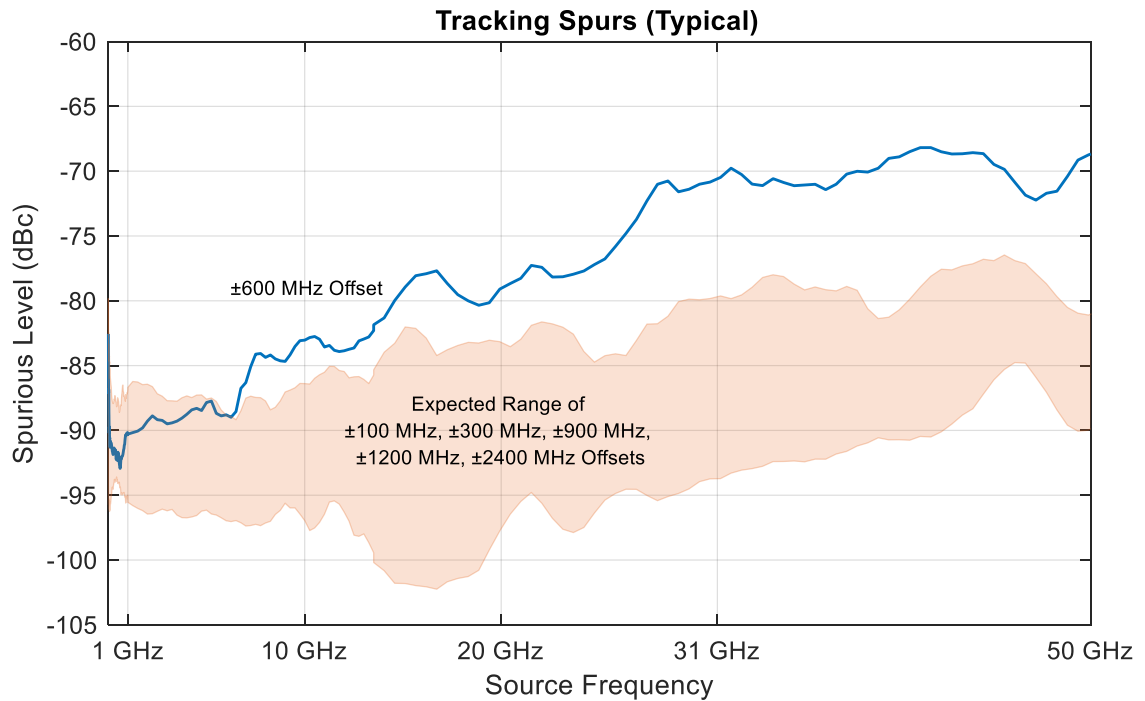

Tracking Spurs (Logarithmic Frequency Scale)

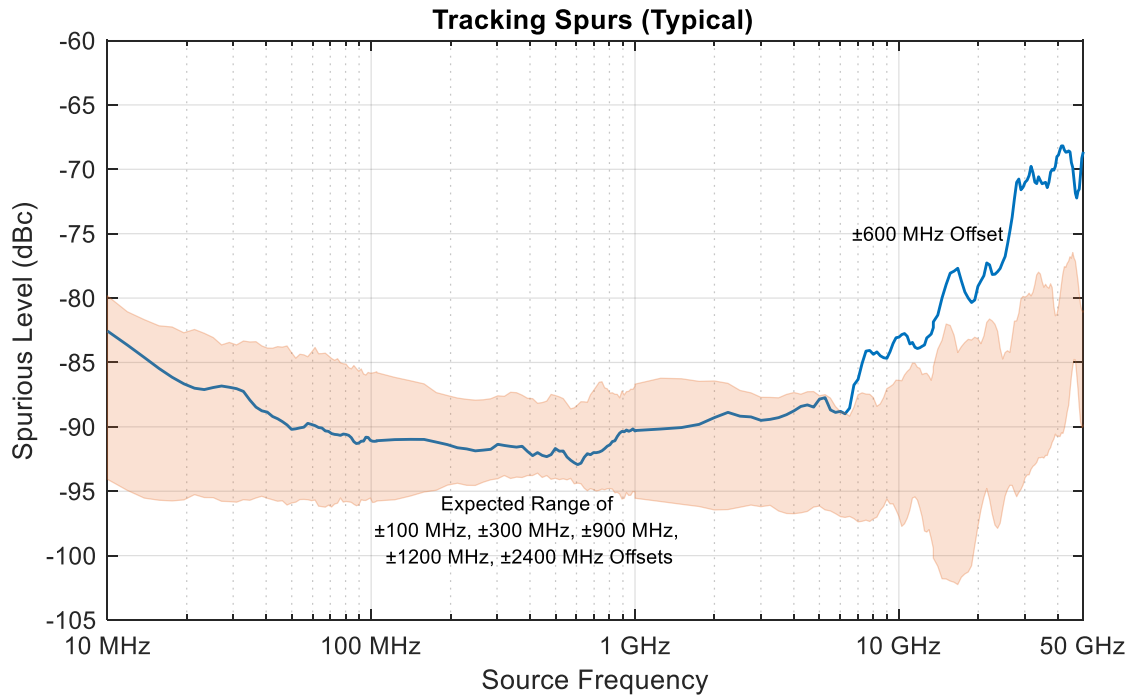

Table 15a. Phase Noise (dBc/Hz), All Options, with UNY, Port 1, 3 - Typical

CW Frequency	100 Hz Offset	1 kHz Offset	10 kHz Offset	100 kHz Offset	1 MHz Offset	10 MHz Offset
1 GHz	-112	-132	-137	-143	-145	-144
5 GHz	-103	-123	-132	-135	-147	-150
10 GHz	-96	-116	-126	-130	-142	-146
20 GHz	-91	-111	-118	-123	-135	-139
26.5 GHz	-87	-106	-115	-121	-131	-135

Table 15b. Phase Noise (dBc/Hz), All Options, with UNY, Port 2, 4 - Typical

CW Frequency	100 Hz Offset	1 kHz Offset	10 kHz Offset	100 kHz Offset	1 MHz Offset	10 MHz Offset
1 GHz	-111	-121	-132	-145	-149	-149
5 GHz	-103	-122	-128	-134	-145	-149
10 GHz	-96	-112	-120	-127	-140	-147
20 GHz	-90	-108	-116	-123	-134	-139
26.5 GHz	-86	-106	-114	-121	-131	-135

Table 15c. Phase Noise (dBc/Hz), All Options, with UNY, All Ports – Supplemental Performance Data

CW Frequency	100 Hz Offset	1 kHz Offset	10 kHz Offset	100 kHz Offset	1 MHz Offset	10 MHz Offset
43.5 GHz	-82	-106	-113	-117	-129	-135
50 GHz	-81	-101	-109	-116	-127	-132

Phase Noise with Option UNY (Typical)

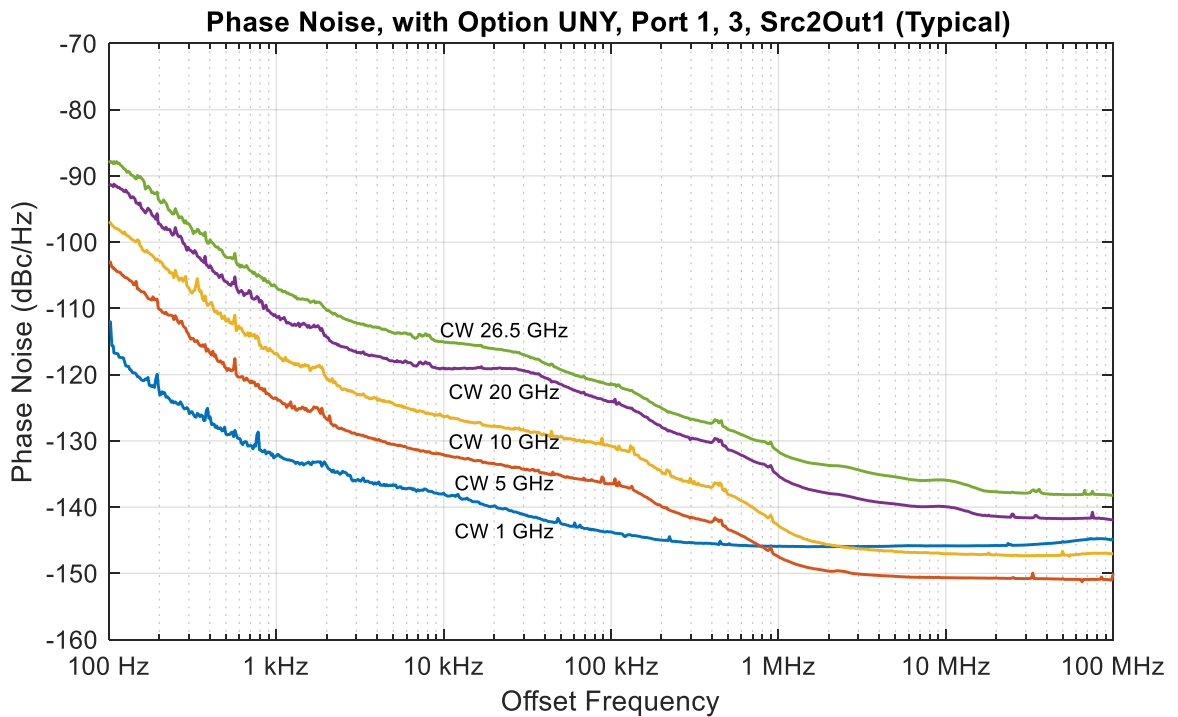

Phase Noise with Option UNY (Supplemental Performance Data)

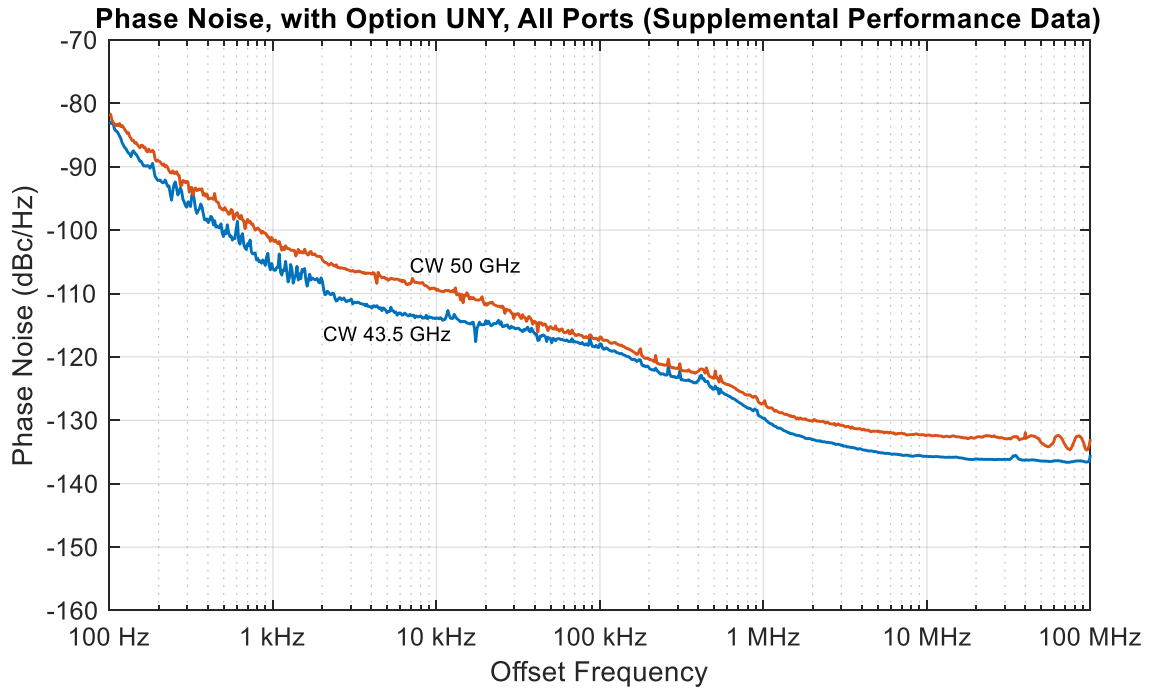

Table 15d. Phase Noise (dBc/Hz) All LFE Options (LFE Enabled), with UNY, All Ports - Typical

Description	1 kHz Offset	10 kHz Offset	100 kHz Offset	1 MHz Offset
500 Hz to 100 MHz	-120	-130	-125	-135

Table 15e. Phase Noise (dBc/Hz), All Options, without UNY, All Ports - Typical

CW Frequency	100 Hz Offset	1 kHz Offset	10 kHz Offset	100 kHz Offset	1 MHz Offset	10 MHz Offset
1 GHz	-94	-116	-130	-141	-145	-146
5 GHz	-83	-106	-119	-128	-139	-147
10 GHz	-78	-100	-113	-122	-133	-142
20 GHz	-72	-94	-107	-116	-127	-135
26.5 GHz	-67	-90	-104	-114	-124	-132

Table 15f. Phase Noise (dBc/Hz), All Options, without UNY, All Ports – Supplemental Performance Data

CW Frequency	100 Hz Offset	1 kHz Offset	10 kHz Offset	100 kHz Offset	1 MHz Offset	10 MHz Offset
43.5 GHz	-70	-90	-103	-112	-122	-130
50 GHz	-66	-86	-101	-111	-121	-130

Phase Noise, CW 10 GHz, with Option UNY and without Option UNY

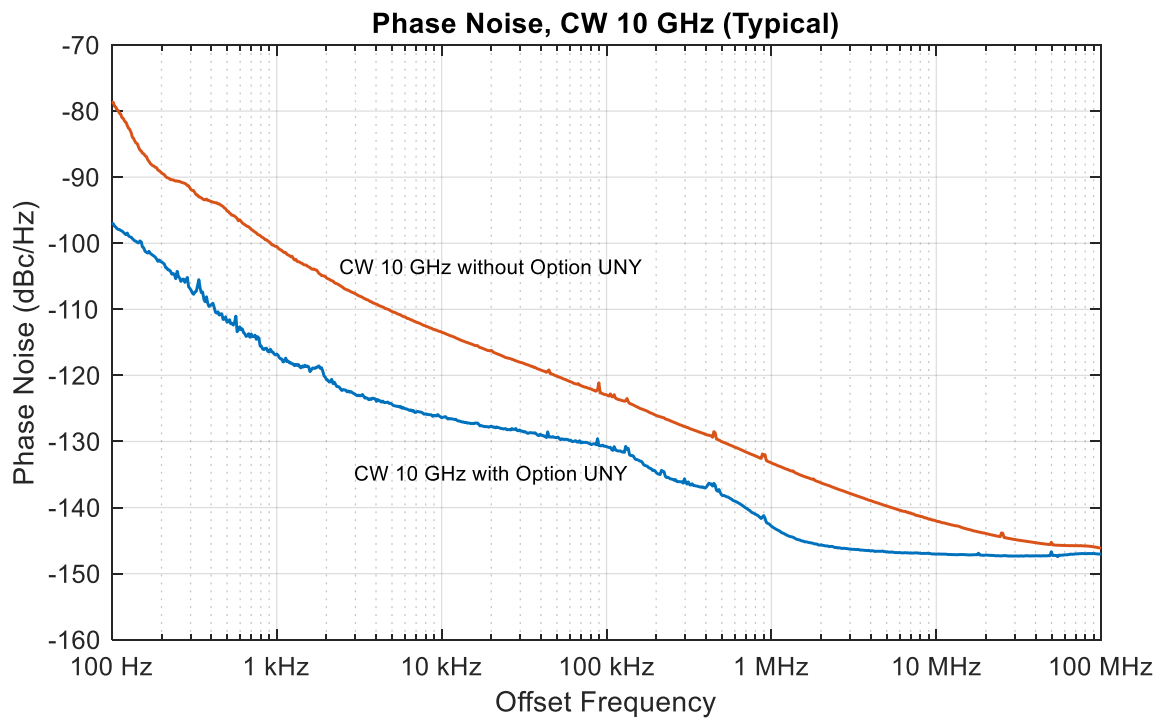

Test Port Input

Table 16a. Test Port Noise Floor (dBm) @ 10 Hz IFBW, All Options

Total average (rms) noise power calculated as the mean value of a linear magnitude trace expressed in dBm. May typically be degraded at particular frequencies below 500 MHz due to spurious receiver residuals.

Description	Specification		Typical	
	N5224B	N5225B	N5224B	N5225B
10 MHz to 50 MHz ¹	-70	-70	-75	-75
50 MHz to 100 MHz ¹	-85	-85	-91	-91
100 MHz to 250 MHz	-95	-95	-100	-100
250 MHz to 500 MHz	-102	-102	-107	-107
500 MHz to 1 GHz	-106	-106	-112	-112
1 GHz to 10 GHz	-114	-114	-118	-118
10 GHz to 26.5 GHz	-114	-114	-120	-120
26.5 GHz to 35 GHz	-110	-110	-116	-116
35 GHz to 40 GHz	-108	-108	-116	-116
40 GHz to 43.5 GHz	-108	-108	-114	-114
43.5 GHz to 50 GHz	--	-109	--	-116

¹ With an LFE option installed and LFE disabled, applied to frequencies <= 100 MHz. Above 100 MHz, performance is the same for both LFE enabled or disabled. For LFE enabled performance <= 100 MHz, see Table 16b.

Table 16b. Test Port Noise Floor (dBm) @ 10 Hz IFBW, All LFE Options (LFE Enabled)

Description	Specification	Typical
500 Hz to 900 Hz	--	-93
900 Hz to 1 kHz	-90	-96
1 kHz to 10 kHz	-91	-96
10 kHz to 100 kHz	-101	-105
100 kHz to 1 MHz	-107	-110
1 MHz to 5 MHz	-108	-112
5 MHz to 10 MHz	-102	-106
10 MHz to 50 MHz	-102	-106
50 MHz to 100 MHz ¹	-102	-106

¹ May be degraded at 100 MHz due to spurious receiver residuals.

Table 17. Direct Receiver Access Input Noise Floor (dBm), Option 201, 205, 217, 219, 220, 401, 405, 417, 419, 420

Total average (rms) noise power calculated as the mean value of a linear magnitude trace expressed in dBm. May typically be degraded at particular frequencies below 500 MHz due to spurious receiver residuals.

Description	Specification		Typical	
	N5224B	N5225B	N5224B	N5225B
10 MHz to 50 MHz	-105	-105	-119	-119
50 MHz to 100 MHz	-105	-105	-121	-121
100 MHz to 250 MHz	-107	-107	-121	-121
250 MHz to 500 MHz	-114	-114	-128	-128
500 MHz to 1 GHz	-118	-118	-133	-133
1 GHz to 10 GHz	-126	-126	-133	-133
10 GHz to 20 GHz	-126	-126	-135	-135
20 GHz to 26.5 GHz	-124	-124	-134	-134
26.5 GHz to 35 GHz	-120	-120	-130	-130
35 GHz to 40 GHz	-118	-118	-130	-130
40 GHz to 43.5 GHz	-116	-116	-125	-125
43.5 GHz to 50 GHz	--	-117	--	-127

Table 18a. 0.1 dB Receiver Compression at Test Port (dBm), Option 201, 217, 219, 401, 417, 419, and All LFE Options - Typical

Description	N5224B	N5225B
10 MHz to 100 MHz ¹	15	15
100 MHz to 40 GHz	12	12
40 GHz to 43.5 GHz	10	10
43.5 GHz to 50 GHz	--	10

¹ With an LFE option installed and LFE disabled, applied to frequencies <= 100 MHz. Above 100 MHz, performance is the same for both LFE enabled or disabled. For LFE enabled performance <= 100 MHz, see Table 18b.

Table 18b. 0.1 dB Compression, All Ports, All LFE Options (LFE Enabled) - Typical

Description	Test Port Power (dBm)
500 Hz to 900 Hz	13
900 Hz to 1 kHz	13
1 kHz to 10 kHz	13
10 kHz to 100 kHz	13
100 kHz to 1 MHz	13
1 MHz to 5 MHz	11
5 MHz to 10 MHz	13
10 MHz to 50 MHz	14
50 MHz to 100 MHz	14

Table 18c. Receiver Compression at Test Power - Specification

Description	Test Port Power (dBm)				Receiver Compression	
	Option 200, 400	Option 201, 205, 401, 405	Option 217, 417	Option 219, 220, 419, 420	Magnitude (dB)	Phase (degrees)
10 MHz to 500 MHz ¹	--	--	--	--	--	--
500 MHz to 10 GHz	11	13	11	11	0.15	1.5
10 GHz to 16 GHz	10	13	11	11	0.15	1.5
16 GHz to 20 GHz	10	13	10	10	0.15	1.5
20 GHz to 26.5 GHz	9	13	10	10	0.18	1.5
26.5 GHz to 30 GHz	9	12	9	9	0.18	1.5
30 GHz to 32 GHz	9	11	8	8	0.18	1.5
32 GHz to 35 GHz	9	10	9	9	0.18	1.5
35 GHz to 43.5 GHz	5	9	8	8	0.18	1.5
43.5 GHz to 47 GHz	1	8	8	8	0.2	1.5
47 GHz to 50 GHz	-5	8	8	8	0.2	1.5

¹ Test port receiver compression at specified input levels below 500 MHz due to coupler roll off in this frequency range.

Table 18d. Compression, All Ports, All LFE Options (LFE Enabled) - Specification

Description	Test Port Power (dBm)	Receiver Compression	
		Magnitude (dB)	Phase (degrees)
500 Hz to 900 Hz	--	--	--
900 Hz to 1 kHz	10	0.2	1
1 kHz to 10 kHz	12	0.2	1
10 kHz to 100 kHz	12	0.2	1
100 kHz to 1 MHz	12	0.2	1
1 MHz to 5 MHz	10	0.2	1
5 MHz to 10 MHz	9	0.2	1
10 MHz to 50 MHz	8	0.2	1
50 MHz to 100 MHz	8	0.2	1

Table 19a. Trace Noise¹ Magnitude (dB rms)

Description	Specification	Typical		
		1 kHz IFBW	100 kHz IFBW	600 kHz IFBW
10 MHz to 50 MHz ²	0.200	0.071	0.667	1.612
50 MHz to 100 MHz ²	0.040	0.009	0.088	0.209
100 MHz to 500 MHz	0.020	0.004	0.040	0.098
500 MHz to 1 GHz	0.003	0.001	0.009	0.022
1 GHz to 26.5 GHz	0.003	0.001	0.006	0.015
26.5 GHz to 43.5 GHz	0.003	0.001	0.009	0.021
43.5 GHz to 50 GHz	0.004	0.002	0.007	0.018

¹ Ratioed measurement, nominal power at test port.

² With an LFE option installed and LFE disabled, applied to frequencies <= 100 MHz. Above 100 MHz, performance is the same for both LFE enabled or disabled.

Table 19b. Trace Noise¹ Magnitude (dB rms), All Ports, All LFE Options (LFE Enabled)

Description	Specification		Typical			
	100 Hz IFBW	1 kHz IFBW	100 Hz IFBW	1 kHz IFBW	100 kHz IFBW	600 kHz IFBW
500 Hz to 900 Hz	--	--	0.002	--	--	--
900 Hz to 4 kHz	0.004	--	0.001	--	--	--
4 kHz to 300 kHz	--	0.004	--	0.002	--	--
300 kHz to 2 MHz	--	0.004	--	0.001	0.01	--
2 MHz to 100 MHz	--	0.004	--	0.001	0.01	0.025

¹ Ratioed measurement, -5 dBm at test port.

Table 20a. Trace Noise¹ Phase (deg rms)

Description	Specification	Typical		
	1 kHz IFBW	1 kHz IFBW	100 kHz IFBW	600 kHz IFBW
10 MHz to 50 MHz ²	1.000	0.485	4.681	11.310
50 MHz to 100 MHz ²	1.000	0.062	0.614	1.456
100 MHz to 500 MHz	0.500	0.029	0.276	0.680
500 MHz to 1 GHz	0.020	0.006	0.061	0.149
1 GHz to 26.5 GHz	0.020	0.008	0.040	0.100
26.5 GHz to 43.5 GHz	0.030	0.014	0.067	0.159
43.5 GHz to 50 GHz	0.030	0.015	0.061	0.142

¹ Ratioed measurement, nominal power at test port.

² With an LFE option installed and LFE disabled, applied to frequencies <= 100 MHz. Above 100 MHz, performance is the same for both LFE enabled or disabled.

Table 20b. Trace Noise¹ Phase (deg rms), All Ports, All LFE Options (LFE Enabled)

Description	Specification		Typical			
	100 Hz IFBW	1 kHz IFBW	100 Hz IFBW	1 kHz IFBW	100 kHz IFBW	600 kHz IFBW
500 Hz to 900 Hz	--	--	0.012	--	--	--
900 Hz to 4 kHz	0.03	--	0.008	--	--	--
4 kHz to 300 kHz	--	0.03	--	0.014	--	--
300 kHz to 2 MHz	--	0.03	--	0.007	0.064	--
2 MHz to 100 MHz	--	0.03	--	0.007	0.068	0.166

¹ Ratioed measurement, -5 dBm at test port.

Table 21. Reference Level Magnitude, All Models and Options - Specification

Description	Magnitude (dB)	Phase (degrees)
Range	±500	±500
Resolution	0.001	0.01

Table 22a. Stability, All Options - Typical

Description	Magnitude (dB/°C)	Phase (°/°C)
10 MHz to 50 MHz ¹	0.020	0.200
50 MHz to 3.2 GHz ¹	0.010	0.100
3.2 GHz to 10 GHz	0.010	0.200
10 GHz to 16 GHz	0.010	0.250
16 GHz to 20 GHz	0.015	0.300
20 GHz to 26.5 GHz	0.015	0.400
26.5 GHz to 35 GHz	0.020	0.600
35 GHz to 43.5 GHz	0.020	0.650
43.5 GHz to 47 GHz	0.025	0.700
47 GHz to 50 GHz	0.027	0.750

¹ With an LFE option installed and LFE disabled, applied to frequencies <= 100 MHz. Above 100 MHz, performance is the same for both LFE enabled or disabled. For LFE enabled performance <= 100 MHz, see Table 22b.

Table 22b. Stability¹, All LFE Options (LFE Enabled)- Typical

Description	Magnitude (dB/°C)	Phase (°/°C)
500 Hz to 900 Hz	0.010	0.2
900 Hz to 1 kHz	0.010	0.2
1 kHz to 10 kHz	0.010	0.2
10 kHz to 100 kHz	0.010	0.2
100 kHz to 1 MHz	0.010	0.1
1 MHz to 5 MHz	0.010	0.1
5 MHz to 10 MHz	0.010	0.1
10 MHz to 50 MHz	0.010	0.1
50 MHz to 100 MHz	0.020	0.1

¹ Stability is defined as a ratio measurement made at the test port.

Table 23. Damage Input Level, All ports

Description	Option 200, 201, 219, 400, 401, 419	Option 217, 417	All LFE Options
RF, DC	27 dBm, 40 V	27 dBm, 7 V	20 dBm, 50 V

Dynamic Accuracy

Dynamic accuracy is verified with the following measurements:

Compression over frequency

IF linearity at a single frequency of 1.998765GHz using a reference level of -20 dBm for an input power range of 0 to -60 dBm. For values below -60 dBm, refer to [VNA Receiver Dynamic Accuracy Specifications and Uncertainties](#).

Table 24. N5224B and N5225B Dynamic Accuracy

N5224B/25B Dynamic Accuracy, 900 Hz, All LFE Options (LFE Enabled) - Specification

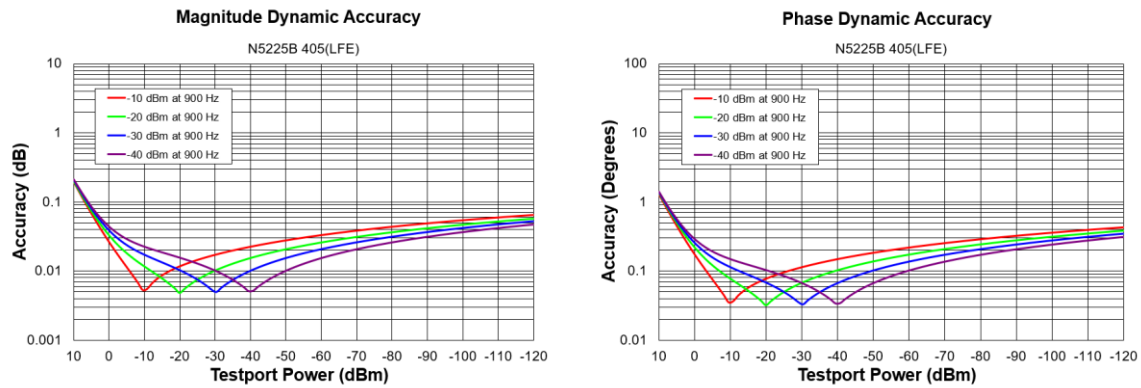

N5224B/25B Dynamic Accuracy, 10 MHz, All LFE Options (LFE Enabled) - Specification

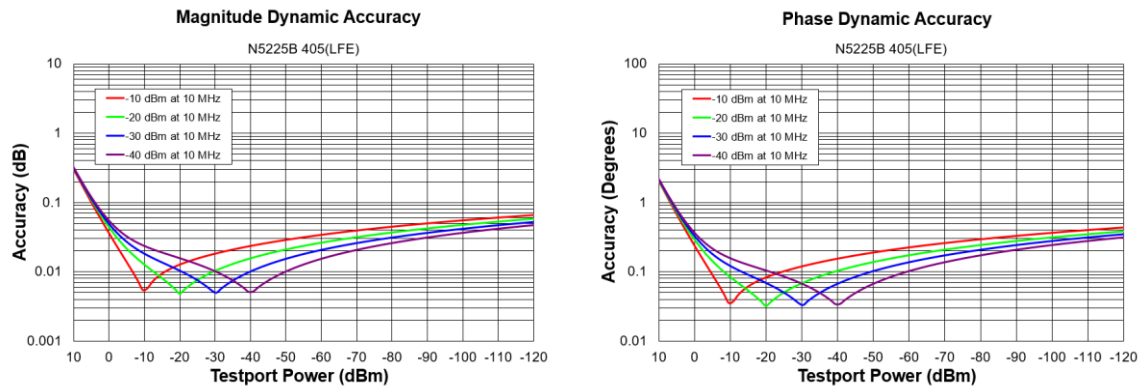

N5224B/25B Dynamic Accuracy, 100 MHz, All LFE Options (LFE Enabled) - Specification

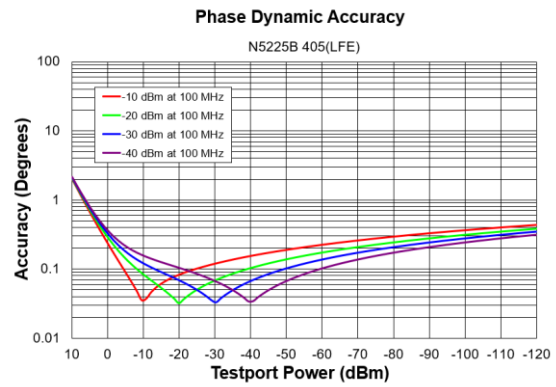
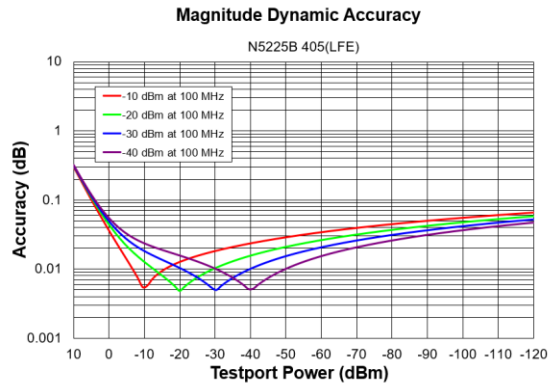

N5224B/25B Dynamic Accuracy, 50 MHz - Specification

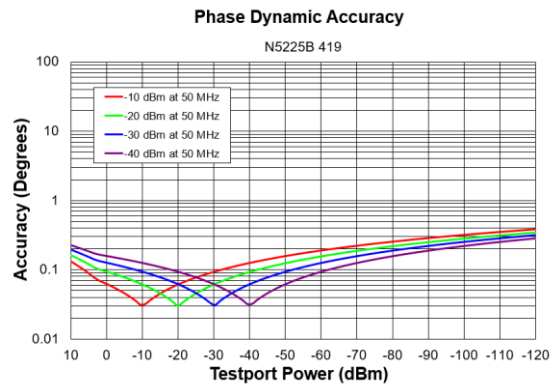
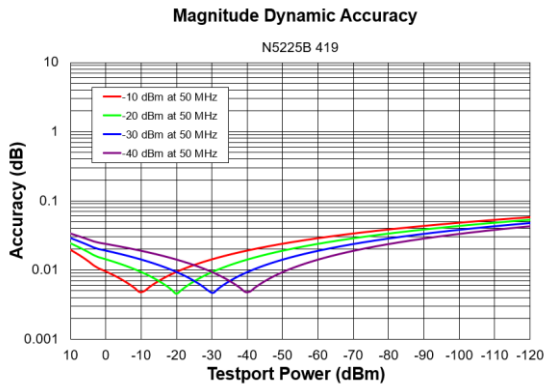

N5224B/25B Dynamic Accuracy, 500 MHz - Specification

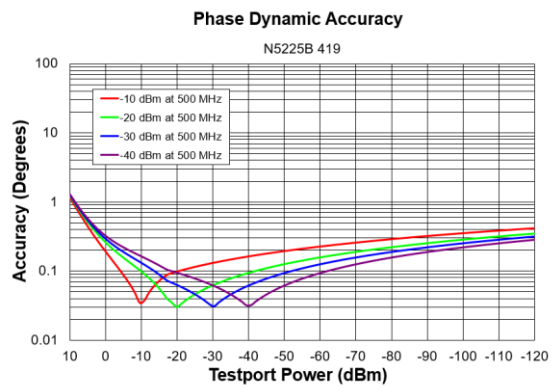
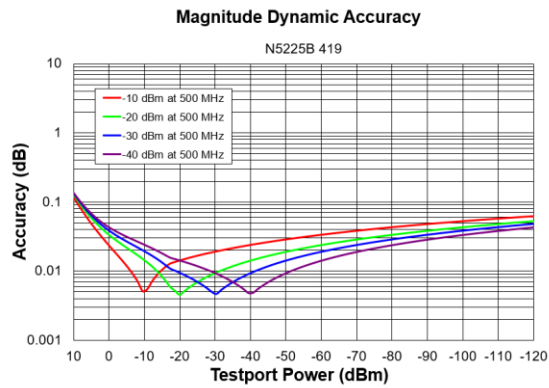

N5224B/25B Dynamic Accuracy, 1 GHz - Specification

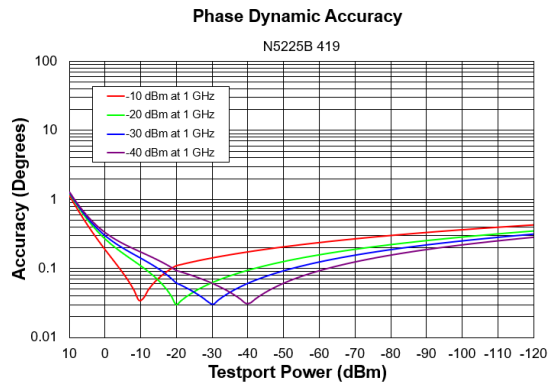
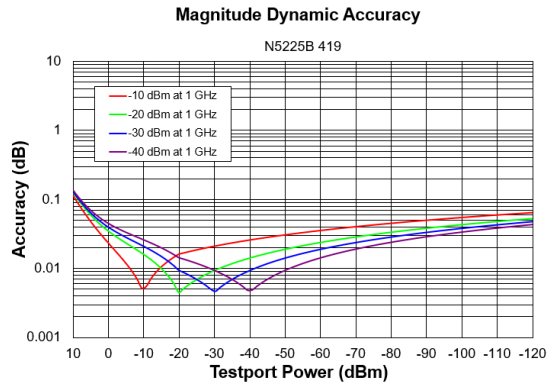

N5224B/25B Dynamic Accuracy, 2 GHz - Specification

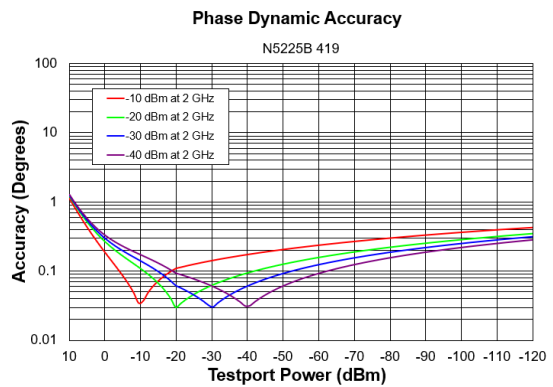
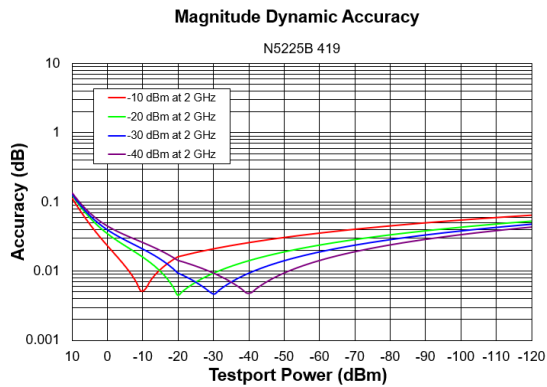

N5224B/25B Dynamic Accuracy, 20 GHz - Specification

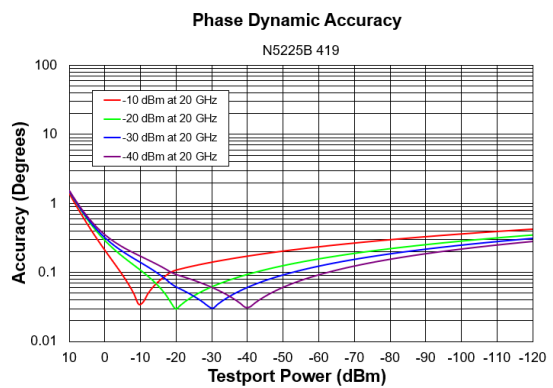
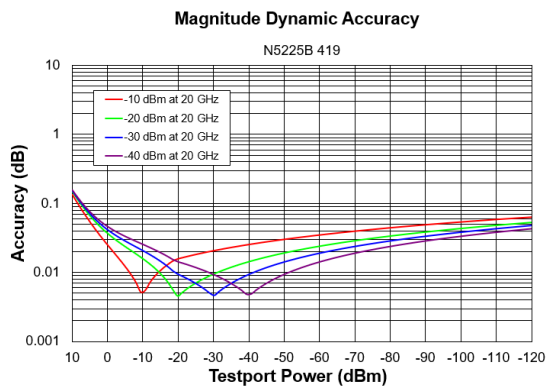

N5224B/25B Dynamic Accuracy, 26.5 GHz - Specification

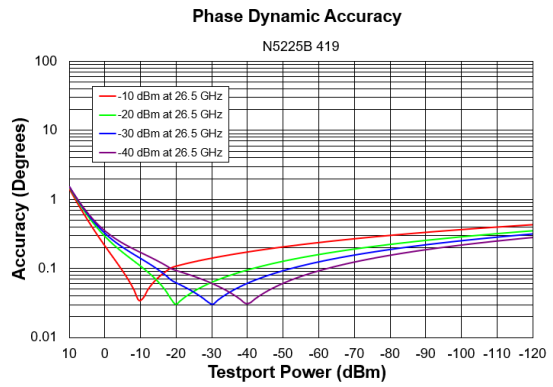
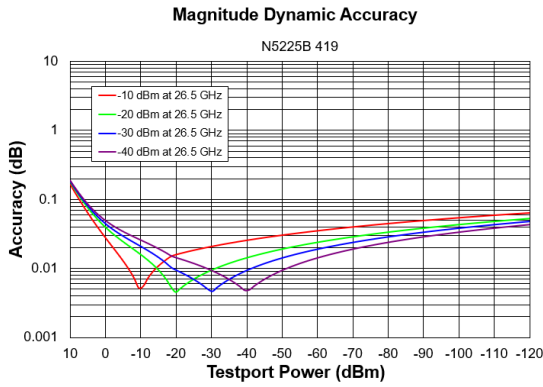

N5224B/25B Dynamic Accuracy, 35 GHz - Specification

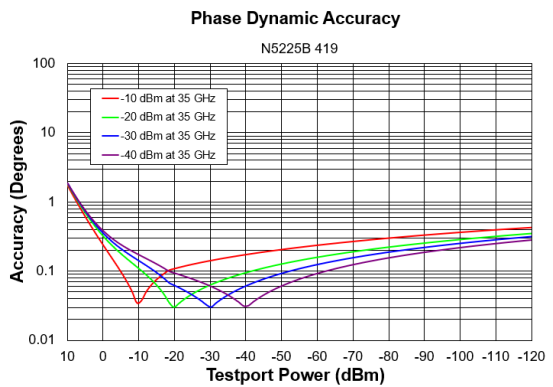
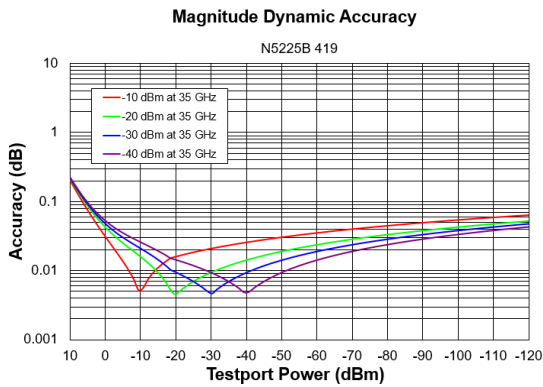

N5224B/25B Dynamic Accuracy, 40 GHz - Specification

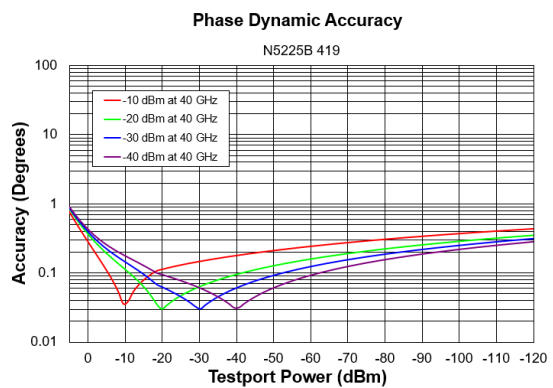
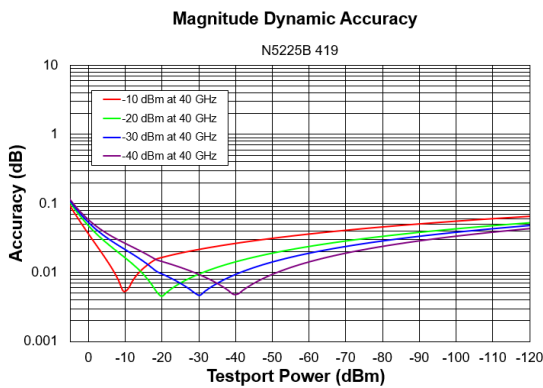

N5224B/25B Dynamic Accuracy, 50 GHz - Specification

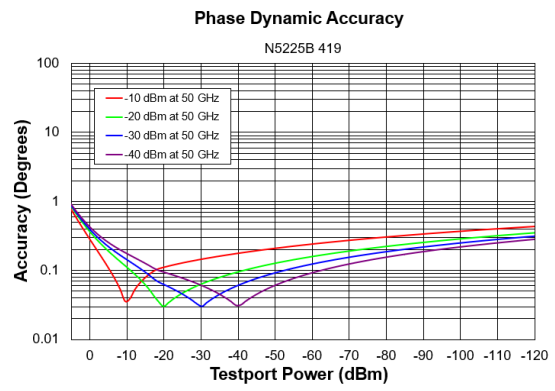
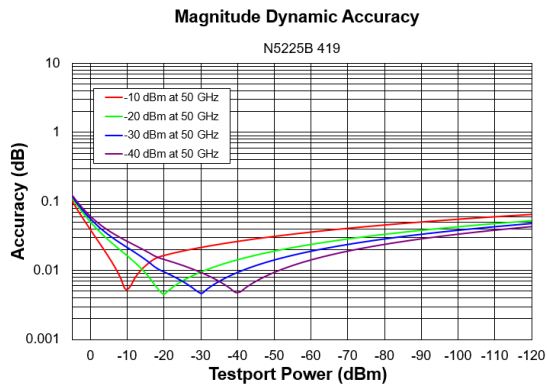

Table 25. Group Delay - Typical

Group delay is computed by measuring the phase change within a specified frequency step (determined by the frequency span and the number of points per sweep). In general, the following formula can be used to determine the accuracy, in seconds, of specific group delay measurement:

$$\pm \text{Phase Accuracy (deg)} / [360 \times \text{Aperture (Hz)}]$$

Depending on the aperture and device length, the phase accuracy used is either incremental phase accuracy or worst-case phase accuracy

Description	Typical Performance
Aperture (selectable)	(frequency span)/(number of points -1)
Maximum Aperture	20% of frequency span
Range	0.5 x (1/minimum aperture)
Maximum Delay	Limited to measuring no more than 180° of phase change within the minimum aperture.)

The following graphs show characteristic group delay accuracy with full 2-port calibration and a 10 Hz IF bandwidth. Insertion loss is assumed to be < 2 dB and electrical length to be ten meters.

For any S_{ij} Group Delay measurement, $S_{ii} = 0$, $S_{ij} = 1$, $S_{ji} = 0$, $S_{kl} = 0$ for all $kl \neq ij$

Group Delay Accuracy (Typical)

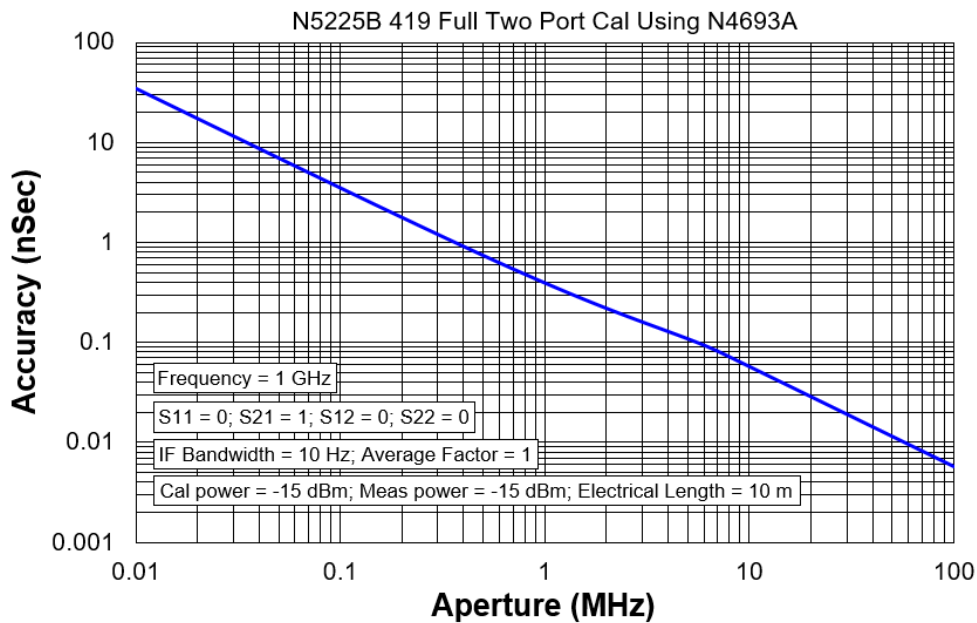

General Information

- Miscellaneous Information
- Front Panel
- Rear Panel
- Environment and Dimensions

Table 26. Miscellaneous Information

Description	Supplemental Information
System IF Bandwidth Range	1 Hz to 15 MHz, nominal
CPU	For the latest information on CPUs and associated hard drives, visit: http://na.support.keysight.com/pna/hdnumbers.html
LXI	Class C

Table 27. Front Panel Information, All Options

Description	Typical Performance
RF Connectors	
Type	2.4 mm (male), 50 ohm, (nominal)
Center Pin Recession	0.002 in. (characteristic)
USB 2.0 Ports - Master (4 ports)	
Standard	Compatible with USB 2.0
Connector	USB Type-A female
Display	
Size	31 cm (12.1 in) diagonal color active matrix LCD; 1280 (horizontal) X 800 (vertical) resolution
Refresh Rate	Vertical 60 Hz; Horizontal 49.31 kHz
Pixels	Any of the following would cause a display to be considered faulty: <ul style="list-style-type: none"> • A complete row or column consists of “stuck” or “dark” pixels. • More than six “stuck on” pixels (but not more than three green) or more than 0.002% of the total pixels are within the LCD specifications. • More than twelve “dark” pixels (but no more than seven of the same color) or more than 0.004% of the total pixels are within the LCD specifications. • Two or more consecutive “stuck on” pixels or three or more consecutive “dark” pixel (but no more than one set of two consecutive dark pixels). • “Stuck on” pixels or more than two “dark” pixels less than 6.5 mm apart (excluding consecutive pixels).

Table 27. (Continued) Front Panel Information, All Options

Description	Typical Performance
Display Range	
Magnitude	±2500 dB (at 500 dB/div), max
Phase	±2500° (at 500 degrees/div), max
Polar	10 pUnits, min 10,000 Units, max
Display Resolution	
Magnitude	0.001 dB/div, min
Phase	0.01°/div, min
Marker Resolution	
Magnitude	0.001 dB, min
Phase	0.01°, min
Polar	10 pUnit, min

Table 28. Rear Panel Information, All Options

Description	Typical Performance
10 MHz Reference In	
Connector	BNC, female
Input Frequency	10 MHz ±1 ppm, 100 MHz ±1 ppm
Input Level	10 MHz: -15 dBm to +20 dBm 100 MHz: -10 dBm to +20 dBm
Input Impedance	50 Ω, nom.
10 MHz Reference Out	
Connector	BNC, female
Output Frequency	10 MHz ±0.7 ppm, 100 MHz ±0.7 ppm
Signal Type	Sine Wave
Output Level	+10 dBm ± 4 dB into 50 Ω
Output Impedance	50 Ω, nominal
Harmonics	<-40 dBc, typical

Table 28. (Continued) Rear Panel Information, All Options

Description	Typical Performance
External IF Inputs	
Function	Allows use of external IF signals from remote mixers, bypassing the PNA's first converters
Connectors	SMA (female); A, B, C, D, R (4-port); A, B, R1, R2 (2-port)
Input Frequency	
Normal IF path	RF < 53 MHz: IF = 826.446 KHz RF >= 53 MHz: IF = 7.438 MHz
Narrowband IF path	IF = 10.70 MHz
Input Impedance	50 Ω
RF Damage Level	+23 dBm
DC Damage Level	5.5 VDC
0.1 dB Compression Point	
Normal IF path	-9.0 dBm at 7.438 MHz
Narrowband IF path	-17 dBm at 10.70 MHz
Pulse Inputs (IF Gates)	
Function	Internal receiver gates used for point-in-pulse and pulse-profile measurements
Connectors	15-pin mini D-sub
Input Impedance	1 K Ohm
Minimum Pulse Width, Source Modulators	33 ns
Minimum Pulse Width, Receiver Gates	20 ns
DC Damage Level	5.5 VDC
Drive Voltage	0 V (off), +3.3 V (on), nominal
RF Pulse Modulator Input (Source Modulator)	
On/Off Ratio	
10 MHz to 3.2 GHz	-64
3.2 GHz to 50 GHz	-80
Pulse Period	
Minimum	33 ns
Maximum	70 s

Table 28. (Continued) Rear Panel Information, All Options

Description	Typical Performance	
Pulse Outputs		
Voltage (TTL)	High: 3.3V to 3.5V Low: <1V	
Impedance	50 Ohm	
External Test Set Driver		
Function	Used for driving remote mixers	
Connections	3.5 mm (female)	
RF Output Frequency Range	3.2 GHz to 19 GHz	
LO Output Frequency Range	0.01 GHz to 26.5 GHz	
Rear Panel LO Power		
	Upper Limit, Typical (dBm)	Lower Limit, Typical (dBm)
10 MHz to 1.7 GHz	--	--
1.7 GHz to 6.78 GHz	5	-3
6.78 GHz to 15.4 GHz	0	-6
15.4 GHz to 26.5 GHz	4	-5
Rear Panel RF Power		
	Upper Limit, Typical (dBm)	Lower Limit, Typical (dBm)
3.2 GHz to 19 GHz	-3	-8
Devices Supported		
	Resolutions	
Flat Panel (TFT)	1024 X 768, 800 X 600, 640 X 480	
Flat Panel (DSTN)	800 X 600, 640 X 480	
CRT Monitor	1280 X 1024, 1024 X 768, 800 X 600, 640 X 480	
Simultaneous operation of the internal and external displays is allowed, but with 640 X 480 resolution only. If you change resolution, you can only view the external display (internal display will "white out").		

Table 28. (Continued) Rear Panel Information, All Options

Description	Typical Performance
Bias Tee Inputs	
Connectors	BNC(f) for ports 1, 2, 3 and 4
Fuse	500 mA, bi-pin style
Maximum Bias Current	±200 mA with no degradation of RF specifications
Maximum Bias Voltage	±40 VDC
Trigger Inputs/Outputs	BNC(f), TTL/CMOS compatible
Test Set IO	25-pin D-Sub connector, available for external test set control
Power IO	9-pin D-Sub, female; analog and digital IO
Handler IO	36-pin parallel I/O port; all input/output signals are default set to negative logic; can be reset to positive logic via GPIB command
Pulse I/O	15-pin D connector provides access to Pulse Modulators and Generators
GPIB	Two ports - dedicated controller and dedicated talker/listener. 24-pin D-sub (Type D-24), female; compatible with IEEE-488
PCIe	Cabled PCIe x4 connector is a 4-lane slot (not currently used)
USB Ports	Two SuperSpeed USB ports (900 mA each), one USB port below LAN connector, and one USB device port. There are also four USB ports (500 mA each) on the front panel. The total current limit for all rear panel USB ports is 2.3 amps. The total current limit for all front panel USB ports is 2 amps.
LAN	10/100/1000 BaseT Ethernet, 8-pin configuration; auto selects between the data rates
VGA Video Output	15-pin mini D-Sub; Drives VGA compatible monitors
Mini DisplayPort	Miniature DisplayPort connector for connection to external displays
Line Power	
Frequency, Voltage	50/60/400 Hz for 100 to 120 VAC 50/60 Hz for 220 to 240 VAC
	Power supply is auto switching
Max	575 watts

Table 29. Analyzer Dimensions and Weight

All models are shipped with handles.

Cabinet Dimensions	Metric (mm)	Imperial (inches)
Height		
Without bottom feet: ¹ EIA RU = 6	266.1	10.5
With bottom feet	279.1	11.0
Width		
Without handles or rack-mount flanges	425.6	16.8
With handles, without rack-mount flanges	458.7	18.1
With handles and rack-mount flanges	482.9	19.0
Depth		
Without front and rear panel hardware	582.3	22.9
With front and rear panel hardware, handles	649.6	25.6

¹ Electronics Industry Association rack units. 1 RU = 1.75 in.

See detailed PNA dimension drawings at: <http://na.support.keysight.com/pna/PNADimensions.pdf>

Weight (nominal)	Net	Shipping
All 2-port models	39.1 kg (86 lb)	55 kg (121 lb)
All 4-port models	41.8 kg (92 lb)	58.2 kg (128 lb)

Regulatory and Environmental Information

For Regulatory and Environmental information, refer to the PNA Series Installation and Quick Start Guide, located online at <http://literature.cdn.keysight.com/litweb/pdf/E8356-90001.pdf>.

Measurement Throughput Summary

- Typical Cycle Time for Measurement Completion
- Cycle Time vs. IF Bandwidth
- Cycle Time vs. Number of Points
- Data Transfer Time

Cycle time Includes sweep time, retrace time and band-crossing time. Analyzer display turned off with DISPLAY:ENABLE OFF. Add 21 ms for display on. Data for one trace (S₁₁) measurement. LF Auto BW off.

Table 30a. Typical Cycle Time (ms) for Measurement Completion, All Models and Options

Sweep Range	IF Bandwidth		Number of Points				
			201	401	1601	16001	32001
9 GHz to 10 GHz	600 kHz	Uncorrected	5.5	5.5	9.4	59.4	116
		2-Port cal	18.0	19.0	26	132	250
	10 kHz	Uncorrected	28.1	53.1	203	1995	3988
		2-Port cal	65.6	116	414	4003	7991
	1 kHz	Uncorrected	227	445	1744	17028	33828
		2-Port cal	461	898	3150	30669	67680
10 GHz to 20 GHz	600 kHz	Uncorrected	17.2	18.8	23.4	68.8	120
		2-Port cal	43.8	46.9	56.3	155	259
	10 kHz	Uncorrected	67.2	127	259	2003	3995
		2-Port cal	144	261	523	4016	8003
	1 kHz	Uncorrected	233	456	1781	17375	34516
		2-Port cal	475	922	3570	34758	69055

Table 30b. N5224B Typical Cycle Time (ms) for Full-Span Measurement Completion

10 MHz to 43.5 GHz		Number of Points				
IF Bandwidth		201	401	1601	16001	32001
600 kHz	Uncorrected	48.4	59.4	78.1	156	206
	2-Port cal	105	127	164	317	428
10 kHz	Uncorrected	84.4	147	505	2172	4188
	2-Port cal	175	302	1016	4350	8384
1 kHz	Uncorrected	250	477	1822	17617	34984
	2-Port cal	505	959	3647	35250	69992

Table 30c. N5225B Typical Cycle Time (ms) for Full-Span Measurement Completion

10 MHz to 50 GHz		Number of Points				
IF Bandwidth		201	401	1601	16001	32001
600 kHz	Uncorrected	55.5	67.2	85.9	166	223
	2-Port cal	116	141	175	334	443
10 kHz	Uncorrected	87.5	151	512	2182	4203
	2-Port cal	180	307	1027	4364	8422
1 kHz	Uncorrected	252	480	1825	17648	35031
	2-Port cal	509	966	3656	35305	70086

Table 31. Cycle Time vs. IF Bandwidth - Typical

Applies to the Preset condition (201 points, correction off) except for the following changes:

- CF = 10 GHz
- Span = 100 MHz
- Display off (add 21 ms for display on)

Cycle time includes sweep and retrace time.

Description		N5224B/25B	
IF Bandwidth (Hz)	Cycle Time (ms)	Trace Noise Magnitude (dB rms)	
600,000	5.5	0.005	
100,000	5.5	0.0024	
30,000	8.6	0.0017	
10,000	28.9	0.0014	
3,000	70.3	0.001	
1,000	223	0.0008	
300	642	0.0006	
100	1823	0.0005	
30	5977	0.0005	
10	17836	0.0005	
3	59289	0.0004	

Table 32. Cycle Time vs. Number of Points - Typical

Applies to the Preset condition (correction off) except for the following changes:

- CF = 10 GHz
- Span = 100 MHz
- Display off (add 21 ms for display on)

Cycle time includes sweep and retrace time.

Description	IF Bandwidth (Hz)			
	1,000	10,000	30,000	600,000
3	6.3	4.7	4.7	4.7
11	15.6	5.5	4.7	4.7
51	59.4	10.2	4.7	4.7
101	113	15.6	6.3	4.7
201	222	28.1	8.6	4.7
401	436	53.1	14.1	5.5
801	859	103	23.4	6.3
1,601	1706	203	43.8	9.4
6,401	6719	800	166	26.6
16,001	16656	1995	408	60.2
32,001	33086	3988	812	116

Table 33. Data Transfer Time (ms) - Typical

Measured with the analyzer display off.

Values will increase slightly if the analyzer display is on.

Description	Number of Points				
	201	401	1601	16,001	32,001
SCPI over GPIB (Program executed on external PC ²)					
32-bit floating point	4.6	9.3	38	352	720
64-bit floating point	9.4	18.8	73.4	730	1455
ASCII	36.7	72.5	288	2882	5762
SCPI over SICL/LAN or TCP/IP Socket¹ (Program executed in the analyzer)					
32-bit floating point	<1	<1	<1	1.2	2.4
64-bit floating point	<1	<1	<1	2.3	4.6
ASCII	2.1	4	15	148	295
COM¹ (Program executed in the analyzer)					
32-bit floating point	<1	<1	<1	<1	<1
Variant type	<1	<1	1.4	12.4	25.5
DCOM over LAN¹ (Program executed on external PC)					
32-bit floating point	<1	<1	<1	2.3	4.4
Variant type	<1	1.6	5.3	52	105.5

¹ Values are for real and imaginary pairs, with the analyzer display off, using Gigabit Ethernet.

NOTE Specifications for Recall & Sweep Speed are not provided for the N522xB analyzers.

Specifications: Front-Panel Jumpers

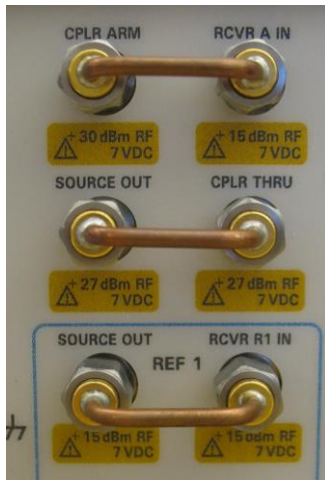

The following options have front-panel jumpers for each port:
201, 205, 217, 219, 220, 401, 405, 417, 419, 420

- Measurement Receiver Inputs
- Reference Receiver Inputs and Reference Source Outputs
- Source Outputs
- Coupler Inputs
- Damage Level

Table 34. Measurement Receiver Inputs (dBm) - Typical
(RCVR A, B, C, D IN) @ 0.1dB Typical Compression

Description	All Options
10 MHz to 500 MHz	-3
500 MHz to 1 GHz	-3
1 GHz to 2 GHz	-2
2 GHz to 3.2 GHz	-1
3.2 GHz to 10 GHz	-2
10 GHz to 26.5 GHz	-4
26.5 GHz to 35 GHz	-5
35 GHz to 50 GHz	-6

Table 35. Reference Receiver Inputs and Reference Source Outputs (dBm) - Typical

(RCVR R1 IN, REF 1 SOURCE OUT) @ Max Specified Output Power

Description	Option 201, 401	Option 217, 219, 417, 419
10 MHz to 50 MHz	-30	-30
50 MHz to 100 MHz	-16	-16
100 MHz to 500 MHz	-16	-16
500 MHz to 1 GHz	-8	-8
1 GHz to 10 GHz	-7	-8
10 GHz to 16 GHz	-8	-8
16 GHz to 26.5 GHz	-8	-9
26.5 GHz to 30 GHz	-9	-10
30 GHz to 32 GHz	-10	-11
32 GHz to 35 GHz	-9	-11
35 GHz to 43.5 GHz	-11	-12
43.5 GHz to 47 GHz	-15	-16
47GHz to 50 GHz	-24	-24

Table 36. Reference Receiver Inputs and Reference Receiver Outputs (dBm) - Typical

(RCVR R2 IN, RCVR R3 IN, RCVR R4 IN, REF 2 SOURCE OUT, REF 3 SOURCE OUT, REF 4 SOURCE OUT) @ Max Specified Output Power

Description	Option 201, 401		Option 401		Option 217, 219, 417, 419	
	RCVR R2 IN, RCVR R4 IN, REF 2 SOURCE OUT, REF 4 SOURCE OUT	RCVR R3 IN, REF 3 SOURCE OUT	RCVR R2 IN, RCVR R4 IN, REF 2 SOURCE OUT, REF 4 SOURCE OUT	RCVR R3 IN, REF 3 SOURCE OUT		
10 MHz to 50 MHz	-25	-25	-25	-25		
50 MHz to 100 MHz	-20	-20	-20	-20		
100 MHz to 500 MHz	-6	-6	-10	-10		
500 MHz to 3.2 GHz	-2	-2	-3	-3		
3.2 GHz to 10 GHz	-1	-1	-2	-2		
10 GHz to 30 GHz	-1	-1	-1	-1		
30 GHz to 32 GHz	-1	-1	-3	-3		
32 GHz to 35 GHz	0	0	-1	-1		
35 GHz to 43.5 GHz	-2	-2	-4	-4		
43.5 GHz to 47 GHz	-5	-5	-7	-7		
47 GHz to 50 GHz	-14	-14	-15	-15		

Table 37. Source Outputs (dBm) - Typical

(PORT 1 SOURCE OUT, PORT 2 SOURCE OUT, PORT 3 SOURCE OUT, PORT 4 SOURCE OUT) @ Max Specified Output Power

Description	Option 201, 401	Option 201, 401	Option 217, 219, 417, 419	
	PORT 1 SOURCE OUT, PORT 3 SOURCE OUT	PORT 2 SOURCE OUT, PORT 4 SOURCE OUT	PORT 1 SOURCE OUT, PORT 3 SOURCE OUT	PORT 2 SOURCE OUT, PORT 4 SOURCE OUT
10 MHz to 50 MHz	12	12	10	10
50 MHz to 1 GHz	13	13	11	11
1 GHz to 10 GHz	14	14	12	12
10 GHz to 16 GHz	14	14	13	13
16 GHz to 26.5 GHz	15	15	13	13
26.5 GHz to 30 GHz	14	14	12	12
30 GHz to 32 GHz	13	13	10	10
32 GHz to 35 GHz	14	14	12	12
35 GHz to 43.5 GHz	11	11	8	8
43.5 GHz to 47 GHz	8	8	4	4
47 GHz to 50 GHz	-2	-2	-5	-5

Table 38. Coupler Inputs (dB) - Typical

(PORT 1, 2, 3, 4 CPLR THRU) Insertion Loss of Coupler Thru

Description	Option 201, 401	Option 217, 219, 417, 419
10 MHz to 50 MHz	0	0
50 MHz to 500 MHz	-0.25	-0.25
500 MHz to 1 GHz	-0.50	-0.50
1 GHz to 2 GHz	-0.50	-1
2 GHz to 3.2 GHz	-0.75	-1
3.2 GHz to 10 GHz	-1	-1.5
10 GHz to 16 GHz	-1.2	-2
16 GHz to 26.5 GHz	-1.8	-2.5
26.5 GHz to 35 GHz	-2	-3
35 GHz to 43.5 GHz	-2.5	-4
43.5 GHz to 47 GHz	-3	-5
47 GHz to 50 GHz	-3	-6

Table 39. Damage Level - Typical

Description	RF (dBm)	DC (v)
RCVR A, B, C, D IN	15	7
RCVR R1, R2, R3, R4 IN	15	7
REF 1 SOURCE OUT	15	7
REF 2, 3, 4 SOURCE OUT	30	7
PORT 1, 2, 3, 4 SOURCE OUT	27	7
PORT 1, 2, 3, 4 CPLR THRU	27 (20 ¹)	40 (50 ¹) (7 ²)
PORT 1, 2, 3, 4 CPLR ARM	30	7

¹ With an LFE option installed.

² With a thru connection between test ports of option 217 or 417 configuration, 7 VDC input to CPLR THRU ports damages the source attenuator on the connected port..

Test Set Block Diagrams

NOTE For best readability, use a color printer for printing the following graphics.

Legend

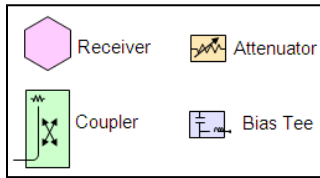

Figure 1. N5224B and N5225B Option 200 (2-port base model)

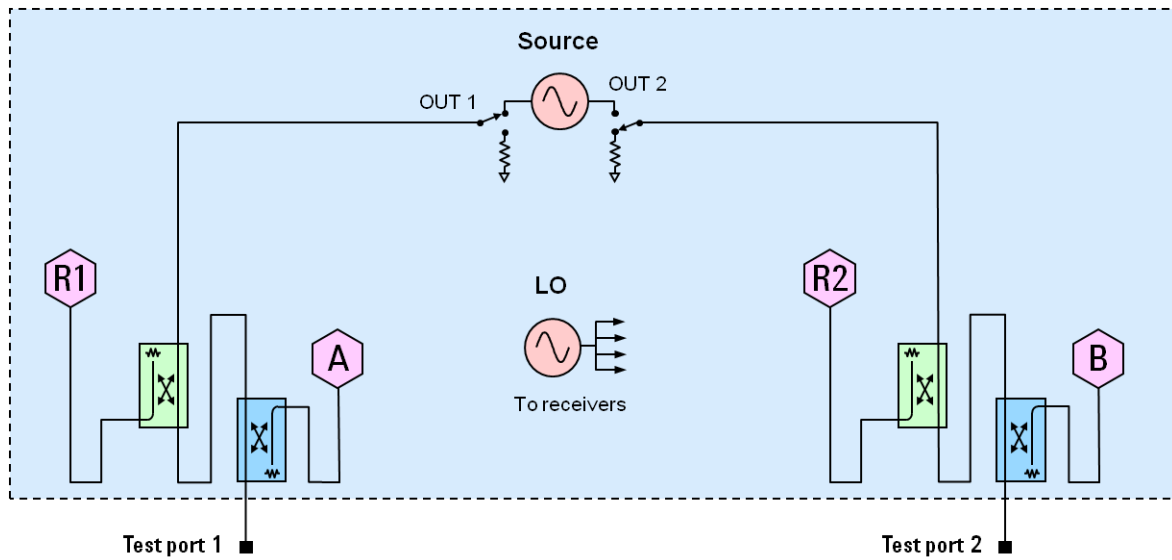

Figure 2. N5224B and N5225B Option 201

To base model, adds front-panel jumpers and R1 receiver switch

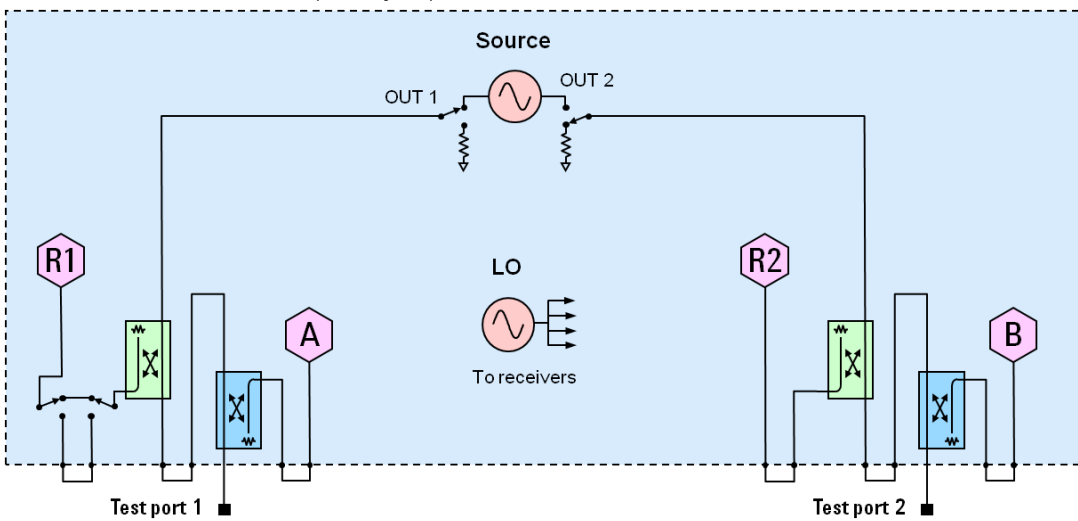

Figure 3. N5224B and N5225B LFE Options

The following LFE block diagram shows how the low-frequency hardware is configured for a single test port. The other ports are configured similarly.

NOTE The attenuators do not apply to Options 205 and 405.

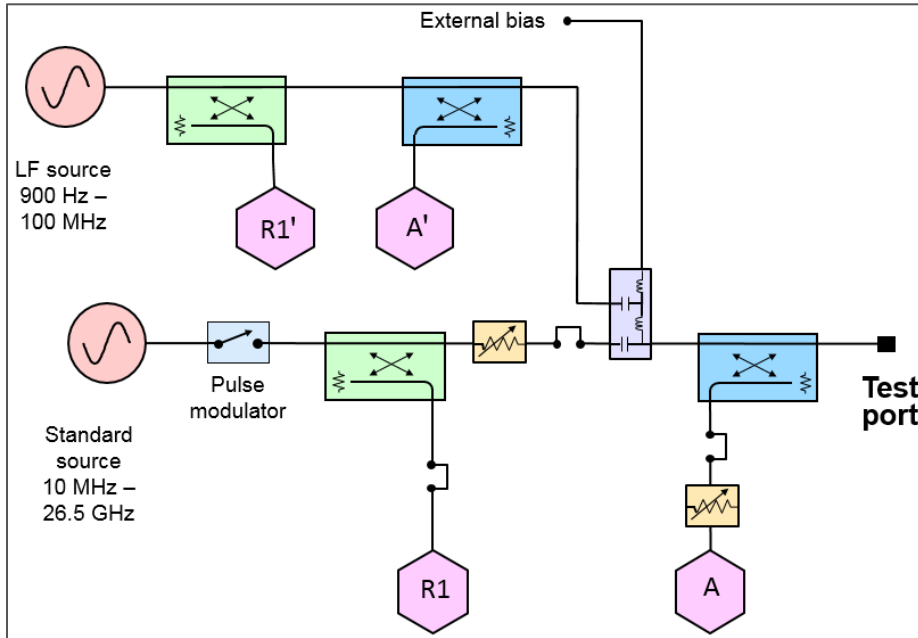

Figure 4. N5224B and N5225B Option 217

To base model, adds front-panel jumpers, R1 receiver switch, and source and receiver attenuators (extended power range).

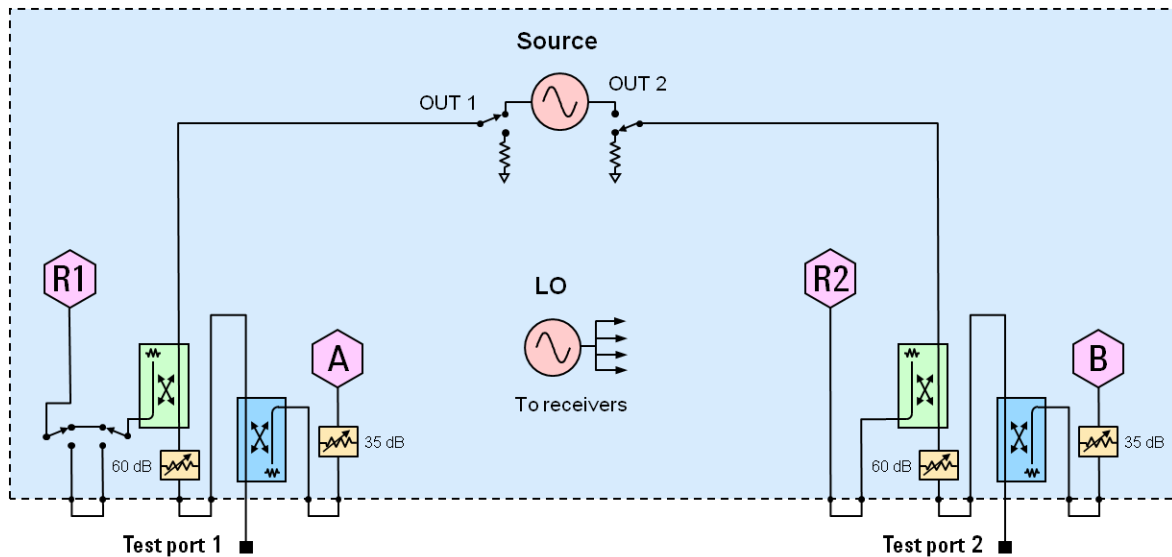

Figure 5. N5224B and N5225B Option 219

To base model, adds front-panel jumpers, R1 receiver switch, source and receiver attenuators (extended power range), and bias-tees.

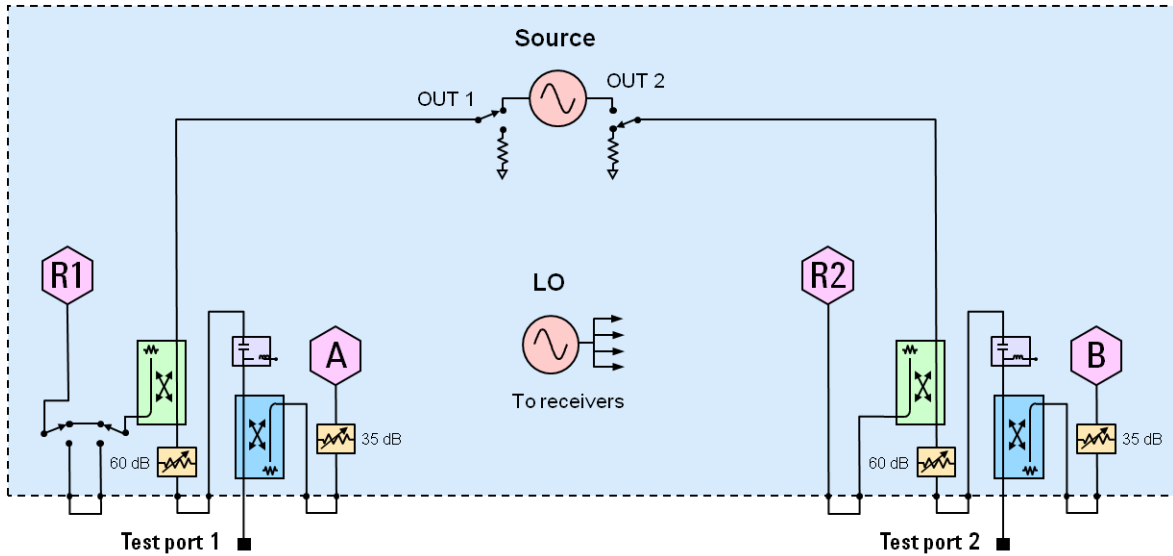

Figure 6. N5224B and N5225B Option 400 (4-port base model)

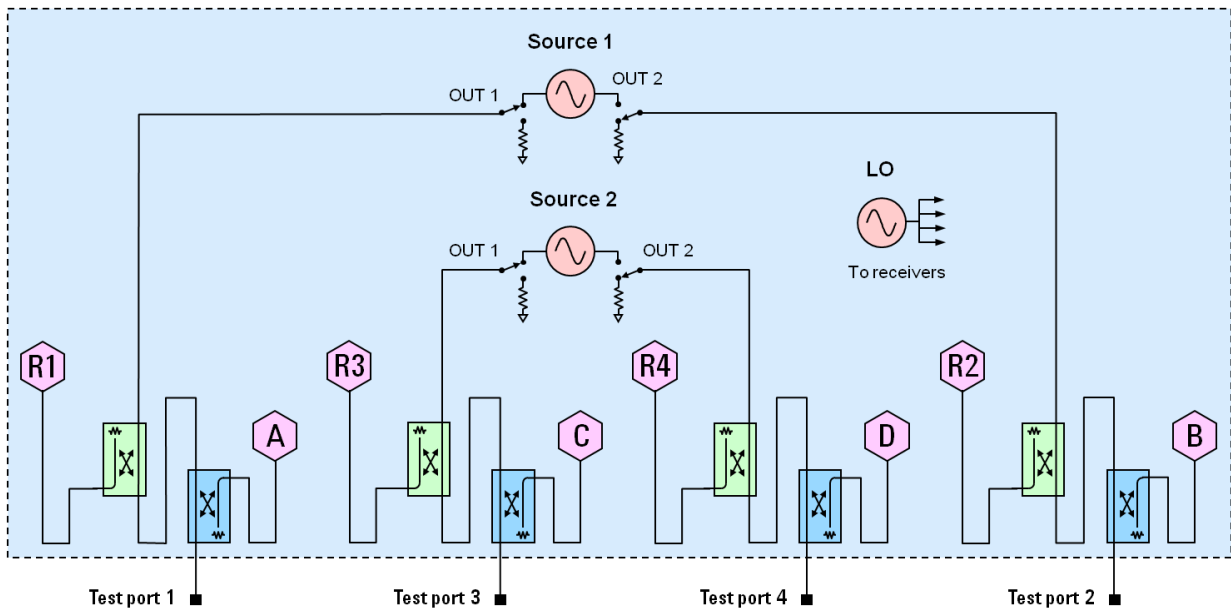

Figure 7. N5224B and N5225B Option 401

To base model, adds front-panel jumpers and R1 receiver switch

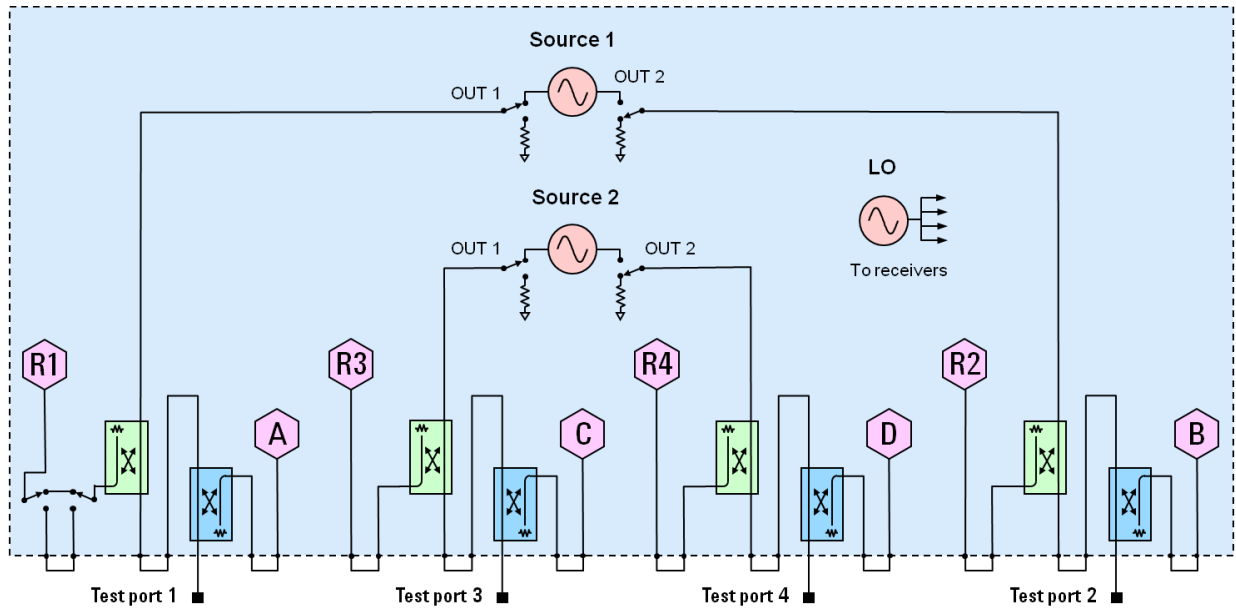

Figure 8. N5224B and N5225B Option 417

To base model, adds front-panel jumpers, R1 receiver switch, and source and receiver attenuators (extended power range).

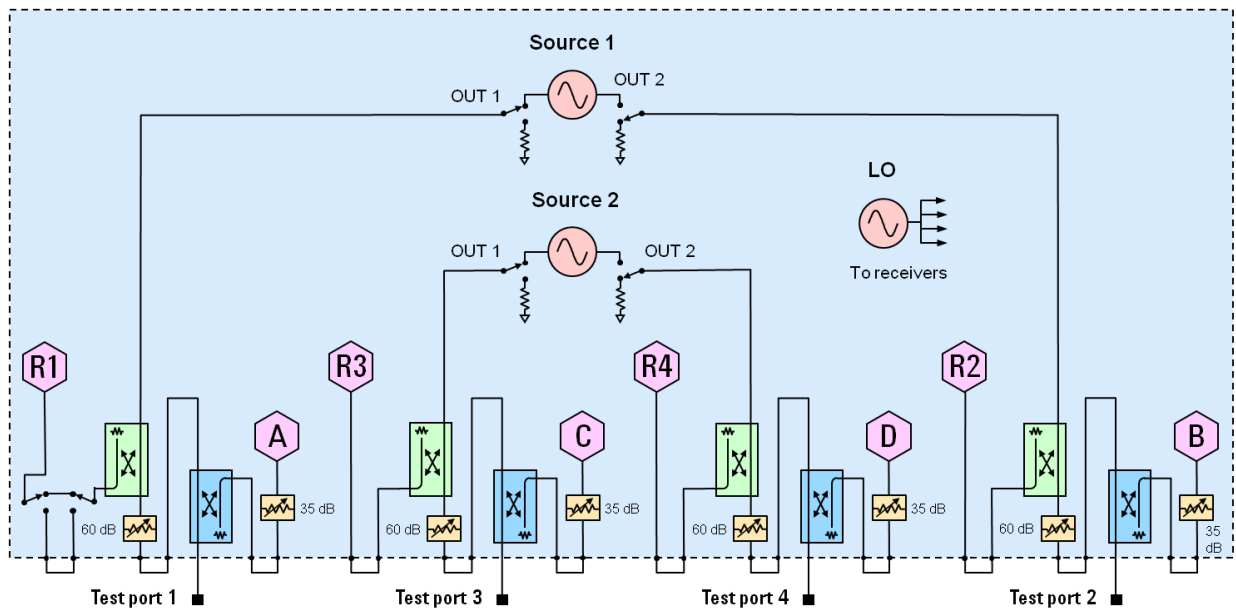

Figure 9. N5224B and N5225B Option 419

To base model, adds front-panel jumpers, R1 receiver switch, source and receiver attenuators (extended power range), and bias-tees.

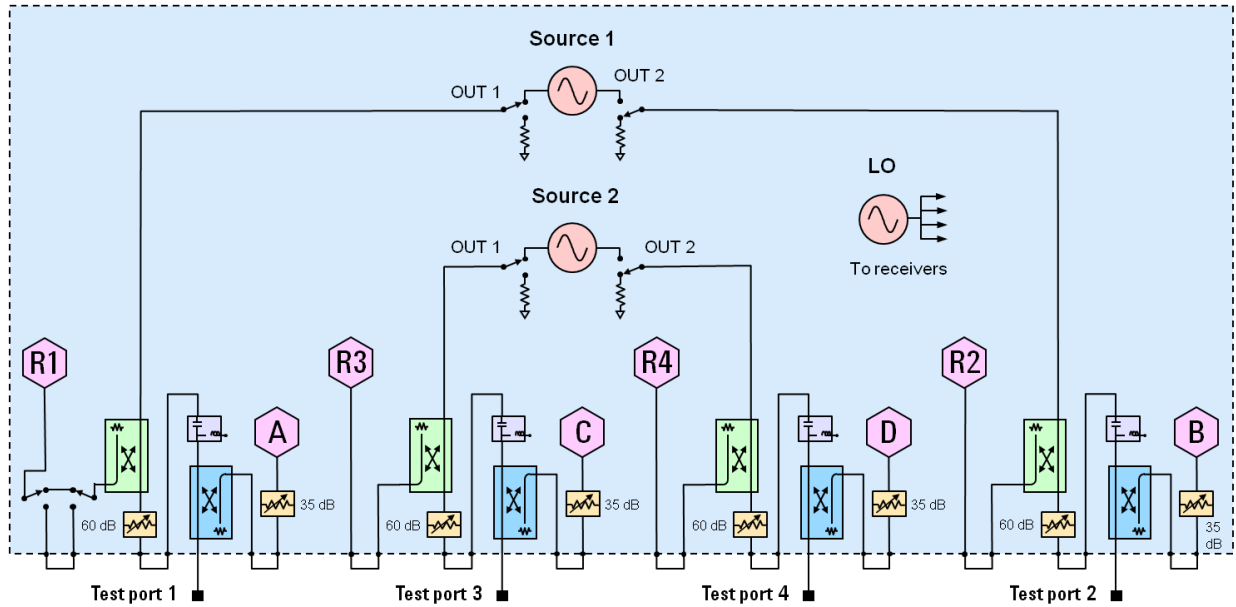
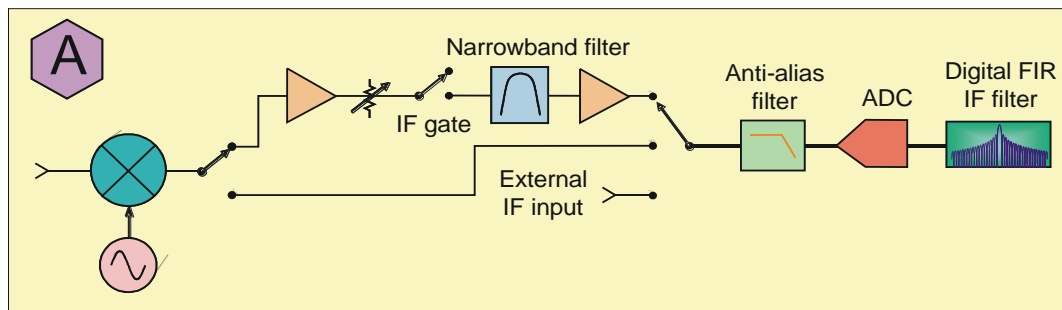

Figure 10. Receiver Block Diagram





This information is subject to change without notice.
© Keysight Technologies 2017-2020
Print Date: October 20, 2020



N5224-90003

www.keysight.com