

# R&S® ZNB VECTOR NETWORK ANALYZER

## Specifications

3  
year  
warranty

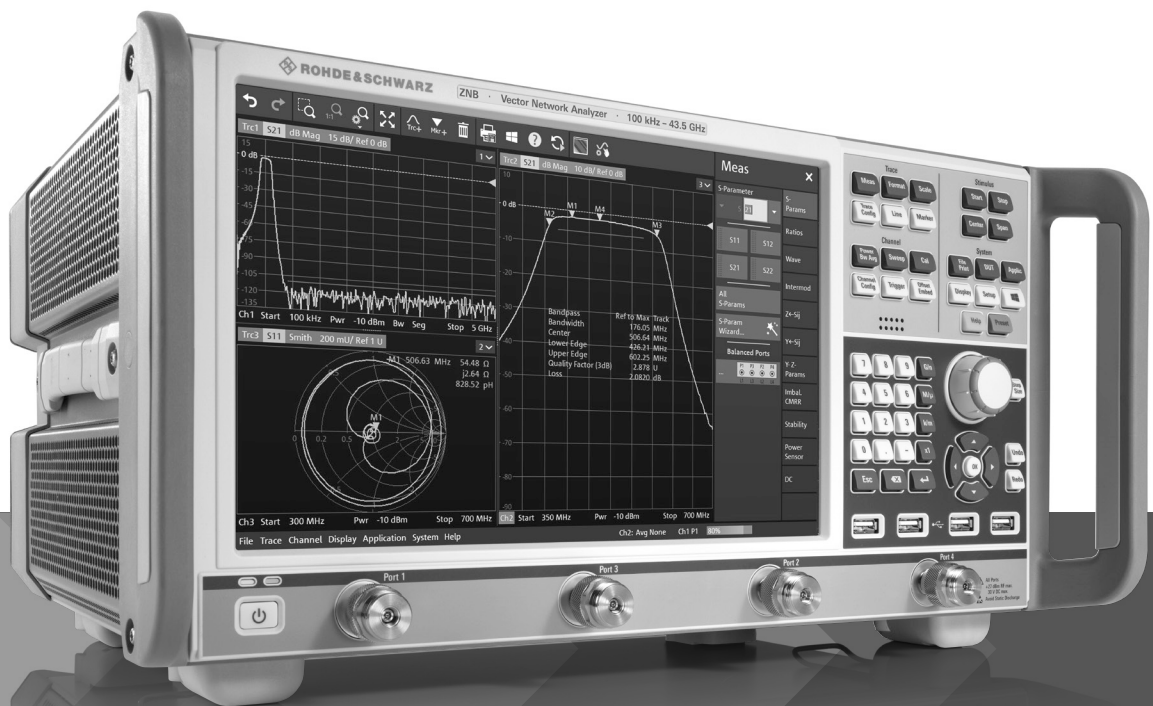

Data Sheet  
Version 06.00

**ROHDE & SCHWARZ**

Make ideas real



# CONTENTS

<b>Definitions</b> .....	<b>3</b>
<b>Measurement range</b> .....	<b>4</b>
<b>Dynamic range</b> .....	<b>5</b>
<b>Measurement speed</b> .....	<b>7</b>
<b>Measurement accuracy of the R&amp;S®ZNB4 and the R&amp;S®ZNB8</b> .....	<b>9</b>
<b>Measurement accuracy of the R&amp;S®ZNB20</b> .....	<b>10</b>
<b>Measurement accuracy of the R&amp;S®ZNB26</b> .....	<b>11</b>
<b>Measurement accuracy of the R&amp;S®ZNB43</b> .....	<b>13</b>
<b>Effective system data</b> .....	<b>15</b>
<b>Factory-calibrated system data</b> .....	<b>16</b>
<b>Test port output</b> .....	<b>20</b>
<b>Test port input</b> .....	<b>23</b>
<b>Additional front panel connectors</b> .....	<b>25</b>
<b>Display</b> .....	<b>25</b>
<b>Rear panel connectors</b> .....	<b>25</b>
<b>Options</b> .....	<b>27</b>
R&S®ZNB-B1.....	27
R&S®ZNB-B4.....	27
R&S®ZNB-B10.....	27
R&S®ZNB-B12.....	27
R&S®ZNB-B14.....	27
R&S®ZNB4-B22/-B24, R&S®ZNB8-B22/-B24, R&S®ZNB20-B22/-B24, R&S®ZNB26-B22/-B24 and R&S®ZNB43-B22/-B24 .....	28
R&S®ZNB4-B31/-B32/-B33/-B34 and R&S®ZNB8-B31/-B32/-B33/-B34 .....	28
R&S®ZNB4-B52/-B54 and R&S®ZNB8-B52/-B54 .....	28
R&S®ZNB-B81.....	29
R&S®ZNB-K980.....	30
<b>General data</b> .....	<b>31</b>
<b>Dimensions (in mm)</b> .....	<b>32</b>
<b>Ordering information</b> .....	<b>34</b>

# Definitions

## General

Product data applies under the following conditions:

- Three hours storage at ambient temperature followed by 30 minutes warm-up operation
- Specified environmental conditions met
- Recommended calibration interval adhered to
- All internal automatic adjustments performed, if applicable

## Specifications with limits

Represent warranted product performance by means of a range of values for the specified parameter. These specifications are marked with limiting symbols such as  $<$ ,  $\leq$ ,  $>$ ,  $\geq$ ,  $\pm$ , or descriptions such as maximum, limit of, minimum. Compliance is ensured by testing or is derived from the design. Test limits are narrowed by guard bands to take into account measurement uncertainties, drift and aging, if applicable.

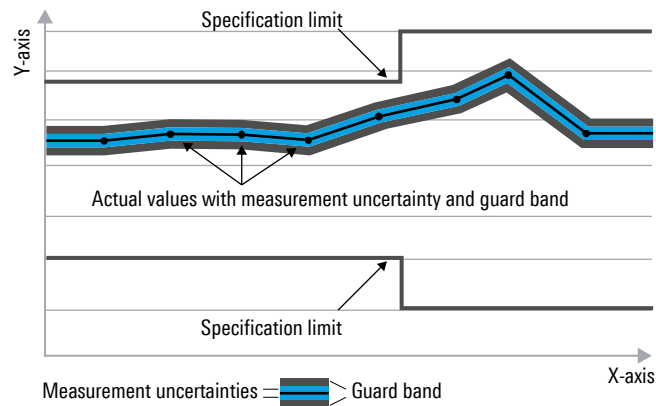

## Non-traceable specifications with limits (n. trc.)

Represent product performance that is specified and tested as described under “Specifications with limits” above. However, product performance in this case cannot be warranted due to the lack of measuring equipment traceable to national metrology standards. In this case, measurements are referenced to standards used in the Rohde & Schwarz laboratories.

## Specifications without limits

Represent warranted product performance for the specified parameter. These specifications are not specially marked and represent values with no or negligible deviations from the given value (e.g. dimensions or resolution of a setting parameter). Compliance is ensured by design.

## Typical data (typ.)

Characterizes product performance by means of representative information for the given parameter. When marked with  $<$ ,  $>$  or as a range, it represents the performance met by approximately 80 % of the instruments at production time. Otherwise, it represents the mean value.

## Nominal values (nom.)

Characterize product performance by means of a representative value for the given parameter (e.g. nominal impedance). In contrast to typical data, a statistical evaluation does not take place and the parameter is not tested during production.

## Measured values (meas.)

Characterize expected product performance by means of measurement results gained from individual samples.

## Uncertainties

Represent limits of measurement uncertainty for a given measurand. Uncertainty is defined with a coverage factor of 2 and has been calculated in line with the rules of the Guide to the Expression of Uncertainty in Measurement (GUM), taking into account environmental conditions, aging, wear and tear.

Device settings and GUI parameters are designated with the format “parameter: value”.

Non-traceable specifications with limits, typical data as well as nominal and measured values are not warranted by Rohde & Schwarz.

In line with the 3GPP/3GPP2 standard, chip rates are specified in million chips per second (Mcps), whereas bit rates and symbol rates are specified in billion bit per second (Gbps), million bit per second (Mbps), thousand bit per second (kbps), million symbols per second (MSPS) or thousand symbols per second (kSPS), and sample rates are specified in million samples per second (Msample/s). Gbps, Mcps, Mbps, MSPS, kbps, kSPS and Msample/s are not SI units.

## Measurement range

Impedance		50 $\Omega$
Test port connector	R&S®ZNB4	type N, female
	R&S®ZNB8	type N, female
	R&S®ZNB20	3.5 mm, male, ruggedized
	R&S®ZNB26	2.92 mm, male, ruggedized
	R&S®ZNB43, 2.4 mm interface	2.4 mm, male, ruggedized
	R&S®ZNB43, 2.92 mm interface	2.92 mm, male, ruggedized
Number of test ports	R&S®ZNB4	2 or 4
	R&S®ZNB8	2 or 4
	R&S®ZNB20	2 or 4
	R&S®ZNB26	2 or 4
	R&S®ZNB43	2 or 4
Frequency range <sup>1</sup>	R&S®ZNB4	9 kHz to 4.5 GHz
	R&S®ZNB8	9 kHz to 8.5 GHz
	R&S®ZNB20	100 kHz to 20 GHz
	R&S®ZNB26	100 kHz to 26.5 GHz
	R&S®ZNB43	100 kHz to 43.5 GHz

<b>Static frequency accuracy</b>	The static frequency accuracy is determined with the formula <i>(time since last adjustment in years × aging per year) + temperature drift + achievable initial calibration accuracy</i> using the values specified below. Depending on whether or not the R&S®ZNB-B4 precision frequency reference option is installed, the standard or the improved value have to be taken into account.	
Aging per year	standard	$\pm 1 \times 10^{-6}$
	with R&S®ZNB-B4 precision frequency reference option	$\pm 1 \times 10^{-7}$
Temperature drift (+5 °C to +40 °C)	standard	$\pm 1 \times 10^{-6}$
	with R&S®ZNB-B4 precision frequency reference option	$\pm 1 \times 10^{-8}$
Achievable initial calibration accuracy	standard	$\pm 5 \times 10^{-7}$
	with R&S®ZNB-B4 precision frequency reference option	$\pm 5 \times 10^{-8}$

Frequency resolution		1 Hz
Number of measurement points	per trace	1 to 100 001
Measurement bandwidth	1/1.5/2/3/5/7 steps	
	base unit	1 Hz to 1 MHz
	with R&S®ZNB-K17 option for increased IF bandwidth	1 Hz to 10 MHz

<sup>1</sup> Specified and typical data given in this data sheet applies to the R&S®ZNB4, the R&S®ZNB8, the R&S®ZNB20, the R&S®ZNB26 and the R&S®ZNB43; note their respective frequency ranges.

## Dynamic range

The receiver noise floor referred to in the following is defined as the RMS value of the data trace of the transmission magnitude, which is produced by noise and crosstalk with the test ports short-circuited. The specification applies at 10 Hz measurement bandwidth, without user correction applied. The dynamic range can be increased by using a measurement bandwidth of 1 Hz. Crosstalk does not limit the dynamic range. Dynamic range performance is specified between port 1 and port 2 as well as between port 3 and port 4 (4-port model). Otherwise, dynamic range performance is typical.

	Specification	Typical	Measured
<b>System dynamic range</b> <sup>2</sup>	R&S®ZNB4 and the R&S®ZNB8 (without options, for extended dynamic range see Options)		
	9 kHz to 100 kHz	≥ 110 dB	122 dB
	100 kHz to 50 MHz	≥ 125 dB	138 dB
	50 MHz to 7GHz	≥ 130 dB	140 dB
	7 GHz to 8.5 GHz	≥ 120 dB	130 dB
	R&S®ZNB20		
	100 kHz to 300 kHz	≥ 95 dB	108 dB
	300 kHz to 1 MHz	≥ 105 dB	120 dB
	1 MHz to 10 MHz	≥ 115 dB	125 dB
	10 MHz to 100 MHz	≥ 120 dB	130 dB
	100 MHz to 9 GHz	≥ 125 dB	135 dB
	9 GHz to 20 GHz	≥ 120 dB	130 dB
	R&S®ZNB26 and R&S®ZNB43		
	100 kHz to 1 MHz	≥ 105 dB	120 dB
	1 MHz to 10 MHz	≥ 110 dB	125 dB
	10 MHz to 5 GHz	≥ 120 dB	128 dB
	5 GHz to 10 GHz	≥ 115 dB	125 dB
	10 GHz to 30 GHz	≥ 110 dB	115 dB
	30 GHz to 35 GHz	≥ 105 dB	110 dB
	35 GHz to 38 GHz	≥ 100 dB	108 dB
	38 GHz to 40 GHz	≥ 95 dB	105 dB
	R&S®ZNB43, 2.4 mm interface		
40 GHz to 43.5 GHz	≥ 85 dB	95 dB	
R&S®ZNB43, 2.92 mm interface			
40 GHz to 43.5 GHz			95 dB

<sup>2</sup> Difference between maximum output power and receiver noise floor.

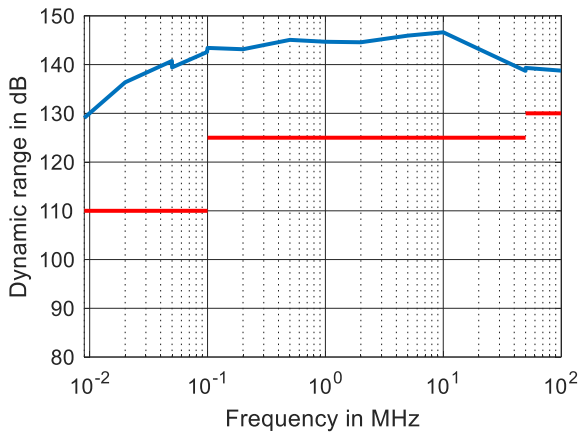

Typical dynamic range in dB versus frequency of the R&S<sup>®</sup>ZNB8 (without extended dynamic range option)

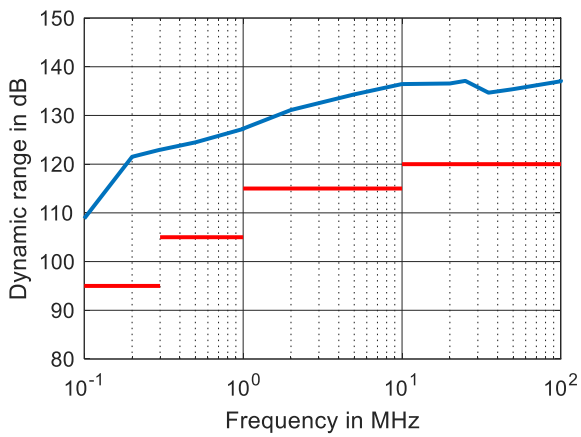
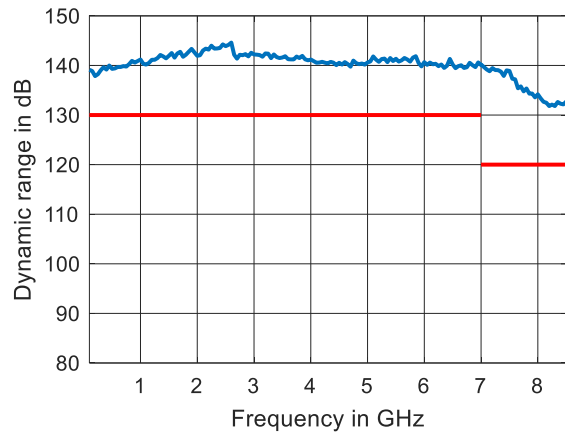

Typical dynamic range in dB versus frequency of the R&S<sup>®</sup>ZNB20

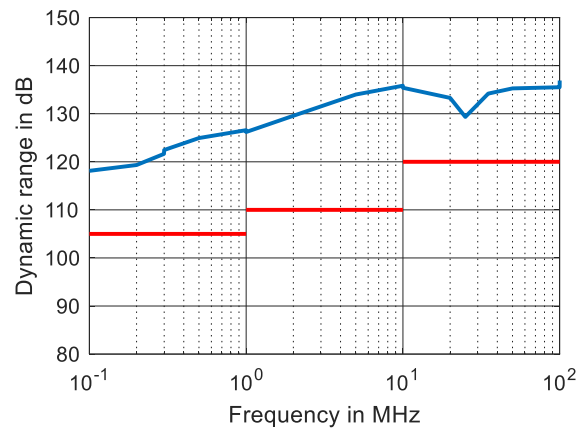
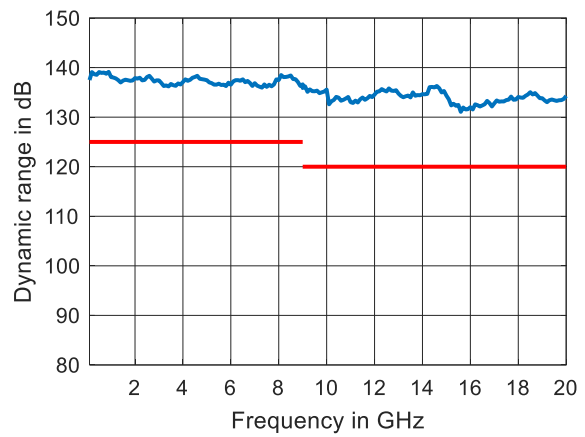

Typical dynamic range in dB versus frequency of the R&S<sup>®</sup>ZNB26

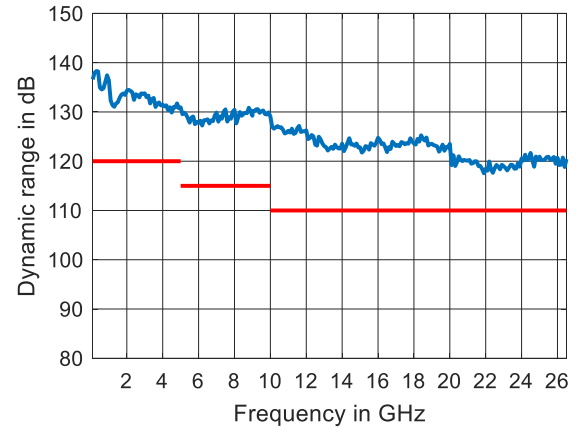

# Measurement speed

Measured with firmware version 3.40 and Windows 10.

Measurement time	for 201 measurements points, with 200 MHz span, 1 MHz measurement bandwidth				
	with 900 MHz center frequency	$T_{\text{SWEEP}}$	$T_{\text{CYCLE}}$		
	with 5.1 GHz center frequency	< 1.5 ms	< 2.5 ms		
Acquisition time per point ( $T_{\text{ACQ}}$ )	1 MHz measurement bandwidth, CW mode	2.5 $\mu$ s			
Sampling time per point ( $T_{\text{SAMPLE}}$ ) IF filter: normal	at 1 MHz measurement bandwidth	860 ns			
	at 10 MHz measurement bandwidth	312 ns			
Time for measurement and data transfer	for 201 measurements points, with 800 MHz start frequency, 1 GHz stop frequency, 1 MHz measurement bandwidth <sup>3</sup>	VXI11	HiSLIP	IEC/IEEE	USB 3.0
		over 1 Gbit/s LAN			
		3.8 ms	3.5 ms	4.0 ms	3.0 ms
Data transfer time	for 201 measurements points (magnitude)	1.0 ms	0.8 ms	1.5 ms	0.5 ms
Switching time between channels	with a maximum of 2001 points	< 5 ms			
Switching time between two preloaded instrument settings	with a maximum of 2001 points	< 5 ms			

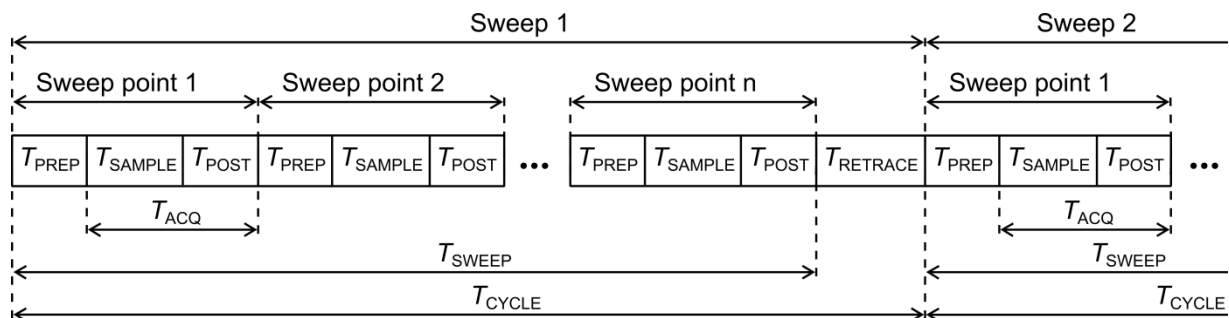

- $T_{\text{PREP}}$  Preparation time required to set up the internal hardware components
- $T_{\text{SAMPLE}}$  Sampling time (approximately equal to the settling time of the digital filters)
- $T_{\text{POST}}$  Time required for hardware postprocessing
- $T_{\text{ACQ}}$  Acquisition time ( $T_{\text{SAMPLE}} + T_{\text{POST}}$ )
- $T_{\text{SWEEP}}$  Time required for one sweep
- $T_{\text{RETRACE}}$  Time between two sweeps
- $T_{\text{CYCLE}}$  Sweep cycle time ( $T_{\text{SWEEP}} + T_{\text{RETRACE}}$ )

Measurement sequence

<sup>3</sup> In continuous mode, no additional time is needed for data transfer as this occurs simultaneously during the measurement.

<b>Nominal sweep times in ms versus number of measurement points <sup>4</sup> of the R&amp;S®ZNB4 and R&amp;S®ZNB8</b>										
Number of measurement points	51		201		401		1601		5001	
Sweep mode (stepped, swept)	swept	stepped	swept	stepped	swept	stepped	swept	stepped	swept	stepped
<b>R&amp;S®ZNB4 and R&amp;S®ZNB8</b>										
800 MHz start frequency, 1 GHz stop frequency, Memory AGC on, 500 kHz measurement bandwidth										
With correction switched off	0.7	1.2	1.2	3.0	2.0	3.7	5.7	6.7	14.6	17.0
With 2-port TOSM calibration	1.0	1.9	2.3	5.4	3.9	6.5	10.3	12.2	27.6	32.8
With 4-port TOSM calibration	1.7	3.5	4.9	10.5	8.0	12.5	22.5	25.9	57.3	67.5
1 MHz start frequency, 4.5 GHz stop frequency, Memory AGC on, 500 kHz measurement bandwidth										
With correction switched off	2.3	2.4	4.1	4.2	4.0	6.7	7.8	18.8	17.4	49.5
With 2-port TOSM calibration	4.3	4.3	8.0	8.0	7.2	12.6	14.3	36.9	32.9	98.0
With 4-port TOSM calibration	8.2	8.3	16.2	16.0	14.4	24.8	29.5	73.9	67.5	211
1 MHz start frequency, 8.5 GHz stop frequency, Memory AGC on, 500 kHz measurement bandwidth										
With correction switched off	2.6	2.7	4.5	4.6	6.8	6.8	8.4	18.8	17.7	50.0
With 2-port TOSM calibration	4.9	5.0	8.8	8.9	13.1	13.2	16.7	37.2	35.5	99.5
With 4-port TOSM calibration	9.5	9.6	17.2	17.3	26.2	26.5	33.5	74.2	70.8	213

<b>Nominal sweep times in ms versus number of measurement points <sup>4</sup> of the R&amp;S®ZNB20</b>										
9 GHz start frequency, 10 GHz stop frequency, Memory AGC on, 500 kHz measurement bandwidth										
With correction switched off	1.1	1.1	1.5	2.5	2.2	4.3	5.6	10.9	15.3	18.1
With 2-port TOSM calibration	2.9	2.9	3.6	5.6	4.8	8.7	11.9	21.6	30.9	37.6
With 4-port TOSM calibration	5.8	5.8	7.7	10.8	10.0	17.5	23.0	44.0	60.5	115
1 MHz start frequency, 20 GHz stop frequency, Memory AGC on, 500 kHz measurement bandwidth										
With correction switched off	11.7	11.6	16.1	16.1	18.9	18.8	29.0	29.0	33.5	56.7
With 2-port TOSM calibration	23.4	23.3	32.2	32.1	37.7	37.6	58.7	58.6	66.0	114
With 4-port TOSM calibration	48.2	48.1	66.8	66.7	78.2	78.2	120	120	138	248

<b>Nominal sweep times in ms versus number of measurement points <sup>4</sup> of the R&amp;S®ZNB26</b>										
9 GHz start frequency, 10 GHz stop frequency, Memory AGC on, 500 kHz measurement bandwidth										
With correction switched off	1.0	1.0	1.4	2.4	2.1	3.9	5.2	10.1	13.9	16.8
With 2-port TOSM calibration	2.6	2.6	3.4	5.0	4.4	8.3	11.0	20.5	28.6	34.9
With 4-port TOSM calibration	5.6	5.6	7.0	10.5	9.3	17.0	22.7	41.5	58.6	71.0
1 MHz start frequency, 26.5 GHz stop frequency, Memory AGC on, 500 kHz measurement bandwidth										
With correction switched off	13.1	13.1	17.6	17.7	20.7	20.7	31.2	31.2	36.5	58.9
With 2-port TOSM calibration	26.6	26.6	35.8	35.8	42.0	41.9	63.0	62.9	73.1	119
With 4-port TOSM calibration	54.6	54.5	74.1	74.1	86.6	86.7	130	130	152	242

<b>Nominal sweep times in ms versus number of measurement points <sup>4</sup> of the R&amp;S®ZNB43</b>										
Number of measurement points	51		201		401		1601		5001	
9 GHz start frequency, 10 GHz stop frequency, Memory AGC on, 500 kHz measurement bandwidth, stepped mode										
With correction switched off	1.7		2.9		4.3		10.0		17.0	
With 2-port TOSM calibration	3.5		5.9		8.7		19.7		33.8	
With 4-port TOSM calibration	7.1		11.7		17.3		39.8		69.8	
39 GHz start frequency, 40 GHz stop frequency, Memory AGC on, 500 kHz measurement bandwidth, stepped mode										
With correction switched off	1.4		2.6		3.4		6.3		16.7	
With 2-port TOSM calibration	2.9		5.0		6.6		12.4		32.5	
With 4-port TOSM calibration	5.9		10.4		13.5		25.5		67.4	
1 MHz start frequency, 43.5 GHz stop frequency, Memory AGC on, 500 kHz measurement bandwidth, stepped mode										
With correction switched off	12.9		17.6		21.6		37.6		69.9	
With 2-port TOSM calibration	25.8		35.3		43.3		75.5		140	
With 4-port TOSM calibration	51.8		71.7		88.0		152		281	

<sup>4</sup> Sweep time is to be understood as cycle time; static frequency accuracy of the instrument applies; measured with firmware version 3.40, Windows 10.



## Measurement accuracy of the R&S®ZNB4 and the R&S®ZNB8

This data is valid between +18 °C and +28 °C, provided the temperature has not varied by more than 1 °C since calibration. Validity of the data is conditional on the use of an R&S®ZV-Z270 calibration kit. This calibration kit is used to achieve the effective system data specified below. Frequency points, measurement bandwidth and sweep time have to be identical for measurement and calibration (no interpolation allowed).

Uncertainty of transmission measurements		Magnitude	Phase
9 kHz to 100 kHz	0 dB to -20 dB	0.05 dB	0.5°
	-20 dB to -40 dB	0.07 dB	0.6°
	-40 dB to -50 dB	0.12 dB	1.0°
	-50 dB to -60 dB	0.32 dB	2.3°
> 100 kHz to 8.5 GHz	+0 dB to -20 dB	0.04 dB	0.5°
	-20 dB to -40 dB	0.06 dB	0.6°
	-40 dB to -50 dB	0.09 dB	0.9°
	-50 dB to -60 dB	0.19 dB	1.5°

Specifications are based on a matched DUT, a measurement bandwidth of 10 Hz and a nominal source power of -10 dBm.

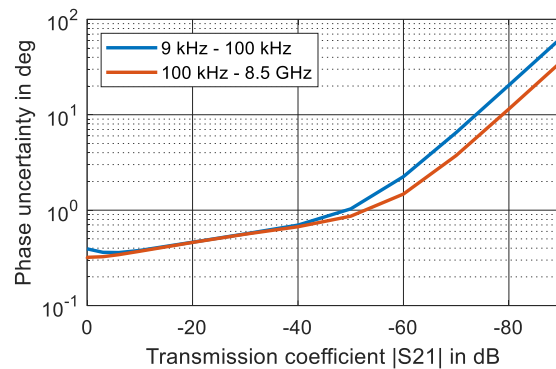
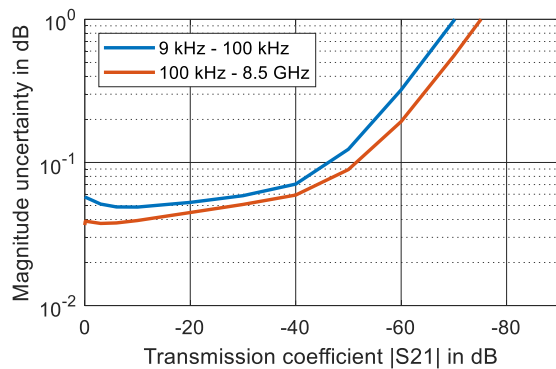

Typical uncertainty of transmission magnitude and transmission phase measurements for the R&S®ZNB4 in the frequency range from 9 kHz to 4.5 GHz, for the R&S®ZNB8 in the frequency range from 9 kHz to 8.5 GHz; analysis conditions:  $S_{11} = S_{22} = 0$ , cal. power: -10 dBm, meas. power: -10 dBm

Uncertainty of reflection measurements	Logarithmic			Linear	
	Reflection level	Magnitude	Phase	Reflection range	Magnitude
9 kHz to 2 GHz	0 dB	0.1 dB	0.6°	0 dB to -15 dB	0.010
	-15 dB	0.2 dB	1.5°	-15 dB to -25 dB	0.005
	-25 dB	0.7 dB	5.6°	-25 dB to -35 dB	0.005
> 2 GHz to 8.5 GHz	0 dB	0.1 dB	0.9°	0 dB to -15 dB	0.015
	-15 dB	0.3 dB	2.0°	-15 dB to -25 dB	0.007
	-25 dB	1.0 dB	7.5°	-25 dB	0.007

Specifications are based on an isolating DUT, a measurement bandwidth of 10 Hz and a nominal source power of -10 dBm.

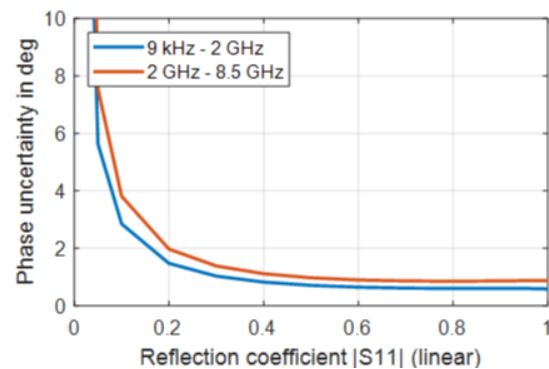
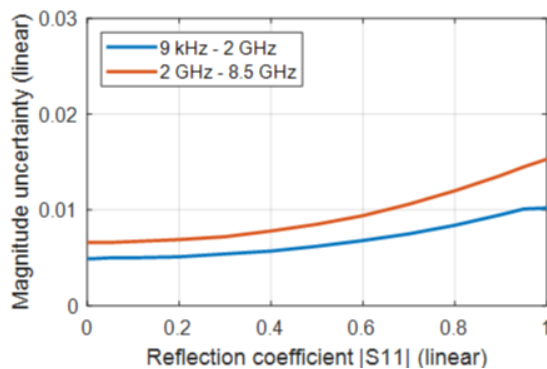

Typical uncertainty of reflection magnitude and reflection phase measurements for the R&S®ZNB4 in the frequency range from 9 kHz to 4.5 GHz, for the R&S®ZNB8 in the frequency range from 9 kHz to 8.5 GHz; analysis conditions:  $S_{12} = S_{21} = 0$ , cal. power: -10 dBm, meas. power: -10 dBm

# Measurement accuracy of the R&S®ZNB20

This data is valid between +18 °C and +28 °C, provided the temperature has not varied by more than 1 °C since calibration. Validity of the data is conditional on the use of an R&S®ZN-Z235 calibration kit. This calibration kit is used to achieve the effective system data specified below. Frequency points, measurement bandwidth and sweep time have to be identical for measurement and calibration (no interpolation allowed).

Uncertainty of transmission measurements		Magnitude	Phase
100 kHz to 10 MHz	0 dB to -20 dB	0.04 dB	0.4°
	-20 dB to -40 dB	0.11 dB	0.9°
	-40 dB to -50 dB	0.32 dB	2.2°
	-50 dB to -60 dB	0.98 dB	6.5°
> 10 MHz to 10 GHz	0 dB to -20 dB	0.05 dB	0.5°
	-20 dB to -40 dB	0.06 dB	0.7°
	-40 dB to -50 dB	0.09 dB	0.9°
	-50 dB to -60 dB	0.19 dB	1.5°
> 10 GHz to 20 GHz	0 dB to -20 dB	0.05 dB	0.7°
	-20 dB to -40 dB	0.07 dB	0.8°
	-40 dB to -50 dB	0.10 dB	1.0°
	-50 dB to -60 dB	0.24 dB	1.8°

Specifications are based on a matched DUT, a measurement bandwidth of 10 Hz and a nominal source power of -10 dBm.

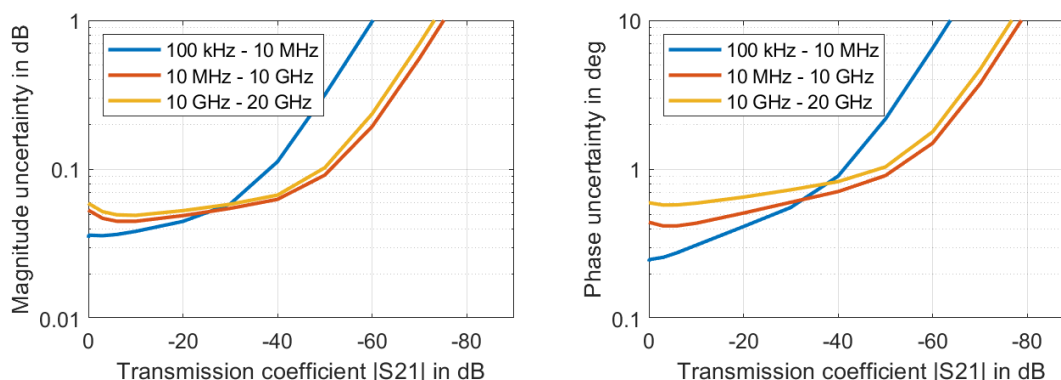

Typical uncertainty of transmission magnitude and transmission phase measurements for the R&S®ZNB20 in the frequency range from 100 kHz to 20 GHz; analysis conditions:  $S_{11} = S_{22} = 0$ , cal. power: -10 dBm, meas. power: -10 dBm

Uncertainty of reflection measurements	Logarithmic			Linear	
	Reflection level	Magnitude	Phase	Reflection range	Magnitude
100 kHz to 10 GHz	0 dB	0.1	0.7°	0 dB to -15 dB	0.013
	-15 dB	0.3	2.0°	-15 dB to -25 dB	0.007
	-25 dB	1.0	7.7°	-25 dB to -35 dB	0.007
> 10 GHz to 20 GHz	0 dB	0.2	1.1°	0 dB to -15 dB	0.019
	-15 dB	0.4	2.4°	-15 dB to -25 dB	0.008
	-25 dB	1.2	9.1°	-25 dB to -35 dB	0.008

Specifications are based on an isolating DUT, a measurement bandwidth of 10 Hz and a nominal source power of -10 dBm.

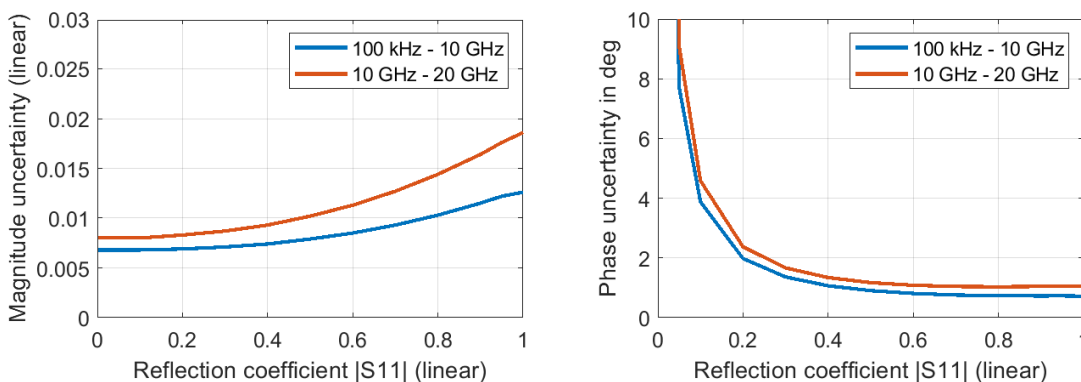

Typical uncertainty of reflection magnitude and reflection phase measurements for the R&S®ZNB20 in the frequency range from 100 kHz to 20 GHz; analysis conditions:  $S_{12} = S_{21} = 0$ , cal. power: -10 dBm, meas. power: -10 dBm

## Measurement accuracy of the R&S®ZNB26

This data is valid between +18 °C and +28 °C, provided the temperature has not varied by more than 1 °C since calibration. Validity of the data is conditional on the use of an R&S®ZN-Z235<sup>5</sup> or R&S®ZN-Z229 calibration kit. This calibration kit is used to achieve the effective system data specified below. Frequency points, measurement bandwidth and sweep time have to be identical for measurement and calibration (no interpolation allowed).

Uncertainty of transmission measurements		Magnitude	Phase
100 kHz to 300 kHz	0 dB to -20 dB	0.04 dB	0.4°
	-20 dB to -40 dB	0.07 dB	0.5°
	-40 dB to -50 dB	0.18 dB	1.2°
	-50 dB to -60 dB	0.55 dB	3.8°
> 300 kHz to 1 MHz	0 dB to -20 dB	0.04 dB	0.4°
	-20 dB to -40 dB	0.05 dB	0.5°
	-40 dB to -50 dB	0.11 dB	0.8°
	-50 dB to -60 dB	0.31 dB	2.1°
> 1 MHz to 5 GHz	0 dB to -20 dB	0.04 dB	0.4°
	-20 dB to -40 dB	0.04 dB	0.4°
	-40 dB to -50 dB	0.08 dB	0.6°
	-50 dB to -60 dB	0.18 dB	1.2°
> 5 GHz to 20 GHz	0 dB to -20 dB	0.05 dB	0.4°
	-20 dB to -40 dB	0.06 dB	0.5°
	-40 dB to -50 dB	0.09 dB	0.7°
	-50 dB to -60 dB	0.23 dB	1.6°
> 20 GHz to 26.5 GHz	0 dB to -20 dB	0.06 dB	0.5°
	-20 dB to -40 dB	0.07 dB	0.5°
	-40 dB to -50 dB	0.12 dB	0.9°
	-50 dB to -60 dB	0.32 dB	2.2°

Specifications are based on a matched DUT, a measurement bandwidth of 10 Hz and a nominal source power of -10 dBm.

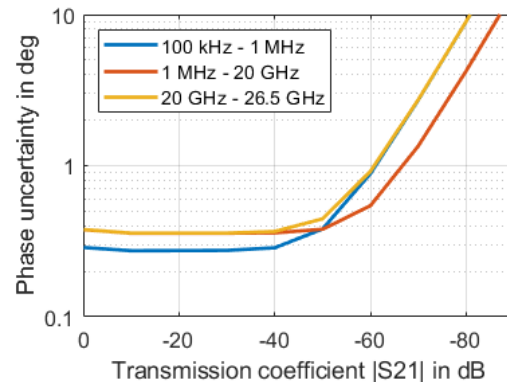
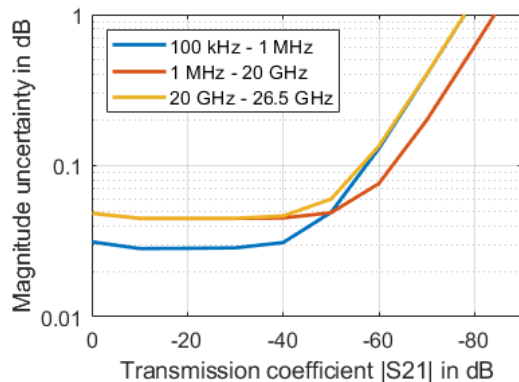

Typical uncertainty of transmission magnitude and transmission phase measurements of the R&S®ZNB26 in the frequency range from 100 kHz to 26.5 GHz; analysis conditions:  $S_{11} = S_{22} = 0$ , cal. power: -10 dBm, meas. power: -10 dBm

<sup>5</sup> Requires optional test port adapter from 2.92 mm to 3.5 mm.

Uncertainty of reflection measurements with R&S®ZNA-Z235 <sup>5</sup>	Logarithmic			Linear	
	Reflection level	Magnitude	Phase	Reflection range	Magnitude
100 kHz to 10 GHz	0 dB	0.10 dB	0.6°	0 dB to -15 dB	0.011
	-15 dB	0.29 dB	1.9°	-15 dB to -25 dB	0.006
	-25 dB	0.93 dB	6.1°	-25 dB to -35 dB	0.006
> 10 GHz to 20 GHz	0 dB	0.12 dB	0.8°	0 dB to -15 dB	0.014
	-15 dB	0.34 dB	2.3°	-15 dB to -25 dB	0.007
	-25 dB	1.09 dB	7.1°	-25 dB to -35 dB	0.007
> 20 GHz to 26.5 GHz	0 dB	0.15 dB	1.0°	0 dB to -15 dB	0.017
	-15 dB	0.44 dB	2.9°	-15 dB to -25 dB	0.009
	-25 dB	1.40 dB	9.2°	-25 dB to -35 dB	0.009

Specifications are based on an isolating DUT, a measurement bandwidth of 10 Hz and a nominal source power of -10 dBm.

Uncertainty of reflection measurements with R&S®ZNA-Z229	Logarithmic			Linear	
	Reflection level	Magnitude	Phase	Reflection range	Magnitude
100 kHz to 10 GHz	0 dB	0.11 dB	0.7°	0 dB to -15 dB	0.013
	-15 dB	0.29 dB	1.9°	-15 dB to -25 dB	0.006
	-25 dB	0.93 dB	6.1°	-25 dB to -35 dB	0.006
> 10 GHz to 20 GHz	0 dB	0.13 dB	0.9°	0 dB to -15 dB	0.015
	-15 dB	0.44 dB	2.9°	-15 dB to -25 dB	0.009
	-25 dB	1.40 dB	9.2°	-25 dB to -35 dB	0.009
> 20 GHz to 26.5 GHz	0 dB	0.20 dB	1.3°	0 dB to -15 dB	0.023
	-15 dB	0.69 dB	4.5°	-15 dB to -25 dB	0.014
	-25 dB	2.21 dB	14.3°	-25 dB to -35 dB	0.014

Specifications are based on an isolating DUT, a measurement bandwidth of 10 Hz and a nominal source power of -10 dBm.

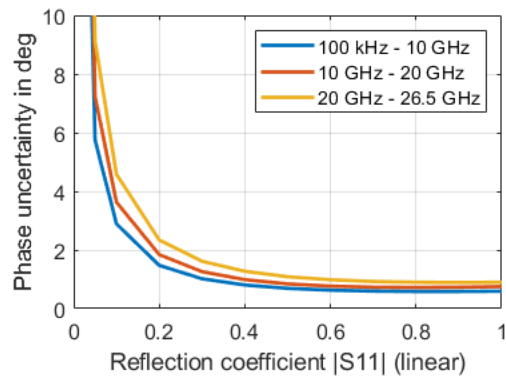
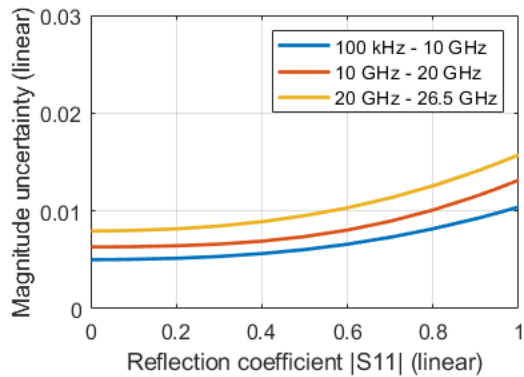

Typical uncertainty of reflection magnitude and reflection phase measurements of the R&S®ZNB26 in the frequency range from 100 kHz to 26.5 GHz; analysis conditions:  $S_{12} = S_{21} = 0$ , cal. power: -10 dBm, meas. power: -10 dBm

## Measurement accuracy of the R&S®ZNB43

This data is valid between +18 °C and +28 °C, provided the temperature has not varied by more than 1 °C since calibration. Validity of the data is conditional on the use of an R&S®ZN-Z229 or R&S®ZN-Z224 calibration kit. This calibration kit is used to achieve the effective system data specified below. Frequency points, measurement bandwidth and sweep time have to be identical for measurement and calibration (no interpolation allowed).

Uncertainty of transmission measurements		Magnitude	Phase
R&S®ZNB43			
100 kHz to 1 MHz	0 dB to -20 dB	0.04 dB	0.4°
	-20 dB to -40 dB	0.05 dB	0.4°
	-40 dB to -50 dB	0.08 dB	0.6°
	-50 dB to -60 dB	0.22 dB	1.5°
> 1 MHz to 10 GHz	0 dB to -20 dB	0.04 dB	0.4°
	-20 dB to -40 dB	0.04 dB	0.4°
	-40 dB to -50 dB	0.06 dB	0.5°
	-50 dB to -60 dB	0.13 dB	0.9°
> 10 GHz to 30 GHz	0 dB to -20 dB	0.05 dB	0.4°
	-20 dB to -40 dB	0.05 dB	0.5°
	-40 dB to -50 dB	0.07 dB	0.6°
	-50 dB to -60 dB	0.18 dB	1.2°
> 30 GHz to 40 GHz	0 dB to -20 dB	0.06 dB	0.5°
	-20 dB to -40 dB	0.08 dB	0.6°
	-40 dB to -50 dB	0.18 dB	1.3°
	-50 dB to -60 dB	0.54 dB	3.7°
R&S®ZNB43, 2.4 mm interface			
> 40 GHz to 43.5 GHz	0 dB to -20 dB	0.06 dB	0.5°
	-20 dB to -40 dB	0.14 dB	1.0°
	-40 dB to -50 dB	0.39 dB	2.6°
	-50 dB to -60 dB	1.19 dB	8.4°
R&S®ZNB43, 2.92 mm interface			
> 40 GHz to 43.5 GHz (measured)	0 dB to -20 dB	0.06 dB	0.5°
	-20 dB to -40 dB	0.14 dB	1.0°
	-40 dB to -50 dB	0.39 dB	2.6°
	-50 dB to -60 dB	1.19 dB	8.4°
Specifications are based on a matched DUT, a measurement bandwidth of 10 Hz and a nominal source power of -10 dBm.			

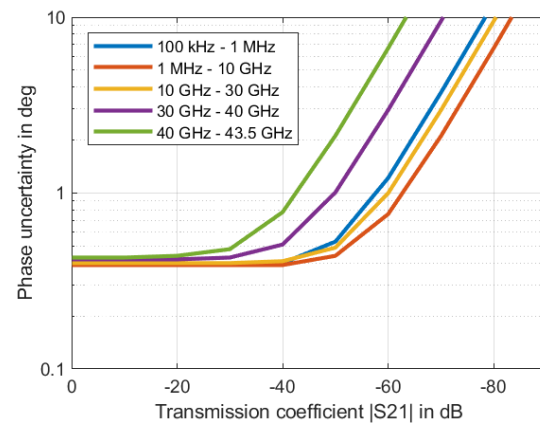
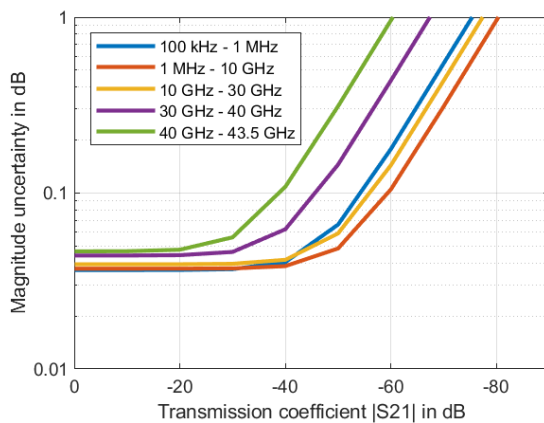

Typical uncertainty of transmission magnitude and transmission phase measurements of the R&S®ZNB43, in the frequency range from 100 kHz to 43.5 GHz; analysis conditions:  $S_{11} = S_{22} = 0$ , cal. power -10 dBm, meas. power -10 dBm

Uncertainty of reflection measurements R&S®ZNB43, 2.4 mm interface with ZN-Z224	Logarithmic			Linear	
	Reflection level	Magnitude	Phase	Reflection range	Magnitude
100 kHz to 10 GHz	0 dB	0.10 dB	0.6°	0 dB to -15 dB	0.011
	-15 dB	0.29 dB	1.6°	-15 dB to -25 dB	0.006
	-25 dB	0.93 dB	6.1°	-25 dB to -35 dB	0.006
> 10 GHz to 20 GHz	0 dB	0.12 dB	0.8°	0 dB to -15 dB	0.014
	-15 dB	0.34 dB	2.3°	-15 dB to -25 dB	0.007
	-25 dB	1.09 dB	7.1°	-25 dB to -35 dB	0.007
> 20 GHz to 26.5 GHz	0 dB	0.15 dB	1.0°	0 dB to -15 dB	0.017
	-15 dB	0.44 dB	2.9°	-15 dB to -25 dB	0.009
	-25 dB	1.40 dB	9.2°	-25 dB to -35 dB	0.009
> 26.5 GHz to 40 GHz	0 dB	0.15 dB	1.0°	0 dB to -15 dB	0.017
	-15 dB	0.44 dB	2.9°	-15 dB to -25 dB	0.009
	-25 dB	1.40 dB	9.2°	-25 dB to -35 dB	0.009
> 40 GHz to 43.5 GHz	0 dB	0.15 dB	1.0°	0 dB to -15 dB	0.017
	-15 dB	0.44 dB	2.9°	-15 dB to -25 dB	0.009
	-25 dB	1.40 dB	9.2°	-25 dB to -35 dB	0.009

Specifications are based on an isolating DUT, a measurement bandwidth of 10 Hz and a nominal source power of -10 dBm.

Uncertainty of reflection measurements R&S®ZNB43, 2.92 mm interface with ZN-Z229	Logarithmic			Linear	
	Reflection level	Magnitude	Phase	Reflection range	Magnitude
100 kHz to 10 GHz	0 dB	0.11 dB	0.7°	0 dB to -15 dB	0.013
	-15 dB	0.23 dB	1.9°	-15 dB to -25 dB	0.006
	-25 dB	0.91 dB	6.1°	-25 dB to -35 dB	0.006
> 10 GHz to 20 GHz	0 dB	0.13 dB	0.9°	0 dB to -15 dB	0.015
	-15 dB	0.44 dB	2.9°	-15 dB to -25 dB	0.009
	-25 dB	1.40 dB	9.2°	-25 dB to -35 dB	0.009
> 20 GHz to 26.5 GHz	0 dB	0.20 dB	1.3°	0 dB to -15 dB	0.023
	-15 dB	0.69 dB	4.5°	-15 dB to -25 dB	0.014
	-25 dB	2.21 dB	14.3°	-25 dB to -35 dB	0.014
> 26.5 GHz to 40 GHz	0 dB	0.20 dB	1.3°	0 dB to -15 dB	0.023
	-15 dB	0.69 dB	4.5°	-15 dB to -25 dB	0.014
	-25 dB	2.21 dB	14.3°	-25 dB to -35 dB	0.014
> 40 GHz to 43.5 GHz (measured)	0 dB	0.20 dB	1.3°	0 dB to -15 dB	0.023
	-15 dB	0.69 dB	4.5°	-15 dB to -25 dB	0.014
	-25 dB	2.21 dB	14.3°	-25 dB to -35 dB	0.014

Specifications are based on an isolating DUT, a measurement bandwidth of 10 Hz and a nominal source power of -10 dBm.

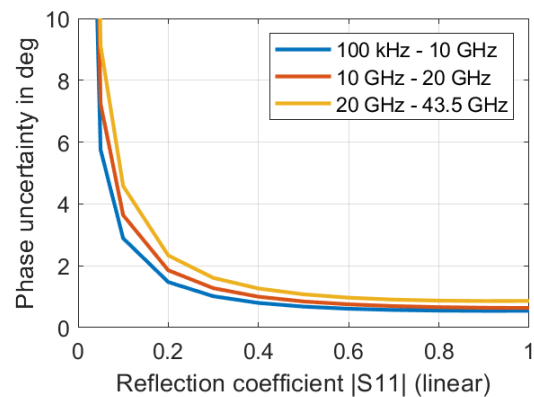
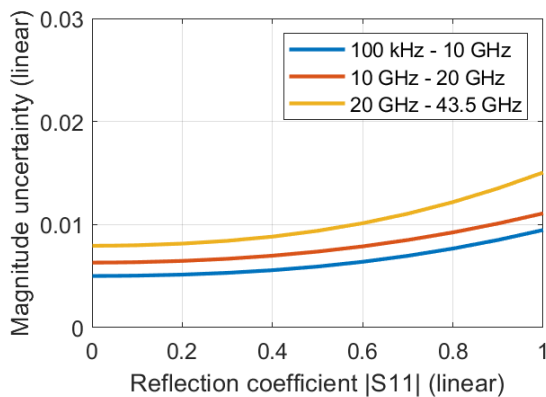

Typical uncertainty of reflection magnitude and reflection phase measurements of the R&S®ZNB43, in the frequency range from 100 kHz to 43.5 GHz; analysis conditions:  $S_{12} = S_{21} = 0$ , cal. power -10 dBm, meas. power -10 dBm

## Effective system data

This data is valid between +18 °C and +28 °C, provided the temperature has not varied by more than 1 °C since calibration. Frequency points, measurement bandwidth and sweep time have to be identical for measurement and calibration (no interpolation allowed). The data is based on a source power of –10 dBm and a measurement bandwidth of 10 Hz.

<b>R&amp;S®ZNB4 and R&amp;S®ZNB8, calibrated using R&amp;S®ZV-Z270</b>	<b>9 kHz to 100 kHz</b>	<b>100 kHz to 4.5 GHz</b>	<b>4.5 GHz to 8.5 GHz</b>
Directivity	≥ 46 dB	≥ 45 dB	≥ 40 dB
Source match	≥ 41 dB	≥ 40 dB	≥ 36 dB
Load match	≥ 44 dB	≥ 45 dB	≥ 40 dB
Reflection tracking	≤ 0.02 dB	≤ 0.02 dB	≤ 0.05 dB
Transmission tracking	≤ 0.028 dB	≤ 0.018 dB	≤ 0.09 dB

<b>R&amp;S®ZNB20, calibrated using R&amp;S®ZN-Z235</b>	<b>100 kHz to 10 GHz</b>	<b>10 GHz to 20 GHz</b>
Directivity	≥ 46 dB	≥ 43 dB
Source match	≥ 43 dB	≥ 38 dB
Load match	≥ 45 dB	≥ 42 dB
Reflection tracking	≤ 0.05 dB	≤ 0.09 dB
Transmission tracking	≤ 0.03 dB	≤ 0.03 dB

<b>R&amp;S®ZNB26, calibrated using R&amp;S®ZN-Z235<sup>5</sup></b>	<b>100 kHz to 10 GHz</b>	<b>10 GHz to 20 GHz</b>	<b>20 GHz to 26.5 GHz</b>
Directivity	≥ 46 dB	≥ 44 dB	≥ 42 dB
Source match	≥ 43 dB	≥ 40 dB	≥ 40 dB
Load match	≥ 45 dB	≥ 43 dB	≥ 41 dB
Reflection tracking	≤ 0.05 dB	≤ 0.05 dB	≤ 0.08 dB
Transmission tracking	≤ 0.03 dB	≤ 0.03 dB	≤ 0.03 dB

<b>R&amp;S®ZNB26, calibrated using R&amp;S®ZN-Z229</b>	<b>100 kHz to 10 GHz</b>	<b>10 GHz to 20 GHz</b>	<b>20 GHz to 26.5 GHz</b>
Directivity	≥ 45 dB	≥ 42 dB	≥ 38 dB
Source match	≥ 41 dB	≥ 40 dB	≥ 36 dB
Load match	≥ 44 dB	≥ 41 dB	≥ 37 dB
Reflection tracking	≤ 0.05 dB	≤ 0.05 dB	≤ 0.08 dB
Transmission tracking	≤ 0.03 dB	≤ 0.03 dB	≤ 0.03 dB

<b>R&amp;S®ZNB43, 2.4 mm interface, calibrated using R&amp;S®ZN-Z224</b>	<b>100 kHz to 10 GHz</b>	<b>10 GHz to 20 GHz</b>	<b>20 GHz to 26.5 GHz</b>	<b>26.5 GHz to 40 GHz</b>	<b>40 GHz to 43.5 GHz</b>
Directivity	≥ 46 dB	≥ 44 dB	≥ 42 dB	≥ 42 dB	≥ 42 dB
Source match	≥ 43 dB	≥ 40 dB	≥ 40 dB	≥ 40 dB	≥ 40 dB
Load match	≥ 45 dB	≥ 43 dB	≥ 41 dB	≥ 41 dB	≥ 41 dB
Reflection tracking	≤ 0.05 dB	≤ 0.05 dB	≤ 0.08 dB	≤ 0.08 dB	≤ 0.08 dB
Transmission tracking	≤ 0.03 dB	≤ 0.03 dB	≤ 0.03 dB	≤ 0.04 dB	≤ 0.05 dB

<b>R&amp;S®ZNB43, 2.92 mm interface, calibrated using R&amp;S®ZN-Z229</b>	<b>100 kHz to 10 GHz</b>	<b>10 GHz to 20 GHz</b>	<b>20 GHz to 26.5 GHz</b>	<b>26.5 GHz to 40 GHz</b>	<b>40 GHz to 43.5 GHz (measured)</b>
Directivity	≥ 45 dB	≥ 42 dB	≥ 38 dB	≥ 38 dB	≥ 38 dB
Source match	≥ 41 dB	≥ 40 dB	≥ 36 dB	≥ 36 dB	≥ 36 dB
Load match	≥ 44 dB	≥ 41 dB	≥ 37 dB	≥ 37 dB	≥ 37 dB
Reflection tracking	≤ 0.05 dB	≤ 0.05 dB	≤ 0.08 dB	≤ 0.08 dB	≤ 0.08 dB
Transmission tracking	≤ 0.03 dB	≤ 0.03 dB	≤ 0.03 dB	≤ 0.04 dB	≤ 0.05 dB

# Factory-calibrated system data

This data is valid between +18 °C and +28 °C. It is based on a source power of –10 dBm and a measurement bandwidth of 1 kHz.

		Specification	Typical	Measured
Directivity	R&S®ZNB4, R&S®ZNB8 and R&S®ZNB20			
	9 kHz to 50 kHz	≥ 20 dB	35 dB	
	50 kHz to 4.5 GHz	≥ 30 dB	50 dB	
	4.5 GHz to 10 GHz	≥ 30 dB	50 dB	
	10 GHz to 20 GHz	≥ 25 dB	35 dB	
	R&S®ZNB26 and R&S®ZNB43			
	100 kHz to 300 kHz	≥ 20 dB	50 dB	
	300 kHz to 10 GHz	≥ 30 dB	50 dB	
	10 GHz to 20 GHz	≥ 25 dB	45 dB	
	20 GHz to 35 GHz	≥ 20 dB	40 dB	
	35 GHz to 40 GHz	≥ 15 dB	35 dB	
	R&S®ZNB43, 2.4 mm interface			
	40 GHz to 43.5 GHz	≥ 15 dB	35 dB	
	R&S®ZNB43, 2.92 mm interface			
40 GHz to 43.5 GHz			35 dB	
Source match	R&S®ZNB4, R&S®ZNB8 and R&S®ZNB20			
	9 kHz to 50 kHz	≥ 20 dB	35 dB	
	50 kHz to 4.5 GHz	≥ 30 dB	50 dB	
	4.5 GHz to 10 GHz	≥ 30 dB	50 dB	
	10 GHz to 20 GHz	≥ 25 dB	35 dB	
	R&S®ZNB26 and R&S®ZNB43			
	100 kHz to 10 GHz	≥ 30 dB	50 dB	
	10 GHz to 20 GHz	≥ 25 dB	45 dB	
	20 GHz to 35 GHz	≥ 20 dB	40 dB	
	35 GHz to 40 GHz	≥ 15 dB	35 dB	
	R&S®ZNB43, 2.4 mm interface			
	40 GHz to 43.5 GHz	≥ 15 dB	35 dB	
	R&S®ZNB43, 2.92 mm interface			
	40 GHz to 43.5 GHz			35 dB
Reflection tracking	R&S®ZNB4, R&S®ZNB8, R&S®ZNB20, R&S®ZNB26 and R&S®ZNB43			
	9 kHz to 20 GHz	≤ 0.5 dB	0.05 dB	
	20 GHz to 40 GHz	≤ 0.5 dB	0.1 dB	
	R&S®ZNB43, 2.4 mm interface			
	40 GHz to 43.5 GHz	≤ 1 dB	0.2 dB	
	R&S®ZNB43, 2.92 mm interface			
40 GHz to 43.5 GHz			0.2 dB	
Transmission tracking	R&S®ZNB4, R&S®ZNB8, R&S®ZNB20, R&S®ZNB26 and R&S®ZNB43			
	9 kHz to 20 GHz	≤ 0.5 dB	0.05 dB	
	20 GHz to 40 GHz	≤ 0.5 dB	0.1 dB	
	R&S®ZNB43, 2.4 mm interface			
	40 GHz to 43.5 GHz	≤ 1.5 dB	0.2 dB	
	R&S®ZNB43, 2.92 mm interface			
40 GHz to 43.5 GHz			0.2 dB	
Load match	R&S®ZNB4 and R&S®ZNB8			
	9 kHz to 50 kHz	≥ 10 dB	15 dB	
	50 kHz to 8.5 GHz	≥ 20 dB	25 dB	
	R&S®ZNB20			
	100 kHz to 1 MHz	≥ 16 dB	30 dB	
	1 MHz to 100 MHz	≥ 20 dB	35 dB	
	100 MHz to 10 GHz	≥ 12 dB	16 dB	
	10 GHz to 20 GHz	≥ 10 dB	14 dB	
	R&S®ZNB26 and R&S®ZNB43			
	100 kHz to 300 kHz	≥ 12 dB	15 dB	
	300 kHz to 10 MHz	≥ 15 dB	18 dB	
	10 MHz to 20 GHz	≥ 18 dB	20 dB	
	20 GHz to 40 GHz	≥ 15 dB	17 dB	
	R&S®ZNB43, 2.4 mm interface			
	40 GHz to 43.5 GHz	≥ 15 dB	17 dB	
	R&S®ZNB43, 2.92 mm interface			
	40 GHz to 43.5 GHz			17 dB



Trace stability		IF bandwidth	Specification	Typical	Measured	
Trace noise magnitude (RMS) at 0 dBm source power, 0 dB reflection	R&S®ZNB4 and R&S®ZNB8					
	9 kHz to 20 kHz	1 kHz	≤ 0.008 dB	0.004 dB		
	20 kHz to 100 kHz	1 kHz	≤ 0.004 dB	0.001 dB		
	100 kHz to 100 MHz	10 kHz	≤ 0.004 dB	0.001 dB		
	100 MHz to 8.5 GHz	10 kHz	≤ 0.004 dB	0.002 dB		
	R&S®ZNB20					
	100 kHz to 300 kHz	10 kHz	≤ 0.006 dB	0.002 dB		
	300 kHz to 20 GHz	10 kHz	≤ 0.004 dB	0.0015 dB		
	R&S®ZNB26 and R&S®ZNB43					
	100 kHz to 5 MHz	10 kHz	≤ 0.008 dB	0.002 dB		
	5 MHz to 20 GHz	10 kHz	≤ 0.004 dB	0.002 dB		
	20 GHz to 35 GHz	10 kHz	≤ 0.006 dB	0.003 dB		
	35 GHz to 40 GHz	10 kHz	≤ 0.008 dB	0.005 dB		
	R&S®ZNB43, 2.4 mm interface					
	40 GHz to 42 GHz	10 kHz	≤ 0.012 dB	0.006 dB		
	42 GHz to 43.5 GHz	10 kHz	≤ 0.025 dB	0.010 dB		
	R&S®ZNB43, 2.92 mm interface					
	40 GHz to 42 GHz	10 kHz			0.006 dB	
	42 GHz to 43.5 GHz	10 kHz			0.010 dB	
Trace noise phase (RMS) at 0 dBm source power, 0 dB reflection	R&S®ZNB4 and R&S®ZNB8					
	9 kHz to 20 kHz	1 kHz	≤ 0.070°	0.040°		
	20 kHz to 100 kHz	1 kHz	≤ 0.035°	0.010°		
	100 kHz to 100 MHz	10 kHz	≤ 0.035°	0.005°		
	100 MHz to 8.5 GHz	10 kHz	≤ 0.035°	0.020°		
	R&S®ZNB20					
	100 kHz to 300 kHz	10 kHz	≤ 0.050°	0.015°		
	300 kHz to 20 GHz	10 kHz	≤ 0.035°	0.01°		
	R&S®ZNB26 and R&S®ZNB43					
	100 kHz to 5 MHz	10 kHz	≤ 0.07°	0.02°		
	5 MHz kHz to 20 GHz	10 kHz	≤ 0.035°	0.015°		
	20 GHz to 35 GHz	10 kHz	≤ 0.05°	0.02°		
	35 GHz to 40 GHz	10 kHz	≤ 0.08°	0.04°		
	R&S®ZNB43, 2.4 mm interface					
	40 GHz to 42 GHz	10 kHz	≤ 0.12°	0.04°		
	42 GHz to 43.5 GHz	10 kHz	≤ 0.25°	0.08°		
	R&S®ZNB43, 2.92 mm interface					
	40 GHz to 42 GHz	10 kHz			0.04°	
	42 GHz to 43.5 GHz	10 kHz			0.08°	

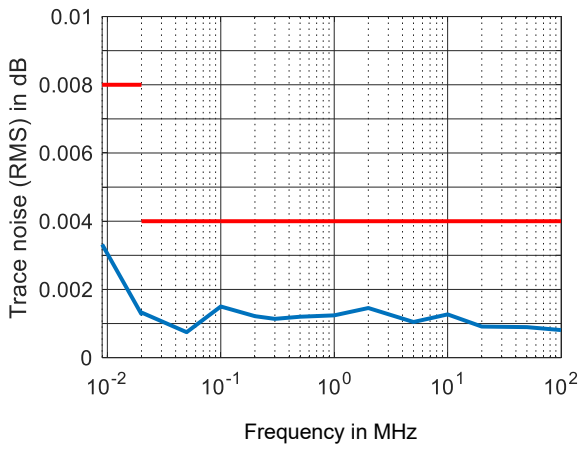

Typical trace noise (RMS) in dB versus frequency of the R&S®ZNB8

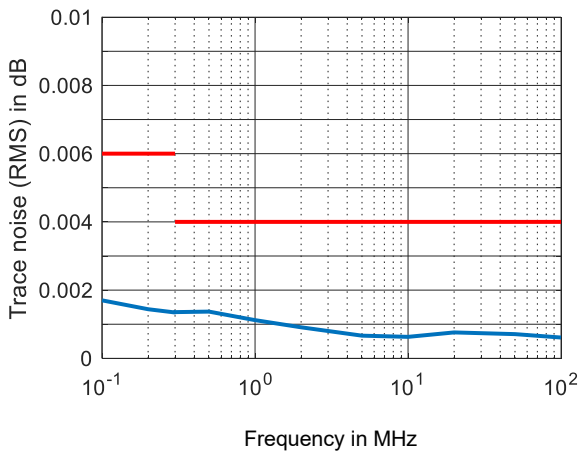
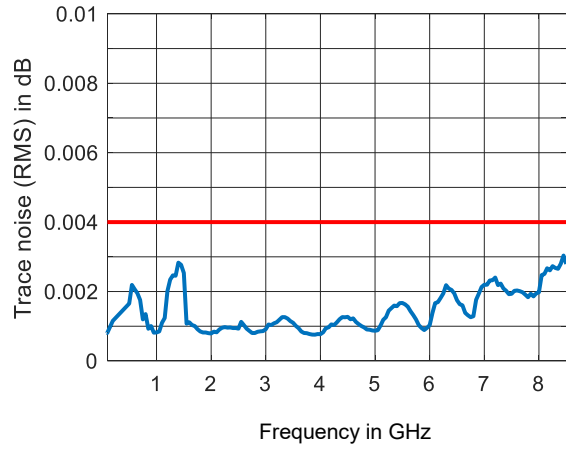

Typical trace noise (RMS) in dB versus frequency of the R&S®ZNB20

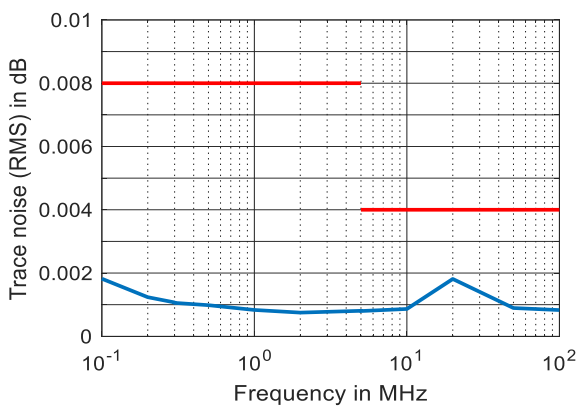
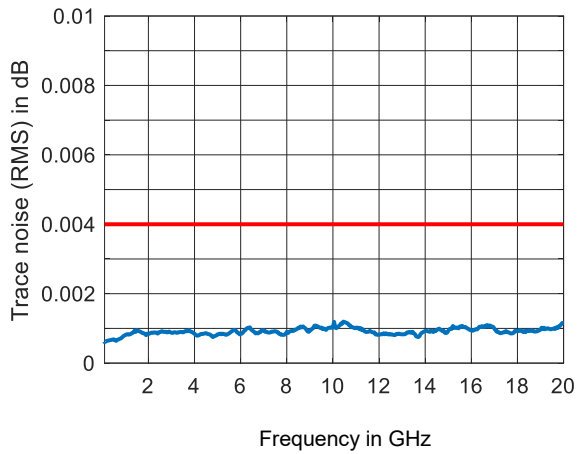

Typical trace noise (RMS) in dB versus frequency of the R&S®ZNB26

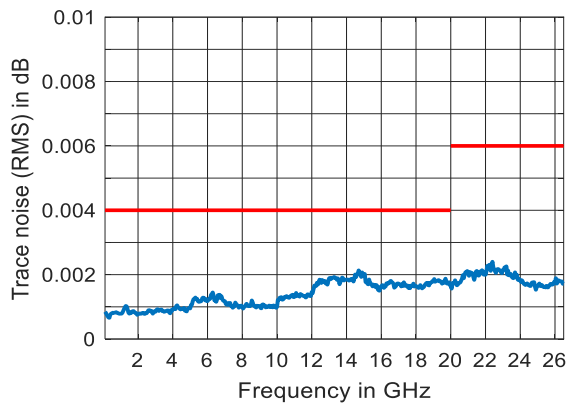

Measured temperature stability <sup>6</sup>		9 kHz to 100 kHz	100 kHz to 10 GHz	10 GHz to 40 GHz	40 GHz to 43.5 GHz
Transmission magnitude at –10 dBm source power	R&S®ZNB4, R&S®ZNB8	0.02 dB/K	0.016 dB/K	–	–
	R&S®ZNB20	–	0.014 dB/K	0.026 dB/K	–
	R&S®ZNB26	–	0.018 dB/K		–
	R&S®ZNB43	–	0.014 dB/K	0.022 dB/K	0.036 dB/K
Transmission phase <sup>7</sup> at –10 dBm source power	R&S®ZNB4, R&S®ZNB8	0.035°/GHz/K			
	R&S®ZNB20, R&S®ZNB26	0.045°/GHz/K			
	R&S®ZNB43	–	0.012°/GHz/K		
VNA uncertainty model, applicable for R&S®ZNB-K50 and R&S®ZNB-K50P real-time measurement uncertainty analysis options	R&S®ZNB4, R&S®ZNB8, R&S®ZNB20 and R&S®ZNB26				
	tracking magnitude	0.010 dB/K		0.020 dB/K	
	symmetry magnitude	0.004 dB/K		0.006 dB/K	
	directivity/match	–65 dB		–60 dB	
	tracking phase <sup>7</sup>	0.025°/GHz/K			
	symmetry phase <sup>7</sup>	0.020°/GHz/K			
	R&S®ZNB43				
	tracking magnitude	–	0.015 dB/K	0.020 dB/K	0.040 dB/K
	symmetry magnitude	–	0.008 dB/K	0.010 dB/K	0.040 dB/K
	directivity/match	–	–65 dB		
	tracking phase <sup>7</sup>	–	0.013°/GHz/K		
	symmetry phase <sup>7</sup>	–	0.012°/GHz/K		

<sup>6</sup> The stability is obtained by measuring the through connection repeatedly while varying the temperature in the range from +18 °C to +28 °C and observing the deviations between the measurements. A temperature drift per Kelvin is deduced.

<sup>7</sup> The phase drift increases linearly with frequency. It is described only by the slope, therefore the factor between phase drift and frequency is stated.

# Test port output

This data is valid in the temperature range from +18 °C to +28 °C.

Parameter	Frequency range	Specification	Typical	Measured
Power range	without optional extended power range			
	R&S®ZNB4 and R&S®ZNB8			
	9 kHz to 100 MHz	-55 dBm to +10 dBm	up to +12 dBm	
	100 MHz to 2.5 GHz	-55 dBm to +13 dBm	up to +15 dBm	
	2.5 GHz to 7.5 GHz	-55 dBm to +10 dBm	up to +13 dBm	
	7.5 GHz to 8.5 GHz	-55 dBm to +8 dBm	up to +12 dBm	
	R&S®ZNB20			
	100 kHz to 10 GHz	-30 dBm to +12 dBm	up to +15 dBm	
	10 GHz to 20 GHz	-30 dBm to +10 dBm	up to +13 dBm	
	R&S®ZNB26 and R&S®ZNB43			
	100 kHz to 300 kHz	-30 dBm to +7 dBm	up to +10 dBm	
	300 kHz to 1 GHz	-30 dBm to +10 dBm	up to +12 dBm	
	1 GHz to 10 GHz	-30 dBm to +8 dBm	up to +10 dBm	
	10 GHz to 15 GHz	-30 dBm to +6 dBm	up to +8 dBm	
	15 GHz to 20 GHz	-30 dBm to +5 dBm	up to +7 dBm	
	20 GHz to 30 GHz	-30 dBm to 0 dBm	up to +4 dBm	
	30 GHz to 40 GHz	-30 dBm to -2 dBm	up to +2 dBm	
	R&S®ZNB43, 2.4 mm interface			
	40 GHz to 43.5 GHz	-30 dBm to -3 dBm	up to +2 dBm	
	R&S®ZNB43, 2.92 mm interface			
40 GHz to 43.5 GHz			+2 dBm	
Minimum power level	using optional extended power range (see Options)			
	R&S®ZNB4 and R&S®ZNB8			
	9 kHz to 8.5 GHz	-85 dBm		
	R&S®ZNB20 and R&S®ZNB26 and R&S®ZNB43			
	100 kHz to 40 GHz	-60 dBm		
	R&S®ZNB43, 2.4 mm interface			
	40 GHz to 43.5 GHz	-60 dBm		
	R&S®ZNB43, 2.92 mm interface			
40 GHz to 43.5 GHz				
Power accuracy, source power: -10 dBm	R&S®ZNB4 and R&S®ZNB8			
	9 kHz to 50 kHz	≤ 3 dB	0.5 dB	
	50 kHz to 8.5 GHz	≤ 2 dB	0.3 dB	
	R&S®ZNB20			
	100 kHz to 10 GHz	≤ 2 dB	0.25 dB	
	10 GHz to 20 GHz	≤ 3 dB	0.5 dB	
	R&S®ZNB26 and R&S®ZNB43			
	100 kHz to 20 GHz	≤ 3 dB	0.5 dB	
	20 GHz to 40 GHz	≤ 5 dB	1.0 dB	
	R&S®ZNB43, 2.4 mm interface			
	40 GHz to 43.5 GHz	≤ 5 dB	1.0 dB	
	R&S®ZNB43, 2.92 mm interface			
40 GHz to 43.5 GHz			1.0 dB	
Power linearity, referenced to -10 dBm	R&S®ZNB4 and R&S®ZNB8			
	source power ≥ -55 dBm	≤ 1 dB	0.3 dB	
	source power < -55 dBm	≤ 2 dB		
	R&S®ZNB20			
	source power ≥ -30 dBm	≤ 1 dB	0.3 dB	
	source power < -30 dBm	≤ 2 dB	0.5 dB	
	R&S®ZNB26 and R&S®ZNB43			
	source power ≥ -30 dBm			
	10 MHz to 20 GHz	≤ 1 dB	0.3 dB	
	20 GHz to 40 GHz	≤ 2 dB	0.5 dB	
	source power < -30 dBm			
	10 MHz to 20 GHz	≤ 2 dB	0.3 dB	
20 GHz to 40 GHz	≤ 4 dB	0.5 dB		

Parameter	Frequency range	Specification	Typical	Measured	
	R&S®ZNB43, 2.4 mm interface				
	source power $\geq -30$ dBm				
	40 GHz to 43.5 GHz	$\leq 2$ dB	0.5 dB		
	source power $< -30$ dBm				
	40 GHz to 43.5 GHz	$\leq 4$ dB	0.5 dB		
	R&S®ZNB43, 2.92 mm interface				
	source power $\geq -30$ dBm				
	40 GHz to 43.5 GHz			0.5 dB	
	source power $< -30$ dBm				
	40 GHz to 43.5 GHz			0.5 dB	
Power resolution		0.01 dB			
Second harmonics at 0 dBm and harmonic frequency	R&S®ZNB4 and R&S®ZNB8				
	40 kHz to 200 MHz	$\leq -20$ dBc	-30 dBc		
	200 MHz to 8.5 GHz	$\leq -25$ dBc	-35 dBc		
	R&S®ZNB20				
	200 kHz to 20 MHz	$\leq -15$ dBc	-25 dBc		
	20 MHz to 200 MHz	$\leq -20$ dBc	-30 dBc		
	200 MHz to 20 GHz	$< -25$ dBc	-35 dBc		
	R&S®ZNB26				
	200 kHz to 20 MHz	$\leq -15$ dBc	-25 dBc		
	20 MHz to 200 MHz	$\leq -20$ dBc	-30 dBc		
	200 MHz to 20 GHz	$\leq -25$ dBc	-30 dBc		
	20 GHz to 26.5 GHz	$\leq -18$ dBc	-25 dBc		
	R&S®ZNB43				
	at 0 dBm				
	200 kHz to 20 MHz		-35 dBc		
	20 MHz to 200 MHz		-40 dBc		
	200 MHz to 2 GHz		-40 dBc		
	2 GHz to 16 GHz		-25 dBc		
	16 GHz to 30 GHz		-20 dBc		
	at -10 dBm				
	30 GHz to 36 GHz		-20 dBc		
	36 GHz to 40 GHz		-15 dBc		
	R&S®ZNB43, 2.4 mm interface				
	at -10 dBm				
	40 GHz to 43.5 GHz		-15 dBc		
	R&S®ZNB43, 2.92 mm interface				
	at -10 dBm				
	40 GHz to 43.5 GHz			-15 dBc	
	Third harmonics at 0 dBm and harmonic frequency	R&S®ZNB4 and R&S®ZNB8			
		60 kHz to 300 MHz	$\leq -20$ dBc	-30 dBc	
		300 MHz to 8.5 GHz	$\leq -25$ dBc	-35 dBc	
		R&S®ZNB20			
300 kHz to 30 MHz		$\leq -15$ dBc	-25 dBc		
30 MHz to 300 MHz		$\leq -20$ dBc	-30 dBc		
300 MHz to 20 GHz		$< -25$ dBc	-35 dBc		
R&S®ZNB26					
300 kHz to 30 MHz		$\leq -15$ dBc	-40 dBc		
30 MHz to 300 MHz		$\leq -20$ dBc	-40 dBc		
300 MHz to 26.5 GHz		$\leq -25$ dBc	-40 dBc		
R&S®ZNB43					
300 kHz to 30 MHz			-40 dBc		
30 MHz to 300 MHz			-45 dBc		
300 MHz to 3 GHz			-45 dBc		
3 GHz to 24 GHz			-35 dBc		
24 GHz to 40 GHz			-25 dBc		
R&S®ZNB43, 2.4 mm interface					
40 GHz to 43.5 GHz			-25 dBc		
R&S®ZNB43, 2.92 mm interface					
40 GHz to 43.5 GHz				-25 dBc	

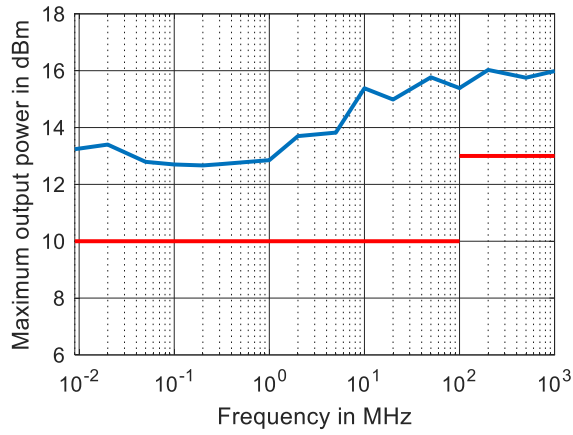

Typical maximum output power in dBm versus frequency of the R&S®ZNB8

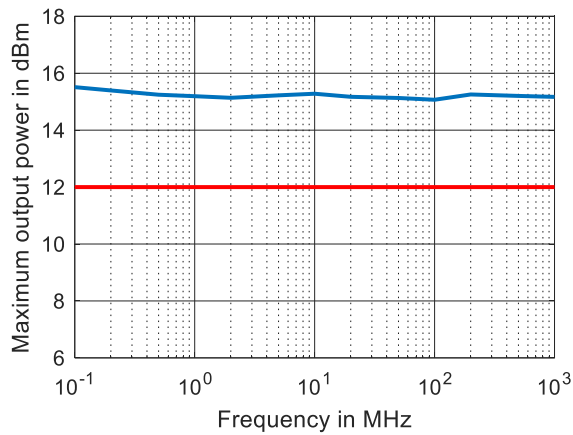
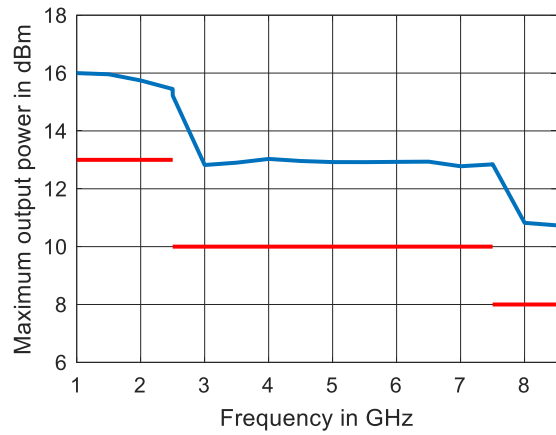

Typical maximum output power in dBm versus frequency of the R&S®ZNB20

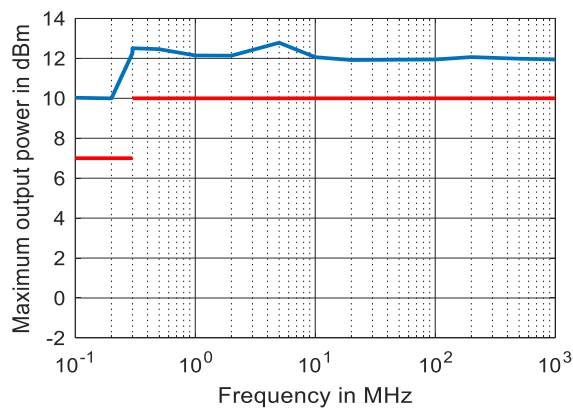
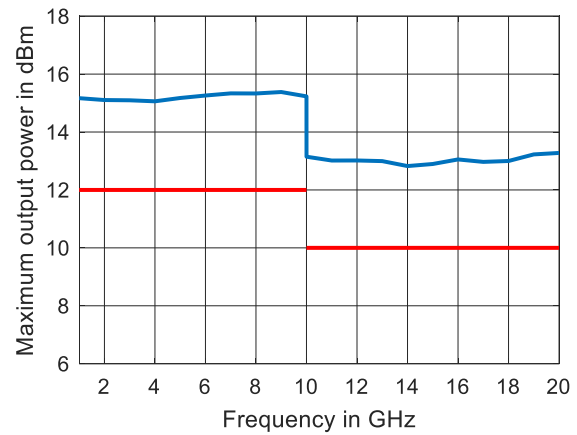

Typical maximum output power in dBm versus frequency of the R&S®ZNB26

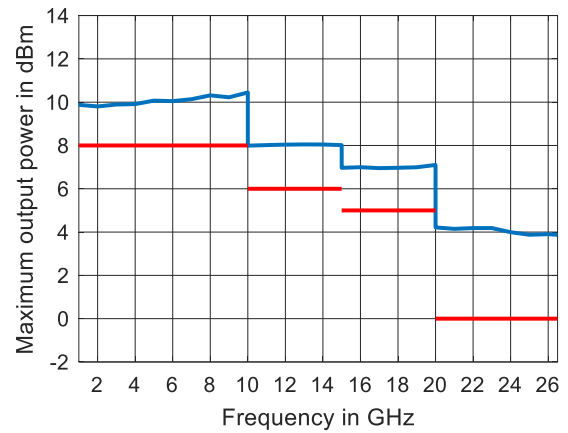

## Test port input

Parameter	Frequency range	Specification	Typical	Measured	Nominal
Match	R&S®ZNB4 and R&S®ZNB8				
	9 kHz to 50 kHz	> 10 dB			
	50 kHz to 8.5 GHz	> 20 dB			
	R&S®ZNB20				
	100 kHz to 1 MHz	> 16 dB			
	1 MHz to 100 MHz	> 20 dB			
	100 MHz to 10 GHz	> 12 dB			
	10 GHz to 20 GHz	> 10 dB			
	R&S®ZNB26 and R&S®ZNB43				
	100 kHz to 300 kHz	> 12 dB	15 dB		
	300 kHz to 10 MHz	> 15 dB	18 dB		
	10 MHz to 20 GHz	> 18 dB	20 dB		
	20 GHz to 40 GHz	> 15 dB	17 dB		
	R&S®ZNB43, 2.4 mm interface				
	40 GHz to 43.5 GHz	> 15 dB	17 dB		
R&S®ZNB43, 2.92 mm interface					
40 GHz to 43.5 GHz			17 dB		
Maximum nominal input level					+13 dBm
Power measurement accuracy at –10 dBm, without power calibration	R&S®ZNB4 and R&S®ZNB8				
	9 kHz to 100 kHz	< 2 dB			
	100 kHz to 8.5 GHz	< 1 dB			
	R&S®ZNB20				
	100 kHz to 10 GHz	< 1 dB	0.1 dB		
	10 GHz to 20 GHz	< 1 dB	0.4 dB		
	R&S®ZNB26 and R&S®ZNB43				
	100 kHz to 1 MHz	< 2 dB	0.5 dB		
	1 MHz to 20 GHz	< 1 dB	0.5 dB		
	20 GHz to 40 GHz	< 2 dB	0.8 dB		
	R&S®ZNB43, 2.4 mm interface				
	40 GHz to 43.5 GHz	< 3 dB <sup>8</sup>	1.0 dB		
	R&S®ZNB43, 2.92 mm interface				
	40 GHz to 43.5 GHz			1.0 dB	
	Compression at test port input, input level: > 0 dBm, referenced to –10 dBm	R&S®ZNB4 and R&S®ZNB8			
9 kHz to 8.5 GHz, 0 dBm to +8 dBm		< 0.2 dB			
9 kHz to 7.5 GHz, +8 dBm to +10 dBm		< 0.2 dB			
R&S®ZNB20					
100 kHz to 15 GHz, 0 dBm to +10 dBm		< 0.3 dB	0.1 dB		
15 GHz to 20 GHz, 0 dBm to +8 dBm		< 0.3 dB	0.1 dB		
R&S®ZNB26 and R&S®ZNB43 <sup>9</sup>					
100 kHz to 20 GHz, 0 dBm to +5 dBm		< 0.2 dB	0.1 dB		
R&S®ZNB4, R&S®ZNB8, R&S®ZNB20, R&S®ZNB26 and R&S®ZNB43 <sup>9</sup>					
9 kHz to 100 kHz, –50 dBm to 0 dBm	< 0.1 dB				
100 kHz to 40 GHz, –50 dBm to 0 dBm	< 0.1 dB	0.02 dB			
R&S®ZNB43, 2.4 mm interface <sup>9</sup>					
40 GHz to 43.5 GHz, –50 dBm to –3 dBm	< 0.1 dB	0.02 dB			
R&S®ZNB43, 2.92 mm interface <sup>9</sup>					
40 GHz to 43.5 GHz, –50 dBm to –3 dBm			0.02 dB		
Damage level		+27 dBm			
Damage DC voltage		30 V			

<sup>8</sup> This data is valid in the temperature range from +18 °C to +28 °C.

<sup>9</sup> For the R&S®ZNB43 (2.92 mm and 2.4 mm interfaces) the values are valid in the temperature range from +18 °C to +28 °C. Outside this range they have to be considered as nominal values.

Noise level <sup>10</sup> , at 1 kHz measurement bandwidth, normalized to 1 Hz	R&S®ZNB4 and R&S®ZNB8			
	9 kHz to 100 kHz	< -120 dBm	-130 dBm	
	100 kHz to 4 GHz	< -130 dBm	-140 dBm	
	4 GHz to 6.5 GHz	< -125 dBm	-138 dBm	
	6.5 GHz to 8.5 GHz	< -120 dBm	-132 dBm	
	R&S®ZNB20			
	100 kHz to 1 MHz	< -105 dBm	-115 dBm	
	1 MHz to 10 MHz	< -115 dBm	-120 dBm	
	10 MHz to 15 GHz	< -120 dBm	-125 dBm	
	15 GHz to 20 GHz	< -118 dBm	-130 dBm	
	R&S®ZNB26 and R&S®ZNB43			
	100 kHz to 300 kHz	< -110 dBm	-120 dBm	
	300 kHz to 1 MHz	< -115 dBm	-125 dBm	
	1 MHz to 5 GHz	< -120 dBm	-125 dBm	
	5 GHz to 20 GHz	< -118 dBm	-122 dBm	
	20 GHz to 30 GHz	< -115 dBm	-122 dBm	
	30 GHz to 35 GHz	< -110 dBm	-118 dBm	
	35 GHz to 40 GHz	< -105 dBm	-115 dBm	
	R&S®ZNB43, 2.4 mm interface			
	40 GHz to 43.5 GHz	< -95 dBm	-108 dBm	
R&S®ZNB43, 2.92 mm interface				
40 GHz to 43.5 GHz			-108 dBm	

<sup>10</sup> The noise level is defined as the RMS value of the specified noise floor. For different bandwidth add  $[10 \times \log_{10}(\text{bandwidth}/1 \text{ Hz})]$  to the given noise level.



## Additional front panel connectors

USB		4 ports, type A plug, version 2.0
-----	--	-----------------------------------

## Display

Screen		30.7 cm (12.1") diagonal WXGA, 18-bit color LCD with touchscreen
Resolution		1280 × 800 pixel, 125 dpi
Pixel failure rate		$< 1 \times 10^{-5}$

## Rear panel connectors

LAN		8-pin, RJ-45
-----	--	--------------

USB host		2 ports, type A plug, version 3.0
----------	--	-----------------------------------

USB device		1 port, type B plug, version 3.0
------------	--	----------------------------------

<b>REF IN</b>	input for external frequency reference signal	
Connector type		BNC, female
Input frequency range		1 MHz to 20 MHz, in steps of 1 MHz
Maximum permissible deviation		1 kHz
Input power		-10 dBm to +15 dBm
Input impedance		50 Ω

<b>REF OUT</b>	output for external frequency reference signal	
Connector type		BNC, female
Output frequency		10 MHz
Output power		+9 dBm ± 4 dB at 50 Ω

<b>Bias tee for the R&amp;S®ZNB26 and R&amp;S®ZNB43</b>		
Connector type		BNC, female
Maximum nominal input voltage		30 V
Maximum nominal input current		250 mA
Damage voltage		30 V
Damage current		400 mA

<b>External monitor</b>		
Connector types		HDMI™, DisplayPort

<b>USER CONTROL</b>	several control and trigger signals, 25-pin D-Sub, 3.3 V TTL, for controlling external generators, for limit checks, sweep signals, etc.	
CHANNEL BIT 0 to CHANNEL BIT 3	pin 8 to pin 11 (outputs)	channel-specific, user-configurable bits
CHANNEL BIT 4 to CHANNEL BIT 7	pin 16 to pin 19 (outputs)	channel-specific, user-configurable bits
DRIVE PORT 1 to DRIVE PORT 4	pin 16 to pin 19 (outputs)	indicates drive ports (can alternatively be used for channel bits 4 to 7)
PASS 1 and PASS 2	pin 13 and pin 14 (outputs)	pass/fail results of limit checks
BUSY	pin 4 (output)	measurements running
READY FOR TRIGGER	pin 6 (output)	ready for trigger
EXT GEN TRIGGER	pin 21 (output)	control signal for external generator
EXT GEN BLANK	pin 22 (input)	handshake signal from external generator
EXTERNAL TRIGGER	pin 2 (input)	first trigger input for analyzer, 5 V tolerant
EXTERNAL TRIGGER 2	pin 25 (input)	second trigger input for analyzer, 5 V tolerant

<b>EXT TRIG IN</b>	trigger input for analyzer	
Connector type		BNC, female
TTL signal (edge-triggered or level-triggered)		3 V, 5 V tolerant
Polarity (selectable)		positive or negative
Minimum pulse width		1 $\mu$ s
Input impedance		> 10 k $\Omega$

<b>EXT TRIG OUT</b>	trigger output of analyzer	
Connector type		BNC, female
Logic high		3.3 V (typ.)

# Options

## R&S®ZNB-B1

Bias tee for the R&S®ZNB4 and the R&S®ZNB8		
Connector type		BNC, female
Maximum nominal input voltage		30 V
Maximum nominal input current		400 mA
Damage voltage		30 V
Damage current		420 mA
Frequency range	R&S®ZNB4 with R&S®ZNB-B1 R&S®ZNB8 with R&S®ZNB-B1	100 kHz to 4.5 GHz 100 kHz to 8.5 GHz
Frequency response data		typical and specified data is valid for the limited frequency range given above

### Factory-calibrated system data

This data is valid between +18 °C and +28 °C. The data is based on a source power of –10 dBm and a measurement bandwidth of 1 kHz.

Parameter	Frequency range	Specification	Typical
Directivity	100 kHz to 4.5 GHz	≥ 30 dB	50 dB
	4.5 GHz to 8.5 GHz	≥ 30 dB	50 dB
Source match	100 kHz to 500 kHz	≥ 20 dB	30 dB
	500 kHz to 8.5 GHz	≥ 30 dB	50 dB
Reflection tracking	100 kHz to 8.5 GHz	≤ 0.5 dB	0.1 dB
Load match	100 kHz to 500 kHz	≥ 10 dB	15 dB
	500 kHz to 8.5 GHz	≥ 18 dB	25 dB
Transmission tracking	100 kHz to 8.5 GHz	≤ 0.5 dB	0.1 dB

## R&S®ZNB-B4

Static frequency accuracy		(time since last adjustment × aging rate) + temperature drift + calibration accuracy
Aging per year	with R&S®ZNB-B4 precision frequency reference option	$\pm 1 \times 10^{-7}$
Temperature drift (5 °C to +40 °C)	with R&S®ZNB-B4 precision frequency reference option	$\pm 1 \times 10^{-8}$
Achievable initial calibration accuracy	with R&S®ZNB-B4 precision frequency reference option	$\pm 5 \times 10^{-8}$

## R&S®ZNB-B10

<b>GPIO interface</b>		remote control interface in line with IEEE 488, IEC 60625; 24-pin
-----------------------	--	---

## R&S®ZNB-B12

Device control		
DIRECT CTRL interface		direct control bus output

## R&S®ZN-B14

<b>Handler I/O</b>	several control and trigger signals, 36-pin Centronics connector, TTL compatible, for controlling external devices, limit checks, sweep signals, etc.	
Keysight handler interface compatibility		type 3
Input signals	pin 2, pin 18	TTL compatible
Output signals	pin 3 to pin 17, pin 19 to pin 21, pin 30 to pin 34, pin 36	TTL compatible
Input/output signals	pin 22 to pin 29	TTL compatible
+5 V output	pin 35	+5 V, max. 100 mA
Response time of write strobe signal	pin 32	1 μs
Pulse width of write strobe signal	pin 32	1 μs
Pulse width of external trigger signal	pin 18	> 1 μs
Pulse width of sweep end signal	pin 34	> 10 μs

## R&S®ZNB4-B22/-B24, R&S®ZNB8-B22/-B24, R&S®ZNB20-B22/-B24, R&S®ZNB26-B22/-B24 and R&S®ZNB43-B22/-B24

Extended power range	Frequency range	Specification	Typical	Measured
Power range for the R&S®ZNB4 and the R&S®ZNB8	9 kHz to 100 MHz	-85 dBm to +10 dBm	up to +12 dBm	
	100 MHz to 2.5 GHz	-85 dBm to +13 dBm	up to +15 dBm	
	2.5 GHz to 7.5 GHz	-85 dBm to +10 dBm	up to +13 dBm	
	7.5 GHz to 8.5 GHz	-85 dBm to +8 dBm	up to +12 dBm	
Power range for the R&S®ZNB20	100 kHz to 10 GHz	-60 dBm to +12 dBm	up to +15 dBm	
	10 GHz to 20 GHz	-60 dBm to +10 dBm	up to +13 dBm	
Power range for the R&S®ZNB26 and the R&S®ZNB43	100 kHz to 300 kHz	-60 dBm to +7 dBm	up to +10 dBm	
	300 kHz to 1 GHz	-60 dBm to +10 dBm	up to +12 dBm	
	1 GHz to 10 GHz	-60 dBm to +8 dBm	up to +10 dBm	
	10 GHz to 15 GHz	-60 dBm to +6 dBm	up to +8 dBm	
	15 GHz to 20 GHz	-60 dBm to +5 dBm	up to +7 dBm	
	20 GHz to 30 GHz	-60 dBm to 0 dBm	up to +4 dBm	
30 GHz to 40 GHz	-60 dBm to -2 dBm	up to +2 dBm		
Power range for R&S®ZNB43, 2.4 mm interface	40 GHz to 43.5 GHz	-60 dBm to -3 dBm	up to +2 dBm	
Power range for R&S®ZNB43, 2.92 mm interface	40 GHz to 43.5 GHz			+2 dBm

## R&S®ZNB4-B31/-B32/-B33/-B34 and R&S®ZNB8-B31/-B32/-B33/-B34

Receiver step attenuators		
Frequency range	R&S®ZNB4-B31/-B32/-B33/-B34	9 kHz to 4.5 GHz
	R&S®ZNB8-B31/-B32/-B33/-B34	9 kHz to 8.5 GHz
Attenuation		0 dB to 30 dB, in 10 dB steps

## R&S®ZNB4-B52/-B54 and R&S®ZNB8-B52/-B54

Extended dynamic range	Frequency range	Specification	Typical
Power range, without optional extended power range	9 kHz to 100 kHz	-55 dBm to +8 dBm	
	100 kHz to 6.5 GHz	-55 dBm to +10 dBm	
	6.5 GHz to 7.5 GHz	-55 dBm to +8 dBm	
	7.5 GHz to 8.5 GHz	-55 dBm to +6 dBm	
Minimum power level using optional extended power range (see Options)	9 kHz to 8.5 GHz	-85 dBm	
Second and third harmonics at 0 dBm	20 kHz to 100 MHz	≤ -18 dBc	-30 dBc
	100 MHz to 8.5 GHz	≤ -25 dBc	-35 dBc
System dynamic range <sup>11</sup>	9 kHz to 50 MHz	≥ 130 dB	140 dB
	50 MHz to 6.5 GHz	≥ 140 dB	150 dB
	6.5 GHz to 8.5 GHz	≥ 130 dB	138 dB

Test port input		
Without system error correction	9 kHz to 50 kHz	≥ 10 dB
	50 kHz to 8.5 GHz	≥ 18 dB
Maximum nominal input level		+10 dBm
Compression at test port input, input level: > 0 dBm, referenced to -10 dBm	9 kHz to 7.5 GHz, 0 dBm to +8 dBm	≤ 0.2 dB
	7.5 GHz to 8.5 GHz, 0 dBm to +6 dBm	≤ 0.2 dB

<sup>11</sup> The dynamic range is defined as the difference between the actual maximum source power and the RMS value of the data trace of the transmission magnitude, which is produced by noise and crosstalk with the test ports short-circuited. The specification applies at 10 Hz measurement bandwidth, without system error correction. The dynamic range can be increased by using a measurement bandwidth of 1 Hz. Crosstalk does not limit the dynamic range. Dynamic range between port 1 and port 2 and between port 3 and port 4 (4-port model). Otherwise the dynamic range performance is typical.

Linearity at test port input, input level: -50 dBm to 0 dBm, referenced to -10 dBm	9 kHz to 8.5 GHz	≤ 0.1 dB
Noise level <sup>12</sup> , at 1 kHz measurement bandwidth, normalized to 1 Hz	9 kHz to 50 kHz	≤ -125 dBm (1 Hz)
	50 kHz to 50 MHz	≤ -130 dBm (1 Hz)
	50 MHz to 6.5 GHz	≤ -140 dBm (1 Hz)
	6.5 GHz to 8.5 GHz	≤ -130 dBm (1 Hz)

Trace stability		IF bandwidth	Specification	Typical
Trace noise magnitude (RMS), at 0 dBm source power, 0 dB reflection	9 kHz to 20 kHz	1 kHz	≤ 0.008 dB	0.004 dB
	20 kHz to 100 kHz	1 kHz	≤ 0.005 dB	0.001 dB
	100 kHz to 1 GHz	10 kHz	≤ 0.005 dB	0.001 dB
	1 GHz to 5 GHz	10 kHz	≤ 0.005 dB	0.002 dB
	5 GHz to 8.5 GHz	10 kHz	≤ 0.005 dB	0.003 dB

Measurement speed in ms with R&S®ZNB4-B52/-B54 or R&S®ZNB8-B52/-B54 option installed					
Typical sweep times versus number of measurement points, sweep mode: stepped					
Number of measurement points	51	201	401	1601	5001
800 MHz start frequency, 1 GHz stop frequency, AGC LOW DIST, 100 kHz measurement bandwidth					
With correction switched off	2.0	5	8	20	57
With 2-port TOSM calibration	3.5	9	13	40	113
With 4-port TOSM calibration	6.5	17	25	81	246
800 MHz start frequency, 1 GHz stop frequency, Memory AGC on, 100 kHz measurement bandwidth					
With correction switched off	3.5	10	16	55	170
With 2-port TOSM calibration	6	18	31	109	339
With 4-port TOSM calibration	10	35	61	225	701
100 kHz start frequency, 4.5 GHz stop frequency, AGC LOW DIST, 100 kHz measurement bandwidth					
With correction switched off	4.0	8	12	33	90
With 2-port TOSM calibration	7.5	14	22	65	180
With 4-port TOSM calibration	14	27	42	130	355
100 kHz start frequency, 4.5 GHz stop frequency, Memory AGC on, 100 kHz measurement bandwidth					
With correction switched off	6	12	21	69	205
With 2-port TOSM calibration	10	23	40	137	405
With 4-port TOSM calibration	19	45	79	273	810
100 kHz start frequency, 8.5 GHz stop frequency, AGC LOW DIST, 100 kHz measurement bandwidth					
With correction switched off	4.5	9	13	34	90
With 2-port TOSM calibration	8.5	17	25	67	180
With 4-port TOSM calibration	16	32	47	131	359
100 kHz start frequency, 8.5 GHz stop frequency, Memory AGC on, 100 kHz measurement bandwidth					
With correction switched off	6	13	22	70	205
With 2-port TOSM calibration	11	26	43	139	410
With 4-port TOSM calibration	21	50	84	280	815

**Note:** The R&S®ZNBx-B52/-B54 options cannot be combined with the R&S®ZNBx-B1 option and/or the R&S®ZNBx-B31/-B32/-B33/-B34 options.

## R&S®ZNB-B81

This data is valid in the temperature range from +18 °C to +28 °C and with a maximum measurement bandwidth of 10 kHz.

DC inputs		
Number of ports		4
Connector type		BNC, female
Voltage range		±20 V, ±3 V, ±0.3 V
Measurement accuracy	±20 V	2 % of reading ± 0.02 V
	±3 V	2 % of reading ± 0.002 V
	±0.3 V	2 % of reading ± 0.002 V
Input impedance		≥ 1 MΩ
Damage voltage		30 V

<sup>12</sup> The noise level is defined as the RMS value of the specified noise floor.

**R&S®ZNB-K980**

<b>Health and utilization monitoring service (HUMS)</b> <sup>13, 14</sup>		
Interfaces	protocols and interfaces supported for data readout and display	<ul style="list-style-type: none"> <li>• SNMP (v1, v2c, v3)</li> <li>• REST (JSON)</li> <li>• SCPI</li> <li>• device web</li> </ul>
Services	information provided	<ul style="list-style-type: none"> <li>• device information (model, serial number, BIOS, date, time, system, HUMS and software information)</li> <li>• user-defined information tags (e.g. for asset management)</li> <li>• equipment information (hardware, options, software, licenses)</li> <li>• system operating status</li> <li>• instrument security information</li> <li>• service related information (due dates etc.)</li> <li>• mass storage related information</li> <li>• instrument utilization data</li> <li>• device history (event log)</li> </ul>

<sup>13</sup> For details, see application note under: [www.rohde-schwarz.com/appnote/GFM336](http://www.rohde-schwarz.com/appnote/GFM336).

<sup>14</sup> For use with common available asset management tools.

## General data

Temperature loading		in line with IEC 60068-2-1 and IEC 60068-2-2
	operating temperature range	+5 °C to +40 °C
	storage temperature range	-20 °C to +60 °C
Damp heat		+40 °C at 85 % rel. humidity, in line with IEC 60068-2-30
Altitude	operating environment	max. 2000 m
	storage environment	max. 4500 m
Mechanical resistance	vibration, sinusoidal	5 Hz to 55 Hz, 0.15 mm amplitude constant, 55 Hz to 150 Hz, 0.5 g constant, in line with IEC 60068-2-6
	vibration, random	10 Hz to 300 Hz, acceleration 1.2 g (RMS) in line with IEC 60068-2-64
	shock	40 g shock spectrum, in line with MIL-STD-810E, method no. 516.4, procedure I
Calibration interval		1 year
EMC	RF emission	in line with CISPR 11/EN 55011 group 1 class A (for a shielded test setup); instrument complies with the emission requirements stipulated by EN 55011 and EN 61326-1 class A; this means that the instrument is suitable for use in industrial environments
	immunity	in line with EMC Directive 2014/30/EU including: IEC/EN 61326-1 (immunity test requirement for industrial environment, EN 61326 table 2), IEC/EN 61326-2-1, IEC/EN 61000-3-2, IEC/EN 61000-3-3
Safety		in line with IEC 61010-1, EN 61010-1 and UL 61010-1, CAN/CSA-C22.2 No.61010-1
Power supply		100 V to 240 V at 50 Hz to 60 Hz and 400 Hz, max. 5.5 A to 2.3 A respectively
Power consumption	R&S®ZNB4 and R&S®ZNB8, with 2 ports	max. 450 W, 120 W (typ.)
	R&S®ZNB4 and R&S®ZNB8, with 4 ports	max. 450 W, 170 W (typ.)
	R&S®ZNB20, R&S®ZNB26 and R&S®ZNB43, with 2 ports	max. 450 W, 130 W (typ.)
	R&S®ZNB20, R&S®ZNB26 and R&S®ZNB43, with 4 ports	max. 450 W, 215 W (typ.)
Test marks		VDE, cCSA <sub>US</sub> , KCC, CE
Dimensions	W × H × D	462.5 mm × 239.6 mm × 361.5 mm (18.2 in × 9.4 in × 14.2 in)
Weight	R&S®ZNB4, R&S®ZNB8, R&S®ZNB20, R&S®ZNB26 and R&S®ZNB43, with 2 ports	14 kg (30.9 lb)
	R&S®ZNB4, R&S®ZNB8, R&S®ZNB20, R&S®ZNB26 and R&S®ZNB43, with 4 ports	16 kg (35.3 lb)
Shipping weight	R&S®ZNB4, R&S®ZNB8, R&S®ZNB20, R&S®ZNB26 and R&S®ZNB43, with 2 ports	19 kg (41.9 lb)
	R&S®ZNB4, R&S®ZNB8, R&S®ZNB20, R&S®ZNB26 and R&S®ZNB43, with 4 ports	21 kg (46.3 lb)

## Dimensions (in mm)

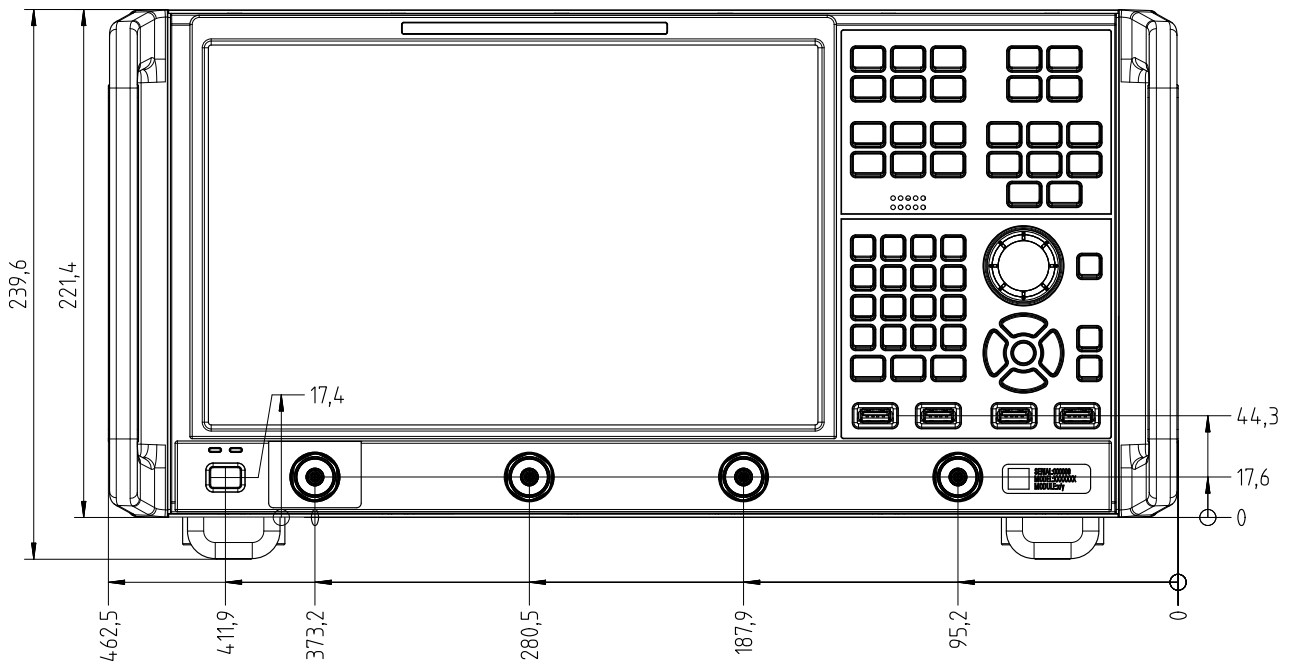

Front view of the R&S®ZNB

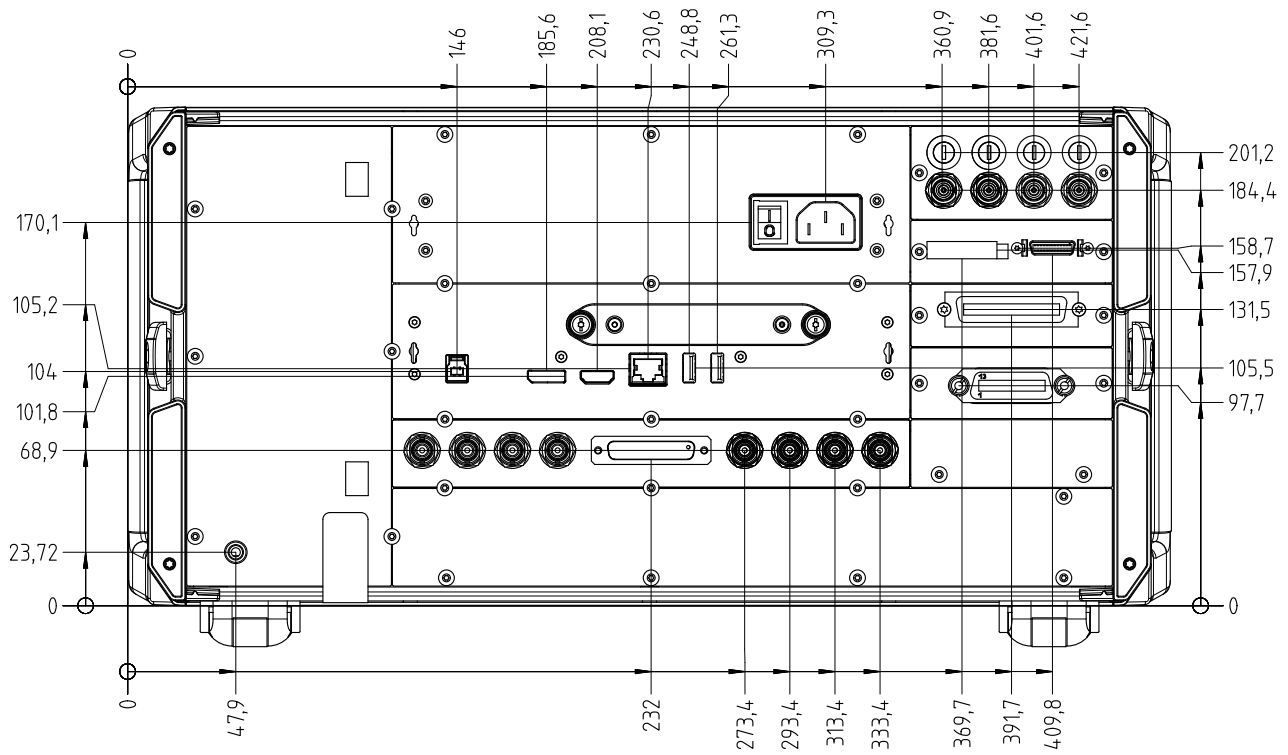

Rear view of the R&S®ZNB



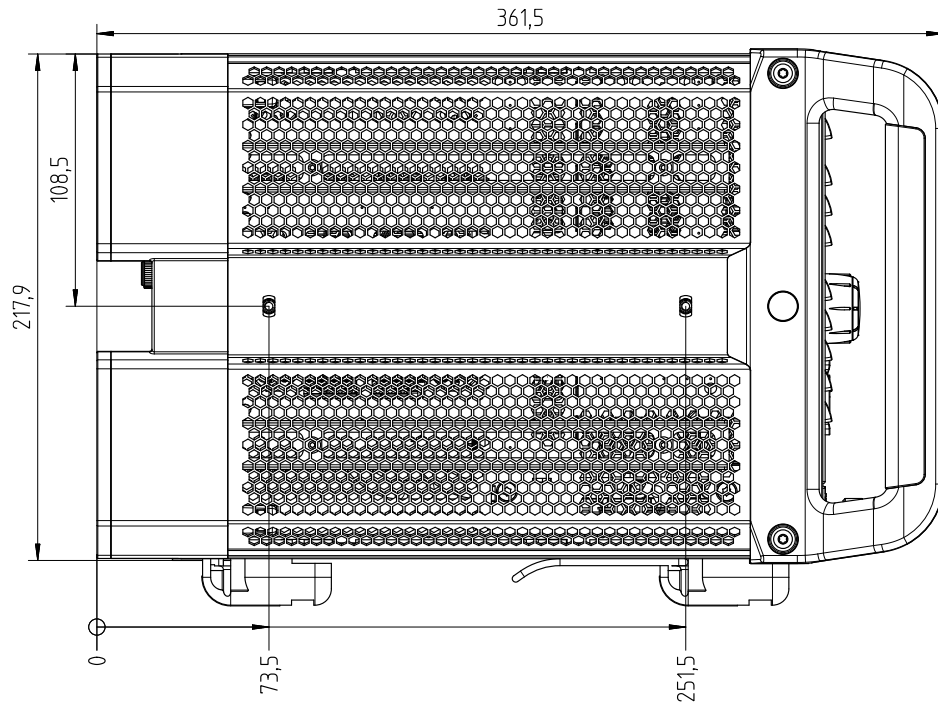

Side view of the R&S®ZNB

## Ordering information

Designation	Type	Retrofit <sup>15</sup>	On site <sup>16</sup>	Order No.
<b>Base unit</b>				
Vector network analyzer, 2 ports, 4.5 GHz, type N	R&S®ZNB4			1334.3330.22
Vector network analyzer, 4 ports, 4.5 GHz, type N	R&S®ZNB4			1334.3330.24
Vector network analyzer, 2 ports, 8.5 GHz, type N	R&S®ZNB8			1334.3330.42
Vector network analyzer, 4 ports, 8.5 GHz, type N	R&S®ZNB8			1334.3330.44
Vector network analyzer, 2 ports, 20 GHz, 3.5 mm	R&S®ZNB20			1334.3330.62
Vector network analyzer, 4 ports, 20 GHz, 3.5 mm	R&S®ZNB20			1334.3330.64
Vector network analyzer, 2 ports, 26.5 GHz, 2.92 mm	R&S®ZNB26			1334.3330.63
Vector network analyzer, 4 ports, 26.5 GHz, 2.92 mm	R&S®ZNB26			1334.3330.65
Vector network analyzer, 2 ports, 43.5 GHz, 2.92 mm	R&S®ZNB43			1334.3330.92
Vector network analyzer, 4 ports, 43.5 GHz, 2.92 mm	R&S®ZNB43			1334.3330.94
Vector network analyzer, 2 ports, 43.5 GHz, 2.4 mm	R&S®ZNB43			1334.3330.93
Vector network analyzer, 4 ports, 43.5 GHz, 2.4 mm	R&S®ZNB43			1334.3330.95
<b>Options</b>				
<b>Extended power range</b>				
Extended power range for 2-port R&S®ZNB4	R&S®ZNB4-B22	●		1316.0210.02
Extended power range for 4-port R&S®ZNB4	R&S®ZNB4-B24	●		1316.0233.02
Extended power range for 2-port R&S®ZNB8	R&S®ZNB8-B22	●		1316.0227.02
Extended power range for 4-port R&S®ZNB8	R&S®ZNB8-B24	●		1316.0240.02
Extended power range for 2-port R&S®ZNB20	R&S®ZNB20-B22	●		1317.8950.02
Extended power range for 4-port R&S®ZNB20	R&S®ZNB20-B24	●		1317.8967.02
Extended power range for 2-port R&S®ZNB26	R&S®ZNB26-B22	●		1350.5457.02
Extended power range for 4-port R&S®ZNB26	R&S®ZNB26-B24	●		1350.5463.02
Extended power range for 2-port R&S®ZNB43	R&S®ZNB43-B22	●		1334.4320.02
Extended power range for 4-port R&S®ZNB43	R&S®ZNB43-B24	●		1334.4337.02
<b>Receiver step attenuators</b>				
Receiver step attenuator, port 1, for R&S®ZNB4	R&S®ZNB4-B31	●		1316.0185.02
Receiver step attenuator, port 2, for R&S®ZNB4	R&S®ZNB4-B32	●		1316.0179.02
Receiver step attenuator, port 3, for R&S®ZNB4	R&S®ZNB4-B33	●		1316.0262.02
Receiver step attenuator, port 4, for R&S®ZNB4	R&S®ZNB4-B34	●		1316.0433.02
Receiver step attenuator, port 1, for R&S®ZNB8	R&S®ZNB8-B31	●		1316.0191.02
Receiver step attenuator, port 2, for R&S®ZNB8	R&S®ZNB8-B32	●		1316.0204.02
Receiver step attenuator, port 3, for R&S®ZNB8	R&S®ZNB8-B33	●		1316.0162.02
Receiver step attenuator, port 4, for R&S®ZNB8	R&S®ZNB8-B34	●		1316.0440.02
<b>Extended dynamic range <sup>17</sup></b>				
Extended dynamic range for 2-port R&S®ZNB4	R&S®ZNB4-B52			1319.4975.02
Extended dynamic range for 4-port R&S®ZNB4	R&S®ZNB4-B54			1319.4981.02
Extended dynamic range for 2-port R&S®ZNB8	R&S®ZNB8-B52			1319.4998.02
Extended dynamic range for 4-port R&S®ZNB8	R&S®ZNB8-B54			1319.5007.02
Bias tees for R&S®ZNB4 and R&S®ZNB8 with 2 ports	R&S®ZNB-B1			1316.1700.02
Bias tees for R&S®ZNB4 and R&S®ZNB8 with 4 ports	R&S®ZNB-B1			1316.1700.04
Second internal generator for 4-port R&S®ZNB4 and 4-port R&S®ZNB8	R&S®ZNB-B2	●		1317.7954.02
Second internal generator for 4-port R&S®ZNB20	R&S®ZNB20-B2	●		1317.8980.02
Second internal generator for 4-port R&S®ZNB26	R&S®ZNB26-B2	●		1350.5470.02
Second internal generator for 4-port R&S®ZNB43	R&S®ZNB43-B2	●		1334.4343.02
Precision frequency reference (OCXO)	R&S®ZNB-B4	●		1316.1769.02
GPIB interface	R&S®ZNB-B10	●	●	1311.5995.04
Device control	R&S®ZNB-B12	●	●	1319.5088.02
Direct control cable	R&S®ZN-B121	●	●	1323.9290.00
Handler I/O	R&S®ZN-B14	●	●	1316.2459.05
RFFE GPIO interface (external)	R&S®ZN-Z15	●	●	1325.5905.02
RFFE GPIO interface (external), including voltage/current measurement	R&S®ZN-Z15	●	●	1325.5905.03
Additional removable SSD, 512 Gbyte, Windows 10 for IPS14	R&S®ZNB-B19	●	●	1334.3860.02
DC inputs	R&S®ZNB-B81	●		1316.0004.02
Time domain analysis	R&S®ZNB-K2	●	●	1316.0156.02
Extended time domain analysis	R&S®ZNB-K20	●	●	1326.8072.02

<sup>15</sup> Option may also be ordered at a later stage, upgrade in service.

<sup>16</sup> Option may be installed by the user on site.

<sup>17</sup> The R&S®ZNBx-B52/-B54 options cannot be combined with the R&S®ZNBx-B1 option and/or the R&S®ZNBx-B31/-B32/-B33/-B34 options.

Designation	Type	Retrofit <sup>15</sup>	On site <sup>16</sup>	Order No.
Distance to fault	R&S®ZNB-K3	●	●	1350.5057.02
Frequency conversion	R&S®ZNB-K4	●	●	1316.2994.02
Intermodulation measurements <sup>18</sup>	R&S®ZNB-K14	●	●	1317.8373.02
10 MHz receiver bandwidth	R&S®ZNB-K17	●	●	1316.1881.02
1 mHz frequency resolution	R&S®ZNB-K19	●	●	1317.8573.02
Real-time measurement uncertainty analysis	R&S®ZNB-K50	●	●	3644.5977.02
Real-time measurement uncertainty analysis, preinstalled	R&S®ZNB-K50P			1338.1810.02
EaZy deembedding (EZD)	R&S®ZNB-K210	●	●	1328.8592.02
In-situ deembedding (ISD)	R&S®ZNB-K220	●		1328.8605.02
Smart fixture deembedding (SFD)	R&S®ZNB-K230	●		1328.8611.02
Delta-L PCB characterization	R&S®ZNB-K231	●		1328.8628.02
Health and utilization monitoring service (HUMS)	R&S®ZNB-K980	●	●	1350.5305.02
19" rackmount kit	R&S®ZZA-KN5	●	●	1175.3040.00

Designation	Type	Order No.
<b>Recommended accessories</b>		
Calibration kits for manual calibration – economy		
Calibration kit, 0 Hz to 18 GHz, N (f)	R&S®ZN-Z170	1328.8163.03
Calibration kit, 0 Hz to 26.5 GHz, 3.5 mm (f)	R&S®ZN-Z135	1328.8157.03
Calibration kit, 0 Hz to 40 GHz, 2.92 mm (f)	R&S®ZN-Z129	1328.8140.03
Calibration kit, 0 Hz to 43.5 GHz, 2.92 mm (f)	R&S®ZN-Z129E	1328.8170.03
Calibration kits for manual calibration – high-end		
Calibration kit, 0 Hz to 18 GHz, N, 50 Ω	R&S®ZV-Z270	5011.6536.02
Calibration kit, 0 Hz to 26.5 GHz, 3.5 mm	R&S®ZN-Z235	1336.8500.02
Calibration kit, 0 Hz to 43.5 GHz, 2.92 mm	R&S®ZN-Z229	1336.7004.02
Calibration kit, 0 Hz to 50 GHz, 2.4 mm	R&S®ZN-Z224	1339.5002.02
Calibration units for automatic calibration – economy		
Calibration unit, 100 kHz to 8.5 GHz, 2 ports, SMA (f)	R&S®ZN-Z151	1317.9134.32
Calibration unit, 100 kHz to 8.5 GHz, 2 ports, N (f)	R&S®ZN-Z151	1317.9134.72
Calibration unit, 100 kHz to 8.5 GHz, 4 ports, SMA (f)	R&S®ZN-Z153	1319.6178.34
Calibration unit, 100 kHz to 8.5 GHz, 6 ports, SMA (f)	R&S®ZN-Z152	1319.6003.36
Calibration unit, 100 kHz to 8.5 GHz, 6 ports, SMA (f)	R&S®ZN-Z154	1319.5120.02
Additional ports 7 to 12, SMA (f)	R&S®ZNZ154-B22	1319.5136.22
Additional ports 13 to 18, SMA (f)	R&S®ZNZ154-B32	1319.5136.32
Additional ports 19 to 24, SMA (f)	R&S®ZNZ154-B42	1319.5136.42
Calibration units for automatic calibration – high-end		
Calibration unit, 100 kHz to 8.5 GHz, 2 ports, N (f)	R&S®ZN-Z51	1319.5507.72
Calibration unit, 100 kHz to 8.5 GHz, 4 ports, N (f)	R&S®ZN-Z51	1319.5507.74
Calibration unit, 100 kHz to 8.5 GHz, 2 ports, 3.5 mm (f)	R&S®ZN-Z51	1319.5507.32
Calibration unit, 100 kHz to 8.5 GHz, 4 ports, 3.5 mm (f)	R&S®ZN-Z51	1319.5507.34
Calibration unit, 9 kHz to 9 GHz, 2 ports, 3.5 mm (f)	R&S®ZN-Z50	1335.6904.30
Calibration unit, 9 kHz to 26.5 GHz, 2 ports, 3.5 mm (f)	R&S®ZN-Z50	1335.6904.32
Calibration unit, 100 kHz to 26.5 GHz, 4 ports, 3.5 mm (f)	R&S®ZN-Z52	1335.6991.30
Calibration unit, 100 kHz to 26.5 GHz, 2 ports, 3.5 mm (f)	R&S®ZN-Z53	1335.7046.32
Calibration unit, 100 kHz to 18 GHz, 2 ports, N (f)	R&S®ZN-Z53	1335.7046.72
Calibration unit, 9 kHz to 40 GHz, 2 ports, 2.92 mm (f), characterized to 43.5 GHz	R&S®ZN-Z54	1335.7117.92
Calibration unit, 9 kHz to 50 GHz, 2 ports, 2.4 mm (f)	R&S®ZN-Z55	1335.7181.42
Inline calibration units for automatic calibration		
CAN bus controller for inline calibration units	R&S®ZN-Z30	1328.7609.02
Inline calibration unit, 10 MHz to 8.5 GHz	R&S®ZN-Z32	1328.7638.02
Inline calibration unit, 10 MHz to 40 GHz, characterized to 43.5 GHz	R&S®ZN-Z33	1328.7644.02
Inline calibration unit, 10 MHz to 40 GHz, for TVAC, characterized to 43.5 GHz	R&S®ZN-Z33	1328.7644.03

<sup>18</sup> The R&S®ZNB-K14 requires R&S®ZNB-K4.

<b>Switch matrices</b>		
Switch matrix, 10 MHz to 8.5 GHz, 2 VNA ports in 6 ports, base unit, SMA (f)	R&S®ZN-Z84	1319.4500.02
Additional ports 7 to 12, 2 VNA ports	R&S®ZN-Z84-B22	1319.4969.22
Additional ports 13 to 18, 2 VNA ports	R&S®ZN-Z84-B32	1319.4969.32
Additional ports 19 to 24, 2 VNA ports	R&S®ZN-Z84-B42	1319.4969.42
Additional ports 7 to 12, 4 VNA ports	R&S®ZN-Z84-B24	1319.4969.24
Additional ports 13 to 18, 4 VNA ports	R&S®ZN-Z84-B34	1319.4969.34
Additional ports 19 to 24, 4 VNA ports	R&S®ZN-Z84-B44	1319.4969.44
Switch matrix, 10 MHz to 20 GHz, 2 VNA-ports in 6 ports, base unit, SMA (f)	R&S®ZN-Z85	1326.4777.03
Additional ports 7 to 12, 4 VNA ports	R&S®ZN-Z85-B24	1326.4831.26
<b>Test cables</b>		
0 Hz to 18 GHz, N (m) to N (m), 50 Ω, length: 0.6 m/1 m	R&S®ZV-Z91	1301.7572.25/.38
0 Hz to 18 GHz, N (m) to N (m), 50 Ω, length: 0.6 m/0.9 m	R&S®ZV-Z191	1306.4507.24/.36
0 Hz to 18 GHz, N (m) to 3.5 mm (m), 50 Ω, length: 0.6 m/1 m	R&S®ZV-Z92	1301.7589.25/.38
0 Hz to 18 GHz, N (m) to 3.5 mm (m), 50 Ω, length: 0.6 m/0.9 m	R&S®ZV-Z192	1306.4513.24/.36
0 Hz to 26.5 GHz, 3.5 mm (f) to 3.5 mm (m), length: 0.6 m/1 m	R&S®ZV-Z93	1301.7595.25/.38
0 Hz to 26.5 GHz, 3.5 mm (f) to 3.5 mm (m), length: 0.6 m/0.9 m/1.5 m	R&S®ZV-Z193	1306.4520.24/.36/ .60
0 Hz to 40 GHz, 2.92 mm (f) to 2.92 mm (m), length: 0.6 m/1.0 m	R&S®ZV-Z95	1301.7608.25/.38
0 Hz to 40 GHz, 2.92 mm (f) to 2.92 mm (m), length: 0.6 m/0.9 m	R&S®ZV-Z195	1306.4536.24/.36
0 Hz to 50 GHz, 2.4 mm (f) to 2.4 mm (m), length: 0.6 m	R&S®ZV-Z97	1301.7637.25

<b>Warranty</b>		
Base unit		3 years
All other items <sup>19</sup>		1 year
<b>Service options</b>		
Extended warranty, one year	R&S®WE1	Please contact your local Rohde & Schwarz sales office.
Extended warranty, two years	R&S®WE2	
Extended warranty with calibration coverage, one year	R&S®CW1	
Extended warranty with calibration coverage, two years	R&S®CW2	
Extended warranty with accredited calibration coverage, one year	R&S®AW1	
Extended warranty with accredited calibration coverage, two years	R&S®AW2	

#### **Extended warranty with a term of one and two years (WE1 and WE2)**

Repairs carried out during the contract term are free of charge <sup>20</sup>. Necessary calibration and adjustments carried out during repairs are also covered.

#### **Extended warranty with calibration coverage (CW1 and CW2)**

Enhance your extended warranty by adding calibration coverage at a package price. This package ensures that your Rohde & Schwarz product is regularly calibrated, inspected and maintained during the term of the contract. It includes all repairs <sup>20</sup> and calibration at the recommended intervals as well as any calibration carried out during repairs or option upgrades.

#### **Extended warranty with accredited calibration (AW1 and AW2)**

Enhance your extended warranty by adding accredited calibration coverage at a package price. This package ensures that your Rohde & Schwarz product is regularly calibrated under accreditation, inspected and maintained during the term of the contract. It includes all repairs <sup>20</sup> and accredited calibration at the recommended intervals as well as any accredited calibration carried out during repairs or option upgrades.

The terms HDMI and HDMI High-Definition Multimedia Interface, and the HDMI Logo are trademarks or registered trademarks of HDMI Licensing, LLC in the United States and other countries.

<sup>19</sup> For options that are installed, the remaining base unit warranty applies if longer than 1 year. Exception: all batteries have a 1 year warranty.

<sup>20</sup> Excluding defects caused by incorrect operation or handling and force majeure. Wear-and-tear parts are not included.





## Service that adds value

- ▶ Worldwide
- ▶ Local and personalized
- ▶ Customized and flexible
- ▶ Uncompromising quality
- ▶ Long-term dependability

## Rohde & Schwarz

The Rohde&Schwarz technology group is among the trailblazers when it comes to paving the way for a safer and connected world with its leading solutions in test & measurement, technology systems and networks & cybersecurity. Founded more than 85 years ago, the group is a reliable partner for industry and government customers around the globe. The independent company is headquartered in Munich, Germany and has an extensive sales and service network with locations in more than 70 countries.

[www.rohde-schwarz.com](http://www.rohde-schwarz.com)

## Sustainable product design

- ▶ Environmental compatibility and eco-footprint
- ▶ Energy efficiency and low emissions
- ▶ Longevity and optimized total cost of ownership

Certified Quality Management  
**ISO 9001**

Certified Environmental Management  
**ISO 14001**

## Rohde & Schwarz training

[www.training.rohde-schwarz.com](http://www.training.rohde-schwarz.com)

## Rohde & Schwarz customer support

[www.rohde-schwarz.com/support](http://www.rohde-schwarz.com/support)

