

# Power Meters and Power Sensors

High Performance Solutions for Peak and Average Power Measurements



# Introducing Keysight Power Meters and Sensors

## Reliable, high-performing solutions

Every power meter and sensor from Keysight Technologies, Inc. consistently delivers great results.

## One specific application: One right solution

Keysight offers a wide selection of power meters and sensors for practically all application needs—wireless communications, radar pulse measurements, component test and more.

## A sure investment for many years to come

Code-compatibility between power meters reduces the need for re-coding. Not only that, all Keysight power meters are backward-compatible with most legacy power sensors.

## Global network support

No matter where you are, Keysight is committed to giving you the 24-hour support you need regarding our products, applications or services.

## Table of Contents

Peak Power Measurements and Analysis For Faster Measurement Speed and Greater Measurement Accuracy	03
Peak Power Measurements and Analysis For Wireless Applications and High Test Throughput	06
Peak and Average Power Measurements and Analysis For Radar and Wireless Applications	09
Peak and Average Power Measurements For Compact ATE Systems	12
Peak and Average Power Measurements For Effective Capture of Wireless and Radar Signals	14
Peak and Average Power Measurements For Testing of Wireless Signals	18
Average Power Measurements For Metrology and Calibration Laboratories	21
Average Power Measurements For Flexible Testing: On the Rack and On the Go	22
Average Power Measurements For Mobile Testing that's Plug-and-Play Easy	23
Average Power Measurements For Broadband Applications	26
Average Power Measurements For mmWave applications	28
Average Power Measurements For Portable RF Measurements	29
Power Measurement Software for Simplified Data Capture	30
Power Meters Selection Chart	32
Power Sensors Selection Chart	33
Power Meters and Sensors Compatibility Table	34
Free Power Measurement Hints and Tips	36
Related Keysight Literature	36
Watch a Live Demonstration or Video Introduction	36

# Peak Power Measurements and Analysis For Faster Measurement Speed and Greater Measurement Accuracy

## Keysight 8990B peak power analyzer

The 8990B peak power analyzer comes with two RF channels and two oscilloscope channels and, when used with a compatible power sensor, measures the dynamic time-dependent aspects of RF and microwave power. Combined with the N1923A/N1924A wideband power sensors, the 8990B achieves 5 nano seconds RF pulse rise time/fall time. The 8990B provides internal and external trigger functions and the peak power analyzer's video input allows for the simultaneous analysis of time-domain control signals.

Designed with both ease of use and high performance in mind, the 8990B peak power analyzer does more than just measure and analyze – it saves you time and effort, letting you focus on the important details.

## Features

### Models

- 8990B peak power analyzer

### Specifications

- 160 MHz video bandwidth
- 100 Msamples/s continuous sampling rate

### Measurement type

- Peak, average, peak-to-average ratio power measurements
- CCDF statistical analysis in graphical and tabular formats
- Rise time, fall time, pulse width, duty cycle, PRI and PRF
- Automated delay measurement, automated droop measurement, pulse spacing measurement
- Multi-pulse analysis (with option 8990B-1FP or N6903A)
- Power-added efficiency (PAE) measurement

### Calibration

- Calibration and correction factors in EEPROM (N1923A/N1924A wideband power sensors and P-Series power sensors)
- Internal zeroing and calibration (N1923A/N1924A wideband power sensors and P-Series power sensors)

### Remote programmability

- SCPI standard interface command
- LAN and USB interfaces
- GPIB (with N4865A GPIB to LAN adapter)

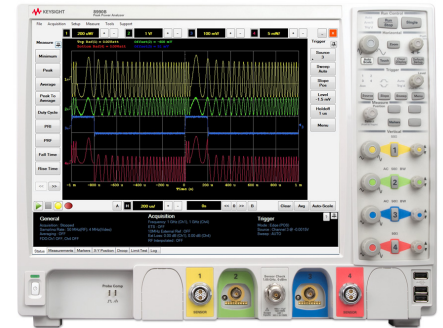

## Highlights

- Measurement system with 5 ns rise and fall times allows accurate pulse analysis
- Set, trigger and measure pulse measurements easily
- Perform accurate and more detailed pulse measurements, faster
- Verify design problems quickly with a 15-inch XGA color display
- Compatible with U2000 Series USB power sensors for additional channels

# Peak Power Measurements and Analysis For Faster Measurement Speed and Greater Measurement Accuracy (continued)

## Delay measurement

Perform delay measurements by pressing the Delay Measurement button on the soft panel key and two vertical markers will automatically detect the first pulse of the traces. The time delay between the two traces will be displayed in the measurement panel below the graphical window.

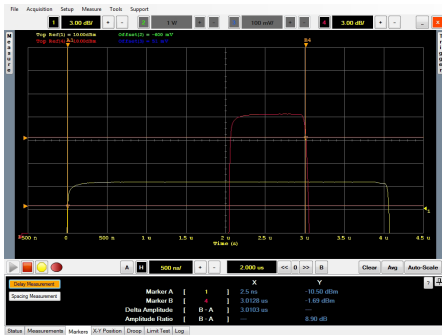

## Droop measurement

The 8990B is the first peak power analyzer on the market to offer automated Pulse Droop measurement, which measures the amplitude degradation of the pulse top. This eliminates the need to manually manipulate the horizontal markers to make this measurement. Access the Pulse Droop measurement via the soft panel key.

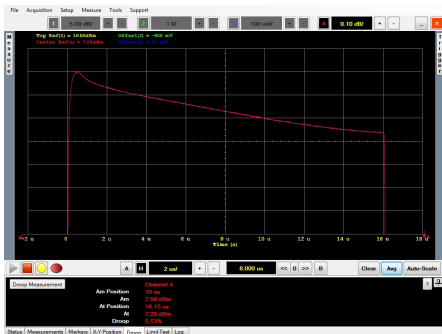

## Multi-pulse measurement

The multi-pulse measurement feature adds pulse-to-pulse measurement and histogram graph capabilities to the 8990B, and allows users to continuously trigger and capture up to 512 pulses. Additionally, users can use the multi-pulse feature to analyze short pulses with long off-times or the amplitude droop across the pulse train.

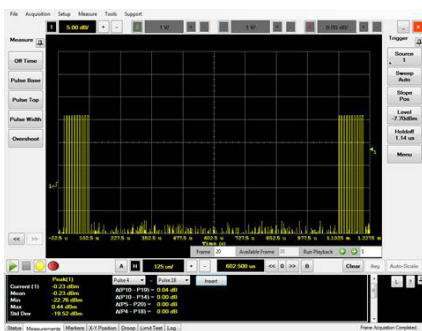

# Peak Power Measurements and Analysis For Faster Measurement Speed and Greater Measurement Accuracy (continued)

## Power-added efficiency math function

Calculate the power-added efficiency (PAE) of power amplifiers and display instant PAE traces onscreen with the 8990B. The peak power analyzer's two RF input channels allow users to measure the RF power gain from the power amplifier; using a DC current probe, scope probe or differential probe, they can also measure the power amplifier's voltage and current through the analog video input channels. The 8990B's PAE math function then uses these measurements to easily determine the PAE percentage of the power amplifier.

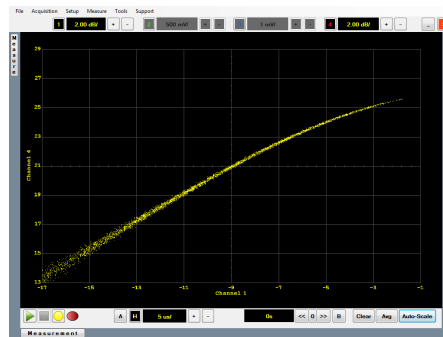
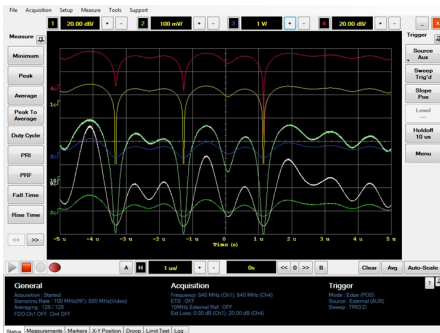

# Peak Power Measurements and Analysis For Wireless Applications and High Test Throughput

## Keysight U2040 X-Series Wide Dynamic Range Power Sensors

Accurately measure any modulated signal with the U2040 X-Series power sensors. With LAN or USB connectivity, the U2040 X-Series comes with the world's widest dynamic range in a power sensor, covering a range of -70 to +26 dBm. The U2049XA LAN power sensor comes with a thermal vacuum option, and it gives the same accuracy and performance even in thermal vacuum chambers.

### Features

#### Models

- U2041XA USB wide dynamic range average power sensor (10 MHz to 6 GHz; -70 dBm to +26 dBm)
- U2042XA USB peak and average power sensor (10 MHz to 6 GHz; -70 dBm to +26 dBm)
- U2043XA USB wide dynamic range average power sensor (10 MHz to 18 GHz; -70 dBm to +26 dBm)
- U2044XA USB peak and average power sensor (10 MHz to 18 GHz; -70 dBm to +26 dBm)
- U2049XA LAN wide dynamic range power sensor (10 MHz to 6/33 GHz; -70 dBm to +20 dBm)



#### Specifications

- Measurement speed: 50,000 readings/second (fast/buffered mode)
- Sampling rate: 20 MSamples/second

#### Measurement type

- Peak, min, average, and peak-to-average ratio power measurements
- Time-gated and free-run measurement modes
- Automatic rise time, fall time, pulse width, pulse period, duty cycle, time to positive occurrence, and time to negative occurrence time measurements

#### Calibration

- Internal zeroing and calibration

#### Remote programmability

- SCPI standard interface commands

### Highlights

- The world's widest dynamic range in a power sensor, spanning -70 to +26 dBm
- Fast measurement speed at 50,000 readings/second (fast/buffered mode)
- Average mode time selectivity feature allows the sensor to make both average and time-gated average measurements across the full 96 dB range
- Capture and analyze measurements with the intuitive BenchVue software
- Thermal vacuum option for LAN sensor

# Peak Power Measurements and Analysis For Wireless Applications and High Test Throughput (continued)

## Typical test setup for wireless chipset manufacturing test

Three power sensors are used to measure the chipset's input power, output power, and reflected power. A spectrum analyzer, like the Keysight Technologies MXA, is used to measure other critical parameters such as ACPR, EVM, and harmonics. Care should be taken to ensure that the power to be measured does not exceed the sensor's measurable power range in order to avoid damaging the sensor, particularly at the power amplifier's output. Depending on the signal formats, a trigger output signal from the signal source can be connected to the trigger input ports of the power sensors in order to synchronize the signal timing and sensors' measurement acquisitions.

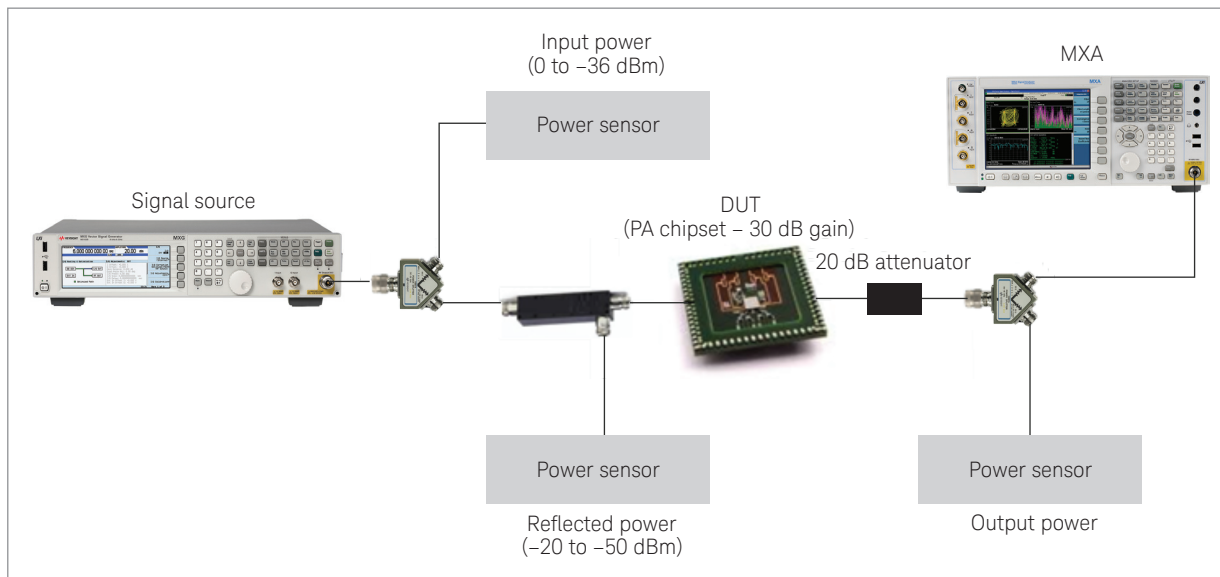

Wireless manufacturing setup

## Average mode time-selective measurement

The average mode time-selectivity feature allows you to precisely select when a measurement is made. A measurement aperture is used to define the duration of the measurement and its position in time can be set relative to a trigger. The aperture duration can be set from 20  $\mu$ s to 200 ms with a resolution of 100 ns to be able to cover any radio format. Giving you similar ability to define a measurement as time-gated power measurements in peak mode, this function allows you to control which portion of the waveform is measured, and perform precise time-selective average power measurements across the full 96 dB dynamic range, and real time measurements of up to 50,000 readings per second.

## Peak Power Measurements and Analysis For Wireless Applications and High Test Throughput (continued)

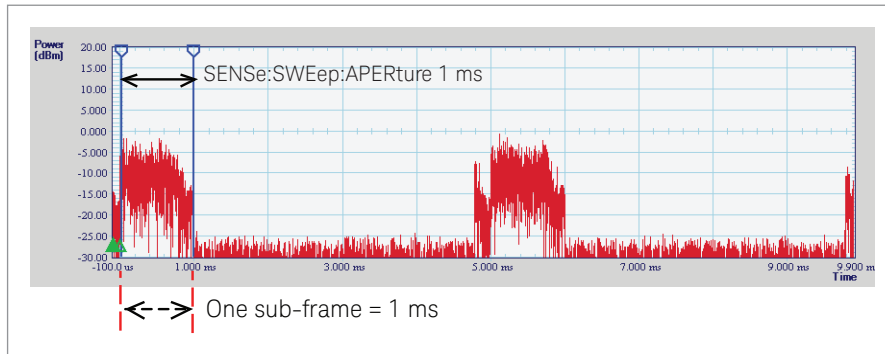

Measurement results for one 1 ms LTE sub-frame using burst average power setting.

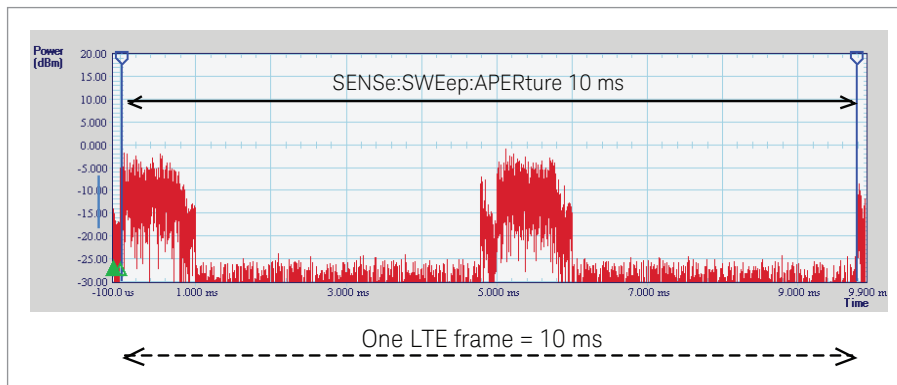

Measurement of one LTE frame over 10 ms using waveform average power setting.

### U2040 X-Series sensor settings for wireless tests

In order to achieve the most accurate and fastest measurements, the U2040 X-Series can be configured into different modes based on the signal formats. The following table lists the common wireless signal formats and the recommended sensor settings.

Type of measurement	Signals	Recommend sensor settings
Burst average power for signals with burst/frame structure	LTE-TDD, GSM, EDGE, WLAN	Average mode time-selectivity
Waveform average power for signals with burst/frame structure	LTE-TDD, GSM, EDGE, WLAN	Average mode time-selectivity
Waveform average power for continuous modulated signals	W-CDMA, LTE-FDD	Free run, fast mode
Time slotted signals without external trigger signals	GSM, EDGE	Normal mode time-gated power measurement
Time slotted signals with external trigger signals	GSM, EDGE	Normal mode time-gated power measurement, or Average mode time-selectivity



# Peak and Average Power Measurements and Analysis For Radar and Wireless Applications

## Keysight U2020 X-Series USB peak and average power sensors

The U2021XA and U2022XA X-Series USB peak power sensors are designed to carry out high speed peak and average power measurements. These sensors offer a fast measurement speed of > 25000 readings/second and a wide peak power dynamic range of -30 dBm to +20 dBm, providing the peak power measurement capability of a power meter in a compact, portable form.

### Features

#### Models

- U2021XA X-series USB peak and average power sensor (50 MHz to 18 GHz; -35 dBm to +20 dBm)
- U2022XA X-series USB peak and average power sensor (50 MHz to 40 GHz; -35 dBm to +20 dBm)

#### Specifications

- 30 MHz video bandwidth
- > 25,000 readings/s measurement speed (in buffer mode)
- Frequency range of 50 MHz to 18 GHz/40 GHz

#### Measurement type

- Peak, min, average, and peak-to-average ratio power measurements
- Time-gated and free-run measurement modes
- Automatic rise time, fall time, pulse width, pulse period, duty cycle, time to positive occurrence, and time to negative occurrence time measurements
- CCDF statistical analysis

#### Calibration

- Internal zeroing and calibration

#### Remote programmability

- USB interface



### Highlights

- Fast measurement speed of > 25,000 readings/second (in buffer mode)
- Wide peak power range of 50 dB, ranging from -30 dBm to +20 dBm
- Fast rise/fall time of down to 13 nano seconds and a video bandwidth of 30 MHz
- Standalone peak power measurement capability without the need of a power meter
- Built-in trigger in/trigger out function
- Built-in radar and wireless presets

# Peak and Average Power Measurements and Analysis For Radar and Wireless Applications (continued)

## High throughput wireless test systems with up to 20 channels

The U2020 X-series USB peak and average sensors perform fast and accurate peak and gated power measurements. These measurements are essential aspects of the production tests conducted for wireless signals used in cellular/mobile phone handset, wireless chipset and amplifier applications. With plug-and-play USB connectivity, high measurement speed and multichannel capability, setting up a high throughput test system is simple, fast and cost effective.

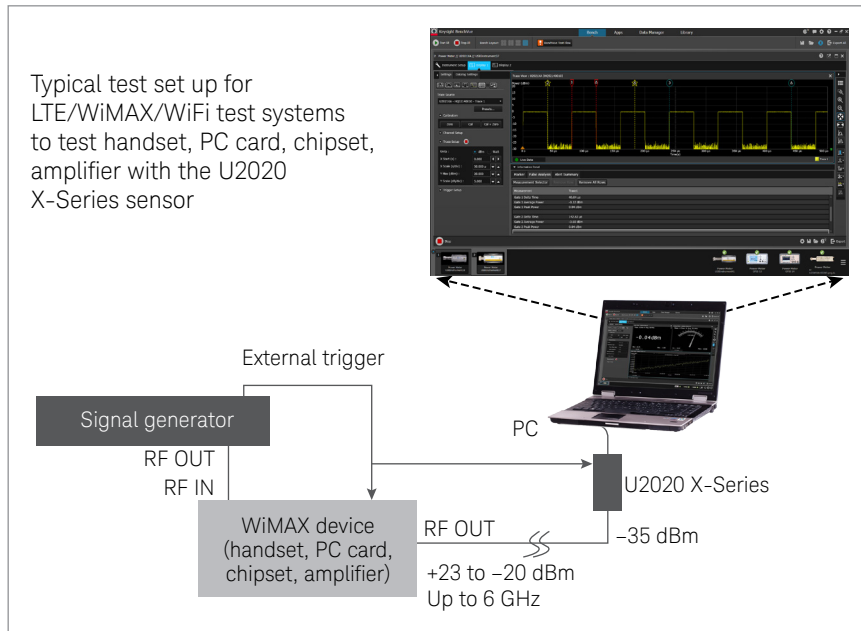

## Remote testing for radar installation and maintenance

When a U2020 X-series sensor is connected to a LAN-USB adapter, you can perform complex radar pulse analysis and monitor your measurements from a distance up to 200 feet. The built-in internal zero calibration function allows you to permanently connect your sensor to the device-under-test without the hassle of constantly removing and re-installing your sensor.

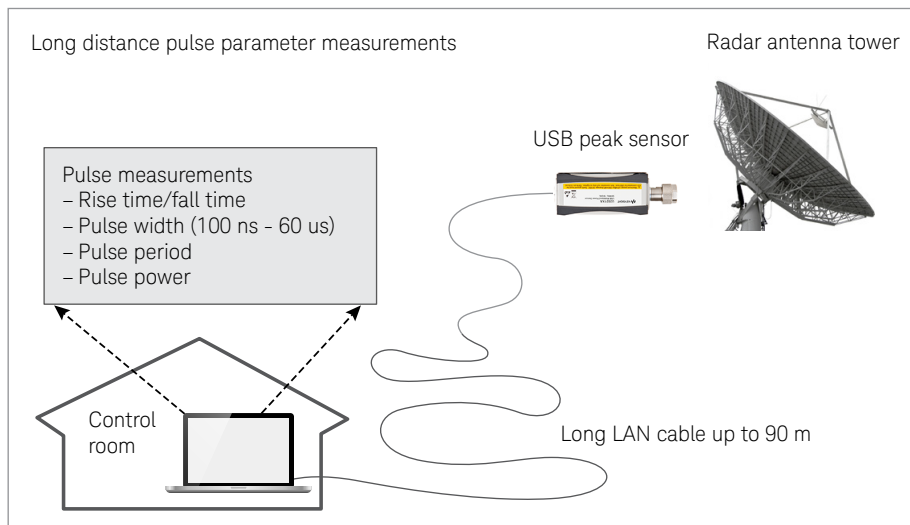

## Peak and Average Power Measurements and Analysis For Radar and Wireless Applications (continued)

### Portable solution for base station installation and maintenance

Portability is one of the key attributes in the base station installation and maintenance industry, where users mainly work out in the field. Whether you are using a PC or other Keysight instruments, the U2020 X-series USB power sensors will perform peak and average power measurement similar to traditional power meters, all in a portable and lightweight form factor.



# Peak and Average Power Measurements For Compact ATE Systems

## Keysight N8262A P-Series modular power meter

The N8262A is a dual-channel, LXI Class C compliant power meter that's designed to support LAN-based ATE systems. With its slim, half-rack build, the N8262A enables a smaller test system and ensures easier deployment.

### Features

#### Dimension

- 1U half-rack size

#### Specifications

- 30 MHz video bandwidth
- 100 Msamples/s continuous sampling rate

#### Measurement type

- Peak, average, peak-to-average ratio power measurements
- Time-gated and free-run measurement modes
- CCDF statistical analysis
- Rise time, fall time, pulse width, time to positive occurrence and time to negative occurrence measurements
- Includes predefined configurations for WLAN, radar and MCPA

#### Calibration

- Calibration and correction factors in EEPROM (P-Series, E-Series sensors)
- Internal zeroing and calibration (P-Series sensors) \* *Refer to page 18*

#### Remote programmability

- SCPI standard interface command
  - \* *Also programmable in other languages. See "System-ready software" below.*
- 10/100BaseT LAN interface

#### System-ready software

- Bundled Synthetic Instrument Finder works with all LXI-compliant instruments
- Instrument Web page is accessible with any standard Web browser
- Bundled Power Meter GUI is also compatible with P-Series power meters
- Bundled IVI driver enables programming in your choice of environment, including Keysight VEE, LabVIEW, C, C#, C++, Microsoft Visual Basic, and MATLAB

#### Backward-compatibility

- Code-compatible with N1912A P-Series power meter



### Highlights

- Deploy test systems more easily
- Lower test system startup cost
- Integrate easily into existing systems
- Perform remote access and control from anywhere

# Peak and Average Power Measurements For Compact ATE Systems (continued)

## Deploy test systems more easily

With its 1U half-rack size, the N8262A eases deployment of test systems wherever duty calls.

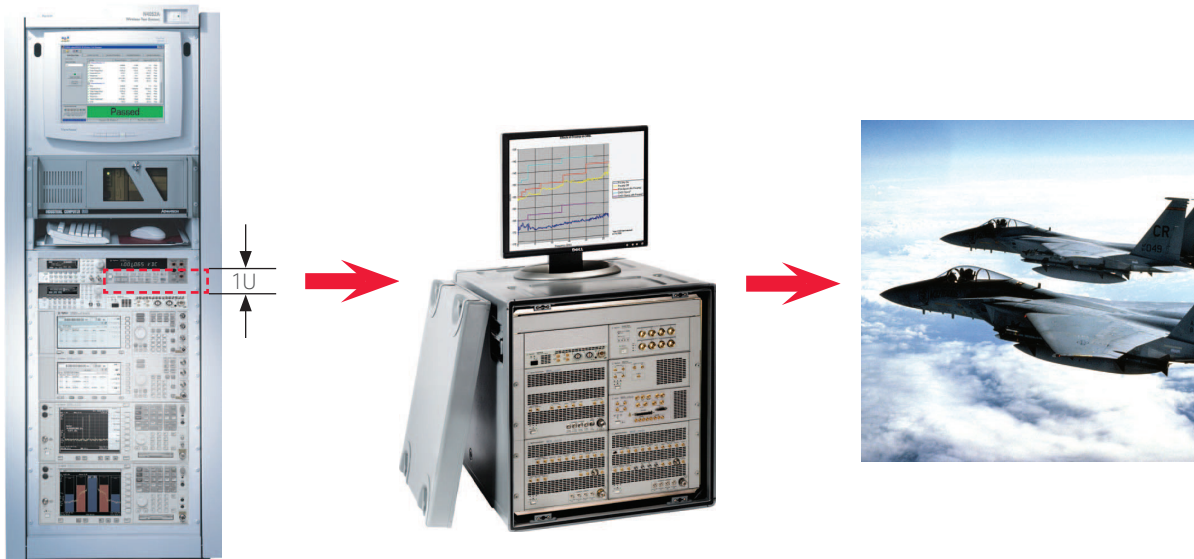

Smaller test systems are possible with the 1U N8262A, making it more readily deployable

## Remote access and control from anywhere

With the convenience of LAN, neither place nor distance is a limit to power measurements with the N8262A.

Whenever you need to view or modify an N8262A's current proxy settings, you can do so with its built-in Web page.

The image displays two screenshots related to the N8262A power meter. The top screenshot shows a web browser window with the URL 'http://141.183.169.193/index.html'. The page title is 'KEYSIGHT N8262A Power Meter'. It features a 'Your Current Settings are:' section with fields for Instrument, Manufacturer, Serial Number, Description, LXI Class, LXI Version, Hostname, Ethernet (MAC) Address, TCP/IP Address, and Firmware Revision. A 'Toggle ID LED' button is also visible. The bottom screenshot shows the front panel GUI of the N8262A. It includes a 'Preset' button, a 'Display' button, and a 'Disconnect' button. The main display area shows a graph with a yellow trace and numerical data: '1-28.2us -43.35dBm', '2-217ns -43.35dBm', 'Peak: 0.29dBm', 'Pk-Avg: 1.83dB', and 'A1: 28.9us'. A numeric keypad and function keys (F1-F5) are also present.

Control an N8262A and view measurement results through the Power Meter GUI soft front panel, the way you would a P-Series power meter from its front panel.

# Peak and Average Power Measurements For Effective Capture of Wireless and Radar Signals

## Keysight N1911A/12A P-Series power meters

The P-Series power meters are LXI Class C compliant, designed for high performance measurement of wireless signals such as WiMAX™, LTE and radar. Predefined settings in the P-Series power meters enable effective capture of unpredictable wireless signals, with their high burst rates and fast, time-varying power levels.

## Features

### Models

- Single-channel N1911A
- Dual-channel N1912A

### Specifications

- 30 MHz video bandwidth
- 100 Msamples/s continuous sampling rate

### Measurement type

- Peak, average, peak-to-average ratio power measurements
- Time-gated and free-run measurement modes
- CCDF statistical analysis in graphical and tabular formats
- Rise time, fall time, pulse width, time to positive occurrence and time to negative occurrence measurements
- Includes predefined configurations for wireless communication formats such as LTE

### Calibration

- Calibration and correction factors in EEPROM (P-Series, E-Series sensors and N8480 Series)
- Internal zeroing and calibration (P-Series sensors) \* Refer to page 18

### Remote programmability

- SCPI standard interface commands  
\* Also programmable in other languages. See below
- GPIB, LAN and USB interfaces

### System-ready software

- Bundled IVI driver enables programming via your choice of environment, including Keysight VEE, LabVIEW, LabWindows, C, C++, and MATLAB

### Backward-compatibility

- Code-compatible with EPM-P and EPM Series power meters

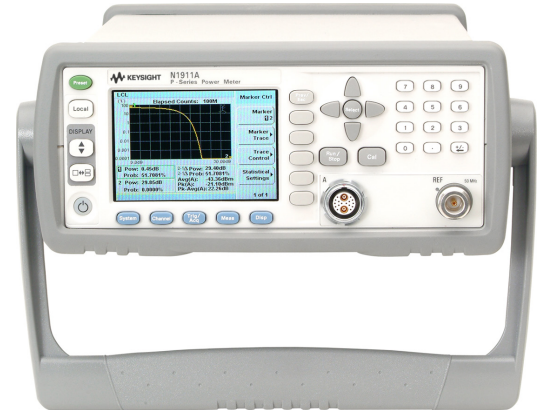

## Highlights

- Quick setup with 22 radio presets
- Automatic pulse capture
- Wide VBW and high sampling rate
- High resolution color display
- External triggerable when used with E-Series average power sensors

# Peak and Average Power Measurements For Effective Capture of Wireless and Radar Signals (continued)

## High sampling rate for WiMAX and WLAN testing

Apart from WiMAX and WLAN presets, the P-Series power meters also offer 100 Msamples/s continuous sampling that ensures glitches are not missed.

- The P-Series power meters' 30 MHz video bandwidth enables the capture of signals with modulation bandwidth up to 30 MHz
- With their auto trigger hold-off capability, you can capture the complete Downlink or Uplink subframe burst desired within a fixed time span
- Time-gated peak, average and peak-to-average ratio power measurements are automatically displayed to ease analysis of signals

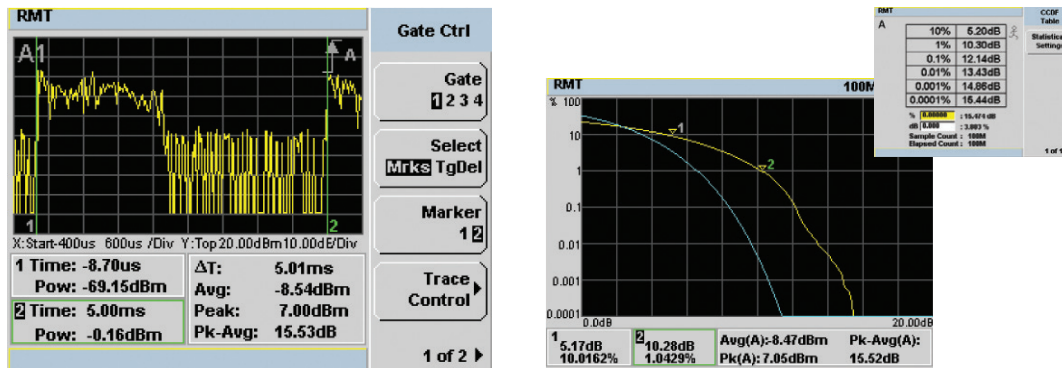

CCDF statistical analysis is viewable in both tabular and graphical formats

## Autoscaling and autogating for radar testing

Setting up for radar signal measurements is faster and easier with the P-Series preset. Capture of a radar pulse is further simplified with autoscaling and autogating functions. With autogating set to "perpetually on," the gates reposition themselves automatically when pulse width changes.

- Up to four independent time gates can be set for individual measurements on one or multiple pulses
- With a frequency range of up to 40 GHz and rise/fall times of  $\leq 13$  ns, you have more than enough to profile high-frequency radar signals in most applications

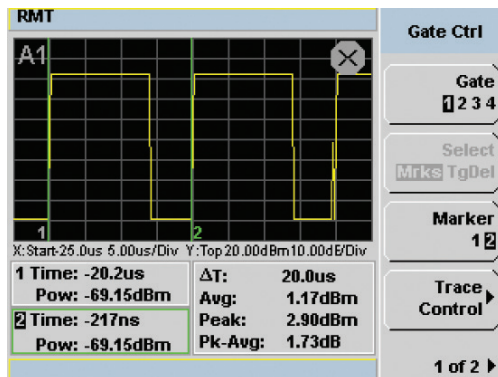

# Peak and Average Power Measurements For Effective Capture of Wireless and Radar Signals (continued)

## Wide video bandwidth for MCPA testing

In designing multi-carrier power amplifiers (MCPA), a wide-bandwidth power meter such as the P-Series helps you ensure that your device stays within its maximum power specification. The P-Series power meter's 30 MHz video bandwidth allows up to six 3G carriers over a wide dynamic range.

- CCDF and peak-to-average power measurements verify if MCPA is clipping
- 100 MSamples/s continuous sampling ensures easier detection of glitches
- Rise/fall time measurements help in checking the signal's burst profile and in identifying power transition problems
- High resolution color display ease viewing and differentiation of the four traces

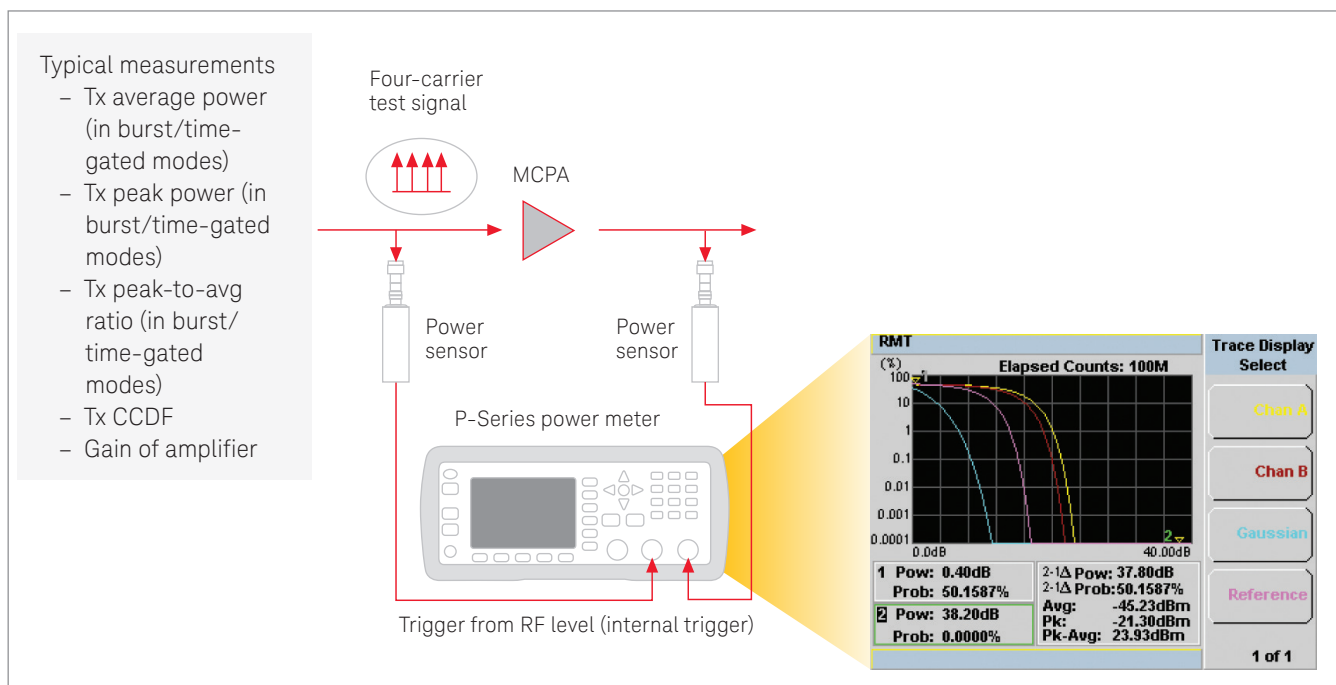

A sample setup for MCPA testing



## Peak and Average Power Measurements For Effective Capture of Wireless and Radar Signals (continued)

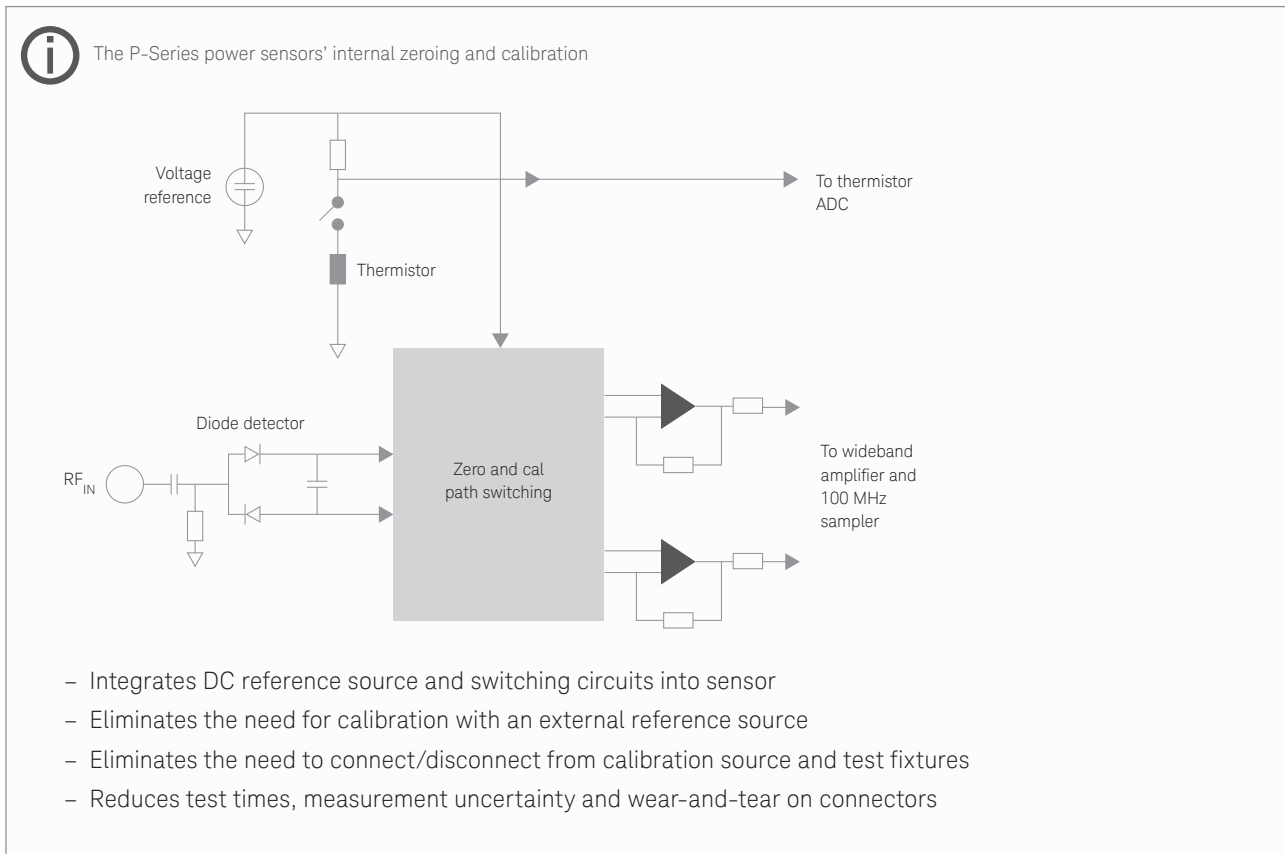

# Peak and Average Power Measurements For Testing of Wireless Signals

## Keysight E4416A/17A EPM-P Series power meters

The EPM-P Series power meters operate with the E9320 Series peak-and-average power sensors for testing various complex modulation formats in wireless communication systems, such as TDMA and CDMA.

### Features

#### Models

- Single-channel E4416A
- Dual-channel E4417A

#### Specifications

- 5 MHz video bandwidth
- 20 Msamples/s continuous sampling rate

#### Measurement type

- Peak, average, peak-to-average ratio power measurements
- Time-gated and free-run measurement modes
- Includes predefined configurations for GSM, EDGE, NADC, iDEN, *Bluetooth*<sup>®</sup>, IS-95 CDMA, W-CDMA and cdma2000<sup>®</sup>

#### Calibration

- Calibration and correction factors in EEPROM (E-Series sensors and N8480 Series)

#### Remote programmability

- SCPI standard interface commands
- GPIB, RS-232/422 interfaces

#### System-ready software

- EPM-P analyzer software

#### Backward-compatibility

- Code-compatible with EPM Series power meters



### Highlights

- Optimize dynamic range for peak power measurement
- Complete TDMA and CDMA characterization

# Peak and Average Power Measurements For Testing of Wireless Signals (continued)

## Optimize dynamic range with E9320 Series sensors

Wider bandwidths allow you to profile fast-changing signals, but at the expense of dynamic range. That's why each E9320 Series power sensor comes with three variable bandwidth settings. This helps you select the best bandwidth for your application, yet still maintain the widest possible dynamic range.

Sensor model	Video bandwidth/maximum peak power dynamic range			
	Off	High	Medium	Low
E9321A	300 kHz/	300 kHz/	100 kHz/	30 kHz/
E9325A	-40 dBm to +20 dBm	-42 dBm to +20 dBm	-43 dBm to +20 dBm	-45 dBm to +20 dBm
E9322A	1.5 MHz/	1.5 MHz/	300 kHz/	100 kHz/
E9326A	-36 dBm to +20 dBm	-37 dBm to +20 dBm	-38 dBm to +20 dBm	-39 dBm to +20 dBm
E9323A	5 MHz/	5 MHz/	1.5 MHz/	300 kHz/
E9327A	-32 dBm to +20 dBm	-32 dBm to +20 dBm	-34 dBm to +20 dBm	-36 dBm to +20 dBm

## Complete TDMA/CDMA analysis with bundled analyzer software

### Pulse analysis

Versatile markers offer complete power and timing characterization of pulsed signals, to provide easy testing of TDMA component parameters and system performance. In addition to measuring peak, average and peak-to-average ratio power, the Keysight EPM-P analyzer software measures the following pulse characteristics automatically:

- Power: pulse top, pulse base, distal, mesial, proximal, overshoot and burst average
- Frequency and time: Pulse Repetition Frequency (PRF), Pulse Repetition Interval (PRI), pulse width, off-time, rise time and fall time

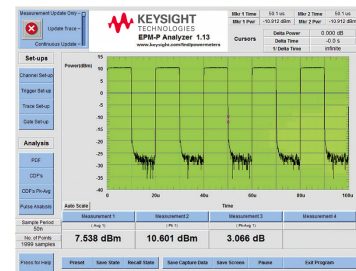

### Statistical analysis

For today's noise-like CDMA and W-CDMA formats, statistical analysis of the power distribution helps you optimize system design by providing essential characterizations such as amplifier compression. The Keysight EPM-P analyzer software provides the capability to determine the PDF, CDF and CCDF.

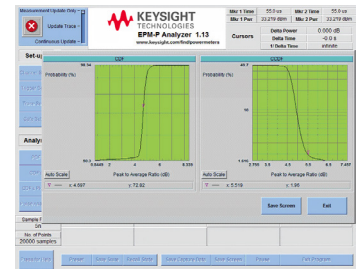

# Peak and Average Power Measurements For Testing of Wireless Signals (continued)

## EPM-P analyzer software

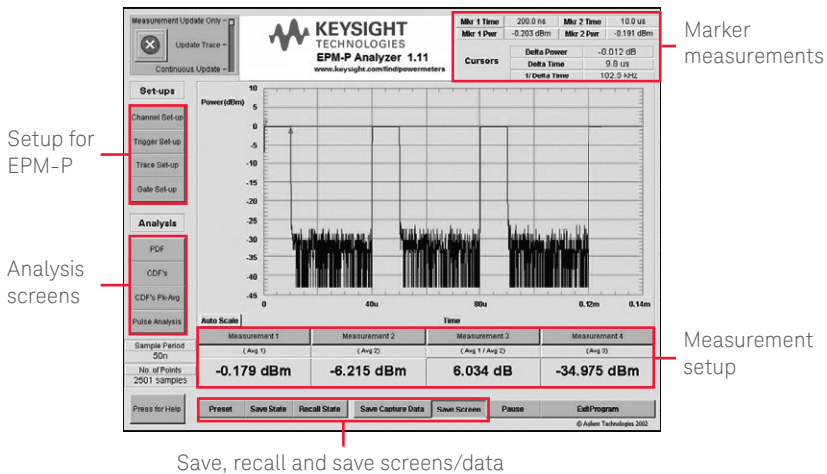

## Setups for EPM-P

This software controls the power meter and is used to set up the Channel, Trigger and Gate Setups as shown through the front panel.

## Analysis screens

After the power meter is configured, the trace is captured to allow for analysis of the captured trace data. There are various analysis screens covering statistical analysis such as Probability Density Function (PDF) and Complementary Cumulative Distribution Function (CCDF or 1-CDF) measurements and pulse analysis.

## Marker measurements

When the trace is captured, the marker measurements can be used to provide time and power information, and the trace can also be zoomed in to look closely at areas of interest.

## Measurement setup

The display can show up to four real-time power measurements, which are configured in a similar manner to the power meter display, and allows time-gated average, peak, peak-to-average ratio measurements, as well as combination measurements to be displayed.

## Save, recall and save screens/data

If the analyzer display is required for reports or import into other applications, the screen can be saved as a JPG or BMP file and the power and time data from the captured trace can also be saved in a CSV file. The analyzer software allows 10 states to be stored and recalled. This ensures easy set up of the analyzer software and allows repeatable measurements to be obtained. These states are saved in a separate file, and stored on the PC or a disc, ensuring users on different PCs are operating the same setups and therefore making the same measurements.

# Average Power Measurements For Metrology and Calibration Laboratories

## Keysight N432A thermistor power meter

The N432A is a single-channel, average RF power meter that's ideal for high-accuracy measurement applications, particularly metrology and calibration laboratory environments.

### Features

#### Measurement type

- Average power measurements

#### Calibration

- Built-in calibration factor table

#### Remote programmability

- SCPI standard interface commands

### Highly accurate RF measurements for metrology and calibration

The N432A's high 0.2% accuracy, coupled with Keysight 478A-H75/H76 thermistor sensors, makes it excellent for 1 mW transfer calibration.



### Highlights

- High accuracy ( $\leq 0.2\% \pm 0.5 \mu\text{W}$ )
- Built-in 6.5-digit ADC eliminates the need for an external DMM
- DC substitution measurement, traceable to the U.S. National Institute of Standards and Technology (NIST)
- Selectable bridge resistance
- Digital color LCD display, and user-friendly interface

# Average Power Measurements For Flexible Testing: On the Rack and On the Go

## Keysight N1913A/14A EPM Series power meters

The Keysight N1913A/14A EPM Series power meters are versatile, user-friendly replacements for the popular E4418B/19B EPM power meters. They deliver fast, repeatable, reliable results for both bench/rack and field applications.

### Features

#### Models

- Single-channel N1913A
- Dual-channel N1914A
- One or two additional channels with USB power sensor(s)

#### Measurement type

- Average power measurements

#### Calibration

- Calibration and correction factors in EEPROM (E-Series and N8480 Series)

#### Remote programmability

- SCPI standard interface commands
- GPIB, USB and LAN/LXI-C interfaces

#### Backward-compatibility

- Code-compatible with legacy E4418B/9B EPM Series, 436A, 437B and 438A power meters (43X compatibility only with Option N191xA-200)



### Highlights

- Up to four-channel power measurements
- Fast measurement speed of 400 readings/second
- Industry's first color LCD screen in an average power meter
- Convenient field usage with operating case and battery option
- Optional external trigger feature for automatic frequency/power sweep measurements
- VGA output option for connection to external monitor

## View measurements better in any lighting and angle

The new EPM Series come with the industry's first color LCD in an average power meter. With its high-resolution color and wide viewing angle, you can see your test results more easily—no matter where you are.

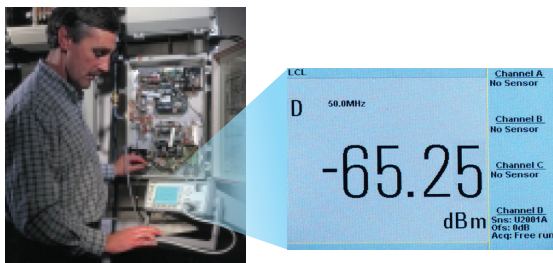

## Perform field measurements conveniently

You can easily carry an EPM Series power meter in its operating case when you need to travel between stations. This meter is also available with a battery option and one-button battery power level check so you can keep your power meters at its optimum capacity before your next field task. To ensure continuous power, you can opt for a spare battery pack (Option N191xA-300).



# Average Power Measurements For Mobile Testing that's Plug-and-Play Easy

## Keysight U2000 Series USB power sensors

Standalone USB-based U2000 Series power sensors enable power measurements without power meters. Using USB power and providing built-in triggering, these power sensors don't need external power adapters or triggering modules for synchronization with external instruments or events. All these make the U2000 Series an ideal choice for high performance mobile power measurements.

### Features

#### Measurement type

- Average power measurements
- Frequency range: 9 kHz to 24 GHz
- Dynamic range: -60 dBm to 44 dBm

#### Remote programmability

- USB interface

#### Backward-compatibility

- Code-compatible with E4418B EPM Series power meter

### Highlights

- Travel with lighter-weight instruments
- Set-up easily with USB, and measure from practically anywhere beyond USB cable length
- Save time connecting/disconnecting sensor with internal zeroing
- RF burst signal measurement with time-gating
- Built-in internal triggering and trace graph display

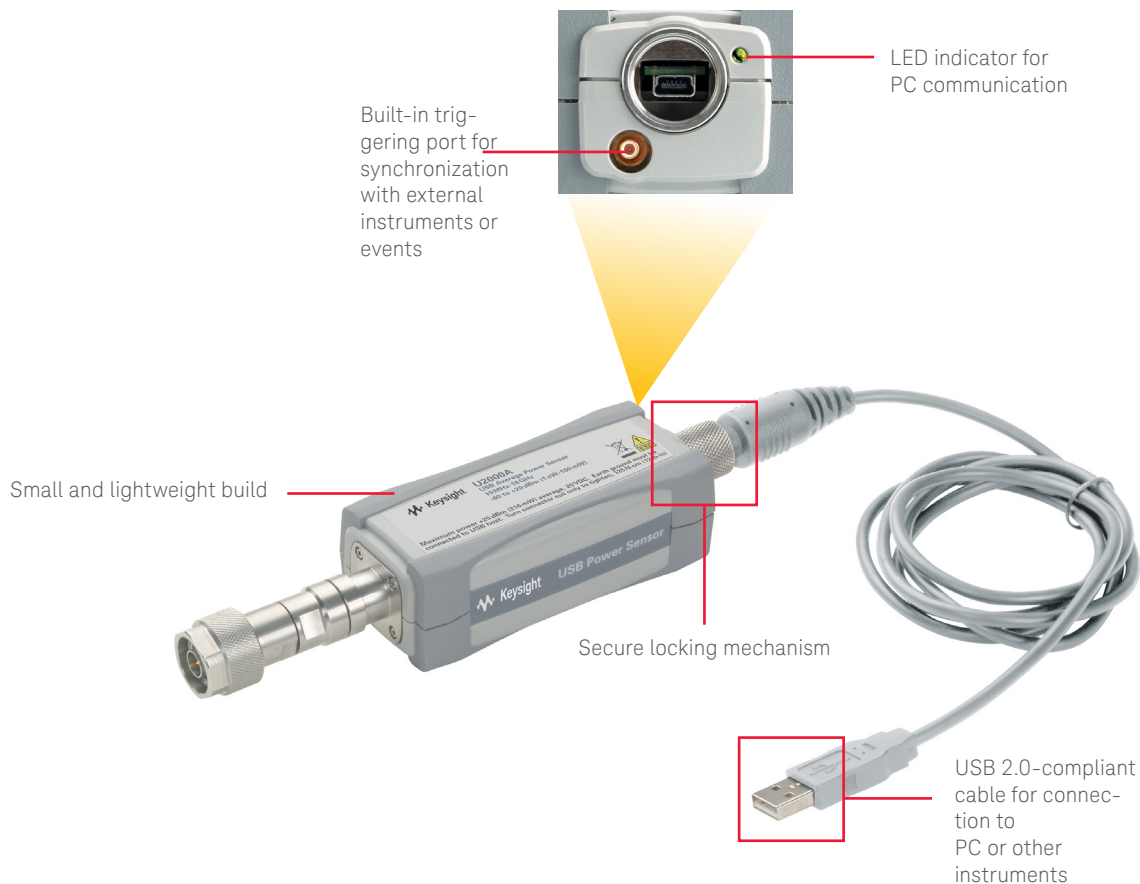

## Average Power Measurements For Mobile Testing that's Plug-and-Play Easy (continued)

### Perform antenna testing across any distance

When a USB power sensor is connected to a USB-to-LAN hub, you can perform measurements beyond the limits of USB cable length. Conveniently leave your sensor connected to the power tap-off—even while performing zeroing – and monitor your measurements remotely.

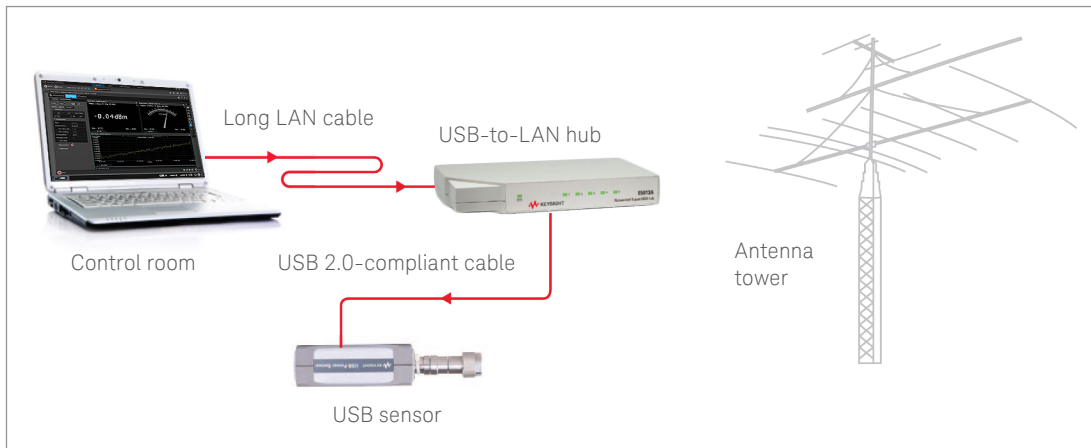

### Perform base station testing without the usual bulkiness

When you need to take power measurements on the road or up a base station tower, smaller, lighter and fewer is better. With the USB power sensors, the only other thing you'll need is a laptop with BenchVue software installed.

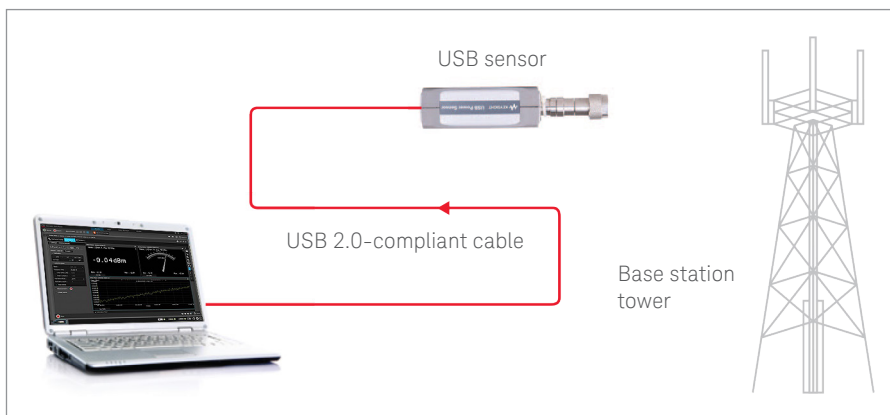



## Average Power Measurements For Mobile Testing that's Plug-and-Play Easy (continued)

### Reduce sensor connection/disconnection

With a U2000 Series sensor's internal zeroing capability, you don't need to power off the device-under-test or disconnect the sensor. This saves test time and reduces sensor wear-and-tear – advantages that are especially crucial in applications where every second counts, such as manufacturing test. With internal zeroing, the sensor can be left connected to the test fixture.



### Add power measurements to other instruments

The USB power sensors give more accurate measurements than other RF measurement instruments like spectrum analyzer or network analyzer. You can connect a USB power sensor to the instrument and you can switch between the power measurement with the USB power sensor and the instrument's original functions at any time.



# Average Power Measurements For Broadband Applications

## Keysight U8480 Series USB thermocouple power sensors

The U8480 Series USB power sensors is one of the most cost-effective solutions in Keysight's power meter and sensor portfolio, providing top performance features at costs so affordable that every engineer can carry one in their bags. These sensors come with a measurement speed of 900 readings/second and power linearity of less than 0.8%, providing high accuracy and stability to help you make average power measurements from DC to 120 GHz (sensor dependent) quickly and confidently.

### Features

#### Models

- U8481A USB thermocouple power sensor (DC/10 MHz to 18 GHz; -35 dBm to +20 dBm)
- U8485A USB thermocouple power sensor (DC/10 MHz to 33 GHz; -35 dBm to +20 dBm)
- U8487A USB thermocouple power sensor (10 MHz to 50 GHz; -35 dBm to +20 dBm)
- U8488A USB thermocouple power sensor (10 MHz to 67 GHz; -35 dBm to +20 dBm)
- U8489A USB thermocouple power sensor (DC to 120 GHz; -35 dBm to +20 dBm)

#### Specifications

- 900 readings/s measurement speed
- Power linearity: < 0.55% (-1 to +15 dBm); < 0.80% (+15 to +30 dBm)
- Damage level (RF): 25 dBm (average power); 15 W (2  $\mu$ s duration) (peak power)
- Damage level (DC): AC coupled (option 100), 50 V; DC coupled (option 200), 4 V
- Zero set: < 25 nW
- Zero drift: < 10 nW
- Measurement noise: < 80 nW

#### Measurement type

- Average power measurements

#### Calibration

- Internal calibration

#### Remote programmability

- USB interface



### Highlights

- Measurement speed of 900 readings/second and power linearity of < 0.8%
- Keysight's first power sensor to measure down to DC (sensor dependent)
- Add power measurement capabilities to selected Keysight instruments, and switch between power measurements and the instrument's original function when needed
- Improve accuracy with real time measurement uncertainty feature
- Correct for errors with the S-parameter and gamma correction functions

## Average Power Measurements For Broadband Applications (continued)

### Continuous remote monitoring of satellite communication systems

Many satellite communication systems operate at microwave frequencies such as X, Ku and Ka bands, which supports wider modulation bandwidth, increased capacity and enables the use of smaller antennas. The U8480 Series covers a wide frequency range from DC to 120 GHz (sensor dependent), and can test satellites up to Ku or Ka bands. The USB sensors also come with a built-in DC reference source and excellent long term drift performance and can be left connected to a test setup without human intervention for several months, making the U8480 Series an ideal solution for long term, remote monitoring of satellite communication systems.

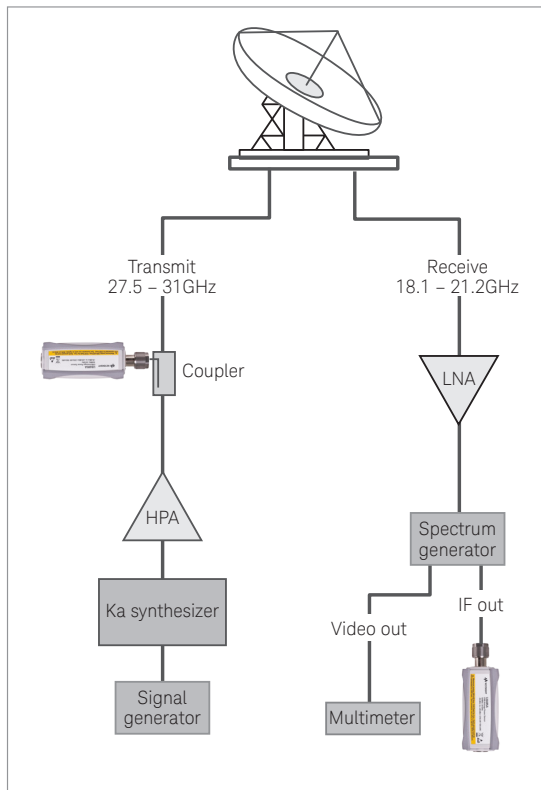

Typical satellite test system set-up

### Perform measurement/calibration down to DC range

The U8481A/85A/89A USB thermocouple sensors have the ability to perform measurements down to the DC range, which is often used for source calibration and power measurement reference for Keysight instruments such as the PNA/PNA-X network analyzers and the MXG X-Series signal generators. DC range measurements are also applicable to some EMC applications.

# Average Power Measurements For mmWave applications

## Keysight 8486A Waveguide Power Sensors

Covering the V-band, E-band and W-band spectrums, the Keysight Technologies, Inc. waveguide power sensors offer best SWR, high reliability and low loss, and come with a 50 MHz calibration port to reduce measurement uncertainties.

### Features

#### Models

- V8486A V-Band waveguide power sensor, 50 to 75 GHz (-30 to +20 dBm, -60 to +20dBm with option H02)
- E8486A E-Band waveguide power sensor, 60 to 90 GHz (-30 to +20 dBm, -60 to +20dBm with option 200)
- W486A W-band waveguide power sensor, 75 to 110 GHz (-30 to +20 dBm)

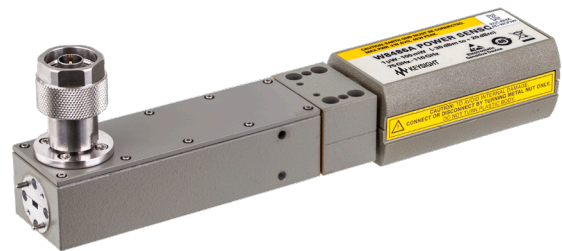

#### Specifications

- SWR < 1.06
- Zero set <  $\pm 200$  nW (<  $\pm 200$  pW with opt 200 or H02)
- Measurement noise < 450 nW (< 450 pW with opt 200 or H02)
- Zero drift <  $\pm 40$  nW (<  $\pm 40$  pW with opt 200 or H02)

#### Measurement type

- Average power measurements

#### R and Q band models:

- R8486D Waveguide power sensor, 26.5 GHz to 40 GHz (-70 dBm to -20 dBm)
- Q8486D Waveguide power sensor, 33 GHz to 50 GHz (-70 dBm to -20 dBm)
- N8486AR Thermocouple waveguide power sensor, 26.5 GHz to 40 GHz (-35 dBm to +20 dBm)
- N8486AQ Thermocouple waveguide power sensor, 33 GHz to 50 GHz (-35 dBm to +20 dBm)

### Highlights

- Best SWR (1.06) minimizes the measurement uncertainty caused by mismatch.
- The 50 MHz calibration port offers an easy calibration and eliminates the variance in making measurements with different meter/sensor combinations and the uncertainties due to temperature
- Reliable measurements using Modified Barrier Integrated Diode (MBID) technology operates in the square-law characteristic for true-average detection.

# Average Power Measurements For Portable RF Measurements

## Keysight V3500A handheld RF power meter

The V3500A is a portable, palm-sized power meter with an integrated power sensor and built-in display. Compact with essential average power measurement capabilities, the V3500A is a handy tool for installation and maintenance or R&D lab environments.

### Features

#### Measurement type

- Average power measurements
- Frequency range: 10 MHz to 6 GHz
- Dynamic range: -60 dBm to 20 dBm

#### Remote programmability

- Programming languages: Microsoft Visual Studio.NET, Microsoft Visual Basic, and Microsoft Visual C++
- USB interface

#### Truly portable for field measurements

The V3500A provides an optional loop holster carrying case with a shoulder strap. The handheld comes with a backlit display and illuminated keypad to help you make measurements in poorly lit conditions.



### Highlights

- Small and lightweight form that fits in your palm, no separate power sensor or display needed
- Internal power reference enables self-calibration
- Absolute accuracy up to  $\pm 0.21$  dB
- Multiple power-up methods: AA batteries, computer via USB interface, AC-DC converter module (Option PWR)



# Power Measurement Software for Simplified Data Capture

## BenchVue software

The Keysight BenchVue software for the PC accelerates testing by providing intuitive, multi instrument measurement visibility and data capture with no programming necessary. You can derive answers faster than ever by easily viewing, capturing and exporting measurement data and screenshots.

The Power Meter/Sensor Control and Analysis App (BV0007B) for BenchVue enables control of power meters and power sensors to data log and visualize measurements in a wide array of display formats. It can control multiple meters/sensors from a single instance. Calibrations can be done fast with software buttons. Presets allow quick analysis of power levels of industry standard communications signals. Trial licenses can be started with one-click using the button to the left. Licenses may be purchased from Keysight or directly from your preferred Keysight Distributor. This app supports Keysight's USB/LAN power sensors and some power meters. Measurement Display options include:

- Digital Meter Views- to display precise and exact reading (up to 4 decimal points) measured by the instrument
- Analog Meter Views- to display measured reading in analog form for easier visualization of large measurement differences
- Strip Chart- to display measured reading in a graphical form (Power/time)
- CCDF View- to display the Complementary Cumulative distribution function
- Trace View- to display traces of modulated signal
- Multilist View- to display multiple power measurements

## Key features & specifications

- Control and setup your Power meters and sensors
- Setup all necessary parameters for your critical measurements
- Control multiple power meters/sensors from one instance of the software
- Log and view measurement data in the format you need:
- With 6 different display types seeing what you care about has never been easier or more flexible
- Export results in three clicks:
- Export data quickly to popular tools such as Matlab and Microsoft Excel or Word for documentation or further analysis.

## Supported models

- U2021XA, U2022XA, U2041XA, U2042XA, U2043XA, U2044XA, U2049XA, U2000A, U2000B, U2000H, U2001A, U2001B, U2001H, U2002A, U2004A
- U8481A, U8485A, U8487A, U8488A, U8489A
- N1911A, N1912A, N1913A, N1914A
- N8262A

## Highlights

- Visualize multiple measurements simultaneously
- Easily log data, screen images and system state
- Recall past state of your bench to replicate results
- Fast measurement data export in desired formats
- Quickly access manuals, drivers, FAQs and videos
- Monitor and control your bench from mobile devices



# Power Measurement Software for Simplified Data Capture (continued)

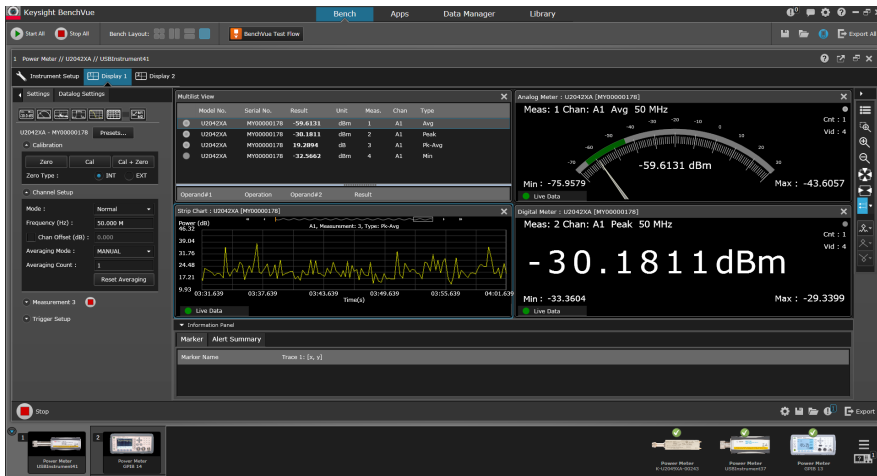

Digital meter, analog meter and datalog view





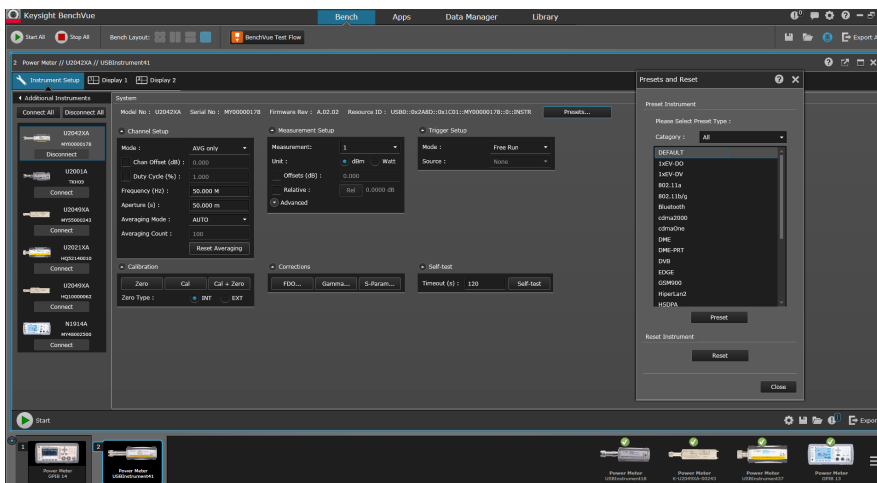







Multi-channel trace display with 4-pairs of gates and automatic pulse parameters measurement



Multi-list view with ratio/difference function

For more information on the BenchVue software, visit [www.keysight.com/find/BenchVue](http://www.keysight.com/find/BenchVue).

# Power Meters Selection Chart

Peak Power Measurement	Power Sensor Options	Average Power Measurement	Power Sensor Options
<b>EPM-P E4416A/17A</b> (VBW: 5 MHz) 	– E932x Peak-and-Average Sensors (300 kHz, 1.5 MHz, 5 MHz) * Also compatible with all average power sensors	<b>EPM N1913A/14A</b> 	– 848x Diode and Thermocouple Sensors – N848x Thermocouple Sensors – N848x and 848x Waveguide Sensors – E441x 1-Path Diode CW-only Sensors – E930x 2-Path Diode True-Average Sensors – U200x USB Sensors
<b>P-Series N1911A/12A</b> (VBW: 30 MHz) 	<b>For the P-series meters</b> – N1921A/22A Wideband Sensors (30 MHz) – E932x Peak-and-Average Sensors (300 kHz, 1.5 MHz, 5 MHz) * Also compatible with all average power sensors	<b>N432A Thermistor power meter</b> 	– 478A Thermistor Sensor
<b>U2020 X-Series USB power sensors</b> (VBW: 30 MHz) 		<b>U8480 Series USB thermocouple sensors</b> 	
<b>U2040 X-Series USB/LAN power sensors</b> (VBW: 5 MHz) 		<b>U2000 Series USB power sensors</b> 	
<b>8990B peak power analyzer</b> (VBW: 160 MHz) 	<b>For the 8990B</b> – N1923A/24A Wideband Sensors (160 MHz) – N1921A/22A Wideband Sensors (30 MHz)	<b>V3500A handheld RF power meter</b> 	

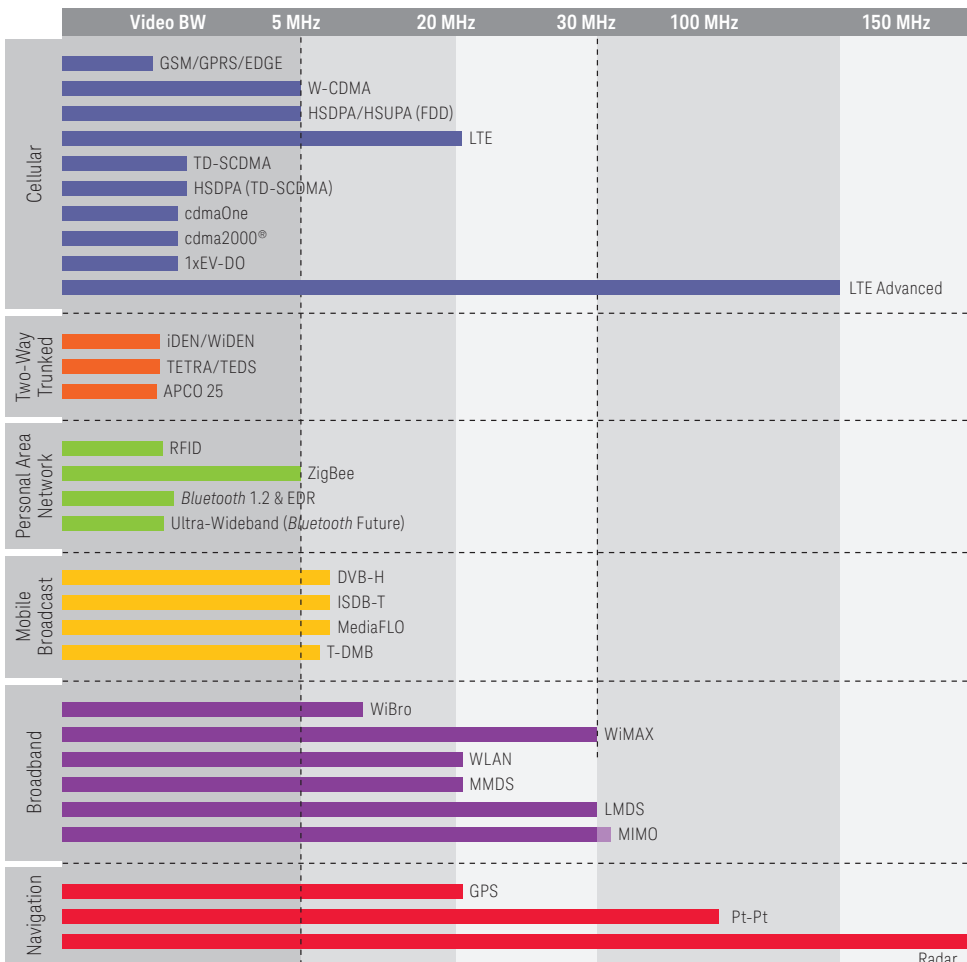



# Power Sensors Selection Chart

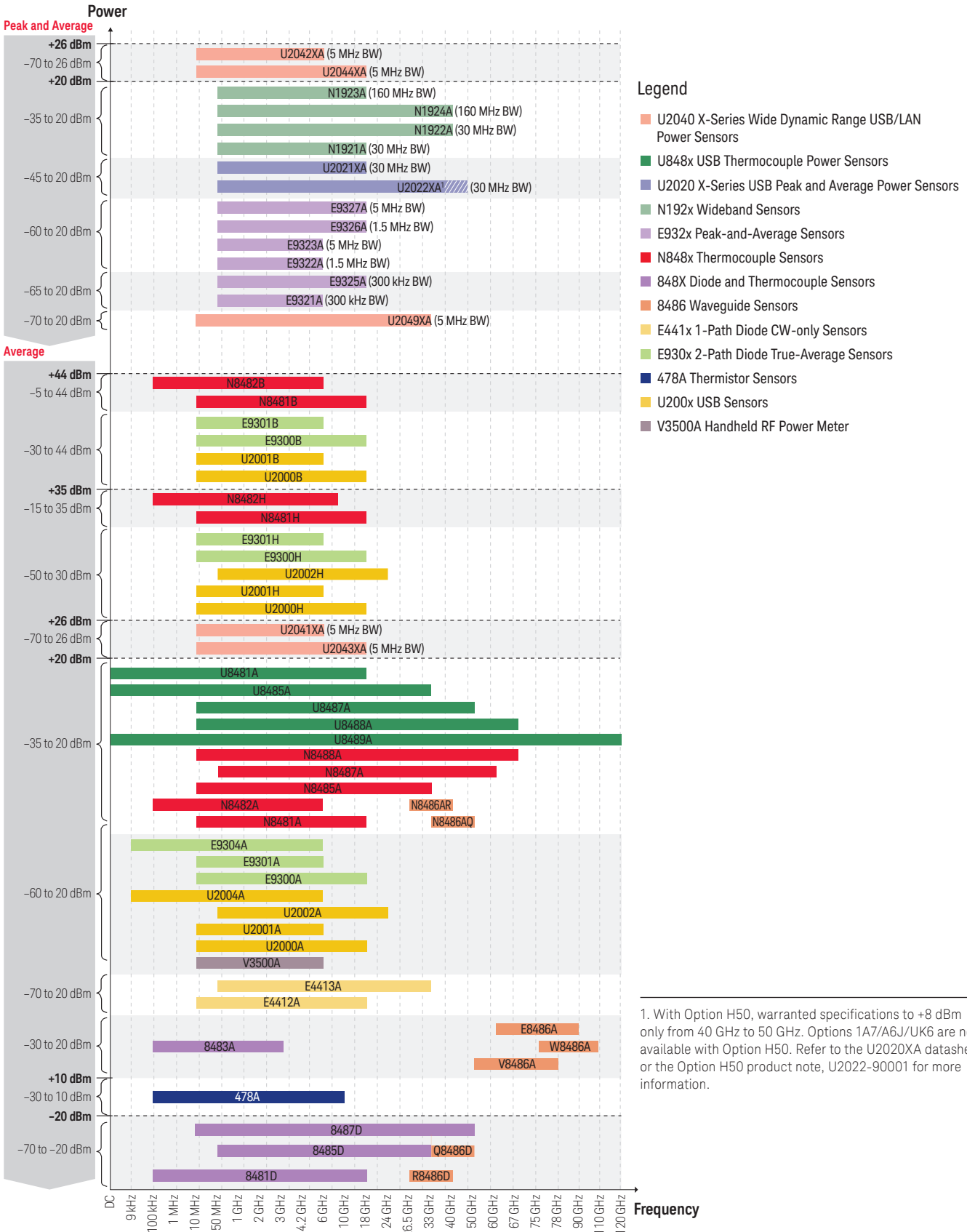

1. With Option H50, warranted specifications to +8 dBm only from 40 GHz to 50 GHz. Options 1A7/A6J/UK6 are not available with Option H50. Refer to the U2020XA datasheet or the Option H50 product note, U2022-90001 for more information.

# Power Meters and Sensors Compatibility Table

		POWER METERS						Product Description/ Sensor Tech.	Frequency Range	Power Range
		N432A	N1913A/14A	N1911A/12A N8262A P-Series	8990B	E4416A/17A EPM-P				
U2040 X-Series wide dynamic range power sensors	U2041XA	-	√	-	√ <sup>1</sup>	-	Diode Power Sensor	10 MHz to 6 GHz	-70 dBm (100 pW) to +26 dBm (398 mW)	
	U2042XA	-	-	-	√ <sup>1</sup>	-	Diode Power Sensor	10 MHz to 6 GHz	-70 dBm (100 pW) to +26 dBm (398 mW)	
	U2043XA	-	√	-	√ <sup>1</sup>	-	Diode Power Sensor	10 MHz to 18 GHz	-70 dBm (100 pW) to +26 dBm (398 mW)	
	U2044XA	-	-	-	√ <sup>1</sup>	-	Diode Power Sensor	10 MHz to 18 GHz	-70 dBm (100 pW) to +26 dBm (398 mW)	
	U2049XA	-	-	-	-	-	Diode Power Sensor	10 MHz to 33 GHz	-70 dBm (100 pW) to +20 dBm (100 mW)	
U8480 Series USB thermocouple sensors	U8481A	-	√	-	√ <sup>1</sup>	-	Thermocouple Power Sensor	DC/10 MHz to 18 GHz	-35 dBm (316 nW) to +20 dBm (100 mW)	
	U8485A	-	√	-	√ <sup>1</sup>	-	Thermocouple Power Sensor	DC/10 MHz to 33 GHz	-35 dBm (316 nW) to +20 dBm (100 mW)	
	U8487A	-	√	-	√ <sup>1</sup>	-	Thermocouple Power Sensor	10 MHz to 50 GHz	-35 dBm (316 nW) to +20 dBm (100 mW)	
	U8488A	-	√	-	√ <sup>1</sup>	-	Thermocouple Power Sensor	10 MHz to 67 GHz	-35 dBm (316 nW) to +20 dBm (100 mW)	
	U8489A	-	√	-	√ <sup>1</sup>	-	Thermocouple Power Sensor	10 MHz to 120 GHz	-35 dBm (316 nW) to +20 dBm (100 mW)	
U2020 X-Series USB sensors	U2021XA	-	-	-	√ <sup>1</sup>	-	Diode Power Sensor	50 MHz to 18 GHz	-35 dBm (316 nW) to +20 dBm (100 mW)	
	U2022XA	-	-	-	√ <sup>1</sup>	-	Diode Power Sensor	50 MHz to 40 GHz	-35 dBm (316 nW) to +20 dBm (100 mW)	
Wideband power sensors	N1923A	-	-	-	√	-	Diode Power Sensor	50 MHz to 18 GHz	-35 dBm (316 nW) to +20 dBm (100 mW)	
	N1924A	-	-	-	√	-	Diode Power Sensor	50 MHz to 40 GHz	-35 dBm (316 nW) to +20 dBm (100 mW)	
P-Series Wideband sensors	N1921A	-	-	√	√	-	Diode Power Sensor	50 MHz to 18 GHz	-35 dBm (316 nW) to +20 dBm (100 mW)	
	N1922A	-	-	√	√	-	Diode Power Sensor	50 MHz to 40 GHz	-35 dBm (316 nW) to +20 dBm (100 mW)	
E-Series Peak-and-Average sensors	E9321A	-	-	√	-	√	Diode Power Sensor	50 MHz to 6 GHz	-65 dBm (320 pW) to +20 dBm (100 mW)	
	E9322A	-	-	√	-	√	Diode Power Sensor	50 MHz to 6 GHz	-60 dBm (1 nW) to +20 dBm (100 mW)	
	E9323A	-	-	√	-	√	Diode Power Sensor	50 MHz to 6 GHz	-60 dBm (1 nW) to +20 dBm (100 mW)	
	E9325A	-	-	√	-	√	Diode Power Sensor	50 MHz to 18 GHz	-65 dBm (320 pW) to +20 dBm (100 mW)	
	E9326A	-	-	√	-	√	Diode Power Sensor	50 MHz to 18 GHz	-60 dBm (1 nW) to +20 dBm (100 mW)	
	E9327A	-	-	√	-	√	Diode Power Sensor	50 MHz to 18 GHz	-60 dBm (1 nW) to +20 dBm (100 mW)	
E-Series True Average sensors	E9300A	-	√	√	-	√	Diode Power Sensor	10 MHz to 18 GHz	-60 dBm (1 nW) to +20 dBm (100 mW)	
	E9301A	-	√	√	-	√	Diode Power Sensor	10 MHz to 6 GHz	-60 dBm (1 nW) to +20 dBm (100 mW)	
	E9304A	-	√	√	-	√	Diode Power Sensor	9 kHz to 6 GHz	-60 dBm (1 nW) to +20 dBm (100 mW)	
	E9300B	-	√	√	-	√	Diode Power Sensor	10 MHz to 18 GHz	-30 dBm (1 μW) to +44 dBm (25 W)	
	E9301B	-	√	√	-	√	Diode Power Sensor	10 MHz to 6 GHz	-30 dBm (1 μW) to +44 dBm (25 W)	
	E9300H	-	√	√	-	√	Diode Power Sensor	10 MHz to 18 GHz	-50 dBm (10 nW) to +30 dBm (1 W)	
E-Series CW-only sensors	E4412A	-	√	√	-	√	Diode Power Sensor	10 MHz to 18 GHz	-70 dBm (100 pW) to +20 dBm (100 mW)	
	E4413A	-	√	√	-	√	Diode Power Sensor	50 MHz to 26.5 GHz	-70 dBm (100 pW) to +20 dBm (100 mW)	
N8480 / 8480 Series Thermocouple and Diode sensors	N8481A	-	√	√	-	√	Thermocouple Power Sensor	10 MHz to 18 GHz	-35 dBm (316 nW) to +20 dBm (100 mW)	
	N8482A	-	√	√	-	√	Thermocouple Power Sensor	100 kHz to 6 GHz	-35 dBm (316 nW) to +20 dBm (100 mW)	
	8483A 75 ohms	-	√	√	-	√	Thermocouple Power Sensor	100 kHz to 2 GHz	-30 dBm (1 μW) to +20 dBm (100 mW)	
	N8485A	-	√	√	-	√	Thermocouple Power Sensor	10 MHz to 26.5 GHz	-35 dBm (316 nW) to +20 dBm (100 mW)	
	N8487A	-	√	√	-	√	Thermocouple Power Sensor	50 MHz to 50 GHz	-35 dBm (316 nW) to +20 dBm (100 mW)	
	N8488A	-	√	√	-	√	Thermocouple Power Sensor	10 MHz to 67 GHz	-35 dBm (316 nW) to +20 dBm (100 mW)	

1. Requires BenchVue Power Meters/Sensors Control and Analysis App software

\* For the complete list of sensor options, please visit our Web site at [www.keysight.com/find/powermeters](http://www.keysight.com/find/powermeters).

## Power Meters and Sensors Compatibility Table

		POWER METERS						Product Description / Sensor Tech.	Frequency Range	Power Range
		N432A	N1913A/14A	N1911A/12A N8262A P-Series	8990B	E4416A/17A EPM-P				
POWER SENSORS	N8480 / 8480 Series Thermocouple and Diode sensors	N8481B	-	√	√	-	√	High Power Thermocouple Sensor	10 MHz to 18 GHz	-5 dBm (316 μW) to +44 dBm (25 W)
		N8482B	-	√	√	-	√	High Power Thermocouple Sensor	100 kHz to 6 GHz	-5 dBm (316 μW) to +44 dBm (25 W)
		N8481H	-	√	√	-	√	High Power Thermocouple Sensor	10 MHz to 18 GHz	-15 dBm (32 μW) to +35 dBm (3 W)
		N8482H	-	√	√	-	√	High Power Thermocouple Sensor	100 kHz to 6 GHz	-15 dBm (32 μW) to +35 dBm (3 W)
		8481D	-	√	√	-	√	Diode Power Sensor	10 MHz to 18 GHz	-70 dBm (100 pW) to -20 dBm (10 μW)
		8485D	-	√	√	-	√	Diode Power Sensor	50 MHz to 26.5 GHz	-70 dBm (100 pW) to -20 dBm (10 μW)
		8487D	-	√	√	-	√	Diode Power Sensor	50 MHz to 50 GHz	-70 dBm (100 pW) to -20 dBm (10 μW)
	Waveguide sensors	R8486D	-	√	√	-	√	Waveguide Power Sensor	26.5 GHz to 40 GHz	-70 dBm (100 pW) to -20 dBm (10 μW)
		Q8486D	-	√	√	-	√	Waveguide Power Sensor	33 GHz to 50 GHz	-70 dBm (100 pW) to -20 dBm (10 μW)
		N8486AR	-	√	√	-	√	Thermocouple Waveguide Power Sensor	26.5 GHz to 40 GHz	-35 dBm (316 μW) to +20 dBm (100 mW)
		N8486AQ	-	√	√	-	√	Thermocouple Waveguide Power Sensor	33 GHz to 50 GHz	-35 dBm (316 μW) to +20 dBm (100 mW)
		V8486A	-	√	√	-	√	V-band Power Sensor	50 GHz to 75 GHz	-30 dBm (1 μW) to +20 dBm (100 mW)
		W8486A	-	√	√	-	√	Waveguide Power Sensor	75 GHz to 110 GHz	-30 dBm (1 μW) to +20 dBm (100 mW)
		E8486A	-	√	√	-	√	E-band Power Sensor	60 GHz to 90 GHz	-30 dBm (1 μW) to +20 dBm (100 mW)
	Thermistor mount sensors	478A	√	-	-	-	-	Coaxial Thermistor Mount	10 MHz to 10 GHz	-30 dBm (1 μW) to +10 dBm (10 mW)
		8478B	√	-	-	-	-	Coaxial Thermistor Mount	10 MHz to 18 GHz	-30 dBm (1 μW) to +10 dBm (10 mW)
	USB average sensors	U2000A	-	√	-	√ <sup>1</sup>	-	Diode Power Sensor	10 MHz to 18 GHz	-60 dBm (1 nW) to +20 dBm (100 mW)
		U2001A	-	√	-	√ <sup>1</sup>	-	Diode Power Sensor	10 MHz to 6 GHz	-60 dBm (1 nW) to +20 dBm (100 mW)
		U2002A	-	√	-	√ <sup>1</sup>	-	Diode Power Sensor	50 MHz to 24 GHz	-60 dBm (1 nW) to +20 dBm (100 mW)
		U2004A	-	√	-	√ <sup>1</sup>	-	Diode Power Sensor	9 kHz to 6 GHz	-60 dBm (1 nW) to +20 dBm (100 mW)
		U2000B	-	√	-	√ <sup>1</sup>	-	Diode Power Sensor	10 MHz to 18 GHz	-30 dBm (1 μW) to +44 dBm (25 W)
		U2001B	-	√	-	√ <sup>1</sup>	-	Diode Power Sensor	10 MHz to 6 GHz	-30 dBm (1 μW) to +44 dBm (25 W)
		U2000H	-	√	-	√ <sup>1</sup>	-	Diode Power Sensor	10 MHz to 18 GHz	-50 dBm (10 nW) to +30 dBm (1 W)
		U2001H	-	√	-	√ <sup>1</sup>	-	Diode Power Sensor	10 MHz to 6 GHz	-50 dBm (10 nW) to +30 dBm (1 W)
	U2002H	-	√	-	√ <sup>1</sup>	-	Diode Power Sensor	50 MHz to 24 GHz	-50 dBm (10 nW) to +30 dBm (1 W)	

1. Requires BenchVue Power Meters/Sensors Control and Analysis App software

\* For the complete list of sensor options, please visit our Web site at [www.keysight.com/find/powermeters](http://www.keysight.com/find/powermeters).

## Free Power Measurement Hints and Tips

Keysight offers a wide selection of power meters and sensors for your application needs, and to help you make better measurements in less time, we've compiled an array of resources for you.

Visit the Power Measurement Hints and Tips page at [www.keysight.com/find/rfpowertips](http://www.keysight.com/find/rfpowertips) for application notes, technical overviews and other power meter and sensor related tools.

## Related Keysight Literature

Here are some key topics that may interest you:

Publication title	Publication number
<i>Long-Term, Remote Monitoring of Satellite Performance</i>	5991-3681EN
<i>Achieving Accurate E-band Power Measurements with Keysight E8486A Waveguide Power Sensors</i>	5991-3776EN
<i>An RF Power Measurement Solution for Multi-antenna MIMO Transmissions</i>	5991-3097EN
<i>Understanding DC-coupled and DC-blocked Power Sensors and How Your Choice of Sensor Would Impact Measurement Accuracy</i>	5990-6745EN
<i>MIMO Measurement Tips with Keysight P-Series Power Meters and U2000 Series USB Power Sensors</i>	5990-3546EN
<i>P-Series and EPM-P Power Meters for Bluetooth Testing</i>	5989-8459EN
<i>4 Steps for Making Better Power Measurements</i>	5965-8167E
<i>Choosing the Right Power Meter and Sensor</i>	5968-7150E

## Watch a Live Demonstration or Video Introduction

Visit the Power Meter and Sensor playlist on the Keysight YouTube network at [www.keysight.com/find/pmps-video](http://www.keysight.com/find/pmps-video) to see the latest videos related to Keysight's power meter and sensor family.

Learn more at: [www.keysight.com](http://www.keysight.com)

For more information on Keysight Technologies' products, applications or services, please contact your local Keysight office. The complete list is available at: [www.keysight.com/find/contactus](http://www.keysight.com/find/contactus)

