

Anritsu envision : ensure

Network Master™ Series

Network Master Flex MT1100A

10G Multirate Module MU110010A

100G Multirate Module MU110011A

40/100G Advanced Module MU110013A



Transport Tester for Evolving

Versatile Support up to 100 Gbps plus High Work Efficiency at R&D and Mass-Production Manufacturing

Today's core and metro communications networks are implementing 100 GigE and OTN technologies rapidly to provide sufficient bandwidth supporting the explosive increase in mobile communications data. These high-bit-rate networks demand very high reliability due to the large data volumes and variety of client signals in use.

Consequently, every stage from R&D through to manufacturing, installation, and maintenance, requires precision testing and verification of network equipment and transport devices.

The all-in-one Network Master Flex MT1100A supports the communications network technologies.

Selecting and installing up to two modules from a range of three module options supports all-in-one R&D, manufacturing, installation and maintenance tests of network and transport equipment operating at bit rates from 1.5 Mbps to 100 Gbps. The large, 12.1-inch color LCD touch panel with easy-to-use GUI plus remote operation of a full range of test functions over an Internet connection greatly improves test efficiency and helps cut costs.



Networks

400G
100G
Core and Metro Networks
OTN
flex mapping

All in
One

100G
4ports

OTN
flex
mapping

All-in-one Transport Tester

- Supports testing from 1.5 Mbps to 100 Gbps
- Support for various transport tests

Supports Up to 400 Gbps (100G × 4)

- Install any two modules from choice of three module options
- Test up to four independent 100 Gbps ports simultaneously to increase manufacturing efficiency for 100 Gbps transport equipment
- Support 400 Gbps (100G × 4) R&D by simulating client signals

OTN Flexible Mapping

- Various OTN mappings up to 100 Gbps
- Supports both multi-stage mappings and ODUflex
- Supports mapped client-signal tests

Main Applications

R&D

- Research and development of 400 Gbps networks and transport equipment

Manufacturing

- Quality and assurance tests of 100 Gbps transport equipment

Commissioning

- Verification of Service Level Agreement (SLA) at commissioning of 1.5 Mbps to 100 Gbps lines

Maintenance

- Troubleshooting 1.5 Mbps to 100 Gbps line faults

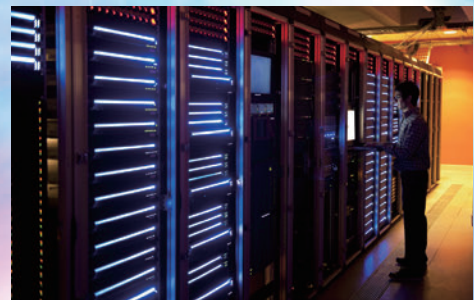

MT1 100A

Network Master Flex MT1100A Function Overview

The all-in-one Network Master Flex MT1100A supports all the latest communications network technologies. Selecting and installing up to two modules from a range of three module options supports all-in-one R&D, manufacturing, installation and maintenance tests of network and transport equipment operating at bit rates from 1.5 Mbps to 100 Gbps. The large, 12.1-inch color LCD touch panel with easy-to-use GUI plus remote operation of a full range of test functions over an Internet connection greatly improves test efficiency and helps cut costs.

All-in-one

The all-in-one MT1100A has the functions required for developing, manufacturing, installing and maintaining networks at bit rates from 1.5 Mbps to 100 Gbps. With four 100 Gbps ports, it supports R&D of the latest OTN 400 Gbps technologies using client signals, including Ethernet, eCPRI/RoE (IEEE1914.3)/CPRI/OBSAI, Fibre Channel, SDH/SONET and PDH/DSn, now in development.

• OTN Testing with Client Signals

The MT1100A can map Ethernet, CPRI, Fibre Channel, and SDH/SONET client signals onto OTN signals. Mapped OTN client-signal tests under near-to-live conditions support faster troubleshooting.

• Easy-to-Use GUI

The user interface is optimized for troubleshooting by field technicians and to reduce training time. It has a logical structure and self-explanatory graphical symbols. Tests are started by launching an intuitive application, and main results are displayed as GO/NO-GO indications. User-programmed application favorites including all required test parameters make operation fast and easy.

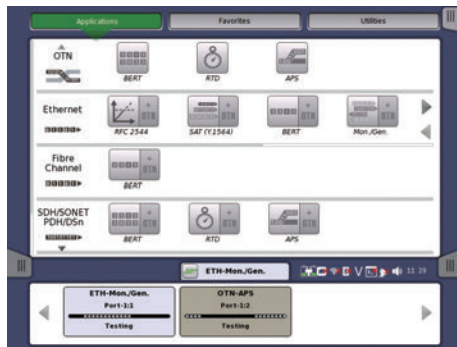

• Simultaneous Testing and In-band Monitoring with Dual Port

Configuring the MT1100A with two ports*1 at all supported rates reduces test times by completing independent tests simultaneously on two lines using a single tester. Or separate measurement test applications can be run independently at the same time.

Support for dual ports is also important at analysis of in-service lines when analyzing the performance of both line directions simultaneously.

*1: MU110011A 100G: 1 port

• Optical Transceiver Analysis

The MT1100A reads and displays the main MDIO parameters of optical transceivers for at-a-glance confirmation of settings and monitoring data. It displays details for each alarm item for CFP/CFP2/QSFP28*2 and can also read from/write to each MDIO/I2C address. Additionally, settings such as VOD, Pre-Emphasis, Rx Equalizer can be changed for each PCS lane to test the impact on the performance of each electrical I/F.

Last, adding an option*3 enables error/alarm insertion at CAUI4 interfaces for isolating optical transceiver and network faults.

*2: When Z2046A, Z2047A, and Z2048A are used.

*3: MU110013A only

• 12.1-inch Touch Screen for Easy Viewing and Operation

The large 12.1-inch, high-resolution, full-color, touch screen is perfect for viewing results. And the touch screen makes instrument operations easy.

• Fast Measurement Overview

Using the Overall Test Status screen, viewing the test status for all current test applications belonging to one user from a distance is easy. For each test application, the Measurement Summary function allows rapid overview of measurements using GO/NO-GO indications with user-defined thresholds. Statistical histograms facilitate error tracking over time.

• Flexible Connectivity

WLAN, Bluetooth and LAN connectivity ensure quick and simple tester access in any situation. While remote operation allows an experienced engineer to assist colleagues in the field.

• Report Generation

The powerful and flexible report generator creates PDF, CSV or XML files for selected measurements to output results in a professional and attractive looking format. The user can customize the detailed contents of the statistical reports, allowing only the most important information to be included.

• Remote Operation and Control

Remote operation from a distance is simple using the Remote Operation function, allowing operation as if on-site. The dedicated remote GUI operation software allows multiple users not only remote operation but also remote boot-up, file transfer, firmware update via Ethernet or WLAN. Moreover, the dedicated Remote Control software can work stand-alone, allowing users to generate reports and analyze results offline in addition to setting-up files without accessing a MT1100A. The remote scripting function cuts the manual operation time, eliminating human testing errors. The MT1100A supports Ethernet, WLAN and GPIB for remote scripting.

• Portable

The high portability and robustness of the MT1100A ensure quick location of faults wherever you are. This light, small instrument is just a fraction larger than its 12.1-inch screen, offering easy access in the tightest locations. The large GUI makes it easy to quickly configure, locate, solve, and report on network issues.

• Long Battery Life

Since AC power is not always available when needed. The battery-operated MT1100A (operating time depends on configuration) is convenient for instant on-site troubleshooting with no need to search for a power outlet.

The Bluetooth® mark and logos are owned by Bluetooth SIG, Inc. and are used by Anritsu under license.

Network Master Flex MT1100A Function Overview

R&D for 400 Gbps Networks

R&D into faster 400 Gbps networks is being driven by the explosive growth in smartphone mobile data traffic.

The MT1100A can send and receive a variety of 100G × 4 client signals, offering support for R&D of 400 Gbps networks and transport equipment.

Features

- Transport testers supporting simultaneous installation of four independent 100 Gbps ports
- Multiple users can log in one MT1100A via PC and operate each port independently using the dedicated remote GUI operation software.
- Each 100 Gbps port supports 40 GigE/100 GigE and OTU4/OTU3/OTU3e1/OTU3e2 interfaces
- Detailed client-signal analysis using Ethernet frame capture
- Support various OTN mappings including ODUflex
- FEC Performance tests using ITU-T O.182 recommended Poisson-distribution error insertion
- Display test results for four ports on one screen

Recommended modules: MU110013A × 2

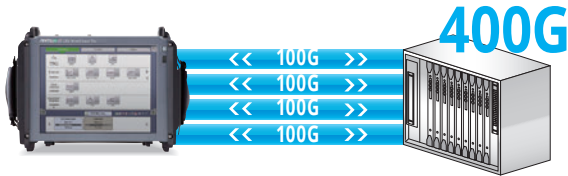

Higher 100 Gbps Transport Equipment Manufacturing Efficiency

Manufacturing of 100 Gbps WDM, switches and optical transceiver modules are being. With all the functions needed for testing transport equipment, the 4-port, all-in-one MT1100A with automatic testing using SCPI commands is the ideal platform for maximizing equipment investment through higher test efficiency and lower cost per port.

Features

- Supports OTN, Ethernet, eCPRI/RoE (IEEE1914.3)/CPRI/OBSAI, Fibre Channel, SDH/SONET and PDH/DSn at bit rates from 1.5 Mbps to 100 Gbps using combination of modules
- RFC 2544-based transmission equipment performance tests
- Color display of threshold settings and Pass/Fail evaluation results
- Optical transceiver modules analysis using MDIO analysis and VOD, Pre-emphasis, Rx equalizer control.
- Various high speed interfaces support CFP2, CXP, QSFP+, QSFP28 (QSFP28 when using Z2046A, Z2047A, and Z2048A)
- Automatic repeat testing using SCPI remote commands via Ethernet, WLAN or GPIB
- Multiple users can log in one MT1100A via PC and operate each port independently using the dedicated remote GUI operation software.

Recommended modules: MU110013A × 2 (for four 40 Gbps/100 Gbps ports)



Quick Network Commissioning Tests

Efficient and accurate network commissioning tests in a limited time window are a key issue for network operators. With its all-in-one support for transport tests, including OTN, eCPRI/RoE (IEEE1914.3)/CPRI/OBSAI, SyncE, PTP (IEEE 1588 v2), ITU-T Y.1564, RFC 6349 etc., plus simultaneous multiple-line tests using two ports, the MT1100A helps cut costs by slashing test times.

Features

- All-in-one support for network commissioning transport tests up to 100 Gbps
- Large, 12.1-inch touch-panel GUI with battery operation
- Frame loopback using remote-controlled MT1100A as Ethernet reflector
- One-way latency tests using operation at Master side at remote control Master/Slave setup
- Time synchronization for the SyncE and IEEE 1588 v2 one-way latency tests is supported using the GPS antenna (option)
- Support Mobile fronthaul deployment and maintenance by eCPRI/RoE/CPRI/OBSAI test
- Network performance check at the end users site by TCP throughput testing with RFC 6349 or iPerf.
- Remote operation over VNC for operations-center support of on-site engineers
- Remote boot-up, operation, file transfer, firmware update
- Halved measurement times using simultaneous 2-port, multi-line testing

Recommended modules: MU110011A



Fast and Flexible Troubleshooting

Today's data centers have a mix of interfaces ranging from old legacy network equipment to the 100 Gbps core networks. With excellent built-in troubleshooting functions as well as dual ports for simultaneous two-way monitoring, the MT1100A locates problems quickly.

Features

- Dual ports supporting bit rates from 1.5 Mbps to 100 Gbps for two-way monitoring and equipment insertion tests
- Top talker, network attack, and fast error-frame capture using IP Channel Statistics (up to 10 Gbps)
- Ethernet frame capture and Wireshark analysis
- Live line monitoring at Through testing
- Battery operation for fast on-site troubleshooting anywhere
- Long-term monitoring using remote operation over VNC or the dedicated remote GUI operation software

Recommended modules: MU110010A + MU110013A
(two ports for 1.5 Mbps to 100 Gbps ports)



Wireshark® is a registered trademark of the Wireshark Foundation.

Panel Layout (Main frame)

Connector Panel Overview

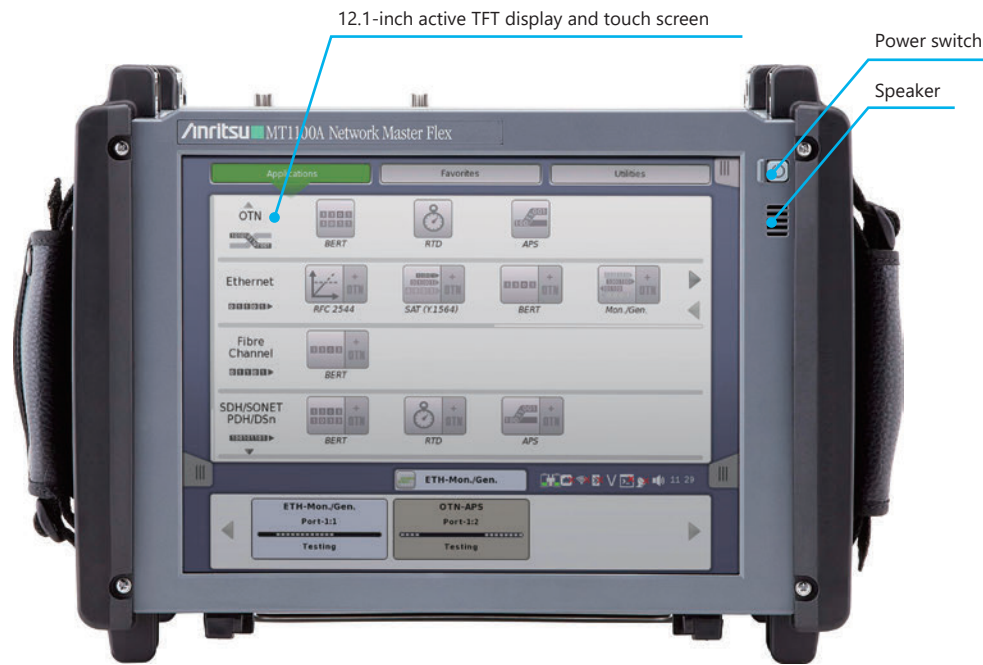
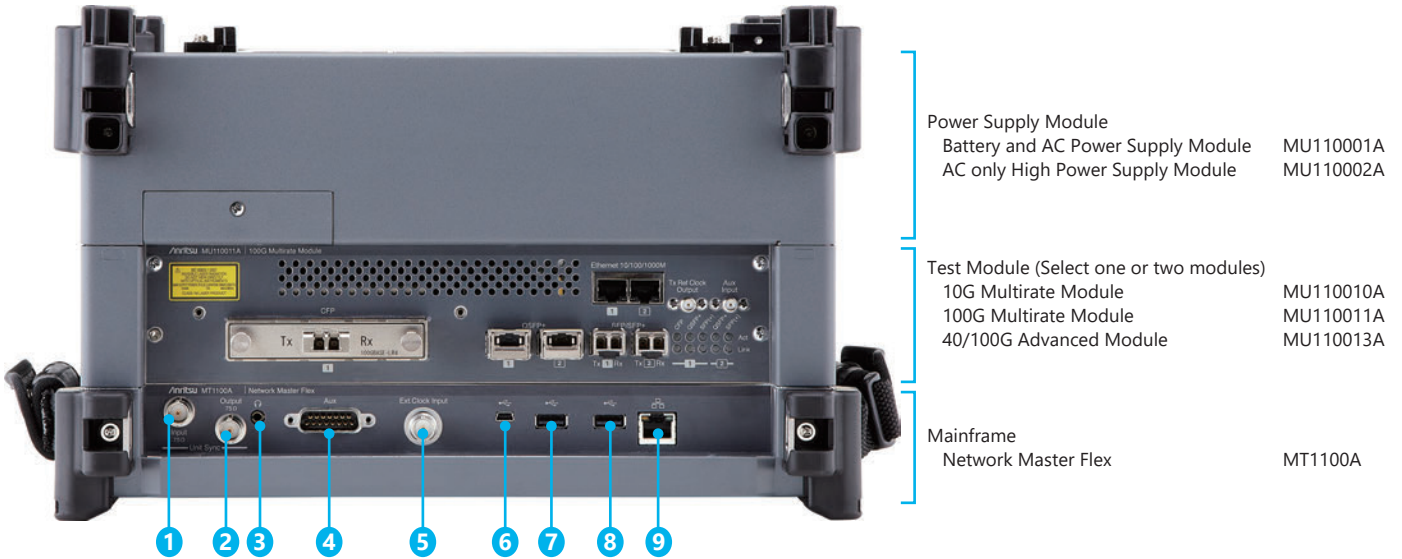

- 1 Unit Sync. Input (for future use)
- 2 Unit Sync. Output (for future use)
- 3 Audio (3.5ø: CTIA Standard)
- 4 AUX (for G0325A, GPS receiver)
- 5 External Clock Input
- 6 USB Mini-B
- 7 USB A
- 8 USB A
- 9 Ethernet Service Interface

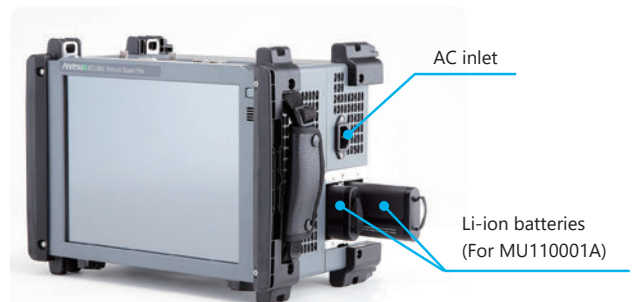

MT1100A + MU110001A + MU110011A Overview

Panel Layout (Measurement Module)

10G Multirate Module MU110010A

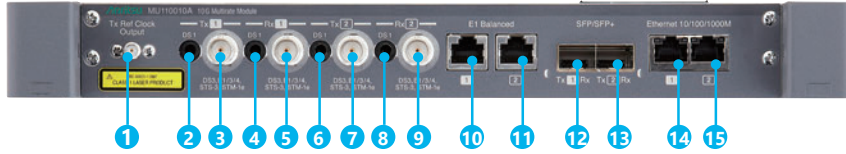

- 1 Tx Reference Clock Output
- 2 Port1, Tx Mini-bantam (DS1)
- 3 Port1, Tx BNC (E1, E3, E4, DS3, STM-1e, STS-3)
- 4 Port1, Rx Mini-bantam (DS1)
- 5 Port1, Rx BNC (E1, E3, E4, DS3, STM-1e, STS-3)
- 6 Port2, Tx Mini-bantam (DS1)
- 7 Port2, Tx BNC (E1, E3, E4, DS3, STM-1e, STS-3)
- 8 Port2, Rx Mini-bantam (DS1)
- 9 Port2, Rx BNC (E1, E3, E4, DS3, STM-1e, STS-3)
- 10 Port1, Tx/Rx RJ48 (E1 balanced)
- 11 Port2, Tx/Rx RJ48 (E1 balanced)
- 12 Port1, Tx/Rx SFP/SFP+ (OTN, Ethernet, eCPRI/RoE/CPRI/OBSAI, Fibre Channel, SDH/SONET optical)
- 13 Port2, Tx/Rx SFP/SFP+ (OTN, Ethernet, eCPRI/RoE/CPRI/OBSAI, Fibre Channel, SDH/SONET optical)
- 14 Port1, Tx/Rx RJ45 (Ethernet, eCPRI/RoE electrical)
- 15 Port2, Tx/Rx RJ45 (Ethernet, eCPRI/RoE electrical)

100G Multirate Module MU110011A

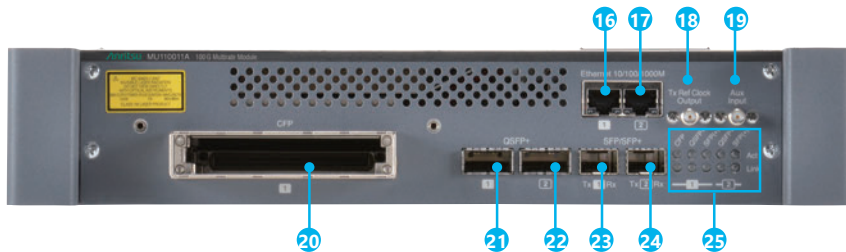

- 16 Port1, Tx/Rx RJ45 (Ethernet, eCPRI/RoE electrical)
- 17 Port2, Tx/Rx RJ45 (Ethernet, eCPRI/RoE electrical)
- 18 Tx Reference Clock Output
- 19 AUX Input (for future use)
- 20 Tx/Rx CFP (OTN, Ethernet, eCPRI/RoE, SDH/SONET optical)
- 21 Port1, Tx/Rx QSFP+ (OTN, Ethernet, eCPRI/RoE optical)
- 22 Port2, Tx/Rx QSFP+ (OTN, Ethernet, eCPRI/RoE optical)
- 23 Port1, Tx/Rx SFP/SFP+ (OTN, Ethernet, eCPRI/RoE/CPRI/OBSAI, Fibre Channel, SDH/SONET optical)
- 24 Port2, Tx/Rx SFP/SFP+ (OTN, Ethernet, eCPRI/RoE/CPRI/OBSAI, Fibre Channel, SDH/SONET optical)
- 25 Act, Link Indicators

40/100G Advanced Module MU110013A

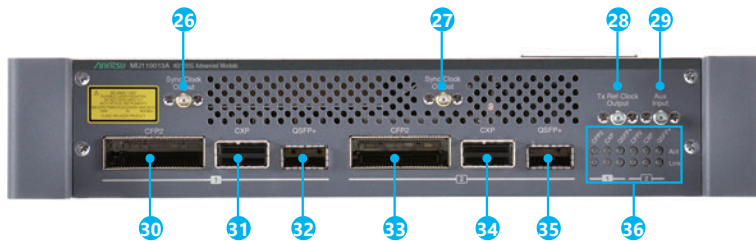

- 26 Port1, CFP2 Sync. Clock Output
- 27 Port2, CFP2 Sync. Clock Output
- 28 Tx Reference Clock Output
- 29 AUX Input (for future use)
- 30 Port1, Tx/Rx CFP2 (OTN, Ethernet, eCPRI/RoE optical)
- 31 Port1, Tx/Rx CXP (Ethernet, eCPRI/RoE optical)
- 32 Port1, Tx/Rx QSFP+ (OTN Ethernet, eCPRI/RoE optical)
- 33 Port2, Tx/Rx CFP2 (OTN, Ethernet, eCPRI/RoE optical)
- 34 Port2, Tx/Rx CXP (Ethernet, eCPRI/RoE optical)
- 35 Port2, Tx/Rx QSFP+ (OTN Ethernet, eCPRI/RoE optical)
- 36 Act, Link Indicators

Ethernet Application

Carrier Ethernet Installation and Troubleshooting

Ethernet technology is used by many applications today, including Carrier Class Ethernet, VLAN, Q-in-Q, Ethernet OAM and MPLS and, recently, PBB and MPLS-TP. Network operators must handle all these technologies, leading to long and complex test procedures. The MT1100A with Ethernet option is a comprehensive solution for easy testing, installing, and faster troubleshooting of Ethernet lines up to 100 Gbps using functions for verifying bandwidth, and testing connectivity, Quality of Service (QoS), and service availability, cutting additional truck rolls, tech support calls, and customer churn to improve operating expenses.

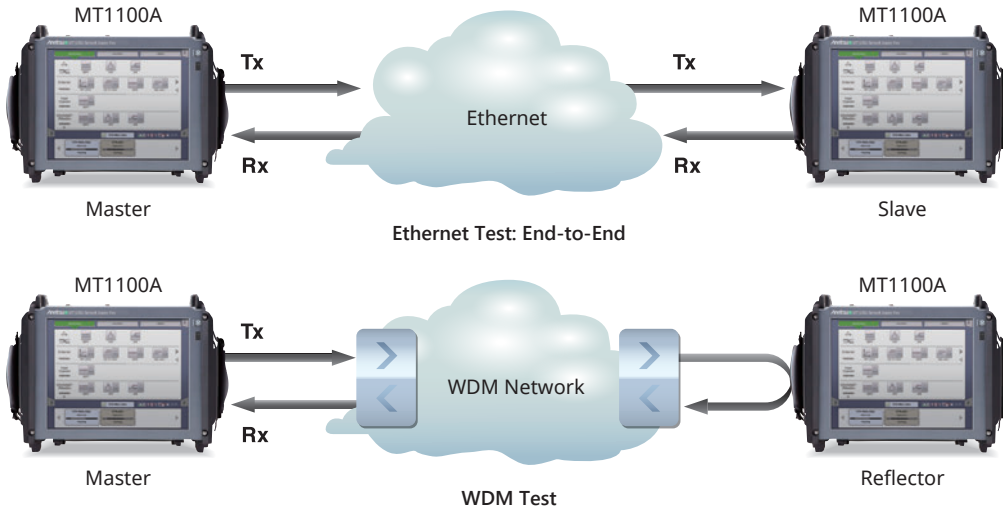

Ethernet test features include:

- Supports 100 Gbps, 40 Gbps, 10 Gbps, 1 Gbps, 100 Mbps, and 10 Mbps Ethernet tests
- Supports 100 Gbps RS-FEC test
- Traffic generation up to full line rate
- Support for IPv4 and IPv6
- Ethernet Service Activation Test (Y.1564)
- Automated RFC 2544 tests of Throughput, Frame Loss, Latency or Packet Jitter, Burstability
- TCP Throughput (RFC 6349, iPerf) [Option] (up to 10 Gbps)
- BER tests – include Frame Loss and Sequence Error tests
- Service disruption measurements
- Comprehensive statistics
- Filters – to extract relevant parts of traffic
- Thresholds – to highlight abnormalities
- Simultaneous monitoring in both line directions
- IP Channel Statistics to identify error streams, top talkers, network attacks (up to 10 Gbps)
- Ethernet OAM tests
- 10G WAN-PHY tests
- Synchronous Ethernet test (up to 10 Gbps)
- Ethernet Multistream
- Stacked VLAN (Q-in-Q)
- MPLS tests
- MPLS-TP and PBB tests
- Ping/Traceroute
- Frame capture for protocol analysis with Wireshark
- Electrical cable tests and optical signal level displays

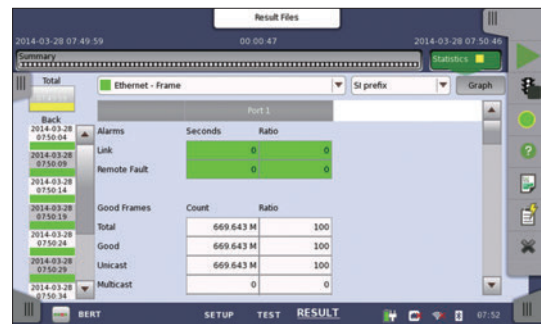

Ethernet Statistics

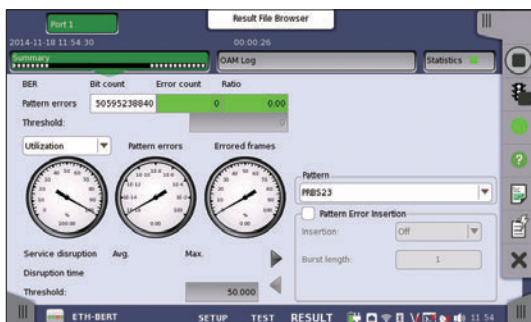

Ethernet BER Tests Statistics Summary

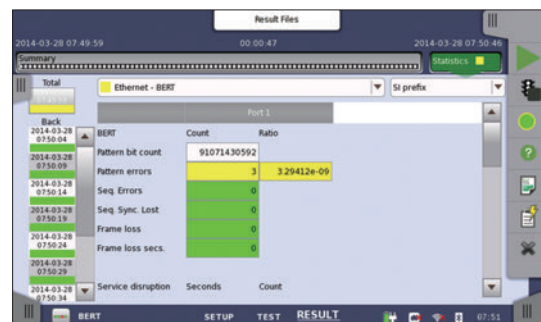

Ethernet BER Tests Results

100 GigE RS-FEC Test

Forward Error Correction (FEC) is a technology for preventing errors when sending and receiving data. It assigns redundancy to the Tx data beforehand so any errors in the data occurring during transmission can be detected and corrected at the receiver side. FEC helps keep the average data throughput high by preventing the need to resend data. The MT1100A can send and receive* FEC signals supported by 100GBASE-SR4, and 100GBASE-ER4-lite (FEC Code: RS (528, 514, 7,10)) to help evaluate network equipment and facilitate RS-FEC communications.

*: Enabled for CFP2 and QSFP28 optical-module settings.

Ethernet Service Activation Test (Y.1564)

With the ability to simultaneously test multiple traffic streams, ITU-T Y.1564 is a new test methodology when deploying Ethernet networks. Today's common RFC 2544 standard completes tests one at the time and does not run all traffic streams simultaneously. ITU-T Y.1564 has the following two test phases.

- **Service Configuration Test:**

This section is completed quickly, within seconds per stream. It confirms the end-to-end configuration while quickly checking the Information Rate (IR), Frame Transfer Delay (FTD), Frame Delay Variation (FDV), Frame Loss Ratio (FLR), Committed Burst Size (CBS) and Excess Burst Size (EBS) sequentially for all configured traffic streams.

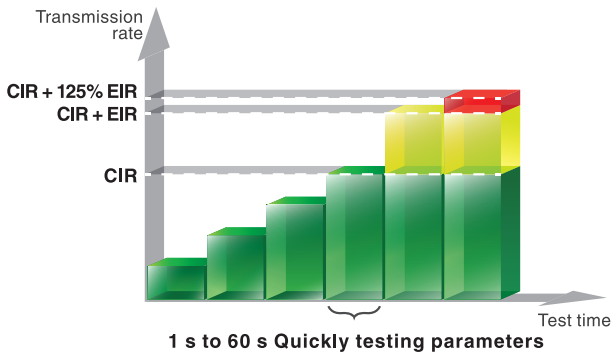

Y.1564 Service Configuration Test

- **Service Performance Test:**

This section is completed based on the M.2110 standard for 15 minutes, 2 hours, 24 hours, or a user-selectable period. It transmits all configured traffic streams simultaneously at the CIR, confirming that all traffic can traverse the network under full load while checking IR, FTD, FDV, FLR and Availability (AVAIL).

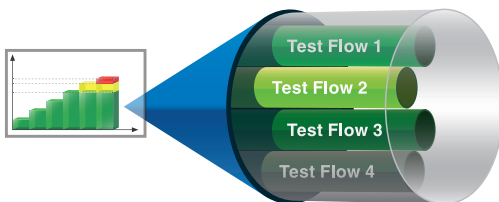

Y.1564 Service Performance Test

Simultaneous testing in the Service Performance Test section greatly reduces the total test time compared to RFC 2544.

RFC 2544 Test

RFC 2544 testing of Throughput, Frame Loss, Latency, Packet Jitter and Burstability is straightforward with the MT1100A.

It automates the procedure while still allowing thorough test configuration. For full information on performance at both line sides, the end-to-end test mode allows two MT1100A testers to work together in a local-remote configuration where the user controls both together and reads results from both locally. Easy to understand tabular screens and bar graph presentations simplifies reading of results. Attractive looking reports can be generated for presentation to end-customers.

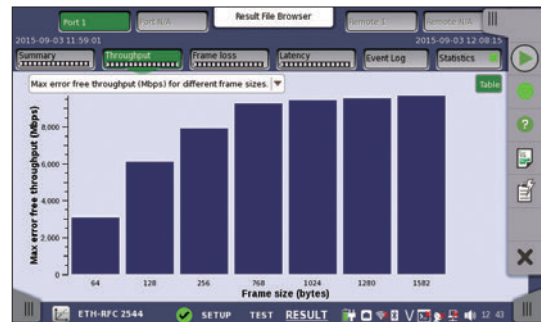
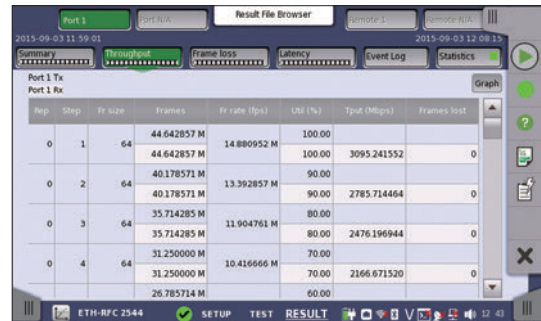

TCP Throughput (RFC 6349, iPerf) [Option] (Up to 10 Gbps)

Optimizing performance is essential in modern communication networks. In IP networks, operators can test based on IETF RFC 2544 and ITU-T Y.1564, but even if they find that their networks are working fine using these tests, customers may complain that the achieved throughput is below their agreement with the operator. This may be caused by a non-optimum configuration of the Transmission Control Protocol (TCP) providing higher layer connections through the network. RFC 6349 is a test methodology that operators can use to optimize TCP throughput. The MT1100A with TCP Throughput option is ideally suited to supporting TCP throughput optimization based on RFC 6349. iPerf client for TCP Throughput testing is also supported.

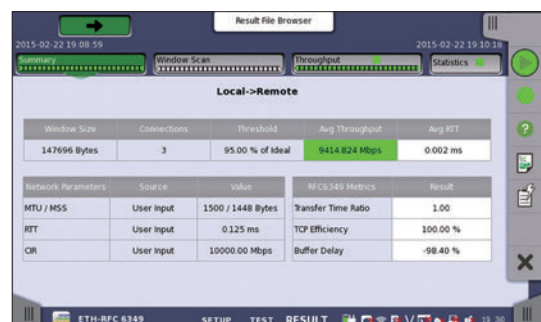

Ethernet Application

Carrier Ethernet Installation and Troubleshooting

Pass-through Mode

Configuring the MT1100A to Pass-through mode supports detailed troubleshooting, especially in bi-directional networks requiring traffic monitoring from both ends.

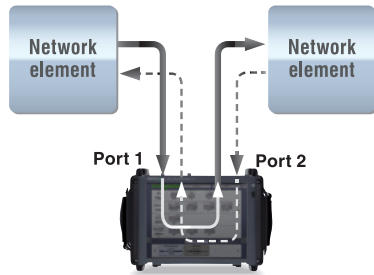

Pass-through monitoring by inserting MT1100A in network

IP Channel Statistics – Multiflow Counters

Up to 230 flows can be selected and filtered by MAC and IP Source/ Destination addresses, VLAN and MPLS to monitor selected streams and display detailed information. This allows the user to identify error streams, top talkers, and network attacks, as well as troubleshoot network issues more deeply. (Up to 10 Gbps)

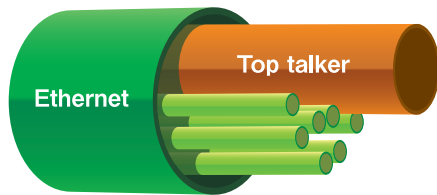

Ethernet OAM

To improve the performance of Ethernet-based networks and provide Carrier Class service, many network providers have enhanced their systems with Ethernet OAM (Operation, Administration and Maintenance), supporting the ability to detect network faults and measure performance. Ethernet OAM is defined by three standards covering different network sections. The ITU-T Y.1731 and IEEE 802.1ag standards are similar and support end-to-end network functionality, while the IEEE 802.3 (previously IEEE 802.3ah) standard supports first (or last) mile functionality. The MT1100A tests the network using all supported OAM functions.

Ethernet Multistream

The MT1100A Ethernet Multistream function allows simulation and testing of a congested network's ability to prioritize high-priority traffic over low-priority traffic. The user can set different priorities for up to 16 streams per port to measure how frame loss affects network performance. The Multistream function displays clear information on Packet Jitter and Latency per stream, helping troubleshoot problematic issues for VoIP services, etc.



Multi Stream Setting

Ethernet Application

Carrier Ethernet Installation and Troubleshooting

Stacked VLAN

Stacked VLAN (Q-in-Q) is used increasingly by several types of Ethernet-based networks, allowing operators to split traffic from different customers on one line or to shape traffic by priority. The MT1100A supports up to 8 levels of VLAN tags, offering a powerful network test tool.

MPLS and MPLS-TP

Multi-Protocol Label Switching (MPLS) supports efficient traffic routing on packet-based networks. MPLS – Transport Profile (MPLS-TP) technology is based on standard MPLS and aims to give service providers reliable connection-oriented packet-based transport over the network. MPLS-TP offers service providers QoS, end-to-end Carrier Class OAM, and protection switching. With its ability to insert up to 8 levels of MPLS labels, the MT1100A is a powerful tool for testing MPLS and MPLS-TP networks including OAM functions.



Protocol Counter

PBB

The Provider Backbone Bridge (PBB) technology is designed to provide Carrier Class division of the networks at layer 2 often referenced as MAC-in-MAC. Allowing multiple provider bridge networks to be interconnected without VLAN addresses conflict

Protocol Analysis

For advanced Ethernet troubleshooting the MT1100A supports a frame capture function for capturing frames of live traffic on the monitored line. Captured frames are analyzed using the Wireshark protocol analysis software.

In-Band Test

Usually at least two field technicians must be dispatched for end-to-end testing, but using the MT1100A in-band measurement function to control the remote MT1100A from the local MT1100A via the test network, cuts the number of required field technicians and increases work efficiency.

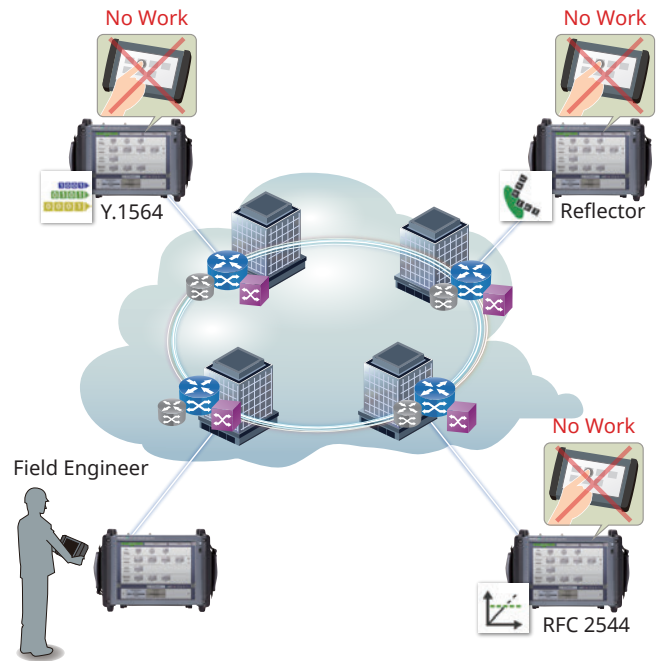

Comprehensive OTN Testing for Core and Metro Networks Installation and Maintenance

OTN carries client signals, but current OTN transport testers only support OTN testing at the OTN line rate with bulk test signals. This means that problems in the carried client signals are invisible when testing an in-service OTN system.

Using the MT1100A, OTN lines can be tested at the client signal level with signals like Ethernet, CPRI, Fibre Channel and SDH/SONET, because the OTN mapping function is mandatory for modern OTN transponders. The MT1100A can also test OTN lines at the line rate with bulk signals.

The user can identify problems at all levels in the OTN signal, solving OTN issues efficiently, reducing system downtime, and reducing operating expenses for network operators.

OTN Testing with Client Signals

The MT1100A is a powerful and full toolset for testing OTN signals. It supports complete Bit Error Rate (BER) tests with bulk signals at the OTN level as well as tests all the way to the Ethernet, Fibre Channel and SDH/SONET client signals mapped onto the OTN signal.

OTN tests features include:

- Supports OTU4, OTU3, OTU3e1, OTU3e2, OTU2, OTU2e, OTU2f, OTU1, OTU1e, OTU1f
- Supports multi-stage mapping and ODUflex
- OTN tests with bulk signals (PRBS, Null or User pattern) at OTN level
- Comprehensive OTN error and alarm statistics
- OTN error performance measurement in accordance with G.8201 or M.2401
- ITU-T O.182-compliant FEC test
- Test of Ethernet, CPRI, Fibre Channel or SDH/SONET client signals mapped onto OTN signal
- Delay measurement
- OTN header edit and capture
- OTN TCM monitoring and generation
- Service disruption analysis using APS application
- OTN tributary scan (up to 10 Gbps)
- Full flexibility to monitor insert/overwrite client overhead and payload within OTN signal

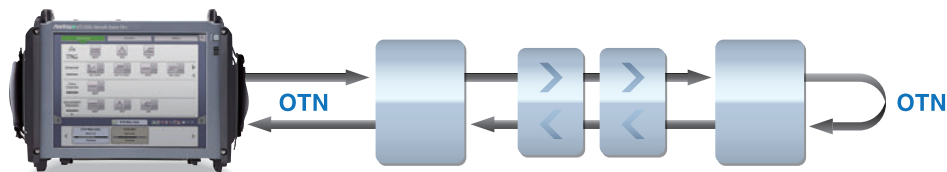

Looping-back test signal from MT1100A at far end supports easy OTN line quality tests

Out-of-service OTN Error and Alarm Statistics

The MT1100A supports powerful statistical measurements for BER tests as well as OTN level alarms and errors for installing/commissioning and troubleshooting out-of-service OTN lines. G.8201 or M.2401 error-performance parameters are calculated during measurement. Stress testing of network elements is supported by inserting errors and alarms, and adjusting overhead bytes in the signal transmitted by the instrument.

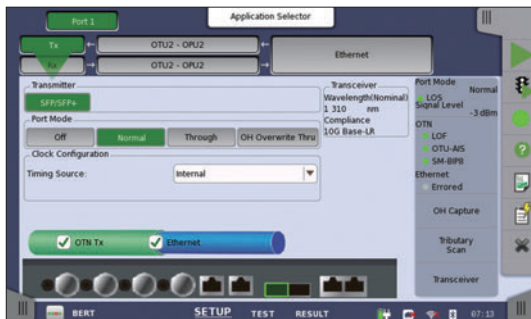

Error/Alarm Setting

Testing Ethernet, CPRI, Fibre Channel, or SDH/SONET Client Signals Mapped onto OTN Signal (Part of ODU Multiplexing Option)

The MT1100A tests OTN links carrying Ethernet, CPRI, or SDH/SONET client signals, allowing the operator to test embedded client signals. For example, an RFC 2544 or Y.1564 test can be performed with an Ethernet signal carried over the OTN signal, allowing the service engineer to run tests emulating the real-world requirements of end users.

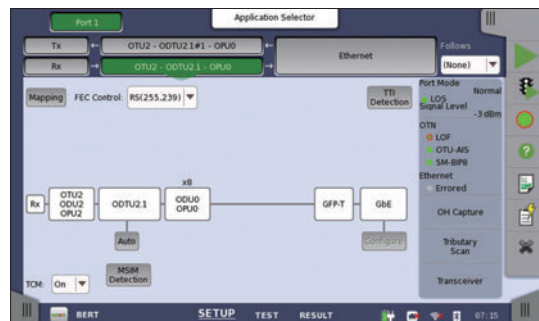

OTN Mapping Setting

OTN Application

Comprehensive OTN Testing for Core and Metro Networks Installation and Maintenance

ODUflex Test (with ODU Flex Option)

ODUflex is a feature of OTN supporting flexible allocation of client-signal bandwidth to make best use of OTN capacity. The MT1100A with ODU Flex option supports ODUflex tests, allowing operators to verify this technology on their networks.

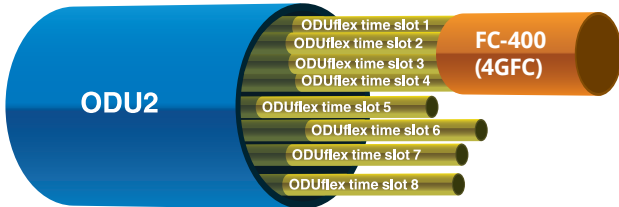

ODU Flex Option divides capacity of ODU2 into eight 1.25G ODUflex time slots. In the above example, an FC-400 (4GFC) Fibre Channel signal occupies four ODUflex time slots.



OTN Statistics Summary



OTU Level Statistics

ITU-T O.182-compliant FEC Test

Anritsu proposed the FEC performance tests using Poisson-distributed random errors adopted by ITU-T Recommendation O.182. This method supports reproducible and accurate FEC error correction tests by generating truly random signal errors. High-speed networks cannot be tested accurately without using the ITU-T O.182 Poisson error distribution.



FEC Error Insertion

OTN Tributary Scan

The tributary scan feature supports quick inspection of the OTN signal by examining it for major problems and highlighting them in an easy-to-understand manner. (up to 10 Gbps)

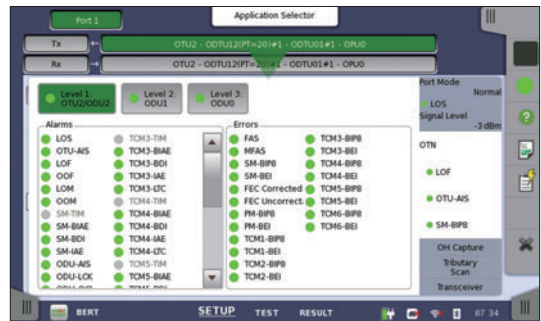

OTU Alarms and Errors View

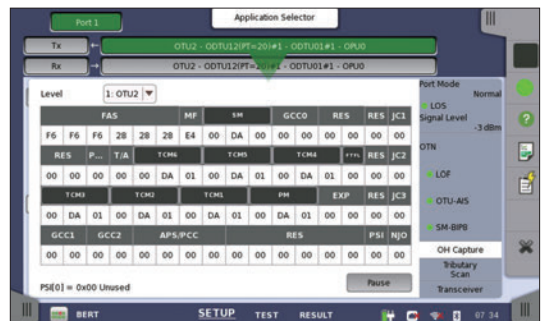

OTU Header Capture

Mobile Backhaul/Mobile Fronthaul Application

Mobile Backhaul Installation and Verification (Up to 10 Gbps)

Synchronous Ethernet is an essential technology in mobile backhaul networks and faults in Synchronous Ethernet seriously jeopardize the performance of mobile networks and can cause system downtime. Consequently, mobile operators need a test tool to verify the correct functioning of Synchronous Ethernet.

The Synchronous Ethernet test function of the MT1100A supports comprehensive testing and analysis of both Synchronous Ethernet technologies: SyncE and PTP (IEEE 1588 v2).

The user can quickly identify problems at all levels in Synchronous Ethernet, solving issues quickly, reducing system downtime and customer churn, and improving operating expenses for mobile operators. (up to 10 Gbps)

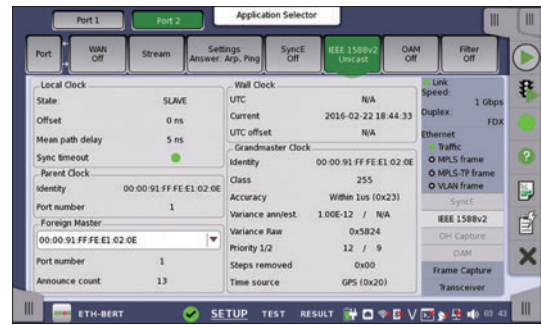

Status of IEEE 1588 v2 Slave Clock

Mobile Fronthaul Installation and Verification (Up to 10 Gbps)

The spread of smartphones, tablets, etc., is driving use of wider bandwidths for mobile communications.

Until now, the mobile-backhaul Base Band Unit (BBU) and Remote Radio Head (RRH) have been connected via a general-purpose interface, such as the Common Public Radio Interface (CPRI) and the Open Base Station Architecture Initiative (OBSAI), with use of multiple antennas supporting better connectivity and faster speeds. Future 5G mobile networks are deploying new eCPRI/IEEE 1914.3 (RoE: Radio over Ethernet) interfaces. In addition to supporting conventional CPRI/OBSAI, the MT1100A has built-in eCPRI/RoE (IEEE1914.3) interfaces and supports BER tests, various error and alarm tests, return time delay (RTD) tests, Link status displays, and Pass-through monitoring.

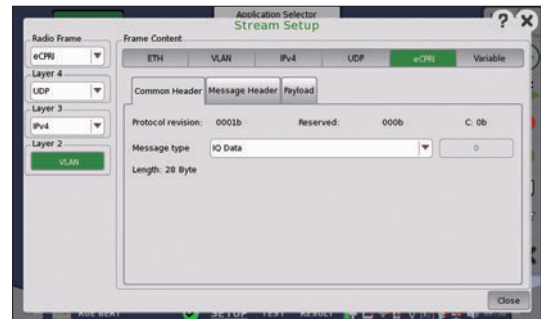
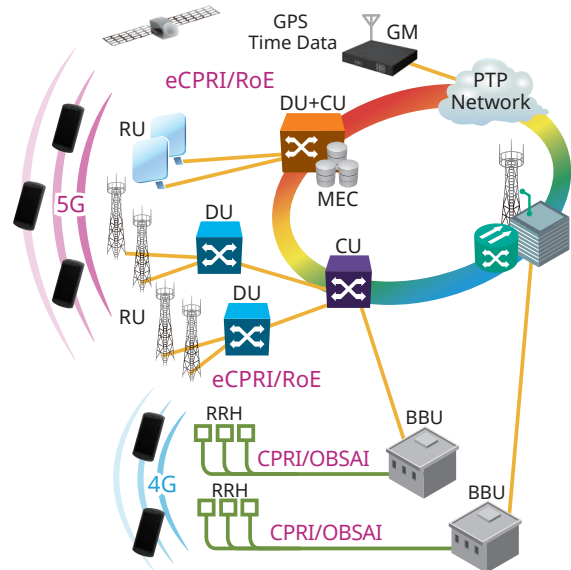

eCPRI Frame Setting

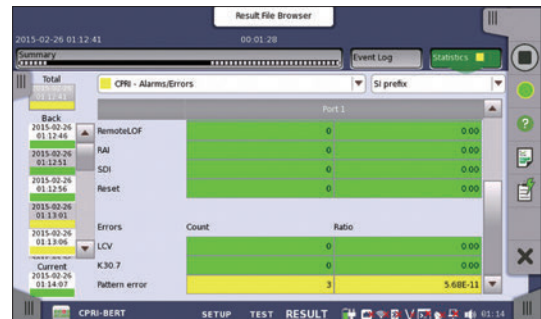

CPRI/OBSAI BER Test

Fibre Channel Application/SDH/SONET, PDH/DSn Application

Storage Area Networking (SAN) Testing (Up to 10 Gbps)

Many operators need to support Fibre Channel links in Storage Area Networks (SAN) together with other transport technologies like OTN, Ethernet, and SDH/SONET. Having one tool for all technologies is important for efficient testing. The multi-protocol MT1100A with Fibre Channel option is the perfect tool for deploying Fibre Channel with support for testing links at rates up to 10 Gbps and it also supports other technologies like OTN, Ethernet, eCPRI/RoE/CPRI/OBSAI, SDH/SONET and PDH/DSn. The all-in-one MT1100A gives the user less equipment to maintain and learn, helping reduce operating expenses.

Fibre Channel test features include:

- 1GFC, 2GFC, 4GFC, 8GFC, and 10GFC tests
- Optional mapping to OTN
- Latency measurement
- BER tests including service disruption measurement
- Line alarm and error monitor
- Normal or Reflector mode

Latency

High latency is a problem for many applications, including SAN, and network operators and service providers urgently need a tool like the MT1100A with Fibre Channel option to test latency on Fibre Channel lines and equipment.

Fibre Channel BER Tests

The MT1100A with Fibre Channel option supports BER tests to measure the performance of Fibre Channel lines and equipment. Service disruption measurement is also supported.

Performance Tests

Fibre Channel achieves frame-loss-free transmissions using buffer credit-based flow control. On the other hand, throughput rates drop due to the wasted wait times if the buffer size is small compared to the network transmission delay time. The MT1100A measures the buffer size needed to achieve the required throughput.

Quick and Easy Tests of SDH/SONET and PDH/DSn Networks

Legacy technologies in transport networks can't just be eliminated because of the huge capital investment, but keeping legacy technologies operational can require several testers.

With its SDH/SONET and PDH/DSn test options, the MT1100A is a powerful and easy-to-use tool for testing SDH/SONET up to STM-64/OC-192. PDH/DSn systems (E1, E3, E4, DS1 and DS3) can be tested directly or embedded into SDH/SONET. The MT1100A can support new and legacy technologies, leaving the user less equipment to maintain and learn, and reducing operating expenses.

SDH/SONET and PDH/DSn test features include:

- Powerful testing of SDH (STM-256, STM-64, STM-16, STM-4, STM-1), SONET (OC-768, OC-192, OC-48, OC-12, OC-3, STS-3) systems and embedded PDH (E1, E3, E4) and DSn (DS1, DS3) systems
- Powerful testing of PDH (E1, E3, E4) and DSn (DS1, DS3) systems
- Simultaneous bi-directional monitoring of SDH/SONET and PDH/DSn lines
- SDH/SONET mapping and de-mapping of PDH/DSn signals
- Comprehensive error and alarm statistics
- SDH/SONET overhead byte testing and monitoring
- SDH/SONET tributary scan
- SDH/SONET pointer event generation and monitoring
- SDH/SONET and PDH/DSn delay measurements
- Analysis of service disruption with APS application

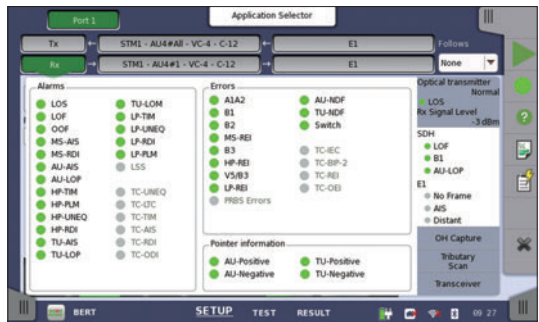

Quick overview of errors and alarms for both sides of SDH/SONET line

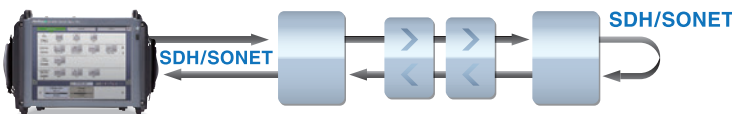

Looping-back test signal from MT1100A at far end supports SDH/SONET line quality tests

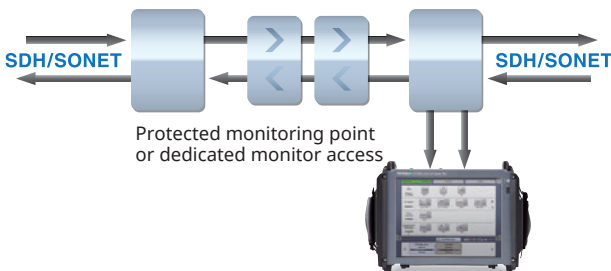

Bi-directional in-service monitoring of SDH/SONET lines

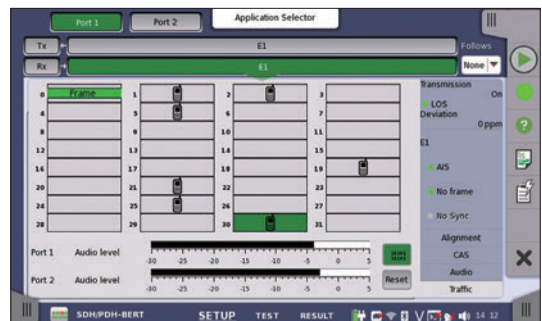

Monitor 64 kbps traffic channels on bidirectional E1 line with MT1100A traffic display

Automated Field Test Environment

The standalone MT1100A with presettings for automated testing requires no external controller. Automated testing simplifies work when test procedures are predetermined, such as manufacturing processes and regression tests.

Higher efficiency by registering test work

- Registering onsite test procedures and equipment in the MT1100A supports one-button operation by technicians.
- Comments can be added to work steps, helping reduce operator errors.
- The tests can be run with no background knowledge of the measuring instrument.

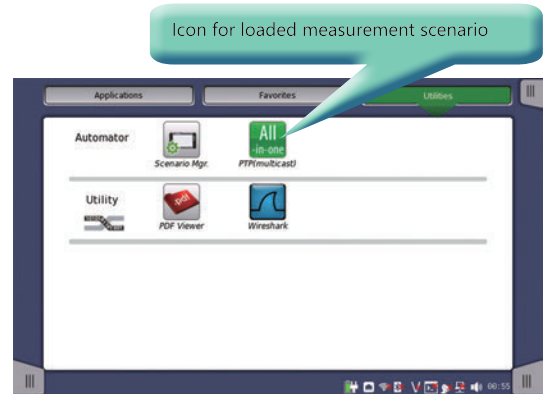

Automation Test Select

Automated test scenarios

- Scenarios are created easily using the intuitive GUI available for free download.
- With Pass/Fail functions built into test scenarios, even inexperienced technicians can perform accurate onsite Pass/Fail evaluation.

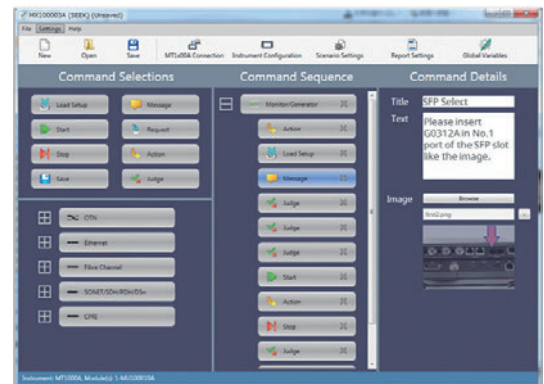

SEEK (Scenario Edit Environment Kit) MX100003A

Mainframe/Power Module Specifications

Network Master Flex MT1100A Mainframe

User Interfaces	
Display	12.1-inch active matrix TFT display (800 × 600 pixels) and touch screen
Supported Languages	English, Chinese, Japanese, French, Russian, Spanish, Finnish, Korean, German

Service Interfaces	
USB Interface	MT1100A operates as host: USB 2.0 type A (2 ports) MT1100A operates as device: USB 2.0 type Mini-B (1 port)
Ethernet Interface	Ethernet 10M/100M/1000M, Connector: RJ45
WLAN Interface*	IEEE 802.11 b/g/n
Bluetooth Interface*	Bluetooth 2.1 + EDR

*: Available for certified countries and regions including USA, Canada, Japan and EU countries. Please visit the Anritsu web site for updated information.

Other Interfaces	
Unit synchronization Input	(Not used)
Unit Synchronization Output	(Not used)
Audio Interface	For connection of CTIA Standard head set Connector: 3.5-mm diameter jack
AUX Connector	For connection of G0325A GPS receiver
Built-in Loudspeaker	Monitors speech of voice channel Output level: user-controlled from user interface
Ext. Clock Input	For connection of external clock signals: • SETS (E1: 2.048 Mbps), BITS (DS1: 1.544 Mbps), or 2.048 MHz TTL signal in accordance with ITU-T G.703, 10 MHz Connector: BNC

Miscellaneous		
Dimensions and Mass	320 (W) × 225 (H) × 46 (D) mm (excluding projections), ≤2.5 kg	
Environmental	Temperature and Humidity • Operating: 0°C to +40°C, ≤80% RH (non-condensing) • Storage: -20°C to +60°C, ≤80% RH (non-condensing)	
CE	EMC	2014/30/EU, EN61326-1, EN61000-3-2
	LVD	2014/35/EU, EN61010-1
	RoHS	2011/65/EU, EN50581

Battery and AC Power Supply Module MU110001A

Battery	14.4 V rechargeable and replaceable intelligent Li-ion battery Operation time: 1 hour (typ.) (with MU110011A, 100 Gbps Ethernet operation) Charging time: 6 hours (typ.) (25°C) Remaining capacity indication: %	
Power Supply	100 V(ac) to 240 V(ac), 50 Hz/60 Hz 380 VA (max.)	
Dimensions and Mass	320 (W) × 225 (H) × 82 (D) mm (excluding projections), ≤3.0 kg (without battery)	
Environmental	Temperature and Humidity • Operating: 0°C to +40°C, ≤80% RH (non-condensing) • Storage: -20°C to +60°C, ≤80% RH (non-condensing, without battery) -20°C to +50°C, ≤80% RH (non-condensing, with battery)	
CE	EMC	2014/30/EU, EN61326-1, EN61000-3-2
	LVD	2014/35/EU, EN61010-1
	RoHS	2011/65/EU, EN50581

AC only High Power Supply Module MU110002A

Power Supply	100 V(ac) to 240 V(ac), 50 Hz/60 Hz 700 VA (max.)	
Dimensions and Mass	320 (W) × 225 (H) × 72 (D) mm (excluding projections), ≤3.0 kg	
Environmental	Temperature and Humidity • Operating: 0°C to +40°C, ≤80% RH (non-condensing) • Storage: -20°C to +60°C, ≤80% RH (non-condensing)	
CE	EMC	2014/30/EU, EN61326-1, EN61000-3-2
	LVD	2014/35/EU, EN61010-1
	RoHS	2011/65/EU, EN50581

Measurement Module Specifications

10G Multirate Module MU110010A

Test Port/Reference Standard	SFP/SFP+: 2 ports <ul style="list-style-type: none"> SFF-8431, SFF-8472 compliant, IEEE 802.3ae-2002, IEEE 802.3-2008 compliant RJ45: 2 ports <ul style="list-style-type: none"> IEEE 802.3-2008 10BASE-T, 100BASE-TX, 1000BASE-T compliant Auto MDI-X 10 Mbps/100 Mbps full/half duplex, 1000 Mbps full duplex BNC: 2 ports <ul style="list-style-type: none"> ITU-T G.703 compliant RJ48: 2 ports <ul style="list-style-type: none"> ITU-T G.703 compliant RTT Bantam: 2 ports <ul style="list-style-type: none"> ANSI DS1.102 compliant 	
Tx Ref. Clock Output	Frequency: <ul style="list-style-type: none"> Selectable from 1/16, or 1/64 against the bit rate. (Available only when one of SFP ports is selected) Level: 250 mVp-p (min.), 550 mVp-p (max.) Termination: 50Ω/AC (Single ended) Connector: SMA	
Dimensions and Mass	320 (W) × 225 (H) × 37 (D) mm, ≤1.4 kg	
Environmental	Temperature and Humidity <ul style="list-style-type: none"> Operating: 0°C to +40°C, ≤80% RH (non-condensing) Storage: -20°C to +60°C, ≤80% RH (non-condensing) 	
CE	EMC	2014/30/EU, EN61326-1, EN61000-3-2
	LVD	2014/35/EU, EN61010-1
	RoHS	2011/65/EU, EN50581
Laser Safety*2	IEC 60825-1: 2007 CLASS 1 21CFR1040.10 and 1040.11*1	

*1: Excludes deviations caused by conformance to Laser Notice No. 50 dated June 24, 2007

*2: Safety measures for laser products

This product complies with optical safety standards in 21CFR1040.10, 1040.11 and IEC 60825-1; the following descriptive labels are affixed to the product.

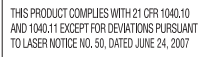
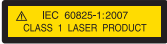

100G Multirate Module MU110011A

Test Port/Reference Standard	CFP: 1 port <ul style="list-style-type: none"> CFP MSA Hardware Specification, Rev. 1.4 compliant CFP MSA Management Interface Specification V2.2 R06a compliant (Not supported to MSA 100GLH) IEEE 802.3ba-2010 compliant QSFP+: 2 ports <ul style="list-style-type: none"> SFF-8436, SFF-8472 compliant IEEE 802.3ba-2010 compliant SFP/SFP+: 2 ports <ul style="list-style-type: none"> SFF-8431, SFF-8472 compliant IEEE 802.3ae-2002, IEEE 802.3-2008 compliant RJ45: 2 ports <ul style="list-style-type: none"> IEEE 802.3-2008 10BASE-T, 100BASE-TX, 1000BASE-T compliant Auto MDI-X 10 Mbps/100 Mbps full/half duplex, 1000 Mbps full duplex 	
Tx Ref. Clock Output	Frequency: Select 1/16 or 1/64 for bit rates of 10G or less. Select 1/16 or 1/64 for each lane rate for XLAUI and OTL3.4 of 40G. Select 1/16 or 1/64 for each lane rate for CAUI and OTL4.19 of 100G. (RJ45 port cannot be selected) Level: 250 mVp-p (min.), 550 mVp-p (max.) Termination: 50Ω/AC (Single ended) Connector: SMA	
Dimensions and Mass	320 (W) × 225 (H) × 60 (D) mm, ≤3.0 kg	
Environmental	Temperature and Humidity <ul style="list-style-type: none"> Operating: 0°C to +40°C, ≤80% RH (non-condensing) Storage: -20°C to +60°C, ≤80% RH (non-condensing) 	
CE	EMC	2014/30/EU, EN61326-1, EN61000-3-2
	LVD	2014/35/EU, EN61010-1
	RoHS	2011/65/EU, EN50581
Laser Safety*2	IEC 60825-1: 2007 CLASS 1 21CFR1040.10 and 1040.11*1 CFP : 100GBASE-LR4, 40GBASE-LR4, 40GBASE-FR QSFP+ : 40GBASE-LR4 SFP : 4GFC(SX), 4GFC(LX), 4GFC(EX), OC-48 LR-1/STM L-16.1, OC-48 LR-2/STM L-16.2, 100BASE-FX, 100BASE-LX SFP+ : 1000BASE-SX/LX/ZX, 10GBASE-LR, 10GBASE-ER, 10GBASE-ZR IEC 60825-1: 2007 CLASS 1M 21CFR1040.10 and 1040.11*1 CFP : 100G BASE-SR10 QSFP+ : 40GBASE-SR4	

*1: Excludes deviations caused by conformance to Laser Notice No. 50 dated June 24, 2007

*2: Safety measures for laser products

This product complies with optical safety standards in 21CFR1040.10, 1040.11 and IEC 60825-1; the following descriptive labels are affixed to the product.



Measurement Module Specifications

40/100G Advanced Module MU110013A

Test Port/Reference Standard	<p>CFP2: 2 ports</p> <ul style="list-style-type: none"> • CFP MSA CFP2 Hardware Specification, Rev. 1.0 compliant • CFP MSA Management Interface Specification V2.2 R06a compliant (Not supported to MSA 100GLH) • IEEE 802.3ba-2010 compliant <p>CXP: 2 ports</p> <ul style="list-style-type: none"> • InfiniBand Architecture 1.2.1 Annex A6: CXP compliant • SFF-8642, IEEE 802.3ba-2010 compliant <p>QSFP+: 2 ports</p> <ul style="list-style-type: none"> • SFF-8436, SFF-8472 compliant • IEEE 802.3ba-2010 compliant 	
Tx Ref. Clock Output	<p>Frequency</p> <p>Select 1/16 or 1/64 for each lane rate of XX.</p> <p>40 GigE : XLAUI OTU3, OTU3e1, OTU3e2 : OTL3.4 100 GigE : CAUI OTU4 : OTL4.10</p> <p>Level: 250 mVp-p (min.), 550 mVp-p (max.) Termination: 50Ω/AC (Single ended) Connector: SMA</p>	
Sync Clock Output	<p>Frequency</p> <p>Select 1/8 or 1/16 against the bit rate of the data lane for CFP2 port.</p> <p>100 GigE : CAUI4 OTU4 : OTL 4.4</p> <p>Level: 150 mVp-p (min.), 650 mVp-p (max.) Termination: 50Ω/AC (Single ended) Connector: SMA</p>	
Dimensions and Mass	320 (W) × 225 (H) × 60 (D) mm, ≤3.0 kg	
Environmental	<p>Temperature and Humidity</p> <ul style="list-style-type: none"> • Operating : 0°C to +40°C, ≤80% RH (non-condensing) • Storage : -20°C to +60°C, ≤80% RH (non-condensing) 	
CE	EMC	2014/30/EU, EN61326-1, EN61000-3-2
	LVD	2014/35/EU, EN61010-1
	RoHS	2011/65/EU, EN50581
Laser Safety*2	<p>IEC 60825-1: 2007 CLASS 1 21CFR1040.10 and 1040.11*1</p> <p>QSFP+ : 40G BASE-LR4 CFP2 : 100G BASE-LR4 QSFP28 : 100G BASE-LR4</p> <p>IEC 60825-1: 2007 CLASS 1M 21CFR1040.10 and 1040.11*1</p> <p>QSFP+ : 40G BASE-SR4 CXP : 100G BASE-SR10 QSFP28 : 100G BASE-SR4</p>	

*1: Excludes deviations caused by conformance to Laser Notice No. 50 dated June 24, 2007

*2: Safety measures for laser products

This product complies with optical safety standards in 21CFR1040.10, 1040.11 and IEC 60825-1; the following descriptive labels are affixed to the product.



Ordering Information

Please specify the model/order number, name and quantity when ordering.
The names listed in the table below are Order Names. The actual name of the item may differ from the Order Name.

1. Mainframe

Model/Order No.	Name
Mainframe	
MT1100A	Network Master Flex
Standard accessories for MT1100A	
	Power Cord
Z1746A	Stylus
Z1870A	Utilities ROM
W3734AE	MT1100A Quick Reference Guide (English)
W3734AW	MT1100A Quick Reference Guide (Japanese)
Z1861A	Carrying Strap
Z1862A	Module Combination Kit
B0699A	Soft Case
Option	
MT1100A-003*1	Connectivity for WLAN/Bluetooth

*1: Please visit the Anritsu web site for updated information.

2. Power Supply Module

Model/Order No.	Name
MU110001A*2	Battery and AC Power Supply Module
MU110002A*2	AC only High Power Supply Module
Standard accessories for MU110001A	
G0327A*3	Li-ion Battery: 2 pcs

*2: Select MU110001A or MU110002A.

When installing two test modules in an MT1100A mainframe, one module must be an MU110010A to select MU110001A, battery powered power module.

*3: MU110001A requires two G0327A.

3. Measurement Module*4

Model/Order No.	Name
MU110010A	10G Multirate Module
MU110011A	100G Multirate Module
MU110013A	40/100G Advanced Module

*4: One or two modules of MU110010A/11A/13A can be installed in one mainframe.

4. Protocol Options*5, *6

MU110010A

Model/Order No.	Name
Ethernet	
MU110010A-001	Up to 2.7G Dual Channel
MU110010A-011	Ethernet 10G Single Channel
MU110010A-012	Ethernet 10G Dual Channel
MU110010A-020	TCP Throughput
CPRI/OBSAI	
MU110010A-071	CPRI/OBSAI Up to 5G Dual Channel
MU110010A-072	CPRI/OBSAI 6G to 10G Single Channel
MU110010A-073	CPRI/OBSAI 6G to 10G Dual Channel
OTN	
MU110010A-001	Up to 2.7G Dual Channel
MU110010A-051	OTN 10G Single Channel
MU110010A-052	OTN 10G Dual Channel
MU110010A-061	ODU Multiplexing
MU110010A-062	ODU Flex
SDH/SONET	
MU110010A-001	Up to 2.7G Dual Channel
MU110010A-081	STM-64 OC-192 Single Channel
MU110010A-082	STM-64 OC-192 Dual Channel
Fibre Channel	
MU110010A-002	FC 1G 2G 4G Dual Channel
MU110010A-091	FC 8G 10G Single Channel
MU110010A-092	FC 8G 10G Dual Channel

*5: "channel" means physical port or client signal test mapped in OTN.

Refer to data sheet for OTN and client signals.

*6: These options can be retrofitted.

The Model/Order No. of retrofit options is "-3**".

Example

MU110010A-001 Up to 2.7G Dual Channel becomes MU110010A-301 Up to 2.7G Dual Channel Retrofit. In addition, specify one of the following media along with the required option.

Model/Order No.	Name
Z1849A	DVD-ROM for Retrofit Options
Z1850A	USB Stick for Retrofit Options

MU110011A

Model/Order No.	Name
Ethernet	
MU110011A-001	Up to 10G Single Channel
MU110011A-003	Up to 10G Dual Channel
MU110011A-013	Ethernet 40G Single Channel
MU110011A-014	Ethernet 40G Dual Channel
MU110011A-015	Ethernet 100G Single Channel
MU110011A-020	TCP Throughput
CPRI/OBSAI	
MU110011A-071	CPRI/OBSAI Up to 10G Single Channel
MU110011A-072	CPRI/OBSAI Up to 10G Dual Channel
OTN	
MU110011A-001	Up to 10G Single Channel
MU110011A-003	Up to 10G Dual Channel
MU110011A-053	OTN 40G Single Channel
MU110011A-054	OTN 40G Dual Channel
MU110011A-055	OTN 100G Single Channel
MU110011A-061	ODU Multiplexing
MU110011A-062	ODU Flex
MU110011A-063*7	40G/100G ODU Multi Stage
SDH/SONET	
MU110011A-001	Up to 10G Single Channel
MU110011A-003	Up to 10G Dual Channel
MU110011A-083	STM-256 OC-768 Single Channel
MU110011A-084	STM-256 OC-768 Dual Channel
Fibre Channel	
MU110011A-005	Up to 10G FC Single Channel
MU110011A-004	Up to 10G FC Dual Channel

MU110013A

Model/Order No.	Name
Ethernet	
MU110013A-001*8	Up to 10G Single Channel
MU110013A-003*8	Up to 10G Dual Channel
MU110013A-013	Ethernet 40G Single Channel
MU110013A-014	Ethernet 40G Dual Channel
MU110013A-015	Ethernet 100G Single Channel
MU110013A-016	Ethernet 100G Dual Channel
MU110013A-023*9	RS-FEC for 100GBASE-SR4
CPRI/OBSAI	
MU110013A-071*8	CPRI Up to 10G Single Channel
MU110013A-072*8	CPRI Up to 10G Dual Channel
OTN	
MU110013A-001*8	Up to 10G Single Channel
MU110013A-003*8	Up to 10G Dual Channel
MU110013A-053	OTN 40G Single Channel
MU110013A-054	OTN 40G Dual Channel
MU110013A-055	OTN 100G Single Channel
MU110013A-056	OTN 100G Dual Channel
MU110013A-062	ODU Flex
MU110013A-063	40G/100G ODU Multi Stage
SDH/SONET	
MU110013A-001*8	Up to 10G Single Channel
MU110013A-003*8	Up to 10G Dual Channel
MU110013A-083*8	STM-256 OC-768 Single Channel
MU110013A-084*8	STM-256 OC-768 Dual Channel
Fibre Channel	
MU110013A-005*8	Up to 10G FC Single Channel
MU110013A-004*8	Up to 10G FC Dual Channel
Device Test	
MU110013A-008*10	4 × 25G/28G BERT

*7: These options including MU11001xA-061 function.

*8: MU110013A does not have a physical interface of these options.

These options are required for the client signal mapped in the OTN.

Please refer to the OTN mapping pages on the datasheet.

*9: Required to MU110013A-015 or MU110013A-016.

*10: Requires one of the following options:

MU100013A-015, MU100013A-016, MU100013A-055, MU100013A-056

Ordering Information

5. Optional Accessories

Model/Order No.	Name
Optical modules*10	
G0332A	100M FX 1310 nm MM SFP
G0329A	10G LR 1310 nm SFP+
G0315A	10G LR/LW 1310 nm SFP+
G0316A	10G ER/EW 1550 nm 40 km SFP+
G0318A	10G ZR/ZW 1550 nm 80 km SFP+
G0319A	Up to 2.7G 1310 nm 15 km SFP
G0320A	Up to 2.7G 1310 nm 40 km SFP
G0321A	Up to 2.7G 1550 nm 80 km SFP
G0328A	1G/2G/4G FC 850 nm SFP
G0322A	1G/2G/4G FC 1310 nm SFP
G0323A	1G/2G/4G FC 1550 nm SFP
G0356A	8G FC/10G SR 850 nm SFP+
G0359A	40G SR4 850 nm QSFP+
G0334A	40G LR4 1310 nm QSFP+
G0335A	40G LR4 1310 nm CFP
G0336A	40G FR 1550 nm CFP
G0337A	100G LR4 1310 nm CFP
G0338A	100G LR4 1310 nm CFP2
G0339A	100G 850 nm CXP
Z2048A*11	CFP2-QSFP28 Adaptor with G0366A
Z2046A*11	CFP2-QSFP28 Adaptor with G0364A
Z2047A*11	CFP2-QSFP28 Adaptor with G0365A
Mainframe optional accessories	
B0717A	Hard Case
Z1860A	Battery Charger
G0325A	GPS Receiver
Z1871A	Utilities in USB Stick
B0692A*12	ESD Box
G0382A	Autofocus Video Inspection Probe
G0306B	Video Inspection Probe
J1667A*13	GPIB-USB Converter
B0705A	Rack Mount Kit
Cables	
J1571A	Optical Cable SM LC/PC to SC/PC 3 m
J1575A	Optical Cable SM LC/PC to FC/PC 3 m
J1579A	Optical Cable SM LC/PC to LC/PC 3 m
J1581A	Optical Cable MM LC/PC to LC/PC 3 m
J1583A	Optical Attenuator 10 dB LC/PC to LC/PC
J1584A	RJ45 Cable 3 m
J1585A	RJ48 to Crocodile Clips Cable 3 m
J1586A	RJ48 to Crocodile Clips Cable 20 dB ATT 3 m
J1588A	BNC Cable 2.5 m
J1589A	BNC to 1.6/5.6 Cable 2.5 m
J1591A	RJ48 to Two 3-pin Banana Plug Cable 2.5 m
J1597A	RJ48 Balanced PDH Cable Crossed 3 m
J1598A	Bantam Cable 3 m
J0775D	Coaxial Cord, 2.0 m (75Ω)
Manuels	
W3735AE	MT1100A Operation Manual (English)
W3735AW	MT1100A Operation Manual (Japanese)
W3736AE	MT1000A/MT1100A Remote Scripting Operation Manual (English)
W3736AW	MT1000A/MT1100A Remote Scripting Operation Manual (Japanese)

*10: Refer to page 22 for the specifications of the optical module.

*11: Set of QSFP28 optical modules and CFP2-QSFP28 conversion adapters.

*12: Up to 4 SFP+/SFPs can be stored.

*13: J1667A is required for SCPI remote control via GPIB.

6. Extended Warranties

Model/Order No.	Name
MT1100A-ES210	2 Years Extended Warranty Service
MT1100A-ES310	3 Years Extended Warranty Service
MT1100A-ES510	5 Years Extended Warranty Service
MU110001A-ES210	2 Years Extended Warranty Service
MU110001A-ES310	3 Years Extended Warranty Service
MU110001A-ES510	5 Years Extended Warranty Service
MU110002A-ES210	2 Years Extended Warranty Service
MU110002A-ES310	3 Years Extended Warranty Service
MU110002A-ES510	5 Years Extended Warranty Service
MU110010A-ES210	2 Years Extended Warranty Service
MU110010A-ES310	3 Years Extended Warranty Service
MU110010A-ES510	5 Years Extended Warranty Service
MU110011A-ES210	2 Years Extended Warranty Service
MU110011A-ES310	3 Years Extended Warranty Service
MU110011A-ES510	5 Years Extended Warranty Service
MU110013A-ES210	2 Years Extended Warranty Service
MU110013A-ES310	3 Years Extended Warranty Service
MU110013A-ES510	5 Years Extended Warranty Service



Hard case B0717A

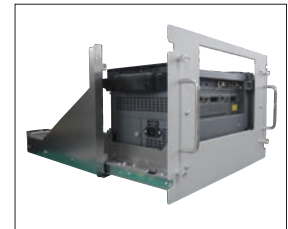

Rack Mount Kit B0705A

Optical Modules Selection Guide

Optical interface tests can be run using the MT1100A just by inserting an optical module supporting the relevant standard into the SFP/SFP+ slot. The following table lists the lineup of CFP, CFP2, CXP, QSFP+, QSFP28, and SFP/SFP+ application parts, and the corresponding standards.

MU110010A	MU110011A	MU110013A	Model/ Order No.	Name	Form Factor	100 Meg Ethernet	156 Meg STM-1	614 Meg CPRI	622 Meg STM-4	768 Meg OBSAI	1 Gig FC	1.23 Gig CPRI	1.25 Gig Ethernet	1.54 Gig OBSAI	2 Gig FC	2.46 Gig CPRI	2.488 Gig STM-16	2.67 Gig OTU1	3.07 Gig CPRI OBSAI	4 Gig FC	4.92 Gig CPRI	6.14 Gig CPRI OBSAI	8 Gig FC	9.83 Gig CPRI	9.95 Gig STM-64	10.1 Gig CPRI	10.3 Gig Ethernet	10.5 Gig FC	10.7 Gig OTU2	11.05 Gig OTU1e	11.09 Gig OTU2e	11.27 Gig OTU1f	11.3 Gig OTU2f	40G SDH/SONET	40G Ethernet	40G OTN	100G Ethernet	100G OTN							
✓	✓		G0332A	100M FX 1310 nm MM SFP	SFP	1310 nm, MM, 2 km																																							
✓	✓		G0329A	10G LR 1310 nm SFP+	SFP+							1310 nm, SM, 10 km																																	
✓	✓		G0315A	10G LR/LW 1310 nm SFP+	SFP+																																								
✓	✓		G0316A	10G ER/EW 1550 nm 40 km SFP+	SFP+																																								
✓	✓		G0318A	10G ZR/ZW 1550 nm 80 km SFP+	SFP+																																								
✓	✓		G0319A	Up to 2.7G 1310 nm 15 km SFP	SFP																																								
✓	✓		G0320A	Up to 2.7G 1310 nm 40 km SFP	SFP																																								
✓	✓		G0321A	Up to 2.7G 1550 nm 80 km SFP	SFP																																								
✓	✓		G0328A	1G/2G/4G FC 850 nm SFP	SFP																																								
✓	✓		G0322A	1G/2G/4G FC 1310 nm SFP	SFP																																								
✓	✓		G0323A	1G/2G/4G FC 1550 nm SFP	SFP																																								
✓	✓		G0356A	8G FC/10G SR 850 nm SFP+	SFP+																																								
	✓	✓	G0359A	40G SR4 850 nm QSFP+	QSFP+																																								
	✓	✓	G0334A	40G LR4 1310 nm QSFP+	QSFP+																																								
	✓		G0335A	40G LR4 1310 nm CFP	CFP																																								
	✓		G0336A	40G FR 1550 nm CFP	CFP																																								
	✓		G0337A	100G LR4 1310 nm CFP	CFP																																								
	✓		G0338A	100G LR4 1310 nm CFP2	CFP2																																								
	✓		G0339A	100G 850 nm CXP	CXP																																								
	✓		Z2048A	CFP2-QSFP28 Adaptor with G0366A	CFP2 (QSFP28)																																								
	✓		Z2046A	CFP2-QSFP28 Adaptor with G0364A	CFP2 (QSFP28)																																								
	✓		Z2047A	CFP2-QSFP28 Adaptor with G0365A	CFP2 (QSFP28)																																								

Related Products

Network Master Pro MT1000A



10G Multirate Module

MU100010A

100G Multirate Module

MU100011A

High Performance GPS Disciplined Oscillator

MU100090A

Installing the MU100010A or MU100011A in the MT1000A supports commissioning and maintenance tests of communications networks operating at speeds from 1.5 Mbps to 100 Gbps.

In addition to Ethernet, OTN, eCPRI/RoE/CPRI/OBSAI, Fibre Channel and SyncE protocols used by mobile-network base stations are supported too.

OTDR Module 1310/1550 nm SMF

MU100020A

OTDR Module 1310/1550/850/1300 nm SMF/MMF

MU100021A

OTDR Module 1310/1550/1625 nm SMF

MU100022A

OTDR Module 1310/1550/1650 nm SMF

MU100023A

Installing an OTDR Module MU100020A/MU100021A/MU100022A/MU100023A provides the OTDR functions required for optical fiber I&M. Work efficiency is increased by all-in-one support for optical fiber tests and data communications network commissioning.

I&M tests of communications networks can be executed by simultaneously installing the MU10001xA. In addition to supporting Ethernet, OTN, etc., networks, Mobile base station CPRI and OBSAI, as well as SyncE protocols are also supported.



MT9090A Series



μOTDR Module

MU909014/15

Compact OTDR for full automatic verification of optical networks, FTTH-PON, Metro and Core.

Gigabit Ethernet Module

MU909060A

Dedicated field test solution for installation and troubleshooting Ethernet links in access networks.



MU909014/15



MU909060A

CMA5 Series

Light Source/Optical Power Meter

For optical fiber installation and maintenance.



ACCESS Master MT9085 Series

For WAN/MFH/DCI/FTTH Optical Fiber I&M

- Improved operability with powerful synergy of 8-inch touchscreen and hardware keys
- At-a-glance Pass/Fail evaluation using Fiber Visualizer
- All OTDR, OLTS, and Visible Light Source operations on one screen
- Short event dead zone of ≤ 0.8 m and high dynamic range of 46 dB max.
- Power meter option for measuring optical power up to +30 dBm



• United States

Anritsu Americas Sales Company

450 Century Parkway, Suite 190, Allen,
TX 75013 U.S.A.
Phone: +1-800-Anritsu (1-800-267-4878)

• Canada

Anritsu Electronics Ltd.

700 Silver Seven Road, Suite 120, Kanata,
Ontario K2V 1C3, Canada
Phone: +1-613-591-2003
Fax: +1-613-591-1006

• Brazil

Anritsu Eletronica Ltda.

Praça Amadeu Amaral, 27 - 1 Andar
01327-010 - Bela Vista - Sao Paulo - SP, Brazil
Phone: +55-11-3283-2511
Fax: +55-11-3288-6940

• Mexico

Anritsu Company, S.A. de C.V.

Bvd Miguel de Cervantes Saavedra #169 Piso 1, Col. Granada
Mexico, Ciudad de Mexico, 11520, MEXICO
Phone: +52-55-4169-7104

• United Kingdom

Anritsu EMEA Ltd.

200 Capability Green, Luton, Bedfordshire, LU1 3LU, U.K.
Phone: +44-1582-433200
Fax: +44-1582-731303

• France

Anritsu S.A.

12 avenue du Québec, Bâtiment Iris 1- Silic 612,
91140 VILLEBON SUR YVETTE, France
Phone: +33-1-60-92-15-50
Fax: +33-1-64-46-10-65

• Germany

Anritsu GmbH

Nemetschek Haus, Konrad-Zuse-Platz 1
81829 München, Germany
Phone: +49-89-442308-0
Fax: +49-89-442308-55

• Italy

Anritsu S.r.l.

Via Elio Vittorini 129, 00144 Roma, Italy
Phone: +39-6-509-9711
Fax: +39-6-502-2425

• Sweden

Anritsu AB

Isafjordsgatan 32C, 164 40 KISTA, Sweden
Phone: +46-8-534-707-00

• Finland

Anritsu AB

Teknobulevardi 3-5, FI-01530 VANTAA, Finland
Phone: +358-20-741-8100
Fax: +358-20-741-8111

• Denmark

Anritsu A/S

c/o Regus Fairway, Arne Jacobsens Allé 7, 5th floor,
2300 Copenhagen S, Denmark
Phone: +45-7211-2200

• Russia

Anritsu EMEA Ltd.

Representation Office in Russia

Tverskaya str. 16/2, bld. 1, 7th floor.
Moscow, 125009, Russia
Phone: +7-495-363-1694
Fax: +7-495-935-8962

• Spain

Anritsu EMEA Ltd.

Representation Office in Spain

Paseo de la Castellana, 141. Planta 5, Edificio Cuzco IV
28046, Madrid, Spain
Phone: +34-91-572-6761

• United Arab Emirates

Anritsu EMEA Ltd.

Dubai Liaison Office

902, Aurora Tower,
P O Box: 500311 - Dubai Internet City
Dubai, United Arab Emirates
Phone: +971-4-3758479
Fax: +971-4-4249036

• India

Anritsu India Private Limited

6th Floor, Indiqube ETA, No.38/4, Adjacent to EMC2,
Doddanekundi, Outer Ring Road, Bengaluru - 560048, India
Phone: +91-80-6728-1300
Fax: +91-80-6728-1301

• Singapore

Anritsu Pte. Ltd.

11 Chang Charn Road, #04-01, Shriro House
Singapore 159640
Phone: +65-6282-2400
Fax: +65-6282-2533

• P.R. China (Shanghai)

Anritsu (China) Co., Ltd.

Room 2701-2705, Tower A,
New Caohejing International Business Center
No. 391 Gui Ping Road Shanghai, 200233, P.R. China
Phone: +86-21-6237-0898
Fax: +86-21-6237-0899

• P.R. China (Hong Kong)

Anritsu Company Ltd.

Unit 1006-7, 10/F., Greenfield Tower, Concordia Plaza,
No. 1 Science Museum Road, Tsim Sha Tsui East,
Kowloon, Hong Kong, P.R. China
Phone: +852-2301-4980
Fax: +852-2301-3545

• Japan

Anritsu Corporation

8-5, Tamura-cho, Atsugi-shi, Kanagawa, 243-0016 Japan
Phone: +81-46-296-6509
Fax: +81-46-225-8352

• Korea

Anritsu Corporation, Ltd.

5FL, 235 Pangyoyeok-ro, Bundang-gu, Seongnam-si,
Gyeonggi-do, 13494 Korea
Phone: +82-31-696-7750
Fax: +82-31-696-7751

• Australia

Anritsu Pty. Ltd.

Unit 20, 21-35 Ricketts Road,
Mount Waverley, Victoria 3149, Australia
Phone: +61-3-9558-8177
Fax: +61-3-9558-8255

• Taiwan

Anritsu Company Inc.

7F, No. 316, Sec. 1, NeiHu Rd., Taipei 114, Taiwan
Phone: +886-2-8751-1816
Fax: +886-2-8751-1817