

Keysight Technologies
11644A R, Q, U, V, and W
Waveguide Calibration Kits

This manual applies to 11644A series calibration kits with serial number prefix 3032A.

Notices

© Keysight Technologies, Inc.
1994-2022

No part of this manual may be reproduced in any form or by any means (including electronic storage and retrieval or translation into a foreign language) without prior agreement and written consent from Keysight Technologies, Inc. as governed by United States and international copyright laws.

Trademark Acknowledgments

Manual Part Number

11644-90369

Edition

Edition 2, May 2022

Printed in USA/Malaysia

Published by:
Keysight Technologies
1400 Fountaingrove Parkway
Santa Rosa, CA 95403

Warranty

THE MATERIAL CONTAINED IN THIS DOCUMENT IS PROVIDED "AS IS," AND IS SUBJECT TO BEING CHANGED, WITHOUT NOTICE, IN FUTURE EDITIONS. FURTHER, TO THE MAXIMUM EXTENT PERMITTED BY APPLICABLE LAW, KEYSIGHT DISCLAIMS ALL WARRANTIES, EITHER EXPRESS OR IMPLIED WITH REGARD TO THIS MANUAL AND ANY INFORMATION CONTAINED HEREIN, INCLUDING BUT NOT LIMITED TO THE IMPLIED WARRANTIES OF MERCHANTABILITY AND FITNESS FOR A PARTICULAR PURPOSE. KEYSIGHT SHALL NOT BE LIABLE FOR ERRORS OR FOR INCIDENTAL OR CONSEQUENTIAL DAMAGES IN CONNECTION WITH THE FURNISHING, USE, OR PERFORMANCE OF THIS DOCUMENT OR ANY INFORMATION CONTAINED HEREIN. SHOULD KEYSIGHT AND THE USER HAVE A SEPARATE WRITTEN AGREEMENT WITH WARRANTY TERMS COVERING THE MATERIAL IN THIS

DOCUMENT THAT CONFLICT WITH THESE TERMS, THE WARRANTY TERMS IN THE SEPARATE AGREEMENT WILL CONTROL.

Technology Licenses

The hardware and/or software described in this document are furnished under a license and may be used or copied only in accordance with the terms of such license.

U.S. Government Rights

The Software is "commercial computer software," as defined by Federal Acquisition Regulation ("FAR") 2.101. Pursuant to FAR 12.212 and 27.405-3 and Department of Defense FAR Supplement ("DFARS") 227.7202, the U.S. government acquires commercial computer software under the same terms by which the software is customarily provided to the public.

Accordingly, Keysight provides the Software to U.S. government customers under its standard commercial license, which is embodied in its End User License Agreement (EULA), a copy of which can be found at

<http://www.keysight.com/find/sweula>

The license set forth in the EULA represents the exclusive authority by which the U.S. government may use, modify, distribute, or disclose the Software. The EULA and the license set forth therein, does not require or permit, among other things, that Keysight: (1) Furnish technical information related to commercial computer software or commercial computer software documentation that is not customarily provided to the public; or (2) Relinquish to, or otherwise provide, the government rights in excess of these rights customarily provided to the public to use, modify, reproduce, release, perform, display, or disclose commercial computer software or commercial computer software documentation. No additional

government requirements beyond those set forth in the EULA shall apply, except to the extent that those terms, rights, or licenses are explicitly required from all providers of commercial computer software pursuant to the FAR and the DFARS and are set forth specifically in writing elsewhere in the EULA. Keysight shall be under no obligation to update, revise or otherwise modify the Software. With respect to any technical data as defined by FAR 2.101, pursuant to FAR 12.211 and 27.404.2 and DFARS 227.7102, the U.S. government acquires no greater than Limited Rights as defined in FAR 27.401 or DFAR 227.7103-5 (c), as applicable in any technical data.

Safety Notices

CAUTION

A **CAUTION** notice denotes a hazard. It calls attention to an operating procedure, practice, or the like that, if not correctly performed or adhered to, could result in damage to the product or loss of important data. Do not proceed beyond a CAUTION notice until the indicated conditions are fully understood and met.

WARNING

A **WARNING** notice denotes a hazard. It calls attention to an operating procedure, practice, or the like that, if not correctly performed or adhered to, could result in personal injury or death. Do not proceed beyond a WARNING notice until the indicated conditions are fully understood and met.

1. General Information

Calibration Kit Overview	1-2
Kit Contents	1-2
Calibration Definitions	1-2
Equipment Required but Not Supplied	1-3
Calibration Kit History	1-3
11644A Series Kits with Serial Prefix 3012A	1-3
Incoming Inspection	1-3
Recording the Device Serial Numbers	1-4
Preventive Maintenance	1-5
When to Calibrate	1-6

2. Specifications

Environmental Requirements	2-2
Temperature—What to Watch Out For	2-2
Mechanical Characteristics	2-3
$\frac{1}{4}$ Wavelength Shims	2-3
Shorts	2-3
Electrical Specifications	2-4
Measurement Uncertainty	2-5
Certification	2-5

3. User Information

Calibration Devices and Their Use	3-2
Short	3-2
Standard Section	3-2
Termination	3-2
$\frac{1}{4}$ Wavelength Shim	3-2
Waveguide Straight Section (verification device)	3-2
Waveguide Straight Section (port 1 and 2)	3-2
Measurement Applications	3-3
Isolation	3-3
Line	3-3
Load	3-4
Offset Load	3-4
Offset Short	3-5
Reflect	3-5
Short	3-5
Thru	3-6
$\frac{1}{4}$ Wavelength Load	3-6
$\frac{1}{4}$ Wavelength Short	3-6

Contents

Changing the $\frac{1}{4}$ Wavelength Shim Calibration Definition	3-7
4. Use, Maintenance, and Care of the Devices	
Electrostatic Discharge	4-2
Visual Inspection	4-3
Cleaning the Mating Plane Surfaces	4-3
Connections	4-5
Waveguide Devices	4-5
Precision Flanges	4-5
Aligning Two Precision Flanges	4-6
Aligning a Precision and a Non-Precision Flange	4-7
Tightening a Flange Connection	4-8
Inspecting a Flange Connection	4-8
Handling and Storage	4-9
5. Performance Verification	
Introduction	5-2
How Keysight Verifies the Devices in Your Kit	5-2
Recertification	5-3
How Often to Recertify	5-3
Where to Send a Kit for Recertification	5-3
Performance Test	5-4
Termination Return Loss Measurement	5-4
In Case of Failure	5-5
6. Troubleshooting	
Troubleshooting Process	6-2
Where to Look for More Information	6-3
Returning a Kit or Device to Keysight	6-4
Contacting Keysight	6-5
7. Replaceable Parts	
Introduction	7-3
A. Standard Definitions	
Class Assignments and Standard Definitions Values are Available on the Web	A-2

1 General Information

Printing Copies from Keysight

Product maintenance agreements and other customer assistance agreements are available for Keysight products.

For any assistance, contact Keysight Technologies. Refer to **“Contacting Keysight” on page 6-3** for a list of Keysight contacts.

Calibration Kit Overview

This waveguide calibration kit is used to calibrate network analyzer systems (such as the Keysight 8510, 872x, or PNA series). With the calibration data properly loaded in the network analyzer and a measurement calibration completed, systematic errors are minimized.

NOTE

TRL (thru-reflect-line) calibrations require Keysight 8510 operating system firmware revision B.05.12 or greater.

Kit Contents

Use the Contents List in the shipping container to verify the completeness of your shipment. Although this list is the most accurate, you can also use the illustrations in Chapter 7 to verify the items in your shipment. If your shipment is not complete, contact Keysight Technologies - refer to **“Contacting Keysight” on page 6-3**.

The standards in this calibration kit allow you to perform simple 1- or 2-Port and TRM (thru-reflect-match) calibrations.

For your convenience, two different lengths of screws are provided in this kit. While you can use the long screws for any connection, the shorter screws provide a faster connection for two-flange connections.

Calibration Definitions

The calibration kit must be selected and the calibration definitions for the devices in the kit installed in the network analyzer prior to performing a calibration.

The calibration definitions can be:

- resident within the analyzer
- manually entered from the front panel

Class assignments and standard definitions may change as more accurate model and calibration methods are developed. You can download the most accurate class assignments and standard definitions from Keysight's Calibration Kit Definitions Web page at <https://www.keysight.com/us/en/assets/9922-01521/technical-specifications/Calibration-Kit-Definitions.pdf>.

Refer to your network analyzer user's guide or embedded Help for instructions on manually entering calibration definitions, selecting the calibration kit, and performing a calibration.

NOTE

The 8510 network analyzer is no longer being sold or supported by Keysight. However, you can download the 8510 class assignments and standard definitions from Keysight's Calibration Kit Definitions Web page at <https://www.keysight.com/us/en/assets/9922-01521/technical-specifications/Calibration-Kit-Definitions.pdf>.

Equipment Required but Not Supplied

Cleaning supplies and various electrostatic discharge (ESD) protection devices are not supplied with the calibration kit but are required to ensure successful operation of the kit. Refer to [Table 7-6 on page 11](#) for their associated part numbers.

Calibration Kit History

This manual applies to any Keysight 11644A series (R, Q, U, V, or W) waveguide calibration kits whose serial number prefix is listed on the title page. If your calibration kit has a different serial number prefix, refer to the next section for information on how this manual applies.

11644A Series Kits with Serial Prefix 3012A

These calibration kits did not have a calibration definitions disk to support the Keysight 8510C network analyzer. The part numbers provided in this manual are the recommended replacement parts for these kits. The devices in these kits should meet the specifications published in this manual.

Incoming Inspection

Verify that the case and its contents are not damaged. The foam-lined storage case provides protection during shipping. If the case or any device appears damaged, or if the shipment is incomplete, refer to **“Contacting Keysight” on page 6-3**. Keysight will arrange for repair or replacement of incomplete or damaged shipments without waiting for a settlement from the transportation company. Refer to **“Returning a Kit or Device to Keysight” on page 3**.

Recording the Device Serial Numbers

In addition to the kit serial number, the devices in the kit are individually serialized (serial numbers are labeled onto the body of each device). Record these serial numbers in the appropriate table. Recording the serial numbers will prevent confusing the devices in this kit with similar devices from other kits.

Table 1-1 V and W Band Serial Number Record

Device	Serial Number
Frequency band	_____
Calibration kit	_____
Fixed load	_____
Straight section (5 cm)	_____
Straight section (5 cm)	_____
Straight section (5 cm)	_____
Shim	_____
Short	_____

Table 1-2 R, Q, and U Band Serial Number Record

Device	Serial Number
Frequency band	_____
Calibration kit	_____
Straight section (5 cm)	_____
Straight section (5 cm)	_____
Standard section (10 cm)	_____
Waveguide straight	_____
Shim	_____
Short	_____

Preventive Maintenance

The best techniques for maintaining the integrity of the devices in the kit include:

- routine visual inspection
- routine cleaning
- proper gaging
- proper connection techniques

All of these are described in **Chapter 4**. Failure to detect and remove dirt or metallic particles on a mating plane surface can degrade repeatability and accuracy and can damage any device mated to it. Improper connections resulting from poor connection techniques, can also damage these devices.

When to Calibrate

A network analyzer calibration remains valid as long as the changes in the systematic error are insignificant. This means that changes to the uncorrected leakages (directivity and isolation), mismatches (source match and load match), and frequency response of the system are small (<10%) relative to accuracy specifications.

Change in the environment (especially temperature) between calibration and measurement is the major cause in calibration accuracy degradation. The major effect is a change in the physical length of external and internal cables. Other important causes are dirty and damaged test port connectors and calibration standards. If the connectors become dirty or damaged, measurement repeatability and accuracy is affected. Fortunately, it is relatively easy to evaluate the general validity of the calibration. To test repeatability, remeasure one of the calibration standards. If you can not obtain repeatable measurements from your calibration standards, maintenance needs to be performed on the test port connectors, cables and calibration standards. Also, maintain at least one sample of the device under test or some known device as your reference device. A verification kit may be used for this purpose. After calibration, measure the reference device and note its responses. Periodically remeasure the device and note any changes in its corrected response which can be attributed to the test system. With experience you will be able to see changes in the reference responses that indicate a need to perform the measurement calibration again.

General Information
When to Calibrate

2 Specifications

Environmental Requirements

Table 2-1 Environmental Requirements

Parameter	Limits
Temperature	
Operating ^a	+20 °C to +26 °C
Storage	–40 °C to +75 °C
Error-corrected range ^b	±1 °C of measurement calibration temperature
Relative humidity	Type tested, 0% to 95% at 40 °C, non-condensing

- a. The temperature range over which the calibration standards maintain performance to their specifications.
- b. The allowable network analyzer ambient temperature drift during measurement calibration and during measurements when the network analyzer error correction is turned on. Also, the range over which the network analyzer maintains its specified performance while correction is turned on.

Temperature—What to Watch Out For

Changes in temperature can affect electrical characteristics. Therefore, the operating temperature is a critical factor in performance. During a measurement calibration, the temperature of the calibration devices must be stable and within the range shown in [Table 2-1](#).

NOTE

IMPORTANT! Avoid unnecessary handling of the devices during calibration because your fingers act as a heat source and may increase the temperature of the device.

Mechanical Characteristics

Table 2-2 lists the typical characteristics of the $\frac{1}{4}$ wavelength shims in your kit. These are not specifications, but are included as additional information.

$\frac{1}{4}$ Wavelength Shims

Figure 2-1 $\frac{1}{4}$ Wavelength Shims

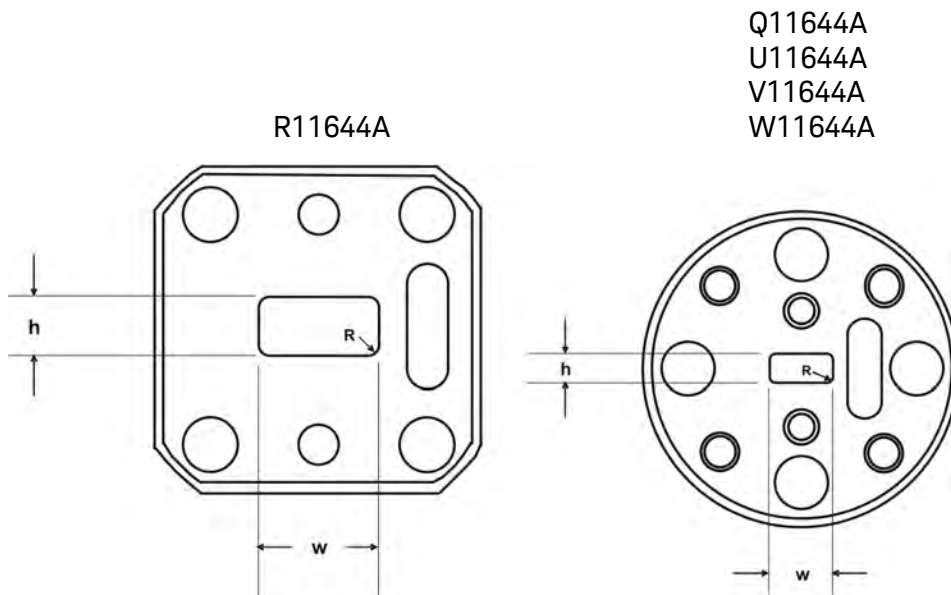

Table 2-2 Mechanical Characteristics of $\frac{1}{4}$ Wavelength Shims

Part Number	Waveguide Band	W (mm)	H (mm)	R (mm)	Thickness (mm)
11664-20003	R11644A - WR28	7.112 ±0.006	3.556 ±0.006	0.043 max	3.018 ±0.013
11664-20001	Q11644A - WR22	5.690 ±0.006	2.845 ±0.006		2.422 ±0.013
11664-20002	U11644A - WR19	4.775 ±0.006	2.388 ±0.006		1.991 ±0.013
11664-20013	V11644A - WR15	3.759 ±0.006	1.880 ±0.006		1.611 ±0.005
11664-20014	W11644A - WR10	2.540 ±0.006	1.270 ±0.006		1.085 ±0.005

Shorts

All waveguide shorts are flat within 0.008 mm.

Electrical Specifications

Table 2-3 through **Table 2-5** list the electrical specifications of the terminations, ¼ wavelength shims, and standard sections in your kit.

Table 2-3 Electrical Specifications of Terminations

Device	Frequency	Termination Specification
R11644A WR-28	26.5 to 40 GHz	Effective return loss \geq 46 dB ^a
Q11644A WR-22	33 to 50 GHz	Effective return loss \geq 46 dB ^a
U11644A WR-19	40 to 60 GHz	Effective return loss \geq 46 dB ^a
V11644A WR-15	50 to 75 GHz	Return loss \geq 38.2 dB
W11644A WR-10	75 to 110 GHz	Return loss \geq 36.6 dB

a. Effective return loss accounts for line section, connector, and load stability as used in a network analyzer to define directivity after calibration.

Table 2-4 Electrical Specifications of ¼ Wavelength Shims

Part Number	Waveguide Band	Return Loss (dB) ^a
11664-20003	WR28	50
11664-20001	WR22	
11664-20002	WR19	
11664-20013	WR15	
11664-20014	WR10	46

a. Return loss specification is guaranteed by mechanical specifications.

Table 2-5 Electrical Specifications of Standard Sections

Device	Frequency	Standard Section Specification
R11644A WR-28	26.5 to 40 GHz	Return loss \geq 42 dB
Q11644A WR-22	33 to 50 GHz	Return loss \geq 42 dB
U11644A WR-19	40 to 60 GHz	Return loss \geq 42 dB
V11644A WR-15	50 to 75 GHz	Return loss \geq 40 dB
W11644A WR-10	75 to 110 GHz	Return loss \geq 36.6 dB

Measurement Uncertainty

Vector Network Analyzer (VNA) measurement accuracy depends on the accuracy of the calibration standards, the calibration method employed, instrumentation accuracy and stability, environmental factors, and the actual characteristic of the device under test (DUT). Because of the complexity in these relationships, Keysight created uncertainty computation tools to calculate the overall measurement uncertainty of a VNA system. In the past, when the Keysight 8510 VNA system was being produced, a “Specification and Verification” RMB program was included to perform an uncertainty calculation. Currently, for the Keysight PNA and ENA families of network analyzers, a customer can download the VNA Uncertainty Calculator program. (To access this program from the Web, navigate to www.keysight.com and enter “calculator” in the Search function.) Explanations of the uncertainty model are provided in the PNA embedded Help files. Additional references on VNA measurements are available from the Keysight Applications Notes and Technical Papers Web page, accessed by www.keysight.com from clicking on the Application Notes and Technical Papers hyperlink.

Certification

Keysight Technologies certifies that this product met its published specifications at the time of shipment from the factory. Keysight further certifies that its calibration measurements are traceable to the United States National Institute of Standards and Technology (NIST) to the extent allowed by the institute’s calibration facility, and to the calibration facilities of other International Standards Organization members. See [“How Keysight Verifies the Devices in Your Kit” on page 1](#) for more information.

3 User Information

Calibration Devices and Their Use

The R, Q, U, V, and W11644 waveguide calibration kits may contain some or all of the following: short, standard section, termination loads, wavelength shim, and waveguide straights.

The following briefly describes the design and construction of all the calibration kit devices.

NOTE

IMPORTANT! To ensure calibration accuracy, you must use the alignment slip pins in the precision flanges. Refer to **“Precision Flanges” on page 4-5.**

Short

A short is also called a flush short. It is connected directly to the test port, or used as an offset short when combined with the $\frac{1}{4}$ wavelength shim.

Standard Section

A standard section is used to check system operation after you complete a calibration.

Termination

A termination is also called a load. It is connected directly to the test port, or used as an offset load when combined with the $\frac{1}{4}$ wavelength shim.

$\frac{1}{4}$ Wavelength Shim

A $\frac{1}{4}$ wavelength shim is also called an offset, or $\frac{1}{4}$ wavelength section. The shim is terminated by the short, fixed load, or the second test port of the analyzer.

Waveguide Straight Section (verification device)

A waveguide straight is included as a system verification device. Be sure to keep it protected from wear and damage. When using it, always connect the same side, in the same orientation, for consistent and accurate mating.

Waveguide Straight Section (port 1 and 2)

Two waveguide straights, provided in this kit, are used as port 1 and port 2 measurement planes when properly connected to the directional couplers. Because these straight sections are used as port 1 and port 2 for device

User Information
Calibration Devices and Their Use

connections, they reduce wear that would otherwise occur to the coupler flanges. These particular straights should be replaced or renewed whenever the calibration devices are replaced or renewed.

Measurement Applications

NOTE

For your convenience, two different lengths of screws are provided in this kit. While you can use the long screws for any connection, the shorter screws provide a faster connection for two-flange connections.

Isolation

In most cases, select the **OMIT ISOLATION softkey** on your network analyzer. You may also use the termination and the short as the port terminations by connecting one load to port 1 and the other load to port 2. See [Figure 3-1](#).

Figure 3-1 Termination and Short

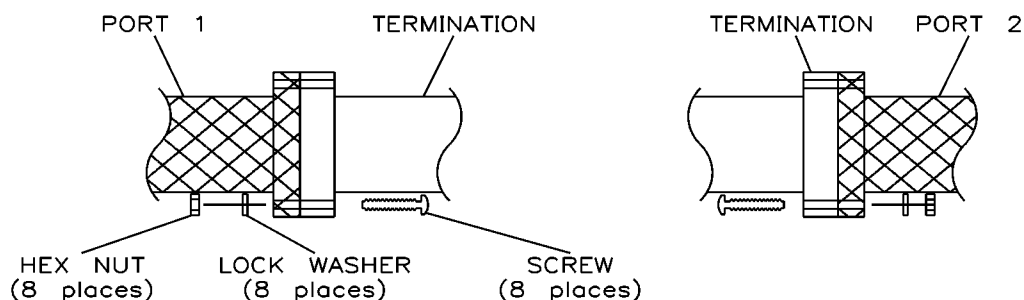

wx401a

Line

Connect the shim between port 1 and port 2, as shown in [Figure 3-2](#).

Figure 3-2 Connecting the Shim

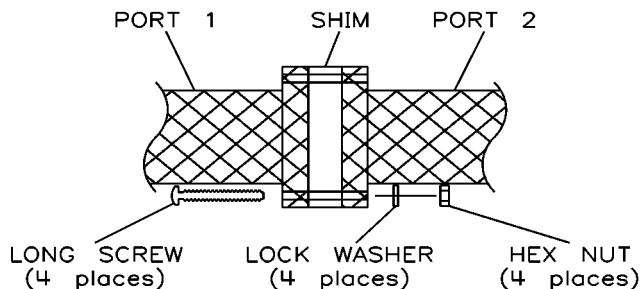

wx402a

Load

Connect the termination to the appropriate test port, as shown in **Figure 3-3**.

Figure 3-3 Test Port and Termination

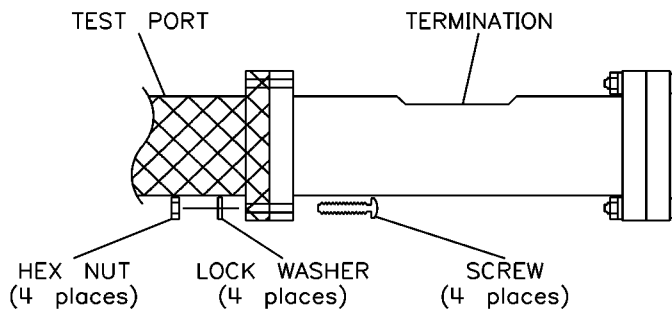

wx403a

Offset Load

Connect the shim and the termination to the appropriate test port, as shown in **Figure 3-4**.

NOTE

For offset load calibration with the R11644A WR-28, Q11644A WR-22, and U11644A WR-19, the moving load must be in a locked position. For more information refer to your network analyzer user's guide.

Figure 3-4 Connect the Shim and the Termination to the Test Port

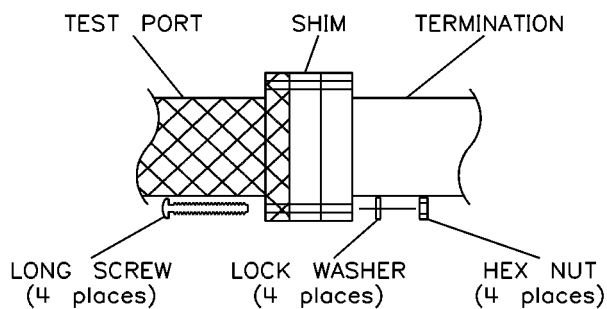

wx404a

Offset Short

Connect the shim and the short to the appropriate test port, as shown in **Figure 3-5**.

Figure 3-5 Connect the Shim and the Short to the Test Port

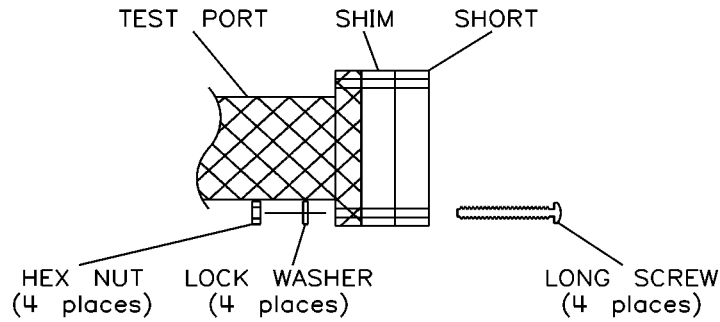

wx405a

Reflect

Connect the short to the appropriate test port, as shown in **Figure 3-6**.

Figure 3-6 Connect the Short to the Test Port

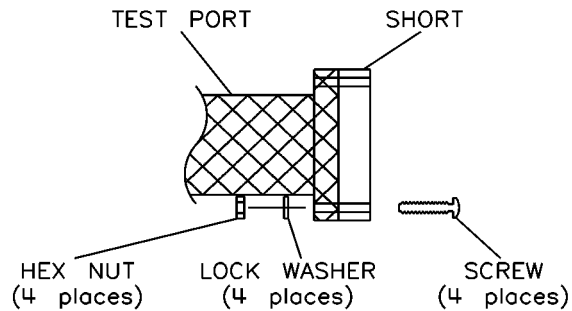

wx406a

Short

See **“Reflect”** above.

Thru

No device is required for this. Connect port 1 to port 2, as shown in **Figure 3-7**.

Figure 3-7 Connect Port 1 to Port 2

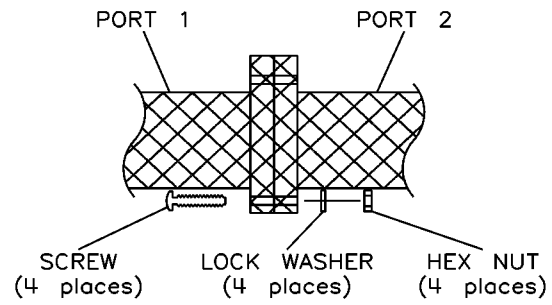

wx407a

$\frac{1}{4}$ Wavelength Load

See **“Offset Load”**.

$\frac{1}{4}$ Wavelength Short

See **“Offset Short”**.

Changing the ¼ Wavelength Shim Calibration Definition

The calibration kit definition data provided with this kit has a nominal value for the ¼ wavelength shim offset delay. You may use the nominal value provided, or measure the exact thickness of the shim and use that value to calculate its exact offset delay. Use the following procedure to change the nominal value of the ¼ wavelength shim delay to reflect the specific device in your kit.

1. Load the calibration kit data into Cal Kit 1.
2. Using the formula below, calculate the offset delay:

$$\frac{\text{length of } \frac{1}{4} \text{ wavelength section (mm)}}{299.6953 \frac{\text{mm}}{\text{ns}} \text{ (propagation velocity in air)}} = \text{offset delay (ns)}$$

NOTE

The value of the propagation velocity in air is corrected for a temperature of 23 °C, 50% relative humidity, and 760 mm Hg of pressure.

User Information
Changing the $\frac{1}{4}$ Wavelength Shim Calibration Definition

4 Use, Maintenance, and Care of the Devices

Electrostatic Discharge

Protection against electrostatic discharge (ESD) is essential while connecting, inspecting, or cleaning connectors attached to a static-sensitive circuit (such as those found in test sets).

Static electricity can build up on your body and can easily damage sensitive internal circuit elements when discharged. Static discharges too small to be felt can cause permanent damage. Devices such as calibration components and devices under test (DUT), can also carry an electrostatic charge. To prevent damage to the test set, components, and devices:

- **Always** wear a grounded wrist strap having a 1 M Ω resistor in series with it when handling components and devices or when making connections to the test set.
- **Always** use a grounded antistatic mat in front of your test equipment.
- **Always** wear a heel strap when working in an area with a conductive floor. If you are uncertain about the conductivity of your floor, wear a heel strap.
- **Always** ground the center conductor of a test cable before making a connection to the analyzer test port or other static-sensitive device. This can be done as follows:
 1. Connect a short (from your calibration kit) to one end of the cable to short the center conductor to the outer conductor.
 2. While wearing a grounded wrist strap, grasp the outer shell of the cable connector.
 3. Connect the other end of the cable to the test port.
 4. Remove the short from the cable.

Figure 4-1 shows a typical ESD protection setup using a grounded mat and wrist strap. Refer to **Table 7-6 on page 7-11** for information on ordering supplies for ESD protection.

Figure 4-1 ESD Protection Setup

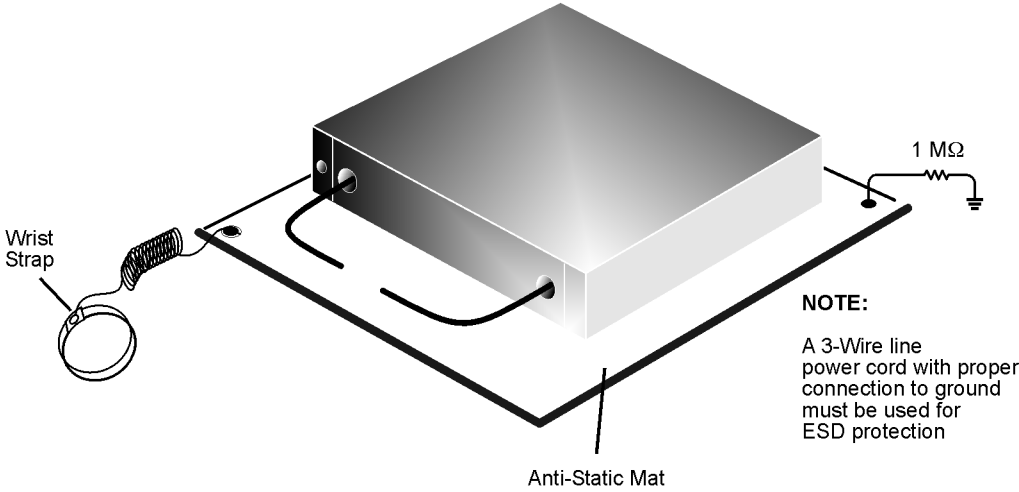

esd_setup

Visual Inspection

Visual inspection and, if necessary, cleaning should be done every time a connection is made. Inspect mating surfaces for dirt, dust, foreign particles, or scratches, which can degrade device performance. A damaged mating surface can damage any good surface connected to it. If necessary, clean all mating surfaces.

Magnification is helpful when inspecting mating surfaces, but it is not required and may actually be misleading. Defects and damage that cannot be seen without magnification generally have no effect on electrical or mechanical performance. Magnification is of great use in analyzing the nature and cause of damage and in cleaning mating surfaces, but it is not required for inspection.

Cleaning the Mating Plane Surfaces

1. Use Compressed Air or Nitrogen

WARNING

Always use protective eyewear when using compressed air or nitrogen.

Use compressed air (or nitrogen) to loosen particles on the mating plane surfaces. Clean air cannot damage a device or leave particles or residues behind.

You can use any source of clean, dry, low-pressure compressed air or nitrogen that has an effective oil-vapor filter and liquid condensation trap placed just before the outlet hose.

Ground the hose nozzle to prevent electrostatic discharge, and set the air pressure to less than 414 kPa (60 psi) to control the velocity of the air stream. High-velocity streams of compressed air can cause electrostatic

effects when directed into a device. These electrostatic effects can damage the device. Refer to “**Electrostatic Discharge**” earlier in this chapter for additional information.

WARNING

Keep isopropyl alcohol away from heat, sparks, and flame. Store in a tightly closed container. It is extremely flammable. In case of fire, use alcohol foam, dry chemical, or carbon dioxide; water may be ineffective. Use isopropyl alcohol with adequate ventilation and avoid contact with eyes, skin, and clothing. It causes skin irritation, may cause eye damage, and is harmful if swallowed or inhaled. It may be harmful if absorbed through the skin. Wash thoroughly after handling.

In case of spill, soak up with sand or earth. Flush spill area with water.

Dispose of isopropyl alcohol in accordance with all applicable federal, state, and local environmental regulations.

2. Clean the Mating Plane Surfaces

- a. Apply a small amount of isopropyl alcohol to a lint-free cleaning swab.
- b. Clean the mating plane surfaces.
- c. Let the alcohol evaporate, then blow the mating plane surface dry with a gentle stream of clean, low-pressure compressed air or nitrogen. Always completely dry a device before you reassemble or use it.

3. Inspect

- a. Inspect the mating plane surface to make sure that no particles or residue remain. “**Visual Inspection**” on page 4-3.

Connections

Good connections require a skilled operator. **Slight errors in operator technique can have a significant effect on measurements and measurement uncertainties. The most common cause of measurement error is poor connections.**

The following procedures illustrate how to make good connections.

Waveguide Devices

NOTE

IMPORTANT! Unlike threaded devices, the WR-28, WR-22, WR-19, WR-15, and WR-10 waveguide mating planes are flanges (often precision) that you must carefully screw together. Always connect waveguide in the same flange orientation. For example, use the label as a reference and always connect a device with the label facing the same direction.

Precision Flanges

A precision flange has four corner screw holes and two precision alignment holes, as shown in **Figure 4-2**. A non-precision flange has only four corner screw holes.

Figure 4-2 Precision Alignment Holes

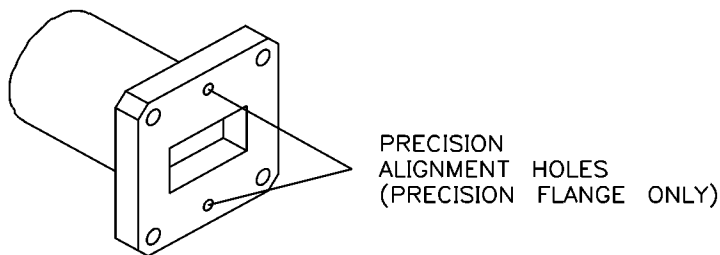

wx409a

Aligning Two Precision Flanges

1. Place the slip pins in the top and bottom holes of one flange, as shown in **Figure 4-3**.

Figure 4-3 Inserting Slip Pins

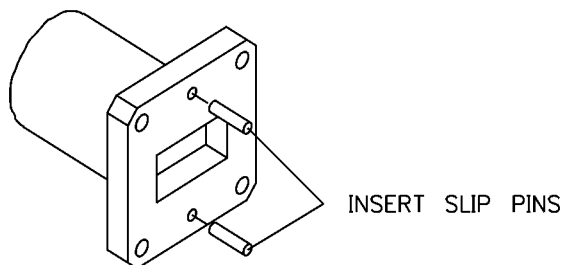

wx410a

2. Using the pins as guides, carefully align the flanges and insert two screws in the diagonal corner holes, as shown in [Figure 4-4](#).

Figure 4-4 Aligning Flanges

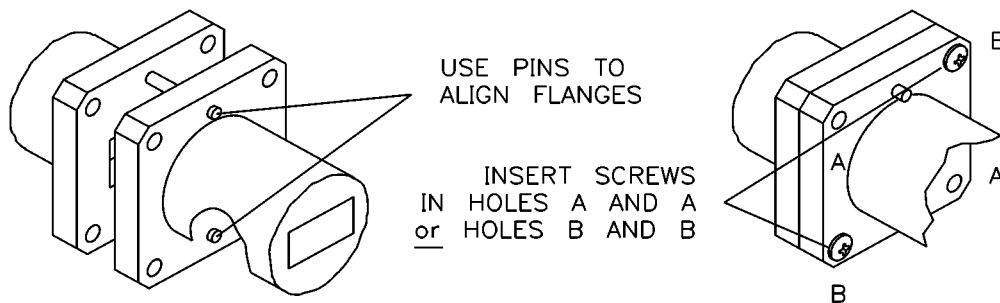

wx411a

3. Place a lock washer and nut on each screw, and finger tighten.
4. Insert the remaining two screws.
5. Place a lock washer and nut on each screw, and finger tighten.
6. Remove the slip pins.
7. Go to [“Tightening a Flange Connection” on page 4-7](#).

Aligning a Precision and a Non-Precision Flange

1. Place an alignment pin (with head) in the corner hole of one flange. Place a second alignment pin in the diagonal corner hole of the second flange. See [Figure 4-5](#).

Figure 4-5 Aligning Pins

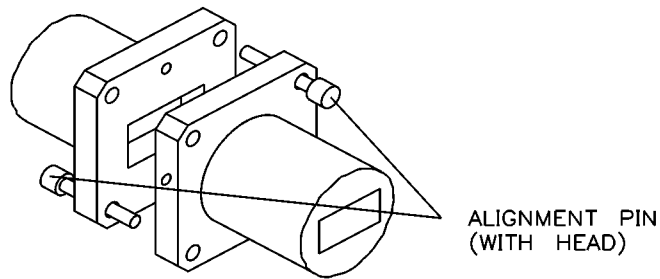

wx412a

2. Using the pins as guides, carefully align the flanges and insert screws in the diagonal corner holes.
3. Place a lock washer and nut on each screw, and finger tighten.
4. Remove the alignment pins and insert the remaining two screws.
5. Place a lock washer and nut on each screws, and finger tighten.
6. Go to [“Tightening a Flange Connection” on page 4-7.](#)

Tightening a Flange Connection

NOTE

The best connection has symmetrical pressure applied as you gradually tighten the screws.

1. In an “X” pattern (for equal compression), tighten all four screws using a hex ball driver. Do not over-tighten. See [Figure 4-6.](#)
2. Visually inspect the connection. Refer to the following section [“Inspecting a Flange Connection” on page 4-8](#)

Figure 4-6 “X” Screw Pattern

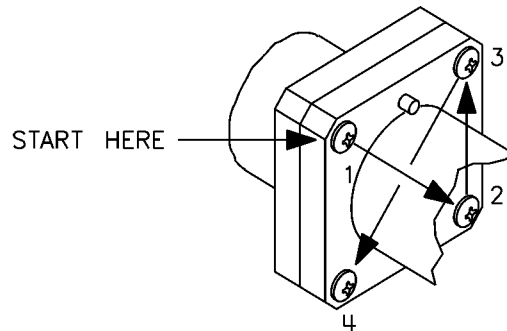

wx413a

Inspecting a Flange Connection

Inspect the flange connection as follows:

1. Place an electric light or white paper behind the connection.
2. Check the flange matings for any gap. A good connection has no gaps between the connected waveguide flanges, and the waveguide walls are flush. There is no step or offset.
3. Ensure that all four screws are equally tight.

NOTE

The most common cause of measurement error is a poor connection.

Handling and Storage

- Install the protective end caps and store the calibration devices in the foam-lined storage case when not in use.
- Never store devices loose in a box, or in a desk or bench drawer. This is the most common cause of device damage during storage.
- Keep devices clean.
- Do not touch mating plane surfaces. Natural skin oils and microscopic particles of dirt are easily transferred to a device and are very difficult to remove.
- Do not set devices contact-end down on a hard surface. The plating and the mating plane surfaces can be damaged if the interface comes in contact with any hard surface.

Use, Maintenance, and Care of the Devices
Handling and Storage

5 Performance Verification

Introduction

The performance of your calibration kit can only be verified by returning the kit to Keysight Technologies for recertification. The equipment and calibration standards required to verify the specifications of the limits of the devices in the kit have been specially manufactured and are not commercially available. However, you may check the performance of the terminations in this kit by following the procedure **“Termination Return Loss Measurement” on page 5-3.**

How Keysight Verifies the Devices in Your Kit

Keysight verifies the specifications of these devices as follows:

- 1. The residual microwave error terms of the test system are verified with precision airlines and shorts that are directly traced to the National Institute of Standards and Technology (NIST). The airline and short characteristics are developed from mechanical measurements. The mechanical measurements and material properties are carefully modeled to give very accurate electrical representation. The mechanical measurements are then traced to NIST through various plug and ring gages and other mechanical measurements.**
- 2. Each calibration device is electrically tested on this system. For the initial (before sale) testing of the calibration devices, Keysight includes the test measurement uncertainty as a guardband to guarantee each device meets the published specification. For recertifications (after sale), no guardband is used and the measured data is compared directly with the specification to determine the pass or fail status. The measurement uncertainty for each device is, however, recorded in the calibration report that accompanies recertified kits.**

These two steps establish a traceable link to NIST for Keysight to the extent allowed by the institute’s calibration facility. The specifications data provided for the devices in the kit is traceable to NIST through Keysight Technologies.

Recertification

The following will be provided with a recertified kit:

- a new calibration sticker affixed to the case
- a certificate of calibration
- a calibration report for each device in the kit listing measured values, specifications, and uncertainties

NOTE

A list of NIST traceable numbers may be purchased upon request to be included in the calibration report.

Keysight Technologies offers a **Standard** calibration for the recertification of the kit. For more information, contact Keysight Technologies. Refer to **“Contacting Keysight” on page 6-3**.

How Often to Recertify

The suggested initial interval for recertification is 12 months or sooner. The actual need for recertification depends on the use of the kit. After reviewing the results of the initial recertification, you may establish a different recertification interval that reflects the usage and wear of the kit.

NOTE

The recertification interval should begin on the date the kit is first used after the recertification date.

Where to Send a Kit for Recertification

Contact Keysight Technologies for information on where to send your kit for recertification. Refer to **“Contacting Keysight” on page 6-3**. Refer to **“Returning a Kit or Device to Keysight” on page 6-3** for details on sending your kit.

Performance Test

Termination Return Loss Measurement

Use this test to check the performance of the terminations in this kit.

Figure 5-1 Return Loss Test Setup

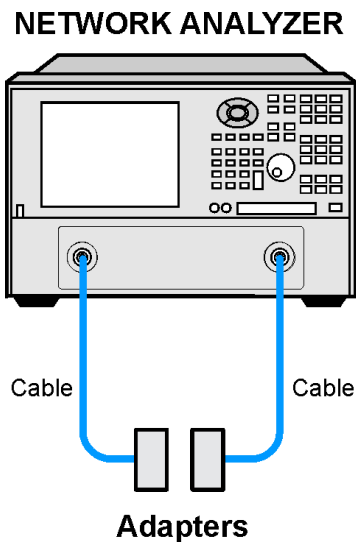

wx425a

1. Connect the equipment as shown in [Figure 5-1](#). Turn on and preset the network analyzer. Let the equipment warm up for at least one hour.

NOTE

The calibration kit definitions must already be loaded in the analyzer. Refer to your analyzer user's guide for information on how to load the calibration kit definitions.

2. Set the appropriate start frequency to:
 - 26.5 GHz (R-band)
 - 33 GHz (Q-band)
 - 40 GHz (U-band)
 - 50 GHz (V-band)
 - 75 GHz (W-band)
3. Set the appropriate stop frequency to:
 - 40 GHz (R-band)
 - 50 GHz (Q-band)

- 60 GHz (U-band)
 - 75 GHz (V-band)
 - 110 GHz (W-band)
4. Set the averaging factor to 512.
 5. At the adapter test port, perform a 2-port TRL calibration.
 6. Turn on the calibration.
 7. Connect the termination you wish to test to port 1.
 8. Measure the return loss (S_{11}) of the load.
 9. After one complete measurement sweep, the displayed trace should look similar to that shown in **Figure 5-2**.
 10. If necessary, update the trace.
 11. Use a marker to determine the maximum value on the trace. This marker determines worst-case return loss.

Figure 5-2

Typical Termination Return Loss

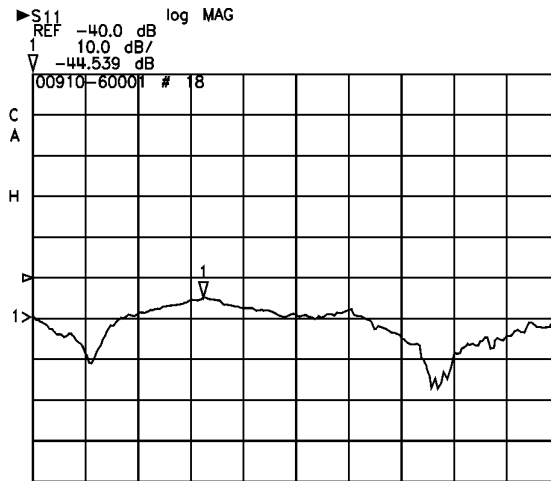

wx415a

In Case of Failure

If a termination fails this test, clean all flanges and carefully reconnect the devices. Repeat the test. If the termination fails again, replace it. Refer to **Table**

6 Troubleshooting

Troubleshooting Process

This manual contains limited information about network analyzer system operation. For complete information, refer to the instrument documentation.

If you suspect a bad calibration, or if your network analyzer does not pass performance verification, follow the steps in **Figure 6-1**.

Figure 6-1 Troubleshooting Flowchart

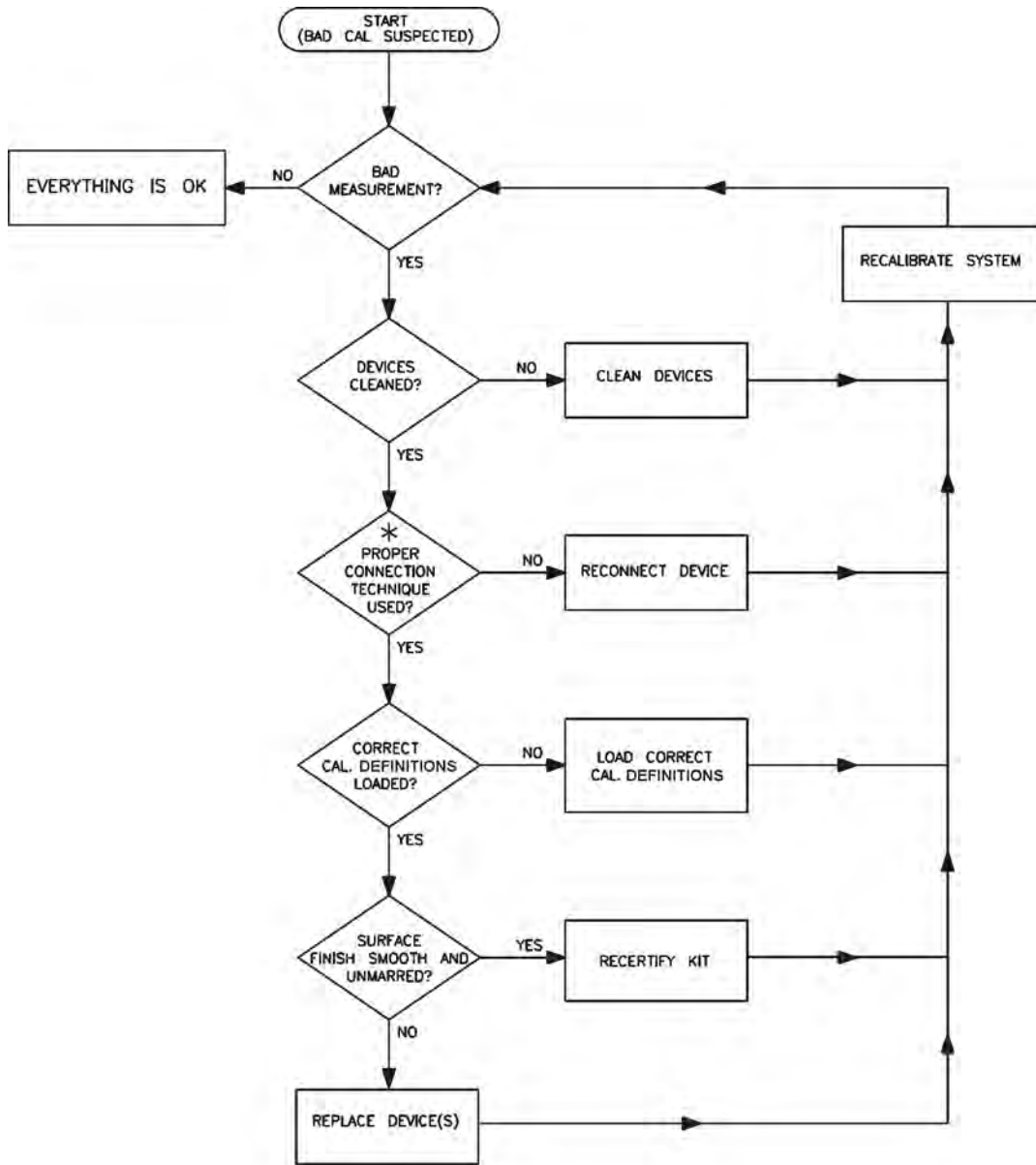

* NO GAPS; WAVEGUIDE WALLS FLUSH;
EVEN AND SYMMETRICAL TIGHTENING.

wx416a

Where to Look for More Information

This manual contains limited information about network analyzer system operation. For detailed information on using a VNA, ENA or PNA series network analyzer, refer to the appropriate user guide or online Help.

- To view the ENA or PNA online Help, press the Help key on the front panel of the network analyzer.
- To view an online VNA user guide, use the following steps:
 1. Go to www.keysight.com.
 2. Enter your VNA model number (Ex: 8753ES) in the Search box and click Search.
 3. Under the heading Manuals & Guides, click on the title/hyperlink for the document PDF you want to view.

If you need additional information, see “[Contacting Keysight](#)” on page 6-3.

Returning a Kit or Device to Keysight

If your kit or device requires service, contact Keysight Technologies for information on where to send it. See “[Contacting Keysight](#)” on page 6-3. Include a service tag (located near the end of this manual) on which you provide the following information:

- your company name and address
- a technical contact person within your company, and the person's complete telephone number
- the model number and serial number of the kit
- the part number and serial number of each device
- the type of service required
- a **detailed** description of the problem and how the device was being used when the problem occurred (such as calibration or measurement)

Getting Assistance from Keysight

By internet or phone, get assistance with all your test and measurement needs.

Contacting Keysight

Assistance with test and measurements needs and information on finding a local Keysight office are available on the Web at:

<http://www.keysight.com/find/assist>

If you do not have access to the Internet, please contact your Keysight field engineer.

NOTE

In any correspondence or telephone conversation, refer to the Keysight product by its model number and full serial number. With this information, the Keysight representative can determine whether your product is still within its warranty period.

If You Have Problems With the Upgrade Kit Contents

Keysight stands behind the quality of the upgrade kit contents. If you have problems with any item in the kit, refer to www.keysight.com and the **Contact Keysight** link.

7 Replaceable Parts

Introduction





The following tables list the replacement part numbers for the Keysight R, Q, U, V, and W11644A waveguide calibration kits. **Table 7-6** lists the replacement part numbers for items **not** included in the calibration kit that are either required or recommended for successful operation of this kit.

To order a listed part, note the description, part number, and the quantity desired. Telephone or send your order to Keysight Technologies. Refer to **“Contacting Keysight” on page 6-3** for further information.

Table 7-1 Replaceable Parts for the R11644A WR-28

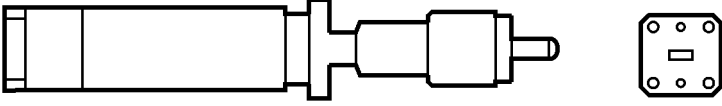
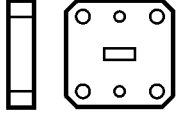
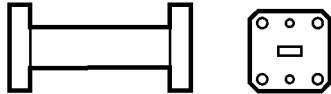
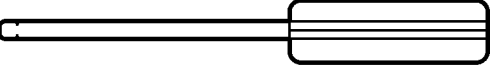
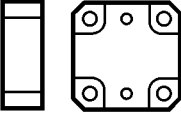
Description	Qty Per Kit	Keysight Part Number
Calibration Devices		
Straight section (5 cm)	2	11644-60016
Standard section (10 cm)	1	11644-60001
Waveguide load	1	11644-60004
Short	1	11644-20005
Shim	1	11644-20003
Hardware		
Alignment pin	6	11644-20009
Slip pin (2.367 mm diameter)	6	11644-20006
4-40 Hex nut (0.094 inch)	12	2260-0002
4-40 SKT HD screw (0.750 inch)	12	3030-0721
Lock washer (0.115 inch)	12	2190-0030
Open end wrench	1	8720-0013
Hex ball driver	1	8710-0523
Miscellaneous Items		
User's and service guide	1	11644-90369
Calibration Kit Storage Case		
Storage case	1	5181-5517
Box	2	1540-0034
Foam pad (set)	1	11644-80040

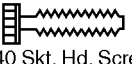
Figure 7-1 R-Band Component Identification Sheet



<p>Standard Section (10 cm)</p> <p>Used for system verification only.</p> 	
<p>Waveguide Load</p> 	
<p>1/4 Wavelength Section</p>  <p>Has mechanical length labeled on side or recessed area.</p>	<p>Straight Section (5 cm)</p>  <p>Used as port 1 and 2</p>
	<p>3/32 inch Hex Ball Driver</p> 
<p>Flush Short</p> 	<p>Slip Pin (2.367 mm diameter)</p>  <p>Alignment Pin (long)</p>  <p>4-40 Skt. Hd. Screw</p>  <p>Lock Washer</p>  <p>4-40 Hex Nut</p>  <p>Note: Short pins used on calibration devices, long pins used on DUTs.</p>

wx417a

Table 7-2 **Replaceable Parts for the Q11644A WR-22**

Description	Qty Per Kit	Keysight Part Number
Calibration Devices		
Straight section (5 cm)	2	11644-60017
Standard section (10 cm)	1	11644-60002
Waveguide load	1	11644-60005
Shim	1	11644-20001
Short	1	11644-20004
Hardware		
Slip pin (1.645 mm diameter)	6	11644-20008
Slip pin (2.367 mm diameter)	6	11644-20006
4-40 captive screw (0.31 inches long)	24	1390-0671
4-40 captive screw (0.43 inches long)	12	1390-0764
4-40 SKT HD screw (0.50 inches long)	12	3030-0209
Hex ball driver	1	8710-0523
Miscellaneous Items		
User's and service guide	1	11644-90369
Calibration Kit Storage Case		
Storage case	1	5181-5517
Box	2	1540-0034
Foam pad (set)	1	11644-80041

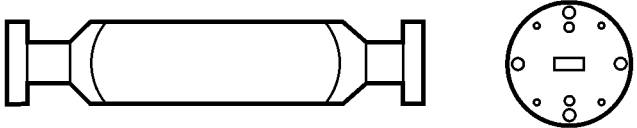
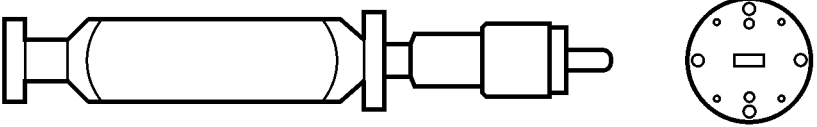
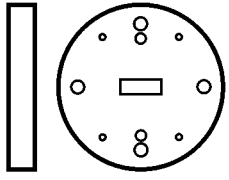
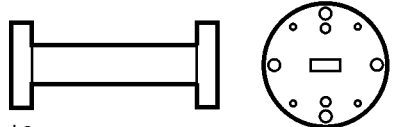
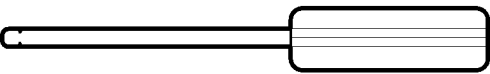
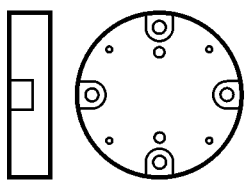
Figure 7-2 Q-Band Component Identification Sheet

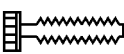
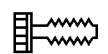
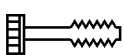

<p>Standard Section (10 cm)</p> <p>Used for system verification only.</p> 	
<p>Waveguide Load</p> 	
<p>Wavelength Section</p>  <p>Has mechanical length labeled on side or recessed area.</p>	<p>Straight Section (5 cm)</p>  <p>Used as port 1 and 2</p> <p>3/32 inch Hex Ball Driver</p> 
<p>Flush Short</p> 	 <p>Slip Pin (2.367 mm diameter)</p>  <p>Slip Pin (1.645 mm diameter)</p>  <p>4-40 Socket Head Screw</p>  <p>4-40 Captive Screw</p>  <p>4-40 Captive Screw</p> <p>Note: Short pins used on calibration devices, long pins used on DUTs.</p>

wx418a

Table 7-3 **Replaceable Parts for the U11644A WR-19**

Description	Qty Per Kit	Keysight Part Number
Calibration Devices		
Straight section (5 cm)	2	11644-60018
Standard section (10 cm)	1	11644-60003
Waveguide load	1	11644-60006
Shim	1	11644-20002
Short	1	11644-20004
Hardware		
Slip pin (1.645 mm diameter)	6	11644-20008
Slip pin (2.367 mm diameter)	6	11644-20006
4-40 captive screw (0.31 inches long)	24	1390-0671
4-40 captive screw (0.43 inches long)	12	1390-0764
4-40 SKT HD screw (0.50 inches long)	12	3030-0209
Hex ball driver	1	8710-0523
Miscellaneous Items		
User's and service guide	1	11644-90369
Calibration Kit Storage Case		
Storage case	1	5181-5517
Box	2	1540-0034
Foam pad (set)	1	11644-80041

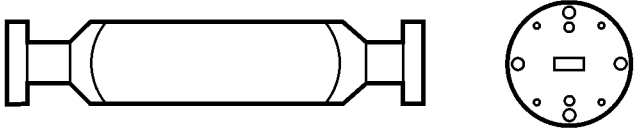
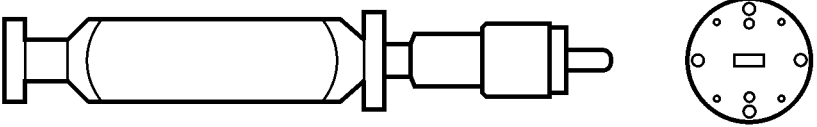
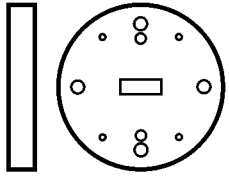
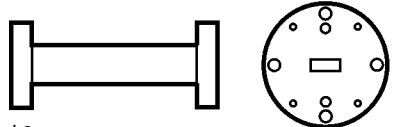
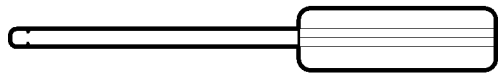
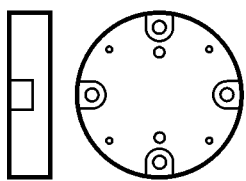
Figure 7-3 U-Band Component Identification Sheet

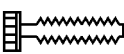
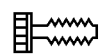
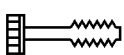



<p>Standard Section (10 cm)</p> <p>Used for system verification only.</p> 	
<p>Waveguide Load</p> 	
<p>Wavelength Section</p>  <p>Has mechanical length labeled on side or recessed area.</p>	<p>Straight Section (5 cm)</p>  <p>Used as port 1 and 2</p> <p>3/32 inch Hex Ball Driver</p> 
<p>Flush Short</p> 	 <p>Slip Pin (2.367 mm diameter)</p>  <p>Slip Pin (1.645 mm diameter)</p>  <p>4-40 Socket Head Screw</p>  <p>4-40 Captive Screw</p>  <p>4-40 Captive Screw</p> <p>Note: Short pins used on calibration devices, long pins used on DUTs.</p>

wx418a

Table 7-4 **Replaceable Parts for the V11644A WR-15**

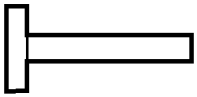
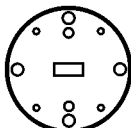
Description	Qty Per Kit	Keysight Part Number
Calibration Devices		
Fixed load	1	11643-60025
Standard section (5 cm)	3	11644-60012
Shim	1	11644-20013
Short	1	11644-20015
Hardware		
Slip pin (1.567 mm diameter)	6	11644-20007
4-40 captive screw (0.41 inch)	12	1390-0765
4-40 captive screw (0.31 inch)	24	1390-0671
Hex ball driver	1	8710-0523
Miscellaneous Items		
User's and service guide	1	11644-90369
Calibration Kit Storage Case		
Storage case	1	5181-5517
Box	2	1540-0034
Foam pad (set)	1	11644-80042

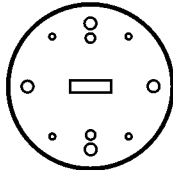
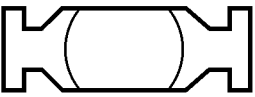
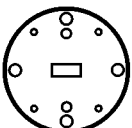
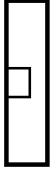
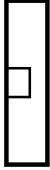
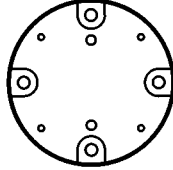
Figure 7-4 V-Band Component Identification Sheet

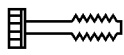

<p>Fixed Load</p>  		
<p>Shim</p>   <p>Has mechanical length labeled on side or recessed area.</p>	<p>Standard Section (5 cm)</p>   <ul style="list-style-type: none"> • Used for system verification only (1) • Used as port 1 and 2 (2) 	
	<p>3/32 inch Hex Ball Driver</p> 	
<p>Flush Short</p>  	<p>Slip Pin (1.567 mm diameter)</p>  <p>4-40 Captive Screw</p>  <p>4-40 Captive Screw</p> 	<p>Note: Short pins used on calibration devices, long pins used on DUTs.</p>

wx419a

Table 7-5 **Replaceable Parts for the W11644A WR-10**

Description	Qty Per Kit	Keysight Part Number
Calibration Devices		
Fixed load	1	11643-60026
Standard section	3	11644-60013
Shim	1	11644-20014
Short	1	11644-20015
Hardware		
Slip pin (1.567 mm diameter)	6	11644-20007
4-40 captive screw (0.41 inch)	12	1390-0765
4-40 captive screw (0.31 inch)	24	1390-0671
Hex ball driver	1	8710-0523
Miscellaneous Items		
User's and service guide	1	11644-90369
Calibration Kit Storage Case		
Storage case	1	5181-5517
Box	2	1540-0034
Foam pad (set)	1	11644-80042

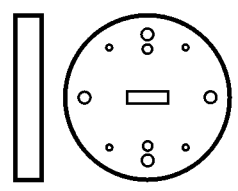
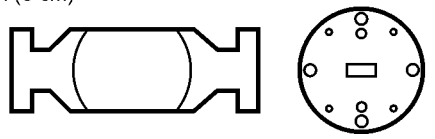
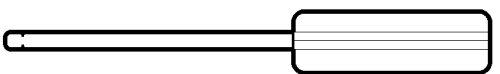
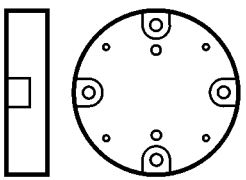
Figure 7-5 W-Band Component Identification Sheet

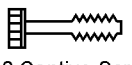
<p>Fixed Load</p> 		
<p>Shim</p>  <p>Has mechanical length labeled on side or recessed area.</p>	<p>Standard Section (5 cm)</p>  <ul style="list-style-type: none"> • Used for system verification only (1) • Used as port 1 and 2 (2) 	
	<p>3/32 inch Hex Ball Driver</p> 	
<p>Flush Short</p> 	<p>Slip Pin (1.567 mm diameter)</p>  <p>4-40 Captive Screw</p>  <p>4-40 Captive Screw</p> 	<p>Note: Short pins used on calibration devices, long pins used on DUTs.</p>

wx419a

Table 7-6 **Items Not Included in the Calibration Kit**

Description	Qty	Keysight Part Number
ESD Protection Devices		
Grounding wrist strap	1	9300-1367
5 ft grounding cord for wrist strap	1	9300-0980
2 ft by 4 ft conductive table mat with 15 ft grounding wire	1	9300-0797
ESD heel strap	1	9300-1308
Cleaning Supplies		
Anhydrous isopropyl alcohol (>92% pure) ^a	--	--
Foam-tipped cleaning swabs	100	9301-1243

a. Keysight can no longer safely ship isopropyl alcohol, so customers should purchase it locally.

Replaceable Parts
Introduction

A: Standard Definitions

Class Assignments and Standard Definitions Values are Available on the Web

Class assignments and standard definitions may change as more accurate model and calibration methods are developed. You can download the most accurate class assignments and standard definitions from Keysight's Calibration Kit Definitions Web page at

<https://www.keysight.com/us/en/assets/9922-01521/technical-specifications/Calibration-Kit-Definitions.pdf>.

For a detailed discussion of calibration kits, refer to the Keysight Application Note, "Specifying Calibration Standards and Kits for Keysight Vector Network Analyzers." This application note covers calibration standard definitions, calibration kit content and its structure requirements for Keysight vector network analyzers. It also provides some examples of how to set up a new calibration kit and how to modify an existing calibration kit definition file. To download a free copy, go to www.keysight.com and enter literature number 5989-4840EN in the Search window.

Standard Definitions

Class Assignments and Standard Definitions Values are Available on the Web

- Symbols
- ¼ wavelength shims, 2-4
- Numerics
- A
- alcohol
 - isopropyl
 - precautions for use of, 4-4
- aligning
 - non-precision and precision flanges, 4-7
 - precision flanges, 4-6
- altitude, specifications, 2-2
- assistance
 - contacting keysight, 6-5
- B
- box, part number, 7-4, 7-6, 7-8, 7-10, 7-12
- C
- cal kit
 - contents, 1-2
 - overview, 1-2
 - verifying, 5-2
- calibration
 - bad, 6-2
 - certificate of, 5-3
 - constants, See calibration definitions
 - definitions
 - part number, 7-12
 - devices, 3-2
 - frequency, 1-6
 - kits, intended use, 1-3
 - report, 5-3
 - standards, 5-2
 - sticker, 5-3
 - temperature, 2-2
 - when to perform, 1-6
 - calibration applications, 3-3
 - 1/4 load, 3-4
 - 1/4 short, 3-5
 - isolation, 3-3
 - line, 3-3
 - load, 3-4
 - offset load, 3-4
 - offset short, 3-5
 - reflect, 3-5
 - short, 3-5
 - thru, 3-6
 - calibration definition, wavelength shim, 3-7
 - calibration definitions, 1-2
 - entering, 1-2
 - calibration kit
 - Keysight Application Note, A-2
 - contents, 1-2
 - drawing of, 7-5, 7-7, 7-9, 7-11, 7-13
 - modifying definition files, A-2
 - overview, 1-2
 - parts not included, 7-14
 - performance
 - how Keysight verifies, 5-2
 - case, storage, 7-4, 7-6, 7-8, 7-10, 7-12
 - certificate of calibration, 5-3
 - certification, device specifications, 2-5
 - characteristics
 - mechanical, 2-3
 - class assignments
 - downloading from Keysight Web site, A-2
 - cleaning
 - connectors, 4-3
 - mating plane surfaces, 4-4
 - supplies, 1-3
 - part number, 7-14
 - component identification sheets
 - Q and U-band, 7-7, 7-9
 - R-band, 7-5
 - V and W-band, 7-11, 7-13
 - compressed air
 - for cleaning, 4-3
 - conductive table mat, part number, 7-14
 - connecting
 - flanges, 4-5, 4-8
 - for ESD protection, 4-2, 7-14
 - waveguides, 4-5
 - connections, 4-5
 - connector
 - cleaning, 4-3
 - mating plane surfaces, 4-4
 - constants
 - part numbers, 7-4, 7-8, 7-12
 - constants, calibration, See calibration definitions
 - contacting Keysight Technologies, 6-5
 - contents
 - calibration kit, 1-2
 - drawing of, 7-5, 7-7, 7-9, 7-11, 7-13
 - incomplete, 1-3
 - D
 - damage
 - caused by electrostatic discharge, 4-2
 - data, recertification, 5-3
 - definitions
 - calibration, 1-2, 3-7
 - entering, 1-2
 - permanently stored, 1-2
 - device
 - calibration, 3-2
 - cleaning, 4-3
 - connecting, 4-5
 - handling, 4-9
 - maintenance, 1-5
 - performance, verifying, 5-2
 - specifications
 - certification of, 2-5
 - electrical, 2-4

- traceability, 5-2, 5-3
 - storage, 4-9
 - temperature, 2-2
 - visual inspection, 4-3
- documentation warranty, -ii
- documented kits, 1-3
- downloading class assignments & std definitions from the Web, A-2
- E
- electrical
 - characteristics
 - effects of temperature, 2-2
 - specifications of shims, 2-4
 - specifications of standard sections, 2-4
 - specifications of terminations, 2-4
- electrostatic discharge, *See* ESD
- environmental
 - regulations, 4-4
 - requirements, 2-2
 - specifications, 2-2
- equipment required, 1-3
- ESD, 4-2
 - protection, 4-2
 - supplies, part number, 7-14
- F
- flange, connect, 4-8
- flowchart, troubleshooting, 6-2
- frequency of calibration, 1-6
- frequency specification, 2-4
- G
- general information, 1-1
- grounding cord, part number, 7-14
- H
- handling, 4-9
- heel strap, part number, 7-14
- history, serial numbers, 1-3
- how often to calibrate, 1-6
- humidity specifications, 2-2
- I
- incoming inspection, 1-3
- inspection
 - flange connection, 4-8
 - incoming, 1-3
 - visual, 4-3
- isolation, 3-3
- isopropyl alcohol
 - precautions for use of, 4-4
- K
- Keysight Technologies
 - application note, A-2
 - contacting, 6-5
- kit
 - contents, 1-2, 7-4, 7-8, 7-12
 - drawing of, 7-5, 7-7, 7-9, 7-11, 7-13
 - overview, 1-2
 - performance
 - failure, 6-2
 - verification, 5-2
- L
- line, 3-3
- load, 3-4
- load, part numbers, 7-4
- M
- maintenance
 - of devices, 1-5
 - preventive, 1-5
- manual
 - part number, 7-4, 7-8, 7-12
 - printing copies, -ii
- mat
 - conductive
 - part number, 7-14
 - for ESD protection, 4-2
- mating plane surfaces
 - cleaning, 4-4
 - connector, 4-4
- measurement uncertainty, 2-5
- mechanical characteristics, 2-3
- modifying calibration kit
 - definition files, A-2
- N
- National Institute of Standards and Technology (NIST), 2-5, 5-2
- network analyzer, 8510, 1-2
- nitrogen, for cleaning, 4-3
- non-precision flanges, aligning, 4-7
- numbers
 - replaceable parts, 7-3, 7-4, 7-8, 7-12, 7-14
 - serial, 1-4
- O
- offset load, 3-4
- offset short, 3-5
- ordering, parts, 7-3, 7-14
- oxygen, 4-3
- P
- part numbers, 7-3
 - included in kit, 7-4, 7-12
 - not included in kit, 7-8
 - of items not in kit, 7-14
- performance
 - verification, 5-2, 6-2
- performance test, 5-4, 5-5

- port 1 and 2, 3-2
- precision flanges, 4-5, 4-6, 4-7
- preventive maintenance, 1-5
- procedures
 - aligning flanges, 4-6
 - cleaning, 4-3
 - tightening flanges, 4-8
- Q
- quarter-wave shims, 2-3, 2-4
- R
- recertification
 - how often, 5-3
 - services included, 5-3
- record serial number, 1-4
- reflect, 3-5
- regulations
 - environmental, 2-2, 4-4
- replaceable parts, 7-3, 7-14
 - drawing of, 7-5, 7-7, 7-9, 7-11, 7-13
- Q11644A WR-22, 7-8
- R11644A WR-28, 7-4
- U11644A WR-19, 7-8
- V11644A WR-15, 7-12
- report, calibration, 5-3
- required equipment, 1-3
- requirements, environmental, 2-2
- return kit or device to Keysight, 1-3, 6-4
- return loss specification, 2-4
 - shims, 2-4
 - standard sections, 2-4
 - terminations, 2-4
- S
- serial numbers, 1-4
 - devices, 1-4
 - history, 1-3
 - recording, 1-4
- service, 6-4
- service tag, 5-3, 6-4
- shims
 - mechanical characteristics, 2-3
 - using, 3-2
- shims, electrical
 - specifications, 2-4
- short, 3-5
 - part numbers, 7-4, 7-6, 7-8, 7-10, 7-12
- shorts, mechanical
 - characteristics, 2-3
- specifications, 2-2
 - altitude
 - operating, 2-2
 - storage, 2-2
 - certification of, 2-5
 - characteristics, 2-4
 - deviation from nominal phase, 2-4
 - device, 2-4
 - electrical, 2-4
 - environmental, 2-2
 - frequency, 2-4
 - operating, 2-2
 - return loss of shims, 2-4
 - return loss of standard sections, 2-4
 - return loss of terminations, 2-4
 - storage, 2-2
 - temperature, 2-2
 - traceability, 5-2, 5-3
- standard definitions
 - downloading from Keysight Web site, A-2
- standard section, 3-2
- standards
 - international, 2-5
 - National Institute of Standards and Technology (NIST), 2-5, 5-2
- static electricity, 4-2
- storage, 4-9
- storage case, part number, 7-4, 7-6, 7-8, 7-10, 7-12
- strap
 - heel and wrist, part number, 7-14
- supplies
 - cleaning, 1-3
 - part number, 7-14
- T
- table mat
 - for ESD protection, 4-2
 - part number, 7-14
- tag, service, 5-3, 6-4
- temperature
 - affect on electrical performance, 2-2
 - cautions about, 2-2
 - environmental requirements, 2-2
 - error-corrected, 2-2
 - measurement, 2-2
 - specifications, 2-2
 - verification and measurement, 2-2
- termination, 3-2
- test data, 5-3
- test, performance, 5-4, 5-5
- thru, 3-6
- traceability
 - of device specifications, 5-2, 5-3
- troubleshooting, flowchart, 6-2
- U
- uncertainty, measurement, 2-5
- user's and service guide
 - part number, 7-6, 7-8, 7-10, 7-12
- V
- verification
 - device, 5-2
 - performance, 5-3
 - temperature, 2-2
- visual inspection, 4-3

W

- warranty, documentation, -ii
- waveguide straight
 - port 1 and 2, 3-2
 - verification device, 3-2
- waveguide, connecting, 4-5
- wavelength shim, 3-2
- wavelength shim, calibration
 - definition, 3-7
- when to calibrate, 1-6
- wrist strap
 - for ESD protection, 4-2
 - part number, 7-14



This information is subject to change without notice.

© Keysight Technologies 1994-2022

Edition 2, May 2022



11644-90369

www.keysight.com