

# MPI Probe Selection Guide

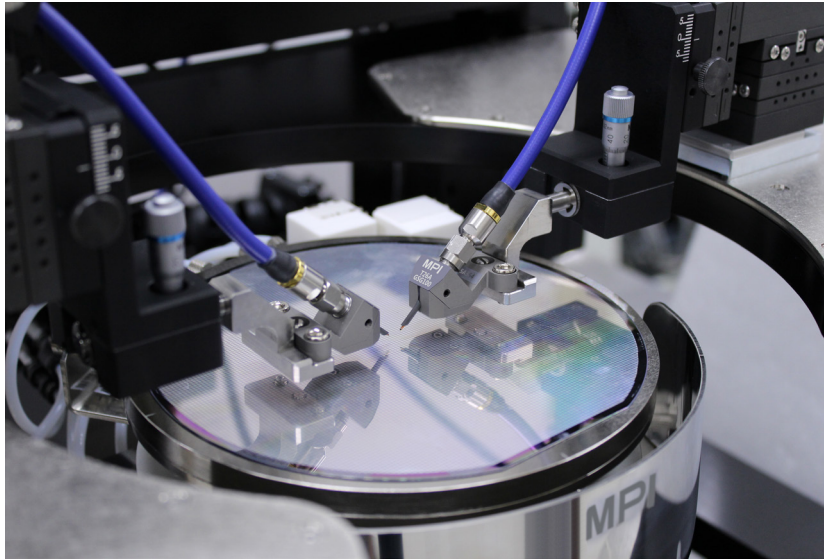

With a critical understanding of the numerous measurement challenges associated with today's RF applications, MPI Corporation has developed TITAN™ RF Probes, a product series specifically optimized for these complex applications centered upon the requirements of advanced RF customers.

TITAN™ Probes provide the latest in technology and manufacturing advancements within the field of RF testing. They are derived from the technology transfer that accompanied the acquisition of Allstron, then significantly enhanced by MPI's highly experienced RF testing team and subsequently produced utilizing MPI's world class MEMS technology. Precisely manufactured, the TITAN™ Probes include matched 50 Ohm MEMS contact tips with improved probe electrical characteristics which allow the realization of unmatched calibration results over a wide frequency range. The patented protrusion tip design enables small passivation window bond pad probing, while significantly reducing probe skate thus providing the outstanding contact repeatability required in today's extreme measurement environments. TITAN™ Probes with all their features are accompanied by a truly affordable price.

The TITAN™ Probe series are available in single-ended and dual tip configurations, with pitch range from 50 micron to 1250 micron and frequencies from 26 GHz to 110 GHz. TITAN™ RF Probes are the ideal choice for on-wafer S-parameter measurements of RF, mm-wave devices and circuits up to 110 GHz as well as for the characterization of RF power devices requiring up to 10 Watts of continuous power. Finally, customers can benefit from both long product life and unbeatable cost of ownership which they have desired for years.

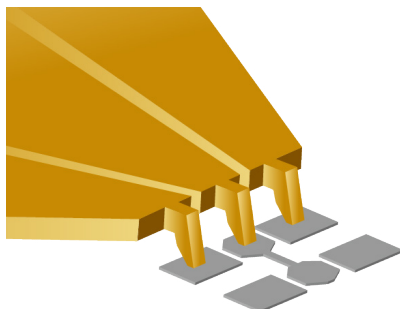

Unique design of the MEMS coplanar contact tip of the TITAN™ probe series.

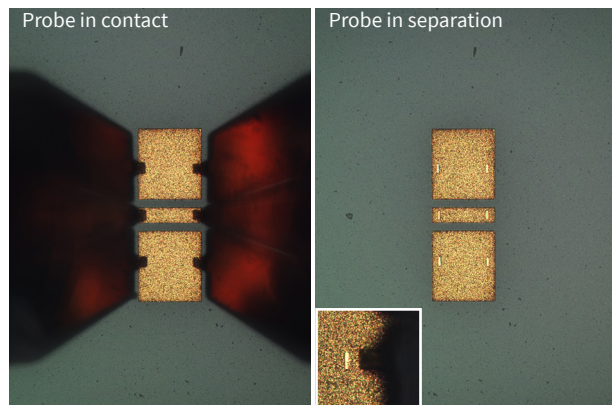

DC-needle-alike visibility of the contact point and the minimal pad damage due to the unique design of the tip

CROSSTALK

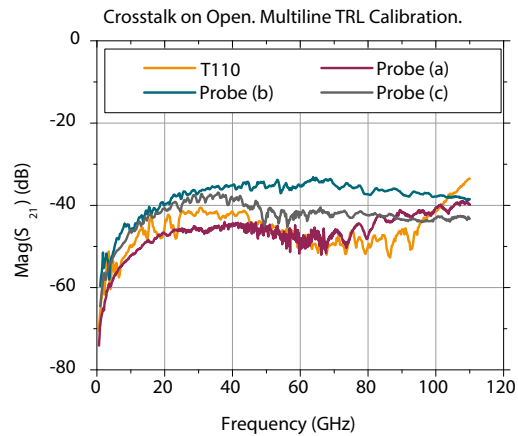
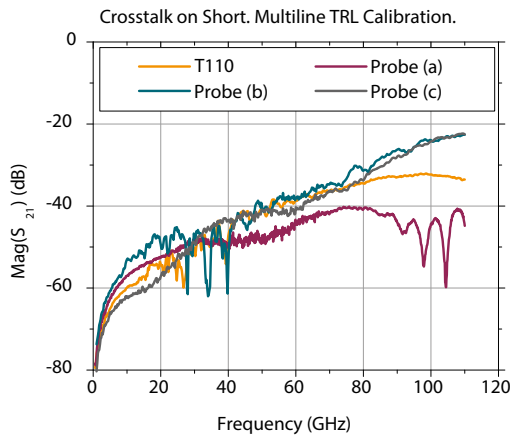

Crosstalk of TITAN™ probes on the short and the bare ceramic open standard of 150 micron spacing compared to conventional 110 GHz probe technologies. Results are corrected by the multiline TRL calibration. All probes are of GSG configuration and 100 micron pitch.

MECHANICAL CHARACTERISTICS

Another advantage of the TITAN™ probe is its superior contact repeatability, which is comparable with the entire system trace noise when measured on the semi-automated system and on gold contact pads.

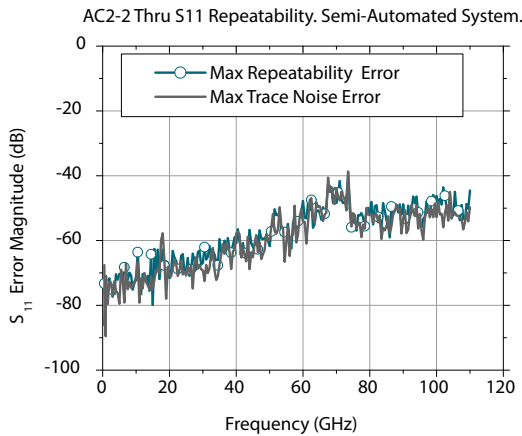

The maximal probe contact repeatability error of the calibrate S<sub>11</sub>-parameter of the AC2-2 thru standard by T110 probes. Semi-automated system. Ten contact circles.

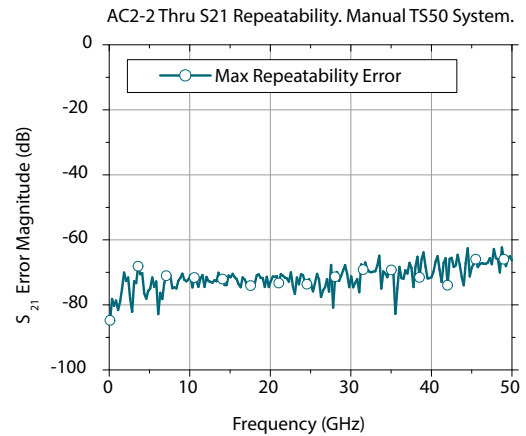

The maximal probe contact repeatability error of the calibrate S<sub>21</sub>-parameter of the AC2-2 thru standard by T50 probes. Manual probe system TS50.

Mechanical Characteristics

Cantilever needle material	Ni alloy
Body material	Al alloy
Contact pressure @2 mils overtravel	20 g
Lifetime, touchdowns	> 1,000,000
Ground and signal alignment error <sup>[1]</sup>	± 3 μm <sup>[1]</sup>
Planarity error <sup>[1]</sup>	± 3 μm <sup>[1]</sup>
Contact footprint width	< 30 μm
Contact resistance on Au	< 3 mΩ
Thermal range	-60 to 175 °C

26 GHZ PROBES FOR WIRELESS APPLICATIONS

Understanding customer needs to reduce the cost of development and product testing for the high competitive wireless application market, MPI offers low-cost yet high-performance RF probes. The specifically developed SMA connector and its outstanding transmission of electro-magnetic waves through the probe design make these probes suitable for applications frequencies up to 26 GHz. The available pitch range is from 50 micron to 1250 micron with GS/SG and GSG probe tip configurations.

TITAN™ 26 GHz probes are the ideal choice for measurement needs when developing components for WiFi, Bluetooth, and 3G/4G commercial wireless applications as well as for student education.

26 GHz Probe Model: T26

Typical Electrical Characteristics

Characteristic Impedance	50 Ω
Frequency range	DC to 26 GHz
Insertion loss (GSG configuration) <sup>1</sup>	< 0.4 dB
Return loss (GSG configuration) <sup>1</sup>	> 16 dB
DC current	≤ 1 A
DC voltage	≤ 100 V
RF power, @10 GHz	≤ 5 W



T26 probe, A-Style of the connector

Mechanical Characteristics

Connector	SMA
Pitch range	50 μm to 1250 μm
Standard pitch step	
from 50 μm to 450 μm	25 μm step
from 500 μm to 1250 μm	50 μm step
	Available for 90 μm pitch
Tip configurations	GSG, GS, SG
Connector angle	V-Style: 90-degree A-Style: 45-degree

Typical Electrical Characteristics: 26 GHz GSG probe, 250 micron pitch

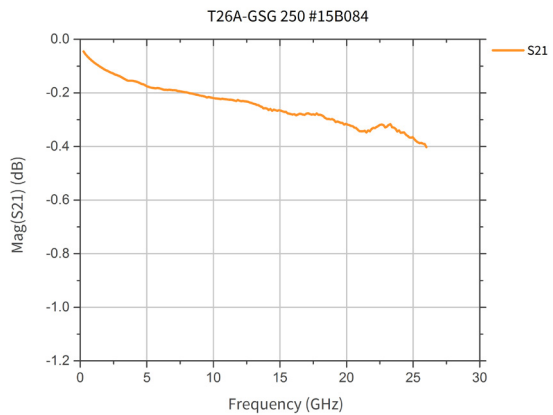
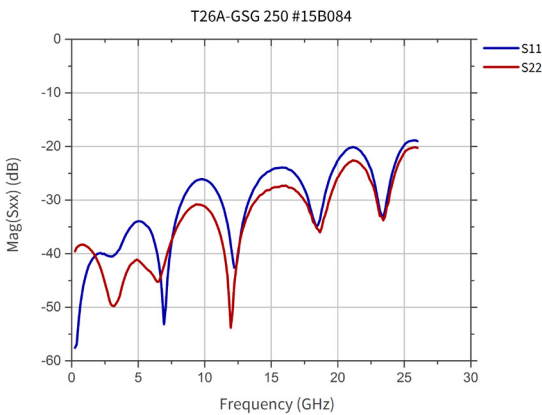

26 GHz PROBES FOR RF POWER APPLICATIONS

MPI offers the high power version of TITAN™ 26 GHz RF probes for commercial wireless applications. The T26P probe model enables RF testing with up to 10 W of power which is two times more compared to what the standard probe family can achieve. T26P offers low testing costs for the development of power RF devices and front-end MMICs for C-band, X-band and Ku-band applications.

26 GHz Probe Model: T26P

Typical Electrical Characteristics

Characteristic Impedance	50 Ω
Frequency range	DC to 26 GHz
Insertion loss (GSG configuration) <sup>1</sup>	< 0.4 dB
Return loss (GSG configuration) <sup>1</sup>	> 16 dB
DC current	≤ 2 A
DC voltage	≤ 250 V
RF power, @10 GHz	≤ 10 W
Thermal range	-60 to 200 °C



T26P probe, A-Style of the connector

Mechanical Characteristics

Connector	SMA
Pitch range	50 to 375 μm, 25 μm step Available for 90 μm pitch
Standard pitch step	25 μm
Tip configurations	GSG
Connector angle	A-Style: 45-degree V-Style: 90-degree

Typical Electrical Characteristics: 26 GHz GSG probe, 125 micron pitch

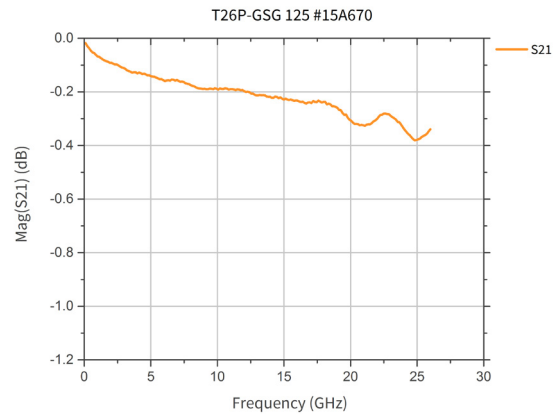
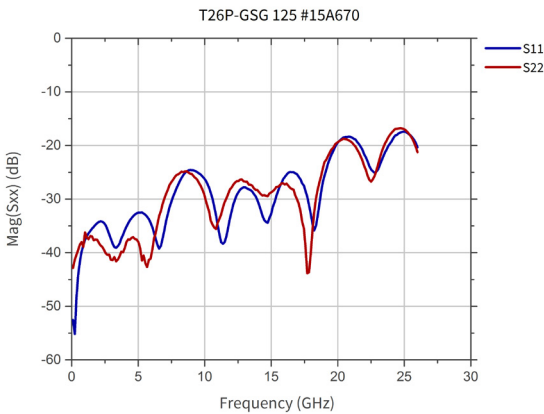

PROBES FOR DEVICE AND IC CHARACTERIZATION UP TO 110 GHZ

TITAN™ probes realize a unique combination of the micro-coaxial cable based probe technology and MEMS fabricated probe tip. A perfectly matched characteristic impedance of the coplanar probe tips and optimized signal transmission across the entire probe down to the pads of the device under test (DUT) result in excellent probe electrical characteristics. At the same time, the unique design of the probe tip provides minimal probe forward skate on any type of pad metallization material, therefore achieving accurate and repeatable measurement up to 110 GHz. TITAN™ probes are suitable for probing on small pads with long probe lifetime and low cost of ownership.

The TITAN™ probe family contains dual probes for engineering and design debug of RF and mm-wave IC's as well as high-end mm-wave range probes for S-parameter characterization up to 110 GHz for modeling of high-performance microwave devices.

40 GHz Probe Model: T40

Typical Electrical Characteristics

Characteristic Impedance	50 Ω
Frequency range	DC to 40 GHz
Insertion loss (GSG configuration) <sup>1</sup>	< 0.6 dB
Return loss (GSG configuration) <sup>1</sup>	> 18 dB
DC current	≤ 1 A
DC voltage	≤ 100 V
RF power, @10 GHz	≤ 5 W



T40 probe, A-Style of the connector

Mechanical Characteristics

Connector	K (2.92 mm)
Pitch range	50 μm to 500 μm
Standard pitch step	
<b>For GSG configuration:</b>	
from 50 μm to 450 μm	25 μm step
from 500 μm to 800 μm	50 μm step
	Available for 90 μm pitch
<b>For GS/SG configuration:</b>	
from 50 μm to 450 μm	25 μm step
	Available for 90/500 μm pitch
Tip configurations	GSG, GS, SG
Connector angle	V-Style: 90-degree A-Style: 45-degree

Typical Electrical Characteristics: 40 GHz GSG probe, 150 micron pitch

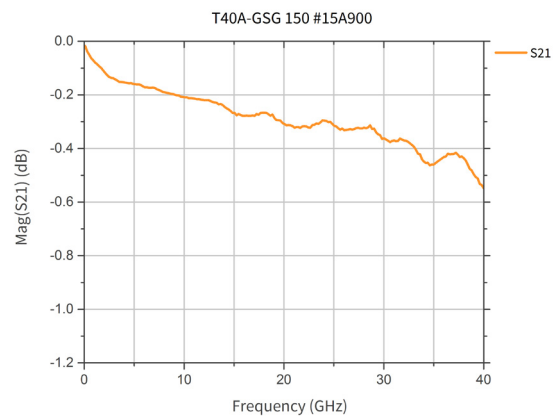
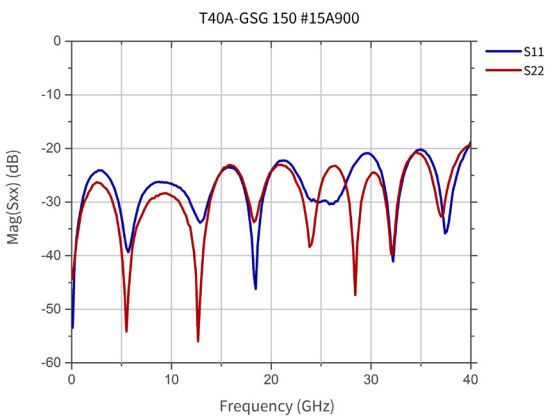

### 50 GHz Probe Model: T50

#### Typical Electrical Characteristics

Characteristic Impedance	50 Ω
Frequency range	DC to 50 GHz
Insertion loss (GSG configuration) <sup>1</sup>	< 0.6 dB
Return loss (GSG configuration) <sup>1</sup>	> 17 dB
DC current	≤ 1 A
DC voltage	≤ 100 V
RF power, @10 GHz	≤ 5 W



T50 probe, A-Style of the connector

#### Mechanical Characteristics

Connector	Q (2.4 mm)
Pitch range	50 μm to 250 μm
Standard pitch step	
<b>For GSG configuration:</b>	
from 50 μm to 450 μm	25 μm step Available for 90/500/550 μm pitch
<b>For GS/SG configuration:</b>	
from 50 μm to 450 μm	25 μm step Available for 90/500 μm pitch
Tip configurations	GSG, GS, SG
Connector angle	V-Style: 90-degree A-Style: 45-degree

#### Typical Electrical Characteristics: 50 GHz GSG probe, 150 micron pitch

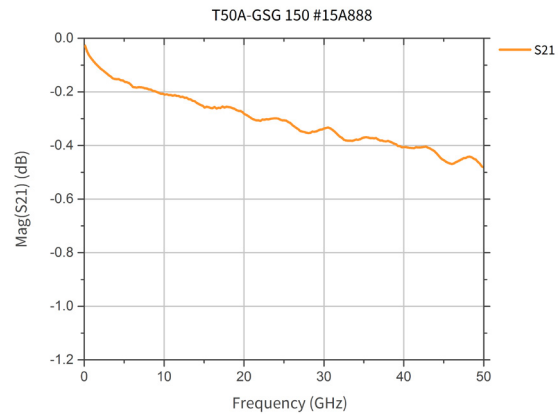
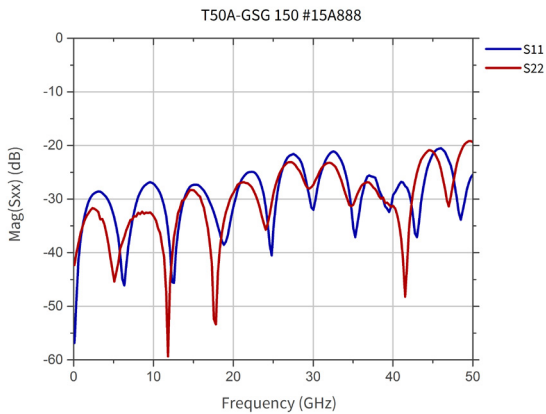



### 67 GHz Probe Model: T67

#### Typical Electrical Characteristics

Characteristic Impedance	50 Ω
Frequency range	DC to 67 GHz
Insertion loss (GSG configuration) <sup>1</sup>	< 0.8 dB
Return loss (GSG configuration) <sup>1</sup>	> 16 dB
DC current	≤ 1 A
DC voltage	≤ 100 V
RF power, @10 GHz	≤ 5 W



T67 probe, A-Style of the connector

#### Mechanical Characteristics

Connector	V (1.85 mm)
Pitch range	50 μm to 250 μm
Standard pitch step	
<b>For GSG configuration:</b>	
from 50 μm to 400 μm	25 μm step Available for 90 μm pitch
<b>For GS/SG configuration:</b>	
from 50 μm to 250 μm	25 μm step Available for 90 μm pitch
Tip configurations	GSG
Connector angle	V-Style: 90-degree A-Style: 45-degree

#### Typical Electrical Characteristics: 67 GHz GSG probe, 100 micron pitch

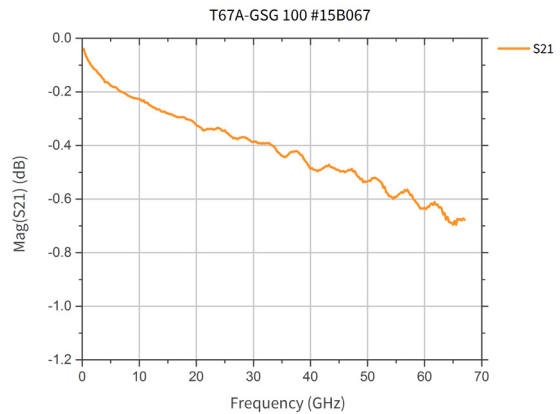
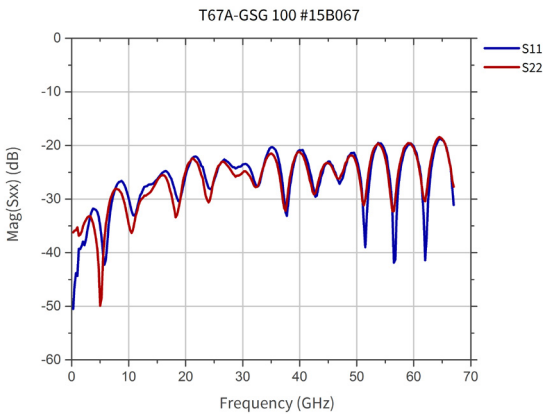

### 110 GHz Probe Model: T110

#### Typical Electrical Characteristics

Characteristic Impedance	50 Ω
Frequency range	DC to 110 GHz
Insertion loss (GSG configuration) <sup>1</sup>	< 1.2 dB
Return loss (GSG configuration) <sup>1</sup>	> 14 dB
DC current	≤ 1 A
DC voltage	≤ 100 V
RF power, @10 GHz	≤ 5 W



T110 probe, A-Style of the connector

#### Mechanical Characteristics

Connector	A (1 mm)
Pitch range	50 μm to 250 μm
Standard pitch step	25 μm
Tip configurations	GSG
Connector angle	A-Style: 45-degree

#### Typical Electrical Characteristics: 110 GHz GSG probe, 100 micron pitch

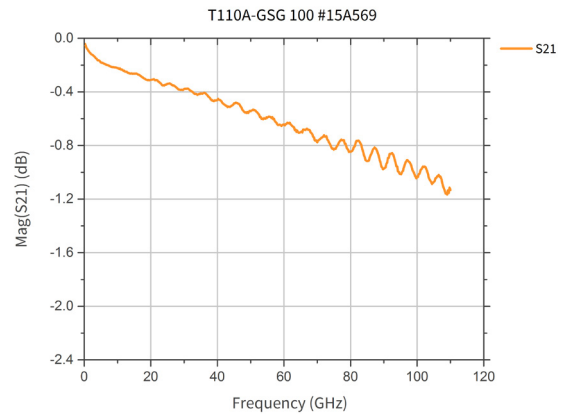
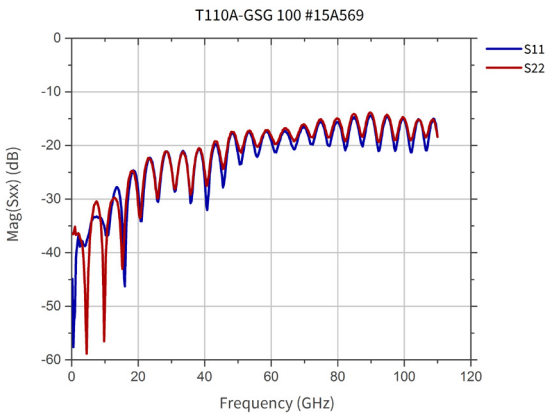



## 220 GHz Probe Model: T220

### Typical Electrical Characteristics

Characteristic impedance	50 $\Omega$
Frequency range	DC to 220 GHz
Insertion loss (GSG configuration) <sup>1</sup>	< 5 dB
Connector end return loss (GSG configuration) <sup>1</sup>	> 9 dB
Tip end return loss (GSG configuration) <sup>1</sup>	> 13 dB
DC current	$\leq 1.5$ A
DC voltage	$\leq 50$ V



T220 probe, broadband interface

### Mechanical Characteristics

Connector	Broadband interface
Pitch range	50/75/90/100/125 $\mu\text{m}$
Temperature range	-40 ~ 150 $^{\circ}\text{C}$
Contact width	15 $\mu\text{m}$
quadrant compatible (allowing corner pads)	Yes
recommended pad size	20 $\mu\text{m}$ x 20 $\mu\text{m}$
recommended OT (overtravel)	15 $\mu\text{m}$
contact resistance (on Al at 20 $^{\circ}\text{C}$ using 15 $\mu\text{m}$ OT)	< 45 m $\Omega$
lifetime touchdowns (on Al at 20 $^{\circ}\text{C}$ using 15 $\mu\text{m}$ OT)	> 200,000

### Typical Performance (at 20 $^{\circ}\text{C}$ for 100 $\mu\text{m}$ pitch)

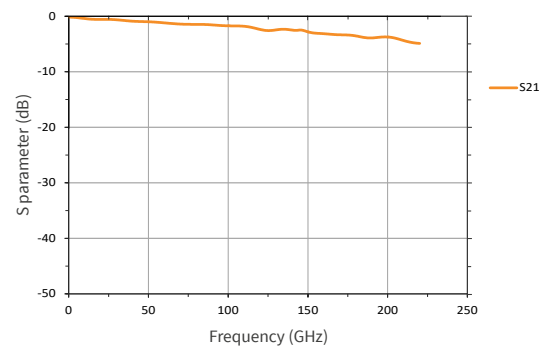
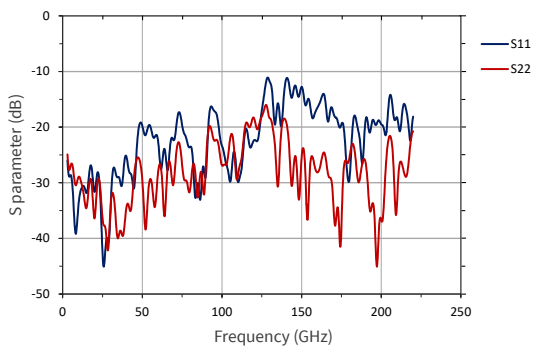

■ BODY DIMENSIONS PROBES

Single-Ended A-Style

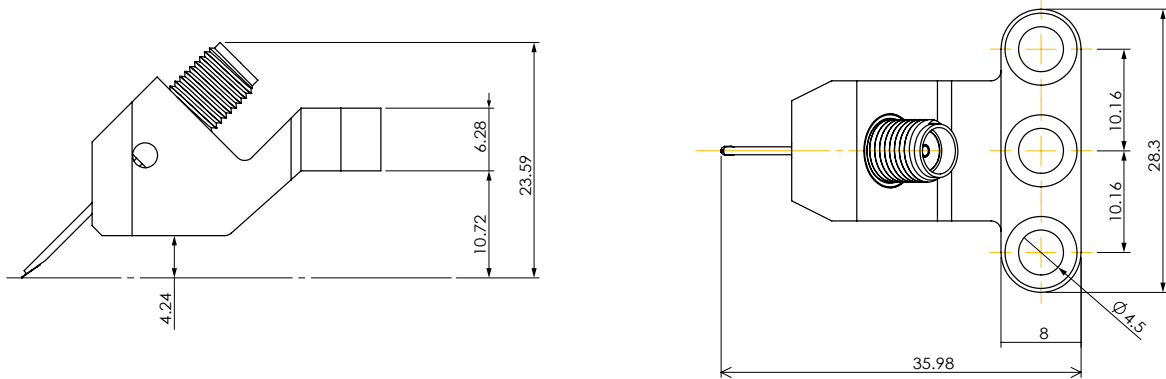

Single-Ended V-Style

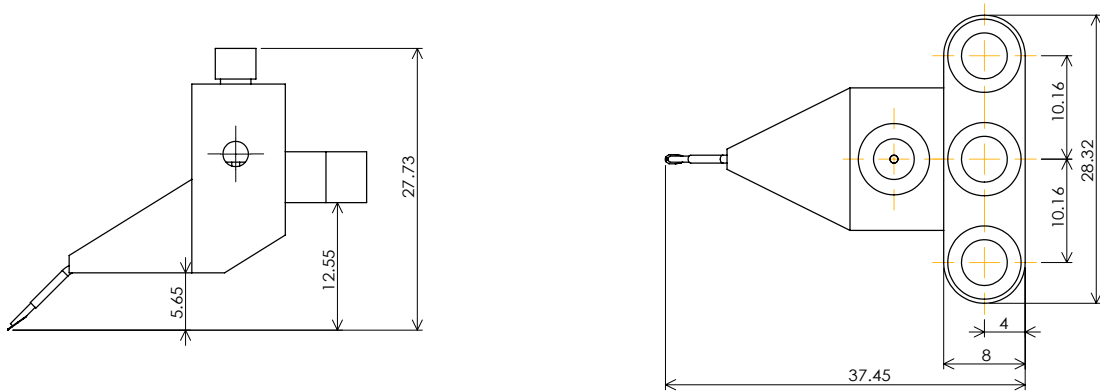

T220 GHz Probe

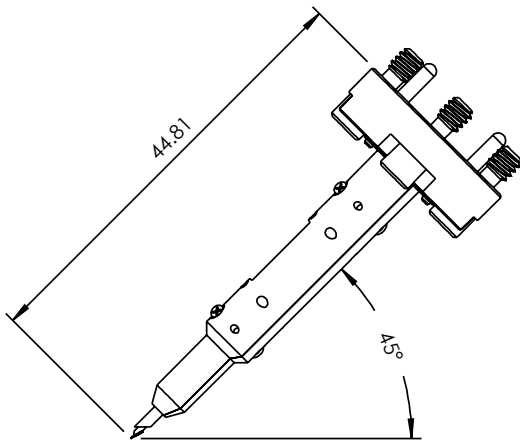

**CALIBRATION SUBSTRATES**

AC-series of calibration standard substrates offers up to 26 standard sets for wafer-level SOLT, LRM probe-tip calibration for GS/SG and GSG probes. Five coplanar lines provide the broadband reference multiline TRL calibration as well as accurate verification of conventional methods. Right-angled reciprocal elements are added to support the SOLR calibration of the system with the right-angled configuration of RF probes. A calibration substrate for wide-pitch probes is also available.

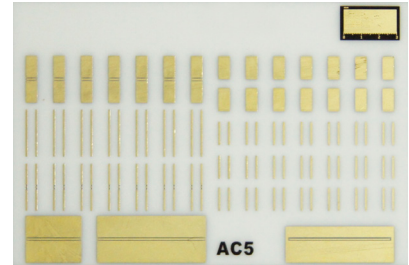
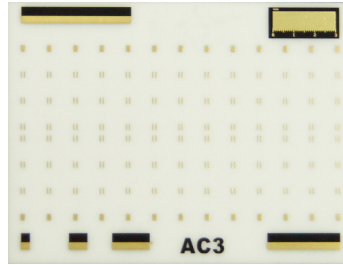
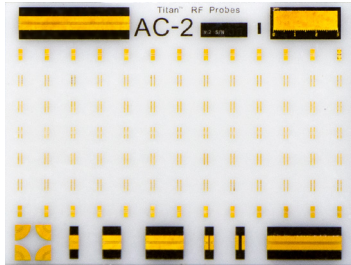

Material	Alumina
Elements design	Coplanar
Supported calibration methods	SOLT, LRM, SOLR, TRL and multiline TRL
Thickness	635 µm
Size	AC2-2 : 16.5 x 12.5 mm AC3 : 16.5 x 12.5 mm AC5 : 22.5 x 15 mm
Effective velocity factor @20 GHz	0.45
Nominal line characteristic impedance @20 GHz	50 Ω
Nominal resistance of the load	50 Ω
Typical load trimming accuracy error	± 0.3 %
Open standard	Au pads on substrate
Calibration verification elements	Yes
Ruler scale	0 to 3 mm
Ruler step size	100 µm

**Calibration substrate AC2-2**

Probe Configuration	GSG
Supported probe pitch	100 to 250 µm
Number of SOLT standard groups	26
Number of verification and calibration lines	5

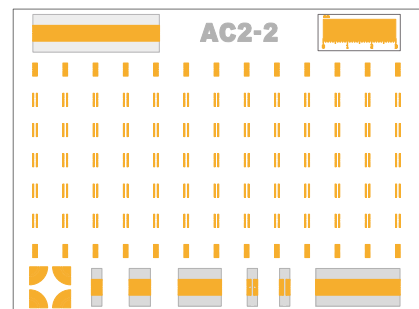

**Calibration substrate AC-3**

Probe Configuration	GS/SG
Supported probe pitch	50 to 250 µm
Number of SOLT standard groups	26
Number of verification and calibration lines	5

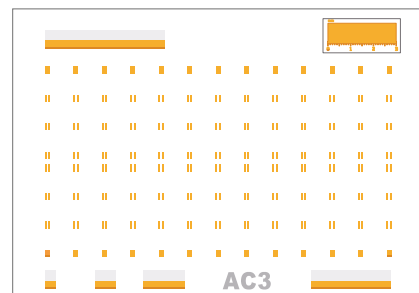

**Calibration substrate AC-5**

Probe Configuration	GSG, GS/SG
Supported probe pitch	250 to 1250 μm
Number of SOLT standard groups	GSG : 7
	GS : 7
	SG : 7
Open standard	On bare ceramic
Number of verification and calibration lines	GSG : 2
	GS : 1

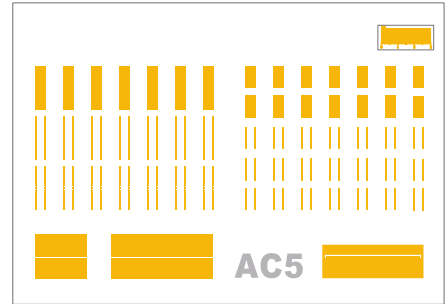

**Typical Electrical Characteristics**

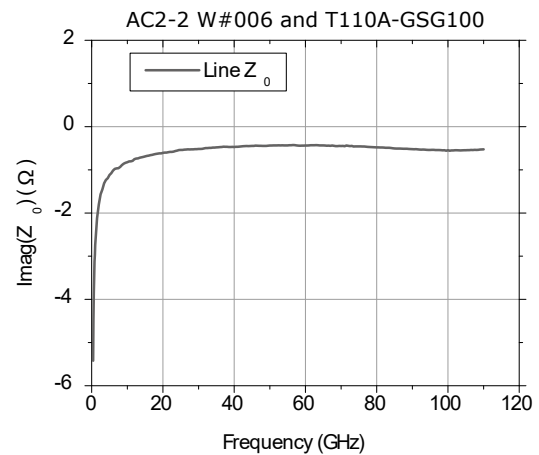
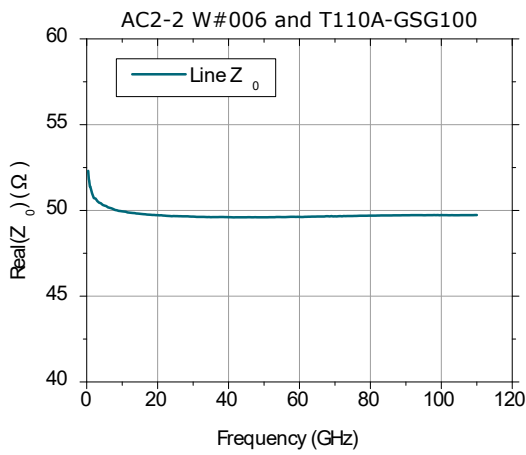
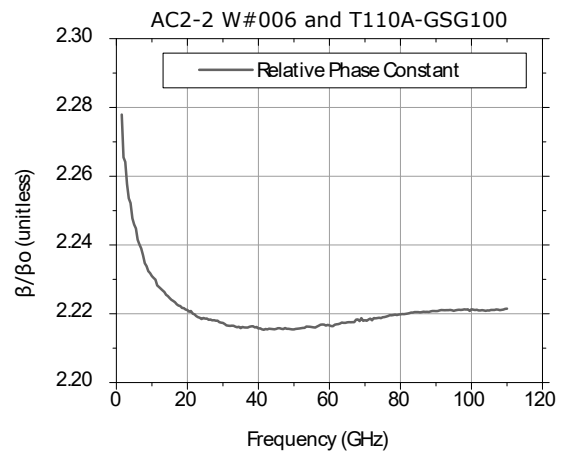
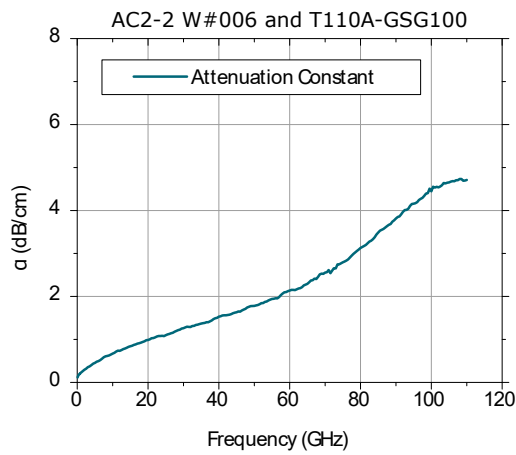

Typical characteristics of the coplanar line standard of AC2-2 calibration substrate measured using T110-GSG100 probes, and methods recommended by the National Institute of Standard and Technologies<sup>[2, 3]</sup>.

## MPI QAlibria® RF CALIBRATION SOFTWARE

MPI QAlibria® RF calibration software has been designed to simplify complex and tedious RF system calibration tasks. By implementing a progressive disclosure methodology and realizing intuitive touch operation, QAlibria® provides crisp and clear guidance to the RF calibration process, minimizing configuration mistakes and helping to obtain accurate calibration results in fastest time. In addition, its concept of multiple GUI's offers full access to all configuration settings and tweaks for advanced users.

QAlibria® offers industry standard and advanced calibration methods. Furthermore, QAlibria® is integrated with the NIST StatistiCal™ calibration packages, ensuring easy access to the NIST multiline TRL metrology-level calibration and uncertainty analysis.

MPI QAlibria® supports a multi-language GUI, eliminating any evitable operation risks and inconvenience.

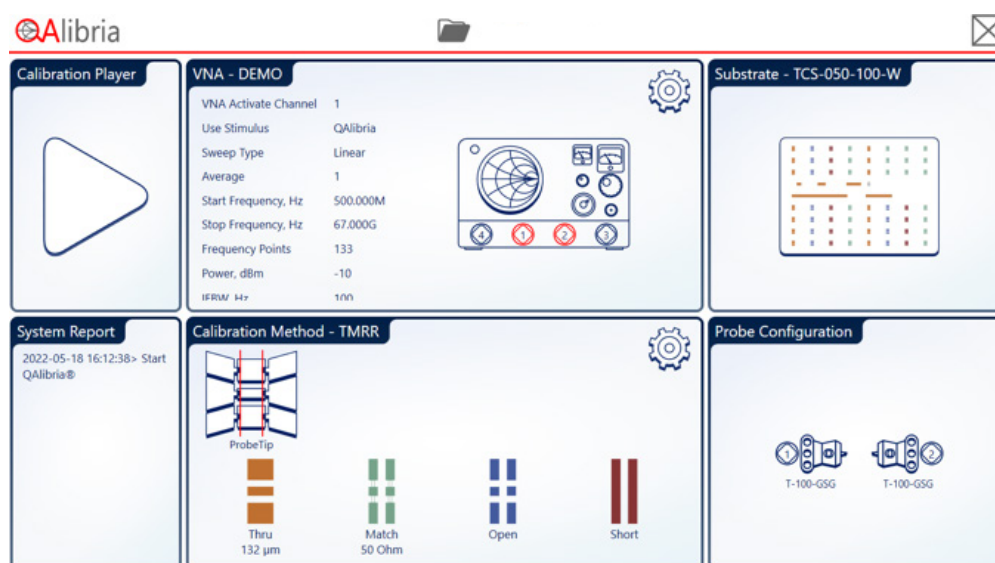

## Specifications

### Supported VNA

#### Rohde & Schwarz

ZV series	ZVA FW 3.12
ZN series	ZNB FW 2.3, ZND FW 2.3, ZNA FW 1.65(1.71)

#### Anritsu

VectorStar series	MS464x FW 2.2.0
ShockLine series	MS4652x FW 3.4.02

#### Keysight

PNA-X series	N5247A FW A.10.40.12, N5242B FW A.15.60.10
PNA series	N5227A FW A.09.80.20, N5227B FW A.12.70.07, E8364B FW A.12.70.07, E8363B FW A.07.50.67, E8361C FW A.08.04.07
PNA-L series	N5232A FW A.10.45.03, N5230C FW A.09.42.22, N5235A FW A.10.40.12
E507xx series	E5071B FW A.09.10, E5071C FW B.12.04
E508xx series	E5080B FW A.13.70.02
PXI series	M9803A

#### Copper Mountain

Cobalt series	C1209 FW 20.3.1, C2420 FW 22.2.2
---------------	----------------------------------

<b>VNA interface</b>	NI VISA ver 5.0 or later, GPIB, TCPIP
<b>Calibration methods</b>	<ul style="list-style-type: none"> <li>• 1-Port SOL (OSM)</li> <li>• 2-Port SOLT (TOSM)</li> <li>• 2-Port NIST multiline TRL (over integration with NIST StatistiCal™ Plus)</li> <li>• 2-Port SOLR</li> <li>• 2-Port TMR (LRM)</li> <li>• 2-Port TMRR</li> <li>• 2-Port TRL</li> <li>• 4-Port SOLT (TOSM)</li> <li>• 4-Port TMR (LRM)</li> <li>• 4-Port TMRR</li> <li>• 4-Port SOLR</li> </ul>
<b>Integration with NIST StatistiCal™ Plus</b>	Online and offline calibration
<b>Computer</b>	
Operation System	Windows 7 / Windows 10 / Windows 11
Processor	Intel Core i3 or better
Memory	2GB or more
Required HDD capacity for QAlibria®	1GB or more
<b>Display</b>	
Recommended resolution and size	1366 X 768, 13”(laptop); 1920 X 1080, 21”(desktop)
Multi touch touchscreen	Recommended
GUI Languages	English, Chinese, Japanese, Russian, German

## RF AND MICROWAVE CABLES

MPI offers an excellent selection of flexible cables and accessories for RF and mm-wave measurement applications for complete RF probe system integration.

### Cables

High-quality cable assemblies with SMA and 3.5 mm connectors provide the best value for money, completing the entry-level RF systems for measurement applications up to 26 GHz. Phase stable high-end flexible cable assemblies with high-precision 2.92, 2.4, 1.85 and 1 mm connectors guarantee high stability, accuracy and repeatability of the calibration and measurement for DC applications up to 110 GHz.

MPI offers these cable assemblies in two standard lengths of 120 and 80 cm, matching the probe system's footprint and the location of the VNA.



### Cables Ordering Information

MRC-18SMA-MF-800	18 GHz SMA flex cable SMA (male) - SMA (female), 80 cm
MRC-18SMA-MF-1200	18 GHz SMA flex cable SMA (male) - SMA (female), 120 cm
MRC-26SMA-MF-800	26 GHz SMA flex cable SMA (male) - SMA (female), 80 cm
MRC-26SMA-MF-1200	26 GHz SMA flex cable SMA (male) - SMA (female), 120 cm
MRC-40K-MF-800	40 GHz flex cable 2.92 mm (K) connector, male-female, 80 cm long
MRC-40K-MF-1200	40 GHz flex cable 2.92 mm (K) connector, male-female, 120 cm long
MRC-50Q-MF-800	50 GHz flex cable 2.4 mm (Q) connector, male-female, 80 cm long
MRC-50Q-MF-1200	50 GHz flex cable 2.4 mm (Q) connector, male-female, 120 cm long
MRC-67V-MF-800	67 GHz flex cable 1.85 mm (V) connector, male-female, 80 cm long
MRC-67V-MF-1200	67 GHz flex cable 1.85 mm (V) connector, male-female, 120 cm long
MMC-40K-MF-800	40 GHz precision flex cable 2.92 mm (K) connector, male-female, 80 cm long
MMC-40K-MF-1200	40 GHz precision flex cable 2.92 mm (K) connector, male-female, 120 cm long
MMC-50Q-MF-800	50 GHz precision flex cable 2.4 mm (Q) connector, male-female, 80 cm long
MMC-50Q-MF-1200	50 GHz precision flex cable 2.4 mm (Q) connector, male-female, 120 cm long
MMC-67V-MF-800	67 GHz precision flex cable 1.85 mm (V) connector, male-female, 80 cm long
MMC-67V-MF-1200	67 GHz precision flex cable 1.85 mm (V) connector, male-female, 120 cm long
MMC-110A-MF-250	110 GHz precision flex cable 1 mm (A) connector, male-female, 25 cm long



## Adapters

High-In addition, high-quality RF and high-end mm-wave range adapters are offered to address challenges of regular system reconfiguration and integration with different type of test instrumentation.

MRA-NM-350F	RF 11 GHz adapter N(male) - 3.5 (male), straight
MRA-NM-350M	RF 11 GHz adapter N(male) - 3.5 (female), straight
MPA-350M-350F	Precision 26 GHz adapter 3.5 mm (male) - 3.5 mm (female), straight
MPA-350F-350F	Precision 26 GHz adapter 3.5 mm (female) - 3.5 mm (female), straight
MPA-350M-350M	Precision 26 GHz adapter 3.5 mm (male) - 3.5 mm (male), straight
MPA-292M-240F	Precision 40 GHz adapter 2.92 mm (male) - 2.4 mm (female), straight
MPA-292F-240M	Precision 40 GHz adapter 2.92 mm (female) - 2.4 mm (male), straight
MPA-292M-292F	Precision 40 GHz adapter 2.92 mm (male) - 2.92 mm (female), straight
MPA-292F-292F	Precision 40 GHz adapter 2.92 mm (female) - 2.92 mm (female), straight
MPA-292M-292M	Precision 40 GHz adapter 2.92 mm (male) - 2.92 mm (male), straight
MPA-240M-240F	Precision 50 GHz adapter 2.4 mm (male) - 2.4 mm (female), straight
MPA-240F-240F	Precision 50 GHz adapter 2.4 mm (female) - 2.4 mm (female), straight
MPA-240M-240M	Precision 50 GHz adapter 2.4 mm (male) - 2.4 mm (male), straight
MPA-185M-185F	Precision 67 GHz adapter 1.85 mm (male) -1.85 mm (female), straight
MPA-185F-185F	Precision 67 GHz adapter 1.85 mm (female) -1.85 mm (female), straight
MPA-185M-185M	Precision 67 GHz adapter 1.85 mm (male) -1.85 mm (male), straight
MPA-185M-100F	Precision 67 GHz adapter 1.85 mm (male) -1.00 mm (female), straight

## REFERENCES

- [1] Parameter may vary depending upon tip configuration and pitch.
- [2] R. B. Marks and D. F. Williams, "Characteristic impedance determination using propagation constant measurement," IEEE Microwave and Guided Wave Letters, vol. 1, pp. 141-143, June 1991.
- [3] D. F. Williams and R. B. Marks, "Transmission line capacitance measurement," Microwave and Guided Wave Letters, IEEE, vol. 1, pp. 243-245, 1991.

Disclaimer: TITAN Probe, QAlibria are trademarks of MPI Corporation, Taiwan. StatistiCal is a trademark of National Institute of Standards and Technology (NIST), USA. All other trademarks are the property of their respective owners. Data subject to change without notice.

Direct contact:  
 Asia region: [ast-asia@mpi-corporation.com](mailto:ast-asia@mpi-corporation.com)  
 EMEA region: [ast-europe@mpi-corporation.com](mailto:ast-europe@mpi-corporation.com)  
 America region: [ast-americas@mpi-corporation.com](mailto:ast-americas@mpi-corporation.com)

MPI global presence: for your local support, please find the right contact here:  
[www.mpi-corporation.com/ast/support/local-support-worldwide](http://www.mpi-corporation.com/ast/support/local-support-worldwide)

© 2023 Copyright MPI Corporation. All rights reserved.

### MPI Global Presence

