



VI.VI



CellAdvisor™

JD745B/JD785B Base Station Analyzers

Introduction

A CellAdvisor JD745B/JD785B Base Station Analyzer is the optimal test tool for installing and maintaining cell sites. It contains all the features and capabilities required for field testing cell sites for all 2G to 4G wireless technologies.

Equipped with one-button standards-based measurements for wireless signals, the analyzer offers a full scope of BTS conformance tests. Its combined functionality includes spectrum analysis, cable and antenna analysis, an RF/optical power meter, interference analysis, a channel scanner, RFoFiber™, and signal analysis.

Standard features include:

- Spectrum analyzer
- Cable and antenna analyzer
- RF power meter

Advanced features include:

- Interference analysis
- Channel scanner
- 2-port transmission
- CW signal generator
- RFoFiber (RFoCPRI/RFoOBSAI)
- GPS receiver
- Built-in bias tee
- Optical power meter
- Fiber inspection with pass/fail (requires P5000i microscope)*
- Cloud Enabled via StrataSync™*
- Signal analysis of cdmaOne/cdma2000, EV-DO, GSM/GPRS/EDGE, WCDMA/HSPA+, TD-SCDMA, Mobile WiMAX, LTE/LTE-Advanced—FDD and LTE/LTE-Advanced—TDD

Highlights and capabilities include:

- Full LTE test capabilities
- LTE MBMS (multimedia broadcast multicast service)
- Passive intermodulation (PIM) detection
- Dual spectrum
- Spectrum replay
- Dual spectrogram
- Remote control
- Coverage mapping
- Remote wireless connectivity via Bluetooth®
- Radar chart
- BBU emulation



JD745B Base Station Analyzer

Spectrum analyzer	100 kHz to 4 GHz
Cable and antenna analyzer	5 MHz to 4 GHz
RF power meter	10 MHz to 4 GHz



JD785B Base Station Analyzer

Spectrum analyzer	9 kHz to 8 GHz
Cable and antenna analyzer	5 MHz to 6 GHz
RF power meter	10 MHz to 8 GHz

*CellAdvisor JD785 only

Features

Easy User Interface

The analyzer provides a consistent, intuitive interface throughout its various functions, giving users a common, easy-to-use menu structure.

The analyzer's built-in help system guides users through each measurement task. They can save a screenshot of any function as a graphic file for report generation and save traces for post-analysis to the instrument's internal memory or to an external USB memory device. Stored data can be easily transferred to a PC using the USB or Ethernet port.

Users can edit file names using the instrument's rotary knob that also conveniently functions as an enter button when selecting alphanumeric characters.

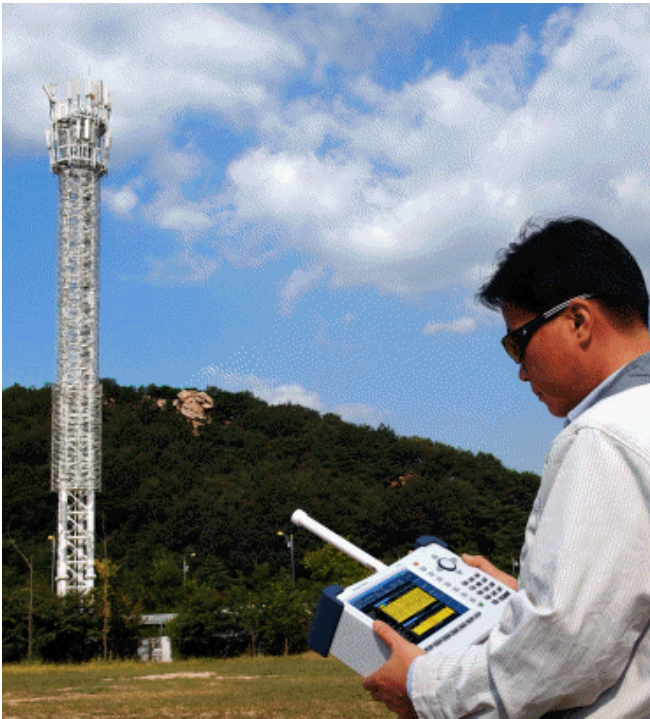

The outdoor display mode enables easier reading in direct sunlight

Automatic Measurements

The analyzer's Auto Measure function affords complete signal profiling covering RF characterization and modulation quality parameters for up to 10 different carriers.

Auto Measure can be easily executed so the instrument automatically configures and tests every aspect for all carriers regardless of their frequency or modulation type. The analyzer's configurable channel scanner can track on one measurement screen the power levels for each of 20 carriers operating at different frequencies or modulation types.

Designed for Field Use

The compact, lightweight analyzer is especially convenient for users who perform field measurements.

Its bright, multimode, 8-inch color display enables clear visibility indoors and outdoors.

The operating temperature ranges from -10 to 55°C; and, its rugged bumper protects the instrument from external impacts exceeding the MIL-PRF-28800F class 2 specification.

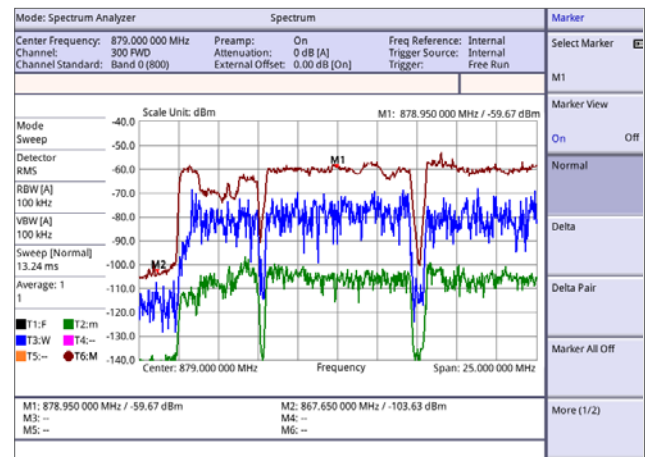

Outdoor display mode

RFoFiber (RFoCPRI/RFoBSAI)

Modern cell sites have a distributed architecture that replaces coax-based feeders with fiber-based feeders and, therefore, significantly reduces signal loss and reflection problems. However, since all RF interfaces reside on the RRH, any RF maintenance or troubleshooting requires reaching the tower top to gain access to the RRH, which increases safety concerns and operational expenses.



The Viavi Solutions™ RFoFiber reduces risky cell tower climbs letting technicians test safely from the ground

RFoFiber technology enables cell technicians to verify the control signals and extracts the RF (IQ) data transmitted between the BBU and RRH at the ground without the need to climb the tower. Key benefit of RFoFiber is that it enables monitoring and analyses of mobile terminal (uplink), PIM detection, as well as the radio's signal (downlink) interference over a fiber link.

Integrated Functionality

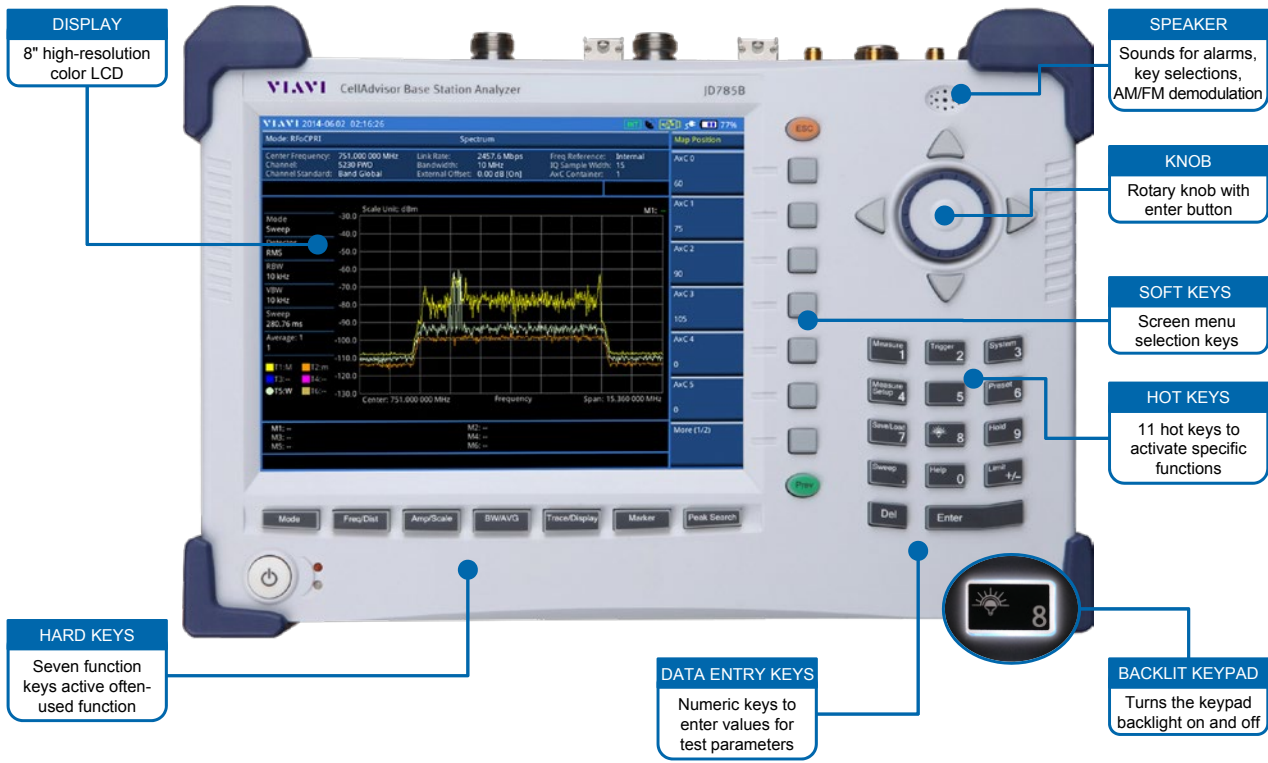
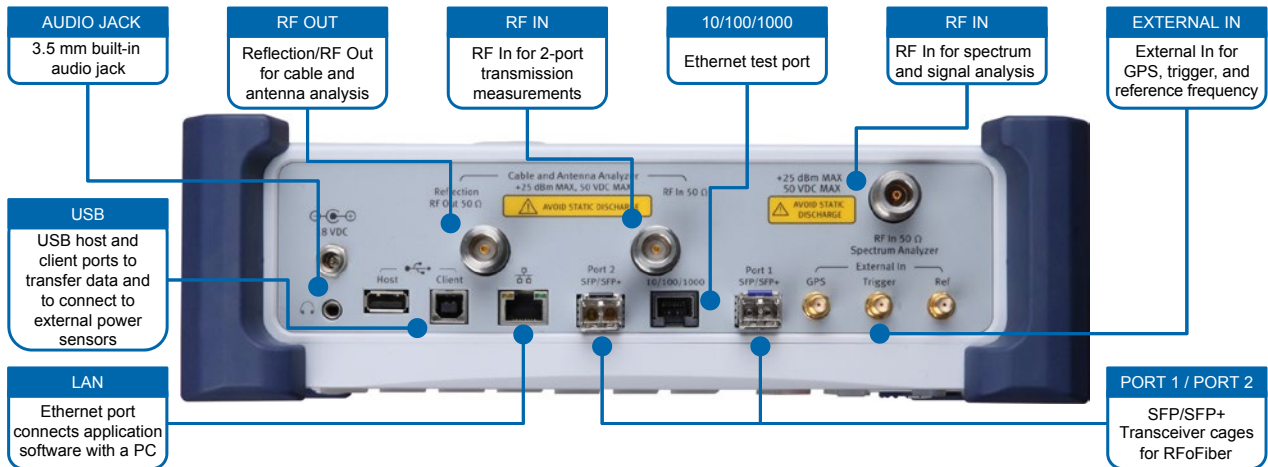

Spectrum Analyzer 100 kHz to 4 GHz (JD745B) 9 kHz to 8 GHz (JD785B) Built-in pre-amplifier Zero span with gate sweep	Locates and identifies various signals. Detects signals as low as -160 dBm/-165 dBm with better than 1 dB measurement accuracy. Triggers pulse or burst signals such as WiMAX, GSM, and TD-SCDMA.
Cable and Antenna Analyzer 5 MHz to 4 GHz (JD745B) 5 MHz to 6 GHz (JD785B)	Provides cable and antenna characterization for proper power transfer from the radio to the antenna. Locates failure points for effective troubleshooting. Verifies conformance to cable specifications.
RF Power Meter 10 MHz to 4 GHz (JD745B) 10 MHz to 8 GHz (JD785B)	Integrated RF power meter eliminates the need for a separate instrument and measures power with or without a power sensor.
2-Port Transmission Measurements (option 001)	Verifies passive and active devices such as filters and amplifiers.
Bias Tee (option 002)	Supplies up to 32 VDC built-in bias to active devices such as amplifiers.
RFoFiber/CW Signal Generator (options 003, 081, 082, 086)	Supports continuous wave (CW) generation and generates LTE FDD and TDD signals.
RFoFiber/Interference Analyzer (options 008, 060-073)	Enables RF measurements over fiber without the need to climb the tower to access the remote radio head.
Bluetooth Connectivity (option 006)	Provides remote control and monitoring capability with JDRemote via Bluetooth interface.
GPS Receiver and Antenna (option 010)	Provides geographical location and highly-accurate frequency, and time for precise measurements.
Interference Analyzer (option 011)	Provides the required spectrogram and multisignal RSSI parameters to properly monitor, identify, and locate interference signals. In addition, it can generate a variable audible tone based on signal strength.
Channel Scanner (option 012)	An intuitive graphical representation of the signal's power for each of the 20 user-definable carriers (frequencies or channels) enables quick identification of improper power levels.
Optical Power Meter	Measures optical power for all single-mode and multimode connectors via an optical power sensor (MP-60A or MP-80A).
Signal Analyzer (options 020-029)	Provides 3GPP/3GPP2/IEEE802.16 conformance testing for RF characteristics as well as modulation analysis of 2G to 4G wireless technologies.
RFoFiber Signal Analyzer (options 091, 092, 096)	The RFoFiber Signal Analyzer supports analysis for LTE-FDD/TDD signals such as modulation accuracy test.
Over-the-Air Analyzer (options 040 to 049)	Characterizes transmission quality at any location providing reflective measurements and identifying signals transmitted from various sites.
BBU Emulation Support (options 101)	Emulates BBU test functions <i>without</i> a BBU connection and tests RF directly from the BBU (RFoCPRI).

Spectrum Analyzer

The analyzer is the most flexible general purpose spectrum analysis test tool for monitoring and analyzing the RF spectrum. The Spectrum Analysis function performs these one-button standards-based wireless-signal power measurements:

- Channel power
- Occupied bandwidth
- Spectrum emission mask
- Adjacent channel power
- Spurious emissions
- Field strength
- AM/FM audio demodulation
- Route map
- PIM detection
- Dual spectrum

Capabilities

- Built-in preamplifier
- Zero span with gated sweep
- AM/FM audio demodulation
- Multiple detectors: normal, RMS, sample, negative, peak
- Advanced marker: frequency counter, noise marker
- Limit line
- Up to six markers and six traces

Measurements

Channel Power measures the power level, spectral density, and peak-to-average ratio (PAR) of the signal in a specified channel bandwidth, showing pass/fail for the defined power

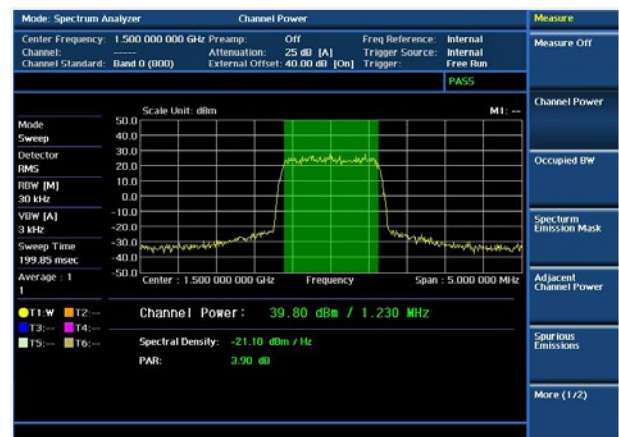

RF test — Channel Power

Occupied BW measures the frequency bandwidth that contains the specified percentage of the power, the total integrated power, and the occupied power with pass/fail results for the defined bandwidth.

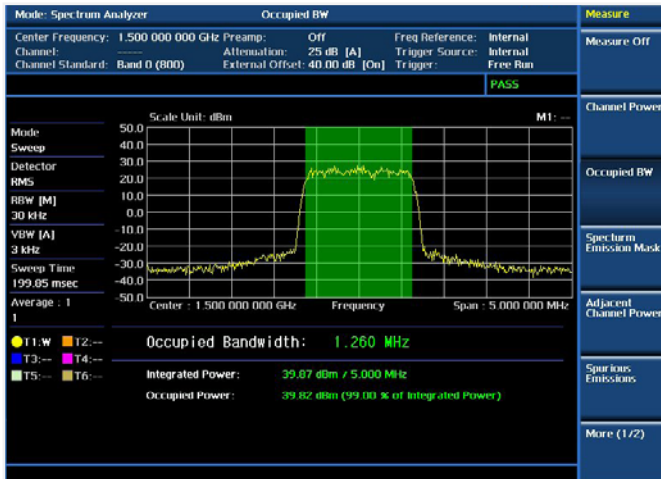

RF test — Occupied Bandwidth

Spectrum Emission Mask (SEM) compares the total power level within the defined carrier bandwidth and the given offset frequencies to defined mask limits with pass/fail results.



RF test — Spectrum Mask Emission Mask

Adjacent Channel Power (ACP) measures the amount of RF power leakage in adjacent channels and its ratios, with pass/fail results for the defined test condition.



RF test — Adjacent Channel Power

Spurious Emissions measurements identify and determine the power level of spurious emissions in certain frequency bands, showing pass/fail results based on the defined mask limits.

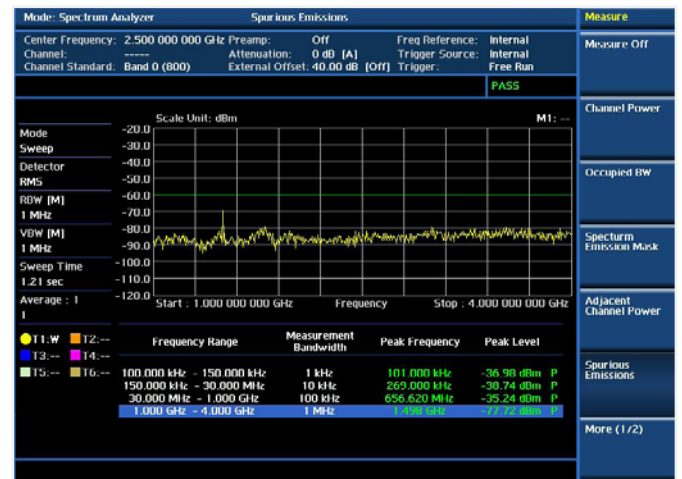

RF Test — Spurious Emissions

Field Strength quickly and conveniently measures and analyzes field strength to user-definable multisegment lines. Measuring field strength is easy once the user specifies the antenna factors in the analyzer.

AM/FM Audio Demodulation identifies interfering signals. The AM/FM signal can be demodulated into the instrument's built-in speaker or through a headset.

The spectrum analyzer can simultaneously operate with the CW signal generator. It easily fulfills the >100 dB guideline required for measuring repeater and antenna isolation.

PIM Detection identifies passive intermodulation in the uplink band caused when signals are combined and transmitted on a single nonlinear feed line.

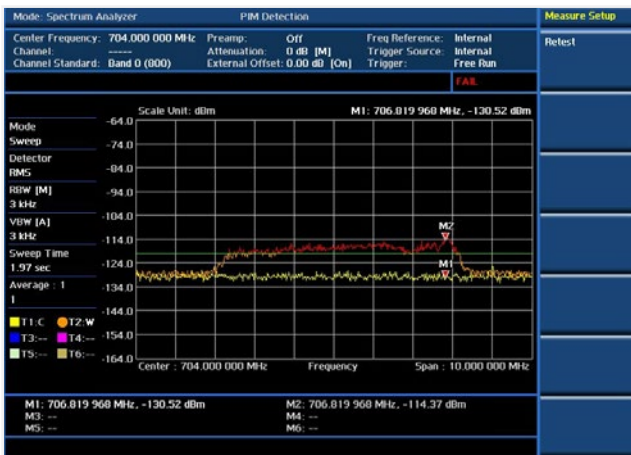

RF test — PIM Detection

Dual Spectrum lets users view the spectrum activity for two different uplink and downlink spectrum bands on one screen simultaneously rather than switching between screens.

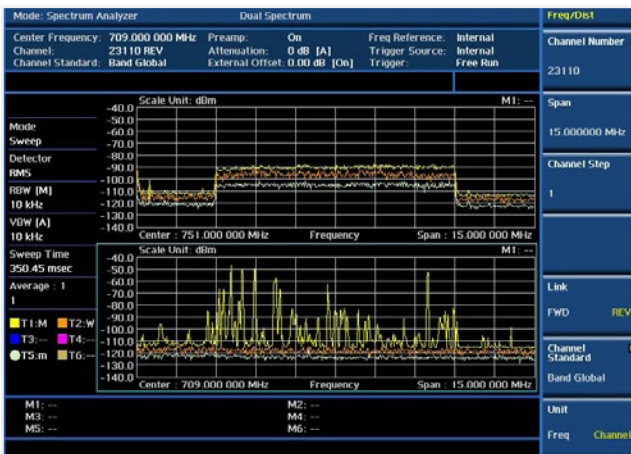

RF test — Dual Spectrum

Cable and Antenna Analyzer

The analyzer performs cable and antenna measurements to verify the base station's infrastructure, including feed lines, connectors, antennas, cables, jumpers, amplifiers, and filters.

Capabilities

- Reflection
 - Voltage standing-wave ratio (VSWR)
 - Return loss
- DTF
 - VSWR
 - Return loss
- Cable loss (1-port)
- Port phase
- Smith chart
- 2-port transmission measurements (option 001)
 - Scalar measurements
 - Vector measurements

Measurements

Reflection – Return Loss measures complete cell-site transmission line impedance performance across a specific frequency range in VSWR or return loss.



Cable and antenna test — Reflection

DTF – Return Loss measures fault locations in the cell-site transmission system indicating signal discontinuities in VSWR or return loss. This distance-to-fault measurement precisely pinpoints the location of such things as damaged or degraded antennas, connectors, amplifiers, filters, and duplexers.

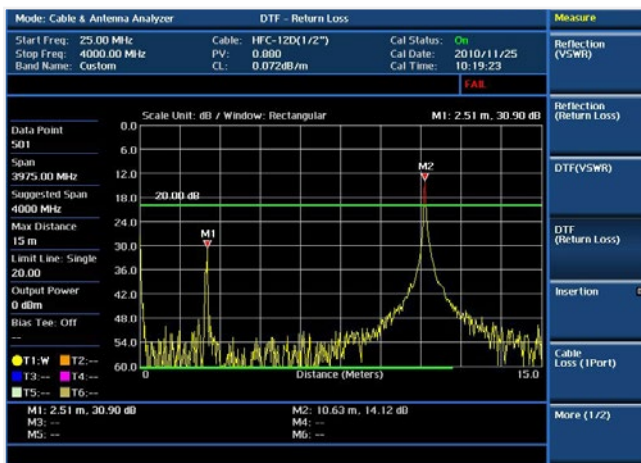

Cable and antenna test — Distance to Fault

Cable Loss (1 port) measures the signal loss through a cable or other devices over a defined frequency range by connecting one end of the cable to the instrument measurement port and terminating the other end of the cable with a short, or leaving it open altogether.



Cable and antenna test — Cable Loss

Smith Chart measures impedance and phase to properly tune RF devices. Smith Chart also displays impedance-matching characteristics in cable and antenna systems or filter and duplexer devices.

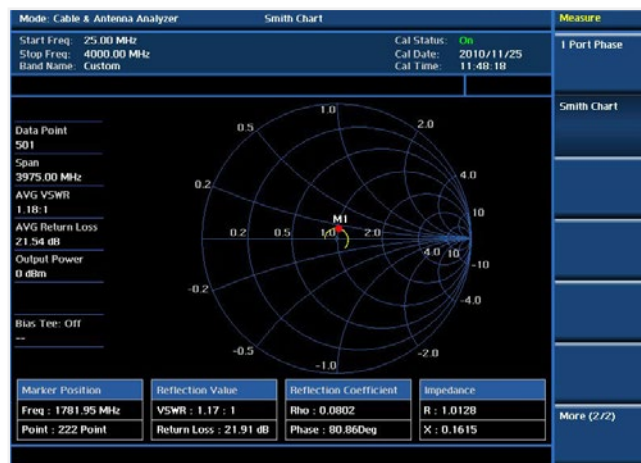

Cable and antenna test — Smith Chart

1-Port Phase measures S_{11} phase to tune antennas and to phase-match cables.



Cable and antenna test — 1-Port Phase

2-Port Measurement (Scalar) (option 001) have vector and scalar measurements. Scalar measurement provides greater dynamic range (>100 dB); vector measurement provides greater accuracy and faster test time.

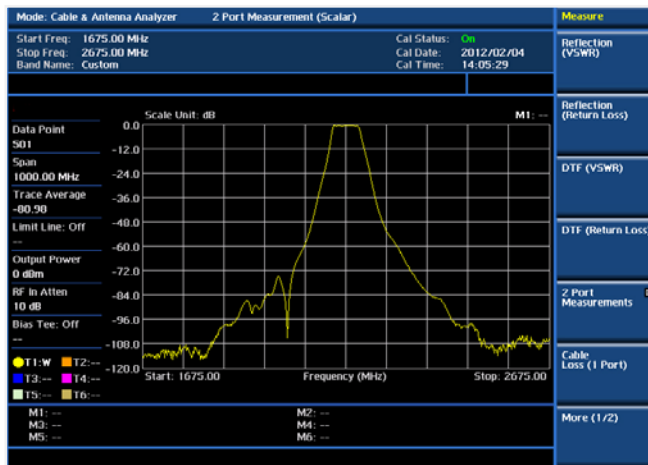

Cable and antenna test — 2-port Measurement

Insertion Gain/Loss measures the characteristics of passive and active devices such as filters, jumpers, splitters, and amplifiers and verifies antenna or sector-to-sector isolation.

2-Port Phase in Vector Measurements measure S_{21} phase to characterize transmission devices such as filters and amplifiers.

The optional built-in bias-tee supplies power to active devices through the instrument's RF In port, eliminating the need for an external power supply.

Power Meters

The analyzer is equipped with an RF power meter and an optical power meter.

The RF power meter performs two different methods of power measurement. The first is an internal power measurement for standard power testing without the assistance of external power sensors and the second interfaces with an external power sensor for high-accuracy power measurements.

The optical power meter measures optical power for single-mode and multimode connectors via an external optical power sensor.

RF Power Meter (Standard)

Internal Power Measurement

- Frequency range: 10 MHz to 4 GHz/8 GHz
- Dynamic range: -120 to +20 dBm/+25 dBm
- Measurement type: RMS or peak

External Power Measurement

- JD732B: Terminating power sensor (average)
- JD734B: Terminating power sensor (peak)
- JD736B: Terminating power sensor (average and peak)
 - Frequency range: 20 MHz to 3.8 GHz
 - Dynamic range: -30 to +20 dBm
- JD731B: Directional (through line) power sensor
 - Frequency range: 300 MHz to 3.8 GHz
 - Dynamic range: average 0.15 to 150 W, peak 4 to 400 W
 - Measurement:
 - Forward average power
 - Reverse average power
 - Forward peak power
 - VSWR
- JD733A: Directional (through line) power sensor
 - Frequency range: 150 MHz to 3.5 GHz
 - Dynamic range: average/peak 0.1 to 50 W
 - Measurement:
 - Forward average power
 - Reverse average power
 - Forward peak power
 - VSWR

Optical Power Meter

Miniature USB 2.0 Optical Power Sensors

- MP-60A
 - Wavelength range: 780 to 1650 nm
 - Dynamic range: 1300, 1310, 1490, 1550 nm: -50 to +10 dBm
850 nm: -45 to +10 dBm
- MP-80A
 - Wavelength range: 780 to 1650 nm
 - Dynamic range: 1300, 1550 nm: -35 to +23 dBm;
850 nm: -30 to +23 dBm



Power sensors

The power meter analysis has user-definable pass/fail limits and displays test results in dBm and watts. Power measurements can be set as absolute measurements displayed in dBm or as relative measurements displayed in dB.

The analyzer displays power levels in two formats, as a real-time value in an analog meter and as a power-level trend through time in a histogram chart.



Power meter test (RF or optical)

*CellAdvisor JD785 only

JD730-series high-precision RF power sensors measure RF power connected via USB to the analyzer.

The analyzer controls terminating power sensors (JD732B, JD734B, and JD736B), making it a highly accurate RF power meter for out-of-service applications up to 3.8 GHz with a -30 to +20 dBm measurement range.

The analyzer controls directional power sensors (JD731B and JD733A) measuring output power and impedance matching for in-service systems. These power sensors can handle up to 150 W of power, eliminating the need for attenuators.

The analyzer controls optical power sensors (MP-series) to measure optical power quickly and easily in single-mode or multimode.

This optical power meter offers a well-organized solution for fiber inspection.

Fiber Inspection* eliminates the most common fiber link problems by verifying that connectors are not contaminated. Only the JD785 can quickly and easily troubleshoot and certify fiber connection quality and cleanliness. Connecting the optional P5000i Fiber Microscope lets users quickly inspect and clean fiber connections with a clear pass/fail indication. The free FiberChekPRO™ application can be used on a PC/laptop with the P5000i microscope to perform the same fiber analysis in parallel using the instrument to test RF and using the PC/laptop to test fiber. Users also can inspect, test, and certify any fiber connector and instantly generate comprehensive pass/fail summary reports.



P5000i microscope

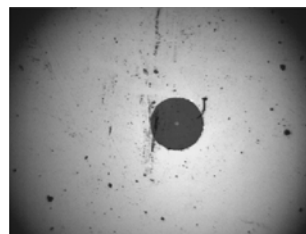

Fiber passed

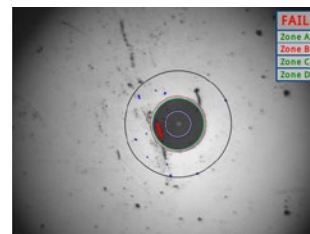

Fiber failed

Interference Analyzer

The Interference Analyzer (option 011) function is extremely effective for locating and identifying periodic or intermittent RF interference. Interference signals derive from several kinds of licensed or unlicensed transmitters that cause dropped calls and poor service quality.

- Spectrum analyzer
 - Sound indicator
 - AM/FM audio demodulation
 - Interference ID
 - Spectrum recorder
- Spectrogram
- Receive signal strength indicator (RSSI)
- Interference finder
- Spectrum replayer
- Dual spectrogram

Measurements

A spectrum analyzer can perform spectrum clearance, capturing just the events where the received signal exceeds the defined power limit.

The audible tone volume is proportional to the signal's power strength. In addition, a built-in AM/FM audio demodulator conveniently identifies AM/FM signals.

Interference ID automatically classifies interfering signals and lists the possible signal types corresponding to the signal selected.

Spectrogram captures spectrum activity over time and uses various colors to differentiate spectrum power levels.

The spectrogram is effective for identifying periodic or intermittent signals. Post-processing analysis can be made for each measurement over time using a time cursor.

RSSI is a multisignal tracking metric that is particularly useful for measuring power-level variations over time.

The RSSI measurement lets you assign a power limit line for audible alarms and increase alarm counters every time a signal exceeds a defined limit line.

For long-term analysis, the spectrogram and RSSI measurements can be automatically saved into an external USB memory. Post-analysis can be performed with JDViewer application software.



Interference analysis test — RSSI

Interference Finder is an automatic triangulation algorithm that uses GPS coordinates to locate possible interference sources based on three measurements.

The interference finder calculates possible interference locations using its inscribed circle or circumscribed circle based on measured intersection points.



Interference analysis test — Interference Finder

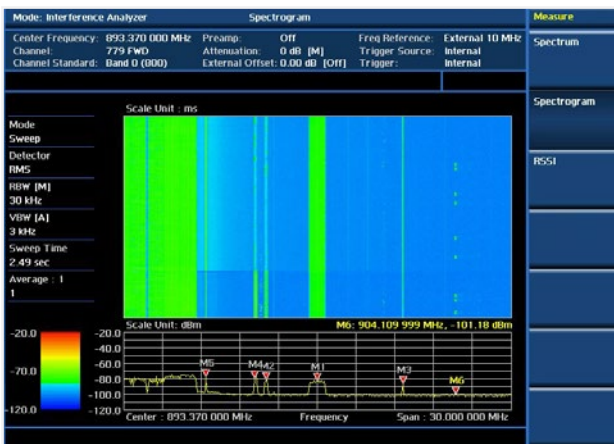

Interference analysis test — Spectrogram

Spectrum Replayer lets users retrieve and replay recorded spectrum analyzer traces in interference analysis mode. These traces can be played back in the spectrogram or RSSI.

Users can configure the limit line to create failure points when signals exceed it. The failure points are clearly displayed on the trace timeline for quick access during playback.

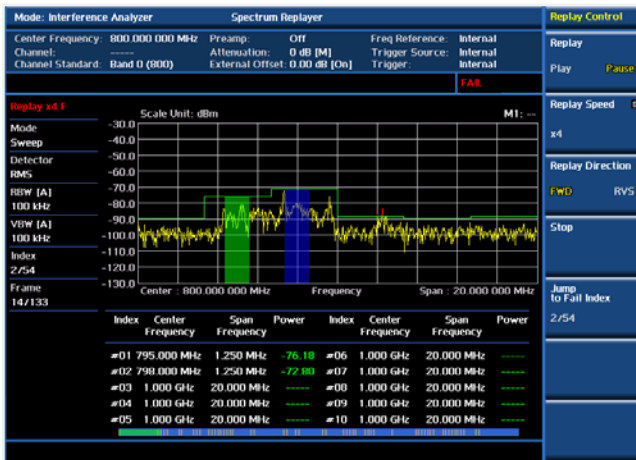

Interference analysis test — Spectrum Replayer

Radar Chart displays an RSSI with azimuth information so that a user can quickly locate interference. CellAdvisor should be used in conjunction with an AntennaAdvisor handle that has a built-in compass, LNA, GPS, and YAGI antenna.

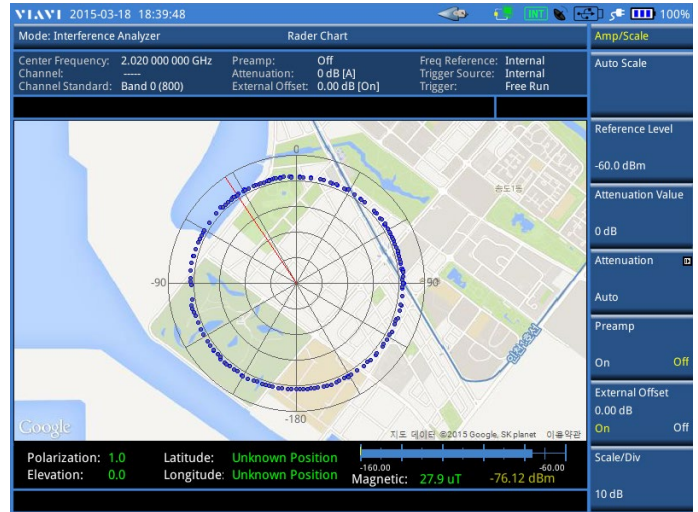

Interference analysis test — Radar Chart (measurement)

Dual Spectrogram captures the spectral activities for two different bands over time to identify periodic or intermittent band signals.

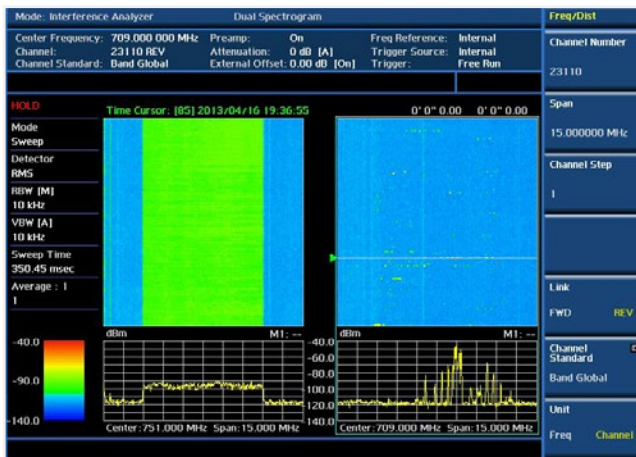

Interference analysis test — Dual Spectrogram

Signal Analyzer

The signal analyzer performs 3GPP/3GPP2/IEEE802.16-standard RF compliance testing for power and spectrum as well as modulation analysis. It performs standards-based measurements with a single-button push, indicating pass/fail based on standards or user-defined limits.

The auto measure capability lets users easily set up test scenarios with programmed measurement schedules such as start time, test duration, test cycles, and test metrics. Then, based on the user-defined conditions, the analyzer tests up to 10 different carriers and automatically saves the corresponding results.

The Over-the-Air (OTA) Analyzer function provides OTA measurements to quickly perform base station characterization. This measurement capability is especially useful for testing cell sites without interrupting service are those that are not easily accessible.

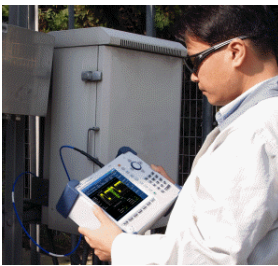

The signal analyzer provides these measurement capabilities:

- Spectrum analysis
- RF analysis
- Modulation analysis
- Auto measure

Modulation analysis can be performed for these wireless technologies:

- cdmaOne/cdma2000 (option 020)
- EV-DO (option 021)
- GSM/GPRS/EDGE (option 022)
- WCDMA/HSPA+ (option 023)
- TD-SCDMA (option 025)
- Mobile WiMAX (option 026)
- LTE-FDD (option 028)
- LTE-Advanced—FDD (option 030)
- LTE-TDD (option 029)
- LTE-Advanced —TDD (option 031)

Over-the-air (OTA) analyses include:

- cdmaOne/cdma2000 (option 040)
- EV-DO (option 041)
- GSM/GPRS/EDGE (option 042)
- WCDMA/HSPA+ (option 043)
- TD-SCDMA (option 045)
- Mobile WiMAX (option 046)
- LTE-FDD (option 048)
- LTE-TDD (option 049)

Signal Analyzer Detailed Feature Matrix

Features		Technology				
		GSM/GPRS/EDGE <i>(Option 022)</i>	WCDMA/HSPA+ <i>(Option 023)</i>	LTE/LTE-Advanced—FDD <i>(Option 028 /030)</i>	LTE/LTE-Advanced—TDD <i>(Option 029 /031)</i>	
RF analysis	Channel power	■	■	■	■	
	Occupied bandwidth	■	■	■	■	
	Spectrum emission mask	■	■	■	■	
	ACP(L)R		■	■	■	
	Multi-ACP(L)R		■	■	■	
	Spurious emissions	■	■	■	■	
Modulation analysis	Power vs. time	Slot	■		■	
		Frame	■		■	
		Mask				
		Timogram				
	Constellation	■	■	■ MBMS	■	
	Code domain power		■			
	Mid-amble power					
	Code power					
	Code error					
	RCDE		■			
	Codogram		■			
	RCSI		■			
	CDP table		■			
	Spectral flatness					
	EVM vs. subcarrier					
	EVM vs. symbol					
	Data channel			■ MBMS	■ MBMS	
	Control channel			■ MBMS	■ MBMS	
	Subframe			■ MBMS	■ MBMS	
	Frame			■ MBMS		
	Time alignment error			■	■	
	Data allocation map			■ MBMS	■ MBMS	
	Auto measure	■	■	■	■	
Power statistics CCDF		■	■	■		
Carrier Aggregation			■	■		
		<i>(Option 042)</i>	<i>(Option 043)</i>	<i>(Option 048)</i>	<i>(Option 049)</i>	
OTA analysis	Scanner	Channel/Frequency	Channel/Scramble	Channel/ID	Channel/ID	
	Multipath profile	■	■	■	■	
	Preamble power trend					
	Modulation analyzer	■				
	Code domain power		■			
	Sync-DL ID vs. tau					
	Sync-DL ID analyzer					
	Control channel			■ MBMS	■ MBMS	
	Datagram			■	■	
	Route map		■	■	■	

Signal Analyzer Detailed Feature Matrix (Continued)

Features		Technology			
	Feature	cdmaOne/cdma2000 <i>(Option 020)</i>	EV-DO <i>(Option 021)</i>	TD-SCDMA <i>(Option 025)</i>	Mobile WiMAX <i>(Option 026)</i>
RF analysis	Channel power	■	■	■	■
	Occupied bandwidth	■	■	■	■
	Spectrum emission mask	■	■	■	■
	ACP(L)R	■	■	■	■
	Multi-ACP(L)R	■	■	■	■
	Spurious emissions	■	■	■	■
Modulation analysis	Power vs. time	Slot	Idle/Active	■	
		Frame		■	■
		Mask		■	
		Timogram		■	
	Constellation	■	■	■	■
	Code domain power	■	■		
	Mid-amble power			■	
	Code power			■	
	Code error			■	
	Codogram	■	■		
	RCSI	■	■		
	CDP table	■	■		
	Spectral flatness				■
	EVM vs. subcarrier				■
	EVM vs. symbol				■
	Data channel				
	Control channel				
	Subframe				
	Frame				
	Time alignment error				
	Data allocation map				
Auto measure	■	■	■	■	
Power statistics CCDF	■	■		■	
		<i>(Option 040)</i>	<i>(Option 041)</i>	<i>(Option 045)</i>	<i>(Option 046)</i>
OTA analysis	Scanner	Channel/PN	Channel/PN	Sync-DL ID	Preamble
	Multipath profile	■	■	Sync-DL ID	■
	Preamble power trend				■
	Modulation analyzer				
	Code domain power	■	■		
	Sync-DL ID vs. tau			■	
	Sync-DL ID analyzer			■	
	Control channel				
	Datagram				
Route map	■	■	■	■	

RF Analysis

Channel Power measures a signal's total RF power, spectral density, and peak-to-average ratio (PAR) in a specified channel bandwidth.



RF analysis — Channel Power

Occupied BW measures the frequency bandwidth containing 99 percent of the power for total integrated and occupied power.



RF analysis — Occupied Bandwidth

Spectrum Emission Mask compares the total power level within the defined carrier bandwidth and the given offset frequencies on each side of the carrier frequency against allowable standards.



RF analysis — Spectrum Emission Mask

Adjacent Channel Power Ratio or Adjacent Channel Leakage Ratio measures RF power leakage in adjacent channels and its ratios per specified standards.



RF analysis — Adjacent Channel Power

The Spurious Emissions measurement identifies and determines spurious emissions power levels in certain frequency bands.

Modulation Analysis

Power vs. Time (Frame) verifies, with LTE-TDD, WiMAX, and GSM, that the transmitter output power has the correct amplitude, shape, and timing according to the standards.



Modulation analysis — Power vs. Time

Constellation provides with multimedia broadcast/multicast services (MBMS), modulation quality metrics (EVM) for data and/or control channels, at its corresponding modulation scheme, such as GMSK, QPSK, 16 QAM and 64 QAM.



Modulation analysis — Data Constellation

Code Domain measures with CDMA/EV-DO and WCDMA/HSPA+, spread code channel power levels across the RF channel, normalized to total power.

Code domain power (CDP) shows the signal's physical channels indicating the various spread factors using different colors to easily differentiate the traffic types carried within the signal.



Modulation analysis — Code Domain Power

Code Power provides the power data for an individual code channel and layer for a specified time slot. It displays the power of the 16 codes of a specified signal.

Code Error shows the power data and error data for an individual code channel and layer for a specified time simultaneously.

Relative Code Domain Error is computed by projecting the error vector onto the code domain at a specified spreading factor.

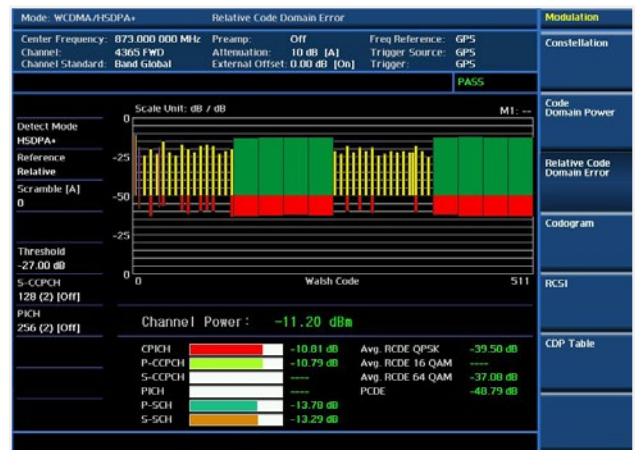

Modulation analysis — Relative Code Domain Error

Modulation Analysis (Continued)

Codogram or **Datagram** displays code power variations over time to give a clear view of each channel's traffic load at any given time.

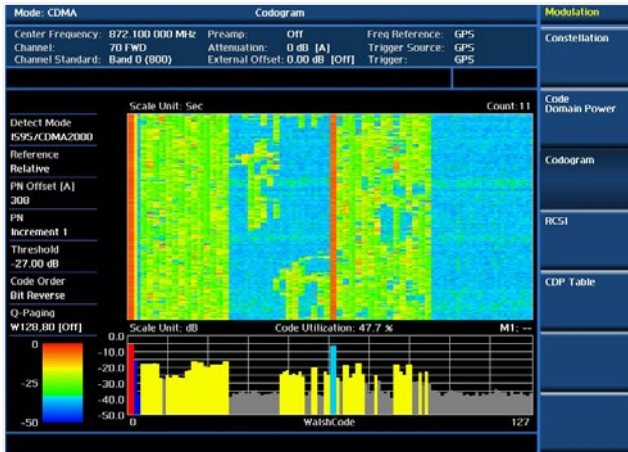

Modulation analysis — Codogram

RCSI (received code strength indicator) shows, with CDMA/EV-DO and WCDMA/HSPA+, power variations over time for control channels.

The analyzer can automatically save codogram and RCSI measurements into external USB memory for long-term analysis or for post-analysis with JDViewer application software.



Modulation analysis — RCSI

Spectral Flatness measures, with Mobile WiMAX, the constellation's flatness energy per the standards.

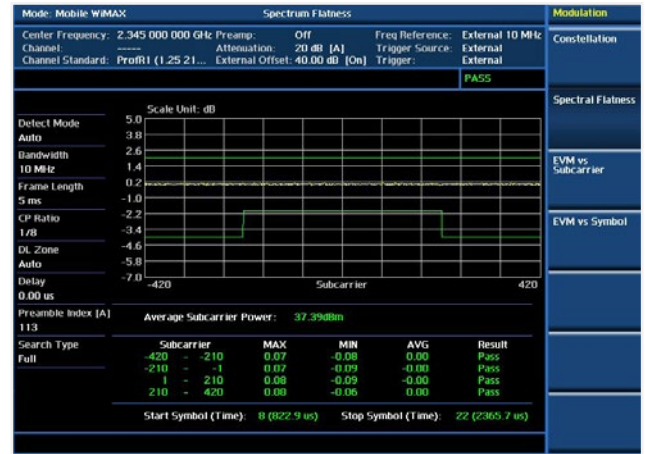

Modulation analysis — Spectral Flatness

EVM vs. Subcarrier shows, with Mobile WiMAX, the error vector magnitude representing the average constellation error for OFDMA subcarriers.

EVM vs. Symbol shows, with Mobile WiMAX, the error vector magnitude representing the average constellation error for OFDMA symbols.

Complementary Cumulative Distribution Function (CCDF) characterizes the statistical power level distribution at any given time.

Data Channel measures, with LTE and MBMS, selected resource block or control channel constellation and modulation quality at any subframe.

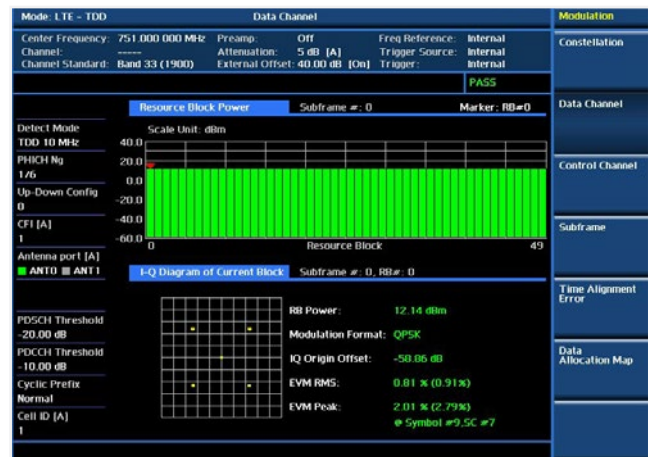

Modulation analysis — Data Channels

Modulation Analysis (Continued)

Subframe measures, with LTE and MBMS, the data and control channel power and modulation quality in any subframe.



Modulation analysis — Subframe

Frame measures, with LTE and MBMS, the power and modulation quality for all data and control channels in a frame.



Modulation analysis — Frame

Time Alignment Error for LTE/MIMO measures MIMO time differences of up to four transmission branches.



Modulation analysis — Time Alignment Error

Data Allocation Map measures, with LTE and MBMS, the power level for all resource blocks across subframes and shows data utilization within a frame.



Modulation analysis — Data Allocation Map

Modulation Analysis (Continued)

Auto Measure lets users easily and quickly check the RF and modulation parameters with the push of a button. All base stations can be tested uniformly using the same procedure with virtually no errors because of test variability. Additionally, this function reduces human error and improves efficiency. Predefined tests enable users at all skill levels to obtain consistent, accurate results.

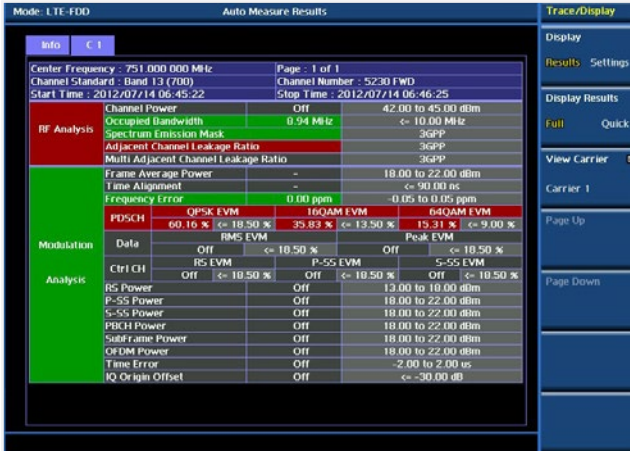

RF and Modulation analysis — Auto Measure

Carrier Aggregation performs up to five interband and/or intraband component carriers, performing a complete characterization in each carrier including power level, modulation quality in data, and control channels.



Modulation analysis — Carrier Aggregation

OTA Analysis

ID (Channel Scanner) measures the strongest of six received cell identifiers, providing all relevant information such as PCI, RSRP, and RSRQ.



OTA analysis — ID (Channel Scanner)

OTA Control Channel with LTE and MBMS provides signal performance metrics for locations served by the base station, including multipath profile indicating reflected signal strength.

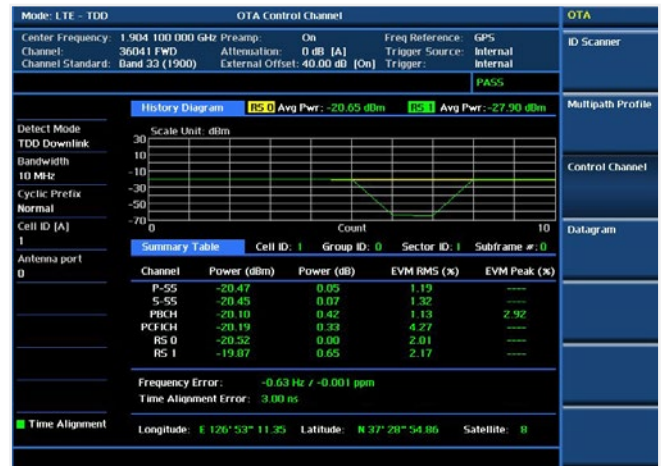

OTA analysis — Control Channels

Datagram measures, with LTE, the power level for all the resource blocks across time and shows data utilization over time.



OTA analysis — OTA Datagram

Route Map measures the OTA performance of a cell site in a defined service area by plotting the corresponding OTA metric in a map, which is then tracked with the instrument's GPS.

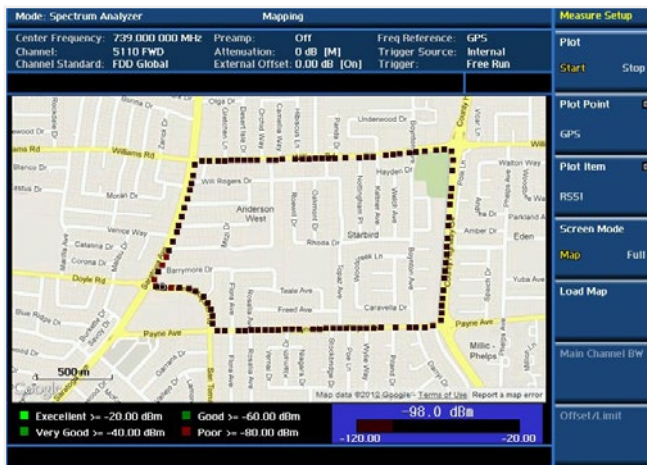

OTA analysis — Route Map

JDMapCreator creates the desired map of interest from a picture file for indoor coverage, or geo-coded maps for outdoor coverage that can then be loaded to the analyzer using a USB memory device.

The route map feature is included in Spectrum Analyzer mode and in Signal Analyzer OTA mode.

JDMapCreator can generate a sizable map so CellAdvisor can zoom-in the map down to two depths.

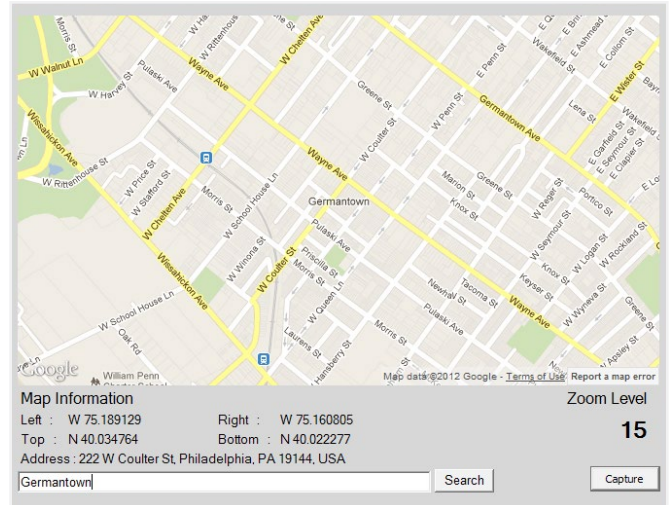

OTA analysis — JDMapCreator

RFoFiber

The analyzer measures RF over fiber to monitor the fiber link status between REC (BBU) and RE (RRH), and it can emulate the REC to verify the RRH cabling and operational status at the ground via fiber.

Capabilities

- Layer-2 monitoring
- Layer-2 term
- Interference analyzer
 - Spectrum analyzer
 - Sound indicator
 - AM/FM audio demodulation
 - Interference ID
- Spectrum recorder
 - Spectrogram
 - RSSI
 - Spectrum replayer
- PIM detection
 - Single radio
 - Multiple radios
- RFoCPRI signal generator
 - LTE-FDD
 - LTE-TDD
- RFoBSAI signal generator
 - LTE-FDD

- RFoCPRI signal analyzer
 - LTE-FDD
 - LTE-TDD
- RFoBSAI signal analyzer
 - LTE-FDD
- BBU emulation
 - Installation verification
 - Spectrum clearance
 - Coverage range
 - PIM analysis

Measurement

Layer 2 Monitoring is an in-service measurement that enables monitoring of the Layer-1 link maintenance alarms delivered on the Layer-2 L1 in-band protocol as well as optical power being received.

Layer 2 Term is an out-of-service measurement that also enables monitoring of the Layer-1 link maintenance alarms delivered on the Layer-2 L1 in-band protocol as well as optical power being received. Another benefit of this function is to emulate the baseband unit and support the start-up process of the RRH so users can verify the optical cabling and proper RRH operation at the ground.



RFoCPRI – Layer 2 Monitoring



RFoCPRI – Layer 2 Term

Interference Analyzer

Interference analyzer captures I/Q data from the fiber link and shows the uplink and downlink spectrum. RFoFiber does not require tower climbs to locate and identify interference signals present on the uplink band.

Spectrum Analyzer enables users to see and record the uplink and downlink spectrum for further analysis later. It provides a more effective way to observe interference for TDD systems because it completely separates the uplink signal from downlink.



RFoBSAI – Layer 2 Monitoring

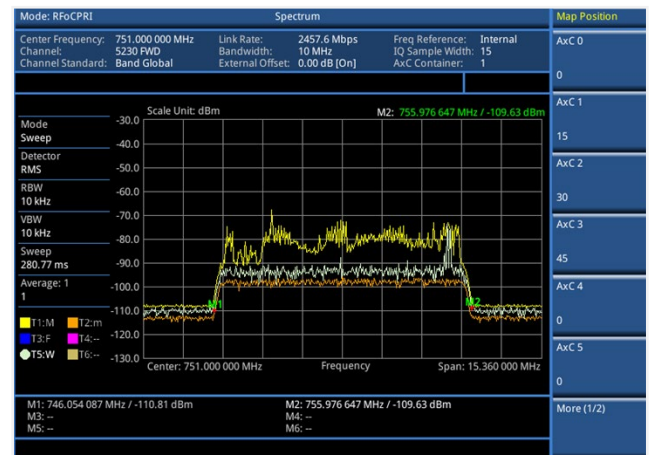

RFoCPRI – Spectrum

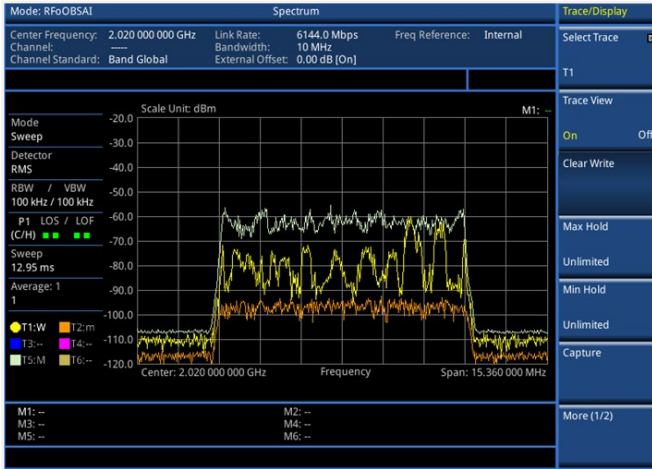

RfOBSAI – Spectrum

Spectrum Replayer enables users to replay a recorded baseband spectrum achieved over fiber link to better understand the nature of interference signal under investigation.

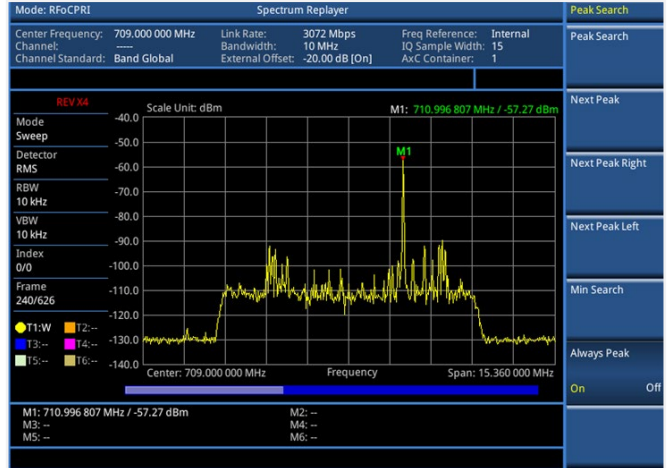

RfOCPRI - Spectrum replayer

Spectrogram captures spectrum and displays it as a waterfall diagram to identify signal interference easily and quickly. Time cursor and Marker enable time and frequency tracking for the intermittent interference signals.

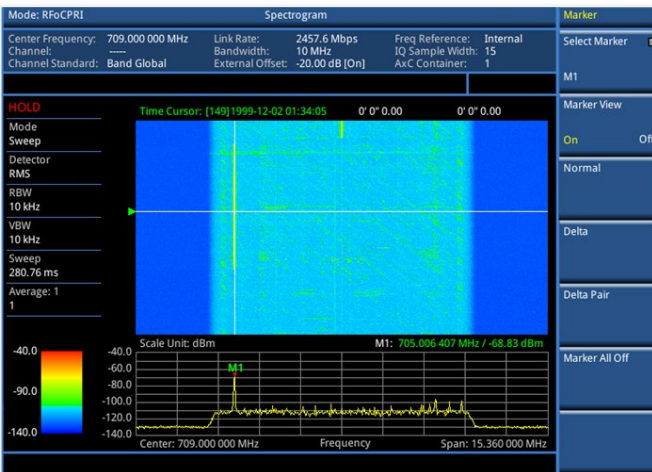

RfOCPRI - Spectrogram

PIM Detection enables PIM detection on the radio system uplink. PIM detection can be achieved differently based on the number of radios that share the same RF/coaxial antenna system. Users can easily check the PIM generated by a single radio occupying wide band or multiple radios with different frequencies.



RfOCPRI – PIM detection

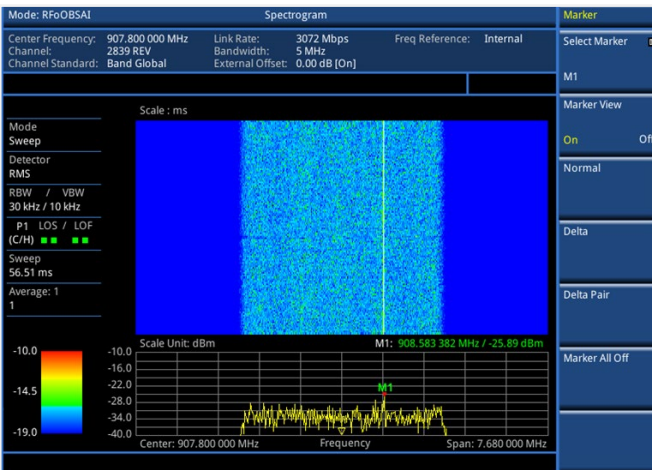

RfOBSAI – Spectrogram



RfOBSAI LTE-FDD signal analyzer window

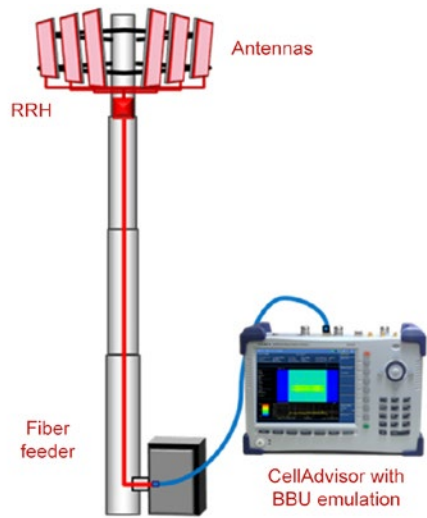

RfOCPRI — DL signal analysis window

BBU Emulation

The BBU emulation function (option 101) lets CellAdvisor emulate as a baseband unit and performs the necessary functions of a BBU for testing purposes. This function helps verify the installation of fiber cabling between the BBU and RRH, the coaxial cabling between the RRH and antennas, and the spectrum clearance and coverage range of the cell site.



RRH CPRI status and active software



RRH SFP information

Channel Scanner

The Channel Scanner function (option 012) can measure up to 20 independent channels for any cellular technology at any channel or frequency. It also shows the power level for each signal type.



Channel Scanner

StrataSync*

The CellAdvisor JD780A-series analyzers are compatible with the Viavi StrataSync cloud to manage instrument inventory, to locate each piece of equipment and to identify which engineer is using it. StrataSync also helps to keep instruments current through remote upgrades to ensure all instruments have the latest firmware. It also centralizes configuration setting and distribution to ensure that engineers are using the same instrument settings to achieve consistent measurements. Once testing is complete, measurement results can be uploaded into StrataSync for secure storage and sharing. Engineers who are unable to resolve a problem can share measurement results with an expert to get analysis help from anywhere without having the expert be near the instrument.

- Manage asset inventory
- Remotely distribute instrument upgrades
- Centralize configuration sharing
- Offers test data management
 - Trace files
 - Screenshots
 - Remote analysis



* CellAdvisor JD785 only

Bluetooth and WiFi Connectivity

Bluetooth and WiFi connectivity (options 006 and 016 respectively) provide safer and easier long-distance testing with the instrument housed at the top of the tower and controlled remotely via Bluetooth or Wi-Fi using a USB WiFi dongle. Tests are conveniently made from the ground. Users can also transfer files from the instrument using file transfer. They can also tether the instrument to an Android smartphone or tablet with a data service connection to upload or download data to the Viavi StrataSync cloud.

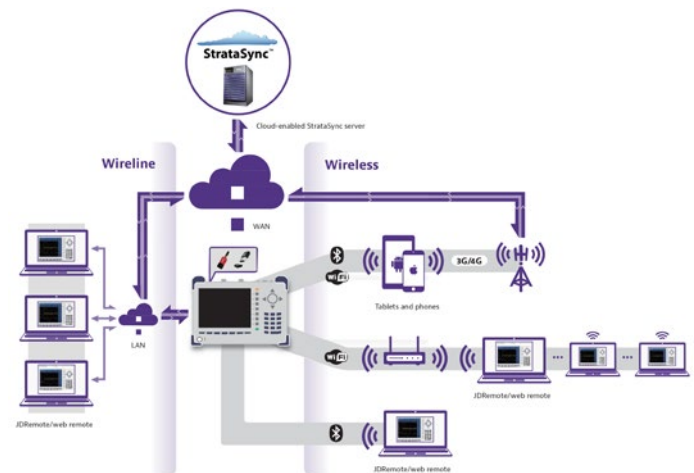

Bluetooth and WiFi connectivity

GPS Receiver and Antenna

The GPS receiver (option 010) gives the location (latitude, longitude, and altitude) and timing for highly-accurate frequency measurements to independently verify base-station timing.



Analyzer with GPS antenna

Application Software

JDViewer Features

- Communicates with the analyzer via LAN or USB
- Retrieves measured or saved measurements
- Exports measurement results
- Generates and prints configurable reports
- Creates a composite file of multiple spectrogram traces
- Analyzes measurement results allowing for assignment of multiple markers and limit lines
- Creates user-defined settings for channel power, occupied bandwidth, SEM, and ACLR
- Registers and edits user-definable cable types and frequency bands
- Creates automatic testing scenarios for GSM, CDMA/EV-DO, WCDMA/HSPA+, Mobile WiMAX, and LTE
- Creates signal strength maps as well as over-the-air signal analysis maps for GSM, CDMA/EV-DO, WCDMA/HSPA+, Mobile WiMAX, and LTE



JDViewer OTA mapping

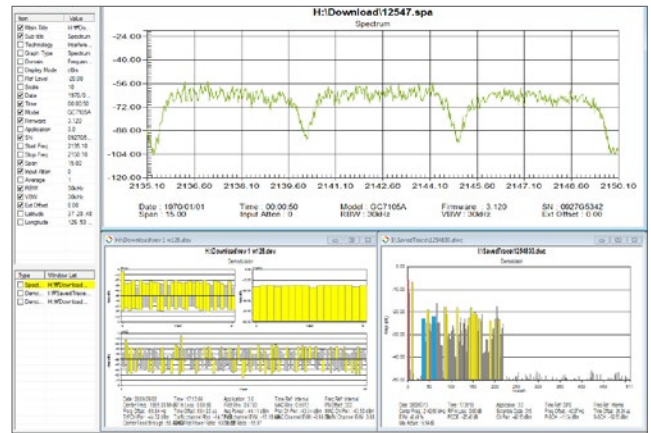

JDViewer spectrum, demodulation

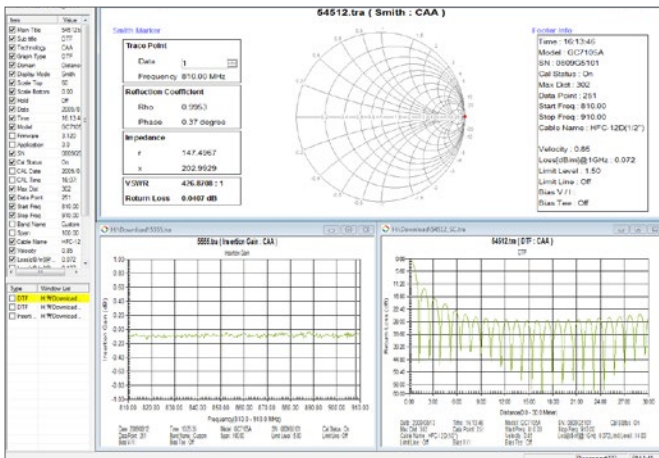

JDViewer VSWR, DTF, Smith chart

JDRemote Features

This capability permits full remote control of the instrument through a software client. Control can either be via directly connected USB, network LAN connections, or Bluetooth.

The analyzer communicates with two Windows-based applications:

- JDViewer — for post-processing, report generation, personalized settings, and coverage map creation
- JDRemote — for full remote control



Analyzer with JDRemote



Contact Us **+1 844 GO VIAVI**
(+1 844 468 4284)

To reach the Viavi office nearest you,
visit viavisolutions.com/contacts.

© 2016 Viavi Solutions Inc.
Product specifications and descriptions in this
document are subject to change without notice.
jd745b-jd785bcelladvisor-br-cpo-nse-ae
30176001 901 0116