

FOT-930 MaxTester

MULTIFUNCTION LOSS TESTER



Please note that this model has been discontinued. For more information, visit EXFO.com

Delivering fully automated loss results for up to three wavelengths in 10 seconds, in addition to automatic ORL and fiber-length measurements with complete, high-quality test documentation.

KEY FEATURES

FasTesT™: Three-wavelength measurement of optical loss, ORL and fiber length in 10 seconds

All-in-one, portable test solution: Up to eight instruments combined in a single, eye-catching handheld package

FTTx-ready: Allows for the testing of passive optical networks (PONs) at 1310 nm, 1490 nm and 1550 nm, the three wavelengths recommended by the ITU-T (G.983.3) for PONs

Cost of ownership: Lowest in the industry, thanks to three-year warranty, error-free testing and minimized training time

SPEC SHEET

EXFO

EXFO'S NEXT-GENERATION MAXTESTER: MORE FEATURES, BETTER PERFORMANCE

The new FOT-930 MaxTester Multifunction Loss Tester is designed to help network service providers address CAPEX and OPEX issues, enable installers to easily adapt to all network types, and provide CATV operators with a single-unit solution to their backreflection, fiber-length, high-power and bidirectional loss measurement needs. Combined with its video fiber inspection probe, this unit also enables the easy detection of dirty or damaged connectors, providing a clear view of connectors and fiber ends on the FOT-930's high-resolution display.

All-in-one unit: Combines up to eight instruments

- › Loss meter
- › Power meter
- › Optical return loss (ORL) meter
- › Visual fault locator (VFL)
- › Multimode and singlemode light sources
- › Digital talk set
- › Fiber-length meter
- › Video fiber inspection probe

FasTesT function: One-touch, automated measurements in 10 seconds

- › Bidirectional loss and ORL testing at up to three singlemode wavelengths
- › Bidirectional loss testing at two multimode wavelengths
- › Fiber-length measurement

Flexible solution: Five-wavelength multimode and singlemode configurations to meet the requirements of installers/contractors in all test situations

- › Up to three singlemode wavelengths on one port—1310 nm, 1550 nm and a choice between 1490 nm and 1625 nm
- › Two multimode wavelengths—850 nm and 1300 nm—on a second port

Future-proof: Next-generation features meeting the latest industry requirements

- › User-configurable pass/fail thresholds that can be adjusted to different industry standards
- › FTTx-ready for testing of passive optical networks (PONs) at the following three ITU-T G.983.3 recommended wavelengths: 1310, 1490 and 1550 nm

Cost of ownership: Lowest on the market

- › Three-year warranty
- › Error-free testing achieved through visual loss and ORL pass/fail analysis
- › Minimized training time, thanks to a single user interface for the eight instruments included in this all-in-one unit

Easy to use and ergonomic: Built for today's fiber-optic test requirements

- › Handy, eye-catching and rugged handheld package
- › High-resolution color display
- › Complete data management and report generation
- › Nine-hour power autonomy provided by field-swappable rechargeable batteries



With countless available configurations, the FOT-930 MaxTester is the handheld unit of choice for today's network service providers, fiber-optic network installers/contractors and CATV operators.

FTTx-READY: OPTIMIZED FOR TESTING PASSIVE OPTICAL NETWORKS

FTTx-Mode Operation

This mode lets you configure your FOT-930 MaxTester to suit your FTTx wavelengths and test-unit locations, as well as choose your preferred data presentation options for on-screen display or report generation. Key benefits include:

- › Display of test data according to FTTx terminology
- › Similar test-data presentation, regardless of the location of master and remote units

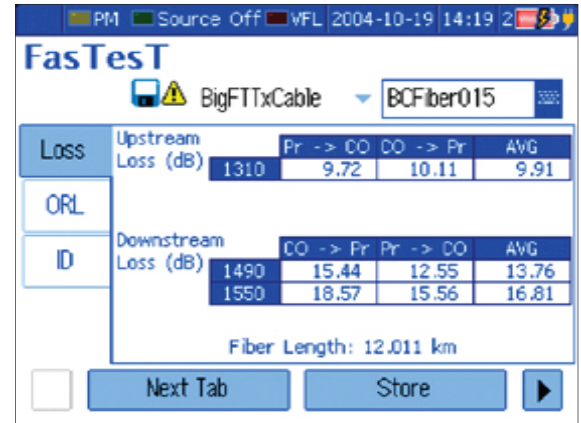

Integrated Data Storage Management

This feature enables the FasTesT initiator to save results on a remote unit—even when multiple remote units are used. Key benefits include:

- › The ability to store test data in a single unit
- › Easier data post-processing and transfer from the FTB-3930 module (see the figure below)

Point-to-Multipoint Testing with Multiple Referencing

Implemented in the FTB-3930 MultiTest Module, multiple referencing lets you coordinate the FTB-3930 with up to 10 remote FOT-930 MaxTester units. Key benefits include:

- › First-class efficiency enabling several technicians to simultaneously install and test distribution fibers

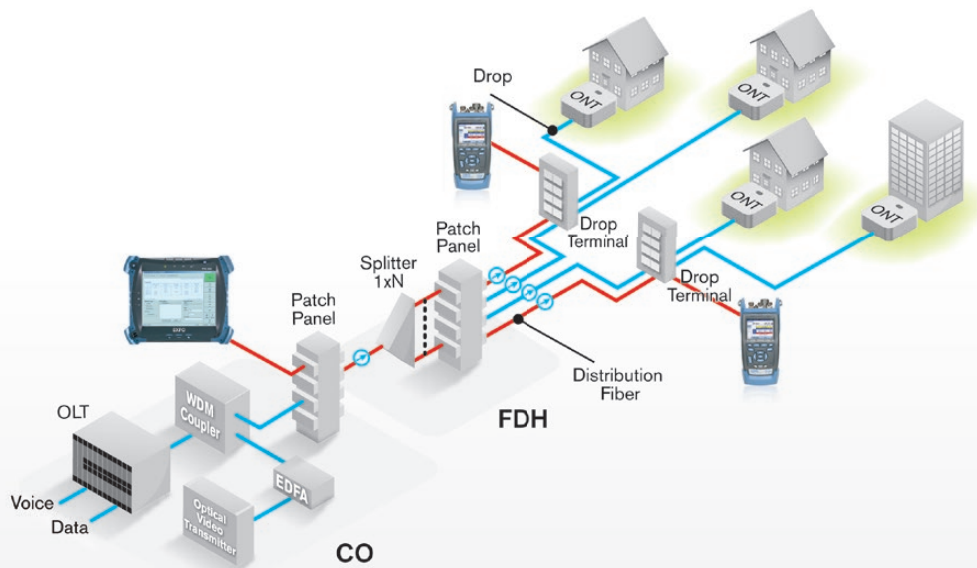

The FOT-930 allows for automated, bidirectional loss and ORL testing of passive optical networks (PONs) at 1310 nm, 1490 nm and 1550 nm, the three wavelengths recommended for PONs by ITU-T (G.983.3).

A SINGLE TOOL FOR ALL BACKREFLECTION, FIBER-LENGTH AND LOSS MEASUREMENT NEEDS

Because it's easier and much faster to learn how to operate a single instrument, test specialists should choose an all-in-one, do-it-all solution such as the FOT-930 MaxTester, which enables them to perform the following tasks: installing long-haul, high-speed networks, testing 1310/1490/1550 nm transmission in FTTH networks, performing multimode testing in enterprise networks, etc.

Key Advantages for All Network Types

- › Fast, three-wavelength loss and ORL testing
- › User-configurable pass/fail thresholds for error-free testing
- › The only unit designed for testing both multimode and singlemode fiber
- › Video fiber inspection probe for easy viewing of connectors and fiber ends on the FOT-930's high-resolution display
- › GeX detector for high-power measurement up to +26 dBm
- › Complete report generation capabilities
- › Talk set and VFL options
- › Ease of use, for faster testing, reduced training, minimum error potential, etc.

Loss	Loss (dB)			
	A->B	B->A	AVG	
ORL	1310	28.77	29.14	28.96
ID	1550	22.35	23.15	21.98
	1625	20.57	20.52	20.55

Fiber Length: 68.359 km

Within 10 seconds, the MaxTester's FasTesT function provides insertion loss and ORL values for up to three wavelengths—including either 1490 or 1625 nm—on a single port.

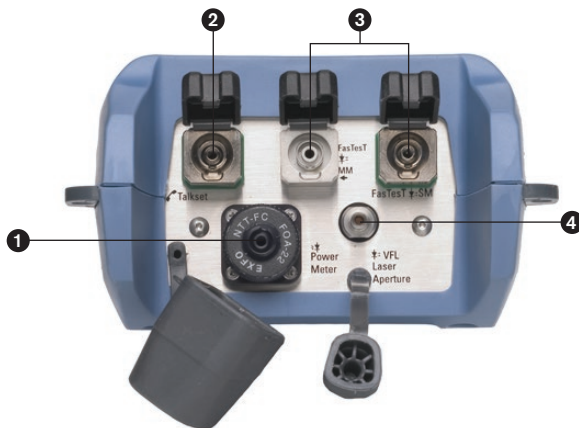

- 1 Power Meter Detector Port**
Compatible with almost every connector on the market. Perform power and loss testing manually and efficiently. Accurately measure power up to +26 dBm.
- 2 Talk Set Port**
For crystal-clear voice communication.
- 3 FasTesT Ports**
Perform loss, ORL and fiber-length measurement for up to three SM wavelengths on one port, and for two MM wavelengths on a second port.
- 4 VFL**
Built-in 650 nm visual fault location on a universal connector.

KEY FEATURES

- Two FasTesT ports: A three-wavelength singlemode port, including either 1625 or 1490 nm, and a two-wavelength multimode port, for a total of up to five wavelengths
- Automatic measurement of ORL and fiber length during FasTesT
- Visual loss and ORL pass/fail analysis
- Large 320 x 240 pixel color screen
- Storage of over 1000 complete test reports, with automated report generation
- Options: High-power detector, talk set, VFL and video fiber inspection probe
- No offset nulling required

FasTesT Port:	Singlemode	Loss Wavelengths	<input checked="" type="checkbox"/> 1310 nm
DUT Type:	125/9 μm		<input checked="" type="checkbox"/> 1490 nm
Compatibility:	FOT-930		<input checked="" type="checkbox"/> 1550 nm
Length Unit:	km	ORL Wavelengths	<input checked="" type="checkbox"/> 1310 nm
Auto save to:	Master unit		<input checked="" type="checkbox"/> 1490 nm
Mode/wave.:	Custom		<input checked="" type="checkbox"/> 1550 nm

Factory Settings Go to FasTesT Ref.

While performing FasTesT measurements, the FOT-930 can launch automated loss and ORL measurements on all three wavelengths and perform fiber-length measurements.

STANDARD DATA REPORTING FEATURES

The FOT-930's software automatically sets up test data in an easy-to-read, well-organized table. Testing is simplified thanks to the highly intuitive user interface and integrated test functions, taking software user-friendliness to the next level.

- › Select predefined test parameters and pass/fail thresholds
- › Customize user settings and cable identification parameters
- › Add operator comments
- › Generate reports for ORL, bidirectional loss (three wavelengths) and fiber-length measurement

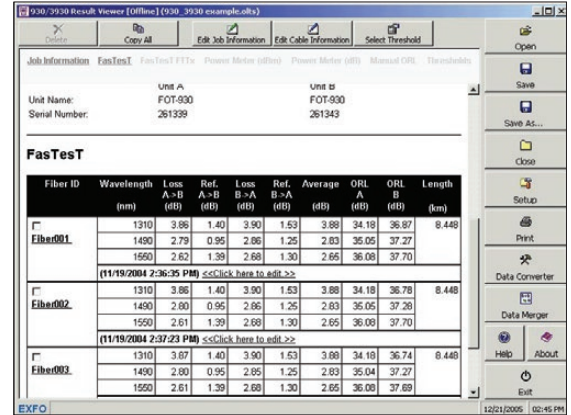

Display comprehensive test results using the Optical Report Viewer software.

Report Generation

Due to growing fiber deployment in NSP and CATV networks, installation companies must often hire subcontractors. These subcontractors must produce proper test documentation to corroborate that the tests were performed as specified.

EXFO's FOT-930 MaxTester easily and efficiently provides complete, high-quality test documentation. Users can perform in-depth analysis and first-class report generation by taking advantage of the FOT-930's data-logging and management features to quickly access and download test results to any PC through the RS-232 port.

Fiber ID	Wavelength	Loss A-B	Loss B-A	Mean	ORL A	ORL B	Length
FIBER008	1310	-0.56	-0.22	-0.29	-50.88	-53.24	8415
	1550	-2.05	-1.72	-1.88			
	1625	-1.15	-1.88	-2.01	-53.65	-54.82	
FiberComment							
FIBER009	1310	-3.37	-3.18	-3.27	-50.84	-53.84	8415
	1550	-2.29	-1.84	-2.11			
	1625	-2.62	-2.25	-2.43	-53.35	-55.46	
FiberComment							
FIBER040	1310	-3.38	-3.20	-3.29	-50.84	-53.17	8415
	1550	-2.09	-1.71	-1.92			
	1625	-2.19	-1.88	-2.02	-53.11	-54.87	
FiberComment							
FIBER041	1310	-3.38	-3.18	-3.27	-50.84	-53.43	8415
	1550	-2.10	-1.77	-1.93			
	1625	-2.17	-1.88	-2.01	-53.09	-54.85	
FiberComment							
FIBER042	1310	-3.38	-3.18	-3.27	-51.04	-53.77	8416
	1550	-2.48	-2.28	-2.38			
	1625	-2.85	-2.71	-2.79	-53.79	-56.72	
FiberComment							
FIBER043	1310	-3.59	-3.37	-3.48	-50.98	-55.20	8415
	1550		-2.63	-2.77	-52.22		
	1625	-3.38	-3.03	-3.19	-57.12	-51.68	
FiberComment							
FIBER044	1310	-3.81	-3.68	-3.74	-50.40	-56.77	8414
	1550	-2.42	-2.07	-2.24			
	1625	-2.64	-2.35	-2.49	-50.31	-54.33	
FiberComment							
FIBER045	1310	-3.81	-3.67	-3.74	-50.42	-56.79	8417
	1550	-2.42	-2.07	-2.24			
	1625	-2.64	-2.35	-2.49	-50.33	-54.34	
FiberComment							

The FOT-930 provides quick and complete FasTest reports.

Online Help Menu and Multilingual Interface for Enhanced User-Friendliness

The FOT-930 MaxTester features a comprehensive, easy-to-use online help menu providing all the necessary information required for highly efficient instrument operation—an advantage offered by no other test unit on the market. This feature contributes to the FOT-930's unequalled user-friendliness.

The FOT-930's interface is available in seven different languages: English, Simplified Chinese, Spanish, French, German, Czech and Russian, allowing users to choose their preferred language in order to further reduce training and testing time.

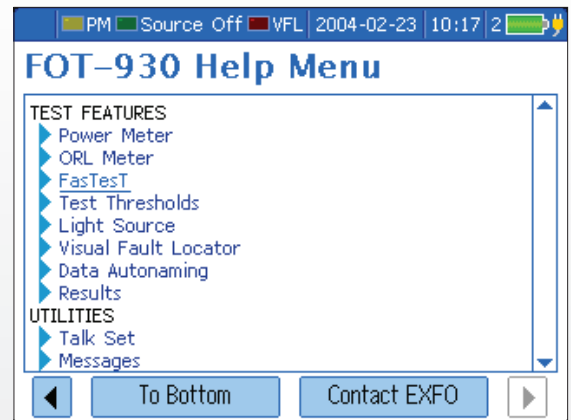

The online help menu and choice of interface languages significantly increase user efficiency.

FAST-TRACK DATA POST-PROCESSING WITH FASTREPORTER 2 SOFTWARE

FastReporter 2 includes a powerful tool that **automates repetitive operations on large numbers of OTDR test files**. Users can process an unlimited number of files in a session, and combine single operations into multioperation batch sessions. In a nutshell, FastReporter 2 optimizes your productivity.

› Batch documentation

- › Document an entire cable/project in a matter of seconds
- › Save time in the field by documenting your files at the office
- › Manage different measurements simultaneously

› Get uniformity in your results

- › Adjust cable and fiber parameters
- › Set detection thresholds for all measurements at once

› Batch analysis

- › Adjust parameters for all cables at once
- › Adjust detection thresholds
- › Set pass/fail thresholds for OTDR, OLTS, CD and PMD testing and characterize your link to ensure that you meet link requirements.

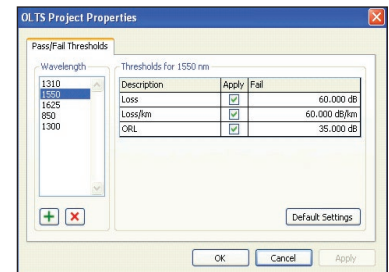
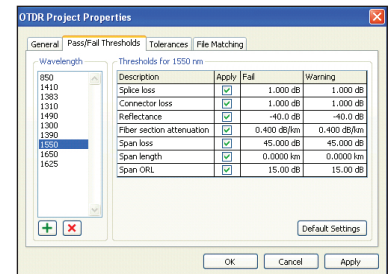

Flexible Reporting

› Various report templates to choose from

Loss and ORL (including EXFO's FasTesT function)

OTDR

PMD

Chromatic dispersion (CD)

Fiber characterization

Cable report

Event Loss	Loss (dB)		Return Loss (dB)		Loss/km (dB/km)		ORL (dB)	
	Loss	Return Loss	Loss/km	Return Loss/km	Loss	Return Loss	Loss/km	Return Loss/km
Fiber#1 (1550 nm)	-42.7	0.271	-42.4	0.211	0.203	-0.228	-42.4	-
Fiber#2 (1550 nm)	-47.2	0.208	-47.4	0.212	0.247	-0.228	-42.1	-
Fiber#3 (1550 nm)	-47.1	0.245	-42.9	0.211	0.209	-0.228	-42.4	-
Fiber#4 (1550 nm)	-42.9	0.208	-42.4	0.209	0.207	-0.228	-42.9	-
Fiber#5 (1550 nm)	-47.1	0.210	-42.9	0.212	0.217	-0.228	-42.4	-
Fiber#6 (1550 nm)	-42.9	0.208	-42.4	0.228	0.204	-0.228	-42.1	-
Fiber#7 (1550 nm)	-47.2	0.423	-42.9	0.208	0.204	-0.228	-42.9	-
Fiber#8 (1550 nm)	-42.9	0.270	-42.9	0.245	0.203	-0.228	-42.7	-
Fiber#9 (1550 nm)	-47.1	0.220	-42.9	0.227	0.208	-0.228	-42.9	-
Fiber#10 (1550 nm)	-42.1	0.198	-42.9	0.148	0.202	-0.228	-42.7	-
Max	-42.7	0.208	-42.9	0.148	0.202	-0.228	-42.1	-

OTDR cable report.

Fiber ID	CD @ 1550 nm		PMD	OLTS				OTDR						
	Dispersion (ps/nm)	Dispersion/km (ps/nm/km)		Warn. Height (dB)	Loss A-B (dB)	Loss B-A (dB)	ORL A-B (dB)	ORL B-A (dB)	Length (km)	Max Span (km)				
G2	2333.94	16.84	0.20	0.04	1550	27.620	27.710	27.820	31.78	32.19	138.5850	138.6235	0.198	0.027
					1625	29.600	29.400	29.540	32.35	32.41	138.5850	138.6206	0.212	0.041
G1	2241.23	16.20	0.24	0.03	1550	28.730	28.600	28.680	32.05	32.92	138.5460	138.5870	0.248	0.087
					1625	30.250	30.280	30.310	32.28	34.15	138.5460	138.5840	0.229	0.050
G4	2227.21	16.79	0.44	0.04	1550	29.010	28.870	28.940	32.97	32.80	138.5370	138.5825	0.217	0.078
					1625	30.670	30.640	30.630	33.53	34.05	138.5370	138.5804	0.198	0.078
G3	2228.82	16.81	0.61	0.05	1550	28.090	27.940	28.010	31.80	32.24	138.5370	138.5823	0.214	0.068
					1625	29.790	29.740	29.760	32.25	33.61	138.5370	138.5847	0.228	0.054

Fiber characterization report.

One cable report replaces hundreds of single-fiber test printouts, simplifying and speeding up high-fiber-count data management. This report automatically provides per-event and per-fiber statistics, and flags threshold-exceeding values. It also generates end-to-end reports for one or more wavelengths.

› Report customization

Create your own report template with external reporting software such as Crystal Reports®.

› Format saving

Easily create comprehensive PDF, Excel or HTML reports, with no additional formatting.

› Copy Graph function

Customize your reports by integrating your graphs into documents such as Excel, Word, etc.

SPECIFICATIONS^a

EXTERNAL POWER METER			
	FOT-932	FOT-932X	FOT-933
Detector type	Ge	GeX	InGaAs
Measurement range (dBm)	10 to -70	26 to -55	6 to -73
Range displayed (dBm)	Down to -77	Down to -65	Down to -80
Uncertainty ^{b,c}	± 5 % ± 0.1 nW	± 5 % ± 3 nW	± 5 % ± 0.05 nW
Wavelength range (nm)	800 to 1650	800 to 1650	800 to 1650
Display resolution (dB) ^b	0.01	0.01	0.01
Calibrated wavelengths	40	42	40
Recommended recalibration period (years)	1	1	1
Automatic offset nulling ^d	Yes	Yes	Yes
Measurement-distance units	kilometers, meters, kilofeet, feet, miles	kilometers, meters, kilofeet, feet, miles	kilometers, meters, kilofeet, feet, miles

SOURCES					
	Standard	-4	-5	-12C (second port)	-12D (second port)
Wavelengths (nm) ^e	1310 ± 20 1550 ± 20	1310 ± 20 1550 ± 20 1625 ± 10	1310 ± 20 1490 ± 10 1550 ± 20	850 ± 25 1300 +50/-20	850 ± 25 1300 +50/-20
Emitter type	Laser	Laser	Laser	LED	LED
Minimum output power (dBm) ^e	-1/-1	-1/-4/-7	-1/-7/-4	-27/-27 (50/125 μm) ⁱ	-21/-21 (62.5/125 μm) ⁱ
Spectral width (nm) ^f	≤ 5/≤ 5	≤ 5/≤ 5/≤ 5	≤ 5/≤ 5/≤ 5	50/135	50/135
Stability (8 hours) (dB) ^g	± 0.05	± 0.05	± 0.05	± 0.05	± 0.05

FASTEST					
	Standard	-4	-5	-12C (second port)	-12D (second port)
Wavelengths (nm)	1310 1550	1310 1550 1625	1310 1490 1550	850 1300	850 1300
Loss range (dB) ^h	60	56	56	40	46
Loss precision (repeatability) (dB) ⁱ					
side-by-side	0.15	0.15	0.15	0.15	0.15
loopback	0.25	0.25	0.25	0.25	0.25
Length measurement range (km)	200	200	200	5	5
Length measurement uncertainty ^j				±(10 m + 1 % x length)	

DEDICATED ORL	
	All SM Wavelengths
ORL range (APC / UPC) (dB)	65/55
ORL uncertainty (dB) ^k	± 0.5
Resolution (dB) ^b	0.01

TALK SET	
Emitter type	Laser
Wavelength (nm)	1550 ± 20
Dynamic range at 1550 nm (dB)	45
Dynamic range MM (dB) ^l	40

VFL ^l	
Emitter type	Laser
Wavelength (nm)	650
Output power (dBm)	3

GENERAL SPECIFICATIONS		
Size (H x W x D)	250 mm x 125 mm x 75 mm	(9 7/8 in x 4 15/16 in x 3 in)
Weight	1 kg	(2.2 lb)
Temperature		
operating	-10 °C to 50 °C	(14 °F to 122 °F)
storage ^m	-40 °C to 70 °C	(-40 °F to 158 °F)
Storage	Capacity of 1024 complete tests	
Relative humidity	0 % to 95 % noncondensing	
Power ⁱ	Li-Ion battery (9 hours) Full recharge takes three hours when the unit is turned off	
Warranty (years)	3	

STANDARD ACCESSORIES	
User guide, AC adapter/charger, 2 Li-Ion batteries, shoulder strap, Certificate of Calibration.	

Notes

- a. At 23 °C ± 1 °C and 1550 nm with FC connector and on batteries, unless otherwise specified.
- b. Resolution, uncertainty and linearity are functions of input power; uncertainty is valid at calibration conditions.
- c. Up to 20 dBm for GeX.
- d. Power of > -45 dBm for Ge, > -30 dBm for GeX and > -47 dBm for InGaAs.
- e. In High source mode.
- f. As defined by Telcordia TR-TSY-000887, rms for lasers and at -3 dB for LEDs; typical values for LEDs.
- g. After a warm-up time of 6 minutes, in CW source mode.
- h. Typical value, at 1550 nm for SM and 850 nm for MM.
- i. Typical value.
- j. For fiber length ≤ 120 km.
- k. Typical value.
- l. For graded-index MM fibers, typical.
- m. Without batteries.

ORDERING INFORMATION

FOT-93X-XX-XX-XX

Model

FOT-932 = Ge detector, dual-wavelength 1310/1550 nm
 FOT-932-4 = Ge detector, triple-wavelength 1310/1550/1625 nm
 FOT-932-5 = Ge detector, triple-wavelength 1310/1490/1550 nm
 FOT-932X = GeX detector, dual-wavelength 1310/1550 nm
 FOT-932X-4 = GeX detector, triple-wavelength 1310/1550/1625 nm
 FOT-932X-5 = GeX detector, triple-wavelength 1310/1490/1550 nm
 FOT-933 = InGaAs detector, dual-wavelength 1310/1550 nm
 FOT-933-4 = InGaAs detector, triple-wavelength 1310/1550/1625 nm
 FOT-933-5 = InGaAs detector, triple-wavelength 1310/1490/1550 nm
 FOT-932-12C = Ge detector, dual-wavelength 1310/1550 nm (first port),
 dual-wavelength 850/1300 nm LED (50/125 μm) (second port)
 FOT-932-12D = Ge detector, dual-wavelength 1310/1550 nm (first port),
 dual-wavelength 850/1300 nm LED (62.5/125 μm) (second port)
 FOT-932X-12C = GeX detector, dual-wavelength 1310/1550 nm (first port),
 dual-wavelength 850/1300 nm LED (50/125 μm) (second port)
 FOT-932X-12D = Ge detector, dual-wavelength 1310/1550 nm (first port),
 dual-wavelength 850/1300 nm LED (62.5/125 μm) (second port)

Talk set and visual fault locator^a

00 = Without talk set and VFL
 VFL = With visual fault locator
 VFT = With talk set and VFL (universal 2.5 mm connector)

Connector^b

EI-EUI-28 = UPC/DIN 47256
 EI-EUI-76 = UPC/HMS-10/AG
 EI-EUI-89 = UPC/FC narrow key
 EI-EUI-90 = UPC/ST
 EI-EUI-91 = UPC/SC
 EI-EUI-95 = UPC/E-2000
 EI-EUI-98 = UPC/LC
 EA-EUI-28 = APC/DIN 47256^c
 EA-EUI-89 = APC/FC narrow key^c
 EA-EUI-91 = APC/SC^c
 EA-EUI-95 = APC/E-2000^c
 EA-EUI-98 = APC/LC^c

Probe option

00 = Without probe
 FP4S = Inspection probe (400x)
 FP4D = Inspection probe (200x/400x)

Example: FOT-932X-4-VFL-FP4S-EI-EUI-89

^a EXFO Universal Interface is protected by US patent 6,612,750.

Notes

- Connector type for the talk set is the same as the one specified for the main source.
- Only available with second port/source.
- Not available with second port/source.

LASER SAFETY

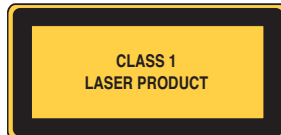

EXFO Headquarters > Tel.: +1 418 683-0211 | Toll-free: +1 800 663-3936 (USA and Canada) | Fax: +1 418 683-2170 | info@EXFO.com | www.EXFO.com

EXFO serves over 2000 customers in more than 100 countries. To find your local office contact details, please go to www.EXFO.com/contact.

EXFO is certified ISO 9001 and attests to the quality of these products. EXFO has made every effort to ensure that the information contained in this specification sheet is accurate. However, we accept no responsibility for any errors or omissions, and we reserve the right to modify design, characteristics and products at any time without obligation. Units of measurement in this document conform to SI standards and practices. In addition, all of EXFO's manufactured products are compliant with the European Union's WEEE directive. For more information, please visit www.EXFO.com/recycle. Contact EXFO for prices and availability or to obtain the phone number of your local EXFO distributor.

For the most recent version of this spec sheet, please go to the EXFO website at www.EXFO.com/specs.

In case of discrepancy, the Web version takes precedence over any printed literature.