

# R&S® ZNB VECTOR NETWORK ANALYZER

## Specifications

3  
year  
warranty



Data Sheet  
Version 12.00

**ROHDE & SCHWARZ**  
Make ideas real



# CONTENTS

<b>Definitions .....</b>	<b>3</b>
<b>Measurement range .....</b>	<b>4</b>
<b>Measurement speed.....</b>	<b>7</b>
<b>Measurement accuracy of the R&amp;S®ZNB4 and the R&amp;S®ZNB8.....</b>	<b>10</b>
<b>Measurement accuracy of the R&amp;S®ZNB20 .....</b>	<b>11</b>
<b>Measurement accuracy of the R&amp;S®ZNB40 model .72.....</b>	<b>12</b>
<b>Measurement accuracy of the R&amp;S®ZNB40 model .82 and .84 .....</b>	<b>13</b>
<b>Effective system data .....</b>	<b>15</b>
<b>Factory-calibrated system data .....</b>	<b>16</b>
<b>Test port output.....</b>	<b>19</b>
<b>Test port input.....</b>	<b>24</b>
<b>Additional front panel connectors.....</b>	<b>25</b>
<b>Display .....</b>	<b>25</b>
<b>Rear panel connectors .....</b>	<b>25</b>
<b>Options .....</b>	<b>27</b>
R&S®ZNB-B1.....	27
R&S®ZNB-B4.....	27
R&S®ZNB-B10.....	27
R&S®ZNB-B12.....	27
R&S®ZNB-B14.....	27
R&S®ZNB-B15.....	28
R&S®ZNB4-B22/-B24, R&S®ZNB8-B22/-B24, R&S®ZNB20-B22/-B24 and R&S®ZNB40-B22 .....	29
R&S®ZNB4-B31/-B32/-B33/-B34 and R&S®ZNB8-B31/-B32/-B33/-B34 .....	29
R&S®ZNB4-B52/-B54 and R&S®ZNB8-B52/-B54 .....	30
R&S®ZNB-B81.....	31
<b>General data .....</b>	<b>32</b>
<b>Dimensions (in mm).....</b>	<b>33</b>
<b>Ordering information .....</b>	<b>35</b>

# Definitions

## General

Product data applies under the following conditions:

- Three hours storage at ambient temperature followed by 30 minutes warm-up operation
- Specified environmental conditions met
- Recommended calibration interval adhered to
- All internal automatic adjustments performed, if applicable

## Specifications with limits

Represent warranted product performance by means of a range of values for the specified parameter. These specifications are marked with limiting symbols such as  $<$ ,  $\leq$ ,  $>$ ,  $\geq$ ,  $\pm$ , or descriptions such as maximum, limit of, minimum. Compliance is ensured by testing or is derived from the design. Test limits are narrowed by guard bands to take into account measurement uncertainties, drift and aging, if applicable.

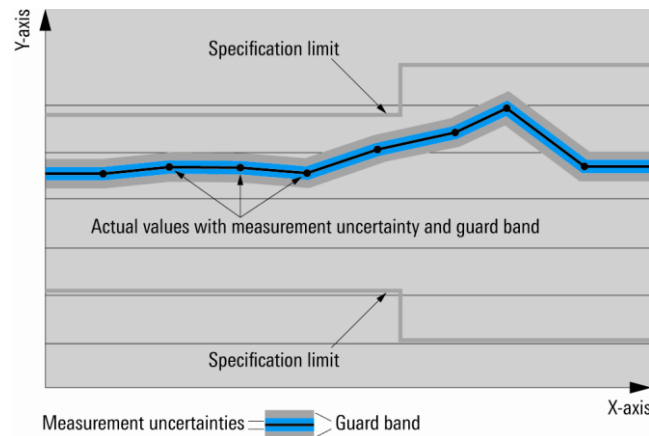

## Non-traceable specifications with limits (n. trc.)

Represent product performance that is specified and tested as described under “Specifications with limits” above. However, product performance in this case cannot be warranted due to the lack of measuring equipment traceable to national metrology standards. In this case, measurements are referenced to standards used in the Rohde & Schwarz laboratories.

## Specifications without limits

Represent warranted product performance for the specified parameter. These specifications are not specially marked and represent values with no or negligible deviations from the given value (e.g. dimensions or resolution of a setting parameter). Compliance is ensured by design.

## Typical data (typ.)

Characterizes product performance by means of representative information for the given parameter. When marked with  $<$ ,  $>$  or as a range, it represents the performance met by approximately 80 % of the instruments at production time. Otherwise, it represents the mean value.

## Nominal values (nom.)

Characterize product performance by means of a representative value for the given parameter (e.g. nominal impedance). In contrast to typical data, a statistical evaluation does not take place and the parameter is not tested during production.

## Measured values (meas.)

Characterize expected product performance by means of measurement results gained from individual samples.

## Uncertainties

Represent limits of measurement uncertainty for a given measurand. Uncertainty is defined with a coverage factor of 2 and has been calculated in line with the rules of the Guide to the Expression of Uncertainty in Measurement (GUM), taking into account environmental conditions, aging, wear and tear.

Device settings and GUI parameters are designated with the format “parameter: value”.

Non-traceable specifications with limits, typical data as well as nominal and measured values are not warranted by Rohde & Schwarz.

In line with the 3GPP/3GPP2 standard, chip rates are specified in million chips per second (Mcps), whereas bit rates and symbol rates are specified in billion bits per second (Gbps), million bits per second (Mbps), thousand bits per second (kbps), million symbols per second (MSPS) or thousand symbols per second (ksps), and sample rates are specified in million samples per second (Msamples/s). Gbps, Mcps, Mbps, MSPS, kbps, ksps and Msamples/s are not SI units.

## Measurement range

Impedance		50 $\Omega$
Test port connector	R&S®ZNB4	N female
	R&S®ZNB8	N female
	R&S®ZNB20	3.5 mm, male, ruggedized
	R&S®ZNB40	2.92 mm, male, ruggedized
Number of test ports	R&S®ZNB4	2 or 4
	R&S®ZNB8	2 or 4
	R&S®ZNB20	2 or 4
	R&S®ZNB40	2 or 4
Frequency range <sup>1</sup>	R&S®ZNB4	9 kHz to 4.5 GHz
	R&S®ZNB8	9 kHz to 8.5 GHz
	R&S®ZNB20	100 kHz to 20 GHz
	R&S®ZNB40 model .72	10 MHz to 40 GHz
	R&S®ZNB40 model .82 and .84	100 kHz to 40 GHz

Static frequency accuracy		(time since last adjustment $\times$ aging rate) + temperature drift + calibration accuracy
Aging per year	standard	$\pm 1 \times 10^{-6}$
	with R&S®ZNB-B4 precision frequency reference option	$\pm 1 \times 10^{-7}$
Temperature drift (+5 °C to +40 °C)	standard	$\pm 1 \times 10^{-6}$
	with R&S®ZNB-B4 precision frequency reference option	$\pm 1 \times 10^{-8}$
Achievable initial calibration accuracy	standard	$\pm 5 \times 10^{-7}$
	with R&S®ZNB-B4 precision frequency reference option	$\pm 5 \times 10^{-8}$

Frequency resolution		1 Hz
Number of measurement points	per trace	1 to 100 001
Measurement bandwidth	1/1.5/2/3/5/7 steps	
	without optional increased bandwidth	1 Hz to 1 MHz
	with optional increased bandwidth	1 Hz to 10 MHz

<sup>1</sup> Specified and typical data given in this data sheet applies to the R&S®ZNB4, the R&S®ZNB8, the R&S®ZNB20 and the R&S®ZNB40; please note their respective frequency ranges.

Parameter	Frequency range	Specification	Typical
Dynamic range <sup>2</sup> of the R&S®ZNB4 and the R&S®ZNB8 (without options)	9 kHz to 100 kHz	≥ 100 dB	122 dB
	100 kHz to 50 MHz	≥ 120 dB	138 dB
	50 MHz to 4 GHz	≥ 130 dB	140 dB
	4 GHz to 7 GHz	≥ 125 dB	138 dB
	7 GHz to 8.5 GHz	≥ 120 dB	130 dB
Dynamic range <sup>2</sup> of the R&S®ZNB20	100 kHz to 1 MHz	≥ 100 dB	110 dB
	1 MHz to 10 MHz	≥ 110 dB	120 dB
	10 MHz to 100 MHz	≥ 115 dB	125 dB
	100 MHz to 6 GHz	≥ 125 dB	135 dB
	6 GHz to 20 GHz	≥ 120 dB	130 dB
Dynamic range <sup>2</sup> of the R&S®ZNB40 model .72	10 MHz to 50 MHz	≥ 90 dB	105 dB
	50 MHz to 100 MHz	≥ 115 dB	125 dB
	100 MHz to 500 MHz	≥ 120 dB	130 dB
	500 MHz to 20 GHz	≥ 125 dB	135 dB
	20 GHz to 30 GHz	≥ 115 dB	125 dB
	30 GHz to 40 GHz	≥ 110 dB	120 dB
Dynamic range <sup>2</sup> of the R&S®ZNB40 model .82 and .84	100 kHz to 1 MHz	≥ 105 dB	120 dB
	1 MHz to 10 MHz	≥ 110 dB	130 dB
	10 MHz to 5 GHz	≥ 120 dB	135 dB
	5 GHz to 10 GHz	≥ 115 dB	125 dB
	10 GHz to 30 GHz	≥ 110 dB	120 dB
	30 GHz to 35 GHz	≥ 105 dB	115 dB
	35 GHz to 38 GHz	≥ 100 dB	105 dB
	38 GHz to 40 GHz	≥ 95 dB	100 dB

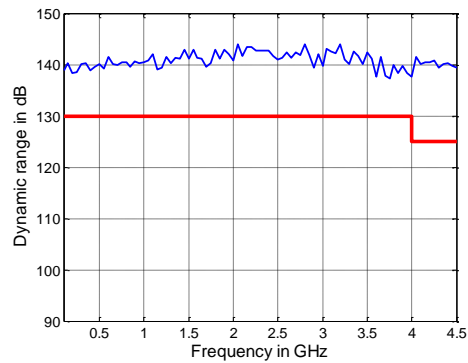
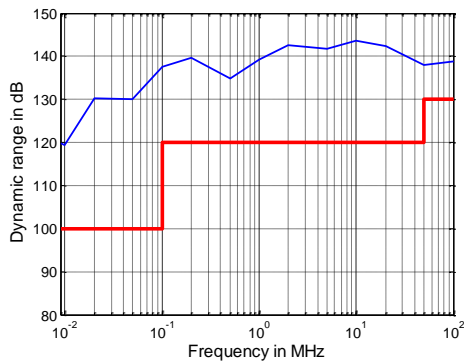

Dynamic range in dB versus frequency for the R&S®ZNB4

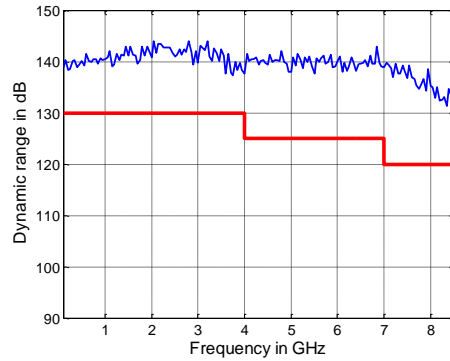
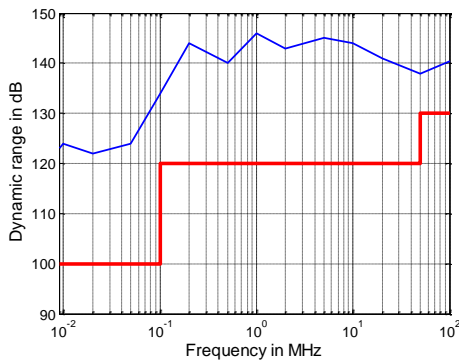

Dynamic range in dB versus frequency for the R&S®ZNB8

<sup>2</sup> The dynamic range is defined as the difference between the actual maximum source power and the RMS value of the data trace of the transmission magnitude, which is produced by noise and crosstalk with the test ports short-circuited. The specification applies at 10 Hz measurement bandwidth, without system error correction. The dynamic range can be increased by using a measurement bandwidth of 1 Hz. Crosstalk does not limit the dynamic range. Dynamic range between port 1 and port 2 and between port 3 and port 4 (4-port model). Otherwise the dynamic range performance is typical.

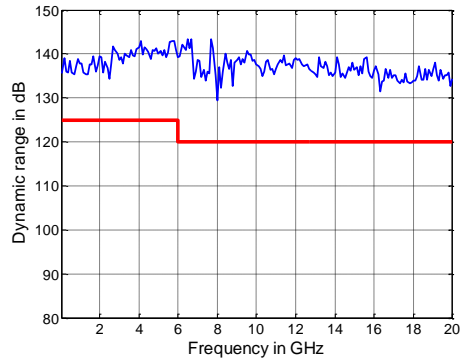
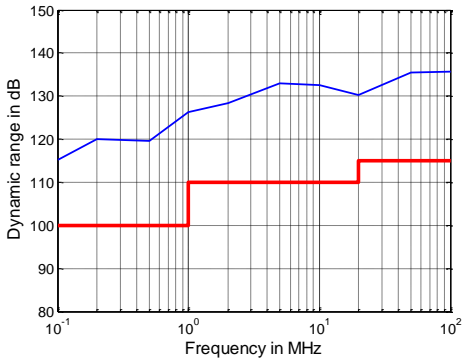

Dynamic range in dB versus frequency for the R&S®ZNB20

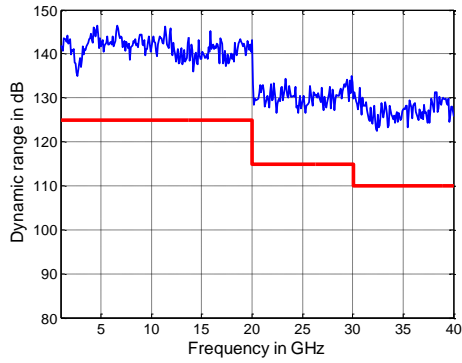
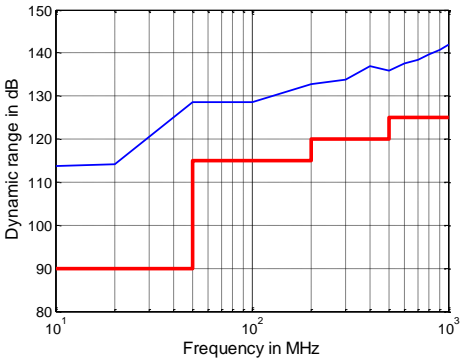

Dynamic range in dB versus frequency for the R&S®ZNB40 model .72

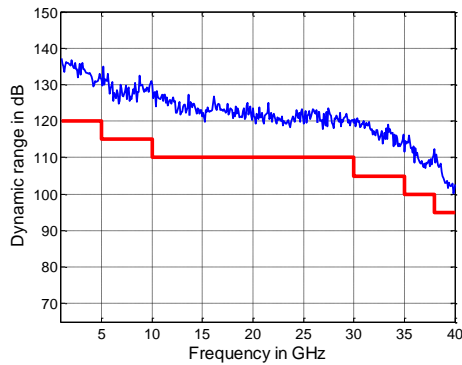
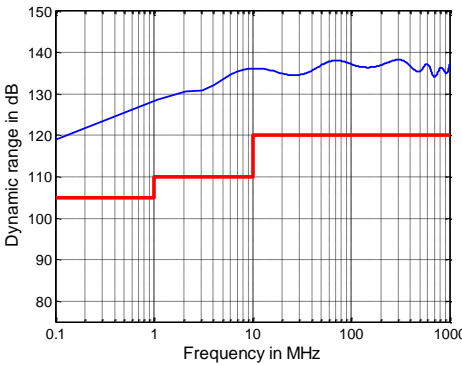

Dynamic range in dB versus frequency for the R&S®ZNB40 model .82 and .84

# Measurement speed

Measured with firmware version 3.15 and Windows 10.

Measurement time	for 201 measurements points, with 200 MHz span, 1 MHz measurement bandwidth				
		$T_{\text{SWEEP}}$	$T_{\text{CYCLE}}$		
	with 900 MHz center frequency	< 1.5 ms	< 2.5 ms		
	with 5.1 GHz center frequency	< 1.3 ms	< 2 ms		
Acquisition time per point ( $T_{\text{ACQ}}$ )	1 MHz measurement bandwidth, CW mode	2.5 $\mu$ s			
Sampling time per point ( $T_{\text{SAMPLE}}$ ) IF filter: normal	at 1 MHz measurement bandwidth	860 ns			
	at 10 MHz measurement bandwidth	312 ns			
Time for measurement and data transfer	for 201 measurements points, with 800 MHz start frequency, 1 GHz stop frequency, 1 MHz measurement bandwidth <sup>3</sup>	VXI11	HiSLIP	IEC/IEEE	USB 3.0
		over 1 Gbit/s LAN			
		3.8 ms	3.5 ms	4.0 ms	3.0 ms
Data transfer time	for 201 measurements points (magnitude)	1.0 ms	0.8 ms	1.5 ms	0.5 ms
Switching time between channels	with a maximum of 2001 points	< 5 ms			
Switching time between two preloaded instrument settings	with a maximum of 2001 points	< 5 ms			

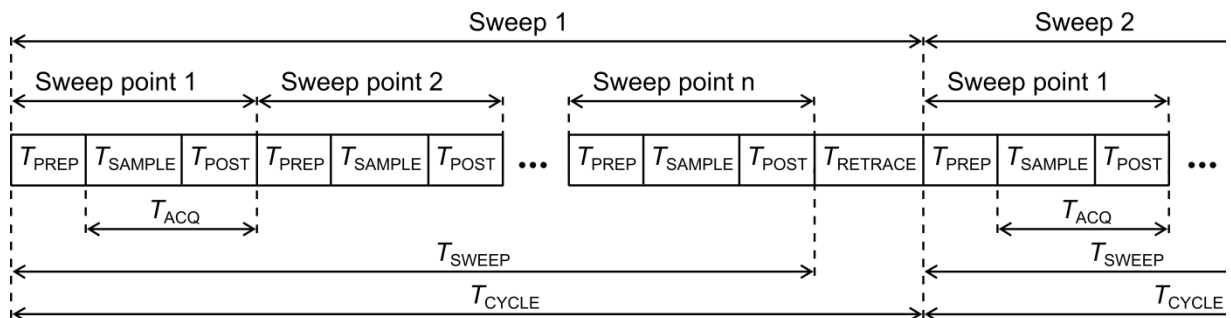

- $T_{\text{PREP}}$  Preparation time required to set up the internal hardware components
- $T_{\text{SAMPLE}}$  Sampling time (approximately equal to the settling time of the digital filters)
- $T_{\text{POST}}$  Time required for hardware postprocessing
- $T_{\text{ACQ}}$  Acquisition time ( $T_{\text{SAMPLE}} + T_{\text{POST}}$ )
- $T_{\text{SWEEP}}$  Time required for one sweep
- $T_{\text{RETRACE}}$  Time between two sweeps
- $T_{\text{CYCLE}}$  Sweep cycle time ( $T_{\text{SWEEP}} + T_{\text{RETRACE}}$ )

Measurement sequence

<sup>3</sup> In continuous mode, no additional time is needed for data transfer as this occurs simultaneously during the measurement.

Typical sweep times in ms versus number of measurement points <sup>4</sup> of the R&S®ZNB4 and the R&S®ZNB8										
Number of measurement points	51		201		401		1601		5001	
Sweep mode (stepped, swept)	swept	step	swept	step	swept	step	swept	step	swept	step
800 MHz start frequency, 1 GHz stop frequency, AGC AUTO, 500 kHz measurement bandwidth										
With correction switched off	0.7	1.2	1.2	3.0	1.8	3.6	5.0	6.5	13.8	17.0
With 2-port TOSM calibration	1.0	1.9	2.1	5.4	3.6	6.6	10.1	12.0	27.0	32.5
With 4-port TOSM calibration	1.7	3.5	4.6	10.5	6.9	12.5	20.5	25.0	56.0	65.0
800 MHz start frequency, 1 GHz stop frequency, AGC LOW DIST, 1 kHz measurement bandwidth										
With correction switched off	46.1	46.1	180	180	358	358	1377	1377	4299	4298
With 2-port TOSM calibration	91.9	91.9	359	359	716	716	2753	2753	8597	8597
With 4-port TOSM calibration	184	184	719	719	1431	1431	5507	5507	17194	17194
1 MHz start frequency, 4.5 GHz stop frequency, AGC AUTO, 500 kHz measurement bandwidth										
With correction switched off	2.3	2.4	4.1	4.2	3.8	6.5	7.2	18.8	16.4	49.0
With 2-port TOSM calibration	4.3	4.4	8.1	8.2	7.1	12.6	14.1	36.9	32.6	98.0
With 4-port TOSM calibration	8.2	8.4	16.0	16.1	13.9	24.8	28.5	73.5	64.8	196
1 MHz start frequency, 4.5 GHz stop frequency, AGC LOW DIST, 1 kHz measurement bandwidth										
With correction switched off	49.1	49.2	181	182	358	358	1414	1414	4407	4407
With 2-port TOSM calibration	97.9	98.1	362	363	715	716	2829	2830	8813	8813
With 4-port TOSM calibration	196	196	724	726	1430	1431	5658	5658	17626	17626
1 MHz start frequency, 8.5 GHz stop frequency, AGC AUTO, 500 kHz measurement bandwidth										
With correction switched off	2.6	2.7	4.5	4.6	6.7	6.8	7.9	18.8	16.7	50.0
With 2-port TOSM calibration	4.8	5.0	8.8	8.9	13.1	13.2	16.0	37.0	33.8	99.0
With 4-port TOSM calibration	9.6	9.6	17.2	17.3	26.2	26.5	32.5	74.0	68.0	198
1 MHz start frequency, 8.5 GHz stop frequency, AGC LOW DIST, 1 kHz measurement bandwidth										
With correction switched off	50.5	50.6	183	183	359	359	1414	1415	4399	4402
With 2-port TOSM calibration	101	101	365	367	717	719	2828	2830	8799	8802
With 4-port TOSM calibration	201	202	730	733	1434	1438	5654	5659	17598	17604

<sup>4</sup> Sweep time is to be understood as cycle time; static frequency accuracy of the instrument applies; measured with firmware version 3.15, Windows 10.



Typical sweep times in ms versus number of measurement points <sup>4</sup> of the R&S®ZNB20 and the R&S®ZNB40										
Number of measurement points	51		201		401		1601		5001	
Sweep mode (stepped, swept)	swept	step	swept	step	swept	step	swept	step	swept	step
9 GHz start frequency, 10 GHz stop frequency, AGC AUTO, 500 kHz measurement bandwidth										
With correction switched off	1	1	1.4	2.4	2.1	4.0	5.3	10.4	14.1	17.8
With 2-port TOSM calibration	2.6	2.6	3.5	5.2	4.6	8.6	11.5	21.0	29.1	42.0
With 4-port TOSM calibration	5.7	5.8	7.5	10.7	10.3	17.2	24.5	42.0	59.2	111
9 GHz start frequency, 10 GHz stop frequency, AGC LOW DIST, 1 kHz measurement bandwidth										
With correction switched off	45.1	45.3	176	176	350	352	1396	1396	4310	4310
With 2-port TOSM calibration	90.7	90.9	352	352	701	701	2793	2793	8619	8620
With 4-port TOSM calibration	182	182	704	706	1405	1405	5580	5580	17240	17240
1 MHz start frequency, 20 GHz stop frequency, AGC AUTO, 500 kHz measurement bandwidth										
With correction switched off	11.9	12.0	16.4	16.5	19.2	19.4	29.8	29.8	34.5	57.5
With 2-port TOSM calibration	24.5	24.5	33.5	33.6	39.2	39.2	60.0	60.0	68.0	115
With 4-port TOSM calibration	49.4	49.4	68.1	67.5	79.0	78.9	121	121	139	231
1 MHz start frequency, 20 GHz stop frequency, AGC LOW DIST, 1 kHz measurement bandwidth										
With correction switched off	55.7	55.8	190	190	365	365	1410	1415	4380	4380
With 2-port TOSM calibration	111	112	380	381	730	732	2830	2830	8750	8760
With 4-port TOSM calibration	224	225	760	766	1460	1470	5660	5650	17500	17510
1 MHz <sup>1</sup> start frequency, 40 GHz stop frequency, AGC AUTO, 500 kHz measurement bandwidth										
With correction switched off	13.6	13.6	18.7	18.7	21.8	21.8	33.1	33.1	39.6	62.2
With 2-port TOSM calibration	28.0	28.0	37.9	37.9	43.5	43.5	66.8	66.8	82.8	122
With 4-port TOSM calibration	56	56	79	79	93	93	138	138	170	250
1 MHz <sup>1</sup> start frequency, 40 GHz stop frequency, AGC LOW DIST, 1 kHz measurement bandwidth										
With correction switched off	57.5	57.5	191	193	367	369	1415	1415	4370	4380
With 2-port TOSM calibration	115	115	384	386	734	736	2830	2830	8759	8760
With 4-port TOSM calibration	230	230	770	770	1480	1480	5650	5650	17500	17500

# Measurement accuracy of the R&S®ZNB4 and the R&S®ZNB8

This data is valid between +18 °C and +28 °C, provided the temperature has not varied by more than 1 °C since calibration. Validity of the data is conditional on the use of an R&S®ZV-Z270 calibration kit. This calibration kit is used to achieve the effective system data specified below. Frequency points, measurement bandwidth and sweep time have to be identical for measurement and calibration (no interpolation allowed).

Uncertainty of transmission measurements		Magnitude	Phase
> 9 kHz to 100 kHz	+0 dB to -35 dB	0.07 dB	0.6°
	-35 dB to -50 dB	0.12 dB	1.0°
	-50 dB to -60 dB	0.32 dB	2.3°
> 100 kHz to 8.5 GHz	+0 dB to -35 dB	0.06 dB	0.6°
	-35 dB to -50 dB	0.09 dB	0.9°
	-50 dB to -60 dB	0.19 dB	1.5°

Specifications are based on a matched DUT, a measurement bandwidth of 10 Hz and a nominal source power of -10 dBm.

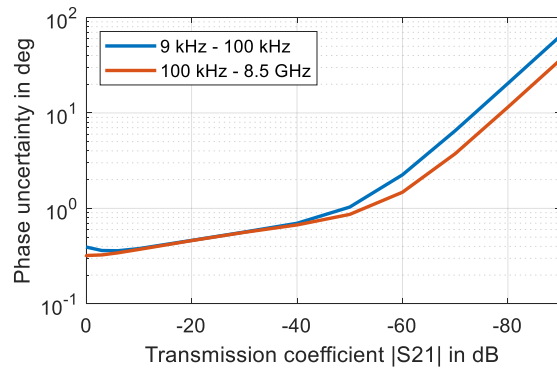
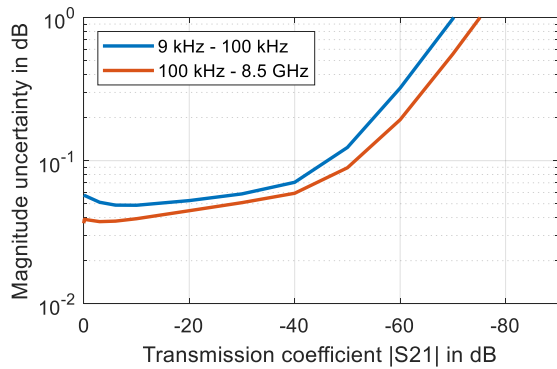

Uncertainty of transmission magnitude and transmission phase measurements for the R&S®ZNB4 in the frequency range from 9 kHz to 4.5 GHz, for the R&S®ZNB8 in the frequency range from 9 kHz to 8.5 GHz; analysis conditions:  $S_{11} = S_{22} = 0$ , cal. power -10 dBm, meas. power -10 dBm

Uncertainty of reflection measurements	Logarithmic			Linear	
	Reflection level	Magnitude	Phase	Reflection range	Magnitude
9 kHz to 2 GHz	0 dB	0.1 dB	0.6°	0 dB to -15 dB	0.010
	-15 dB	0.2 dB	1.5°	-15 dB to -25 dB	0.005
	-25 dB	0.7 dB	5.6°	-25 dB to -35 dB	0.005
> 2 GHz to 8.5 GHz	0 dB	0.1 dB	0.9°	0 dB to -15 dB	0.015
	-15 dB	0.3 dB	2.0°	-15 dB to -25 dB	0.007
	-25 dB	1.0 dB	7.5°	-25 dB	0.007

Specifications are based on an isolating DUT, a measurement bandwidth of 10 Hz and a nominal source power of -10 dBm.

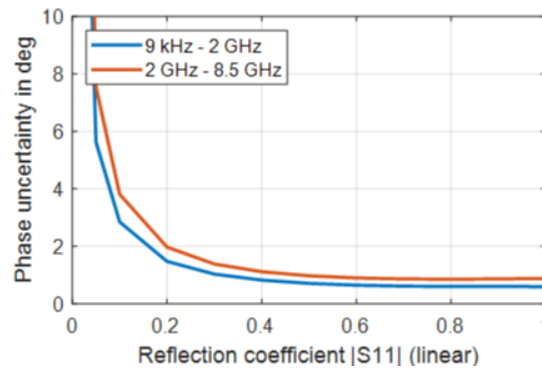
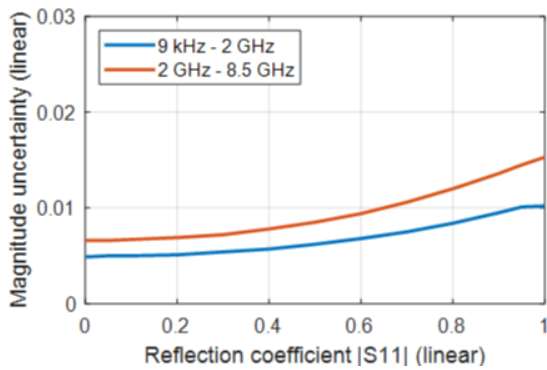

Uncertainty of reflection magnitude and reflection phase measurements for the R&S®ZNB4 in the frequency range from 9 kHz to 4.5 GHz, for the R&S®ZNB8 in the frequency range from 9 kHz to 8.5 GHz; analysis conditions:  $S_{12} = S_{21} = 0$ , cal. power -10 dBm, meas. power -10 dBm

# Measurement accuracy of the R&S®ZNB20

This data is valid between +18 °C and +28 °C, provided the temperature has not varied by more than 1 °C since calibration. Validity of the data is conditional on the use of an R&S®ZV-Z235 calibration kit. This calibration kit is used to achieve the effective system data specified below. Frequency points, measurement bandwidth and sweep time have to be identical for measurement and calibration (no interpolation allowed).

Uncertainty of transmission measurements		Magnitude	Phase
100 kHz to 1 MHz	+0 dB to -35 dB	0.09 dB	0.7°
	-35 dB to -50 dB	0.32 dB	2.2°
	-50 dB to -60 dB	0.98 dB	6.5°
> 1 MHz to 10 GHz	+0 dB to -35 dB	0.07 dB	0.7°
	-35 dB to -50 dB	0.19 dB	1.4°
	-50 dB to -60 dB	0.56 dB	3.7°
> 10 GHz to 20 GHz	+0 dB to -35 dB	0.07 dB	0.8°
	-35 dB to -50 dB	0.09 dB	1.0°
	-50 dB to -60 dB	0.20 dB	1.6°

Specifications are based on a matched DUT, a measurement bandwidth of 10 Hz and a nominal source power of -10 dBm.

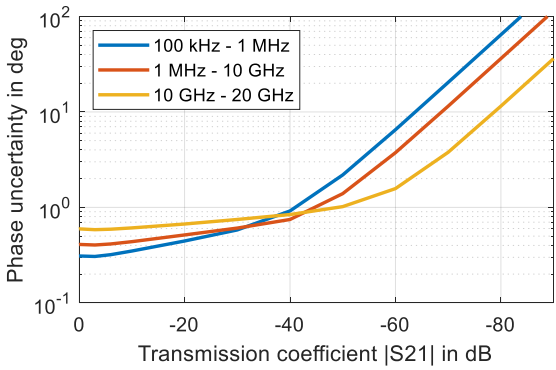
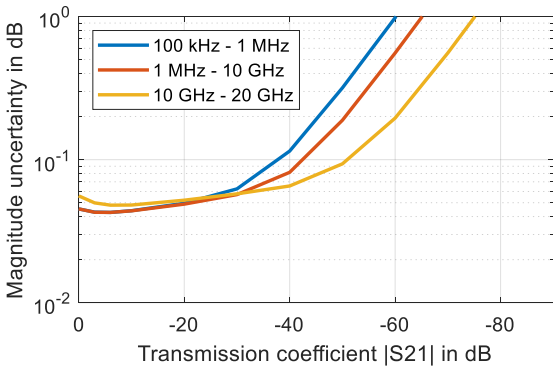

Uncertainty of transmission magnitude and transmission phase measurements for the R&S®ZNB20 in the frequency range from 100 kHz to 20 GHz; analysis conditions:  $S_{11} = S_{22} = 0$ , cal. power -10 dBm, meas. power -10 dBm

Uncertainty of reflection measurements	Logarithmic			Linear	
	Reflection level	Magnitude	Phase	Reflection range	Magnitude
100 kHz to 10 GHz	0 dB	0.10 dB	0.7°	0 dB to -15 dB	0.013
	-15 dB	0.30 dB	2.0°	-15 dB to -25 dB	0.007
	-25 dB	1.00 dB	7.7°	-25 dB to -35 dB	0.007
> 10 GHz to 20 GHz	0 dB	0.20 dB	1.1°	0 dB to -15 dB	0.019
	-15 dB	0.40 dB	2.4°	-15 dB to -25 dB	0.008
	-25 dB	1.20 dB	9.1°	-25 dB to -35 dB	0.008

Specifications are based on an isolating DUT, a measurement bandwidth of 10 Hz and a nominal source power of -10 dBm.

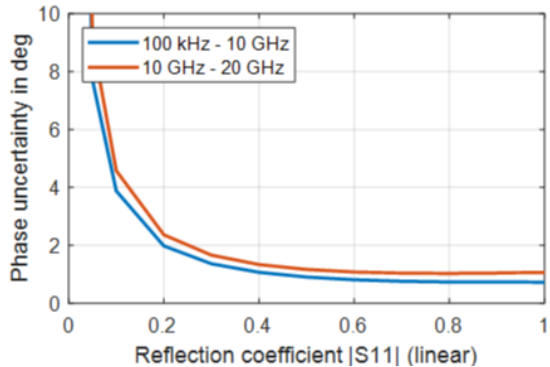
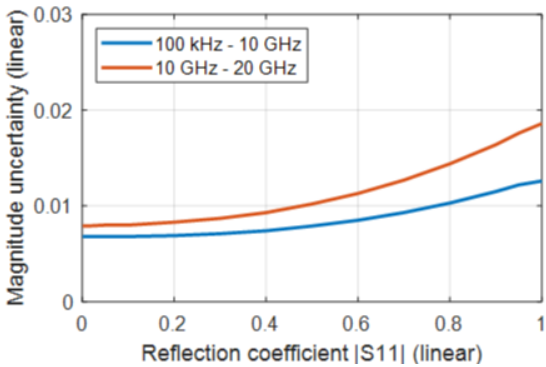

Uncertainty of reflection magnitude and reflection phase measurements for the R&S®ZNB20 in the frequency range from 100 kHz to 20 GHz; analysis conditions:  $S_{12} = S_{21} = 0$ , cal. power -10 dBm, meas. power -10 dBm

## Measurement accuracy of the R&S®ZNB40 model .72

This data is valid between +18 °C and +28 °C, provided the temperature has not varied by more than 1 °C since calibration. Validity of the data is conditional on the use of an R&S®ZV-Z229 calibration kit. This calibration kit is used to achieve the effective system data specified below. Frequency points, measurement bandwidth and sweep time have to be identical for measurement and calibration (no interpolation allowed).

Uncertainty of transmission measurements		Magnitude	Phase
10 MHz to 200 MHz	0 dB to -35 dB	0.13 dB	1.0°
	-35 dB to -50 dB	0.55 dB	3.7°
	-50 dB to -60 dB	1.74 dB	12°
> 200 MHz to 20 GHz	0 dB to -35 dB	0.07 dB	0.8°
	-35 dB to -50 dB	0.12 dB	1.0°
	-50 dB to -60 dB	0.32 dB	2.2°
> 20 GHz to 40 GHz	0 dB to -35 dB	0.11 dB	1.1°
	-35 dB to -50 dB	0.15 dB	1.4°
	-50 dB to -60 dB	0.33 dB	2.4°

Specifications are based on a matched DUT, a measurement bandwidth of 10 Hz and a nominal source power of -10 dBm.

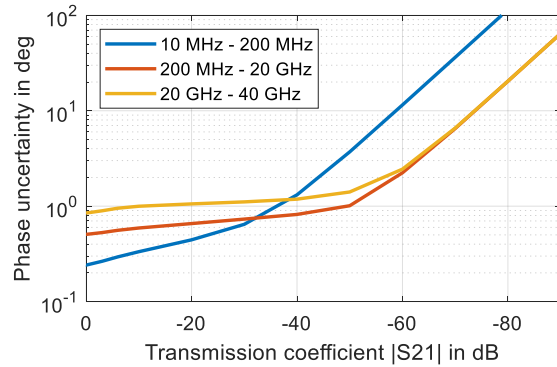
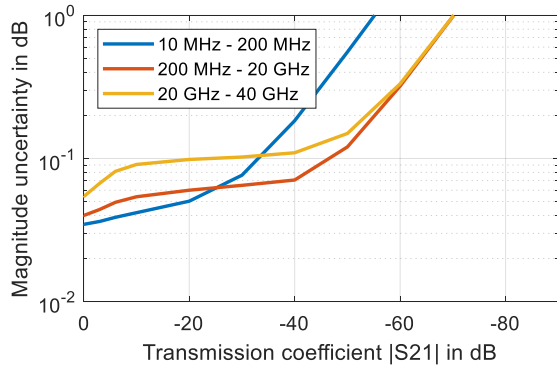

Uncertainty of transmission magnitude and transmission phase measurements for the R&S®ZNB40 model .72 in the frequency range from 10 MHz to 40 GHz; analysis conditions:  $S_{11} = S_{22} = 0$ , cal. power -10 dBm, meas. power -10 dBm

Uncertainty of reflection measurements	Logarithmic			Linear	
	Reflection level	Magnitude	Phase	Reflection range	Magnitude
10 MHz to 4 GHz	0 dB	0.1 dB	0.7°	0 dB to -15 dB	0.012
	-15 dB	0.3 dB	1.7°	-15 dB to -25 dB	0.006
	-25 dB	0.9 dB	6.6°	-25 dB	0.006
> 4 GHz to 20 GHz	0 dB	0.2 dB	1.1°	0 dB to -15 dB	0.020
	-15 dB	0.5 dB	2.7°	-15 dB to -25 dB	0.010
	-25 dB	1.3 dB	11°	-25 dB	0.009
> 20 GHz to 40 GHz	0 dB	0.2 dB	1.6°	0 dB to -15 dB	0.028
	-15 dB	0.6 dB	3.7°	-15 dB to -25 dB	0.013
	-25 dB	1.8 dB	14°	-25 dB	0.013

Specifications are based on an isolating DUT, a measurement bandwidth of 10 Hz and a nominal source power of -10 dBm.

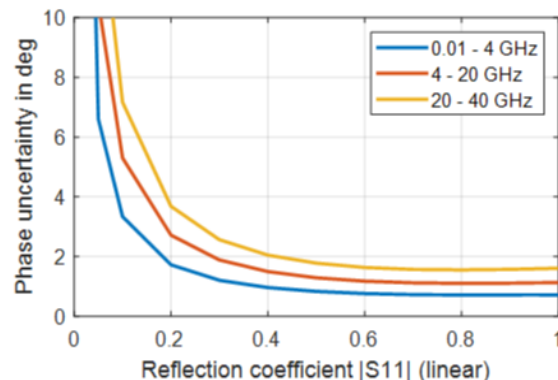
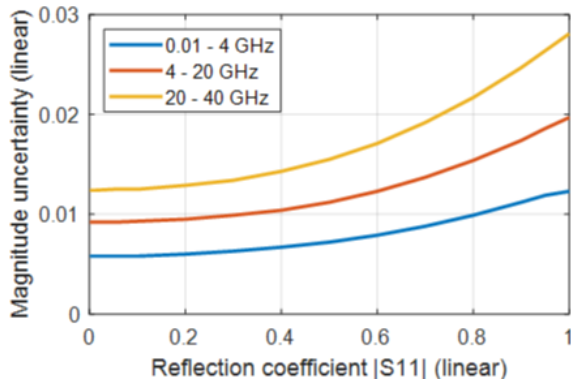

Uncertainty of reflection magnitude and reflection phase measurements for the R&S®ZNB40 model .72 in the frequency range from 10 MHz to 40 GHz; analysis conditions:  $S_{12} = S_{21} = 0$ , cal. power -10 dBm, meas. power -10 dBm

## Measurement accuracy of the R&S®ZNB40 model .82 and .84

This data is valid between +18 °C and +28 °C, provided the temperature has not varied by more than 1 °C since calibration. Validity of the data is conditional on the use of an R&S®ZV-Z229 calibration kit. This calibration kit is used to achieve the effective system data specified below. Frequency points, measurement bandwidth and sweep time have to be identical for measurement and calibration (no interpolation allowed).

Uncertainty of transmission measurements		Magnitude	Phase
100 kHz to 200 MHz	0 dB to -35 dB	0.06 dB	0.6°
	-35 dB to -50 dB	0.09 dB	0.9°
	-50 dB to -60 dB	0.19 dB	1.5°
> 200 MHz to 10 GHz	0 dB to -35 dB	0.06 dB	0.7°
	-35 dB to -50 dB	0.10 dB	1.0°
	-50 dB to -60 dB	0.23 dB	1.7°
> 10 GHz to 20 GHz	0 dB to -35 dB	0.06 dB	0.8°
	-35 dB to -50 dB	0.10 dB	1.1°
	-50 dB to -60 dB	0.24 dB	1.8°
> 20 GHz to 35 GHz	0 dB to -35 dB	0.07 dB	1.2°
	-35 dB to -50 dB	0.13 dB	1.5°
	-50 dB to -60 dB	0.32 dB	2.5°
> 35 GHz to 40 GHz	0 dB to -35 dB	0.10 dB	1.3°
	-35 dB to -50 dB	0.32 dB	2.5°
	-50 dB to -60 dB	0.98 dB	6.6°

Specifications are based on a matched DUT, a measurement bandwidth of 10 Hz and a nominal source power of -10 dBm.

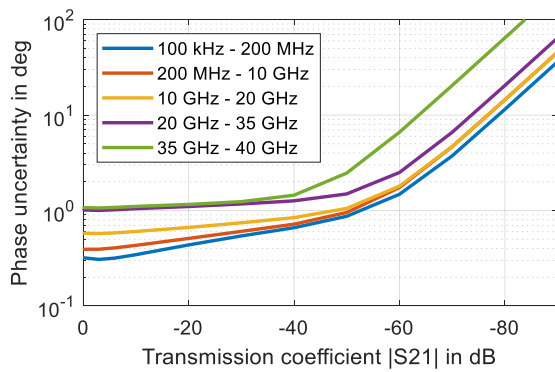
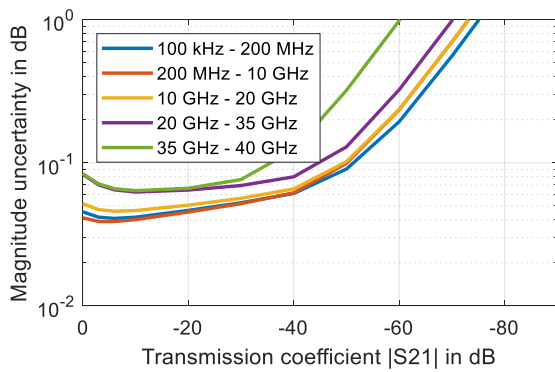

Uncertainty of transmission magnitude and transmission phase measurements for the R&S®ZNB40 model .82 and .84 in the frequency range from 100 kHz to 40 GHz; analysis conditions:  $S_{11} = S_{22} = 0$ , cal. power -10 dBm, meas. power -10 dBm

Uncertainty of reflection measurements	Logarithmic			Linear	
	Reflection level	Magnitude	Phase	Reflection range	Magnitude (lin)
100 kHz to 10 GHz	0 dB	0.10 dB	0.7°	0 dB to -15 dB	0.012
	-15 dB	0.29 dB	1.7°	-15 dB to -25 dB	0.006
	-25 dB	0.88 dB	6.6°	-25 dB to -35 dB	0.006
> 10 GHz to 20 GHz	0 dB	0.17 dB	1.1°	0 dB to -15 dB	0.020
	-15 dB	0.48 dB	2.7°	-15 dB to -25 dB	0.010
	-25 dB	1.29 dB	11°	-25 dB to -35 dB	0.009
> 20 GHz to 40 GHz	0 dB	0.24 dB	1.6°	0 dB to -15 dB	0.028
	-15 dB	0.61 dB	3.7°	-15 dB to -25 dB	0.013
	-25 dB	1.81 dB	14°	-25 dB to -35 dB	0.013

Specifications are based on an isolating DUT, a measurement bandwidth of 10 Hz and a nominal source power of -10 dBm.

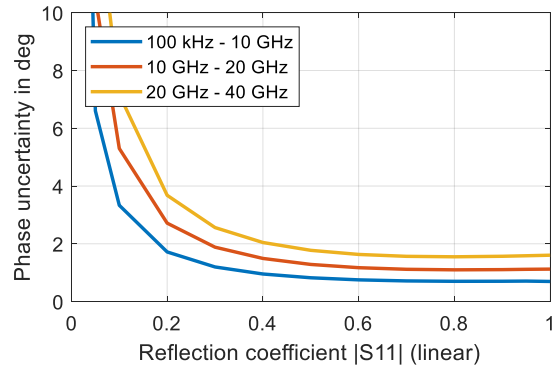
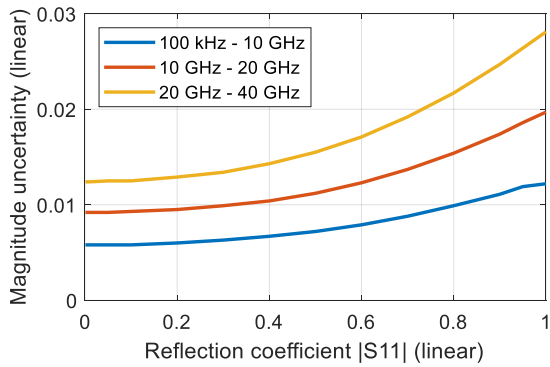

Uncertainty of reflection magnitude and reflection phase measurements for the R&S®ZNB40 model .82 and .84 in the frequency range from 100 kHz to 40 GHz; analysis conditions:  $S_{12} = S_{21} = 0$ , cal. power -10 dBm, meas. power -10 dBm

## Effective system data

This data is valid between +18 °C and +28 °C, provided the temperature has not varied by more than 1 °C since calibration. Frequency points, measurement bandwidth and sweep time have to be identical for measurement and calibration (no interpolation allowed). The data is based on a measurement bandwidth of 10 Hz.

<b>R&amp;S®ZNB4 and R&amp;S®ZNB8 calibrated using R&amp;S®ZV-Z270</b>	<b>9 kHz to 100 kHz</b>	<b>100 kHz to 4.5 GHz</b>	<b>4.5 GHz to 8.5 GHz</b>
Directivity	≥ 46 dB	≥ 45 dB	≥ 40 dB
Source match	≥ 41 dB	≥ 40 dB	≥ 36 dB
Load match	≥ 44 dB	≥ 45 dB	≥ 40 dB
Reflection tracking	≤ 0.02 dB	≤ 0.02 dB	≤ 0.05 dB
Transmission tracking	≤ 0.028 dB	≤ 0.018 dB	≤ 0.09 dB

<b>R&amp;S®ZNB20 calibrated using R&amp;S®ZV-Z235</b>	<b>100 kHz to 10 GHz</b>	<b>10 GHz to 20 GHz</b>
Directivity	≥ 46 dB	≥ 41 dB
Source match	≥ 43 dB	≥ 38 dB
Load match	≥ 44 dB	≥ 40 dB
Reflection tracking	≤ 0.05 dB	≤ 0.05 dB
Transmission tracking	≤ 0.025 dB	≤ 0.035 dB

<b>R&amp;S®ZNB40 calibrated using R&amp;S®ZV-Z229</b>	<b>100 kHz to 4 GHz</b>	<b>4 GHz to 20 GHz</b>	<b>20 GHz to 40 GHz</b>
Directivity	≥ 42 dB	≥ 38 dB	≥ 34 dB
Source match	≥ 38 dB	≥ 36 dB	≥ 32 dB
Load match	≥ 40 dB	≥ 38 dB	≥ 35 dB
Reflection tracking	≤ 0.05 dB	≤ 0.05 dB	≤ 0.08 dB
Transmission tracking	≤ 0.02 dB	≤ 0.03 dB	≤ 0.06 dB

## Factory-calibrated system data

This data is valid between +18 °C and +28 °C. It is based on a source power of -10 dBm and a measurement bandwidth of 1 kHz.

Parameter	Frequency range	Specification	Typical
<b>Directivity</b>	9 kHz to 50 kHz	≥ 20 dB	35 dB
	50 kHz to 4.5 GHz	≥ 30 dB	50 dB
	4.5 GHz to 10 GHz	≥ 30 dB	50 dB
	10 GHz to 20 GHz	≥ 25 dB	35 dB
	20 GHz to 35 GHz	≥ 20 dB	20 dB
	35 GHz to 40 GHz	≥ 15 dB	20 dB
<b>Source match</b>	9 kHz to 50 kHz	≥ 20 dB	35 dB
	50 kHz to 4.5 GHz	≥ 30 dB	50 dB
	4.5 GHz to 10 GHz	≥ 30 dB	50 dB
	10 GHz to 20 GHz	≥ 25 dB	35 dB
	20 GHz to 35 GHz	≥ 20 dB	20 dB
	35 GHz to 40 GHz	≥ 15 dB	20 dB
<b>Reflection tracking</b>	9 kHz to 20 GHz	≤ 0.5 dB	0.1 dB
	20 GHz to 40 GHz	≤ 0.5 dB	0.1 dB
<b>Transmission tracking</b>	9 kHz to 20 GHz	≤ 0.5 dB	0.1 dB
	20 GHz to 40 GHz	≤ 0.5 dB	0.1 dB
<b>Load match</b>			
Load match of the R&S®ZNB4 and the R&S®ZNB8	9 kHz to 50 kHz	≥ 10 dB	15 dB
	50 kHz to 8.5 GHz	≥ 20 dB	25 dB
Load match of the R&S®ZNB20	100 kHz to 1 MHz	≥ 16 dB	20 dB
	1 MHz to 2 GHz	≥ 20 dB	23 dB
	2 GHz to 20 GHz	≥ 16 dB	19 dB
Load match of the R&S®ZNB40 model .72	10 MHz to 50 MHz	≥ 15 dB	18 dB
	50 MHz to 2 GHz	≥ 20 dB	22 dB
	2 GHz to 6 GHz	≥ 16 dB	18 dB
	6 GHz to 10 GHz	≥ 12 dB	14 dB
	10 GHz to 20 GHz	≥ 10 dB	12 dB
	20 GHz to 40 GHz	≥ 8 dB	10 dB
Load match of the R&S®ZNB40 model .82 and .84	100 kHz to 300 kHz	≥ 12 dB	15 dB
	300 kHz to 10 MHz	≥ 15 dB	18 dB
	10 MHz to 20 GHz	≥ 18 dB	22 dB
	20 GHz to 40 GHz	≥ 15 dB	20 dB

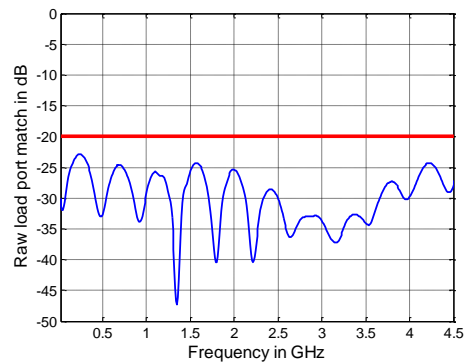
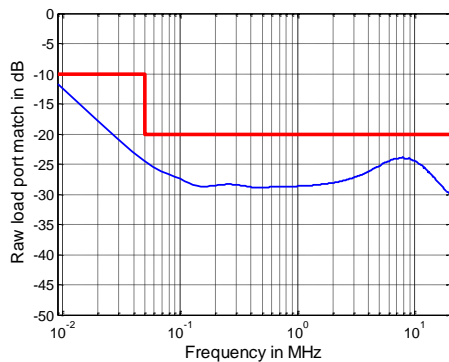

Raw load port match versus frequency for the R&S®ZNB4



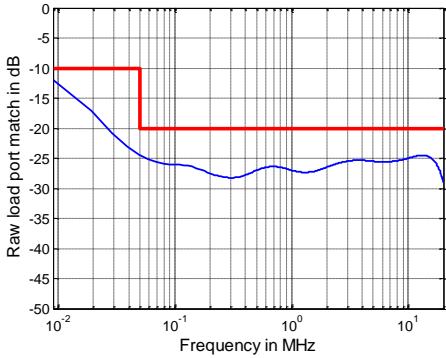

Raw load port match versus frequency for the R&S<sup>®</sup>ZNB8

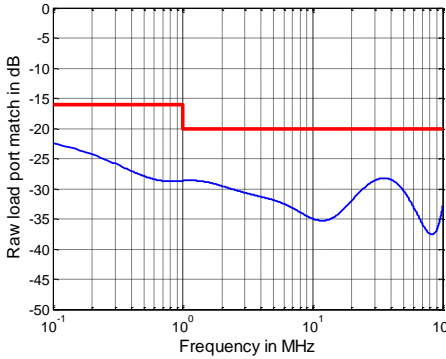
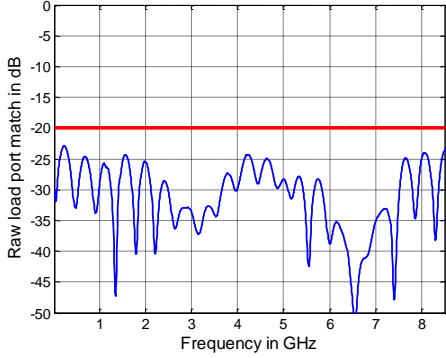

Raw load port match versus frequency for the R&S<sup>®</sup>ZNB20

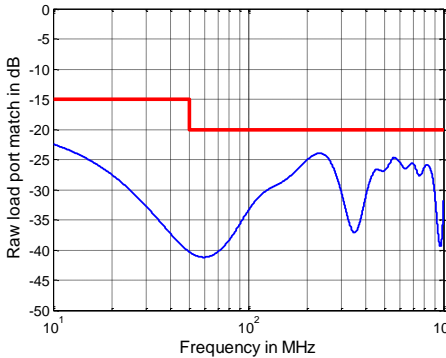
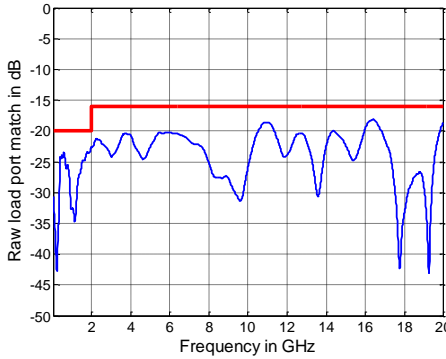

Raw load port match versus frequency for the R&S<sup>®</sup>ZNB40 model .72

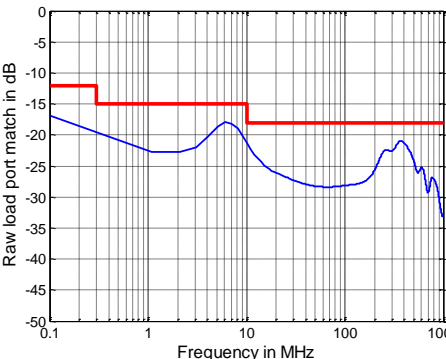
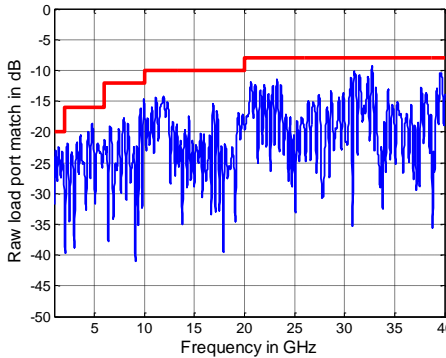

Raw load port match versus frequency for the R&S<sup>®</sup>ZNB40 model .82 and .84

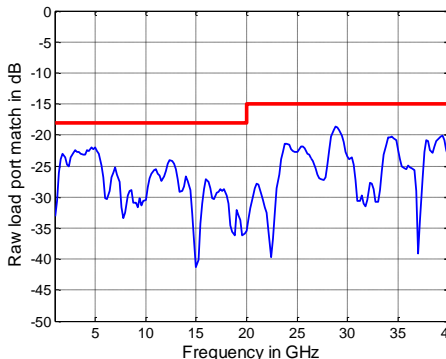

Trace stability			Specification	Typical
Trace noise magnitude (RMS) of the R&S®ZNB4 and the R&S®ZNB8	at 0 dBm source power, 0 dB reflection	IF bandwidth		
	9 kHz to 20 kHz	1 kHz	≤ 0.008 dB	0.004 dB
	20 kHz to 100 kHz	1 kHz	≤ 0.004 dB	0.001 dB
	100 kHz to 100 MHz	10 kHz	≤ 0.004 dB	0.001 dB
Trace noise magnitude (RMS) of the R&S®ZNB20	100 MHz to 8.5 GHz	10 kHz	≤ 0.004 dB	0.002 dB
	at 0 dBm source power, 0 dB reflection			
Trace noise magnitude (RMS) of the R&S®ZNB40 model .72	100 kHz to 300 kHz	10 kHz	≤ 0.008 dB	0.002 dB
	300 kHz to 20 GHz	10 kHz	≤ 0.004 dB	0.001 dB
	10 MHz to 50 MHz	10 kHz	≤ 0.040 dB	0.020 dB
	50 MHz to 500 MHz	10 kHz	≤ 0.015 dB	0.006 dB
Trace noise magnitude (RMS) of the R&S®ZNB40 model .82 and .84 <sup>5</sup>	500 MHz to 20 GHz	10 kHz	≤ 0.004 dB	0.002 dB
	20 GHz to 30 GHz	10 kHz	≤ 0.015 dB	0.006 dB
	30 GHz to 40 GHz	10 kHz	≤ 0.020 dB	0.012 dB
	20 GHz to 35 GHz	10 kHz	≤ 0.006 dB	0.003 dB
Trace noise phase (RMS) of the R&S®ZNB4 and the R&S®ZNB8	35 GHz to 40 GHz	10 kHz	≤ 0.008 dB	0.005 dB
	at 0 dBm source power, 0 dB reflection			
	9 kHz to 20 kHz	1 kHz	≤ 0.070°	0.040°
	20 kHz to 100 kHz	1 kHz	≤ 0.035°	0.010°
Trace noise phase (RMS) of the R&S®ZNB20	100 kHz to 100 MHz	10 kHz	≤ 0.035°	0.005°
	100 MHz to 8.5 GHz	10 kHz	≤ 0.035°	0.020°
Trace noise phase (RMS) of the R&S®ZNB40 model .72	at 0 dBm source power, 0 dB reflection			
	100 kHz to 300 kHz	10 kHz	≤ 0.070°	0.02°
	300 kHz to 20 GHz	10 kHz	≤ 0.035°	0.01°
Trace noise phase (RMS) of the R&S®ZNB40 model .82 and .84	at 0 dBm source power, 0 dB reflection			
	10 MHz to 50 MHz	10 kHz	≤ 0.400°	0.2°
	50 MHz to 500 MHz	10 kHz	≤ 0.120°	0.06°
	500 MHz to 20 GHz	10 kHz	≤ 0.035°	0.02°
	20 GHz to 30 GHz	10 kHz	≤ 0.120°	0.06°
Temperature dependence	30 GHz to 40 GHz	10 kHz	≤ 0.200°	0.12°
	at 0 dB transmission or reflection			
	9 kHz to 4.5 GHz	magnitude		0.01 dB/K
		phase		0.15 °/K
4.5 GHz to 20 GHz	magnitude		0.04 dB/K	
	phase		0.80 °/K	
20 GHz to 40 GHz	magnitude		0.08 dB/K	
	phase		1.60 °/K	

<sup>5</sup> Between 1.5 MHz and 2.5 MHz, trace noise magnitude may slightly exceed the specified value.

# Test port output

This data is valid from +18 °C to +28 °C.

Parameter	Frequency range	Specification	Typical	
Power range of the R&S®ZNB4 and the R&S®ZNB8	without R&S®ZNB-B22/-B24 extended power range option			
	9 kHz to 100 MHz	-55 dBm to +10 dBm	up to +12 dBm	
	100 MHz to 2.5 GHz	-55 dBm to +13 dBm	up to +15 dBm	
	2.5 GHz to 7.5 GHz	-55 dBm to +10 dBm	up to +13 dBm	
	7.5 GHz to 8.5 GHz	-55 dBm to +8 dBm	up to +12 dBm	
	with R&S®ZNB-B22/-B24 extended power range option			
	9 kHz to 100 MHz	-85 dBm to +10 dBm	up to +12 dBm	
	100 MHz to 2.5 GHz	-85 dBm to +13 dBm	up to +15 dBm	
	2.5 GHz to 7.5 GHz	-85 dBm to +10 dBm	up to +13 dBm	
	7.5 GHz to 8.5 GHz	-85 dBm to +8 dBm	up to +12 dBm	
Power range of the R&S®ZNB20	without R&S®ZNB20-B22/-B24 extended power range option			
	100 kHz to 1 MHz	-30 dBm to +8 dBm	up to +10 dBm	
	1 MHz to 10 MHz	-30 dBm to +10 dBm	up to +12 dBm	
	10 MHz to 10 GHz	-30 dBm to +12 dBm	up to +14 dBm	
	10 GHz to 15 GHz	-30 dBm to +10 dBm	up to +12 dBm	
	15 GHz to 20 GHz	-30 dBm to +8 dBm	up to +10 dBm	
	with R&S®ZNB20-B22/-B24 extended power range option			
	100 kHz to 1 MHz	-60 dBm to +8 dBm	up to +10 dBm	
	1 MHz to 10 MHz	-60 dBm to +10 dBm	up to +12 dBm	
	10 MHz to 10 GHz	-60 dBm to +12 dBm	up to +14 dBm	
	10 GHz to 15 GHz	-60 dBm to +10 dBm	up to +12 dBm	
	15 GHz to 20 GHz	-60 dBm to +8 dBm	up to +10 dBm	
	Power range of the R&S®ZNB40 model .72	without R&S®ZNB40-B22 extended power range option		
		10 MHz to 30 GHz	-30 dBm to +10 dBm	up to +15 dBm
30 GHz to 40 GHz		-30 dBm to +8 dBm	up to +13 dBm	
with R&S®ZNB40-B22 extended power range option				
10 MHz to 30 GHz		-60 dBm to +10 dBm	up to +15 dBm	
30 GHz to 40 GHz		-60 dBm to +8 dBm	up to +13 dBm	
Power range of the R&S®ZNB40 model .82 and .84	without R&S®ZNB40-B22 extended power range option			
	100 kHz to 300 kHz	-30 dBm to +8 dBm	up to +11 dBm	
	300 kHz to 1 GHz	-30 dBm to +10 dBm	up to +12 dBm	
	1 GHz to 10 GHz	-30 dBm to +8 dBm	up to +11 dBm	
	10 GHz to 15 GHz	-30 dBm to +6 dBm	up to +10 dBm	
	15 GHz to 20 GHz	-30 dBm to +5 dBm	up to +8 dBm	
	20 GHz to 30 GHz	-30 dBm to +2 dBm	up to +5 dBm	
	30 GHz to 40 GHz	-30 dBm to 0 dBm	up to +4 dBm	
	with R&S®ZNB40-B22 extended power range option			
	100 kHz to 300 kHz	-60 dBm to +8 dBm	up to +11 dBm	
	300 kHz to 1 GHz	-60 dBm to +10 dBm	up to +12 dBm	
	1 GHz to 10 GHz	-60 dBm to +8 dBm	up to +11 dBm	
	10 GHz to 15 GHz	-60 dBm to +6 dBm	up to +10 dBm	
	15 GHz to 20 GHz	-60 dBm to +5 dBm	up to +8 dBm	
20 GHz to 30 GHz	-60 dBm to +2 dBm	up to +5 dBm		
30 GHz to 40 GHz	-60 dBm to 0 dBm	up to +4 dBm		
Power accuracy of the R&S®ZNB4 and the R&S®ZNB8	source power -10 dBm			
	9 kHz to 50 kHz	≤ 3 dB		
	50 kHz to 8.5 GHz	≤ 2 dB	0.5 dB	
Power accuracy of the R&S®ZNB20	source power -10 dBm			
	100 kHz to 10 GHz	≤ 2 dB		
	10 GHz to 20 GHz	≤ 3 dB		
Power accuracy of the R&S®ZNB40 model .72	source power -10 dBm			
	10 MHz to 10 GHz	≤ 2 dB		
	10 GHz to 20 GHz	≤ 3 dB		
	20 GHz to 40 GHz	≤ 4 dB		
Power accuracy of the R&S®ZNB40 model .82 and .84	source power -10 dBm			
	100 kHz to 20 GHz	≤ 2 dB		
	20 GHz to 40 GHz	≤ 3 dB		

Parameter	Frequency range	Specification	Typical
Power linearity of the R&S®ZNB4 and the R&S®ZNB8	referenced to -10 dBm		
	source power $\geq -55$ dBm	$\leq 1$ dB	
	source power $< -55$ dBm	$\leq 2$ dB	
Power linearity of the R&S®ZNB20	referenced to -10 dBm		
	source power $\geq -30$ dBm	$\leq 1$ dB	
	source power $< -30$ dBm	$\leq 2$ dB	
Power linearity of the R&S®ZNB40	referenced to -10 dBm		
	source power $\geq -30$ dBm		
	10 MHz to 20 GHz	$\leq 1$ dB	
	20 GHz to 40 GHz	$\leq 2$ dB	
	source power $< -30$ dBm		
	10 MHz to 20 GHz	$\leq 2$ dB	
Power resolution	20 GHz to 40 GHz	$\leq 4$ dB	
		0.01 dB	
Harmonics of the R&S®ZNB4 and the R&S®ZNB8	at 0 dBm		
	20 kHz to 100 MHz	$\leq -20$ dBc	-30 dBc
	100 MHz to 8.5 GHz	$\leq -25$ dBc	-35 dBc
Harmonics of the R&S®ZNB20	at 0 dBm		
	100 kHz to 10 MHz	$\leq -15$ dBc	-20 dBc
	10 MHz to 100 MHz	$\leq -20$ dBc	-30 dBc
	100 MHz to 15 GHz	$< -25$ dBc	-35 dBc
	15 GHz to 20 GHz	$\leq -20$ dBc	-35 dBc
Harmonics of the R&S®ZNB40 model .72	at 0 dBm		
	10 MHz to 100 MHz	$\leq -20$ dBc	-30 dBc
	100 MHz to 14 GHz	$\leq -25$ dBc	-35 dBc
	14 GHz to 40 GHz	$\leq -15$ dBc	-30 dBc
Harmonics of the R&S®ZNB40 model .82 and .84	at 0 dBm		
	100 kHz to 10 MHz	$\leq -15$ dBc	-30 dBc
	10 MHz to 100 MHz	$\leq -20$ dBc	-35 dBc
	100 MHz to 10 GHz	$\leq -25$ dBc	-30 dBc
	10 GHz to 15 GHz	$\leq -18$ dBc	-25 dBc
	at -5 dBm		
	15 GHz to 18 GHz	$\leq -18$ dBc	-25 dBc
	18 GHz to 40 GHz	$\leq -15$ dBc	-20 dBc

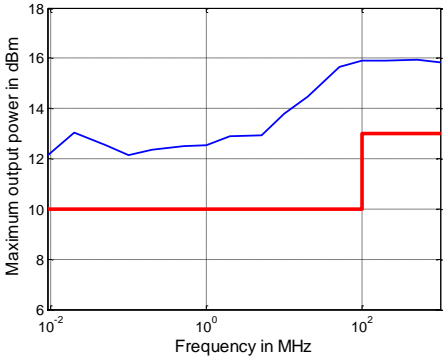

Maximum output power in dBm versus frequency for the R&S ZNB4

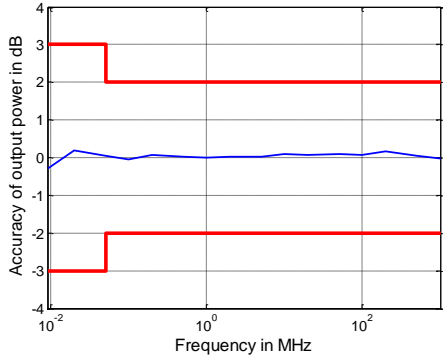
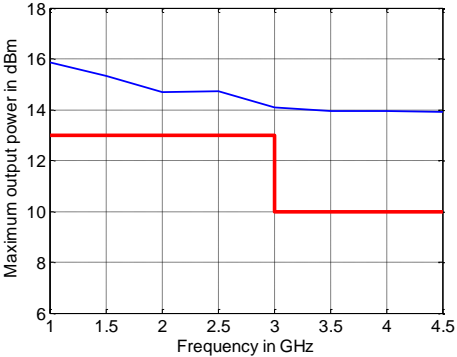

Output power accuracy in dB versus frequency for the R&S ZNB4

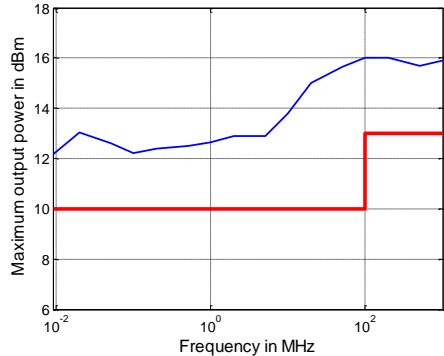
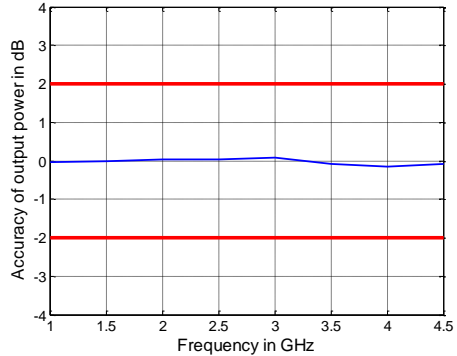

Maximum output power in dBm versus frequency for the R&S ZNB8

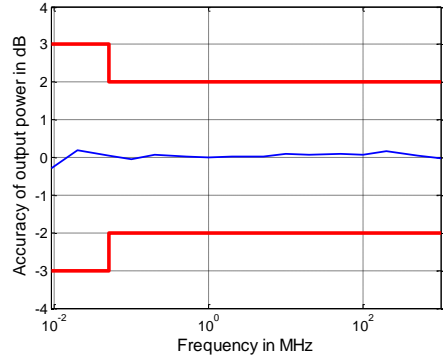
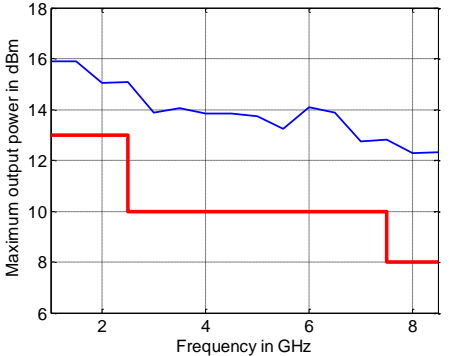

Output power accuracy in dB versus frequency for the R&S ZNB8

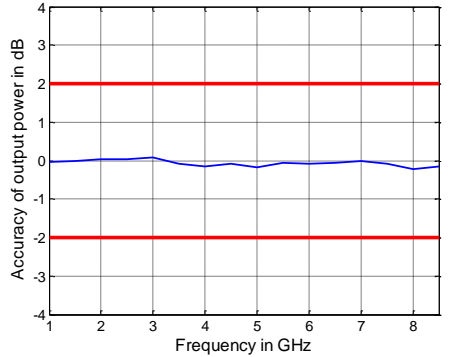

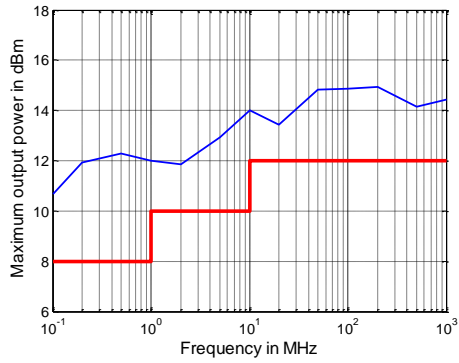

Maximum output power in dBm versus frequency for the R&S®ZNB20

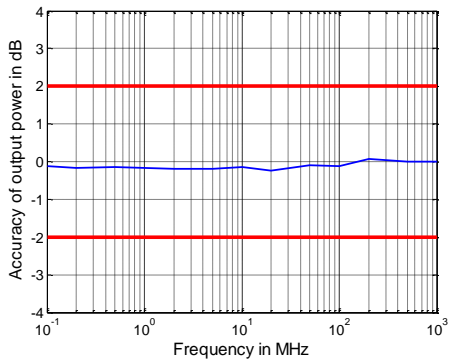
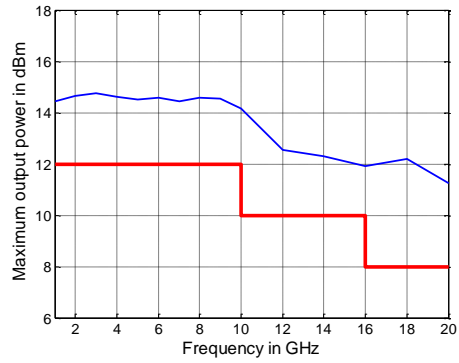

Output power accuracy in dB versus frequency for the R&S®ZNB20

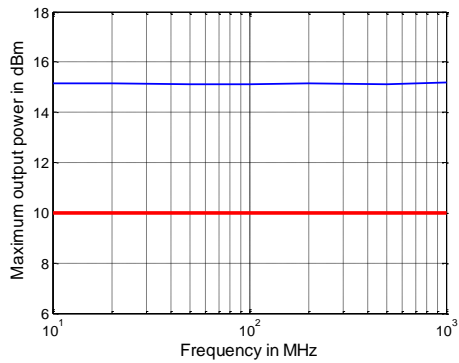
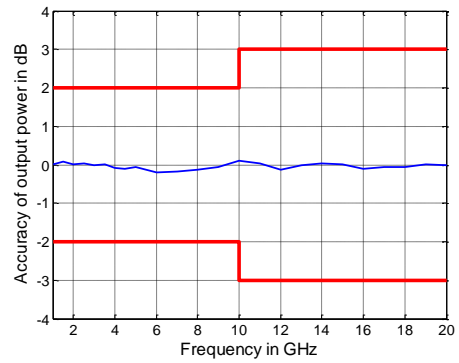

Maximum output power in dBm versus frequency for the R&S®ZNB40 model .72

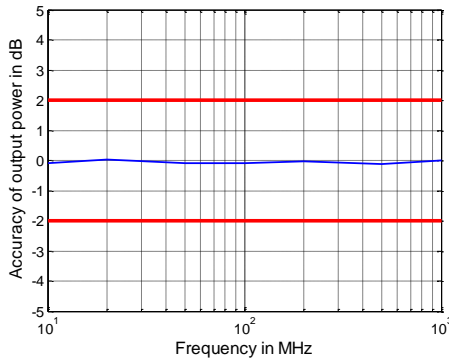
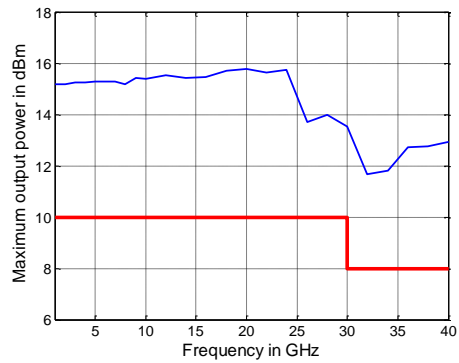

Output power accuracy in dB versus frequency for the R&S®ZNB40 model .72

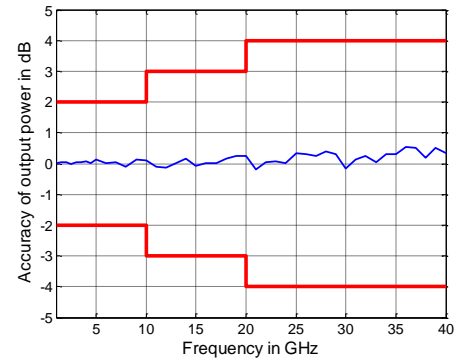

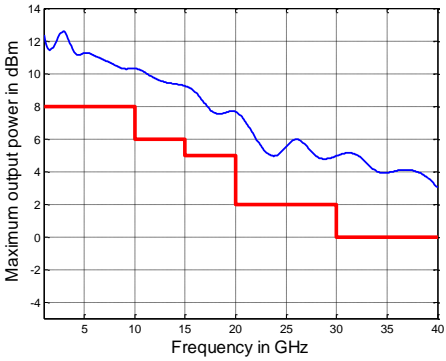
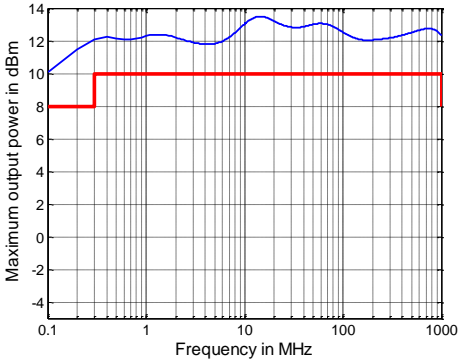

Maximum output power in dBm versus frequency for the R&S<sup>®</sup>ZNB40 model .82 and .84

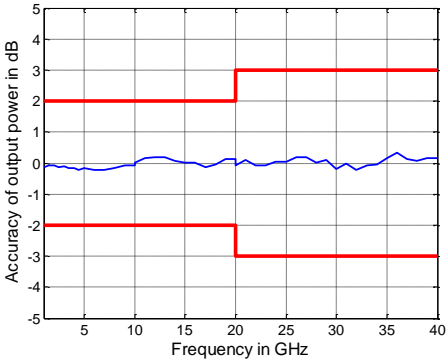
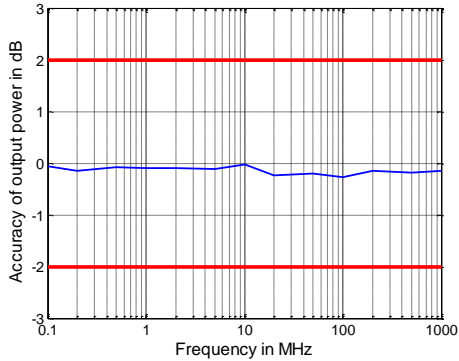

Output power accuracy in dB versus frequency for the R&S<sup>®</sup>ZNB40 model .82 and .84

## Test port input

Match	without system error correction		
	R&S®ZNB4		
	9 kHz to 50 kHz	> 10 dB	
	50 kHz to 4.5 GHz	> 20 dB	
	R&S®ZNB8		
	9 kHz to 50 kHz	> 10 dB	
	50 kHz to 8.5 GHz	> 20 dB	
	R&S®ZNB20		
	100 kHz to 1 MHz	> 16 dB	
	1 MHz to 2 GHz	> 20 dB	
	2 GHz to 20 GHz	> 16 dB	
	R&S®ZNB40 model .72		
	10 MHz to 50 MHz	> 15 dB	
	50 MHz to 2 GHz	> 20 dB	
	2 GHz to 6 GHz	> 16 dB	
	6 GHz to 10 GHz	> 12 dB	
	10 GHz to 20 GHz	> 10 dB	
	20 GHz to 40 GHz	> 8 dB	
	R&S®ZNB40 model .82 and .84		
	100 kHz to 300 kHz	> 12 dB	
	300 kHz to 10 MHz	> 15 dB	
	10 MHz to 20 GHz	> 18 dB	
	20 GHz to 40 GHz	> 15 dB	
	Maximum nominal input level		+13 dBm
	Power measurement accuracy at -10 dBm without power calibration	R&S®ZNB4 and R&S®ZNB8	
		9 kHz to 100 kHz	< 2 dB
		100 kHz to 8.5 GHz	< 1 dB
		R&S®ZNB20	
		100 kHz to 20 GHz	< 1 dB
		R&S®ZNB40	
		10 MHz to 20 GHz	< 1 dB
		20 GHz to 40 GHz	< 2 dB
	Receiver linearity referenced to -10 dBm	R&S®ZNB4 and R&S®ZNB8	
		for +20 dB to +10 dB	
		9 kHz to 7.5 GHz	< 0.2 dB
		for +18 dB to +10 dB	
		7.5 GHz to 8.5 GHz	< 0.2 dB
		for +10 dB to -40 dB	
9 kHz to 8.5 GHz		< 0.1 dB	
R&S®ZNB20			
for +18 dB to +10 dB			
100 kHz to 1 MHz		< 0.3 dB	
for +20 dB to +10 dB			
1 MHz to 15 GHz		< 0.3 dB	
for +18 dB to +10 dB			
15 GHz to 20 GHz		< 0.3 dB	
for +10 dB to -40 dB			
100 kHz to 20 GHz		< 0.1 dB	
R&S®ZNB40 model .72			
for +15 dB to +10 dB			
10 MHz to 40 GHz		typ. 0.4 dB	
for +10 dB to +5 dB			
10 MHz to 40 GHz		< 0.2 dB	
for +5 dB to -40 dB			
10 MHz to 40 GHz		< 0.1 dB	
R&S®ZNB40 model .82 and .84			
for +15 dB to +10 dB			
100 kHz to 20 GHz	< 0.2 dB		
for +10 dB to -40 dB			
100 kHz to 40 GHz	< 0.1 dB		
Damage level		+27 dBm	
Damage DC voltage		30 V	



Noise level <sup>6</sup> at 1 kHz measurement bandwidth, normalized to 1 Hz	R&S®ZNB4 and R&S®ZNB8	
	9 kHz to 50 kHz	< -115 dBm (1 Hz)
	50 kHz to 50 MHz	< -120 dBm (1 Hz)
	50 MHz to 4 GHz	< -130 dBm (1 Hz)
	4 GHz to 6.5 GHz	< -125 dBm (1 Hz)
	6.5 GHz to 8.5 GHz	< -120 dBm (1 Hz)
	R&S®ZNB20	
	100 kHz to 300 kHz	< -105 dBm (1 Hz)
	300 kHz to 1 MHz	< -110 dBm (1 Hz)
	1 MHz to 10 MHz	< -115 dBm (1 Hz)
	10 MHz to 100 MHz	< -120 dBm (1 Hz)
	100 MHz to 10 GHz	< -125 dBm (1 Hz)
	10 GHz to 20 GHz	< -120 dBm (1 Hz)
	R&S®ZNB40 model .72	
	10 MHz to 50 MHz	< -100 dBm (1 Hz)
	50 MHz to 100 MHz	< -110 dBm (1 Hz)
	100 MHz to 500 MHz	< -115 dBm (1 Hz)
	500 MHz to 20 GHz	< -125 dBm (1 Hz)
	20 GHz to 40 GHz	< -115 dBm (1 Hz)
	R&S®ZNB40 model .82 and .84	
	100 kHz to 300 kHz	< -110 dBm (1 Hz)
300 kHz to 1 MHz	< -115 dBm (1 Hz)	
1 MHz to 5 GHz	< -120 dBm (1 Hz)	
5 GHz to 20 GHz	< -118 dBm (1 Hz)	
20 GHz to 35 GHz	< -115 dBm (1 Hz)	
35 GHz to 40 GHz	< -105 dBm (1 Hz)	

## Additional front panel connectors

USB	4 ports, type A plug, version 2.0
-----	-----------------------------------

## Display

Screen	30.7 cm (12.1") diagonal, WXGA, 18-bit color LCD with touchscreen
Resolution	1280 × 800 pixel, 125 dpi
Pixel failure rate	< 1 × 10 <sup>-5</sup>

## Rear panel connectors

LAN	local area network connector, 8-pin, RJ-45
-----	--

USB Host	2 ports, type A plug, version 2.0
----------	-----------------------------------

USB Device	1 port, type B plug, version 2.0
------------	----------------------------------

<b>REF IN</b>	input for external frequency reference signal	
Connector type	BNC, female	
Input frequency range	1 MHz to 20 MHz, in steps of 1 MHz	
Maximum permissible deviation	1 kHz	
Input power	-10 dBm to +15 dBm	
Input impedance	50 Ω	

<b>REF OUT</b>	output for external frequency reference signal	
Connector type	BNC, female	
Output frequency	10 MHz	
Output power	+9 dBm ± 4 dB at 50 Ω	

<sup>6</sup> The noise level is defined as the RMS value of the specified noise floor.

<b>Bias tee for the R&amp;S®ZNB20 and the R&amp;S®ZNB40</b>		
Connector type		BNC, female
Maximum nominal input voltage		30 V
Maximum nominal input current		250 mA
Damage voltage		30 V
Damage current		400 mA

<b>External monitor</b>		
Monitor (DVI-D)		DVI connector (for external monitor)
Monitor (DisplayPort)		DisplayPort connector

<b>USER CONTROL</b>		
	several control and trigger signals, 25-pin D-Sub, 3.3 V TTL, for controlling external generators, for limit checks, sweep signals, etc.	
CHANNEL BIT 0 to CHANNEL BIT 3	pin 8 to pin 11 (outputs)	channel-specific, user-configurable bits
CHANNEL BIT 4 to CHANNEL BIT 7	pin 16 to pin 19 (outputs)	channel-specific, user-configurable bits
DRIVE PORT 1 to DRIVE PORT 4	pin 16 to pin 19 (outputs)	indicates drive ports (can alternatively be used for channel bits 4 to 7)
PASS 1 and PASS 2	pin 13 and pin 14 (outputs)	pass/fail results of limit checks
BUSY	pin 4 (output)	measurements running
READY FOR TRIGGER	pin 6 (output)	ready for trigger
EXT GEN TRIGGER	pin 21 (output)	control signal for external generator
EXT GEN BLANK	pin 22 (input)	handshake signal from external generator
EXTERNAL TRIGGER	pin 2 (input)	first trigger input for analyzer, 5 V tolerant
EXTERNAL TRIGGER 2	pin 25 (input)	second trigger input for analyzer, 5 V tolerant

<b>EXT TRIG IN</b>		
	trigger input for analyzer	
Connector type		BNC, female
TTL signal (edge-triggered or level-triggered)		3 V, 5 V tolerant
Polarity (selectable)		positive or negative
Minimum pulse width		1 $\mu$ s
Input impedance		> 10 k $\Omega$

<b>EXT TRIG OUT</b>		
	trigger output of analyzer	
Connector type		BNC, female
Logic high		typ. 3.3 V

# Options

## R&S®ZNB-B1

Bias tee for the R&S®ZNB4 and the R&S®ZNB8		
Connector type		BNC, female
Maximum nominal input voltage		30 V
Maximum nominal input current		400 mA
Damage voltage		30 V
Damage current		420 mA
Frequency range	R&S®ZNB4 with R&S®ZNB-B1 R&S®ZNB8 with R&S®ZNB-B1	100 kHz to 4.5 GHz 100 kHz to 8.5 GHz
Frequency response data		typical and specified data is valid for the limited frequency range given above

### Factory-calibrated system data

This data is valid between +18 °C and +28 °C. The data is based on a source power of –10 dBm and a measurement bandwidth of 1 kHz.

Parameter	Frequency range	Specification	Typical
Directivity	100 kHz to 4.5 GHz	≥ 30 dB	50 dB
	4.5 GHz to 8.5 GHz	≥ 30 dB	50 dB
Source match	100 kHz to 500 kHz	≥ 20 dB	30 dB
	500 kHz to 4.5 GHz	≥ 30 dB	50 dB
	4.5 GHz to 8.5 GHz	≥ 30 dB	50 dB
Reflection tracking	100 kHz to 8.5 GHz	≤ 0.5 dB	0.1 dB
Load match	100 kHz to 500 kHz	≥ 10 dB	15 dB
	500 kHz to 8.5 GHz	≥ 20 dB	25 dB
Transmission tracking	100 kHz to 8.5 GHz	≤ 0.5 dB	0.1 dB

## R&S®ZNB-B4

Static frequency accuracy		(time since last adjustment × aging rate) + temperature drift + calibration accuracy
Aging per year	with R&S®ZNB-B4 precision frequency reference option	±1 × 10 <sup>-7</sup>
Temperature drift (0 °C to +50 °C)	with R&S®ZNB-B4 precision frequency reference option	±1 × 10 <sup>-8</sup>
Achievable initial calibration accuracy	with R&S®ZNB-B4 precision frequency reference option	±5 × 10 <sup>-8</sup>

## R&S®ZNB-B10

<b>GPIO interface</b>	remote control interface in line with IEEE 488, IEC 60625; 24-pin
-----------------------	---

## R&S®ZNB-B12

Device control	
DIRECT CTRL interface	direct control bus output

## R&S®ZN-B14

<b>Handler I/O</b>	several control and trigger signals, 36-pin Centronics connector, TTL compatible, for controlling external devices, limit checks, sweep signals, etc.	
Agilent handler interface compatibility	type 3	
Input signals	pin 2, pin 18	TTL compatible
Output signals	pin 3 to pin 17, pin 19 to pin 21, pin 30 to pin 34, pin 36	TTL compatible
Input/output signals	pin 22 to pin 29	TTL compatible
+5 V output	pin 35	+5 V, max. 100 mA
Response time of write strobe signal	pin 32	1 μs
Pulse width of write strobe signal	pin 32	1 μs
Pulse width of external trigger signal	pin 18	> 1 μs
Pulse width of sweep end signal	pin 34	> 10 μs

## R&amp;S®ZN-B15

<b>RFFE GPIO interface</b> <b>1323.9355.02 and 1323.9355.03</b>	provides two independent MIPI RFFE busses, and 10 individually configurable output lanes with different power handling capabilities
Connector type	25-pin D-Sub female
Ground (analog and digital)	pin 1, 3, 5, 11 and 22

Output voltage	Output configuration selected	Voltage range	Voltage step size	Maximum current
RFFE port 1 VIO	pin 2	0 to +2 V	1 mV	20 mA
RFFE port 1 DATA	pin 15	0 to +2 V	1 mV	20 mA
RFFE port 1 CLK	pin 14	0 to +2 V	1 mV	20 mA
		configurable clockrate 31.25 kHz to 26 MHz		
RFFE port 2 VIO	pin 4	0 to +2 V	1 mV	20 mA
RFFE port 2 DATA	pin 17	0 to +2 V	1 mV	20 mA
RFFE port 2 CLK	pin 16	0 to +2 V	1 mV	20 mA
		configurable clockrate 31.25 kHz to 26 MHz		
GPIO 1 to GPIO 8	pin 6 to pin 9, pin 18 to pin 21	-5 V to +10 V, typ. -6 V to +12 V	5 mV	20 mA
GPIO 9 and 10	pin 10 and 23	-5 V to +10 V, typ. -6 V to +12 V	5 mV	100 mA

<b>RFFE GPIO interface</b> <b>1323.9355.03</b>	including voltage/current measurement with switchable source resistance					
	32 internal ADC channels are available on the RFFE-GPIO-Interface measuring voltage and current at each RFFE and GPIO pin simultaneously					
<b>Voltage measurement</b>		<b>Voltage range</b>	<b>Resolution</b>	<b>Accuracy <sup>7</sup></b>		
RFFE port 1 and 2, VIO, DATA and CLK	pin 2 and 4, pin 14 to pin 17	0 to +3 V	100 µV	2 % ± 20 mV		
GPIO 1 to GPIO 10	pin 6 to pin 9, pin 18 to pin 21, pin 10, pin 23	-5 V to +10 V	100 µV	2 % ± 50 mV		
<b>Current measurement</b> <b>Current values are valid for GPIO</b> <b>voltages -5 V to +8 V</b>		<b>Source shunt resistor</b>	<b>Current range</b>	<b>Resolution</b>	<b>Accuracy <sup>7</sup></b>	<b>Repeatability</b>
RFFE port 1 and 2, VIO, DATA and CLK, GPIO 1 to GPIO 8	pin 6 to pin 9, pin 18 to pin 21	10 Ω	-20 mA to +20 mA	10 µA	2 % ± 200 µA	< 100 µA
		100 Ω	-2 mA to +2 mA	1 µA	2 % ± 20 µA	< 10 µA
		1 kΩ	-200 µA to +200 µA	100 nA	3 % ± 3 µA	< 1 µA
		10 kΩ	-20 µA to +20 µA	10 nA	5 % ± 500 nA	< 100 nA
		100 kΩ	-2 µA to +2 µA	1 nA	5 % ± 50 nA	< 10 nA
GPIO 9 and 10	pin 10 and 23		-100 mA to +100 mA	10 µA	3 % ± 3 mA	< 100 µA

<sup>7</sup> x % ± y is to be understood as x % of reading ± y.

## R&S®ZNB4-B22/-B24, R&S®ZNB8-B22/-B24, R&S®ZNB20-B22/-B24 and R&S®ZNB40-B22

		Specification	Typical
<b>Extended power range</b>			
Frequency range	R&S®ZNB4-B22 and R&S®ZNB4-B24	9 kHz to 4.5 GHz	
	R&S®ZNB8-B22 and R&S®ZNB8-B24	9 kHz to 8.5 GHz	
	R&S®ZNB20-B22 and R&S®ZNB20-B24	100 kHz to 20 GHz	
	R&S®ZNB40-B22	10 MHz to 40 GHz	
Power range for the R&S®ZNB4 and the R&S®ZNB8	9 kHz to 100 MHz	-85 dBm to +10 dBm	up to +12 dBm
	100 MHz to 2.5 GHz	-85 dBm to +13 dBm	up to +15 dBm
	2.5 GHz to 7.5 GHz	-85 dBm to +10 dBm	up to +13 dBm
	7.5 GHz to 8.5 GHz	-85 dBm to +8 dBm	up to +12 dBm
Power range for the R&S®ZNB20	100 kHz to 1 MHz	-60 dBm to +8 dBm	up to +10 dBm
	1 MHz to 10 MHz	-60 dBm to +10 dBm	up to +12 dBm
	10 MHz to 10 GHz	-60 dBm to +12 dBm	up to +14 dBm
	10 GHz to 15 GHz	-60 dBm to +10 dBm	up to +12 dBm
Power range for the R&S®ZNB40 model .72	15 GHz to 20 GHz	-60 dBm to +8 dBm	up to +10 dBm
	10 MHz to 30 GHz	-60 dBm to +10 dBm	up to +15 dBm
Power range for the R&S®ZNB40 model .82 and 84	30 GHz to 40 GHz	-60 dBm to +8 dBm	up to +13 dBm
	100 kHz to 300 kHz	-60 dBm to +8 dBm	up to +11 dBm
Power range for the R&S®ZNB40 model .82 and 84	300 kHz to 1 GHz	-60 dBm to +10 dBm	up to +12 dBm
	1 GHz to 10 GHz	-60 dBm to +8 dBm	up to +11 dBm
	10 GHz to 15 GHz	-60 dBm to +6 dBm	up to +10 dBm
	15 GHz to 20 GHz	-60 dBm to +5 dBm	up to +8 dBm
	20 GHz to 30 GHz	-60 dBm to +2 dBm	up to +5 dBm
	30 GHz to 40 GHz	-60 dBm to 0 dBm	up to +4 dBm

## R&S®ZNB4-B31/-B32/-B33/-B34 and R&S®ZNB8-B31/-B32/-B33/-B34

<b>Receiver step attenuators</b>		
Frequency range	R&S®ZNB4-B31/R&S®ZNB4-B32/ R&S®ZNB4-B33/R&S®ZNB4-B34	9 kHz to 4.5 GHz
	R&S®ZNB8-B31/R&S®ZNB8-B32/ R&S®ZNB8-B33/R&S®ZNB8-B34	9 kHz to 8.5 GHz
Attenuation		0 dB to 30 dB in 10 dB steps

## R&S®ZNB4-B52/-B54 and R&S®ZNB8-B52/-B54

Extended dynamic range		Specification	Typical
Power range	without R&S®ZNB4-B22/R&S®ZNB4-B24 or R&S®ZNB8-B22/R&S®ZNB8-B24 extended power range option		
	9 kHz to 100 kHz	-55 dBm to +8 dBm	
	100 kHz to 6.5 GHz	-55 dBm to +10 dBm	
	6.5 GHz to 7.5 GHz	-55 dBm to +8 dBm	
	7.5 GHz to 8.5 GHz	-55 dBm to +6 dBm	
	with R&S®ZNB4-B22/R&S®ZNB4-B24 or R&S®ZNB8-B22/R&S®ZNB8-B24 extended power range option		
	9 kHz to 100 kHz	-85 dBm to +8 dBm	
	100 kHz to 6.5 GHz	-85 dBm to +10 dBm	
	6.5 GHz to 7.5 GHz	-85 dBm to +8 dBm	
	7.5 GHz to 8.5 GHz	-85 dBm to +6 dBm	
Dynamic range <sup>8</sup>	9 kHz to 100 kHz	≥ 120 dB	130 dB
	100 kHz to 50 MHz	≥ 125 dB	140 dB
	50 MHz to 6.5 GHz	≥ 140 dB	150 dB
	6.5 GHz to 8.5 GHz	≥ 130 dB	138 dB

Test port input			
Match	without system error correction		
	9 kHz to 50 kHz	≥ 10 dB	
	50 kHz to 8.5 GHz	≥ 18 dB	
Maximum nominal input level		+10 dBm	
Receiver linearity referenced to -10 dBm	for +18 dB to +10 dB		
	9 kHz to 7.5 GHz	≤ 0.2 dB	
	for +16 dB to +10 dB		
	7.5 GHz to 8.5 GHz	≤ 0.2 dB	
	for +10 dB to -40 dB		
Noise level <sup>9</sup> at 1 kHz measurement bandwidth, normalized to 1 Hz	9 kHz to 8.5 GHz		
	9 kHz to 50 kHz	≤ -125 dBm (1 Hz)	
	50 kHz to 50 MHz	≤ -130 dBm (1 Hz)	
	50 MHz to 6.5 GHz	≤ -140 dBm (1 Hz)	
	6.5 GHz to 8.5 GHz	≤ -130 dBm (1 Hz)	

Trace stability			Specification	Typical
Trace noise magnitude (RMS)	at 0 dBm source power, 0 dB reflection		IF bandwidth	
	9 kHz to 20 kHz	1 kHz	≤ 0.008 dB	0.004 dB
	20 kHz to 100 kHz	1 kHz	≤ 0.005 dB	0.001 dB
	100 kHz to 100 MHz	10 kHz	≤ 0.005 dB	0.001 dB
	100 MHz to 8.5 GHz	10 kHz	≤ 0.005 dB	0.002 dB

<sup>8</sup> The dynamic range is defined as the difference between the actual maximum source power and the RMS value of the data trace of the transmission magnitude, which is produced by noise and crosstalk with the test ports short-circuited. The specification applies at 10 Hz measurement bandwidth, without system error correction. The dynamic range can be increased by using a measurement bandwidth of 1 Hz. Crosstalk does not limit the dynamic range. Dynamic range between port 1 and port 2 and between port 3 and port 4 (4-port model). Otherwise the dynamic range performance is typical.

<sup>9</sup> The noise level is defined as the RMS value of the specified noise floor.

<b>Measurement speed in ms with option R&amp;S®ZNB4-B52/-B54 or R&amp;S®ZNB8-B52/-B54 installed</b>					
Typical sweep times versus number of measurement points, sweep mode: stepped.					
<b>Number of measurement points</b>	<b>51</b>	<b>201</b>	<b>401</b>	<b>1601</b>	<b>5001</b>
800 MHz start frequency, 1 GHz stop frequency, AGC LOW DIST, 100 kHz measurement bandwidth					
With correction switched off	2.0	5	8	20	57
With 2-port TOSM calibration	3.5	9	13	40	113
With 4-port TOSM calibration	6.5	17	25	81	246
800 MHz start frequency, 1 GHz stop frequency, AGC AUTO, 100 kHz measurement bandwidth					
With correction switched off	3.5	10	16	55	170
With 2-port TOSM calibration	6	18	31	109	339
With 4-port TOSM calibration	10	35	61	225	701
100 kHz start frequency, 4.5 GHz stop frequency, AGC LOW DIST, 100 kHz measurement bandwidth					
With correction switched off	4.0	8	12	33	90
With 2-port TOSM calibration	7.5	14	22	65	180
With 4-port TOSM calibration	14	27	42	130	355
100 kHz start frequency, 4.5 GHz stop frequency, AGC AUTO, 100 kHz measurement bandwidth					
With correction switched off	6	12	21	69	205
With 2-port TOSM calibration	10	23	40	137	405
With 4-port TOSM calibration	19	45	79	273	810
100 kHz start frequency, 8.5 GHz stop frequency, AGC LOW DIST, 100 kHz measurement bandwidth					
With correction switched off	4.5	9	13	34	90
With 2-port TOSM calibration	8.5	17	25	67	180
With 4-port TOSM calibration	16	32	47	131	359
100 kHz start frequency, 8.5 GHz stop frequency, AGC AUTO, 100 kHz measurement bandwidth					
With correction switched off	6	13	22	70	205
With 2-port TOSM calibration	11	26	43	139	410
With 4-port TOSM calibration	21	50	84	280	815

**Note:** The R&S®ZNBx-B52/-B54 options cannot be combined with the R&S®ZNBx-B1 option and/or the R&S®ZNBx-B31/-B32/-B33/-B34 options.

## R&S®ZNB-B81

This data is valid from +18 °C to +28 °C and a measurement bandwidth at maximum 10 kHz.

<b>DC inputs</b>		
Number of ports		4
Connector type		BNC, female
Voltage range		±20 V, ±3 V, ±0.3 V
Measurement accuracy	±20 V	1 % of reading ± 0.01 V
	±3 V	1 % of reading ± 0.001 V
	±0.3 V	1 % of reading ± 0.001 V
Input impedance		≥ 1 MΩ
Damage voltage		30 V

## General data

Temperature loading	in line with IEC 60068-2-1 and IEC 60068-2-2	
	operating temperature range	+5 °C to +40 °C
	storage temperature range	-20 °C to +60 °C
Damp heat		+40 °C at 85 % rel. humidity, in line with IEC 60068-2-30
Altitude	operating environment	max. 2000 m
	storage environment	max. 4500 m
Mechanical resistance	vibration, sinusoidal	5 Hz to 55 Hz, 0.15 mm amplitude constant, 55 Hz to 150 Hz, 0.5 g constant, in line with IEC 60068-2-6
	vibration, random	10 Hz to 300 Hz, acceleration 1.2 g (RMS) in line with IEC 60068-2-64
	shock	40 g shock spectrum, in line with MIL-STD-810E method no. 516.4 procedure I
Calibration interval		1 year
EMC	RF emission	in line with CISPR 11/EN 55011 group 1 class A (for a shielded test setup); instrument complies with the emission requirements stipulated by EN 55011 and EN 61326-1 class A; this means that the instrument is suitable for use in industrial environments
	immunity	in line with EMC Directive 2014/30/EU including: IEC/EN 61326-1 (immunity test requirement for industrial environment, EN 61326 table 2), IEC/EN 61326-2-1, IEC/EN 61000-3-2, IEC/EN 61000-3-3
Safety		in line with IEC 61010-1, EN 61010-1 and UL 61010-1, CAN/CSA-C22.2 No.61010-1
Power supply		100 V to 240 V at 50 Hz to 60 Hz and 400 Hz, max. 5.5 A to 2.3 A respectively
Power consumption	R&S®ZNB4 and R&S®ZNB8, with 2 ports	max. 450 W, typ. 120 W
	R&S®ZNB4 and R&S®ZNB8, with 4 ports	max. 450 W, typ. 170 W
	R&S®ZNB20 and R&S®ZNB40, with 2 ports	max. 450 W, typ. 130 W
	R&S®ZNB20 and R&S®ZNB40, with 4 ports	max. 450 W, typ. 215 W
Test mark		VDE, GS, cCSA <sub>US</sub> , KCC conformity mark, CE conformity mark
Dimensions	W x H x D	461.1 mm x 239.9 mm x 351.0 mm (18.2 in x 9.6 in x 13.9 in)
Weight	R&S®ZNB4, R&S®ZNB8, R&S®ZNB20 and R&S®ZNB40, with 2 ports	14 kg (30.9 lb)
	R&S®ZNB4, R&S®ZNB8, R&S®ZNB20 and R&S®ZNB40, with 4 ports	16 kg (35.3 lb)
Shipping weight	R&S®ZNB4, R&S®ZNB8, R&S®ZNB20 and R&S®ZNB40, with 2 ports	19 kg (41.9 lb)
	R&S®ZNB4, R&S®ZNB8, R&S®ZNB20 and R&S®ZNB40, with 4 ports	21 kg (46.3 lb)



# Dimensions (in mm)

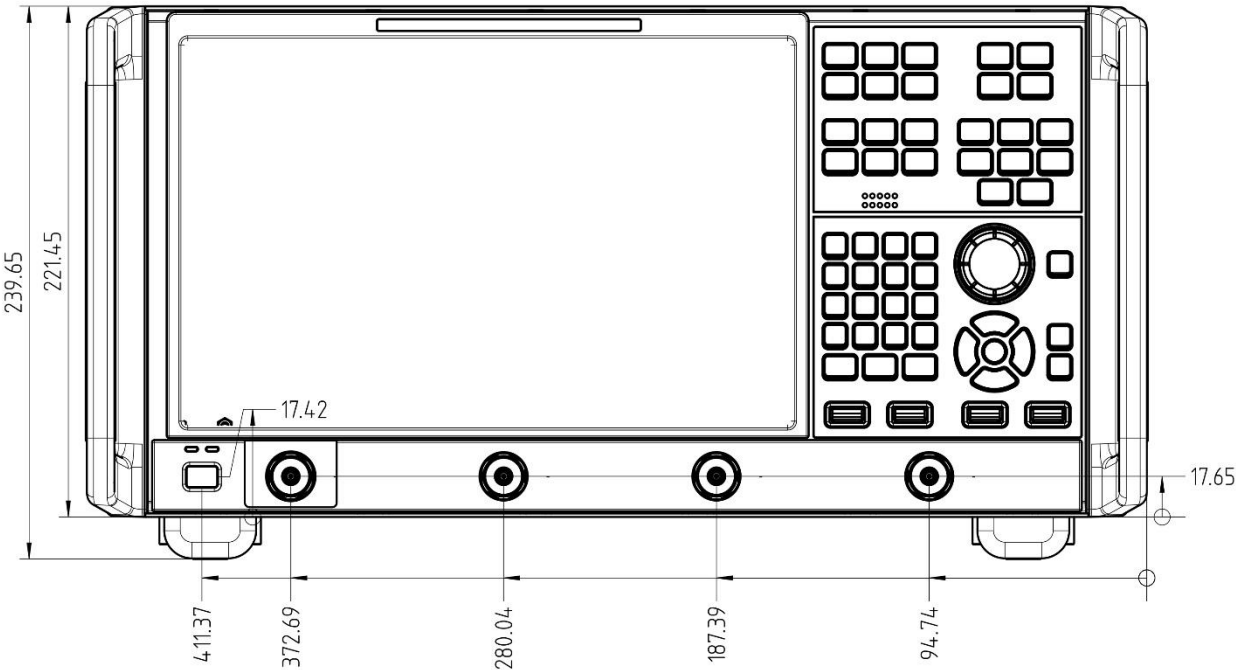

Front view of the R&S®ZNB

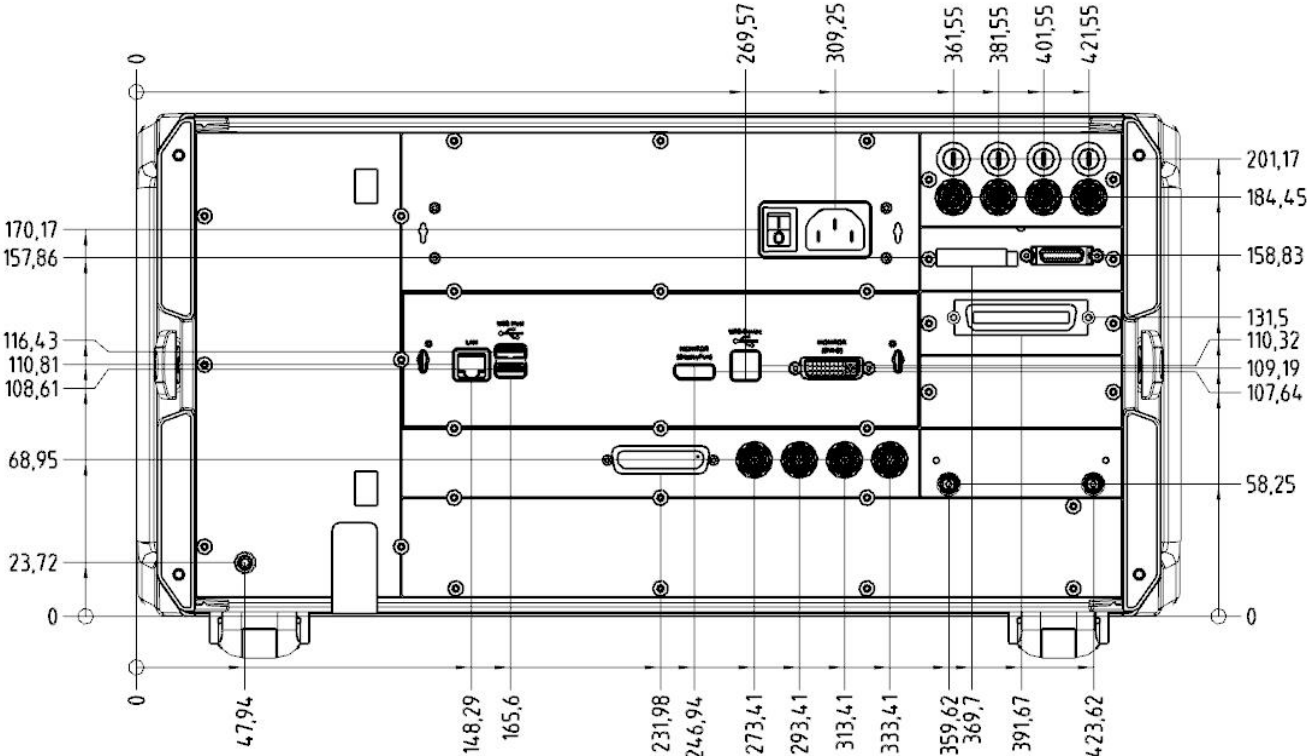

Rear view of the R&S®ZNB

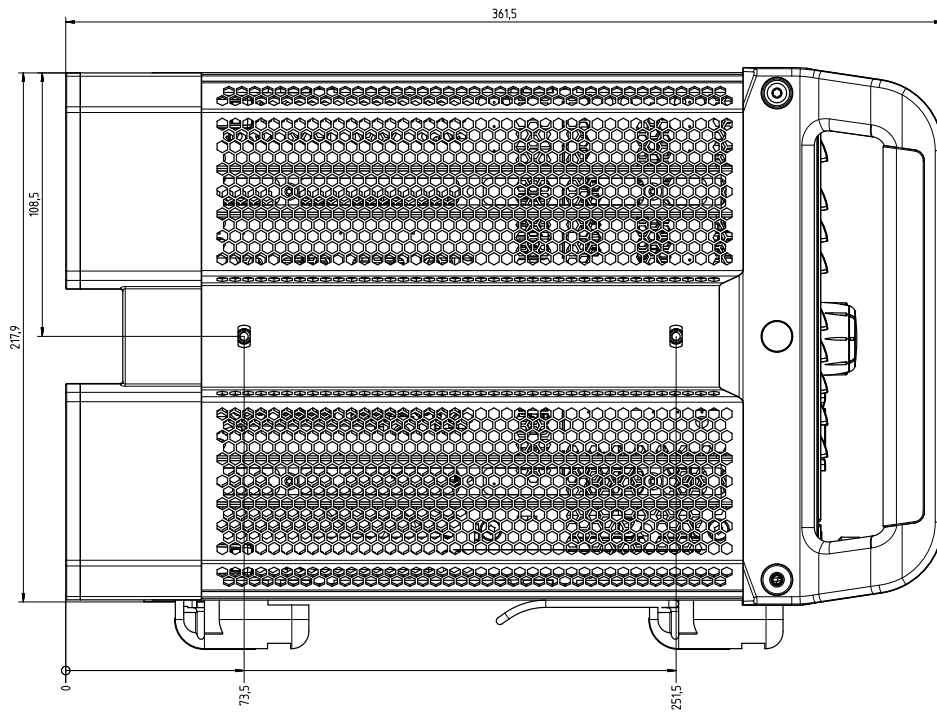

Side view of the R&S<sup>®</sup>ZNB

## Ordering information

Designation	Type	Retrofit <sup>10</sup>	On site <sup>11</sup>	Order No.
<b>Base unit</b>				
Vector network analyzer, 2 ports, 4.5 GHz, N	R&S®ZNB4			1311.6010K22
Vector network analyzer, 4 ports, 4.5 GHz, N	R&S®ZNB4			1311.6010K24
Vector network analyzer, 2 ports, 8.5 GHz, N	R&S®ZNB8			1311.6010K42
Vector network analyzer, 4 ports, 8.5 GHz, N	R&S®ZNB8			1311.6010K44
Vector network analyzer, 2 ports, 20 GHz, 3.5 mm	R&S®ZNB20			1311.6010K62
Vector network analyzer, 4 ports, 20 GHz, 3.5 mm	R&S®ZNB20			1311.6010K64
Vector network analyzer, 2 ports, 40 GHz, 2.92 mm	R&S®ZNB40			1311.6010K72
Vector network analyzer, 2 ports, 40 GHz, 2.92 mm	R&S®ZNB40			1311.6010K82
Vector network analyzer, 4 ports, 40 GHz, 2.92 mm	R&S®ZNB40			1311.6010K84
<b>Options</b>				
<b>Extended power range</b>				
Extended power range for 2-port R&S®ZNB4	R&S®ZNB4-B22	•		1316.0210.02
Extended power range for 4-port R&S®ZNB4	R&S®ZNB4-B24	•		1316.0233.02
Extended power range for 2-port R&S®ZNB8	R&S®ZNB8-B22	•		1316.0227.02
Extended power range for 4-port R&S®ZNB8	R&S®ZNB8-B24	•		1316.0240.02
Extended power range for 2-port R&S®ZNB20	R&S®ZNB20-B22	•		1317.8950.02
Extended power range for 4-port R&S®ZNB20	R&S®ZNB20-B24	•		1317.8967.02
Extended power range for 2-port R&S®ZNB40	R&S®ZNB40-B22	•		1317.8973.02
Extended power range for 4-port R&S®ZNB40	R&S®ZNB40-B24	•		1332.8112.02
<b>Receiver step attenuators</b>				
Receiver step attenuator, port 1, for R&S®ZNB4	R&S®ZNB4-B31	•		1316.0185.02
Receiver step attenuator, port 2, for R&S®ZNB4	R&S®ZNB4-B32	•		1316.0179.02
Receiver step attenuator, port 3, for R&S®ZNB4	R&S®ZNB4-B33	•		1316.0262.02
Receiver step attenuator, port 4, for R&S®ZNB4	R&S®ZNB4-B34	•		1316.0433.02
Receiver step attenuator, port 1, for R&S®ZNB8	R&S®ZNB8-B31	•		1316.0191.02
Receiver step attenuator, port 2, for R&S®ZNB8	R&S®ZNB8-B32	•		1316.0204.02
Receiver step attenuator, port 3, for R&S®ZNB8	R&S®ZNB8-B33	•		1316.0162.02
Receiver step attenuator, port 4, for R&S®ZNB8	R&S®ZNB8-B34	•		1316.0440.02
<b>Extended dynamic range <sup>12</sup></b>				
Extended dynamic range for 2-port R&S®ZNB4	R&S®ZNB4-B52			1319.4975.02
Extended dynamic range for 4-port R&S®ZNB4	R&S®ZNB4-B54			1319.4981.02
Extended dynamic range for 2-port R&S®ZNB8	R&S®ZNB8-B52			1319.4998.02
Extended dynamic range for 4-port R&S®ZNB8	R&S®ZNB8-B54			1319.5007.02
Bias tees for R&S®ZNB4 and R&S®ZNB8 with 2 ports	R&S®ZNB-B1	•		1316.1700.02
Bias tees for R&S®ZNB4 and R&S®ZNB8 with 4 ports	R&S®ZNB-B1	•		1316.1700.04
Second internal generator for 4-port R&S®ZNB4 and 4-port R&S®ZNB8	R&S®ZNB-B2	•		1317.7954.02
Second internal generator for 4-port R&S®ZNB20	R&S®ZNB20-B2	•		1317.8980.02
Second internal generator for 4-port R&S®ZNB40	R&S®ZNB40-B2	•		1332.8129.02
Precision frequency reference (OCXO)	R&S®ZNB-B4	•		1316.1769.02
GPIB interface	R&S®ZNB-B10	•	•	1311.5995.02
Device control	R&S®ZNB-B12	•	•	1319.5088.02
Handler I/O	R&S®ZNB-B14	•	•	1316.2459.05
RFFE GPIO interface <sup>13</sup>	R&S®ZNB-B15	•	•	1323.9355.02
RFFE GPIO interface <sup>13</sup> including voltage/current measurement	R&S®ZNB-B15	•	•	1323.9355.03
Additional removable SSD, 512 Gbyte, Windows 10 for LPW11	R&S®ZNB-B19	•	•	1334.3860.02
Additional removable hard disk, 500 Gbyte, 64 bit, for LPW11	R&S®ZNB-B19	•	•	1323.9490.10
Additional removable hard disk, 500 Gbyte, 64 bit, for LPW10	R&S®ZNB-B19	•	•	1323.9490.07
Additional removable hard disk, 500 Gbyte, 32 bit, for LPW10	R&S®ZNB-B19	•	•	1323.9490.02
<b>DC inputs</b>				
DC inputs	R&S®ZNB-B81	•		1316.0004.02
Time domain analysis	R&S®ZNB-K2	•	•	1316.0156.02
Distance-to-fault	R&S®ZNB-K3	•	•	1350.5057.02
Extended time domain analysis	R&S®ZNB-K20	•	•	1326.8072.02
Frequency conversion	R&S®ZNB-K4	•	•	1316.2994.02
Intermodulation measurements <sup>14</sup>	R&S®ZNB-K14	•	•	1317.8373.02
10 MHz receiver bandwidth	R&S®ZNB-K17	•	•	1316.1881.02

<sup>10</sup> Option may also be ordered at a later stage, upgrade in service.

<sup>11</sup> Option may be installed by the customer on site.

<sup>12</sup> The R&S®ZNBx-B52/-B54 options cannot be combined with the R&S®ZNBx-B1 option and/or the R&S®ZNBx-B31/-B32/-B33/-B34 options.

<sup>13</sup> The R&S®ZNB-B15 option cannot be combined with the R&S®ZNBx-B1 option.

<sup>14</sup> The R&S®ZNB-K14 requires R&S®ZNB-K4.

Designation	Type	Retrofit <sup>10</sup>	On site <sup>11</sup>	Order No.
1 millihertz frequency resolution	R&S®ZNB-K19	●	●	1317.8573.02
Real-time measurement uncertainty analysis	R&S®ZNB-K50	●	●	3644.5977.02
Real-time measurement uncertainty analysis, preinstalled	R&S®ZNB-K50P			1338.1810.02
Easy deembedding	R&S®ZN-K210	●	●	1328.8592.02
In-situ deembedding	R&S®ZN-K220	●		1328.8605.02
Smart fixture deembedding	R&S®ZN-K230	●		1328.8611.02
Delta-L PCB characterization	R&S®ZN-K231	●		1328.8628.02
19" rackmount kit	R&S®ZZA-KN5	●	●	1175.3040.00
Direct control cable	R&S®ZN-B121	●	●	1323.9290.00
<b>Upgrade kits</b>				
Upgrade kit from Windows 7 to Windows 10 for R&S®ZNB <sup>15</sup>	R&S®ZNB-U10	●		1334.4450.02
Upgrade kit to LPW11 incl. SSD and Windows 10 for R&S®ZNB	R&S®ZNB-U11	●		1332.8329.02

<b>Warranty</b>			
Base unit			3 years
All other items <sup>16</sup>			1 year
<b>Options</b>			
Extended warranty, one year	R&S®WE1		Please contact your local Rohde & Schwarz sales office.
Extended warranty, two years	R&S®WE2		
Extended warranty with calibration coverage, one year	R&S®CW1		
Extended warranty with calibration coverage, two years	R&S®CW2		
Extended warranty with accredited calibration coverage, one year	R&S®AW1		
Extended warranty with accredited calibration coverage, two years	R&S®AW2		

**Extended warranty with a term of one and two years (WE1 and WE2)**

Repairs carried out during the contract term are free of charge <sup>17</sup>. Necessary calibration and adjustments carried out during repairs are also covered.

**Extended warranty with calibration coverage (CW1 and CW2)**

Enhance your extended warranty by adding calibration coverage at a package price. This package ensures that your Rohde & Schwarz product is regularly calibrated, inspected and maintained during the term of the contract. It includes all repairs <sup>17</sup> and calibration at the recommended intervals as well as any calibration carried out during repairs or option upgrades.

**Extended warranty with accredited calibration (AW1 and AW2)**

Enhance your extended warranty by adding accredited calibration coverage at a package price. This package ensures that your Rohde & Schwarz product is regularly calibrated under accreditation, inspected and maintained during the term of the contract. It includes all repairs <sup>17</sup> and accredited calibration at the recommended intervals as well as any accredited calibration carried out during repairs or option upgrades.

<sup>15</sup> Requires internal PC LPW11.

<sup>16</sup> For options that are installed, the remaining base unit warranty applies if longer than 1 year. Exception: all batteries have a 1 year warranty.

<sup>17</sup> Excluding defects caused by incorrect operation or handling and force majeure. Wear-and-tear parts are not included.







## Service that adds value

- ▶ Worldwide
- ▶ Local and personalized
- ▶ Customized and flexible
- ▶ Uncompromising quality
- ▶ Long-term dependability

## Rohde & Schwarz

The Rohde & Schwarz electronics group offers innovative solutions in the following business fields: test and measurement, broadcast and media, secure communications, cybersecurity, monitoring and network testing. Founded more than 80 years ago, the independent company which is headquartered in Munich, Germany, has an extensive sales and service network with locations in more than 70 countries.

[www.rohde-schwarz.com](http://www.rohde-schwarz.com)

## Sustainable product design

- ▶ Environmental compatibility and eco-footprint
- ▶ Energy efficiency and low emissions
- ▶ Longevity and optimized total cost of ownership

Certified Quality Management  
**ISO 9001**

Certified Environmental Management  
**ISO 14001**

## Rohde & Schwarz training

[www.training.rohde-schwarz.com](http://www.training.rohde-schwarz.com)

## Rohde & Schwarz customer support

[www.rohde-schwarz.com/support](http://www.rohde-schwarz.com/support)

