

R&S® ZNB VECTOR NETWORK ANALYZER

Specifications

3
year
warranty

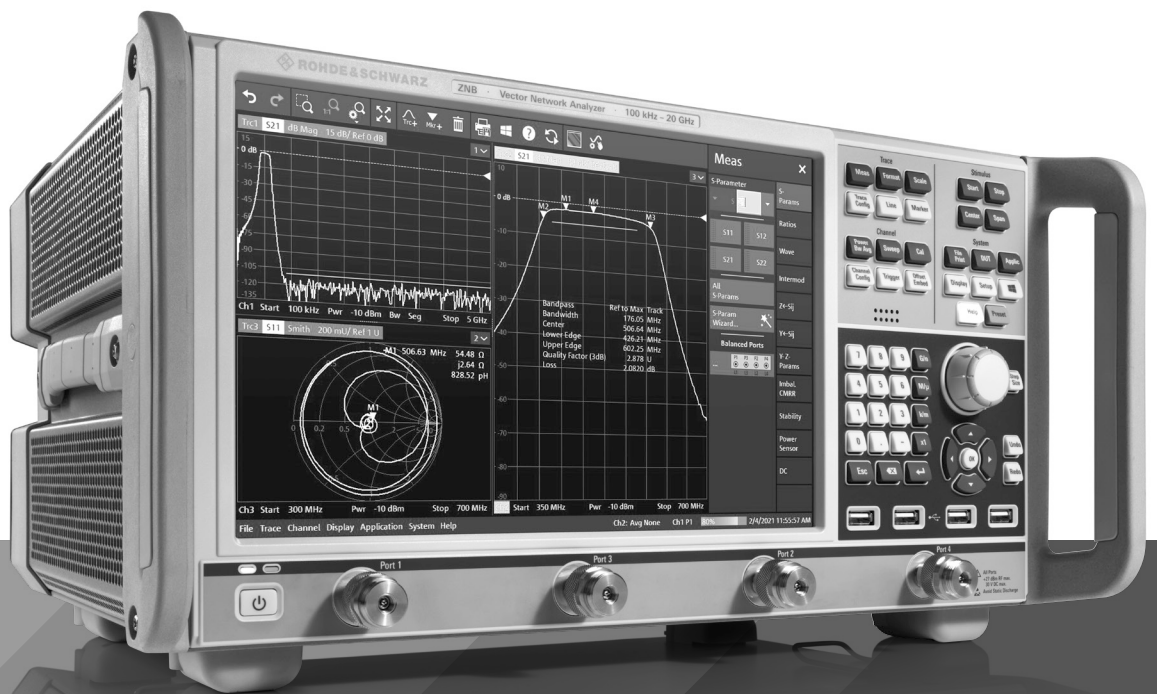

Data Sheet
Version 04.00

ROHDE & SCHWARZ

Make ideas real



CONTENTS

Definitions	3
Measurement range	4
Dynamic range	5
Measurement speed	6
Measurement accuracy of the R&S®ZNB4 and the R&S®ZNB8	8
Measurement accuracy of the R&S®ZNB20	9
Effective system data	10
Factory-calibrated system data	10
Test port output	13
Test port input	15
Additional front panel connectors	16
Display	16
Rear panel connectors	16
Options	17
R&S®ZNB-B1.....	17
R&S®ZNB-B4.....	17
R&S®ZNB-B10.....	17
R&S®ZNB-B12.....	17
R&S®ZNB-B14.....	17
R&S®ZNB4-B22/-B24, R&S®ZNB8-B22/-B24 and R&S®ZNB20-B22/-B24.....	18
R&S®ZNB4-B31/-B32/-B33/-B34 and R&S®ZNB8-B31/-B32/-B33/-B34.....	18
R&S®ZNB4-B52/-B54 and R&S®ZNB8-B52/-B54.....	18
R&S®ZNB-B81.....	19
R&S®ZNB-K980.....	20
General data	21
Dimensions (in mm)	22
Ordering information	24

Definitions

General

Product data applies under the following conditions:

- Three hours storage at ambient temperature followed by 30 minutes warm-up operation
- Specified environmental conditions met
- Recommended calibration interval adhered to
- All internal automatic adjustments performed, if applicable

Specifications with limits

Represent warranted product performance by means of a range of values for the specified parameter. These specifications are marked with limiting symbols such as $<$, \leq , $>$, \geq , \pm , or descriptions such as maximum, limit of, minimum. Compliance is ensured by testing or is derived from the design. Test limits are narrowed by guard bands to take into account measurement uncertainties, drift and aging, if applicable.

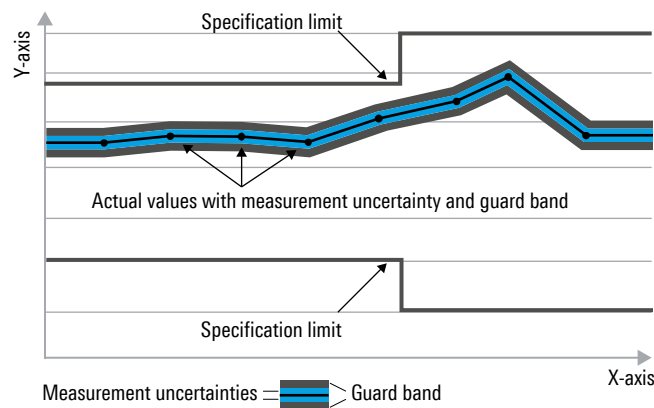

Non-traceable specifications with limits (n. trc.)

Represent product performance that is specified and tested as described under “Specifications with limits” above. However, product performance in this case cannot be warranted due to the lack of measuring equipment traceable to national metrology standards. In this case, measurements are referenced to standards used in the Rohde & Schwarz laboratories.

Specifications without limits

Represent warranted product performance for the specified parameter. These specifications are not specially marked and represent values with no or negligible deviations from the given value (e.g. dimensions or resolution of a setting parameter). Compliance is ensured by design.

Typical data (typ.)

Characterizes product performance by means of representative information for the given parameter. When marked with $<$, $>$ or as a range, it represents the performance met by approximately 80 % of the instruments at production time. Otherwise, it represents the mean value.

Nominal values (nom.)

Characterize product performance by means of a representative value for the given parameter (e.g. nominal impedance). In contrast to typical data, a statistical evaluation does not take place and the parameter is not tested during production.

Measured values (meas.)

Characterize expected product performance by means of measurement results gained from individual samples.

Uncertainties

Represent limits of measurement uncertainty for a given measurand. Uncertainty is defined with a coverage factor of 2 and has been calculated in line with the rules of the Guide to the Expression of Uncertainty in Measurement (GUM), taking into account environmental conditions, aging, wear and tear.

Device settings and GUI parameters are designated with the format “parameter: value”.

Non-traceable specifications with limits, typical data as well as nominal and measured values are not warranted by Rohde & Schwarz.

In line with the 3GPP/3GPP2 standard, chip rates are specified in million chips per second (Mcps), whereas bit rates and symbol rates are specified in billion bits per second (Gbps), million bits per second (Mbps), thousand bits per second (kbps), million symbols per second (MSPS) or thousand symbols per second (ksps), and sample rates are specified in million samples per second (Msample/s). Gbps, Mcps, Mbps, MSPS, kbps, ksps and Msample/s are not SI units.

Measurement range

Impedance		50 Ω
Test port connector	R&S®ZNB4	type N, female
	R&S®ZNB8	type N, female
	R&S®ZNB20	3.5 mm, male, ruggedized
Number of test ports	R&S®ZNB4	2 or 4
	R&S®ZNB8	2 or 4
	R&S®ZNB20	2 or 4
Frequency range ¹	R&S®ZNB4	9 kHz to 4.5 GHz
	R&S®ZNB8	9 kHz to 8.5 GHz
	R&S®ZNB20	100 kHz to 20 GHz

Static frequency accuracy	The static frequency accuracy is determined with the formula <i>(time since last adjustment in years × aging per year) + temperature drift + achievable initial calibration accuracy</i> using the values specified below. Depending on whether or not the R&S®ZNB-B4 precision frequency reference option is installed, the standard or the improved value have to be taken into account.	
Aging per year	standard	$\pm 1 \times 10^{-6}$
	with R&S®ZNB-B4 precision frequency reference option	$\pm 1 \times 10^{-7}$
Temperature drift (+5 °C to +40 °C)	standard	$\pm 1 \times 10^{-6}$
	with R&S®ZNB-B4 precision frequency reference option	$\pm 1 \times 10^{-8}$
Achievable initial calibration accuracy	standard	$\pm 5 \times 10^{-7}$
	with R&S®ZNB-B4 precision frequency reference option	$\pm 5 \times 10^{-8}$

Frequency resolution		1 Hz
Number of measurement points	per trace	1 to 100 001
Measurement bandwidth	1/1.5/2/3/5/7 steps	
	base unit	1 Hz to 1 MHz
	with R&S®ZNB-K17 option for increased IF bandwidth	1 Hz to 10 MHz

¹ Specified and typical data given in this data sheet applies to the R&S®ZNB4, the R&S®ZNB8 and the R&S®ZNB20; note their respective frequency ranges.

Dynamic range

The receiver noise floor referred to in the following is defined as the RMS value of the data trace of the transmission magnitude, which is produced by noise and crosstalk with the test ports short-circuited. The specification applies at 10 Hz measurement bandwidth, without user correction applied. The dynamic range can be increased by using a measurement bandwidth of 1 Hz. Crosstalk does not limit the dynamic range. Dynamic range performance is specified between port 1 and port 2 as well as between port 3 and port 4 (4-port model). Otherwise, dynamic range performance is typical.

	Specification	Typical	
System dynamic range ²	R&S®ZNB4 and the R&S®ZNB8 (without options, for extended dynamic range refer to Options)		
	9 kHz to 100 kHz	≥ 110 dB	122 dB
	100 kHz to 50 MHz	≥ 125 dB	138 dB
	50 MHz to 7GHz	≥ 130 dB	140 dB
	7 GHz to 8.5 GHz	≥ 120 dB	130 dB
	R&S®ZNB20		
	100 kHz to 300 kHz	≥ 95 dB	108 dB
	300 kHz to 1 MHz	≥ 105 dB	120 dB
	1 MHz to 10 MHz	≥ 115 dB	125 dB
	10 MHz to 100 MHz	≥ 120 dB	130 dB
100 MHz to 9 GHz	≥ 125 dB	135 dB	
9 GHz to 20 GHz	≥ 120 dB	130 dB	

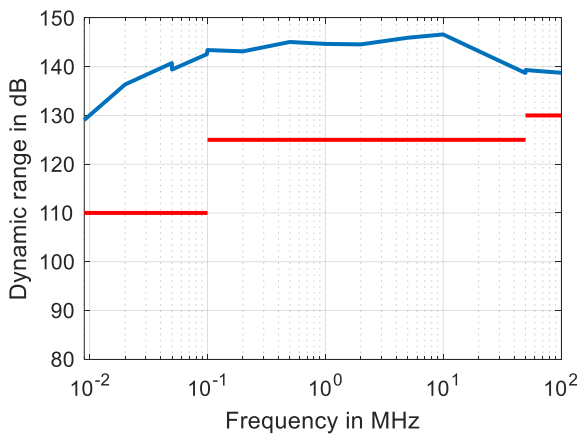

Typical dynamic range in dB versus frequency of the R&S®ZNB8 (without extended dynamic range option)

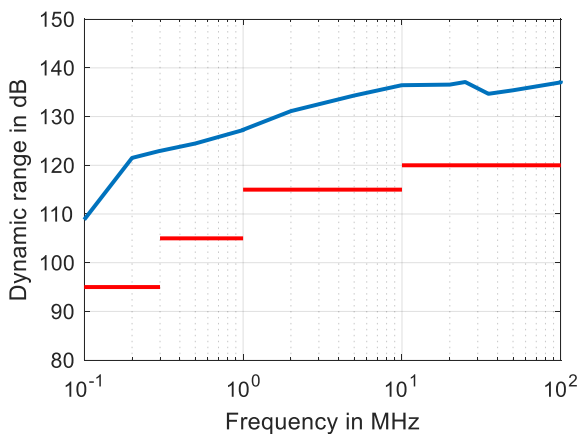
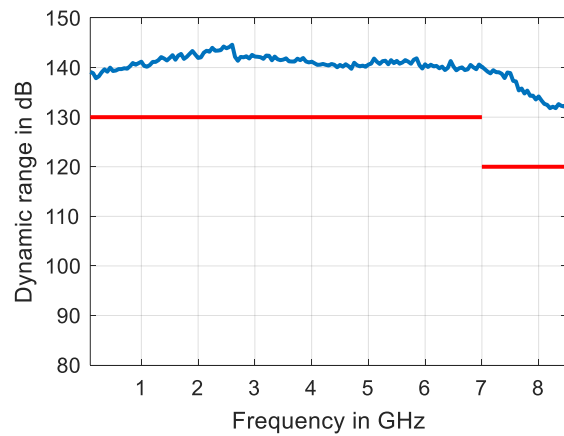

Typical dynamic range in dB versus frequency of the R&S®ZNB20

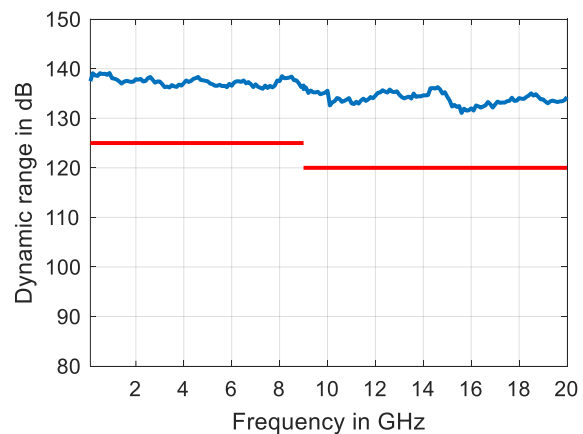

² Difference between maximum output power and receiver noise floor.

Measurement speed

Measured with firmware version 3.20 and Windows 10.

Measurement time	for 201 measurements points, with 200 MHz span, 1 MHz measurement bandwidth	T_{SWEEP}		T_{CYCLE}	
	with 900 MHz center frequency	< 1.5 ms		< 2.5 ms	
	with 5.1 GHz center frequency	< 1.3 ms		< 2 ms	
Acquisition time per point (T_{ACQ})	1 MHz measurement bandwidth, CW mode	2.5 μ s			
Sampling time per point (T_{SAMPLE}) IF filter: normal	at 1 MHz measurement bandwidth	860 ns			
	at 10 MHz measurement bandwidth	312 ns			
Time for measurement and data transfer	for 201 measurements points, with 800 MHz start frequency, 1 GHz stop frequency, 1 MHz measurement bandwidth ³	VXI11	HiSLIP	IEC/IEEE	USB 3.0
		over 1 Gbit/s LAN			
		3.8 ms	3.5 ms	4.0 ms	3.0 ms
Data transfer time	for 201 measurements points (magnitude)	1.0 ms	0.8 ms	1.5 ms	0.5 ms
Switching time between channels	with a maximum of 2001 points	< 5 ms			
Switching time between two preloaded instrument settings	with a maximum of 2001 points	< 5 ms			

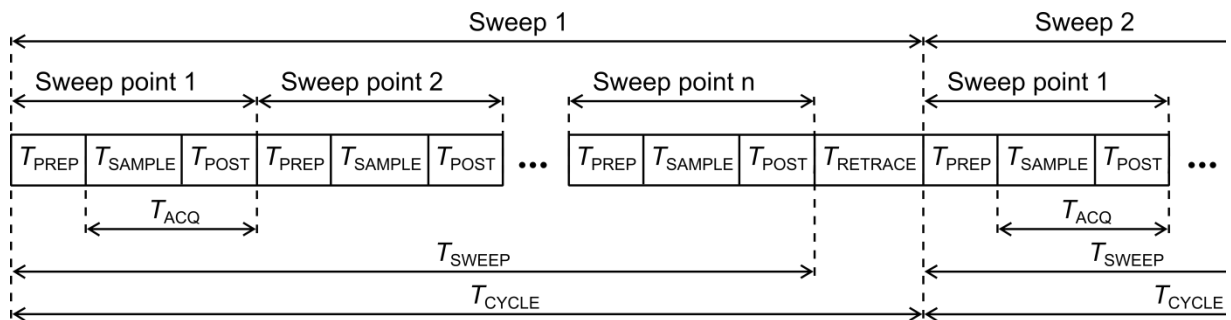

- T_{PREP} Preparation time required to set up the internal hardware components
- T_{SAMPLE} Sampling time (approximately equal to the settling time of the digital filters)
- T_{POST} Time required for hardware postprocessing
- T_{ACQ} Acquisition time ($T_{SAMPLE} + T_{POST}$)
- T_{SWEEP} Time required for one sweep
- $T_{RETRACE}$ Time between two sweeps
- T_{CYCLE} Sweep cycle time ($T_{SWEEP} + T_{RETRACE}$)

Measurement sequence

³ In continuous mode, no additional time is needed for data transfer as this occurs simultaneously during the measurement.

Nominal sweep times in ms versus number of measurement points ⁴ of the R&S®ZNB4 and R&S®ZNB8										
Number of measurement points	51		201		401		1601		5001	
Sweep mode (stepped, swept)	swept	step	swept	step	swept	step	swept	step	swept	step
R&S®ZNB4 and R&S®ZNB8										
800 MHz start frequency, 1 GHz stop frequency, Memory AGC on, 500 kHz measurement bandwidth										
With correction switched off	0.7	1.2	1.2	3.0	2.0	3.7	5.7	6.7	14.6	17.0
With 2-port TOSM calibration	1.0	1.9	2.3	5.4	3.9	6.5	10.3	12.2	27.6	32.8
With 4-port TOSM calibration	1.7	3.5	4.9	10.5	8.0	12.5	22.5	25.9	57.3	67.5
1 MHz start frequency, 4.5 GHz stop frequency, Memory AGC on, 500 kHz measurement bandwidth										
With correction switched off	2.3	2.4	4.1	4.2	4.0	6.7	7.8	18.8	17.4	49.5
With 2-port TOSM calibration	4.3	4.3	8.0	8.0	7.2	12.6	14.3	36.9	32.9	98.0
With 4-port TOSM calibration	8.2	8.3	16.2	16.0	14.4	24.8	29.5	73.9	67.5	211
1 MHz start frequency, 8.5 GHz stop frequency, Memory AGC on, 500 kHz measurement bandwidth										
With correction switched off	2.6	2.7	4.5	4.6	6.8	6.8	8.4	18.8	17.7	50.0
With 2-port TOSM calibration	4.9	5.0	8.8	8.9	13.1	13.2	16.7	37.2	35.5	99.5
With 4-port TOSM calibration	9.5	9.6	17.2	17.3	26.2	26.5	33.5	74.2	70.8	213

Nominal sweep times in ms versus number of measurement points ⁴ of the R&S®ZNB20										
9 GHz start frequency, 10 GHz stop frequency, Memory AGC on, 500 kHz measurement bandwidth										
With correction switched off	1.1	1.1	1.5	2.5	2.2	4.3	5.6	10.9	15.3	18.1
With 2-port TOSM calibration	2.9	2.9	3.6	5.6	4.8	8.7	11.9	21.6	30.9	37.6
With 4-port TOSM calibration	5.8	5.8	7.7	10.8	10.0	17.5	23.0	44.0	60.5	115
1 MHz start frequency, 20 GHz stop frequency, Memory AGC on, 500 kHz measurement bandwidth										
With correction switched off	11.7	11.6	16.1	16.1	18.9	18.8	29.0	29.0	33.5	56.7
With 2-port TOSM calibration	23.4	23.3	32.2	32.1	37.7	37.6	58.7	58.6	66.0	114
With 4-port TOSM calibration	48.2	48.1	66.8	66.7	78.2	78.2	120	120	138	248

⁴ Sweep time is to be understood as cycle time; static frequency accuracy of the instrument applies; measured with firmware version 3.15, Windows 10.

Measurement accuracy of the R&S®ZNB4 and the R&S®ZNB8

This data is valid between +18 °C and +28 °C, provided the temperature has not varied by more than 1 °C since calibration. Validity of the data is conditional on the use of an R&S®ZV-Z270 calibration kit. This calibration kit is used to achieve the effective system data specified below. Frequency points, measurement bandwidth and sweep time have to be identical for measurement and calibration (no interpolation allowed).

Uncertainty of transmission measurements		Magnitude	Phase
9 kHz to 100 kHz	+0 dB to -20 dB	0.05 dB	0.5°
	-20 dB to -40 dB	0.07 dB	0.6°
	-40 dB to -50 dB	0.12 dB	1.0°
	-50 dB to -60 dB	0.32 dB	2.3°
> 100 kHz to 8.5 GHz	+0 dB to -20 dB	0.04 dB	0.5°
	-20 dB to -40 dB	0.06 dB	0.6°
	-40 dB to -50 dB	0.09 dB	0.9°
	-50 dB to -60 dB	0.19 dB	1.5°

Specifications are based on a matched DUT, a measurement bandwidth of 10 Hz and a nominal source power of -10 dBm.

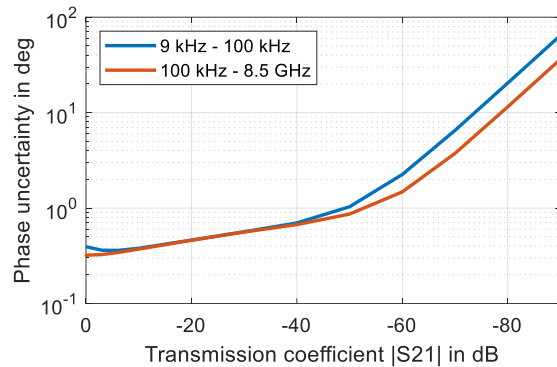
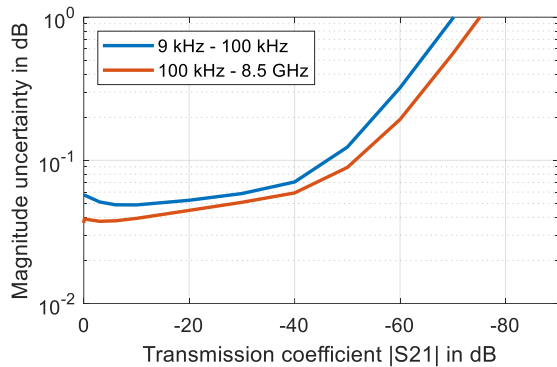

Typical uncertainty of transmission magnitude and transmission phase measurements for the R&S®ZNB4 in the frequency range from 9 kHz to 4.5 GHz, for the R&S®ZNB8 in the frequency range from 9 kHz to 8.5 GHz; analysis conditions: $S_{11} = S_{22} = 0$, cal. power: -10 dBm, meas. power: -10 dBm

Uncertainty of reflection measurements	Logarithmic			Linear	
	Reflection level	Magnitude	Phase	Reflection range	Magnitude
9 kHz to 2 GHz	0 dB	0.1 dB	0.6°	0 dB to -15 dB	0.010
	-15 dB	0.2 dB	1.5°	-15 dB to -25 dB	0.005
	-25 dB	0.7 dB	5.6°	-25 dB to -35 dB	0.005
> 2 GHz to 8.5 GHz	0 dB	0.1 dB	0.9°	0 dB to -15 dB	0.015
	-15 dB	0.3 dB	2.0°	-15 dB to -25 dB	0.007
	-25 dB	1.0 dB	7.5°	-25 dB	0.007

Specifications are based on an isolating DUT, a measurement bandwidth of 10 Hz and a nominal source power of -10 dBm.

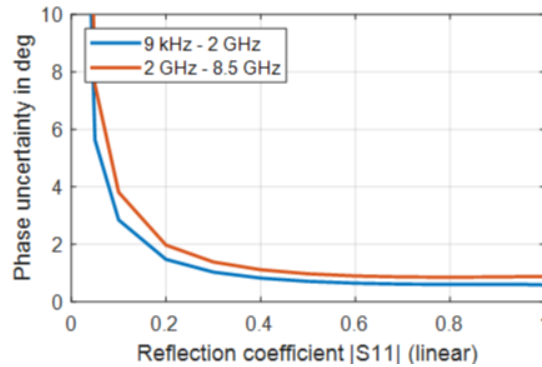
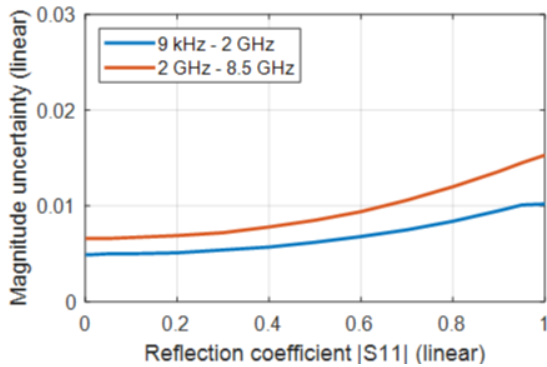

Typical uncertainty of reflection magnitude and reflection phase measurements for the R&S®ZNB4 in the frequency range from 9 kHz to 4.5 GHz, for the R&S®ZNB8 in the frequency range from 9 kHz to 8.5 GHz; analysis conditions: $S_{12} = S_{21} = 0$, cal. power: -10 dBm, meas. power: -10 dBm

Measurement accuracy of the R&S®ZNB20

This data is valid between +18 °C and +28 °C, provided the temperature has not varied by more than 1 °C since calibration. Validity of the data is conditional on the use of an R&S®ZN-Z235 calibration kit. This calibration kit is used to achieve the effective system data specified below. Frequency points, measurement bandwidth and sweep time have to be identical for measurement and calibration (no interpolation allowed).

Uncertainty of transmission measurements		Magnitude	Phase
100 kHz to 10 MHz	+0 dB to -20 dB	0.04 dB	0.4°
	-20 dB to -40 dB	0.11 dB	0.9°
	-40 dB to -50 dB	0.32 dB	2.2°
	-50 dB to -60 dB	0.98 dB	6.5°
> 10 MHz to 10 GHz	+0 dB to -20 dB	0.05 dB	0.5°
	-20 dB to -40 dB	0.06 dB	0.7°
	-40 dB to -50 dB	0.09 dB	0.9°
	-50 dB to -60 dB	0.19 dB	1.5°
> 10 GHz to 20 GHz	+0 dB to -20 dB	0.05 dB	0.7°
	-20 dB to -40 dB	0.07 dB	0.8°
	-40 dB to -50 dB	0.10 dB	1.0°
	-50 dB to -60 dB	0.24 dB	1.8°

Specifications are based on a matched DUT, a measurement bandwidth of 10 Hz and a nominal source power of -10 dBm.

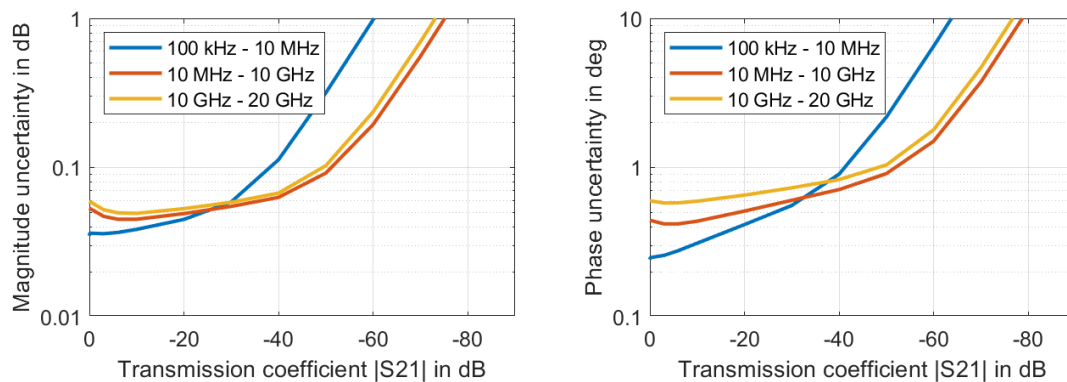

Typical uncertainty of transmission magnitude and transmission phase measurements for the R&S®ZNB20 in the frequency range from 100 kHz to 20 GHz; analysis conditions: $S_{11} = S_{22} = 0$, cal. power -10 dBm, meas. power -10 dBm

Uncertainty of reflection measurements	Logarithmic			Linear	
	Reflection level	Magnitude	Phase	Reflection range	Magnitude
100 kHz to 10 GHz	0 dB	0.1	0.7°	0 dB to -15 dB	0.013
	-15 dB	0.3	2.0°	-15 dB to -25 dB	0.007
	-25 dB	1.0	7.7°	-25 dB to -35 dB	0.007
> 10 GHz to 20 GHz	0 dB	0.2	1.1°	0 dB to -15 dB	0.019
	-15 dB	0.4	2.4°	-15 dB to -25 dB	0.008
	-25 dB	1.2	9.1°	-25 dB to -35 dB	0.008

Specifications are based on an isolating DUT, a measurement bandwidth of 10 Hz and a nominal source power of -10 dBm.

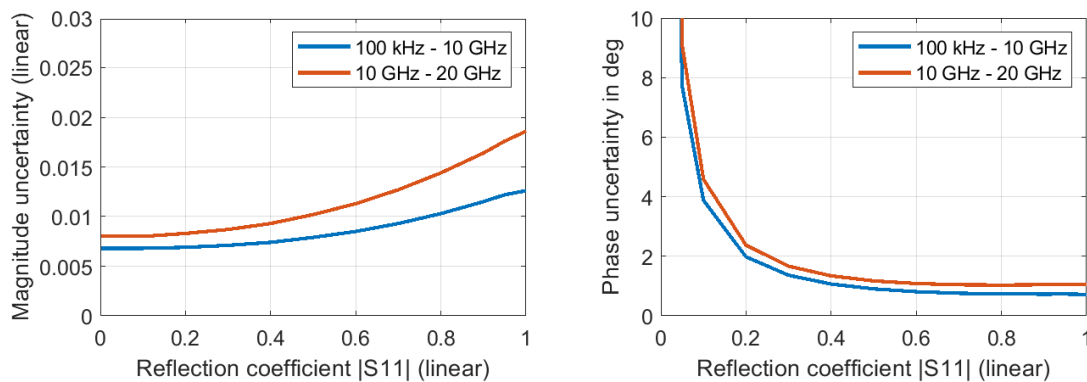

Typical uncertainty of reflection magnitude and reflection phase measurements for the R&S®ZNB20 in the frequency range from 100 kHz to 20 GHz; analysis conditions: $S_{12} = S_{21} = 0$, cal. power: -10 dBm, meas. power: -10 dBm

Effective system data

This data is valid between +18 °C and +28 °C, provided the temperature has not varied by more than 1 °C since calibration. Frequency points, measurement bandwidth and sweep time have to be identical for measurement and calibration (no interpolation allowed). The data is based on a measurement bandwidth of 10 Hz.

R&S®ZNB4 and R&S®ZNB8, calibrated using R&S®ZV-Z270	9 kHz to 100 kHz	100 kHz to 4.5 GHz	4.5 GHz to 8.5 GHz
Directivity	≥ 46 dB	≥ 45 dB	≥ 40 dB
Source match	≥ 41 dB	≥ 40 dB	≥ 36 dB
Load match	≥ 44 dB	≥ 45 dB	≥ 40 dB
Reflection tracking	≤ 0.02 dB	≤ 0.02 dB	≤ 0.05 dB
Transmission tracking	≤ 0.028 dB	≤ 0.018 dB	≤ 0.09 dB

R&S®ZNB20, calibrated using R&S®ZN-Z235	100 kHz to 10 GHz	10 GHz to 20 GHz
Directivity	≥ 46 dB	≥ 43 dB
Source match	≥ 43 dB	≥ 38 dB
Load match	≥ 45 dB	≥ 42 dB
Reflection tracking	≤ 0.05 dB	≤ 0.09 dB
Transmission tracking	≤ 0.03 dB	≤ 0.03 dB

Factory-calibrated system data

This data is valid between +18 °C and +28 °C. It is based on a source power of –10 dBm and a measurement bandwidth of 1 kHz.

		Specification	Typical
Directivity	R&S®ZNB4, R&S®ZNB8 and R&S®ZNB20		
	9 kHz to 50 kHz	≥ 20 dB	35 dB
	50 kHz to 4.5 GHz	≥ 30 dB	50 dB
	4.5 GHz to 10 GHz	≥ 30 dB	50 dB
	10 GHz to 20 GHz	≥ 25 dB	35 dB
Source match	R&S®ZNB4, R&S®ZNB8 and R&S®ZNB20		
	9 kHz to 50 kHz	≥ 20 dB	35 dB
	50 kHz to 4.5 GHz	≥ 30 dB	50 dB
	4.5 GHz to 10 GHz	≥ 30 dB	50 dB
	10 GHz to 20 GHz	≥ 25 dB	35 dB
Reflection tracking	R&S®ZNB4, R&S®ZNB8 and R&S®ZNB20		
	9 kHz to 20 GHz	≤ 0.5 dB	0.05 dB
Transmission tracking	R&S®ZNB4, R&S®ZNB8 and R&S®ZNB20		
	9 kHz to 20 GHz	≤ 0.5 dB	0.05 dB
Load match	R&S®ZNB4 and R&S®ZNB8		
	9 kHz to 50 kHz	≥ 10 dB	15 dB
	50 kHz to 8.5 GHz	≥ 20 dB	25 dB
	R&S®ZNB20		
	100 kHz to 1 MHz	≥ 16 dB	30 dB
	1 MHz to 100 MHz	≥ 20 dB	35 dB
	100 MHz to 10 GHz	≥ 12 dB	16 dB
	10 GHz to 20 GHz	≥ 10 dB	14 dB

Trace stability		IF bandwidth	Specification	Typical
Trace noise magnitude (RMS) at 0 dBm source power, 0 dB reflection	R&S®ZNB4 and R&S®ZNB8			
	9 kHz to 20 kHz	1 kHz	≤ 0.008 dB	0.004 dB
	20 kHz to 100 kHz	1 kHz	≤ 0.004 dB	0.001 dB
	100 kHz to 100 MHz	10 kHz	≤ 0.004 dB	0.001 dB
	100 MHz to 8.5 GHz	10 kHz	≤ 0.004 dB	0.002 dB
Trace noise phase (RMS) at 0 dBm source power, 0 dB reflection	R&S®ZNB4 and R&S®ZNB8			
	9 kHz to 20 kHz	1 kHz	≤ 0.070°	0.040°
	20 kHz to 100 kHz	1 kHz	≤ 0.035°	0.010°
	100 kHz to 100 MHz	10 kHz	≤ 0.035°	0.005°
	100 MHz to 8.5 GHz	10 kHz	≤ 0.035°	0.020°
R&S®ZNB20				
	100 kHz to 300 kHz	10 kHz	≤ 0.006 dB	0.002 dB
	300 kHz to 20 GHz	10 kHz	≤ 0.004 dB	0.0015 dB
R&S®ZNB20				
	100 kHz to 300 kHz	10 kHz	≤ 0.050°	0.015°
	300 kHz to 20 GHz	10 kHz	≤ 0.035°	0.01°

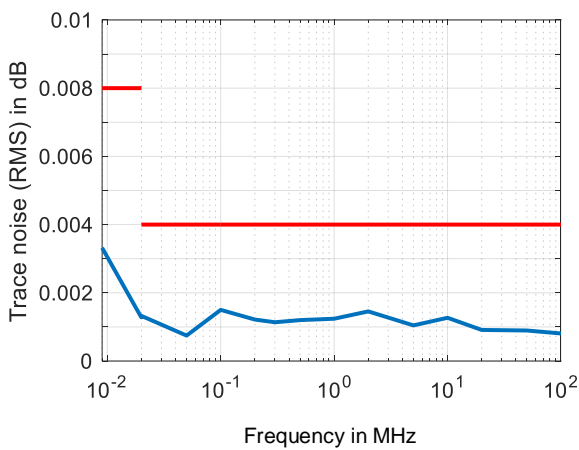

Typical trace noise (RMS) in dB versus frequency of the R&S®ZNB8

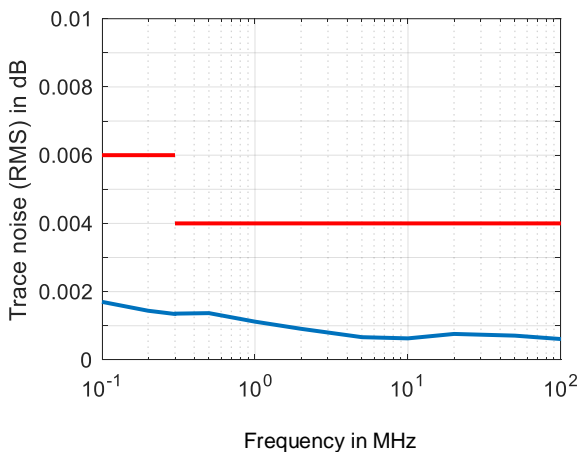
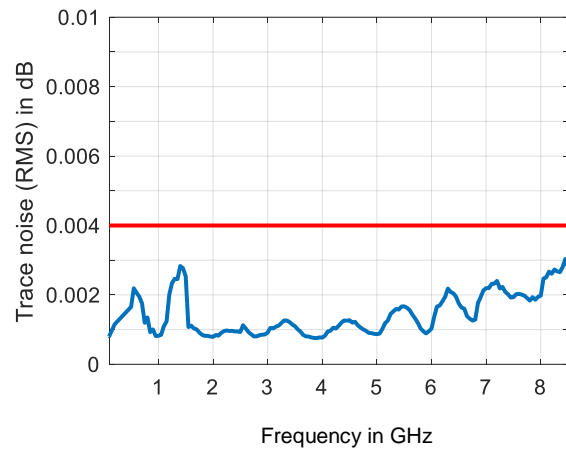

Typical trace noise (RMS) in dB versus frequency of the R&S®ZNB20

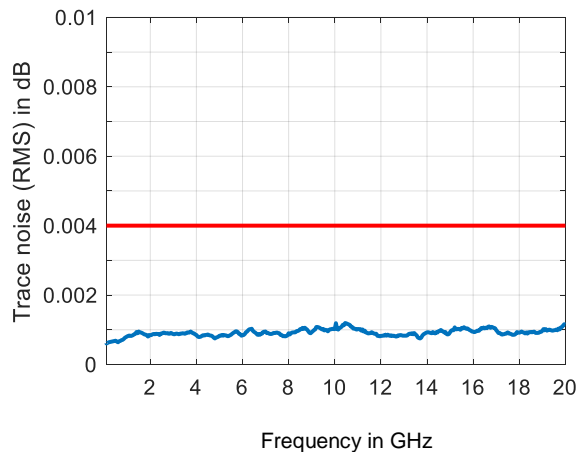

Measured temperature stability ⁵		9 kHz to 100 kHz	100 kHz to 10 GHz	10 GHz to 20 GHz
Transmission magnitude at –10 dBm source power	R&S®ZNB4 and R&S®ZNB8	0.02 dB/K	0.016 dB/K	–
	R&S®ZNB20	–	0.014 dB/K	0.026 dB/K
Transmission phase ⁶ at –10 dBm source power	R&S®ZNB4 and R&S®ZNB8	0.035°/GHz/K		
	R&S®ZNB20	0.045°/GHz/K		
VNA uncertainty model, applicable for R&S®ZNB-K50 and R&S®ZNB-K50P real-time measurement uncertainty analysis options	R&S®ZNB4, R&S®ZNB8 and R&S®ZNB20			
	tracking magnitude	0.010 dB/K		0.020 dB/K
	symmetry magnitude	0.004 dB/K		0.006 dB/K
	directivity/match	–65 dB		–60 dB
	tracking phase ⁶	0.025°/GHz/K		
symmetry phase ⁶	0.020°/GHz/K			

⁵ The stability is obtained by measuring the through connection repeatedly while varying the temperature in the range 18 °C to 28 °C and observing the deviations between the measurements. A temperature drift per Kelvin is deduced.

⁶ The phase drift increases linearly with frequency. It is described only by the slope, therefore the factor between phase drift and frequency is stated.

Test port output

This data is valid in the temperature range +18 °C to +28 °C.

Parameter	Frequency range	Specification	Typical
Power range	without optional extended power range		
	R&S®ZNB4 and R&S®ZNB8		
	9 kHz to 100 MHz	-55 dBm to +10 dBm	up to +12 dBm
	100 MHz to 2.5 GHz	-55 dBm to +13 dBm	up to +15 dBm
	2.5 GHz to 7.5 GHz	-55 dBm to +10 dBm	up to +13 dBm
	7.5 GHz to 8.5 GHz	-55 dBm to +8 dBm	up to +12 dBm
	R&S®ZNB20		
	100 kHz to 10 GHz	-30 dBm to +12 dBm	up to +15 dBm
	10 GHz to 20 GHz	-30 dBm to +10 dBm	up to +13 dBm
Minimum power level	using optional extended power range (see Options)		
	R&S®ZNB4 and R&S®ZNB8		
	9 kHz to 8.5 GHz	-85 dBm	
	R&S®ZNB20		
	100 kHz to 20 GHz	-60 dBm	
Power accuracy, source power: -10 dBm	R&S®ZNB4 and R&S®ZNB8		
	9 kHz to 50 kHz	≤ 3 dB	0.5 dB
	50 kHz to 8.5 GHz	≤ 2 dB	0.3 dB
	R&S®ZNB20		
	100 kHz to 10 GHz	≤ 2 dB	0.25 dB
	10 GHz to 20 GHz	≤ 3 dB	0.5 dB
Power linearity referenced to -10 dBm	R&S®ZNB4 and R&S®ZNB8		
	source power ≥ -55 dBm	≤ 1 dB	0.3 dB
	source power < -55 dBm	≤ 2 dB	
	R&S®ZNB20		
	source power ≥ -30 dBm	≤ 1 dB	0.3 dB
	source power < -30 dBm	≤ 2 dB	0.5 dB
Power resolution		0.01 dB	
Second and third harmonics at 0 dBm	R&S®ZNB4 and R&S®ZNB8		
	20 kHz to 100 MHz	≤ -20 dBc	-30 dBc
	100 MHz to 8.5 GHz	≤ -25 dBc	-35 dBc
	R&S®ZNB20		
	100 kHz to 10 MHz	≤ -15 dBc	-25 dBc
	10 MHz to 100 MHz	≤ -20 dBc	-30 dBc
	100 MHz to 20 GHz	< -25 dBc	-35 dBc

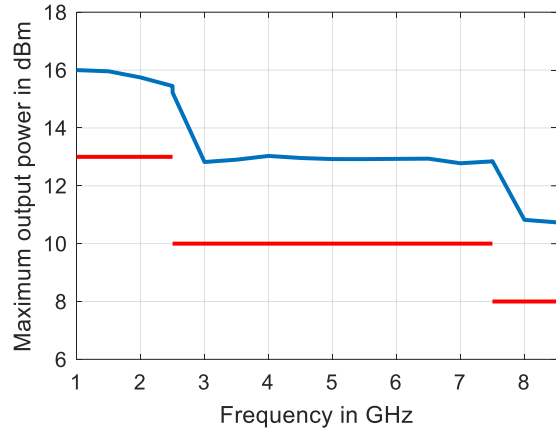
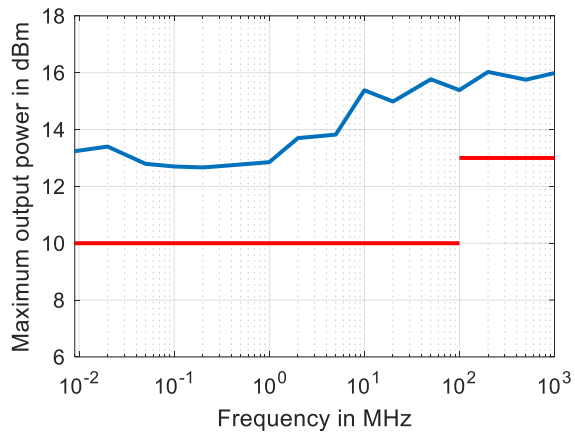

Typical maximum output power in dBm versus frequency of the R&S[®]ZNB8

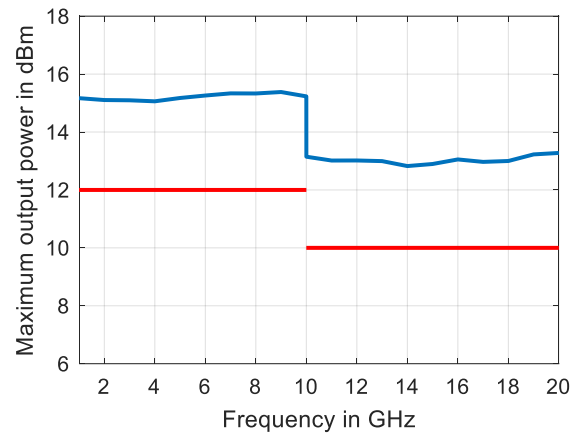
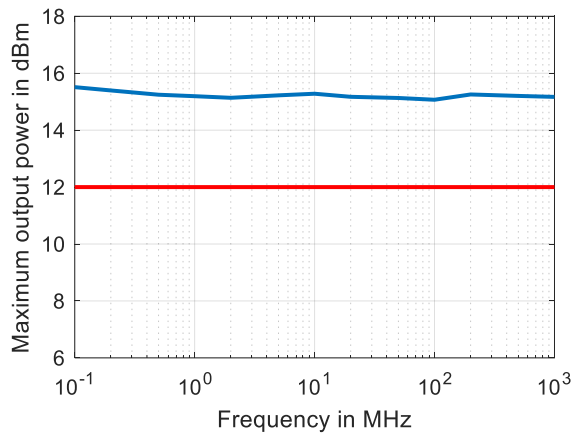

Typical maximum output power in dBm versus frequency of the R&S[®]ZNB20

Test port input

Parameter	Frequency range	Specification	Typical	Nominal
Match	R&S®ZNB4 and R&S®ZNB8			
	9 kHz to 50 kHz	> 10 dB		
	50 kHz to 8.5 GHz	> 20 dB		
	R&S®ZNB20			
	100 kHz to 1 MHz	> 16 dB		
	1 MHz to 100 MHz	> 20 dB		
Maximum nominal input level	100 MHz to 10 GHz	> 12 dB		
	10 GHz to 20 GHz	> 10 dB		
Power measurement accuracy at –10 dBm, without power calibration	R&S®ZNB4 and R&S®ZNB8			
	9 kHz to 100 kHz	< 2 dB		
	100 kHz to 8.5 GHz	< 1 dB		
	R&S®ZNB20			
	100 kHz to 10 GHz	< 1 dB	0.1 dB	
Compression at test port input, input level: > 0 dBm, referenced to -10 dBm	R&S®ZNB4 and R&S®ZNB8			
	9 kHz to 8.5 GHz, +0 dBm to +8 dBm	< 0.2 dB		
	9 kHz to 7.5 GHz, +8 dBm to +10 dBm	< 0.2 dB		
	R&S®ZNB20			
	100 kHz to 15 GHz, +0 dBm to +10 dBm	< 0.3 dB	0.1 dB	
	15 GHz to 20 GHz, +0 dBm to +8 dBm	< 0.3 dB	0.1 dB	
Linearity at test port input, input level: –50 dBm to 0 dBm, referenced to –10 dBm	R&S®ZNB4, R&S®ZNB8 and R&S®ZNB20			
	9 kHz to 100 kHz	< 0.1 dB		
	100 kHz to 20 GHz	< 0.1 dB	0.02 dB	
Damage level		+27 dBm		
Damage DC voltage		30 V		
Noise level ⁷ , at 1 kHz measurement bandwidth, normalized to 1 Hz	R&S®ZNB4 and R&S®ZNB8			
	9 kHz to 100 kHz	< –120 dBm	–130 dBm	
	100 kHz to 4 GHz	< –130 dBm	–140 dBm	
	4 GHz to 6.5 GHz	< –125 dBm	–138 dBm	
	6.5 GHz to 8.5 GHz	< –120 dBm	–132 dBm	
	R&S®ZNB20			
	100 kHz to 1 MHz	< –105 dBm	–115 dBm	
	1 MHz to 10 MHz	< –115 dBm	–120 dBm	
	10 MHz to 15 GHz	< –120 dBm	–125 dBm	
15 GHz to 20 GHz	< –118 dBm	–130 dBm		

⁷ The noise level is defined as the RMS value of the specified noise floor. For different bandwidth add $[10 \times \log_{10}(\text{bandwidth}/1 \text{ Hz})]$ to the given noise level.

Additional front panel connectors

USB		4 ports, type A plug, version 2.0
-----	--	-----------------------------------

Display

Screen		30.7 cm (12.1") diagonal WXGA, 18-bit color LCD with touchscreen
Resolution		1280 × 800 pixel, 125 dpi
Pixel failure rate		$< 1 \times 10^{-5}$

Rear panel connectors

LAN		8-pin, RJ-45
-----	--	--------------

USB host		2 ports, type A plug, version 3.0
----------	--	-----------------------------------

USB device		1 port, type B plug, version 3.0
------------	--	----------------------------------

REF IN	input for external frequency reference signal	
Connector type		BNC, female
Input frequency range		1 MHz to 20 MHz, in steps of 1 MHz
Maximum permissible deviation		1 kHz
Input power		-10 dBm to +15 dBm
Input impedance		50 Ω

REF OUT	output for external frequency reference signal	
Connector type		BNC, female
Output frequency		10 MHz
Output power		+9 dBm ± 4 dB at 50 Ω

External monitor		
Connector types		HDMI™ DisplayPort

USER CONTROL	several control and trigger signals, 25-pin D-Sub, 3.3 V TTL, for controlling external generators, for limit checks, sweep signals, etc.	
CHANNEL BIT 0 to CHANNEL BIT 3	pin 8 to pin 11 (outputs)	channel-specific, user-configurable bits
CHANNEL BIT 4 to CHANNEL BIT 7	pin 16 to pin 19 (outputs)	channel-specific, user-configurable bits
DRIVE PORT 1 to DRIVE PORT 4	pin 16 to pin 19 (outputs)	indicates drive ports (can alternatively be used for channel bits 4 to 7)
PASS 1 and PASS 2	pin 13 and pin 14 (outputs)	pass/fail results of limit checks
BUSY	pin 4 (output)	measurements running
READY FOR TRIGGER	pin 6 (output)	ready for trigger
EXT GEN TRIGGER	pin 21 (output)	control signal for external generator
EXT GEN BLANK	pin 22 (input)	handshake signal from external generator
EXTERNAL TRIGGER	pin 2 (input)	first trigger input for analyzer, 5 V tolerant
EXTERNAL TRIGGER 2	pin 25 (input)	second trigger input for analyzer, 5 V tolerant

EXT TRIG IN	trigger input for analyzer	
Connector type		BNC, female
TTL signal (edge-triggered or level-triggered)		3 V, 5 V tolerant
Polarity (selectable)		positive or negative
Minimum pulse width		1 μs
Input impedance		> 10 kΩ

EXT TRIG OUT	trigger output of analyzer	
Connector type		BNC, female
Logic high		3.3 V (typ.)

Options

R&S®ZNB-B1

Bias tee for the R&S®ZNB4 and the R&S®ZNB8		
Connector type		BNC, female
Maximum nominal input voltage		30 V
Maximum nominal input current		400 mA
Damage voltage		30 V
Damage current		420 mA
Frequency range	R&S®ZNB4 with R&S®ZNB-B1 R&S®ZNB8 with R&S®ZNB-B1	100 kHz to 4.5 GHz 100 kHz to 8.5 GHz
Frequency response data		typical and specified data is valid for the limited frequency range given above

Factory-calibrated system data

This data is valid between +18 °C and +28 °C. The data is based on a source power of –10 dBm and a measurement bandwidth of 1 kHz.

Parameter	Frequency range	Specification	Typical
Directivity	100 kHz to 4.5 GHz	≥ 30 dB	50 dB
	4.5 GHz to 8.5 GHz	≥ 30 dB	50 dB
Source match	100 kHz to 500 kHz	≥ 20 dB	30 dB
	500 kHz to 8.5 GHz	≥ 30 dB	50 dB
Reflection tracking	100 kHz to 8.5 GHz	≤ 0.5 dB	0.1 dB
Load match	100 kHz to 500 kHz	≥ 10 dB	15 dB
	500 kHz to 8.5 GHz	≥ 18 dB	25 dB
Transmission tracking	100 kHz to 8.5 GHz	≤ 0.5 dB	0.1 dB

R&S®ZNB-B4

Static frequency accuracy		(time since last adjustment × aging rate) + temperature drift + calibration accuracy
Aging per year	with R&S®ZNB-B4 precision frequency reference option	±1 × 10 ⁻⁷
Temperature drift (5 °C to +40 °C)	with R&S®ZNB-B4 precision frequency reference option	±1 × 10 ⁻⁸
Achievable initial calibration accuracy	with R&S®ZNB-B4 precision frequency reference option	±5 × 10 ⁻⁸

R&S®ZNB-B10

 GPIB interface 		remote control interface in line with IEEE 488, IEC 60625; 24-pin
-------------------------	--	---

R&S®ZNB-B12

Device control		
DIRECT CTRL interface		direct control bus output

R&S®ZN-B14

Handler I/O	several control and trigger signals, 36-pin Centronics connector, TTL compatible, for controlling external devices, limit checks, sweep signals, etc.	
Keysight handler interface compatibility		type 3
Input signals	pin 2, pin 18	TTL compatible
Output signals	pin 3 to pin 17, pin 19 to pin 21, pin 30 to pin 34, pin 36	TTL compatible
Input/output signals	pin 22 to pin 29	TTL compatible
+5 V output	pin 35	+5 V, max. 100 mA
Response time of write strobe signal	pin 32	1 μs
Pulse width of write strobe signal	pin 32	1 μs
Pulse width of external trigger signal	pin 18	> 1 μs
Pulse width of sweep end signal	pin 34	> 10 μs

R&S®ZNB4-B22/-B24, R&S®ZNB8-B22/-B24 and R&S®ZNB20-B22/-B24

Extended power range		Specification	Typical
Power range for the R&S®ZNB4 and the R&S®ZNB8	9 kHz to 100 MHz	-85 dBm to +10 dBm	up to +12 dBm
	100 MHz to 2.5 GHz	-85 dBm to +13 dBm	up to +15 dBm
	2.5 GHz to 7.5 GHz	-85 dBm to +10 dBm	up to +13 dBm
	7.5 GHz to 8.5 GHz	-85 dBm to +8 dBm	up to +12 dBm
Power range for the R&S®ZNB20	100 kHz to 10 GHz	-60 dBm to +12 dBm	up to +15 dBm
	10 GHz to 20 GHz	-60 dBm to +10 dBm	up to +13 dBm

R&S®ZNB4-B31/-B32/-B33/-B34 and R&S®ZNB8-B31/-B32/-B33/-B34

Receiver step attenuators		
Frequency range	R&S®ZNB4-B31/-B32/-B33/-B34	9 kHz to 4.5 GHz
	R&S®ZNB8-B31/-B32/-B33/-B34	9 kHz to 8.5 GHz
Attenuation		0 dB to 30 dB, in 10 dB steps

R&S®ZNB4-B52/-B54 and R&S®ZNB8-B52/-B54

Extended dynamic range		Specification	Typical
Power range, without optional extended power range	9 kHz to 100 kHz	-55 dBm to +8 dBm	
	100 kHz to 6.5 GHz	-55 dBm to +10 dBm	
	6.5 GHz to 7.5 GHz	-55 dBm to +8 dBm	
	7.5 GHz to 8.5 GHz	-55 dBm to +6 dBm	
Minimum power level using optional extended power range (see Options)	9 kHz to 8.5 GHz	-85 dBm	
Second and third harmonics at 0 dBm	20 kHz to 100 MHz	≤ -18 dBc	-30 dBc
	100 MHz to 8.5 GHz	≤ -25 dBc	-35 dBc
System dynamic range ⁸	9 kHz to 50 MHz	≥ 130 dB	140 dB
	50 MHz to 6.5 GHz	≥ 140 dB	150 dB
	6.5 GHz to 8.5 GHz	≥ 130 dB	138 dB

Test port input		
Without system error correction	9 kHz to 50 kHz	≥ 10 dB
	50 kHz to 8.5 GHz	≥ 18 dB
Maximum nominal input level		+10 dBm
Compression at test port input, input level: > 0 dBm, referenced to -10 dBm	9 kHz to 7.5 GHz, +0 dBm to +8 dBm	≤ 0.2 dB
	7.5 GHz to 8.5 GHz, +0 dBm to +6 dBm	≤ 0.2 dB
Linearity at test port input, input level: -50 dBm to 0 dBm, referenced to -10 dBm	9 kHz to 8.5 GHz	≤ 0.1 dB
Noise level ⁹ , at 1 kHz measurement bandwidth, normalized to 1 Hz	9 kHz to 50 kHz	≤ -125 dBm (1 Hz)
	50 kHz to 50 MHz	≤ -130 dBm (1 Hz)
	50 MHz to 6.5 GHz	≤ -140 dBm (1 Hz)
	6.5 GHz to 8.5 GHz	≤ -130 dBm (1 Hz)

Trace stability		IF bandwidth	Specification	Typical
Trace noise magnitude (RMS), at 0 dBm source power, 0 dB reflection	9 kHz to 20 kHz	1 kHz	≤ 0.008 dB	0.004 dB
	20 kHz to 100 kHz	1 kHz	≤ 0.005 dB	0.001 dB
	100 kHz to 1 GHz	10 kHz	≤ 0.005 dB	0.001 dB
	1 GHz to 5 GHz	10 kHz	≤ 0.005 dB	0.002 dB
	5 GHz to 8.5 GHz	10 kHz	≤ 0.005 dB	0.003 dB

⁸ The dynamic range is defined as the difference between the actual maximum source power and the RMS value of the data trace of the transmission magnitude, which is produced by noise and crosstalk with the test ports short-circuited. The specification applies at 10 Hz measurement bandwidth, without system error correction. The dynamic range can be increased by using a measurement bandwidth of 1 Hz. Crosstalk does not limit the dynamic range. Dynamic range between port 1 and port 2 and between port 3 and port 4 (4-port model). Otherwise the dynamic range performance is typical.

⁹ The noise level is defined as the RMS value of the specified noise floor.

Measurement speed in ms with R&S®ZNB4-B52/-B54 or R&S®ZNB8-B52/-B54 option installed					
Typical sweep times versus number of measurement points, sweep mode: stepped					
Number of measurement points	51	201	401	1601	5001
800 MHz start frequency, 1 GHz stop frequency, AGC LOW DIST, 100 kHz measurement bandwidth					
With correction switched off	2.0	5	8	20	57
With 2-port TOSM calibration	3.5	9	13	40	113
With 4-port TOSM calibration	6.5	17	25	81	246
800 MHz start frequency, 1 GHz stop frequency, Memory AGC on, 100 kHz measurement bandwidth					
With correction switched off	3.5	10	16	55	170
With 2-port TOSM calibration	6	18	31	109	339
With 4-port TOSM calibration	10	35	61	225	701
100 kHz start frequency, 4.5 GHz stop frequency, AGC LOW DIST, 100 kHz measurement bandwidth					
With correction switched off	4.0	8	12	33	90
With 2-port TOSM calibration	7.5	14	22	65	180
With 4-port TOSM calibration	14	27	42	130	355
100 kHz start frequency, 4.5 GHz stop frequency, Memory AGC on, 100 kHz measurement bandwidth					
With correction switched off	6	12	21	69	205
With 2-port TOSM calibration	10	23	40	137	405
With 4-port TOSM calibration	19	45	79	273	810
100 kHz start frequency, 8.5 GHz stop frequency, AGC LOW DIST, 100 kHz measurement bandwidth					
With correction switched off	4.5	9	13	34	90
With 2-port TOSM calibration	8.5	17	25	67	180
With 4-port TOSM calibration	16	32	47	131	359
100 kHz start frequency, 8.5 GHz stop frequency, Memory AGC on, 100 kHz measurement bandwidth					
With correction switched off	6	13	22	70	205
With 2-port TOSM calibration	11	26	43	139	410
With 4-port TOSM calibration	21	50	84	280	815

Note: The R&S®ZNBx-B52/-B54 options cannot be combined with the R&S®ZNBx-B1 option and/or the R&S®ZNBx-B31/-B32/-B33/-B34 options.

R&S®ZNB-B81

This data is valid in the temperature range +18 °C to +28 °C and with a maximum measurement bandwidth of 10 kHz.

DC inputs		
Number of ports		4
Connector type		BNC, female
Voltage range		±20 V, ±3 V, ±0.3 V
Measurement accuracy	±20 V	2 % of reading ± 0.02 V
	±3 V	2 % of reading ± 0.002 V
	±0.3 V	2 % of reading ± 0.002 V
Input impedance		≥ 1 MΩ
Damage voltage		30 V

R&S®ZNB-K980

Health and utilization monitoring service (HUMS) ^{10, 11}		
Interfaces	protocols and interfaces supported for data readout and display	<ul style="list-style-type: none"> • SNMP (v1, v2c, v3) • REST (JSON) • SCPI • device web
Services	information provided	<ul style="list-style-type: none"> • device information (model, serial number, BIOS, date, time, system, HUMS and software information) • user-defined information tags (e.g. for asset management) • equipment information (hardware, options, software, licenses) • system operating status • instrument security information • service related information (due dates etc.) • mass storage related information • instrument utilization data • device history (event log)

¹⁰ For details see application note under: www.rohde-schwarz.com/appnote/GFM336.

¹¹ For use with common available asset management tools.

General data

Temperature loading		in line with IEC 60068-2-1 and IEC 60068-2-2
	operating temperature range	+5 °C to +40 °C
	storage temperature range	-20 °C to +60 °C
Damp heat		+40 °C at 85 % rel. humidity, in line with IEC 60068-2-30
Altitude	operating environment	max. 2000 m
	storage environment	max. 4500 m
Mechanical resistance	vibration, sinusoidal	5 Hz to 55 Hz, 0.15 mm amplitude constant, 55 Hz to 150 Hz, 0.5 g constant, in line with IEC 60068-2-6
	vibration, random	10 Hz to 300 Hz, acceleration 1.2 g (RMS) in line with IEC 60068-2-64
	shock	40 g shock spectrum, in line with MIL-STD-810E method no. 516.4 procedure I
Calibration interval		1 year
EMC	RF emission	in line with CISPR 11/EN 55011 group 1 class A (for a shielded test setup); instrument complies with the emission requirements stipulated by EN 55011 and EN 61326-1 class A; this means that the instrument is suitable for use in industrial environments
	immunity	in line with EMC Directive 2014/30/EU including: IEC/EN 61326-1 (immunity test requirement for industrial environment, EN 61326 table 2), IEC/EN 61326-2-1, IEC/EN 61000-3-2, IEC/EN 61000-3-3
Safety		in line with IEC 61010-1, EN 61010-1 and UL 61010-1, CAN/CSA-C22.2 No.61010-1
Power supply		100 V to 240 V at 50 Hz to 60 Hz and 400 Hz, max. 5.5 A to 2.3 A respectively
Power consumption	R&S®ZNB4 and R&S®ZNB8, with 2 ports	max. 450 W, 120 W (typ.)
	R&S®ZNB4 and R&S®ZNB8, with 4 ports	max. 450 W, 170 W (typ.)
	R&S®ZNB20, with 2 ports	max. 450 W, 130 W (typ.)
	R&S®ZNB20, with 4 ports	max. 450 W, 215 W (typ.)
Test marks		VDE, cCSA _{US} , KCC conformity mark, CE conformity mark
Dimensions	W x H x D	462.5 mm x 239.6 mm x 361.5 mm (18.2 in x 9.4 in x 14.2 in)
Weight	R&S®ZNB4, R&S®ZNB8 and R&S®ZNB20, with 2 ports	14 kg (30.9 lb)
	R&S®ZNB4, R&S®ZNB8 and R&S®ZNB20, with 4 ports	16 kg (35.3 lb)
Shipping weight	R&S®ZNB4, R&S®ZNB8 and R&S®ZNB20, with 2 ports	19 kg (41.9 lb)
	R&S®ZNB4, R&S®ZNB8 and R&S®ZNB20, with 4 ports	21 kg (46.3 lb)

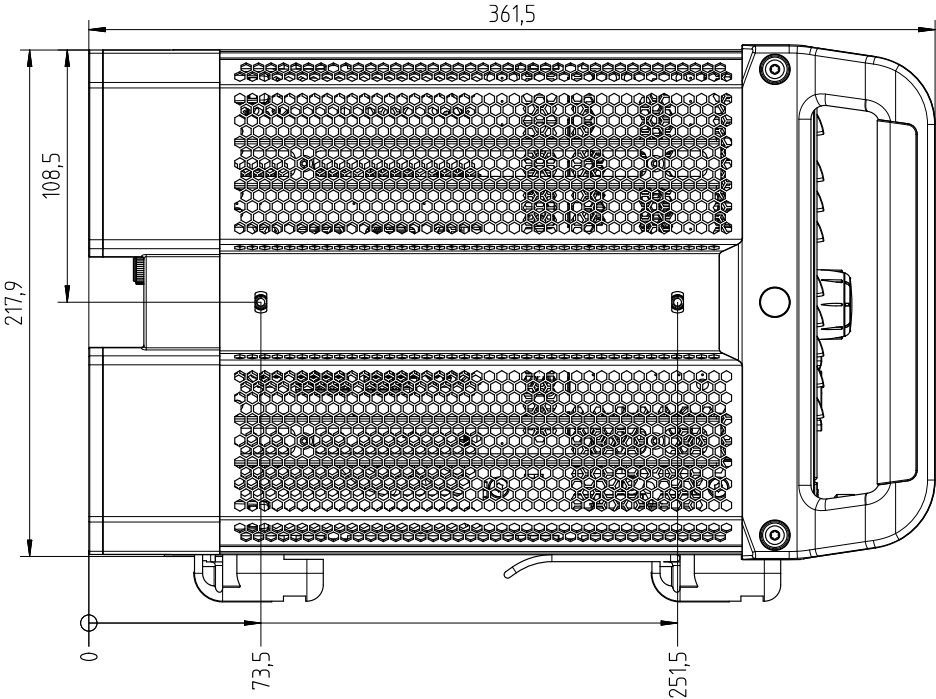

Side view of the R&S[®]ZNB

Ordering information

Designation	Type	Retrofit ¹²	On site ¹³	Order No.
Base unit				
Vector network analyzer, 2 ports, 4.5 GHz, type N	R&S®ZNB4			1334.3330.22
Vector network analyzer, 4 ports, 4.5 GHz, type N	R&S®ZNB4			1334.3330.24
Vector network analyzer, 2 ports, 8.5 GHz, type N	R&S®ZNB8			1334.3330.42
Vector network analyzer, 4 ports, 8.5 GHz, type N	R&S®ZNB8			1334.3330.44
Vector network analyzer, 2 ports, 20 GHz, 3.5 mm	R&S®ZNB20			1334.3330.62
Vector network analyzer, 4 ports, 20 GHz, 3.5 mm	R&S®ZNB20			1334.3330.64
Options				
Extended power range				
Extended power range for 2-port R&S®ZNB4	R&S®ZNB4-B22	•		1316.0210.02
Extended power range for 4-port R&S®ZNB4	R&S®ZNB4-B24	•		1316.0233.02
Extended power range for 2-port R&S®ZNB8	R&S®ZNB8-B22	•		1316.0227.02
Extended power range for 4-port R&S®ZNB8	R&S®ZNB8-B24	•		1316.0240.02
Extended power range for 2-port R&S®ZNB20	R&S®ZNB20-B22	•		1317.8950.02
Extended power range for 4-port R&S®ZNB20	R&S®ZNB20-B24	•		1317.8967.02
Receiver step attenuators				
Receiver step attenuator, port 1, for R&S®ZNB4	R&S®ZNB4-B31	•		1316.0185.02
Receiver step attenuator, port 2, for R&S®ZNB4	R&S®ZNB4-B32	•		1316.0179.02
Receiver step attenuator, port 3, for R&S®ZNB4	R&S®ZNB4-B33	•		1316.0262.02
Receiver step attenuator, port 4, for R&S®ZNB4	R&S®ZNB4-B34	•		1316.0433.02
Receiver step attenuator, port 1, for R&S®ZNB8	R&S®ZNB8-B31	•		1316.0191.02
Receiver step attenuator, port 2, for R&S®ZNB8	R&S®ZNB8-B32	•		1316.0204.02
Receiver step attenuator, port 3, for R&S®ZNB8	R&S®ZNB8-B33	•		1316.0162.02
Receiver step attenuator, port 4, for R&S®ZNB8	R&S®ZNB8-B34	•		1316.0440.02
Extended dynamic range ¹⁴				
Extended dynamic range for 2-port R&S®ZNB4	R&S®ZNB4-B52			1319.4975.02
Extended dynamic range for 4-port R&S®ZNB4	R&S®ZNB4-B54			1319.4981.02
Extended dynamic range for 2-port R&S®ZNB8	R&S®ZNB8-B52			1319.4998.02
Extended dynamic range for 4-port R&S®ZNB8	R&S®ZNB8-B54			1319.5007.02
Bias tees for R&S®ZNB4 and R&S®ZNB8 with 2 ports	R&S®ZNB-B1			1316.1700.02
Bias tees for R&S®ZNB4 and R&S®ZNB8 with 4 ports	R&S®ZNB-B1			1316.1700.04
Second internal generator for 4-port R&S®ZNB4 and 4-port R&S®ZNB8	R&S®ZNB-B2	•		1317.7954.02
Second internal generator for 4-port R&S®ZNB20	R&S®ZNB20-B2	•		1317.8980.02
Precision frequency reference (OCXO)	R&S®ZNB-B4	•		1316.1769.02
GPIB interface	R&S®ZNB-B10	•	•	1311.5995.04
Device control	R&S®ZNB-B12	•	•	1319.5088.02
Direct control cable	R&S®ZNB-B121	•	•	1323.9290.00
Handler I/O	R&S®ZNB-B14	•	•	1316.2459.05
RFFE GPIO interface (external)	R&S®ZNB-Z15	•	•	1325.5905.02
RFFE GPIO interface (external), including voltage/current measurement	R&S®ZNB-Z15	•	•	1325.5905.03
Additional removable SSD, 512 Gbyte, Windows 10 for IPS14	R&S®ZNB-B19	•	•	1334.3860.02
DC inputs	R&S®ZNB-B81	•		1316.0004.02
Time domain analysis	R&S®ZNB-K2	•	•	1316.0156.02
Extended time domain analysis	R&S®ZNB-K20	•	•	1326.8072.02
Distance to fault	R&S®ZNB-K3	•	•	1350.5057.02
Frequency conversion	R&S®ZNB-K4	•	•	1316.2994.02
Intermodulation measurements ¹⁵	R&S®ZNB-K14	•	•	1317.8373.02
10 MHz receiver bandwidth	R&S®ZNB-K17	•	•	1316.1881.02
1 mHz frequency resolution	R&S®ZNB-K19	•	•	1317.8573.02
Real-time measurement uncertainty analysis	R&S®ZNB-K50	•	•	3644.5977.02
Real-time measurement uncertainty analysis, preinstalled	R&S®ZNB-K50P			1338.1810.02

¹² Option may also be ordered at a later stage, upgrade in service.

¹³ Option may be installed by the customer on site.

¹⁴ The R&S®ZNBx-B52/-B54 options cannot be combined with the R&S®ZNBx-B1 option and/or the R&S®ZNBx-B31/-B32/-B33/-B34 options.

¹⁵ The R&S®ZNB-K14 requires R&S®ZNB-K4.

Designation	Type	Retrofit ¹²	On site ¹³	Order No.
Easy deembedding	R&S®ZNB-K210	●	●	1328.8592.02
In-situ deembedding	R&S®ZNB-K220	●		1328.8605.02
Smart fixture deembedding	R&S®ZNB-K230	●		1328.8611.02
Delta-L PCB characterization	R&S®ZNB-K231	●		1328.8628.02
Health and utilization monitoring service	R&S®ZNB-K980	●	●	1350.5305.02
19" rackmount kit	R&S®ZZA-KN5	●	●	1175.3040.00
Inline calibration units (automatic calibration)				
Inline calibration unit controller	R&S®ZN-Z30			1328.7609.02
Inline calibration unit, 8.5 GHz	R&S®ZN-Z32			1328.7638.02
Inline calibration unit, 40 GHz	R&S®ZN-Z33			1328.7644.02
Inline calibration unit, 40 GHz TVAC	R&S®ZN-Z33			1328.7644.03

Warranty				
Base unit			3 years	
All other items ¹⁶			1 year	
Service options				
Extended warranty, one year	R&S®WE1	Please contact your local Rohde & Schwarz sales office.		
Extended warranty, two years	R&S®WE2			
Extended warranty with calibration coverage, one year	R&S®CW1			
Extended warranty with calibration coverage, two years	R&S®CW2			
Extended warranty with accredited calibration coverage, one year	R&S®AW1			
Extended warranty with accredited calibration coverage, two years	R&S®AW2			

Extended warranty with a term of one and two years (WE1 and WE2)

Repairs carried out during the contract term are free of charge ¹⁷. Necessary calibration and adjustments carried out during repairs are also covered.

Extended warranty with calibration coverage (CW1 and CW2)

Enhance your extended warranty by adding calibration coverage at a package price. This package ensures that your Rohde & Schwarz product is regularly calibrated, inspected and maintained during the term of the contract. It includes all repairs ¹⁷ and calibration at the recommended intervals as well as any calibration carried out during repairs or option upgrades.

Extended warranty with accredited calibration (AW1 and AW2)

Enhance your extended warranty by adding accredited calibration coverage at a package price. This package ensures that your Rohde & Schwarz product is regularly calibrated under accreditation, inspected and maintained during the term of the contract. It includes all repairs ¹⁷ and accredited calibration at the recommended intervals as well as any accredited calibration carried out during repairs or option upgrades.

The terms HDMI and HDMI High-Definition Multimedia Interface, and the HDMI Logo are trademarks or registered trademarks of HDMI Licensing, LLC in the United States and other countries.

¹⁶ For options that are installed, the remaining base unit warranty applies if longer than 1 year. Exception: all batteries have a 1 year warranty.

¹⁷ Excluding defects caused by incorrect operation or handling and force majeure. Wear-and-tear parts are not included.

Service that adds value

- ▶ Worldwide
- ▶ Local and personalized
- ▶ Customized and flexible
- ▶ Uncompromising quality
- ▶ Long-term dependability

Rohde & Schwarz

The Rohde&Schwarz technology group is among the trailblazers when it comes to paving the way for a safer and connected world with its leading solutions in test & measurement, technology systems, and networks & cybersecurity. Founded more than 85 years ago, the group is a reliable partner for industry and government customers around the globe. The independent company is headquartered in Munich, Germany and has an extensive sales and service network with locations in more than 70 countries.

www.rohde-schwarz.com

Sustainable product design

- ▶ Environmental compatibility and eco-footprint
- ▶ Energy efficiency and low emissions
- ▶ Longevity and optimized total cost of ownership

Certified Quality Management
ISO 9001

Certified Environmental Management
ISO 14001

Rohde & Schwarz training

www.training.rohde-schwarz.com

Rohde & Schwarz customer support

www.rohde-schwarz.com/support

