

Anritsu envision : ensure

Network Master™ Series

Network Master Pro MT1000A

10G Multirate Module MU100010A

100G Multirate Module MU100011A

High Performance GPS Disciplined Oscillator MU100090A

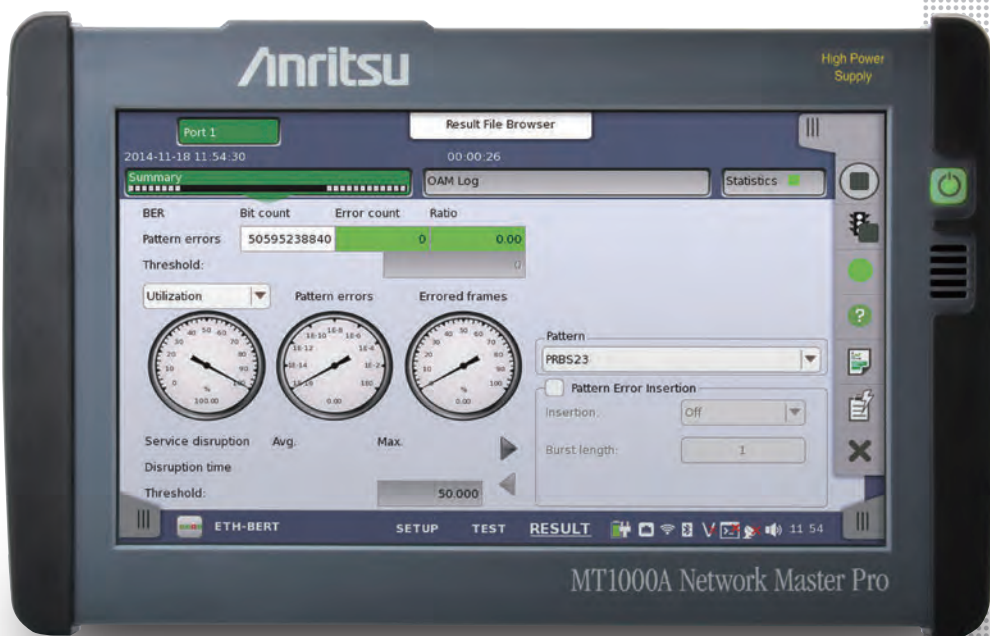

MT1000A Network Master Pro



All-in-One Tester for Network

Networks continue to evolve as standards for transport tests, such as Ethernet, OTN, SDH/SONET, eCPRI/RoE/CPRI/OBSAI, PTP, Fibre Channel, etc., become more diverse, and speeds increase with development of 100G/25G Ethernet and 16G Fibre Channel.

With an easily configured modular design to support changing network standards and an easy-to-use GUI, the Network Master Pro MT1000A is perfect for rapid I&M of wide-area networks.



MT1000A



All in One

I&M

Easy to use

- All transport network field tests in one tester
- Easy-to-read 9-inch touch screen in easy-to-use compact B5-size tester
- Higher work efficiency with multiple tests using one-button automated measurement tools

* : Available for certified countries and regions including USA, Canada, Japan and EU countries. Please visit the Anritsu web site for updated information.

Evolving Networks and Required Test Equipment

100G interfaces are being introduced progressively on Core and Metro networks. Additionally, introduction of the eCPRI/RoE protocol is being examined for 5G mobile networks in combination with 5G speed increases and diversifying applications. Onsite network I&M work requires cost-effective support for diversifying services at speeds from 1G to 100G with a field tester that improves work efficiency.

Key Applications → Details P.6

- | | |
|---|--|
| <div style="background-color: #00a651; color: white; padding: 5px; text-align: center; font-size: 8px;">Ethernet</div> <div style="background-color: #00a651; color: white; padding: 5px; text-align: center; font-size: 8px;">100G/25G Ethernet</div> | <ul style="list-style-type: none"> • 10M to 10G/25G/40G/100G Ethernet testing • FEC testing of 100G/25G Ethernet • High load traffic generation function at full wire rate • Ethernet testing up to 10 Gbps including RFC 2544, RFC 6349 and Y.1564 |
| <div style="background-color: #00a651; color: white; padding: 5px; text-align: center; font-size: 8px;">Mobile Fronthaul</div> <div style="background-color: #00a651; color: white; padding: 5px; text-align: center; font-size: 8px;">eCPRI</div> | <ul style="list-style-type: none"> • BER and Latency tests at eCPRI/RoE (IEEE1914.3) frame • Supported to CPRI 1 to 10 • Supported to OBSAI 1x, 2x, 4x, 8x • Verifying Link connection with REC/RE using CPRI |
| <div style="background-color: #00a651; color: white; padding: 5px; text-align: center; font-size: 8px;">Mobile Backhaul</div> <div style="background-color: #00a651; color: white; padding: 5px; text-align: center; font-size: 8px;">PTP Network</div> | <ul style="list-style-type: none"> • SyncE testing up to 25 Gbps • PTP testing up to 25 Gbps • MU100090A enables easy Pass/Fail evaluations when installing and commissioning time and phase synchronous networks • Supported Profiles:
G.8265.1, G.8375.1, G.8275.2, SMPTE2059-2 |
| <div style="background-color: #00a651; color: white; padding: 5px; text-align: center; font-size: 8px;">Data Center</div> <div style="background-color: #00a651; color: white; padding: 5px; text-align: center; font-size: 8px;">Fibre Channel</div> | <ul style="list-style-type: none"> • Supported to 1GFC, 2GFC, 4GFC, 8GFC, 10GFC, 16GFC • Network Performance Testing • Latency test • BER tests including service disruption measurement |
| <div style="background-color: #00a651; color: white; padding: 5px; text-align: center; font-size: 8px;">OTN</div> | <ul style="list-style-type: none"> • OTN up to OTU4 including mapping of Ethernet, CPRI, Fibre Channel, SDH/SONET client signals, multistage mapping and FEC (Forward Error Correction) • OTN error performance measurement in accordance with G.8201 or M.2401 • ITU-T O.182-compliant FEC test • Delay measurement |
| <div style="background-color: #00a651; color: white; padding: 5px; text-align: center; font-size: 8px;">SDH/SONET</div> | <ul style="list-style-type: none"> • Powerful testing of SDH (STM-64, STM-16, STM-4, STM-1), SONET (OC-192, OC-48, OC-12, OC-3, STS-3) systems • Analysis of service disruption with APS application • Error-performance test (G.826, G.828, G.829, or M.2100) |

The Network Master supports all types of network I&M.

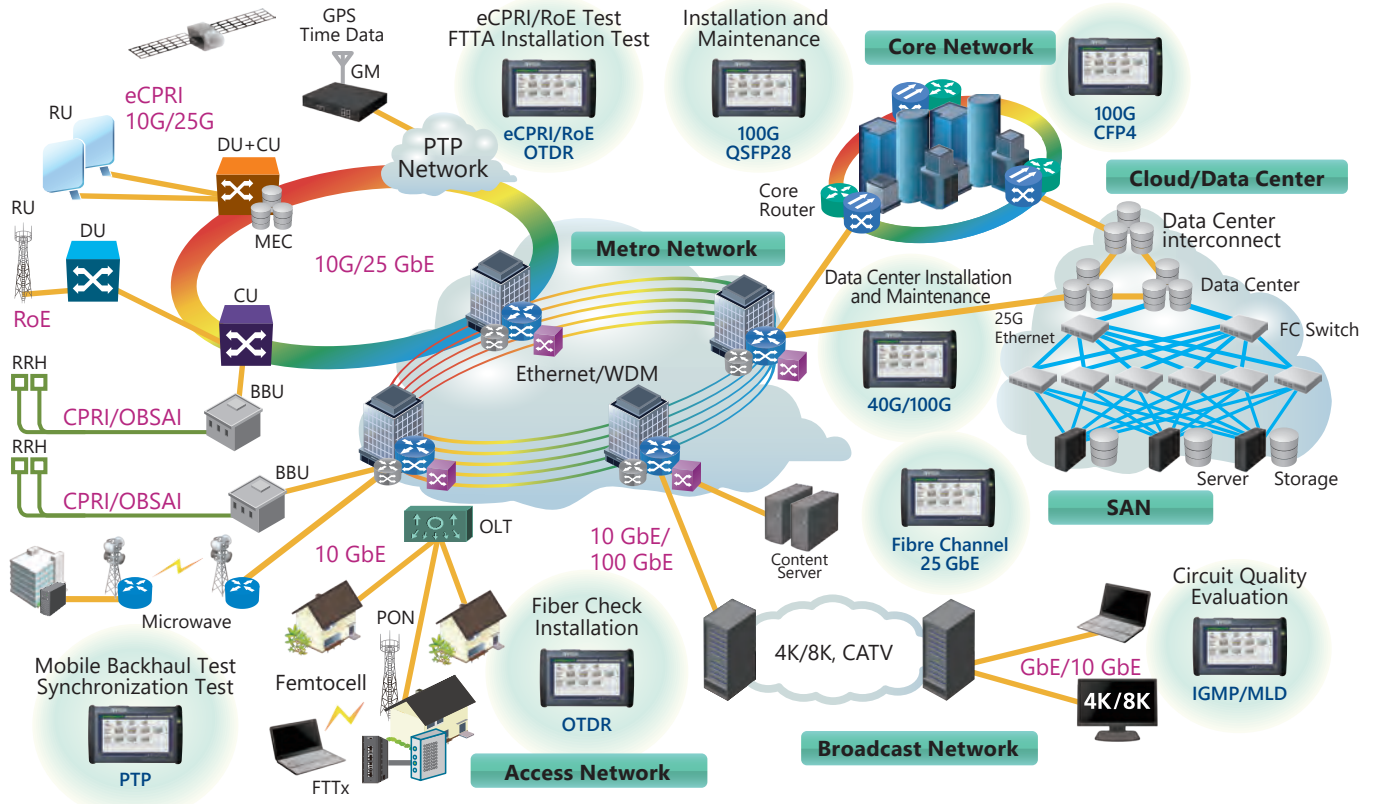

The modular design of the Network Master Pro MT1000A platform makes it easy to support I&M for different network configurations. Combining it with the 10G Multirate Module MU100010A offers the necessary functions for I&M of networks at speeds from 1.5 Mbps to 10 Gbps. Combining with the 100G Multirate Module MU100011A, it supports more interface standards than any other handheld transport tester on the market such as CFP4/QSPF28, QSFP+, SFP28 (25GbE), SFP+SFP and RJ45.

Coupled with a compact easy-to-use design and long battery operation, plus a large 9" easy-to-see color touch screen, remote GUI operation via Internet connection, and more, the MT1000A is a key factor in increasing I&M test work efficiency.

Furthermore, options for each test function can be selected and added as necessary to match the work schedule, helping cut initial capital costs.

Interface*	Ethernet	OTN	SDH/SONET	Fibre Channel	CPRI/OBSAI	PDH/DSn
CFP4	100 GbE	OTU4	—	—	—	—
QSFP28	100 GbE	OTU4	—	—	—	—
QSFP+	40 GbE	OTU3	—	—	—	—
SFP28	25 GbE	—	—	—	CPRI 10	—
SFP/SFP+	GbE/10 GbE	OTU1x/OTU2x	STM1-64/ OC3-192	1G/2G/4G/8G/10G FC	CPRI 1/2/3/4/5/6/7/8 OBSAI 1x/2x/4x/8x	—
				16G FC	CPRI 9	
RJ45	10/100/1000M	—	—	—	—	—
RJ48	—	—	—	—	—	E1
BNC	—	—	STM-1e/STS-3	—	—	E1/E3/E4/DS3
Bantam	—	—	—	—	—	DS1

Legend: : MU100010A Only : MU100011A Only : Both MU100010A & MU100011A Supported

*: The interface depends on the module. For details, refer to the following.

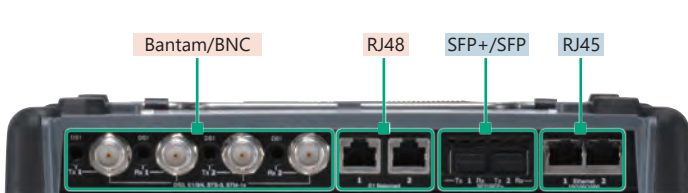

10G Multirate Module MU100010A

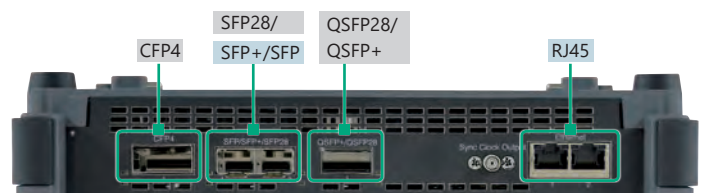

100G Multirate Module MU100011A

As networks get faster, I&M field technicians must not only master the relevant technical knowledge for each network type that includes metro networks, mobile networks, data centers, etc., but must also understand the detailed tester operations for each of these networks. In addition, sometimes multiple items must be measured at each commissioning, increasing the risk of operator errors. But with the versatile and easy-to-use MT1000A functions, the risk of operator errors are decreased.

Easy-to-Use GUI

The MT1000A GUI (graphical user interface) is designed for intuitive onsite operation and speeds-up I&M test-result evaluations as well as problem troubleshooting. Training time is also cut by the intuitive interface.

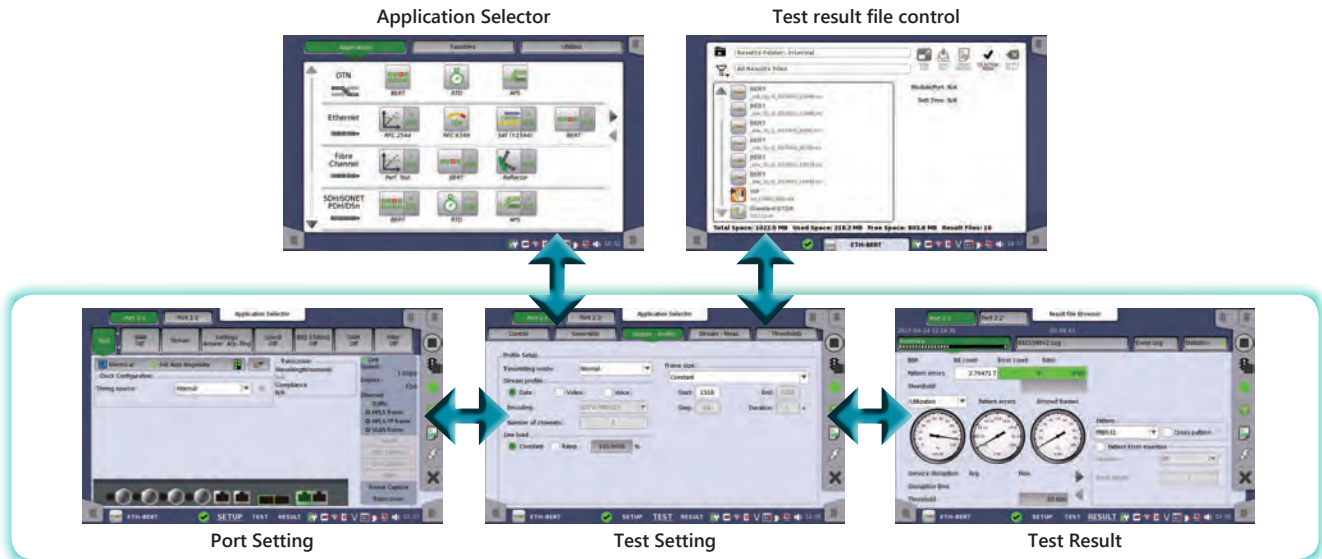

Remotely Controlled Network Installation, Start-up, and Maintenance

The MT1000A has a useful remote function for network installation, start-up and maintenance. Connecting the office and job site via LAN allows engineers in the office to see screens at the on-site instrument while making settings and measurements, and troubleshooting. This provides an efficient link between engineers and on-site measurements to help cut network installation and maintenance costs.

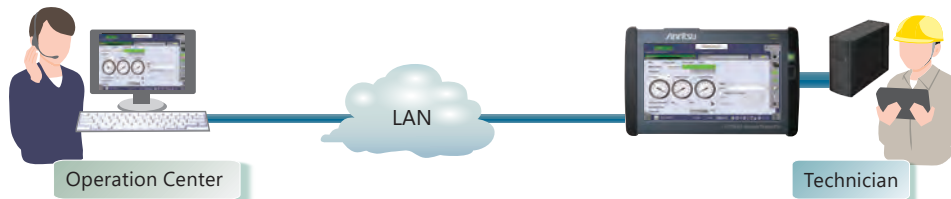

Easy Connections Anywhere Using SORA (Site Over Remote Access)*

Using the MX109020A Site Over Remote Access (SORA hereafter) software measuring instruments can be remotely controlled easily anywhere. The SORA cloud-based service allows office users to log-in to an Internet webpage to control the measuring instrument from the office via a smartphone.

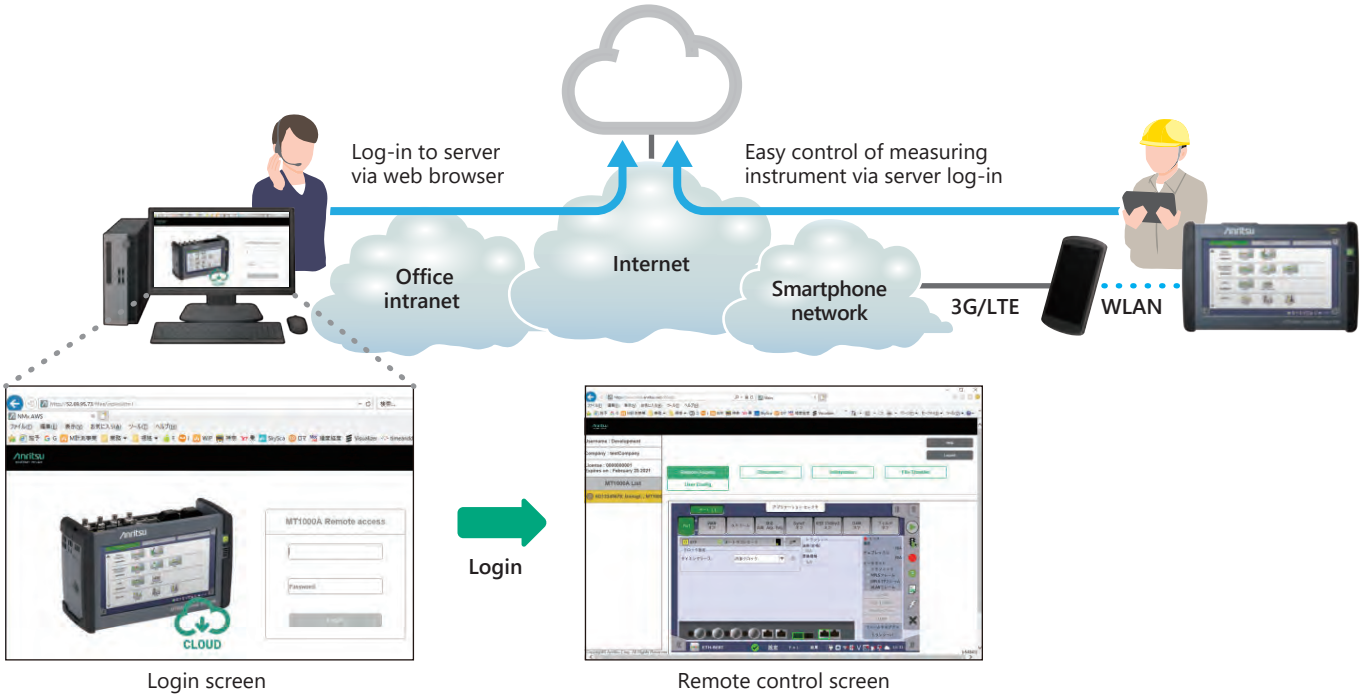

* This service can be used in countries and regions where the MT1000A WLAN/Bluetooth option has been approved. For details, contact Anritsu.

* To connect using SORA, you must purchase an option license for the main unit as well as a subscription license. Refer to the MX109020A leaflet and product introduction for more details. You must agree to the service contract before purchasing SORA. Refer to the service contract at the following URL: <https://www.anritsu.com/en-AU/test-measurement/support/downloads/manuals/dwl20059>.

One Button Testing

The MT1000A has automatic test functions for simple and efficient network commissioning. These MT1000A automated test functions run scenario files created in advance on a PC to perform tests automatically using preset measurement items, procedures, and pass/fail evaluation conditions. Since the scenario also handles report creation, evaluation and results, inexperienced workers can run accurate tests without operation mistakes and re-tests.

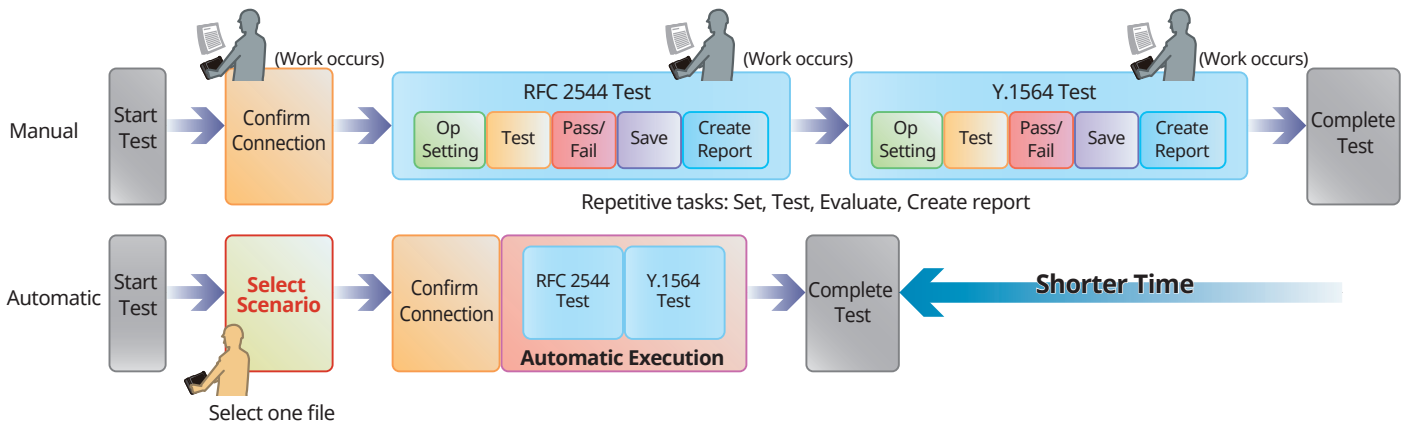
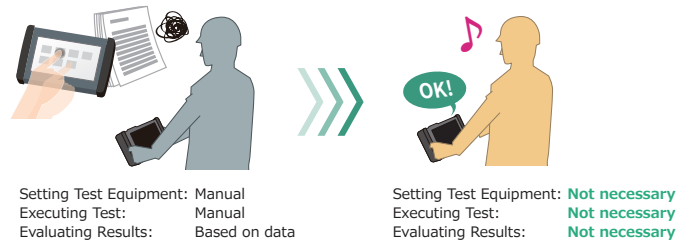

Ethernet Application

Carrier Ethernet Installation and Troubleshooting

Network operators are introducing new carrier-class technologies, such as VLAN, Q-in-Q, Ethernet OAM, MPLS, PBB, MPLS-TP, etc., to their Ethernet service menus, increasing test complexity and test time for field technicians. The MU100010A/MU100011A Ethernet test functions provide strong support for commissioning and troubleshooting Ethernet networks up to 100G speeds, including connectivity and band tests, QoS tests, and service-related tests.

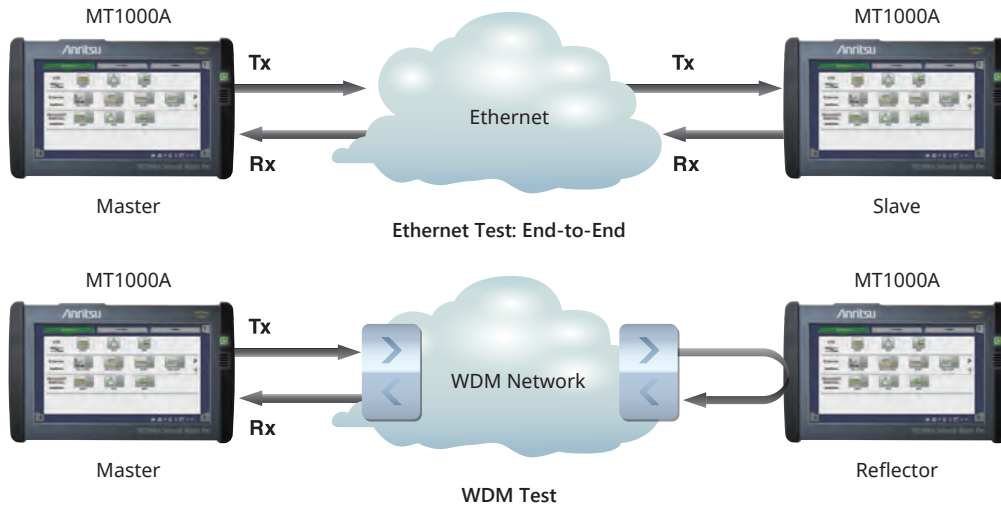

Ethernet test features include:

- Ethernet tests at 100 Gbps, 40 Gbps, 25 Gbps, 10 Gbps, 1 Gbps, 100 Mbps, and 10 Mbps
- Traffic generation up to full line rate
- Support for IPv4 and IPv6
- Ethernet Service Activation Test (Y.1564)
- Automated RFC 2544 tests of Throughput, Frame Loss, Latency or Packet Jitter, Burstability
- TCP Throughput (RFC 6349, iPerf) [Option]
- BER tests – include Frame Loss and Sequence Error tests
- Service disruption measurements
- Comprehensive statistics
- Filters – to extract relevant parts of traffic
- Thresholds – to highlight abnormalities
- Simultaneous monitoring in both line directions
- IP Channel Statistics to identify error streams, top talkers, network attacks
- Ethernet OAM tests
- 10G WAN-PHY tests
- Synchronous Ethernet test (SyncE), PTP (IEEE 1588 v2)
- IEEE 1588 v2 Phase/Time synchronization test (For optical 1G/10G/25G bps)
- Ethernet Multistream
- Stacked VLAN (Q-in-Q)
- Link Fault Signaling (LFS) Emulation (10G/25G/40G/100G bps)
- IGMP/MLD client function
- MPLS tests
- MPLS-TP and PBB tests
- Ping
- Traceroute
- Frame capture for protocol analysis with Wireshark
- Electrical cable tests and optical signal level displays

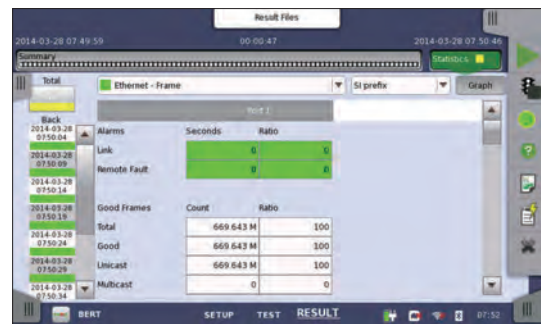

Ethernet Statistics



Ethernet BER Tests Statistics Summary

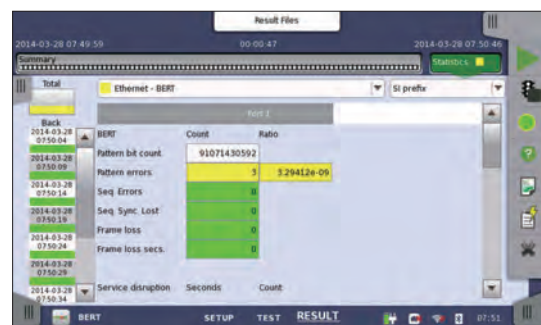

Ethernet BER Tests Results

Wireshark® is a registered trademark of the Wireshark Foundation.

Carrier Ethernet Installation and Troubleshooting

Ethernet Service Activation Test (Y.1564)

With the ability to simultaneously test multiple traffic streams, ITU-T Y.1564 is a new test methodology when deploying Ethernet networks. Today's common RFC 2544 standard completes tests one at the time and does not run all traffic streams simultaneously. ITU-T Y.1564 has the following two test phases.

- Service Configuration Test:**

This section is completed quickly, within seconds per stream. It confirms the end-to-end configuration while quickly checking the Information Rate (IR), Frame Transfer Delay (FTD), Frame Delay Variation (FDV), Frame Loss Ratio (FLR), Committed Burst Size (CBS) and Excess Burst Size (EBS) sequentially for all configured traffic streams.

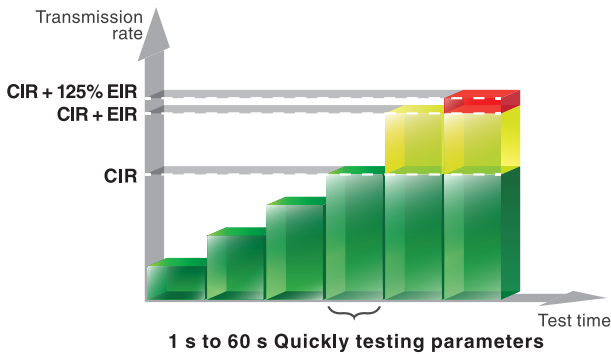

Y.1564 Service Configuration Test

- Service Performance Test:**

This section is completed based on the M.2110 standard for 15 minutes, 2 hours, 24 hours, or a user-selectable period. It transmits all configured traffic streams simultaneously at the CIR, confirming that all traffic can traverse the network under full load while checking IR, FTD, FDV, FLR and Availability (AVAIL).

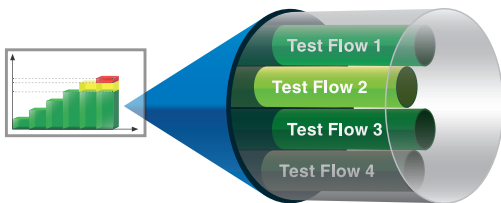

Y.1564 Service Performance Test

Simultaneous testing in the Service Performance Test section greatly reduces the total test time compared to RFC 2544.

RFC 2544 Test

RFC 2544 testing of Throughput, Frame Loss, Latency, Packet Jitter and Burstability is straightforward with the MU100010A/MU100011A. It automates the procedure while still allowing thorough test configuration. For full information on performance at both line sides, the end-to-end test mode allows two MT1000A testers to work together in a local-remote configuration where the user controls both testers and reads results from both locally. Easy to understand tabular screens and bar graph presentations simplifies reading of results. Attractive looking reports can be generated for presentation to end-customers.

Test No.	Size	# of Flows	Throughput	Frame Loss	Latency	Test (Mbps)
0	1	64	44.642857 M	14.888952 M	100.00	3095.241552
0	2	64	40.178571 M	13.592857 M	90.00	2785.714464
0	3	64	35.714285 M	11.904761 M	80.00	2476.190944
0	4	64	31.250000 M	10.416666 M	70.00	2166.671520

Throughput Summary

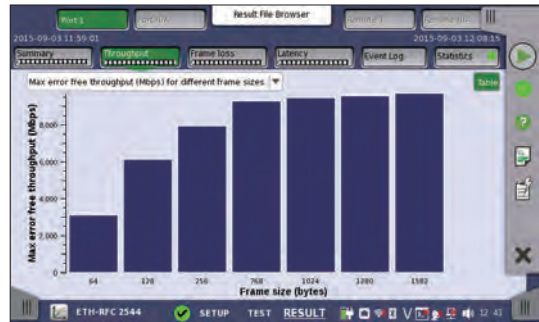

Throughput Graph

TCP Throughput (RFC 6349, iPerf) [Option]

Normally, IP network operators test their communications equipment in accordance with the RFC 2544 and ITU-T Y.1564 standards, but even when the test results are good, sometimes the expected end-to-end data throughput is not achieved. Although data communications use the TCP protocol for guaranteed data transfers, sometimes throughput drops as a result of network delays, poor circuit quality, etc. The RFC 6349 standard regulates the test methods for assuring operator throughput over the TCP layer, and the MU100010A/MU100011A modules with built-in TCP throughput option support TCP throughput evaluation and testing in accordance with the RFC 6349 standard. The iperf client function for testing TCP throughput is also supported.

Window size	Connections	Threshold	Avg Throughput	Avg RTT
147696 Bytes	3	95.00 % of Ideal	9414.924 Mbps	0.002 ms

Network Parameters	Source	Value	RFC6349 Metric	Result
MTU / MSS	User input	1500 / 1448 Bytes	Transfer Time Ratio	1.00
RTT	User input	0.125 ms	TCP Efficiency	100.00 %
CIR	User input	10000.00 Mbps	Buffer Delay	-98.48 %

Test Result

Ethernet Application

Carrier Ethernet Installation and Troubleshooting

Pass-through Mode

Configuring the MU100010A/MU100011A to Pass-through mode supports detailed troubleshooting, especially in bi-directional networks requiring traffic monitoring from both ends.

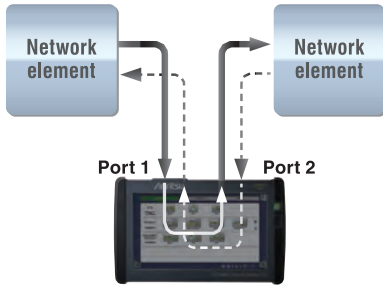

Pass-through monitoring by inserting MT1000A in network

IP Channel Statistics – Multiflow Counters

Up to 230 flows can be selected and filtered by MAC and IP Source/Destination addresses, VLAN and MPLS to monitor selected streams and display detailed information. This allows the user to identify error streams, top talkers, and network attacks, as well as troubleshoot network issues more deeply.

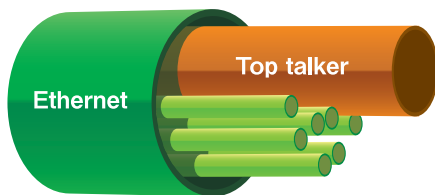

One-way Delay Measurement Using Two MT1000A Units

One-way delay can be measured with high accuracy using two MT1000A/MU100011A units at a distant location with installed MU100090A.

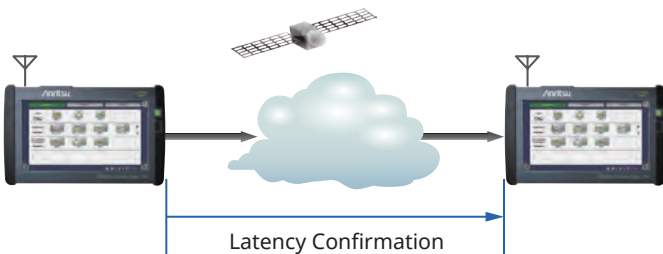

Ethernet OAM

To improve the performance of Ethernet-based networks and provide Carrier Class service, many network providers have enhanced their systems with Ethernet OAM (Operation, Administration and Maintenance), supporting the ability to detect network faults and measure performance. Ethernet OAM is defined by three standards covering different network sections. The ITU-T Y.1731 and IEEE 802.1ag standards are similar and support end-to-end network functionality, while the IEEE 802.3 (previously IEEE 802.3ah) standard supports first (or last) mile functionality. The MU100010A/MU100011A tests the network using all supported OAM functions.

Ethernet Multistream

The MU100010A/MU100011A Ethernet Multistream function allows simulation and testing of a congested network's ability to prioritize high-priority traffic over low-priority traffic. The user can set different priorities for up to 16 streams per port to measure how frame loss affects network performance. The Multistream function displays clear information on Packet Jitter and Latency per stream, helping troubleshoot problematic issues for VoIP services, etc.



Multi Stream Setting

MPLS and MPLS-TP

Multi-Protocol Label Switching (MPLS) supports efficient traffic routing on packet-based networks. MPLS – Transport Profile (MPLS-TP) technology is based on standard MPLS and aims to give service providers reliable connection-oriented packet-based transport over the network. MPLS-TP offers service providers QoS, end-to-end Carrier Class OAM, and protection switching. With its ability to insert up to 8 levels of MPLS labels, the MU100010A/MU100011A is a powerful tool for testing MPLS and MPLS-TP networks including OAM functions.

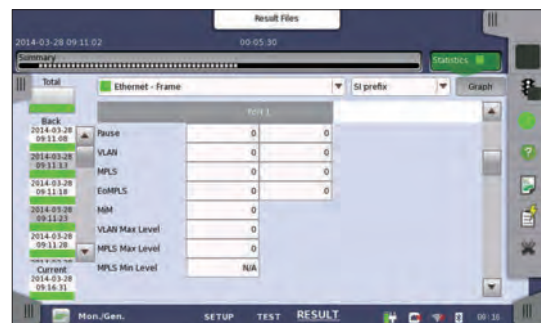

Protocol Counter

Ethernet Application

Carrier Ethernet Installation and Troubleshooting

Stacked VLAN

Stacked VLAN (Q-in-Q) is used increasingly by several types of Ethernet-based networks, allowing operators to split traffic from different customers on one line or to shape traffic by priority. The MU100010A/MU100011A supports up to 8 levels of VLAN tags, offering a powerful network test tool.

PBB

The Provider Backbone Bridge (PBB) technology is designed to provide Carrier Class division of the networks at layer 2 often referenced as MAC-in-MAC. Allowing multiple provider bridge networks to be interconnected without VLAN addresses conflict.

Protocol Analysis

For advanced Ethernet troubleshooting the MU100010A/MU100011A supports a frame capture function for capturing frames of live traffic on the monitored line. Captured frames are analyzed using the Wireshark protocol analysis software.

In-Band Test

Usually at least two field technicians must be dispatched for end-to-end testing, but using the MU100010A/MU100011A in-band measurement function to control the remote MT1000A from the local MT1000A via the test network, cuts the number of required field technicians and increases work efficiency.

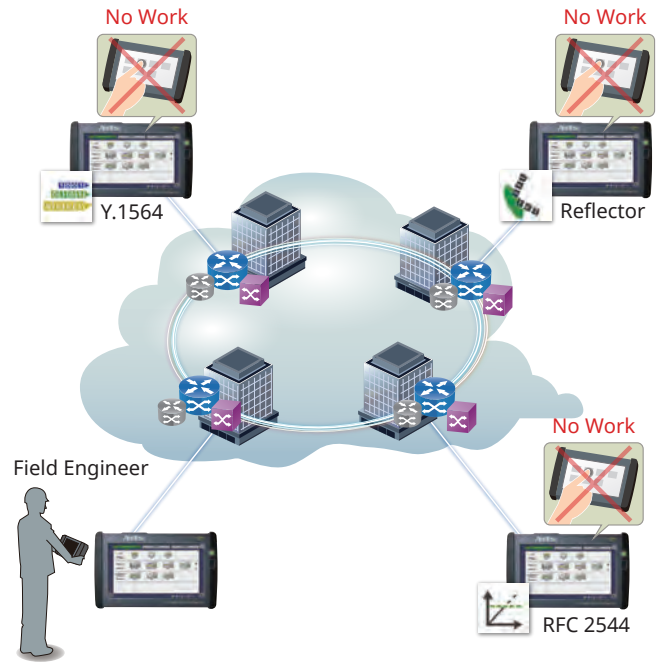

Broadcast Network Inspection

Quality Assurance

Ethernet is used for live video at events such as Olympics and concerts and for interactive video at public viewing, etc. Video image quality is degraded by latency and jitter. The MT1000A assures stable network quality using efficient throughput and packet jitter evaluations.

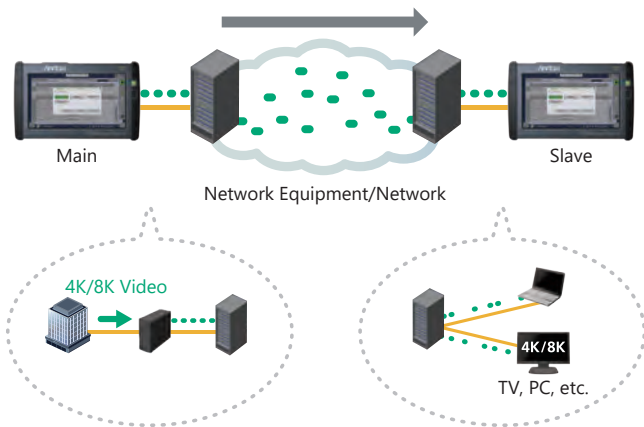

Multicast Group

Assuring video streaming services requires joining a multicast group. The MT1000A has a IGMP/MLD client function for measurements using multicast packets as well as analysis of actual multicast packets.

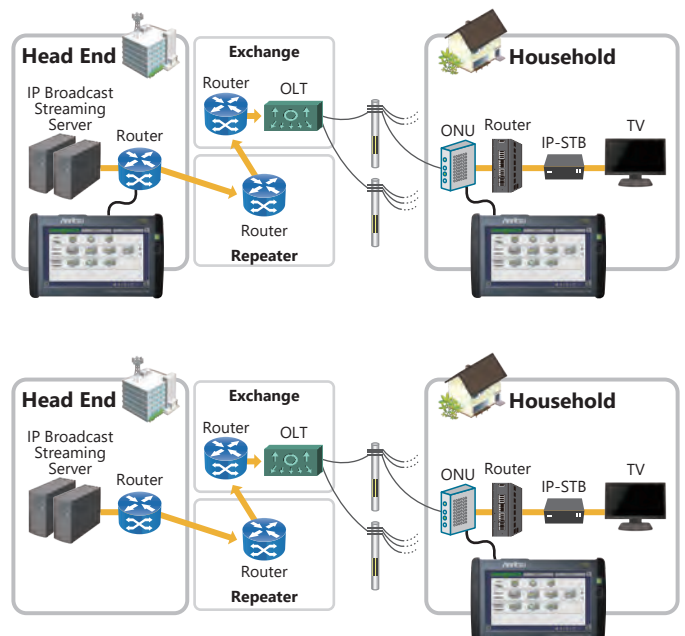

OTN Application

Comprehensive OTN Testing for Metro and Core Networks Installation and Maintenance

OTN carries client signals, but current OTN field testers only support OTN testing at the OTN line rate with bulk test signals. This means that problems in the carried client signals are invisible when testing an in-service OTN system.

Using the MU100010A/MU100011A, OTN lines can be tested at the client signal level with signals like Ethernet, CPRI, Fibre Channel and SDH/SONET, because the OTN mapping function is mandatory for modern OTN transponders. The MT1000A can also test OTN lines at the line rate with bulk signals.

The user can identify problems at all levels in the OTN signal, solving OTN issues efficiently, reducing system downtime, and reducing operating expenses for network operators.

OTN Testing with Client Signals

The MU100010A/MU100011A is a powerful and full toolset for testing OTN signals. It supports complete Bit Error Rate (BER) tests with bulk signals at the OTN level as well as tests all the way to the Ethernet, Fibre Channel and SDH/SONET client signals mapped onto the OTN signal.

OTN tests features include:

- OTU4, OTU3, OTU3e1, OTU3e2, OTU2, OTU2e, OTU2f, OTU1, OTU1e, OTU1f tests
- Multi Stage Mapping and ODU Flex support
- OTN tests with bulk signals (PRBS, Null or User pattern) at OTN level
- Comprehensive OTN error and alarm statistics
- OTN error performance measurement in accordance with G.8201 or M.2401
- ITU-T O.182-compliant FEC test
- Test of Ethernet, CPRI, Fibre Channel or SDH/SONET client signals mapped onto OTN signal
- Delay measurement
- OTN header edit and capture
- OTN TCM monitoring and generation
- Service disruption analysis using APS application
- OTN tributary scan
- Full flexibility to monitor insert/overwrite client overhead and payload within OTN signal

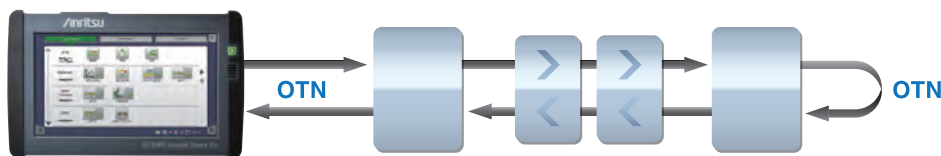

Looping-back test signal from MT1000A at far end supports easy OTN line quality tests

Out-of-service OTN Error and Alarm Statistics

The MU100010A/MU100011A supports powerful statistical measurements for BER tests as well as OTN level alarms and errors for installing/commissioning and troubleshooting out-of-service OTN lines. G.8201 or M.2401 error-performance parameters are calculated during measurement. Stress testing of network elements is supported by inserting errors and alarms, and adjusting overhead bytes in the signal transmitted by the instrument.



Error/Alarm Setting

Testing Ethernet, CPRI, Fibre Channel, or SDH/SONET Client Signals Mapped onto OTN Signal (Part of ODU Multiplexing Option)

The MU100010A/MU100011A tests OTN links carrying Ethernet, CPRI, Fibre Channel or SDH/SONET client signals, allowing the operator to test embedded client signals.

For example, an RFC 2544 or Y.1564 test can be performed with an Ethernet signal carried over the OTN signal, allowing the service engineer to run tests emulating the real-world requirements of end users.

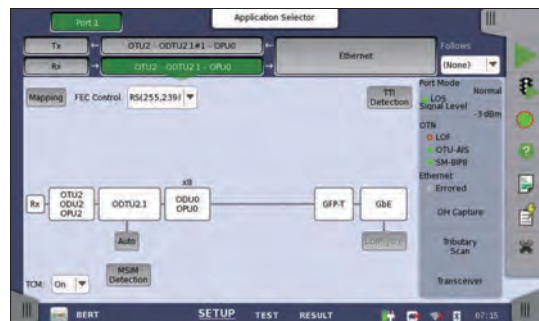

OTN Mapping Setting

Comprehensive OTN Testing for Metro and Core Networks Installation and Maintenance

ODUflex Test (with ODU Flex Option)

ODUflex is a new feature of OTN supporting flexible allocation of client-signal bandwidth to make best use of OTN capacity. The MU100010A/MU100011A with ODU Flex option supports ODUflex tests, allowing operators to verify this new technology on their networks.

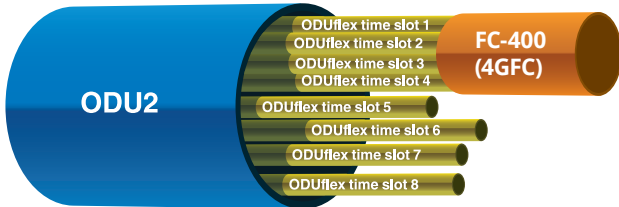

ODU Flex Option divides capacity of ODU2 into eight 1.25G ODUflex time slots. In the above example, an FC-400 (4GFC) Fibre Channel signal occupies four ODUflex time slots.

ITU-T O.182-compliant FEC Test

Anritsu proposed the FEC performance tests using Poisson-distributed random errors adopted by ITU-T Recommendation O.182. This method supports reproducible and accurate FEC error correction tests by generating truly random signal errors. High-speed networks cannot be tested accurately without using the ITU-T O.182 Poisson error distribution.

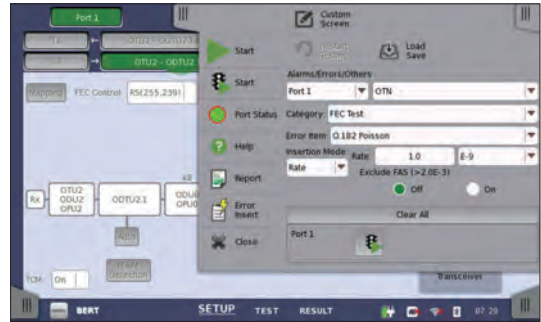

FEC Error Insertion



OTN Statistics Summary

OTN Tributary Scan

The tributary scan feature supports quick inspection of the OTN signal by examining it for major problems and highlighting them in an easy-to-understand manner.

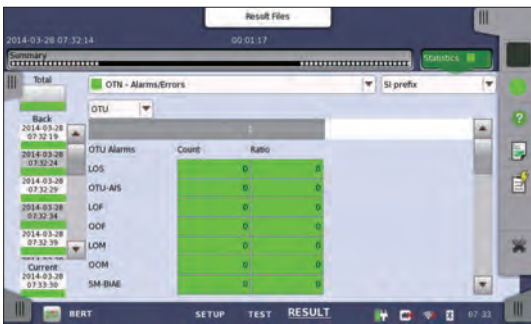

OTU Level Statistics

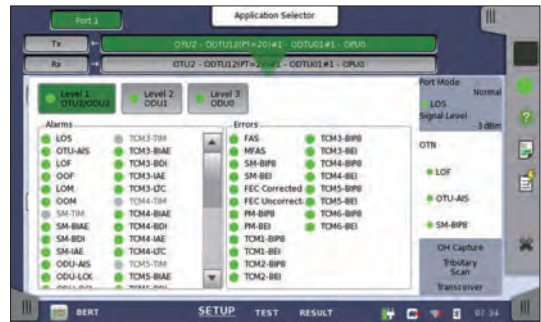

OTU Alarms and Errors View

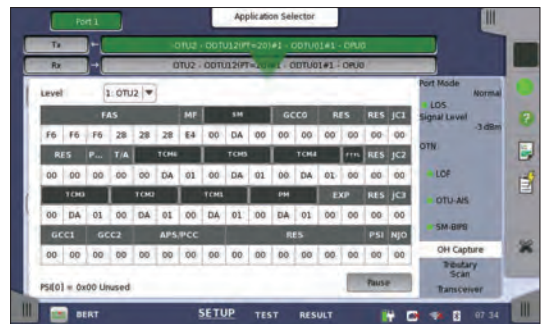

OTU Header Capture

Mobile xhaul Application

Tests using Throughput and Protocols

Operators are supporting the explosive spread of smartphones and tablets by increasing the bandwidth of mobile communications networks, in turn driving a complete change in mobile

So far, mobile front haul has been split into the Base Band Unit (BBU) and Remote Radio Head (RRU) with speed increased and ease of connected supported by using multiple antennas.

However, in addition to faster speeds, the key requirements for next-generation 5G mobile are higher reliability, lower latency, and multiple simultaneous user connections. As a result, mobile front haul requires:

- Change of interface between BBU and RRH from CPRI/OBSAI to eCPRI/RoE (IEEE1914.3)
- Improved time synchronization accuracy
- Large decreases in latency.

eCPRI/RoE (IEEE1914.3) Test

- BER tests using either eCPRI or RoE frame
- One and two-way latency time measurements*1
- Phase/Time synchronization accuracy tests
 - Time synchronization test using IEEE 1588 v2 1 pps TE supporting 1G/10G/25G Ethernet

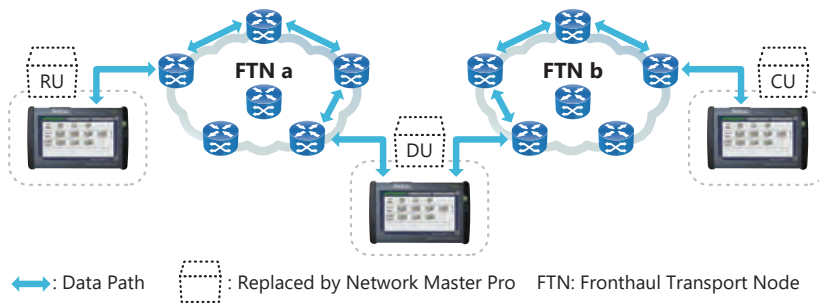

CPRI Test

- BER tests
- Various error and alarm tests
- Return Time Delay (RTD) tests
- Perform pass-through monitoring*2 and CPRI APS measurements
- Client signal mapped to OTN.

OBSAI Test

- BER tests
- Various error and alarms tests
- Return Time Delay (RTD)
- Perform OBSAI APS measurements

*1: Requires MU100011A for high-resolution measurement; requires two MT1000A/MU100011A/MU100090A units for measurement at distant location

*2: CPRI Option 9 and Option 10 not supported

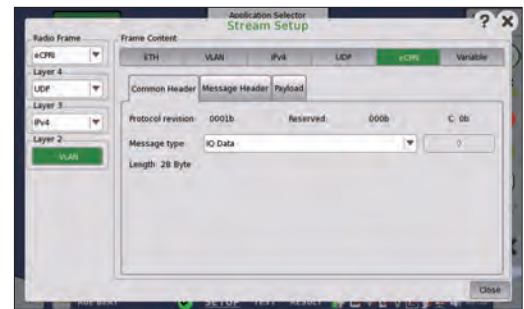
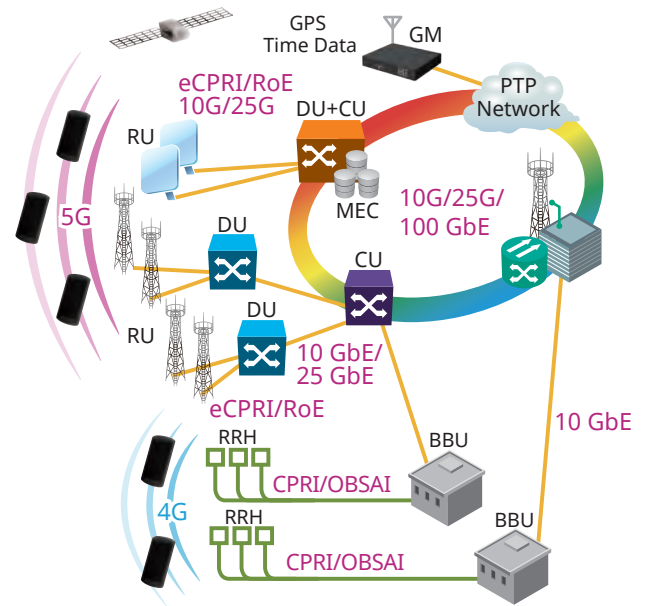

eCPRI Frame Setting

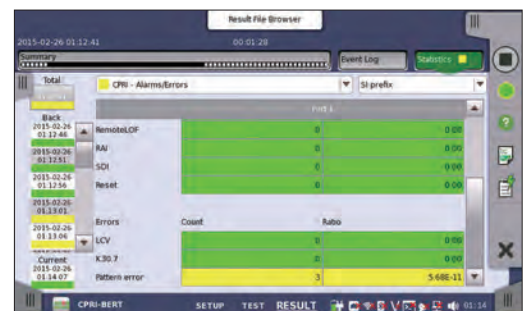

CPRI/OBSAI BER Test



CPRI Link Status

Mobile xhaul Application

Time Synchronization, Phase Evaluation

Mobile backhaul networks use IEEE 1588 v2 and synchronous Ethernet (SyncE) technologies. Since in-office base stations generate wireless signals based on a synchronizing signal distributed by the mobile backhaul, any mobile backhaul synchronization fault severely degrades the mobile radio performance. As a result, mobile operators must test that the SyncE and IEEE 1588 v2 technologies are functioning correctly.

Synchronous Ethernet test

The MU100010A/MU100011A support SyncE and IEEE 1588 v2 (G.8265.1, G.8275.1 and G.8275.2) protocol tests and analyses for monitoring SSM messages, and effectively troubleshooting and analyzing network faults, such as interoperability issues caused by abnormal vendor clock devices.

Time/Phase Synchronization Accuracy Tests

Mobile backhaul is starting construction of IEEE 1588 v2 (G.8275.1)-compliant time and phase-synchronized networks. The High Performance GPS Disciplined Oscillator MU100090A option measures the time and phase synchronization with high accuracy as a $\max|TE|$ (absolute Time Error), cTE (Constant Time Error), and dTE (Dynamic Time Error) matrix.* Combining it with the MU100010A/MU100011A adds pass/fail evaluation tests for commissioning time and phase-synchronized networks.

*: Peer-to-Peer only supports protocol emulation.

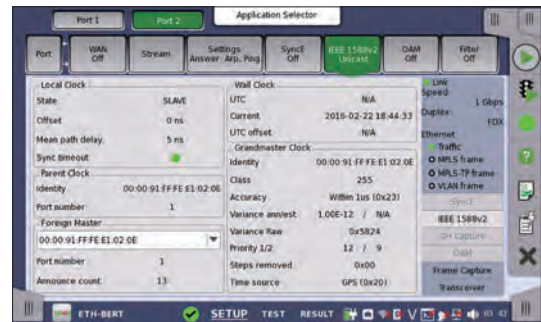
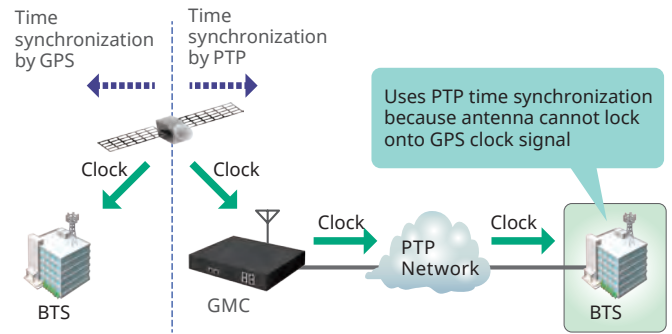

Status of IEEE 1588 v2 Slave Clock

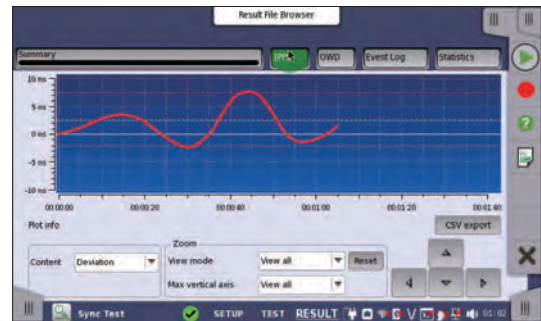

Phase Confirmation using MU100090A

Fibre Channel Application

Powerful Storage Area Networking (SAN) Testing

Many operators need to support Fibre Channel links in Storage Area Networks (SAN) together with other transport technologies like OTN, Ethernet, and SDH/SONET. Having one tool for all technologies is important for efficient testing. The multi-protocol MU100010A/MU100011A with Fibre Channel option is the perfect tool for deploying Fibre Channel with support for testing links at rates up to 10 Gbps and it also supports other technologies like OTN, Ethernet, CPRI/OBSAI, SDH/SONET and PDH/DSn. The all-in-one MT1000A gives the user less equipment to maintain and learn, helping reduce operating expenses.

Fibre Channel test features include:

- 1GFC, 2GFC, 4GFC, 8GFC, 10GFC, and 16GFC tests
- Latency measurement
- BER tests including service disruption measurement
- Line alarm and error monitor
- Normal or Reflector mode
- Performance Test
- Buffer Credit environment
- Optional mapping to OTN

Latency

High latency is a problem for many applications, including SAN, and network operators and service providers urgently need a tool like the MU100010A/MU100011A with Fibre Channel option to test latency on Fibre Channel lines and equipment.

Fibre Channel BER Tests

The MU100010A/MU100011A with Fibre Channel option supports BER tests to measure the performance of Fibre Channel lines and equipment. Service disruption measurement is also supported.

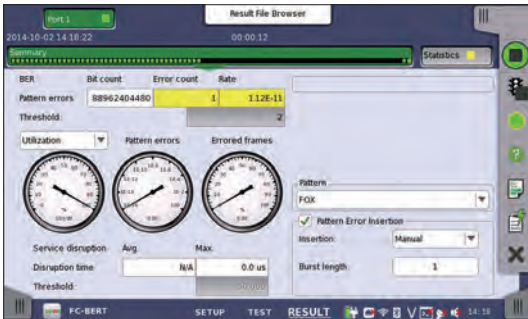

FC BER Test

Performance Tests

Fibre Channel achieves frame-loss-free transmissions using buffer-credit-based flow control. On the other hand, throughput rates drop due to the wasted wait times if the buffer size is small compared to the network transmission delay time.

The MU100010A/MU100011A measures the buffer size needed to achieve the required throughput and can play a key role in the following aspects of network I&M.

- Adjusting local parameters at commissioning testing
- Troubleshooting whether buffer size setting or network settings are causing lower throughput than the network design specification

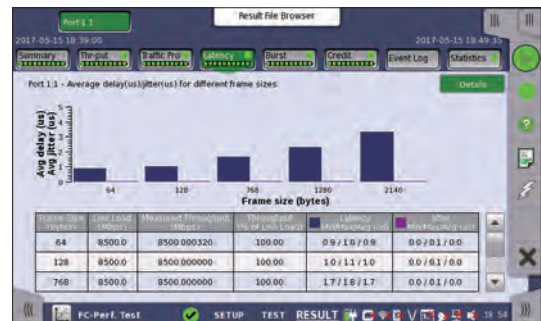

FC Performance Test

Flow Control

Credit-based Flow Control

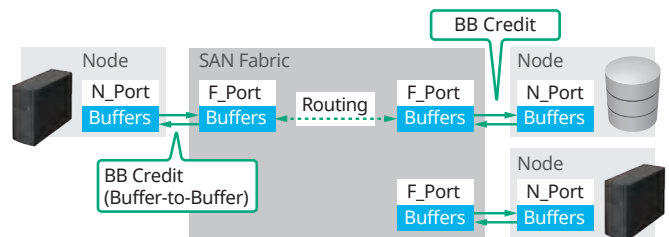

BB Credit

Flow control between physically connected ports. Used for propagation of data of all classes.

SDH/SONET, PDH/DSn Application

Quick and Easy Tests of SDH/SONET and PDH/DSn Networks

Legacy technologies in transport networks can't just be eliminated because of the huge capital investment, but keeping legacy technologies operational can require several testers.

With its SDH/SONET and PDH/DSn test options, the MU100010A/MU100011A is a powerful and easy-to-use tool for testing SDH/SONET up to STM-64/OC-192. PDH/DSn systems (E1, E3, E4, DS1 and DS3) can be tested directly or embedded into SDH/SONET. The MT1000A can support new and legacy technologies, leaving the user less equipment to maintain and learn, and reducing operating expenses.

SDH/SONET and PDH/DSn test features include:

- Powerful testing of SDH (STM-64, STM-16, STM-4, STM-1), SONET (OC-192, OC-48, OC-12, OC-3, STS-3) systems and embedded PDH (E1, E3, E4) and DSn (DS1, DS3) systems
- Powerful testing of PDH (E1, E3, E4) and DSn (DS1, DS3) systems
- Simultaneous bi-directional monitoring of SDH/SONET and PDH/DSn lines
- SDH/SONET mapping and de-mapping of PDH/DSn signals
- Comprehensive error and alarm statistics
- SDH/SONET overhead byte testing and monitoring
- SDH/SONET tributary scan
- SDH/SONET pointer event generation and monitoring
- SDH/SONET and PDH/DSn delay measurements
- Analysis of service disruption with APS application

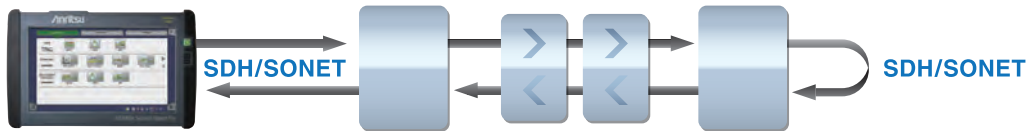

Looping-back test signal from MT1000A at far end supports SDH/SONET line quality tests

SDH/SONET Installing and Commissioning Testing

The MU100010A/MU100011A has powerful statistical measurements for BER testing at installing/commissioning and troubleshooting out-of-service SDH/SONET lines. Statistics are also collected for in-service analysis of line transmission-error performance together with information on pointer operations. G.826, G.828, G.829, or M.2100 error-performance parameters are calculated and the measurement result is highlighted by easy-to-understand color coding. Errors, alarms, pointer operations and overhead byte changes can be inserted into the transmitted signal for stress testing.

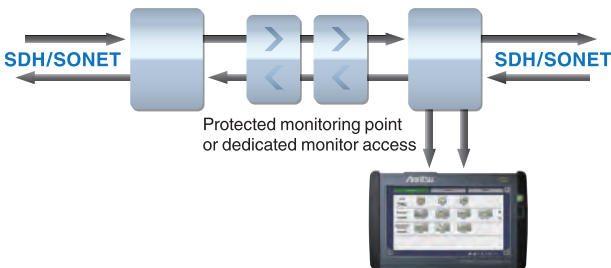

Bi-directional in-service monitoring of SDH/SONET lines



Quick overview of errors and alarms for both sides of SDH/SONET line

Speeds-up SDH/SONET Troubleshooting

The MU100010A/MU100011A monitor function speeds-up troubleshooting by providing key information on the monitored system, including line alarms and errors, input frequency and deviation, optical input level and overhead bytes. Information is also available on embedded PDH/DSn signals.

PDH (E1, E3, E4) and DSn (DS1, DS3) Testing

The MU100010A/MU100011A has powerful statistical measurements for BER testing at installing/commissioning and troubleshooting out-of-service PDH/DSn lines. Statistics are also collected for in-service analysis of line transmission-error performance of PDH/DSn lines, and G.826 or M.2100 error-performance parameters are calculated. Furthermore, PDH/DSn signals can be mapped to the SDH/SONET signal.

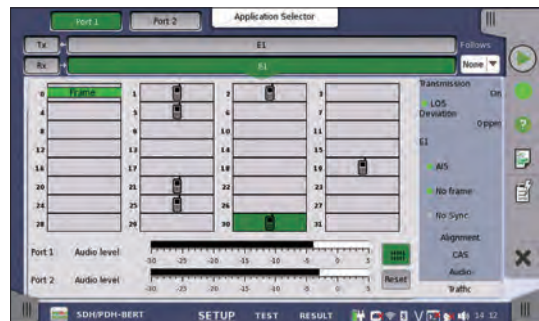

Monitor 64 kbps traffic channels on bidirectional E1 line with MU100010A/MU100011A traffic display

Optical Modules Selection Guide

Model/Order No.	Description (Approx. Distance)	Max. Input Power	Input Sensitivity	Input Wavelength	Output Power	Output Wavelength	Loop Back
G0332A 100M FX 1310 nm MM SFP	100BASE - FX 1310 nm multi mode (2 km)	-14 dBm	-31 dBm	1270 nm to 1600 nm	-20 to -15 dBm	1280 nm to 1380 nm	OK
G0319A Up to 2.7G 1310 nm 15 km SFP	STM-1/4/16 short haul 1310 nm single mode (15 km)	0 dBm	-18 dBm	1270 nm to 1580 nm	-5 to 0 dBm	1260 nm to 1360 nm	OK
G0320A Up to 2.7G 1310 nm 40 km SFP	STM-1/4/16 long haul 1310 nm single mode (40 km)	-9 dBm	-27 dBm	1270 nm to 1580 nm	-2 to +3 dBm	1280 nm to 1335 nm	>12 dB ATT
G0321A Up to 2.7G 1550 nm 80 km SFP	STM-1/4/16 long haul 1550 nm single mode (80 km)	-9 dBm	-28 dBm	1270 nm to 1580 nm	-2 to +3 dBm	1500 nm to 1580 nm	>12 dB ATT
G0328A 1G/2G/4G FC 850 nm SFP	1GFC, 2GFC, 4GFC 850 nm multi mode (0.5 km)	-3 dBm	-15 dBm	830 nm to 860 nm	-9 to 0 dBm	830 nm to 860 nm	>3 dB ATT
G0322A 1G/2G/4G FC 1310 nm SFP	1GFC, 2GFC, 4GFC 1310 nm single mode (10 km)	-3 dBm	-18 dBm	1260 nm to 1360 nm	-8 to 0 dBm	1260 nm to 1360 nm	>3 dB ATT
G0323A 1G/2G/4G FC 1550 nm SFP	1GFC, 2GFC, 4GFC 1550 nm single mode (40 km)	-3 dBm	-18 dBm	1470 nm to 1600 nm	0 to +5 dBm	1510 nm to 1590 nm	>8 dB ATT
G0315A 10G LR/LW 1310 nm SFP+	10GBASE - LR 1310 nm single mode (10 km)	+0.5 dBm	-14.4 dBm	1260 nm to 1565 nm	-6 to -1 dBm	1290 nm to 1330 nm	OK
G0316A 10G ER/EW 1550 nm 40 km SFP+	10GBASE - ER 1550 nm single mode (40 km)	-1 dBm	-15.8 dBm	1260 nm to 1565 nm	-3 to +3 dBm	1530 nm to 1560 nm	>4 dB ATT
G0318A 10G ZR/ZW 1550 nm 80 km SFP+	10GBASE - ER 1550 nm single mode (80 km)	-8 dBm	-22 dBm	1260 nm to 1565 nm	0 to +5 dBm	1525 nm to 1565 nm	>13 dB ATT
G0329A 10G LR 1310 nm SFP+	10GBASE - LR 1310 nm single mode (10 km)	+0.5 dBm	-14 dBm	1260 nm to 1355 nm	-8.2 to +0.5 dBm	1260 nm to 1355 nm	OK
G0356A 8G FC/10G SR 850 nm SFP+	8GFC, 10GFC, 10GBASE - SR 850 nm multi mode (0.3 km)	-1 dBm	-11.1 dBm	840 nm to 860 nm	-7.3 to -1 dBm	840 nm to 860 nm	OK
G0386A 16GFC SR 850 nm SFP+	16GFC 850 nm multi mode (0.035 km)	0 dBm	-10.5 dBm	840 nm to 860 nm	-7.5 dBm ~	840 nm to 860 nm	OK
G0387A 16GFC LR 1310 nm SFP+	16GFC 1310 nm single mode (10 km)	+2 dBm	-12 dBm	1295 nm to 1325 nm	-5 to +2 dBm	1295 nm to 1325 nm	OK
G0388A 25G SR 850 nm QSFP28	25GBASE - SR 850 nm multi mode (0.1 km)	+2.4 dBm	-10.3 dBm	840 nm to 860 nm	-8.4 to +2.4 dBm	840 nm to 860 nm	OK
G0389A 25G LR 1310 nm QSFP28	25GBASE - LR 1310 nm single mode (10 km)	+2 dBm	-13.3 dBm	1260 nm to 1350 nm	-7 to +2 dBm	1295 nm to 1325 nm	OK
G0359A 40G SR4 850 nm QSFP+	40GBASE - SR4 850 nm multi mode (0.1 km)	+2.4 dBm (per Lane)	-9.9 dBm	840 nm to 860 nm	-8 to +2.4 dBm	840 nm to 860 nm	OK
G0334A 40G LR4 1310nm QSFP+	40G Ethernet/OTN 1310 nm single mode (10 km)	+2.3 dBm (per Lane)	-11.5 dBm (per Lane)	1264.5 nm to 1277.5 nm 1284.5 nm to 1297.5 nm 1304.5 nm to 1317.5 nm 1324.5 nm to 1337.5 nm	+8.3 dBm (max.) (Total) -2 to +2.3 dBm (per Lane)	1264.5 nm to 1277.5 nm 1284.5 nm to 1297.5 nm 1304.5 nm to 1317.5 nm 1324.5 nm to 1337.5 nm	OK
G0366A 100G SR4 850 nm QSFP28	100G Ethernet 850 nm multi mode (0.1 km)	+2.4 dBm (per Lane)	-9.9 dBm (per Lane)	840 nm to 860 nm	+8.9 dBm (max.) (Total) -9.1 to +2.4 dBm (per Lane)	840 nm to 860 nm	OK
G0364A 100G LR4 1310 nm QSFP28	100G Ethernet 1310 nm single mode (10 km)	+4.5 dBm (per Lane)	-8.6 dBm (per Lane)	1294.53 nm to 1296.59 nm 1299.02 nm to 1301.09 nm 1303.54 nm to 1305.63 nm 1308.09 nm to 1310.19 nm	+10.5 dBm (max.) (Total) -4.3 to +4.5 dBm (per Lane)	1294.53 nm to 1296.59 nm 1299.02 nm to 1301.09 nm 1303.54 nm to 1305.63 nm 1308.09 nm to 1310.19 nm	OK
G0365A 100G LR4 Dual Rate 1310 nm QSFP28	100G Ethernet /OTN 1310 nm single mode (10 km)	+4 dBm (per Lane)	-8.4 dBm (per Lane)	1294.53 nm to 1296.59 nm 1299.02 nm to 1301.09 nm 1303.54 nm to 1305.63 nm 1308.09 nm to 1310.19 nm	+10 dBm (max.) (Total) -0.6 to +4 dBm (per Lane)	1294.53 nm to 1296.59 nm 1299.02 nm to 1301.09 nm 1303.54 nm to 1305.63 nm 1308.09 nm to 1310.19 nm	OK
G0369A 100G LR4 Dual Rate 1310 nm CFP4	100G Ethernet /OTN 1310 nm single mode (10 km)	+4.5 dBm (per Lane)	-8.6 dBm (per Lane)	1294.53 nm to 1296.59 nm 1299.02 nm to 1301.09 nm 1303.54 nm to 1305.63 nm 1308.09 nm to 1310.19 nm	+10.5 dBm (max.) (Total) -4.3 to +4.5 dBm (per Lane)	1294.53 nm to 1296.59 nm 1299.02 nm to 1301.09 nm 1303.54 nm to 1305.63 nm 1308.09 nm to 1310.19 nm	OK

Optical Modules Selection Guide

MUJ10010A	Model/ Order No.	Name	Form Factor	100 Meg Ethernet	156 Meg STM-1	614 Meg CPRI	622 Meg STM-4	768 Meg OBSAI	1GFC	1.23 Gig CPRI	1.25 Gig Ethernet	1.54 Gig OBSAI	2GFC	2.46 Gig CPRI	2.488 Gig STM-16	2.67 Gig OTU1	3.07 Gig CPRI OBSAI	4GFC	4.92 Gig CPRI	6.14 Gig CPRI OBSAI	8GFC	9.83 Gig CPRI	9.95 Gig STM-64	10.1 Gig CPRI	10.3 Gig Ethernet	10GFC	10.7 Gig OTU2	11.05 Gig OTU1e	11.09 Gig OTU2e	11.27 Gig OTU1f	11.3 Gig OTU2f	16GFC	25G Ethernet	40G Ethernet	40G OTN	100G Ethernet	100G OTN					
✓	G0332A	100M FX 1310 nm MM SFP	SFP	1310 nm, MM, 2 km																																						
✓	G0319A	Up to 2.7G 1310 nm 15 km SFP	SFP		1310 nm, SM, 15 km																																					
✓	G0320A	Up to 2.7G 1310 nm 40 km SFP	SFP		1310 nm, SM, 40 km																																					
✓	G0321A	Up to 2.7G 1550 nm 80 km SFP	SFP		1550 nm, SM, 80 km																																					
✓	G0328A	1G/2G/4G FC 850 nm SFP	SFP						850 nm, MM, 0.5 km																																	
✓	G0322A	1G/2G/4G FC 1310 nm SFP	SFP						1310 nm, SM, 10 km																																	
✓	G0323A	1G/2G/4G FC 1550 nm SFP	SFP						1550 nm, SM, 40 km																																	
✓	G0315A	10G LR/LW 1310 nm SFP+	SFP+																		1310 nm, SM, 10 km																					
✓	G0316A	10G ER/EW 1550 nm 40 km SFP+	SFP+																		1550 nm, SM, 40 km																					
✓	G0318A	10G ZR/ZW 1550 nm 80 km SFP+	SFP+																		1550 nm, SM, 80 km																					
✓	G0329A	10G LR 1310 nm SFP+	SFP+						1310 nm, SM, 10 km																																	
✓	G0356A	8G FC/10G SR 850 nm SFP+	SFP+																		850 nm, MM, 0.3 km																					
✓	G0386A	16GFC SR 850 nm SFP+	SFP+																																							
✓	G0387A	16GFC LR 1310 nm SFP+	SFP+																																							
✓	G0388A	25G SR 850 nm SFP28	SFP28																																							
✓	G0389A	25G LR 1310 nm SFP28	SFP28																																							
✓	G0359A	40G SR4 850 nm QSFP+	QSFP+																																							
✓	G0334A	40G LR4 1310 nm QSFP+	QSFP+																																							
✓	G0366A	100G SR4 850 nm QSFP28	QSFP28																																							
✓	G0364A	100G LR4 1310 nm QSFP28	QSFP28																																							
✓	G0365A	100G LR4 Dual Rate 1310 nm QSFP28	QSFP28																																							
✓	G0369A	100G LR4 Dual Rate 1310 nm CFP4	CFP4																																							

Network Master Pro MT1000A Mainframe Specifications

User Interfaces	
Display	9-inch active TFT display (800 × 480 pixels) and touch screen
Supported Languages	English, Chinese, Japanese, French, Russian, Spanish, Finnish, Korean, German

Service Interfaces	
USB Data Interface	MT1000A operates as host: USB 2.0 type A (2 ports) MT1000A operates as device: USB 2.0 type Mini-B (1 port)
Ethernet Interface	Ethernet 10M/100M/1000M, Connector: RJ45
WLAN Interface*1	IEEE 802.11 b/g/n
Bluetooth Interface*1	Bluetooth 2.1 +EDR

*1: Available for certified countries and regions including USA, Canada, Japan and EU countries. Please visit the Anritsu web site for updated information.
The Bluetooth® mark and logos are registered trademarks of Bluetooth SIG, Inc.

Other Interfaces	
Audio Interface	For connection of CTIA Standard head set Connector: 3.5-mm diameter jack
AUX Connector	For connection of optional G0325A GPS receiver With MT1000A-005: For connection of Optional MU100090A
Built-in Loudspeaker	Monitors speech of voice channel Output level: user-controlled from user Interface
Internal Clock	Accuracy: ±4.6 ppm or less, STRATUM3 compliant
Ext. Clock Input	For connection of external clock signals: SETS (E1: 2.048 Mbps), BITS (DS1: 1.544 Mbps) or 2.048 MHz TTL signal in accordance with ITU-T G.703, 10 MHz Connector: BNC (50Ω)

Miscellaneous		
Battery	10.8 V rechargeable and replaceable intelligent Li-ion battery Operating time: 1.5 hours (typ., in case of 100 GbE) Charging time: 6 hours (Max.) Remaining capacity indication: %	
Mains Adapter	Input: 100 V(ac) to 240 V(ac), 50 Hz/60 Hz Output: 18 V(dc), 3.62 A (max.) Power Consumption: ≤65 W With MT1000A-006*2 Input: 100 V(ac) to 240 V(ac), 50 Hz/60 Hz Output: 18 V(dc), 6.6 A (max.) Power Consumption: ≤120 W	
Dimensions and Mass	257 (W) × 164 (H) × 82 (D) mm (Exclude Projection, MT1000A + MU100010A) 257 (W) × 164 (H) × 89 (D) mm (Exclude Projection, MT1000A + MU100011A) 2.7 kg (including MT1000A, MU100010A and battery) 2.7 kg (including MT1000A, MU100011A and battery)	
Environmental	Temperature Operating : 0°C to +50°C (non-condensing) Charging: 0°C to +40°C (non-condensing) Storage: -30°C to +60°C (non-condensing, without battery or AC adapter) -20°C to +50°C (non-condensing, with battery and AC adapter) Humidity Operating: ≤85% RH (non-condensing) Storage and Transportation: ≤90% RH (non-condensing, without battery and AC adapter) Storage and Transportation: ≤85% RH (non-condensing, with battery and AC adapter)	
CE	EMC	2014/30/EU, EN61326-1, EN61000-3-2
	LVD	2014/35/EU, EN61010-1
	RoHS	2011/65/EU, EN50581
Laser Safety*3	IEC 60825-1:2007 Class 1M CFP4: 100GBASE-SR4 QSFP+: 40GBASE-SR4 QSFP28: 100GBASE-SR4 SFP28: 25GBASE-SR IEC 60825-1:2007 Class 1 CFP4: 100GBASE-LR4 QSFP+: 40GBASE-LR4 QSFP28: 100GBASE-LR4 SFP28: 25GBASE-LR SFP+: 1000BASE-SX/LX/ZX, 10GBASE-LR/ER/ZR SFP: 4G FC (SX), 4G FC (LX), 4G FC (EX), OC-48 LR-1/STM L-16.1, OC-48 LR-2/STM L-16.2, 100BASE-FX/LX FDA 21CFR1040.10 and 1040.11*4	

*2: MT1000A-006 is required for MU100011A.

*3: Safety measures for laser products

This product complies with optical safety standards in 21CFR1040.10, 1040.11 and IEC 60825-1; the following descriptive labels are affixed to the product.

*4: Excludes deviations caused by conformance to Laser Notice No. 50 dated June 24, 2007

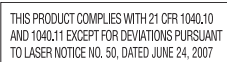

Panel Layout

Network Master Pro MT1000A

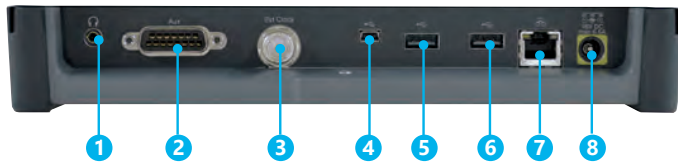
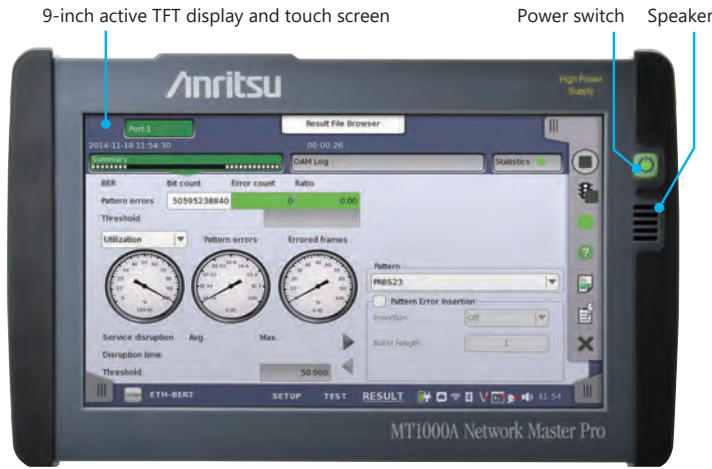

10G Multirate Module MU100010A

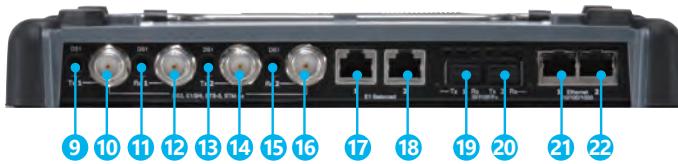

100G Multirate Module MU100011A

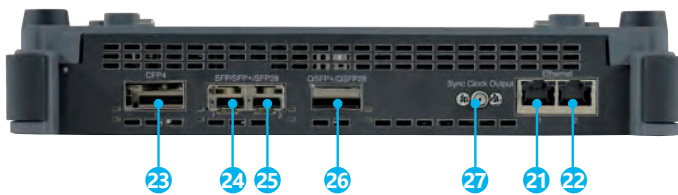

High Performance GPS Disciplined Oscillator MU100090A

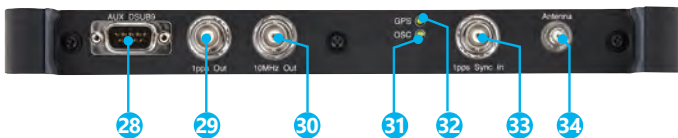

- 1 Audio (3.5ø: CTIA Standard)
- 2 AUX (D-SUB 15 pin)
- 3 Clock Input
- 4 USB Mini-B
- 5 USB A
- 6 USB A
- 7 Ethernet Service Interface
- 8 DC Input (18 Vdc)
- 9 Port 1, Tx Bantam (DS1)
- 10 Port 1, Tx BNC (E1, E3, E4, DS3, STM-1e, STS-3)
- 11 Port 1, Rx Bantam (DS1)
- 12 Port 1, Rx BNC (E1, E3, E4, DS3, STM-1e, STS-3)
- 13 Port 2, Tx Bantam (DS1)
- 14 Port 2, Tx BNC (E1, E3, E4, DS3, STM-1e, STS-3)
- 15 Port 2, Rx Bantam (DS1)
- 16 Port 2, Rx BNC (E1, E3, E4, DS3, STM-1e, STS-3)
- 17 Port 1, Tx/Rx RJ48 (E1 balanced)
- 18 Port 2, Tx/Rx RJ48 (E1 balanced)
- 19 Port 1, Tx/Rx SFP/SFP+ (OTN, Ethernet, eCPRI/RoE/CPRI/OBSAI, Fibre Channel, SDH/SONET optical)
- 20 Port 2, Tx/Rx SFP/SFP+ (OTN, Ethernet, eCPRI/RoE/CPRI/OBSAI, Fibre Channel, SDH/SONET optical)
- 21 Port 1, Tx/Rx RJ45 (Ethernet, eCPRI/RoE electrical)
- 22 Port 2, Tx/Rx RJ45 (Ethernet, eCPRI/RoE electrical)
- 23 Port 1, Tx/Rx CFP4 (OTN, Ethernet, eCPRI/RoE)
- 24 Port 1, Tx/Rx SFP/SFP+/SFP28 (OTN, Ethernet, eCPRI/RoE/CPRI/OBSAI, Fibre Channel, SDH/SONET)
- 25 Port 2, Tx/Rx SFP/SFP+/SFP28 (OTN, Ethernet, eCPRI/RoE/CPRI/OBSAI, Fibre Channel, SDH/SONET)
- 26 Port 1, Tx/Rx QSFP+/QSFP28 (OTN, Ethernet, eCPRI/RoE)
- 27 Port 1, Sync. Clock Output
- 28 AUX (D-SUB 9 pin)
- 29 1 pps Output (REF)
- 30 10 MHz Output
- 31 OCS LED
- 32 GPS received LED
- 33 1 pps Sync In
- 34 Antenna Input



Rechargeable and replaceable Li-ion battery

Network Master Pro MT1000A Ordering Information

Please specify the model/order number, name and quantity when ordering.
The names listed in the table below are Order Names. The actual name of the item may differ from the Order Name.

Mainframe

Model/Order No.	Name
MT1000A	Network Master Pro
Standard Accessories	
MT1000A-006*1	High Power Supply: Installed
	Line Cord*2: 1 pc
B0745A	Softcase: 1 pc
B0728A*3	Rear Panel kit: 1 pc
G0385A*4	High Power AC Adaptor: 1 pc
G0310A	Li-ion Battery: 1 pc
Z1746A	Stylus: 1 pc
Z1747A*5	Carrying Strap: 1 pc
Z1748A*6	Handle: 1 pc
Z1817A*7	Utilities ROM: 1 pc
Options	
MT1000A-003*8	Connectivity for WLAN/Bluetooth
MT1000A-005*9	AUX I/O

Model/Order No.	Name
Optional Accessories	
B0691B*10	Hard Case
B0720A	Rear Panel
B0729A*11	Screw 1U
B0730A*11	Screw 2U
B0731A*11	Screw 3U
B0732A*12	Screw Kit
G0382A*13	Autofocus Video Inspection Probe
G0306B*13	Video Inspection Probe
G0309A*4	AC Adapter
G0324A	Battery Charger
G0325A	GPS Receiver
J1569B	Car 12 Vdc Adapter
J1667A*14	GPIO-USB Converter
Z1821A*15	Utilities in USB Stick

Softcase B0745A (Standard Accessory)

This bag with shoulder strap can hold the MT1000A with up to three installed modules.



Hard Case B0691B

This strong plastic case can hold the MT1000A with up to two installed modules.
462 (W) × 372 (H) × 207 (D) mm



Module Configuration*16

1 Module		
2 Modules		
3 Modules		

*1: The presence of the MT1000A-006 option can be recognized at the top right of the front panel. To retrofit to the already shipped item, please contact us.



Without MT1000A-006



With in MT1000A-006

*2: One line cord is attached to the area to shipment.

*3: Composed of B0720A, B0729A, B0730A and B0731A.

Refer to Module Composition for the module combination.

*4: The MT1000A with MT1000A-006 can be used. Use the AC adapter when using the MT1000A without MT1000A-006 installed.

*5: Shoulder strap for MT1000A.

*6: Hand strap for MT1000A.

*7: This DVD includes PDF files and formatting tools of each product's instruction manual (such as W3933AE, W3810AE, W3736AE, W3946AE).

*8: Available for certified countries and regions including USA, Canada, Japan and EU countries. Please visit the Anritsu web site for updated information.

*9: MT1000A-005 is required for MU100090A. To retrofit to the already shipped item, please contact us.

*10: Can use module 1 to 2 in combination

*11: Includes 4 bolts of same length

*12: Includes B0729A, B0730A and B0731A

*13: This fiberscope uses the VIP function in the MT1000A Utility menu.

Different tip types are used by the G0382A and G0306B.



G0382A



G0306B

*14: J1667A is required for SCPI remote control via GPIO

*15: Include MT1000A Operation Manual and the Remote Script Manual.

*16: Any modular combination as shown in a figure.

*17: Required if the transport module is not used rear cover.

Network Master Pro MT1000A Ordering Information

Transport Module

10G Multirate Module MU100010A

Model/Order No.	Name
MU100010A	10G Multirate Module
Standard Accessories	
W3935AE	MT1000A Transport Module Quick Reference Guide: 1 pc
B0692A*1	ESD Box (for optical modules): 1 pc

*1: Up to four SFP+/SFPS can be stored.

Options*2

Model/Order No.	Name
Low Rate	
MU100010A-001*3	Up to 2.7G Dual Channel
Ethernet	
MU100010A-011	Ethernet 10G Single Channel
MU100010A-012	Ethernet 10G Dual Channel
MU100010A-020*4	TCP Throughput
OTN	
MU100010A-051	OTN 10G Single Channel
MU100010A-052	OTN 10G Dual Channel
MU100010A-061*5	ODU Multiplexing
MU100010A-062*5	ODU Flex
CPRI/OBSAI	
MU100010A-071	CPRI/OBSAI Up to 5G Dual Channel
MU100010A-072	CPRI/OBSAI 6G to 10G Single Channel
MU100010A-073	CPRI/OBSAI 6G to 10G Dual Channel
Fibre Channel	
MU100010A-002	FC 1G 2G 4G Dual Channel
MU100010A-091	FC 8G 10G Single Channel
MU100010A-092	FC 8G 10G Dual Channel
SDH/SONET	
MU100010A-081	STM-64 OC-192 Single Channel
MU100010A-082	STM-64 OC-192 Dual Channel

*2: This option can be retrofitted.

The Model/Order No. of retrofit option is "-3**".

Example

As a retrofit, MU100010A-001 Up to 2.7G Dual Channel becomes MU100010A-301 Up to 2.7G Dual Channel Retrofit. In addition, specify one of the following media along with the required option.

Model/Order No.	Name
Z1849A	DVD-ROM for Retrofit Options
Z1850A	USB Stick for Retrofit Options

*3: Includes OTN (OTU1), Ethernet (10 Mbps, 100 Mbps, 1 Gbps), SDH up to STM-16, SONET up to OC-48, PDH (E1, E3, E4), and DSn (DS1, DS3)

*4: Requires that at least one of the following options is installed: MU100010A-001, MU100010A-011, MU100010A-012

*5: Requires that at least one of the following options is installed: MU100010A-001, MU100010A-051, MU100010A-052

100G Multirate Module MU100011A

Model/Order No.	Name
MU100011A*6	100G Multirate Module
Standard accessories	
W3935AE	MT1000A Transport Module Quick Reference Guide: 1 pc
B0763A*7	ESD Box (for Optical modules): 1 pc

*6: MT1000A-006 is required for MU100011A.

*7: One CFP4 plus either up to two QSFP28s or up to four SFP/SFP+s can be stored.

Options*2

Model/Order No.	Name
Standard	
MU100011A-001*8	Up to 10G Single Channel
MU100011A-003*8	Up to 10G Dual Channel
Ethernet	
MU100011A-013	Ethernet 40G Single Channel
MU100011A-015	Ethernet 100G Single Channel
MU100011A-017*9	Ethernet 25G Single Channel
MU100011A-020*10	TCP Throughput
MU100011A-023*11	RS-FEC for 100GBASE-SR4
OTN	
MU100011A-053	OTN 40G Single Channel
MU100011A-055	OTN 100G Single Channel
MU100011A-062*12	ODU Flex
MU100011A-063*12	ODU Multiplexing/Multi Stage
Fibre Channel	
MU100011A-004	Up to 10G FC Single Channel
MU100011A-005	Up to 10G FC Dual Channel
MU100011A-091	FC 16G Single Channel
eCPRI/RoE/CPRI/OBSAI	
MU100011A-071	CPRI/OBSAI Up to 10G Single Channel
MU100011A-072	CPRI/OBSAI Up to 10G Dual Channel
MU100011A-073	CPRI 12/25G Single Channel
MU100011A-074	CPRI 12/25G Dual Channel
MU100011A-075*9, *13	eCPRI/RoE 25G Dual Channel
SDH/SONET	
MU100011A-083*14	STM-256/OC-768 Client Signal

*8: Only one of these option can be installed.

Included OTN(OTU1, OTU1e, OTU1f, OTU2, OTU2e, OTU2f), Ethernet up to 10 Gbps, SDH up to STM-64 and SONET up to OC-192.

*9: FEC selectable On/Off.

*10: Requires that at least one of the following option is installed: MU100011A-001, MU100011A-003

*11: Requires to MU100011A-015

*12: Requires that at least one of the following option is installed: MU100011A-001, MU100011A-003, MU100011A-053, MU100011A-055

*13: Option supports eCPRI RoE protocol test only.

*14: MU100011A does not have a physical interface of the option. The option is required for client signal mapped in the OTN.

High Performance GPS Disciplined Oscillator MU100090A

Model/Order No.	Name
MU100090A*15	High Performance GPS Disciplined Oscillator
Standard Accessories	
J1705A	AUX Conversion Adaptor
J1706A	GPS Antenna
J1710A	BNC Cable (20 cm) × 2

*15: Excellent Eco Product non-compliant.

MT1000A-005 is required for MU100090A.

Network Master Pro MT1000A Ordering Information

Optional Accessories for Transport Module

Model/Order No.	Name
Operation Manuals	
W3933AE	MT1000A Transport Module Operation Manual
W3736AE	MT1000A/MT1100A Remote Scripting Operation Manual
Optical Module	
G0332A	100M FX 1310 nm MM SFP
G0319A	Up to 2.7G 1310 nm 15 km SFP
G0320A	Up to 2.7G 1310 nm 40 km SFP
G0321A	Up to 2.7G 1550 nm 80 km SFP
G0328A	1G/2G/4G FC 850 nm SFP
G0322A	1G/2G/4G FC 1310 nm SFP
G0323A	1G/2G/4G FC 1550 nm SFP
G0315A	10G LR/LW 1310 nm SFP+
G0316A	10G ER/EW 1550 nm 40 km SFP+
G0318A	10G ZR/ZW 1550 nm 80 km SFP+
G0329A	10G LR 1310 nm SFP+
G0356A	8G FC/10G SR 850 nm SFP+
G0386A	16GFC SR 850 nm SFP+
G0387A	16GFC LR 1310 nm SFP+
G0388A	25G SR 850 nm SFP28
G0389A	25G LR 1310 nm SFP28
G0359A	40G SR4 850 nm QSFP+
G0334A	40G LR4 1310 nm QSFP+
G0366A	100G SR4 850 nm QSFP28
G0364A	100G LR4 1310 nm QSFP28
G0365A	100G LR4 Dual Rate 1310 nm QSFP28
G0369A	100G LR4 Dual Rate 1310 nm CFP4
Cables	
J1571A	Optical Cable SM LC/PC to SC/PC 3 m
J1575A	Optical Cable SM LC/PC to FC/PC 3 m
J1579A	Optical Cable SM LC/PC to LC/PC 3 m
J1581A	Optical Cable MM LC/PC to LC/PC 3 m
J1583A	Optical Attenuator 10 dB LC/PC to LC/PC
J1584A	RJ45 Cable 3 m
J1585A*1	RJ48 to Crocodile Clips Cable 3 m
J1586A*1	RJ48 to Crocodile Clips Cable 20 dB ATT 3 m
J1588A*2	BNC Cable 2.5 m
J1589A*2	BNC to 1.6/5.6 Cable 2.5 m
J1591A*1	RJ48 to Two 3-pin Banana Plug Cable 2.5 m
J1597A*1	RJ48 Balanced PDH Cable Crossed 3 m
J1598A*3	Bantam Cable 3 m
J1710A*4	BNC Cable 0.2 m
J0127B*4	COAXIAL CORD, 2.0 M

*1: E1 interface cable.

*2: E1, E3, E4, DS3, STM-1e, STS-3 interface cable. Impedance: 75Ω

*3: DS1 interface cable.

*4: 50Ω impedance cable for MU100090A and main-frame external clock input connector

Maintenance Service

Model/Order No.	Name
MT1000A-ES210	2 Years Extended Warranty Service
MT1000A-ES310	3 Years Extended Warranty Service
MT1000A-ES510	5 Years Extended Warranty Service
MU100010A-ES210	2 Years Extended Warranty Service
MU100010A-ES310	3 Years Extended Warranty Service
MU100010A-ES510	5 Years Extended Warranty Service
MU100011A-ES210	2 Years Extended Warranty Service
MU100011A-ES310	3 Years Extended Warranty Service
MU100011A-ES510	5 Years Extended Warranty Service
MU100090A-ES210	2 Years Extended Warranty Service
MU100090A-ES310	3 Years Extended Warranty Service
MU100090A-ES510	5 Years Extended Warranty Service

Network Master Pro MT1000A Ordering Information

Remote Software Service

The following licenses must be purchased to use the MX109020A Site Over Remote Access.

Mainframe Option License

Model/Order No.	Name
MT1000A-003*1	WLAN/Bluetooth Connect
MT1000A-011*2	Site Over Remote Access Connect

*1: Available for certified countries and regions including USA, Canada, Japan and EU countries. Please visit the Anritsu web site for updated information.
The Bluetooth® mark and logos are registered trademarks of Bluetooth SIG, Inc.

*2: Validity period is unlimited. An open TCP port may be required to allow the MT1000A to be connected from an in-company LAN to MX109020A, depending on the LAN security policy.

Subscription Option License

Model/Order No.	Name
MX109020A*3, *5, *6, *7	Site Over Remote Access Basic License
MX109020A-TL001*3, *4	Site Over Remote Access 1 Year License
MX109020A-001*5	Site Over Remote Access 8 Units
MX109020A-002*5	Site Over Remote Access Unlimited Units

*3: We recommend purchasing a 1-year license in addition to the basic license.

*4: When extending the usage period, we recommend purchasing in 1-year license periods

*5: Up to two measuring instruments can be remotely controlled simultaneously with the basic license.

This number can be increased to up to 8 units by purchasing the MX109020A-001 option, and up to 100 units by purchasing the MX109020A-002 option.

*6: You must agree to the service terms before purchasing SORA.

Refer to the service terms at the following URL: <https://www.anritsu.com/en-AU/test-measurement/support/downloads/manuals/dwl20059>

*7: This product cannot be used in some regions and countries; please read the service terms for more details.

Network Master Pro MT1000A

Related Products

Network Master Pro MT1000A



OTDR Module 1310/1550 nm SMF	MU100020A
OTDR Module 1310/1550/850/1300 nm SMF/MMF	MU100021A
OTDR Module 1310/1550/1625 nm SMF	MU100022A
OTDR Module 1310/1550/1650 nm SMF	MU100023A

Installing an OTDR Module MU100020A/MU100021A/MU100022A/MU100023A provides the OTDR functions required for optical fiber I&M. Work efficiency is increased by all-in-one support for optical fiber tests and data communications network commissioning. I&M tests of 1.5 Mbps to 100 Gbps communications networks can be executed by simultaneously installing the MU100010A or MU100011A. In addition to supporting Ethernet, OTN, etc., networks, Mobile base station CPRI and OBSAI, as well as SyncE protocols are also supported.

CPRI RF Module MU100040B

Installing the CPRI RF Module MU100040B in the MT1000A supports analysis of IQ signal frequency characteristics included in CPRI signals between the LTE base station RRH and BBU. This can be used to check operation of the RRH after installation. MU100040B supported BBU emulation for RRH.



Network Master Flex MT1100A



All-in-one, up to 4-port transport tester supporting from 1.5 Mbps to 100 Gbps including OTN, Ethernet, eCPRI/RoE/CPRI/OBSAI, Fibre Channel, SDH/SONET and PDH/DSn.



MT9090A Series



μOTDR Module MU909014/15

Compact OTDR for full automatic verification of optical networks, FTTH-PON, Metro and Core.



Gigabit Ethernet Module MU909060A

Dedicated field test solution for installation and troubleshooting Ethernet links in access networks.



CMA5 Series

Light Source/Optical Power Meter

For optical fiber installation and maintenance.



ACCESS Master MT9085 Series

For WAN/MFH/DCI/FTTH Optical Fiber I&M

- Improved operability with powerful synergy of 8-inch touchscreen and hardware keys
- At-a-glance Pass/Fail evaluation using Fiber Visualizer
- All OTDR, OLTS, and Visible Light Source operations on one screen
- Short event dead zone of ≤ 0.8 m and high dynamic range of 46 dB max.
- Power meter option for measuring optical power up to +30 dBm



• **United States**

Anritsu Americas Sales Company

450 Century Parkway, Suite 190, Allen, TX 75013 U.S.A.
Phone: +1-800-Anritsu (1-800-267-4878)

• **Canada**

Anritsu Electronics Ltd.

700 Silver Seven Road, Suite 120, Kanata,
Ontario K2V 1C3, Canada
Phone: +1-613-591-2003
Fax: +1-613-591-1006

• **Brazil**

Anritsu Elettronica Ltda.

Praça Amadeu Amaral, 27 - 1 Andar
01327-010 - Bela Vista - Sao Paulo - SP, Brazil
Phone: +55-11-3283-2511
Fax: +55-11-3288-6940

• **Mexico**

Anritsu Company, S.A. de C.V.

Bldv Miguel de Cervantes Saavedra #169 Piso 1, Col. Granada
Mexico, Ciudad de Mexico, 11520, MEXICO
Phone: +52-55-4169-7104

• **United Kingdom**

Anritsu EMEA Ltd.

200 Capability Green, Luton, Bedfordshire, LU1 3LU, U.K.
Phone: +44-1582-433200
Fax: +44-1582-731303

• **France**

Anritsu S.A.

12 avenue du Québec, Bâtiment Iris 1- Silic 612,
91140 VILLEBON SUR YVETTE, France
Phone: +33-1-60-92-15-50
Fax: +33-1-64-46-10-65

• **Germany**

Anritsu GmbH

Nemetschek Haus, Konrad-Zuse-Platz 1,
81829 München, Germany
Phone: +49-89-442308-0
Fax: +49-89-442308-55

• **Italy**

Anritsu S.r.l.

Via Elio Vittorini 129, 00144 Roma, Italy
Phone: +39-6-509-9711
Fax: +39-6-502-2425

• **Sweden**

Anritsu AB

Isafjordsgatan 32C, 164 40 KISTA, Sweden
Phone: +46-8-534-707-00

• **Finland**

Anritsu AB

Teknobulevardi 3-5, FI-01530 VANTAA, Finland
Phone: +358-20-741-8100
Fax: +358-20-741-8111

• **Denmark**

Anritsu A/S

c/o Regus Fairway, Arne Jacobsens Allé 7, 5th floor,
2300 Copenhagen S, Denmark
Phone: +45-7211-2200

• **Russia**

Anritsu EMEA Ltd.

Representation Office in Russia

Tverskaya str. 16/2, bld. 1, 7th floor.
Moscow, 125009, Russia
Phone: +7-495-363-1694
Fax: +7-495-935-8962

• **Spain**

Anritsu EMEA Ltd.

Representation Office in Spain

Paseo de la Castellana, 141. Planta 5, Edificio Cuzco IV
28046, Madrid, Spain
Phone: +34-91-572-6761

• **United Arab Emirates**

Anritsu EMEA Ltd.

Dubai Liaison Office

902, Aurora Tower, P O Box: 500311- Dubai Internet City
Dubai, United Arab Emirates
Phone: +971-4-3758479
Fax: +971-4-4249036

• **India**

Anritsu India Private Limited

6th Floor, Indiqube ETA, No.38/4, Adjacent to EMC2,
Doddanekundi, Outer Ring Road, Bengaluru – 560048, India
Phone: +91-80-6728-1300
Fax: +91-80-6728-1301

• **Singapore**

Anritsu Pte. Ltd.

11 Chang Charn Road, #04-01, Shriro House, Singapore 159640
Phone: +65-6282-2400
Fax: +65-6282-2533

• **Vietnam**

Anritsu Company Limited

Room No. 1635, 16th Floor, ICON 4 Tower, 243A De La Thanh Street,
Lang Thuong Ward, Dong Da District, Hanoi, Vietnam
Phone: +84-24-3760-6216
Fax: +84-24-6266-2608

• **P.R. China (Shanghai)**

Anritsu (China) Co., Ltd.

Room 2701-2705, Tower A, New Caohejing International
Business Center No. 391 Gui Ping Road Shanghai, 200233, P.R. China
Phone: +86-21-6237-0898
Fax: +86-21-6237-0899

• **P.R. China (Hong Kong)**

Anritsu Company Ltd.

Unit 1006-7, 10/F., Greenfield Tower, Concordia Plaza,
No. 1 Science Museum Road, Tsim Sha Tsui East,
Kowloon, Hong Kong, P.R. China
Phone: +852-2301-4980
Fax: +852-2301-3545

• **Japan**

Anritsu Corporation

8-5, Tamura-cho, Atsugi-shi, Kanagawa, 243-0016 Japan
Phone: +81-46-296-6509
Fax: +81-46-225-8352

• **Korea**

Anritsu Corporation, Ltd.

5FL, 235 Pangyoeyeok-ro, Bundang-gu, Seongnam-si,
Gyeonggi-do, 13494 Korea
Phone: +82-31-696-7750
Fax: +82-31-696-7751

• **Australia**

Anritsu Pty. Ltd.

Unit 20, 21-35 Ricketts Road, Mount Waverley, Victoria 3149, Australia
Phone: +61-3-9558-8177
Fax: +61-3-9558-8255

• **Taiwan**

Anritsu Company Inc.

7F, No. 316, Sec. 1, NeiHu Rd., Taipei 114, Taiwan
Phone: +886-2-8751-1816
Fax: +886-2-8751-1817