



**The never-ending evolution of power supplies!**



## **Ultra-Compact AC/DC Programmable Power Supply PCR-WEA/WEA2 Series**

Compact size: 6 kVA in 6U size (PCR6000WEA2)

Up to 36 kVA in one single unit

100% regenerative capability (for "R" models, PCR-WEA2R)

Mix-and-match parallel operation up to 144 kVA

Flexible digital interface: LAN (LXI), USB, RS232C, GPIB (factory option)

Power line disturbance simulation

Power-saving function

DC output (100% of rated power)

Output frequency up to 5 kHz

Output rating: AC 0 to 320 Vrms, DC 0 to  $\pm 452$  V

# THE EVOLUTION

More power, more speed, more freedom! While maintaining the high-power density of 6 kVA/6U and 36 kVA in a single housing unit, the maximum output voltage, response characteristics, and load stability have been improved!

## Ultra-Compact AC/DC Programmable Power Supply PCR-WEA/WEA2 Series

The PCR-WEA/WEA2 is a series of multifunctional switching AC power supplies that combines accurate, high-power output with an ultra-compact design. The 15 model line-up ranges from 1 kVA to 36 kVA AC/DC with single & 3-phase variable output from 6 kVA and up. The PCR-WEA2 also features a regenerative mode\*1 that can drastically reduce power consumption and cut operating costs. The PCR-WEA2/WEA2R also supports mix-and-match parallel operation\*2 up to 144 kVA for large-scale test systems. Output frequency up to 5 kHz is also available with all models, which is critical for AC applications in avionic industries.

- Compact size: 6 kVA in 6U frame (PCR6000WEA2)
- Up to 36 kVA in a single unit (PCR36000WEA2)
- 100% regenerative-power capability\*1
- Mix-and-match parallel operation up to 144 kVA
- Flexible digital interface:  
LAN (LXI), USB, RS232C, GPIB (option)
- Power line disturbance simulation features
- Sequence function for advanced simulation
- External analog, digital control function (standard)
- Power-saving function
- DC output (100% of rated power)
- Output frequency up to 5 kHz
- Output rating: AC 0 to 320 Vrms, DC 0 to  $\pm 452$  V
- Analog monitor output (factory option)\*3

\*1: Only "R" models (PCR-WEA2R) with 3-phase 200 V input. For regeneration within the installation site only.

\*2: Parallel operation is available for 6 kVA models and up, with a maximum of 4 units. Same model combination is not required.

\*3: 6 kVA models and higher



PCR1000WEA  
PCR2000WEA



PCR3000WEA2



PCR6000WEA2  
PCR6000WEA2R



PCR12000WEA2  
PCR12000WEA2R



PCR18000WEA2  
PCR18000WEA2R

**6U**  
approx. **262 mm**  
(10.32 inch)

**6 kVA**

**Max voltage increased to 320V**



PCR6000WEA2  
PCR6000WEA2R

Refer to pg.16 for full scale.

## ● Lineup

Specifications		AC mode output rating				DC mode output rating				Input rating (AC rms)		
Model	Phase	Power capacity	Phase voltage	Max. current *1 (L/H range)	Frequency	Power capacity	Voltage	Max. current *2 (L/H range)	Phase	Voltage (nominal)	Apparent power	Current
		VA	V	A	Hz	W	V	A		V	kVA or less	A or less
PCR1000WEA	Single-phase	1 k	(The spec guaranteed voltage range) 1 to 160/ 2 to 320 (L/H output range)  (Voltage setting range) 0 to 161.0/ 0 to 322.0	10/5	1 to 5000	1 k	(The spec guaranteed voltage range) ±1.4 to ±226/ ±2.8 to ±452 (L/H output range)  (Voltage setting range) -227.5 to +227.5/ -455.0 to +455.0	10/5	Single-phase	100 to 120, 200 to 240	1.4	17/8.5
PCR2000WEA	Single-phase	2 k		20/10		2 k		20/10	Single-phase	100 to 120, 200 to 240	2.7	32/16
PCR3000WEA2	Single-phase	3 k		30/15		3 k		30/15	Single-phase	100 to 120, 200 to 240	4	48/24
	Three-phase Single-phase Three-wire			10/5								
PCR6000WEA2R	Single-phase	6 k		60/30		6 k		60/30	Three-phase Three-wire	Line voltage 200 to 240	7.8	27
PCR6000WEA2	Three-phase Single-phase Three-wire	4 k		20/10				120/60	Three-phase Four-wire	Line voltage 380 to 480		14
PCR12000WEA2R	Single-phase	12 k		120/60		12 k		120/60	Three-phase Three-wire	Line voltage 200 to 240	15.6	53
PCR12000WEA2	Three-phase Single-phase Three-wire			8 k				40/20	Three-phase Four-wire	Line voltage 380 to 480		28
PCR18000WEA2R	Single-phase	18 k		180/90		18 k		180/90	Three-phase Three-wire	Line voltage 200 to 240	23.4	80
PCR18000WEA2	Three-phase Single-phase Three-wire			12 k				60/30	Three-phase Four-wire	Line voltage 380 to 480		42
PCR24000WEA2R	Single-phase	24 k		240/120		24 k		240/120	Three-phase Three-wire	Line voltage 200 to 240	31.2	106
PCR24000WEA2	Three-phase Single-phase Three-wire			16 k				80/40	Three-phase Four-wire	Line voltage 380 to 480		56
PCR30000WEA2R	Single-phase	30 k		300/150		30 k		300/150	Three-phase Three-wire	Line voltage 200 to 240	39	133
PCR30000WEA2	Three-phase Single-phase Three-wire			20 k				100/50	Three-phase Four-wire	Line voltage 380 to 480		70
PCR36000WEA2R	Single-phase	36 k		360/180		36 k		360/180	Three-phase Three-wire	Line voltage 200 to 240	46.8	159
PCR36000WEA2	Three-phase Single-phase Three-wire			24 k				120/60	Three-phase Four-wire	Line voltage 380 to 480		84

\*1 When the output phase voltage is between 100 Vac and 160 Vac or 200 Vac and 320 Vac, the output current is reduced by the output voltage. When the output frequency is between 1 Hz and 40 Hz, the output current is reduced by the output frequency.

\*2 When the output voltage is between 100 Vac and 226 Vac or 200 Vac and 452 Vac, the output current is reduced by the output voltage.

★ 500 Hz Limit Model is available. The PCR-WEA2 Series offers a limited frequency type with a maximum output frequency of 500 Hz.

## ● Dimensions/Weight

Model	Dimensions(mm(inch))(Maximum size)	Weight
PCR1000WEA	430(16.9")W×129.2(5.1")×150(5.9")H×674(26.5")×735(28.9")Dmm	18 kg(39.7 lb)
PCR2000WEA	430(16.9")W×129.2(5.1")×150(5.9")H×674(26.5")×735(28.9")Dmm	21 kg(46.3 lb)
PCR3000WEA2	430(16.9")W×129.2(5.1")×150(5.9")H×674(26.5")×735(28.9")Dmm	25 kg(55.1 lb)
PCR6000WEA2R	430(16.9")W×262(10.3")×345(13.6")H×563(22.2")×635(25.0")Dmm	43 kg(94.8 lb)
PCR6000WEA2	430(16.9")W×262(10.3")×345(13.6")H×563(22.2")×635(25.0")Dmm	43 kg(94.8 lb)
PCR12000WEA2R	430(16.9")W×389(15.3")×475(18.7")H×563(22.2")×635(25.0")Dmm	67 kg(147.7 lb)
PCR12000WEA2	430(16.9")W×389(15.3")×475(18.7")H×563(22.2")×635(25.0")Dmm	66 kg(145.5 lb)
PCR18000WEA2R	430(16.9")W×690(27.2")×785(30.9")H×563(22.2")×670(26.4")Dmm	120 kg(264.6 lb)
PCR18000WEA2	430(16.9")W×690(27.2")×785(30.9")H×563(22.2")×670(26.4")Dmm	120 kg(264.6 lb)

Model	Dimensions(mm(inch))(Maximum size)	Weight
PCR24000WEA2R	430(16.9")W×445(17.5")×690(27.2")×785(30.9")H×563(22.2")×670(26.4")Dmm	130 kg(286.6 lb)
PCR24000WEA2	430(16.9")W×445(17.5")×690(27.2")×785(30.9")H×563(22.2")×670(26.4")Dmm	130 kg(286.6 lb)
PCR30000WEA2R	430(16.9")W×445(17.5")×944(37.2")×1040(40.9")H×563(22.2")×670(26.4")Dmm	160 kg(352.7 lb)
PCR30000WEA2	430(16.9")W×445(17.5")×944(37.2")×1040(40.9")H×563(22.2")×670(26.4")Dmm	160 kg(352.7 lb)
PCR36000WEA2R	430(16.9")W×445(17.5")×944(37.2")×1040(40.9")H×563(22.2")×670(26.4")Dmm	180 kg(396.8 lb)
PCR36000WEA2	430(16.9")W×445(17.5")×944(37.2")×1040(40.9")H×563(22.2")×670(26.4")Dmm	180 kg(396.8 lb)

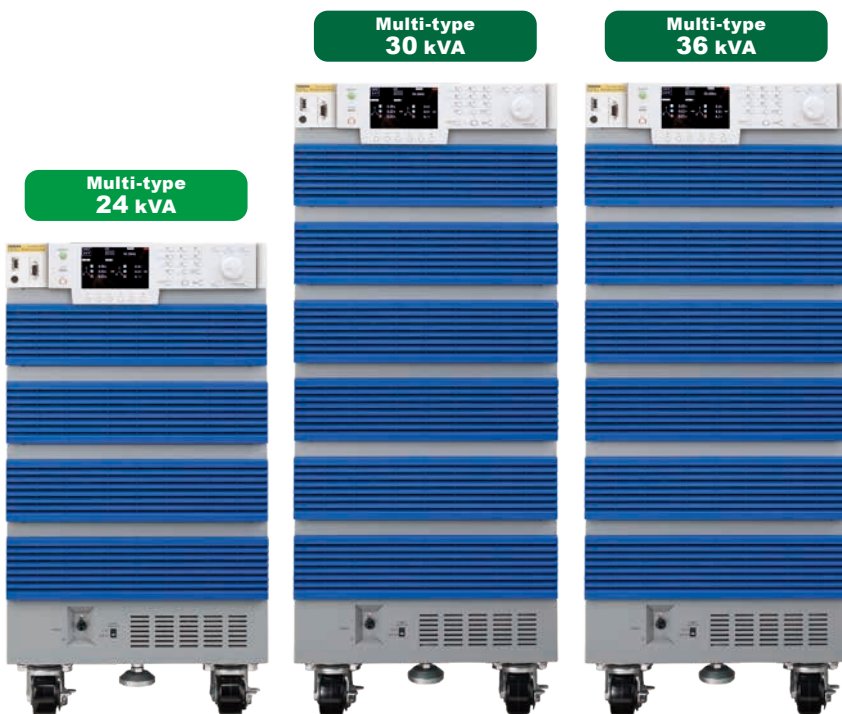

PCR24000WEA2  
PCR24000WEA2R

PCR30000WEA2  
PCR30000WEA2R

PCR36000WEA2  
PCR36000WEA2R

Features

p4-p5

Performance

p6

Applications

p7

Exterior Design

p10-p11

Specifications

p12-p15

Option/Cable

p8-p9, p18-p19

# PWM Inverter Type - Programmable AC Power Supply

The PCR-WEA/WEA2 Series brings new innovations to the power-electronics industry.

## Compact Size!

Compared to our previous PWM models, the size of the PCR-WEA has been drastically reduced by 60%. Efficiency has also been increased by approximately 7%, for an overall high efficiency of approximately 85%.

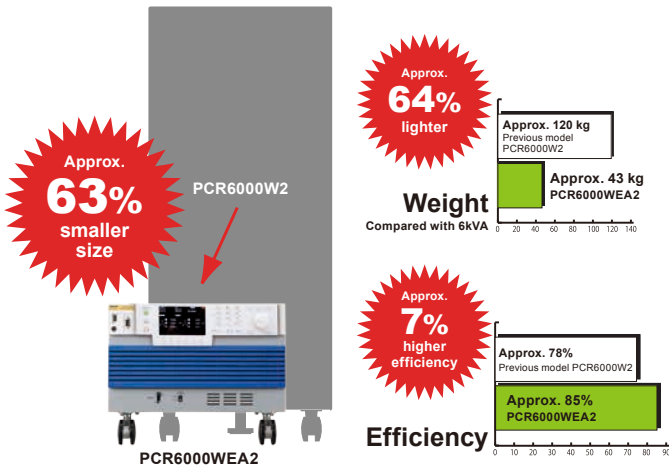

## Extremely Power Dense 36 kVA Chassis

The PCR-WEA/WEA2 form factor has been significantly improved, occupying the absolute minimum amount of precious space in your testing facility. The form factor is even further optimized in high power models.

### ● Installation area comparison (36 kVA)

The PCR-WEA/WEA2 is only 1/6th the size of the PCR-LE!

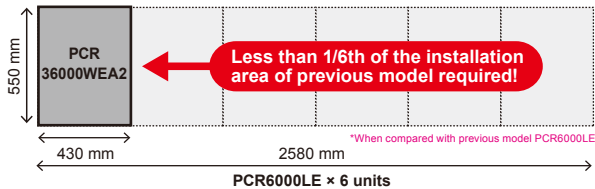

### ● Weight comparison (36 kVA)

The PCR-WEA/WEA2 is approximately 80% lighter than the PCR-LE!



## Low Ripple Noise

Achieves an extremely low switching noise for a PWM inverter-type AC power supply, with ripple noise as low as 0.25 Vrms. The PCR-WEA series even boasts similar noise performance with the PCR-LE/LE2 linear amplifier power supply series. The compact, high-power design of the PCR-WEA/WEA2 has been achieved with absolutely no compromises to ripple noise performance.

## 100% Regeneration Capability, No Time Limit

The PCR-WEA2R models are capable of 100% power regeneration. The power regeneration feature is available with absolutely no reverse load flow time limit. (30% for PCR-LE/LE2)

*\*Regeneration is limited within installation site. Only available in "R" models (PCR-WEA2R) with 3-phase 200 V input.*

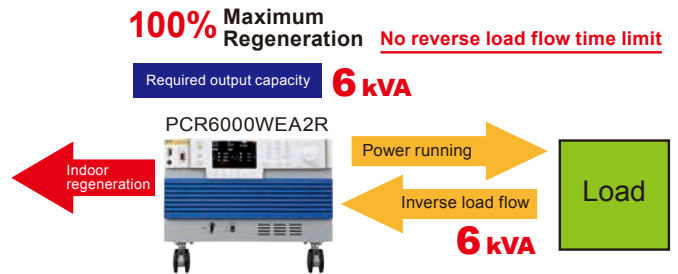

## LAN, USB, RS232C Standard Digital Interface

The PCR-WEA/WEA2 series includes a flexible digital interface for users utilizing LAN, USB, and RS232C communication interfaces (GPIB factory option available). LAN connection is LXI compliant, allowing you to monitor and control your device wherever you are via computer, smartphone, or tablet web browser. This feature is particularly important when conducting critical AC tests in anechoic chambers/shield rooms. Additionally, the PCR-WEA can be controlled directly with easy remote-control software for customers with limitations in external communication.

### ● Wired LAN connection (optical cable)

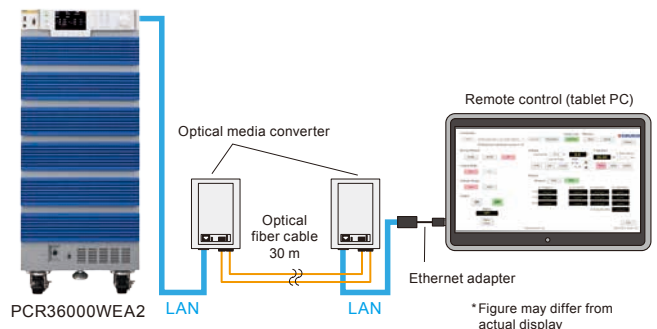

### ● Wireless LAN connection

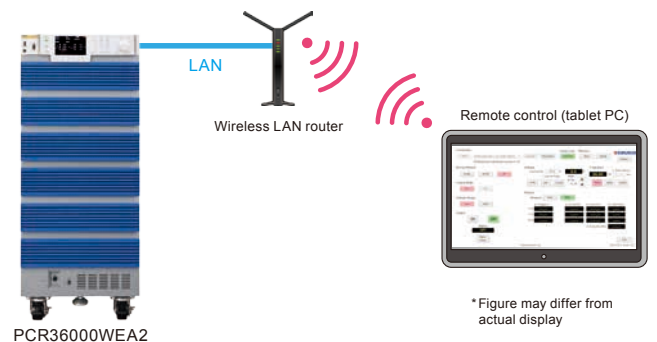

## Output Frequency up to 5 kHz

It has a maximum output frequency up to 5 kHz for critical applications in the defense and avionics industries. The frequency performance of the PCR-WEA allows for simulation of sharp voltage fluctuations required for airborne electronic equipment testing. Furthermore, the compact 6kVA/6U form factor allows for the easy preparation of an automated, one-rack testing system without requiring a costly, specialized power source installation space.



## Up to 144 kVA with Parallel Operation

Parallel operation is available on all models by simply connecting an optional parallel operation cable. This feature is available even among different models for a wide range of high power.

\*Same input voltage required for 6 kVA models and higher.



### ● Mix-and-match parallel operation (example)

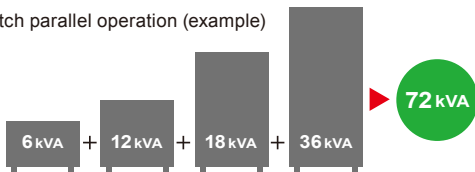

### ● Connection diagram

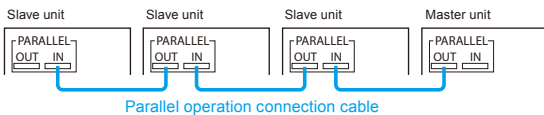

## Analog Monitor Output (Factory option)

Instantaneous voltage / current values can be output as voltage waveforms without using a differential probe or current sensor.

It is also possible to output the instantaneous value of the power value.

\*6 kVA models and higher

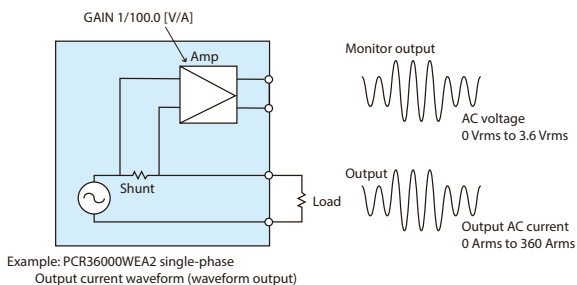

## DC Output 100% of Rated Power

The PCR-WEA/WEA2 series enables DC output up to 100% of the AC rated power output.

### DC output: 100% of AC output rating

Required output capacity **6 kVA**



## Power Saving Mode \*6 kVA models and higher

### ● Sleep mode

If the PCR-WEA/WEA2 does not detect output for a certain amount of time, the power unit will go into "sleep mode" and cut power consumption.

ZZZ.....  
Sleep mode screen is displayed.



### ● Power-saving mode

The power-saving feature allows the PCR-WEA to cut the costs of operation by drawing power from only the necessary power modules required to reach the output setting.

[Example]  
Only 6 kVA drawn from the 36 kVA model

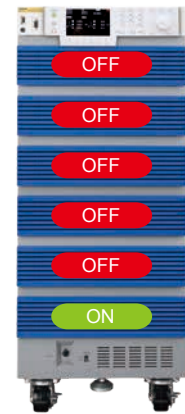

## Modular design allows for simple maintenance

Each separate power module can be removed and replaced for maintenance and calibration. \*For models 6 kVA and higher

## Power Line Error Simulation

The PCR-WEA/WEA2 series can simulate various power line abnormalities such as power outages, voltage drops (dips) and voltage increases (pops). This feature is useful for the testing of power-source switches and various electronic devices.

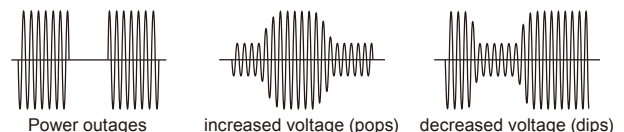

## Built-in parallel operation driver software! Easy parallel operation with a single connection cable.

The PCR-WEA/WEA2 series can be easily configured in a parallel connection with a single cable\* per connection for all models 6 kVA and above. This cable can be used in synchronization with a power-interlock cable\* to control the ON/OFF status of master/slave units. \*Optional

### Performance

#### ●Example of the combined system using same models

Capacity	Model	Qty	Parallel operation cable	Qty	Power-sync cable	Qty
12 kVA	PCR6000WEA2	2	PC01-PCR-WE	1	LC01-PCR-LE	1
48 kVA	PCR24000WEA2R	2	PC01-PCR-WE	1	LC01-PCR-LE	1
90 kVA	PCR30000WEA2R	3	PC01-PCR-WE	2	LC01-PCR-LE	2
144 kVA	PCR36000WEA2R	4	PC01-PCR-WE	3	LC01-PCR-LE	3

[PCR36000WEA2R 4 units, example of 144 kVA]

The figure below is a conceptual diagram. Power wiring etc. are also required for system build up. Please consult your local Kikusui distributor.

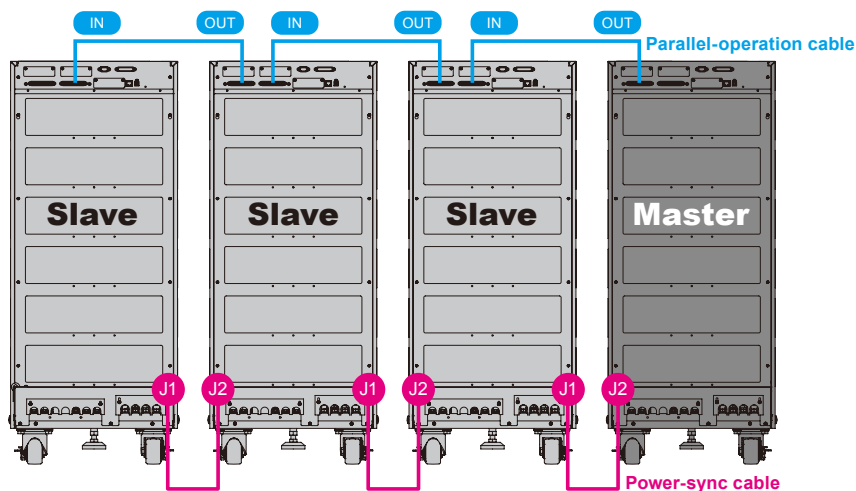

#### ●Example of the combined system using different models

Capacity	Model	Part	Qty
60 kVA Parallel-operation system	PCR6000WEA2R	AC/DC Power supplies (6 kVA)	1
	PCR12000WEA2R	AC/DC Power supplies (12 kVA)	1
	PCR18000WEA2R	AC/DC Power supplies (18 kVA)	1
	PCR24000WEA2R	AC/DC Power supplies (24 kVA)	1
	PC01-PCR-WE	Parallel operation cable	3
	LC01-PCR-LE	Power-sync cable	3

The figure below is a conceptual diagram. Power wiring etc. are also required for system build up. Please consult your local Kikusui distributor.

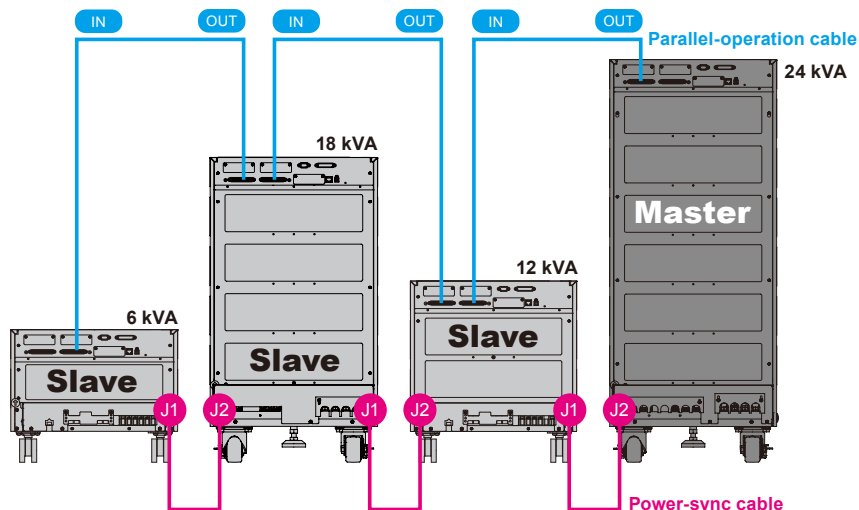

# Applications

## For Standard Compliance Testing

### ● Single-phase system

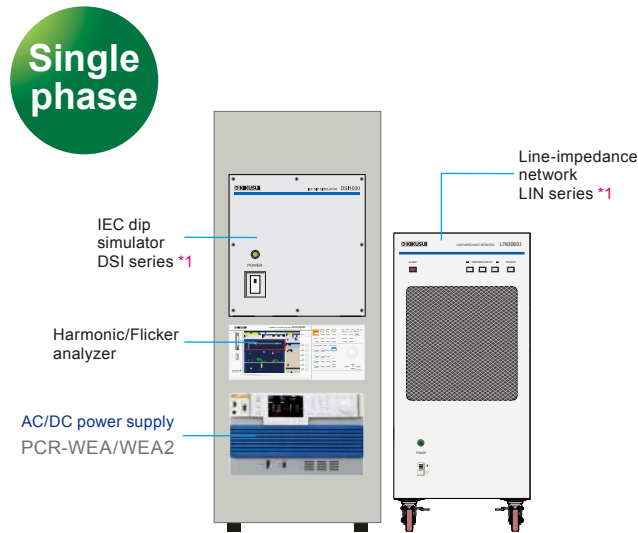

### ● Three-phase system

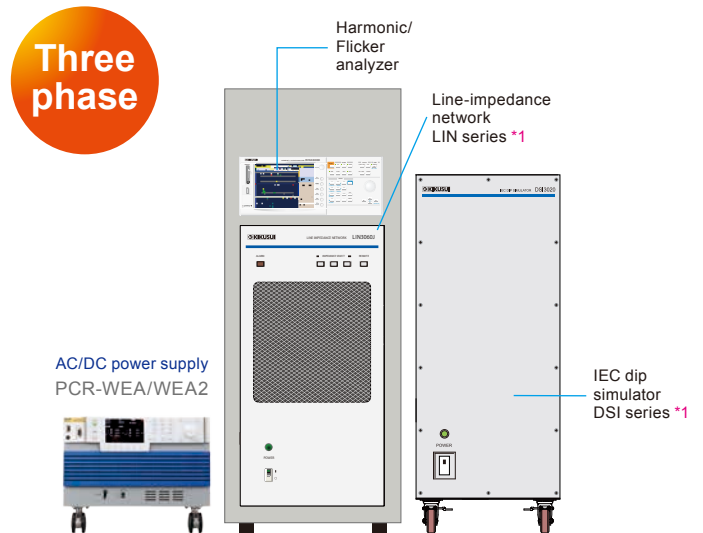

This system can simulate various conditions of phenomena occurring in AC power environments. It can be used for immunity tests of electrical and electronic devices, which are connected to a low-voltage distribution system, or which have DC power input ports, under the standard conditions as specified to the right. The test conditions can be set outside the standard range, allowing the system to be used for preliminary tests prior to standard tests, immunity-margin tests, and stress tests. The KHA3000 harmonic/flicker analyzer combines a PCR-WEA/WEA2 Series AC power supply, LIN Series line- impedance network\*1, DSI series IEC dip simulator\*2 and application software(Refer to pg.8), allowing tests that conform to IEC standards and JIS standards.

\*1 Specially made to order

IEC61000-4-11	Voltage dipping, instantaneous power failure and voltage variation
IEC61000-4-13	Higher harmonics wave/interharmonic wave
IEC61000-4-14	Voltage swing
IEC61000-4-27	Unbalance in units
IEC61000-4-28	Variation in power-supply frequency for units with 16 A/phase
IEC61000-4-34	Voltage drop(dip), instantaneous power failure and voltage variation for units with input current exceeding 16 A/phase
IEC61000-4-17	Ripple at the DC input power terminal
IEC61000-4-29	Voltage drop(dip), instantaneous power failure and voltage variation in DC *2
IEC61000-3-2,12	Harmonic electric current limit level
IEC61000-3-3,11	Voltage fluctuation, Flicker limit level

\*2 Designed for preliminary test purposes.

## For Testing of the EV Charging System

### ● EV charging system (item under test)

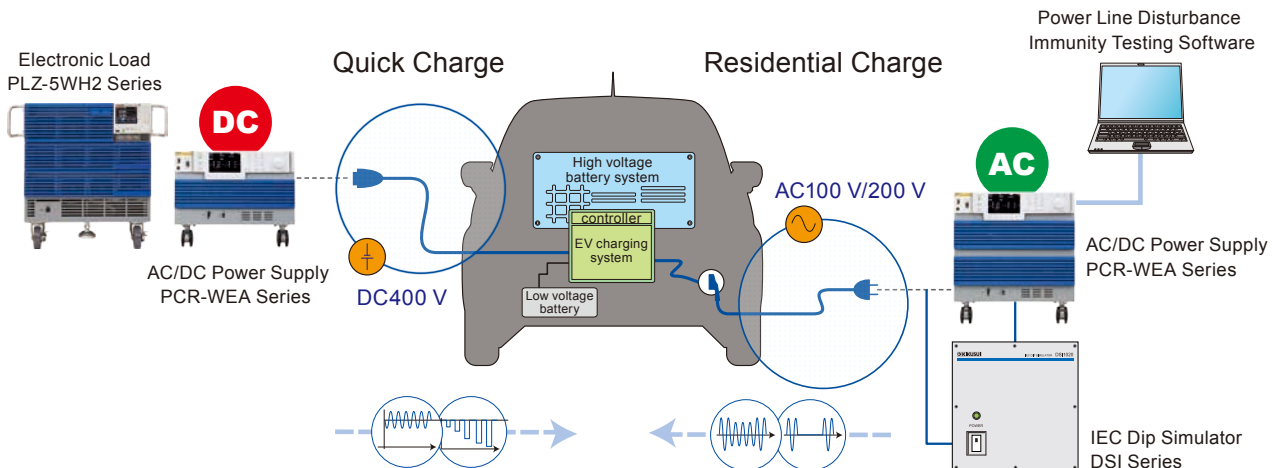

# Simple, user-friendly application software for various standard testing!



Power Line Disturbance Immunity Testing Software

## SD009-PCR-LE/WE (Quick Immunity Sequencer 2)

### List of conformance to the EMC standard tests

✓ : Conforming as standard    ▲ : Partially non-conforming    - : Function not available

Standard	Item	Conforming	
		Single-phase	Three-phase
<b>IEC61000-4-11</b> Voltage dipping, instantaneous power failure and voltage variation	Voltage drop (dip)	✓*1	✓*1
	Instantaneous power failure	✓*1	✓*1
	Voltage variation	✓	✓
	Flat curve	✓	✓
<b>IEC61000-4-13</b> Higher harmonics wave/interharmonic wave	Over swing	✓	✓
	Frequency sweep	✓	✓
	Odd harmonics the order of which is not a multiple of 3	✓	✓
	Odd harmonics the order of which is a multiple of 3	✓	✓
	Even harmonics	✓	✓
<b>IEC61000-4-14</b> Voltage swing	Interharmonics	✓	✓
	Meister curve	✓	✓
	Single-phase rectifier circuit	✓	✓
<b>IEC61000-4-17</b> Ripple at the DC input power terminal	Three-phase rectifier circuit	✓	✓
	Interval	✓	✓
<b>IEC61000-4-27</b> Unbalance in units	Unbalance	-	▲*2
<b>IEC61000-4-28</b> Variation in power supply frequency for units with 16 A/phase	Frequency variation	✓	✓
<b>IEC61000-4-29</b> Voltage drop (dip), instantaneous power failure and voltage variation in DC	Voltage drop (dip)	✓	-
	Instantaneous power failure	▲*3	-
	Voltage variation	✓	-
<b>IEC61000-4-34</b> Voltage drop (dip), instantaneous power failure and voltage variation for units with input current exceeding 16 A/phase	Voltage drop (dip)	▲*4	▲*4
	Instantaneous power failure	▲*4	▲*4
	Voltage variation	✓	✓

\* Immunity testing for units with 16 A/phase except for those required by IEC61000-4-34

\*1 Conforms to the standard when used in combination with IEC Dip Simulator DSI series. If using the PCR-WEA/WEA2 alone, the voltage dips and short-time power failures are preliminary tests.

\*2 110 %, 95.2 %, 93.5 %, 90 %, 87 %, 80 %, 74 %, 71 %, 66 % need to respond to sudden changes of 1 μs to 5 μs. The voltage response of PCR-WEA/WEA2 is more than 40 μs at FAST, which is a preliminary test.

\*3 Must support output impedance greater than 100 kΩ. The PCR-WEA/WEA2 output impedance is less than 100 kΩ and therefore designed for preliminary testing purposes.

\*4 The device between the range of 16A to 75 A requires having the capability of rapid change with 1 μs to 5 μs. The device exceeding 75 A is not required to have the capability of rapid change with 1μs to 5 μs. (It is relaxed to 1 μs to 50 μs for the device exceeding 75 A.)

### The latest standards for IEC61000-4 supported!

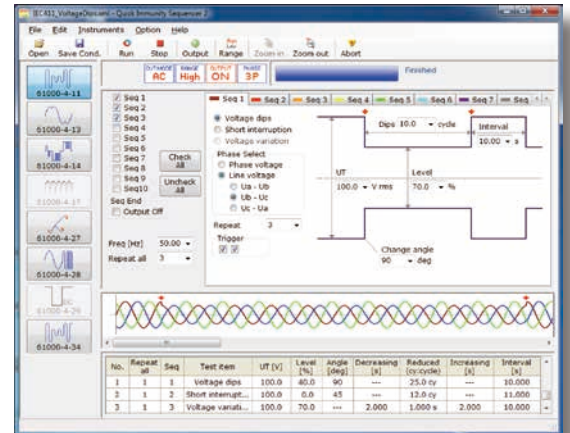

"Quick Immunity Sequencer 2" (model name: SD009-PCR-LE/WE) is an application software for immunity testing with the AC power supply PCR-WEA/WEA2 series system, based on the power line disturbance standard (IEC61000-4 Series) for the immunity testing of the EMC standard. Not only can it be used for compliance testing based on the latest standards or for some types of preliminary testing, but the software can be also employed for advance checking in development phases and for immunity margin tests, because it allows extended testing conditions to be set as needed.



Avionics Test Software

## SD012-PCR-LE/WE

Supporting compliance testing of avionics test standards.

The test pattern can be conducted from the library.

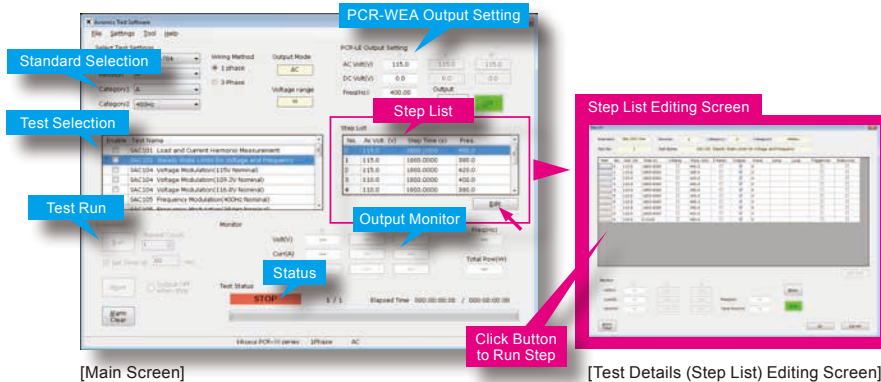

- Easy configuration - just select standard from library
- Test-step editing and saving - convenient for development and evaluation required with marginal testing
- Test-condition reporting function - enables test history logging
- Remote control via LAN

### Supported Standards

- Military Standard: MIL-STD-704A/E/F
- Civilian Standard: RTCA DO-160F/G
- Civilian Standard: JIS W0812:2004

Test standards have been established that electrical components and parts installed on aircraft must meet. All electrical components and parts installed on the fuselage must comply with these standards, but the applicable test standards vary according to the intended use and purpose. Test standards can be largely divided into two types: military standards and civilian standards. In addition, aircraft manufacturers sometimes apply their own set of private standards. Avionics Test Software [SD012-PCR-LE/WE] is a software application that supports aircraft test standards, and is used to control the PCR-WEA/WEA2 Series that enables you to conduct the test standards for the MIL-STD-704, RTCA/DO-160 and JIS W0812 standards. Test patterns are library-based, which enables tests to be easily run by simply selecting the wiring configuration and the type of test. In general, the 400 Hz AC power supply is used for large aircrafts, and the 28 V DC power supply is used for the small aircrafts.





"Wavy" sequence creation software

# SD032-PCR-WE ( Wavy for PCR-WE )

The software extends the feature of waveform generation and sequence functions.

Easy sequence control without programming knowledge!

**Trial version available on website!**  
<http://www.kikusui.co.jp/en/download/index.html>  
**Download!**

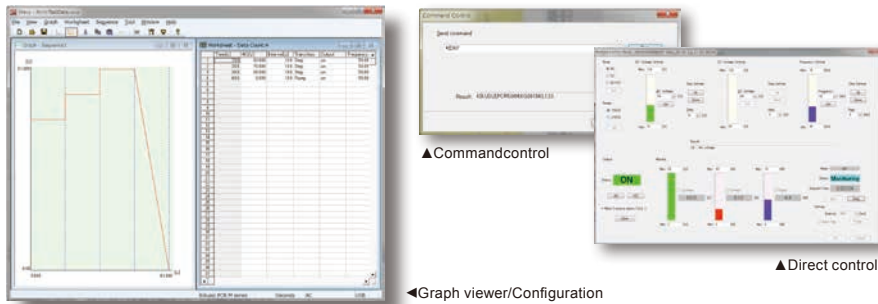

Wavy is an application software that supports sequence creation and the operation for Kikusui power supplies and electronic loads. Wavy allows you to create and edit sequences visually with a mouse without programming knowledge.

- Makes it easier to create or edit the test-condition file required for the sequence operation.
- By using the storage function of test-condition data file, it enables you to manage the test condition of the standard routine test.
- The progress of execution sequence will be displayed in "practical dialogue" with the setting value and the cursor.
- It is possible to observe the intuitionistic output through the "monitor graph" that plots the ongoing monitor value.
- You can save the acquired monitor data as a test result.
- Added "waveform image" window let's you easily keep track of the AC signal.
- Allows you to edit and create a new arbitrary waveform easily. You can instantly write and then output the created arbitrary waveform.
- You can select or deselect the pause function, trigger function, AC waveform etc. as necessary.



Remote-control software for Windows tablet

# SD021-PCR-LE/WE ( RMT CONT SOFTWARE FOR PCR-LE/WE )

**Windows tablet can be used as a remote controller !**

The SD021-PCR-LE/WE is software that can control the PCR-WEA/WEA2 Series. It is capable of changing the setting condition of the "wiring method", "output mode", "voltage range", "voltage value", and "frequency value". And the settings changed by remote control can be saved and recalled. Moreover, it can display the measurement value of the AC power supply. Remote operation and control of the AC power supply can be easily achieved from a distance.

- Operating environment : Intel Core 2 or later / Windows 8.1 / Memory 4 GB / Storage 128 GB / Display resolution 133 x 768 or higher / USB port

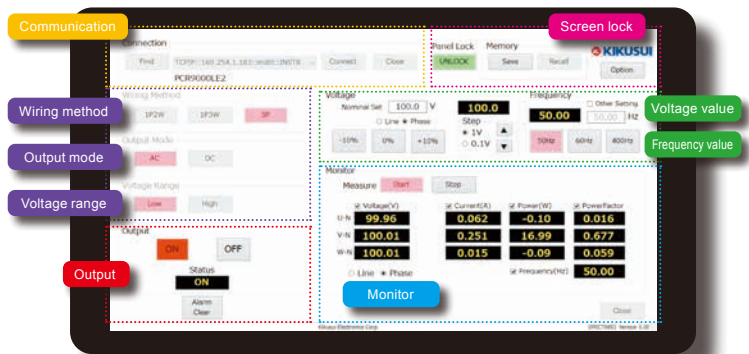

Screen display (main screen)

# Exterior Design

## Front Panel

### PCR1000WEA/2000WEA/3000WEA2

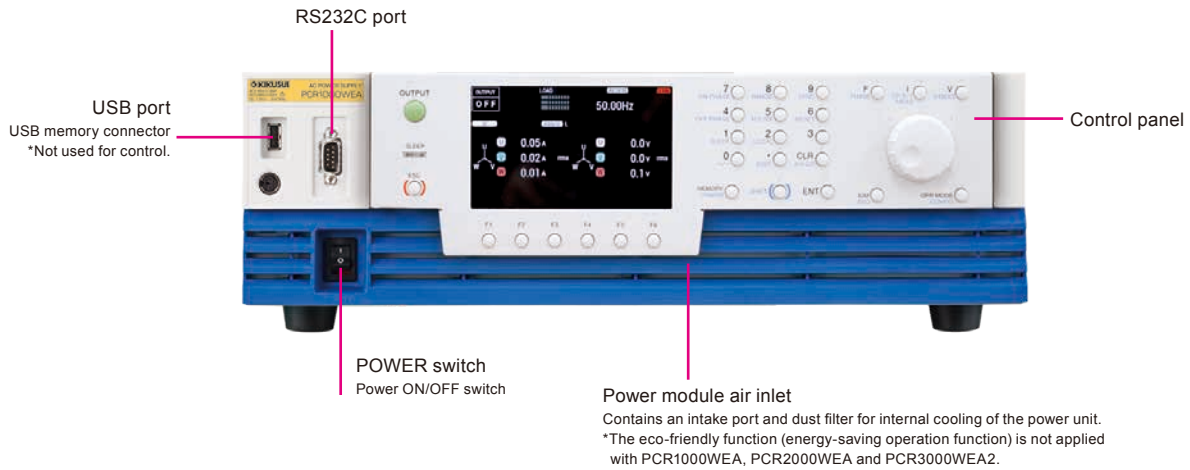

### PCR12000WEA2

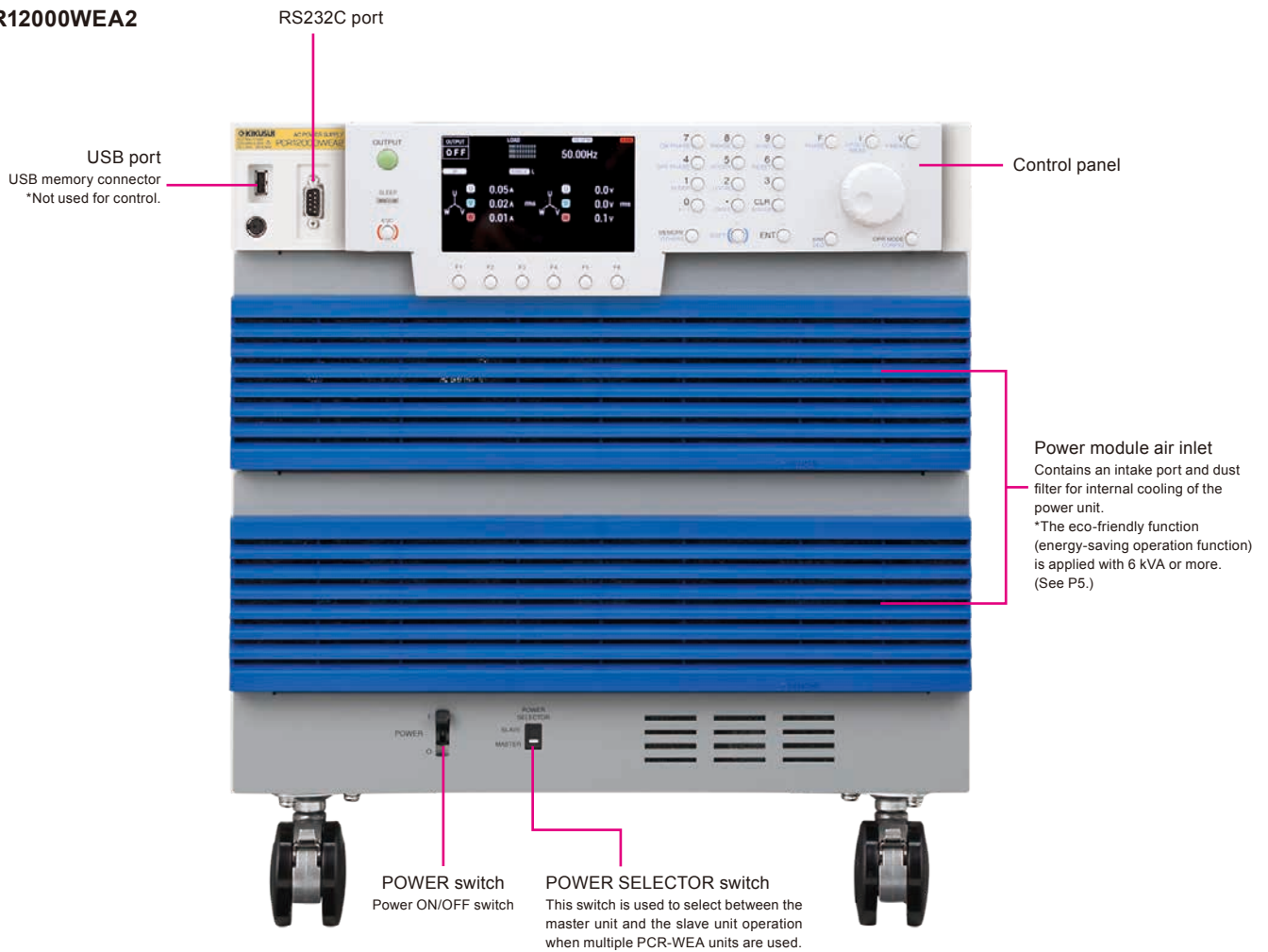

## Rear Panel

● **PCR1000WEA/2000WEA/3000WEA2** \*The photo shows the PCR3000WEA2. Covers have been removed for photographic purposes.

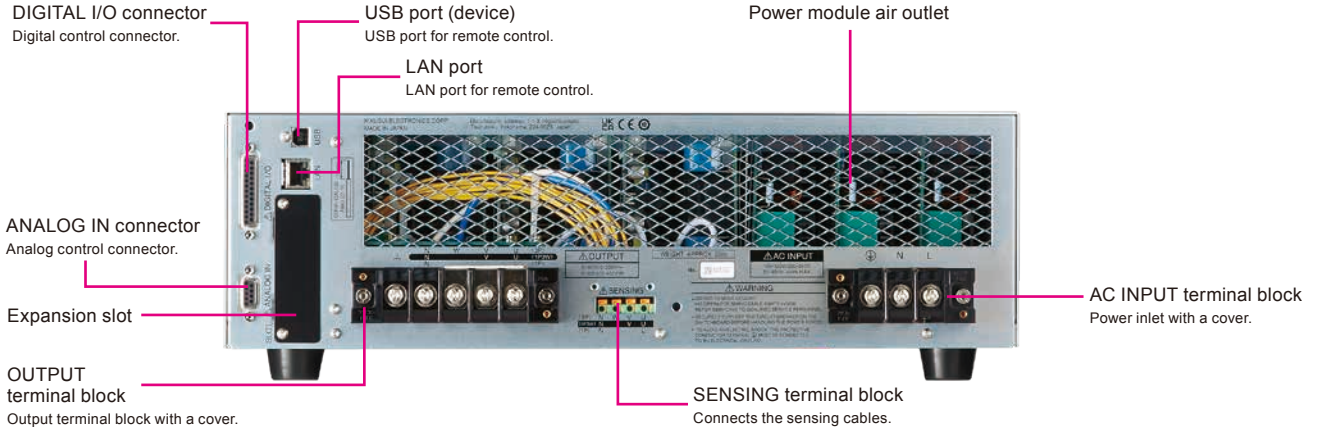

● **PCR6000WEA2R**

\*Covers have been removed for photographic purposes.

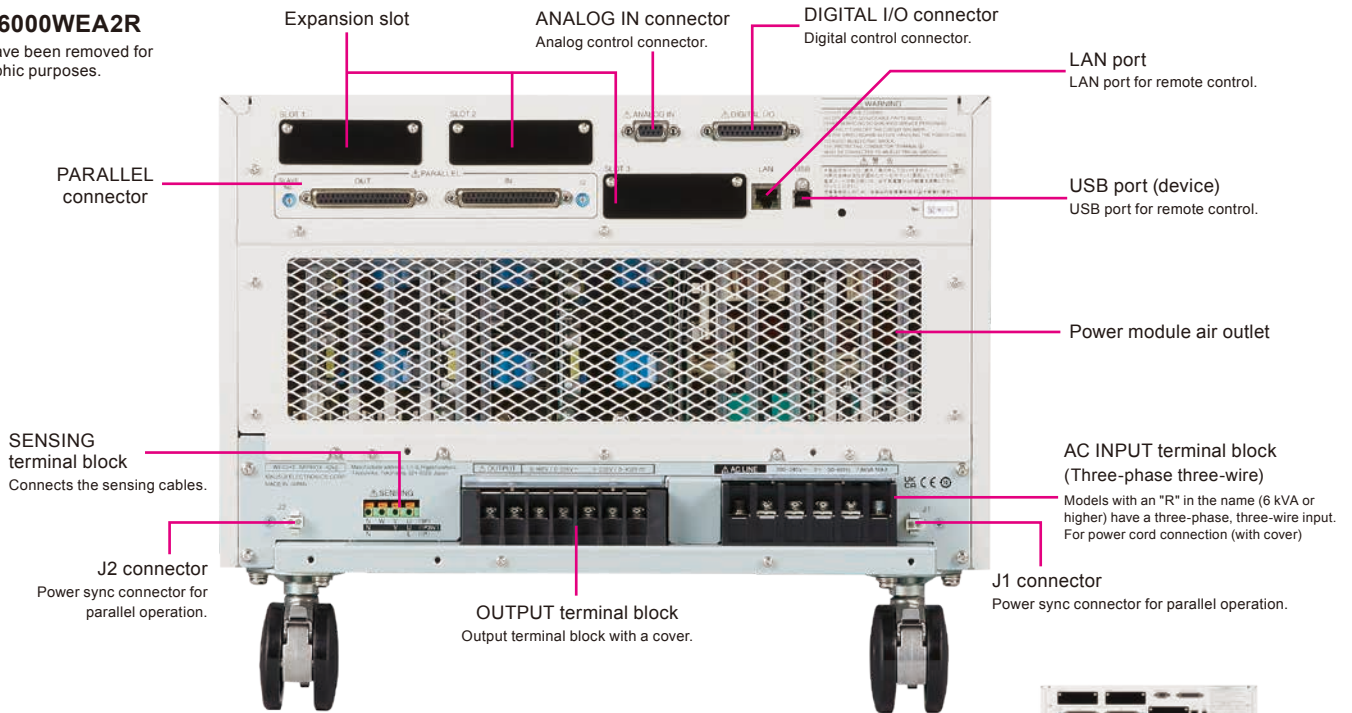

● **400 V input model (Three-phase four-wire input)**

Models of 6 kVA or more without an "R" in the name have three-phase 4-wire input.

\*The photo shows the PCR36000WEA2. Covers have been removed for photographic purposes.

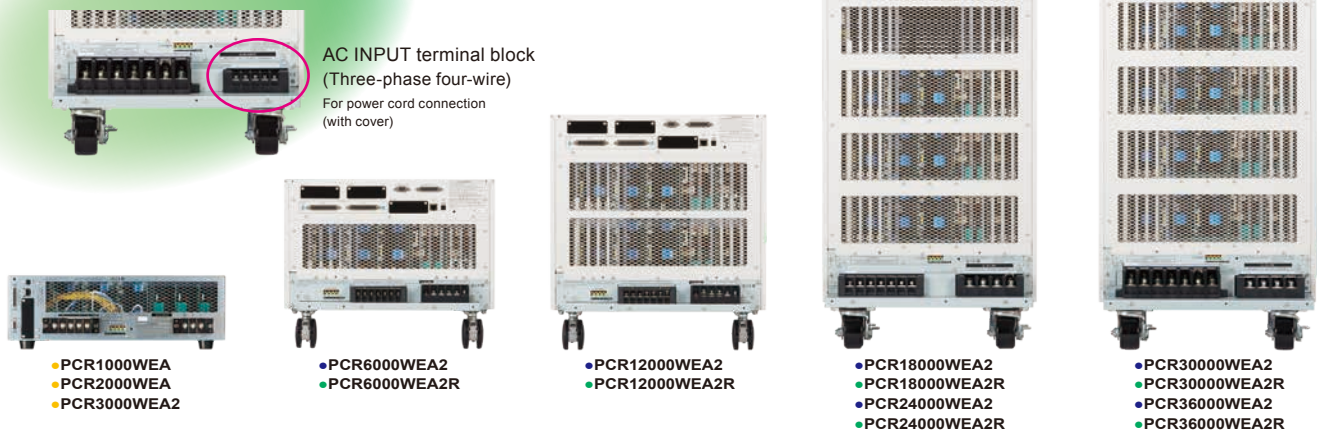

## Specifications

Unless specified otherwise, the specifications are for the following settings and conditions.

- The warm-up time is 30 minutes (with current flowing). • TYP: These are typical values that are representative of situations where the product operates in an environment with an ambient temperature of 23°C. These values do not guarantee the performance of the PCR-WEA/WEA2.
- setting: Indicates a setting. • reading: Indicates the readout value. • f.s: Indicates full scale.

## Input (AC rms)

Model		Single-phase output			Single-phase/three-phase switchable model					
		PCR 1000WEA	PCR 2000WEA	PCR 3000WEA2	PCR 6000WEA2	PCR 12000WEA2	PCR 18000WEA2	PCR 24000WEA2	PCR 30000WEA2	PCR 36000WEA2
Nominal input voltage	1P2W input model	100 Vac to 120 Vac / 200 Vac to 240 Vac *1			—					
	3P3W input model	—			200 Vac to 240 Vac (3 phase line voltage) *2					
	3P4W input model	—			380 Vac to 480 Vac (3 phase line voltage) *3					
Phase		Single-phase			Three-phase					
Nominal input Frequency					50 Hz to 60 Hz					
Input frequency range					45 Hz to 65 Hz					
Apparent power		1.4 kVA and less	2.7 kVA and less	4 kVA and less	7.8 kVA and less	15.6 kVA and less	23.4 kVA and less	31.2 kVA and less	39 kVA and less	46.8 kVA and less
Power factor *4		0.95(TYP)			0.97(TYP) 3P3W input model / 0.95(TYP) 3P4W input model					
Maximum current	1P2W input model *1	17 A / 8.5 A	32 A / 16 A	48 A / 24 A	—					
	3P3W input model	—			27 A	53 A	80 A	106 A	133 A	159 A
	3P4W input model	—			14 A	28 A	42 A	56 A	70 A	84 A
Hold-up time for power interruption*4					10 ms					

\*1 100 V/200 V input system (auto select) \*2 Models with an "R" in the name (6 kVA or higher) have a three-phase, three-wire input. \*3 Models of 6 kVA or more without an "R" in the name have three-phase 4-wire input. \*4 At output voltage 100 V/200 V, rated output current, sine wave, load power factor 1, output frequency 40 Hz to 1 kHz

## Output

Model		Single-phase output			Single-phase/three-phase switchable model					
		PCR 1000WEA	PCR 2000WEA	PCR 3000WEA2	PCR 6000WEA2	PCR 12000WEA2	PCR 18000WEA2	PCR 24000WEA2	PCR 30000WEA2	PCR 36000WEA2
Maximum peak current *11					4 times the maximum output current					
Inrush current capacity *3		3 times the rated current (0.07 s) *12 1.4 times the rated current (0.5 s)			1.4 times the rated current (0.5 s)					
Efficiency *10		82 %(TYP)			85 %(TYP)					
AC voltage										
AC voltage *1	Rating	160 V / 320 V *2								
	Setting range	0 V to 161.0 V, 0 V to 322.0 V								
	Setting resolution	0.1 V								
	Setting accuracy (phase voltage) *3 *4	±(0.3 % of setting + 0.3 V), ±(0.3 % of setting + 0.6 V)								
	Setting accuracy (Line voltage) *3 *4	±(0.3 % of setting + 0.3 V), ±(0.3 % of setting + 0.6 V) *5								
Maximum current *1 *6	Single-phase output	10 A / 5 A	20 A / 10 A	30 A / 15 A	60 A / 30 A	120 A / 60 A	180 A / 90 A	240 A / 120 A	300 A / 150 A	360 A / 180 A
	Single-phase three-wire output, Three-phase output	—		10 A / 5 A	20 A / 10 A	40 A / 20 A	60 A / 30 A	80 A / 40 A	100 A / 50 A	120 A / 60 A
Phase		1P			1P2W, 1P3W, 3P4W switchable					
Power capacity	Single-phase output	1 kVA	2 kVA	3 kVA	6 kVA	12 kVA	18 kVA	24 kVA	30 kVA	36 kVA
	Three-phase output	—			2 kVA	4 kVA	8 kVA	12 kVA	16 kVA	20 kVA
	Single-phase three-wire output	—			2 kVA	4 kVA	8 kVA	12 kVA	16 kVA	20 kVA
Load power factor		0 to 1 (leading or lagging)								
Frequency	Setting range	1 Hz to 5 kHz *7 (5 kHz -3dB, <40 Hz derating required)								
	Resolution	0.01 Hz(1.00 Hz to 100.0 Hz), 0.1 Hz(100.0 Hz to 1000 Hz), 1 Hz(1000 Hz to 5000 Hz)								
	Accuracy *3	±0.01 %, Temperature coefficient : ±0.005 %/°C								
Phase	Resolution	—			0.01*13, 0.1° (1 Hz to 500 Hz), 1° (500 Hz to 4 kHz), 2° (4 kHz or more)					
	Accuracy *3	—			Within ±(0.4° + fo×0.9°) *8 fo: frequency [kHz]					
DC voltage										
DC voltage	Rating *1	-226 V to +226 V, -452 V to +452 V *2								
	Setting range *1	-227.5 V to +227.5 V, -455.0 V to +455.0 V								
	Resolution	0.1 V								
	Accuracy *9	±(0.05 % of setting +0.1 V)								
Maximum current *6		10 A / 5 A	20 A / 10 A	30 A / 15 A	60 A / 30 A	120 A / 60 A	180 A / 90 A	240 A / 120 A	300 A / 150 A	360 A / 180 A
Power capacity		1 kW	2 kW	3 kW	6 kW	12 kW	18 kW	24 kW	30 kW	36 kW

\*1 output L range, output H range

\*2 Specification guaranteed voltage range is 1 V to 160 V / 2 V to 320 V (AC) and 1.4 V to 226 V / 2.8 V to 452 V (DC)

\*3 At ambient temperature of 23 °C±5 °C.

\*4 No load, output frequency 45 Hz to 65 Hz

\*5 When the phase angle of 120° of each phase.

\*6 For output phase voltage of 100 Vac to 160 Vac/ 200 Vac to 320 Vac and output voltage of 100 Vdc to 226 Vdc/ 200 Vdc to 452 Vdc, output current is reduced with output voltage.

When the output frequency is between 1 Hz and 40 Hz, the output current is reduced by the output frequency. The output current is 70 % at 1 Hz.

\*7 On the 500 Hz limit model, the frequency is limited to 1 Hz to 500.0 Hz for three-phase output.

\*8 Within ±(0.4° + 2.5 μs×360°×fo×10<sup>-3</sup>). The following show the angles obtained by calculating the expression with the specified frequency within ± 0.5° (at 60 Hz output), within ± 0.8° (at 400 Hz output)

\*9 With no load at 23°C±5°C.

\*10 When the output voltage is 100 V or 200 V, the output current is the rated value, the load power factor is 1, and the output frequency is between 40 Hz and 1 kHz.

\*11 Repeated output is possible when the crest factor is 4.

\*12 125 Vac/ 250 Vac (output L range/ H range)

\*13 Waveform bank 0, at 1 Hz to 500 Hz.

## Regeneration Function

Only for three-phase, three-wire input models with R at the end of the model name. Single-phase output models and three-phase, four-wire input models do not have a regeneration function. For regeneration within the installation site only.

Model	Single-phase/three-phase switchable model						
	PCR 6000WEA2R	PCR 12000WEA2R	PCR 18000WEA2R	PCR 24000WEA2R	PCR 30000WEA2R	PCR 36000WEA2R	
Maximum regenerated power *1	6 kVA	12 kVA	18 kVA	24 kVA	30 kVA	36 kVA	
Maximum reverse power flow current *1 *2	1P2W	60 A / 30 A	120 A / 60 A	180 A / 90 A	240 A / 120 A	300 A / 150 A	360 A / 180 A
	1P3W 3P	20 A / 10 A	40 A / 20 A	60 A / 30 A	80 A / 40 A	100 A / 50 A	120 A / 60 A
Regeneration efficiency *3	85 % (TYP)						
Output current harmonic distortion	THD: 5 % and less, each harmonic: 3 % and less (2nd to 40th)						

\*1 When the output phase voltage is between 100 Vac and 160 Vac or 200 Vac and 320 Vac, the output current is reduced by the output voltage.

When the output frequency is between 1 Hz and 40 Hz, the output current is reduced by the output frequency. The output current is 70 % at 1 Hz.

\*2 When the output voltage is 100 V or 200 V and the output frequency is between 40 Hz and 1 kHz (when the current phase is -90 deg to -180 deg or 90 deg to 180 deg relative to the output voltage)

\*3 When the output voltage is 100 V or 200 V, the output current is the rated value, sine wave, the load power factor is 1, and the output frequency is between 45 Hz to 65 Hz.

## Output Voltage Stability (Phase Voltage)

Model	Single-phase output			Single-phase/three-phase switchable model					
	PCR 1000WEA	PCR 2000WEA	PCR 3000WEA2	PCR 6000WEA2	PCR 12000WEA2	PCR 18000WEA2	PCR 24000WEA2	PCR 30000WEA2	PCR 36000WEA2
				PCR 6000WEA2R	PCR 12000WEA2R	PCR 18000WEA2R	PCR 24000WEA2R	PCR 30000WEA2R	PCR 36000WEA2R
Line regulation *1	Within $\pm 0.1$ %								
Load regulation *2	Within $\pm 0.1$ V / $\pm 0.2$ V (1 Hz to 100 Hz) Within $\pm 0.3$ V / $\pm 0.6$ V (100.1 Hz to 500 Hz) Within $\pm 1$ V / $\pm 2$ V (500.1 Hz to 1 kHz)						Within $\pm 0.2$ V / $\pm 0.4$ V (1 Hz to 100 Hz) Within $\pm 0.3$ V / $\pm 0.6$ V (100.1 Hz to 500 Hz) Within $\pm 1$ V / $\pm 2$ V (500.1 Hz to 1 kHz)		
Output frequency variation *3	When the output voltage correction function is enabled : Within $\pm 0.3$ % (1 Hz to 1 kHz), Within $\pm 10$ % (1001 Hz to 5 kHz) When the output voltage correction function is disabled : Within -3 dB (5 kHz)								
Ripple noise *4	$\leq 0.25$ Vrms								
Ambient temperature variation *5	$\pm 100$ ppm / °C (TYP)								
Total harmonic distortion *6	0.3 % and less (1 Hz to 100 Hz), 0.5 % and less (100.1 Hz to 330 Hz), 1.5 %/kHz and less (330.1 Hz to 5 kHz)								
Transient response *7	Response FAST : 40 $\mu$ s (TYP)								
Response speed Tr/Tf *8	Response FAST : 40 $\mu$ s (TYP) Response MEDIUM : 100 $\mu$ s (TYP) Response SLOW : 300 $\mu$ s (TYP)								

\*1 With respect to changes in the rated range of input voltage.

\*2 With respect to 0 % to 100 % changes in the rating of output current.

When the output phase voltage is between 80 V and 160 V (L range) or 160 V and 320 V (H range) and the load power factor is 1, and the response is FAST.

At the output terminal block, when the compensation function is not used.

\*3 Voltage variation over 40 Hz to 5 kHz in AC mode with 55 Hz as the reference.

When the output phase voltage is between 80 V and 160 V or 160 V and 320 V and the load power factor is 1, and the response is FAST, at the output terminal block.

\*4 5 Hz to 1 MHz components in DC mode.

\*5 With respect to changes in the operating temperature range. When the output phase voltage is 100 V or 200 V, with no load.

\*6 When the output phase voltage is between 80 V and 160 V or 160 V and 320 V and the load power factor is 1, and the response is FAST, at the output terminal block.

\*7 When the output voltage is 100 V or 200 V, the load power factor is 1, and the output current changes from 0 A to the rated value and from the rated value to 0 A.

\*8 At 10 % to 90 % of the output voltage.

## Measurement

Model	Single-phase output			Single-phase/three-phase switchable model						
	PCR 1000WEA	PCR 2000WEA	PCR 3000WEA2	PCR 6000WEA2	PCR 12000WEA2	PCR 18000WEA2	PCR 24000WEA2	PCR 30000WEA2	PCR 36000WEA2	
				PCR 6000WEA2R	PCR 12000WEA2R	PCR 18000WEA2R	PCR 24000WEA2R	PCR 30000WEA2R	PCR 36000WEA2R	
Voltage Rms value	Resolution	0.1 V								
	Accuracy *1	DC, 40 Hz to 999.9 Hz : $\pm 0.3$ % of reading +1 V) 1 kHz to 5 kHz : $\pm 0.5$ % of reading +1 V)								
Current Rms value	Resolution	0.01 A			0.1 A					
	Accuracy *1 *2	45 Hz to 65 Hz : $\pm 0.3$ % of reading +0.3 % of f.s) DC, 40 Hz to 999.9 Hz : $\pm 0.6$ % of reading +0.6 % of f.s) 1 kHz to 5 kHz : $\pm 1.2$ % of reading +1.2 % of f.s)								
Current peak value	Resolution	0.01 A			0.1 A			1 A		
	Accuracy *1 *3	4 % of f.s								
Active power	Resolution	1 W			10 W					
	Accuracy *1 *2 *4	45 Hz to 65 Hz : $\pm 0.3$ % of reading +0.3 % of f.s)								
Apparent power	Resolution	1 VA			10 VA					
Power factor	Resolution	0.01								
Phase difference	Resolution	0.1°								
Harmonic measurement	Frequency range (fundamental wave)	10 Hz to 1 kHz								
	Upper limit of harmonic analysis	5th to 50th								
	FFT data length	4096								
	Measurement items	Rms voltage and current, phase angle, THD								
Recommended calibration period	1 year									

\*1 At ambient temperature of 23 °C  $\pm 5$  °C.

\*2 At 10 % to 100 % of maximum rated current, sine wave.

\*3 Pulse height of sine wave

\*4 At a power factor of 1.

# Specifications

## General

Model		Single-phase output			Single-phase/three-phase switchable model					
		PCR 1000WEA	PCR 2000WEA	PCR 3000WEA2	PCR 6000WEA2	PCR 12000WEA2	PCR 18000WEA2	PCR 24000WEA2	PCR 30000WEA2	PCR 36000WEA2
					PCR 6000WEA2R	PCR 12000WEA2R	PCR 18000WEA2R	PCR 24000WEA2R	PCR 30000WEA2R	PCR 36000WEA2R
Insulation resistance	Between input and chassis, output and chassis, and input and output	500 Vdc, 10 MΩ or more								
Withstand voltage	Between input and chassis, output and chassis, and input and output	1500 Vac / 2150 Vdc, 1 minute								
Electromagnetic compatibility (EMC) *1 *2		Complies with the requirements of the following directive and standards. EMC Directive 2014/30/EU EN 61326-1 (Class A*3), EN 55011 (Class A*3, Group 1*4), EN 61000-3-2*5, EN 61000-3-3*5 Applicable under the following conditions The maximum length of all cabling and wiring connected to the product must be less than 3 m.				Complies with the requirements of the following directive and standards. EMC Directive 2014/30/EU EN 61326-1 (Class A*3) EN 55011 (Class A*3, Group 1*4) Applicable under the following conditions The maximum length of all cabling and wiring connected to the product must be less than 3 m.				
Safety *1		Complies with the requirements of the following directive and standards. Low Voltage Directive 2014/35/EU*2 EN 61010-1 (Class I*6, Pollution Degree2*7)								
Environmental conditions	Operating environment	Indoor use, overvoltage category II								
	Operating temperature range	0 °C to +50 °C (32 °F to +122 °F)								
	Storage temperature range	-10 °C to +60 °C (14 °F to +140 °F)								
	Operating humidity range	20 %rh to 80 %rh (no condensation)								
	Storage humidity range	90 %rh and less (no condensation)								
Altitude		Up to 2000 m								
Dimensions		See page 17								
Weight		18 kg (39.7 lb)	21 kg (46.3 lb)	25 kg (55.1 lb)	43 kg (94.8 lb)	66 kg (145.5 lb) 67 kg (147.7 lb)	120 kg (264.6 lb)	130 kg (286.6 lb)	160 kg (352.7 lb)	180 kg (396.8 lb)
Input terminal		M6			M5		200 V input model : M8 400 V input model : M5			
Output terminal		M6			M5		M6		M8	
Accessories		Cable tie (4 pcs.), External control(DIGITAL I/O) connector (1 pc.), Heavy object warning label (1 pc.)*Excludes PCR1000WEA, Read This First! (1 copy), Quick Reference(1 sheet), CD-ROM (1 disc), Safety Information (1 copy)								

\*1 Does not apply to specially ordered or modified products.

\*2 Only on models that have the CE marking on the panel.

\*3 This is Class A equipment. This product is intended for use in an industrial environment. This product may cause interference if used in residential areas. Such use must be avoided unless the user takes special measures to reduce electromagnetic emissions to prevent interference to the reception of radio and television broadcasts.

\*4 This is Group 1 equipment. This product does not generate and/or use intentionally radio-frequency energy, in the form of electromagnetic radiation, inductive and/or capacitive coupling, for the treatment of material or inspection/analysis purpose.

\*5 This does not apply to the PCR6000WEA2R.

\*6 This is Class I equipment. Be sure to ground this product's protective conductor terminal. The safety of this product is only guaranteed when the product is properly grounded.

\*7 Pollution is addition of foreign matter (solid, liquid or gaseous) that may produce a reduction of dielectric strength or surface resistivity. Pollution Degree 2 assumes that only non-conductive pollution will occur except for an occasional temporary conductivity caused by condensation.

## Output Impedance Setting

### Resistance component

Model		Single-phase output			Single-phase/three-phase switchable model					
		PCR 1000WEA	PCR 2000WEA	PCR 3000WEA2	PCR 6000WEA2	PCR 12000WEA2	PCR 18000WEA2	PCR 24000WEA2	PCR 30000WEA2	PCR 36000WEA2
					PCR 6000WEA2R	PCR 12000WEA2R	PCR 18000WEA2R	PCR 24000WEA2R	PCR 30000WEA2R	PCR 36000WEA2R
L range	1P	0 Ω to 2000 mΩ	0 Ω to 1000 mΩ	0 Ω to 667 mΩ	0 Ω to 333 mΩ	0 Ω to 167 mΩ	0 Ω to 111 mΩ	0 Ω to 83 mΩ	0 Ω to 67 mΩ	0 Ω to 56 mΩ
	1P3W 3P	—	—	0 Ω to 2000 mΩ	0 Ω to 1000 mΩ	0 Ω to 500 mΩ	0 Ω to 333 mΩ	0 Ω to 250 mΩ	0 Ω to 200 mΩ	0 Ω to 167 mΩ
H range	1P	0 Ω to 8000 mΩ	0 Ω to 4000 mΩ	0 Ω to 2667 mΩ	0 Ω to 1333 mΩ	0 Ω to 667 mΩ	0 Ω to 444 mΩ	0 Ω to 333 mΩ	0 Ω to 267 mΩ	0 Ω to 222 mΩ
	1P3W 3P	—	—	0 Ω to 8000 mΩ	0 Ω to 4000 mΩ	0 Ω to 2000 mΩ	0 Ω to 1333 mΩ	0 Ω to 1000 mΩ	0 Ω to 800 mΩ	0 Ω to 667 mΩ

### Reactance component

■ Response: FAST

Model		Single-phase output			Single-phase/three-phase switchable model					
		PCR 1000WEA	PCR 2000WEA	PCR 3000WEA2	PCR 6000WEA2	PCR 12000WEA2	PCR 18000WEA2	PCR 24000WEA2	PCR 30000WEA2	PCR 36000WEA2
					PCR 6000WEA2R	PCR 12000WEA2R	PCR 18000WEA2R	PCR 24000WEA2R	PCR 30000WEA2R	PCR 36000WEA2R
L range	1P	40 μH to 2000 μH	20 μH to 1000 μH	13 μH to 667 μH	7 μH to 333 μH	3 μH to 167 μH	2 μH to 111 μH	2 μH to 83 μH	1 μH to 67 μH	1 μH to 56 μH
	1P3W 3P	—	—	40 μH to 2000 μH	20 μH to 1000 μH	10 μH to 500 μH	7 μH to 333 μH	5 μH to 250 μH	4 μH to 200 μH	3 μH to 167 μH
H range	1P	160 μH to 8000 μH	80 μH to 4000 μH	53 μH to 2667 μH	27 μH to 1333 μH	13 μH to 667 μH	9 μH to 444 μH	7 μH to 333 μH	5 μH to 267 μH	4 μH to 222 μH
	1P3W 3P	—	—	160 μH to 8000 μH	80 μH to 4000 μH	40 μH to 2000 μH	27 μH to 1333 μH	20 μH to 1000 μH	16 μH to 800 μH	13 μH to 667 μH

■ Response: MED

Model		Single-phase output			Single-phase/three-phase switchable model					
		PCR 1000WEA	PCR 2000WEA	PCR 3000WEA2	PCR 6000WEA2	PCR 12000WEA2	PCR 18000WEA2	PCR 24000WEA2	PCR 30000WEA2	PCR 36000WEA2
					PCR 6000WEA2R	PCR 12000WEA2R	PCR 18000WEA2R	PCR 24000WEA2R	PCR 30000WEA2R	PCR 36000WEA2R
L range	1P	80 μH to 2000 μH	40 μH to 1000 μH	27 μH to 667 μH	13 μH to 333 μH	7 μH to 167 μH	4 μH to 111 μH	3 μH to 83 μH	3 μH to 67 μH	2 μH to 56 μH
	1P3W 3P	—	—	80 μH to 2000 μH	40 μH to 1000 μH	20 μH to 500 μH	13 μH to 333 μH	10 μH to 250 μH	8 μH to 200 μH	7 μH to 167 μH
H range	1P	320 μH to 8000 μH	160 μH to 4000 μH	107 μH to 2667 μH	53 μH to 1333 μH	27 μH to 667 μH	18 μH to 444 μH	13 μH to 333 μH	11 μH to 267 μH	9 μH to 222 μH
	1P3W 3P	—	—	320 μH to 8000 μH	160 μH to 4000 μH	80 μH to 2000 μH	53 μH to 1333 μH	40 μH to 1000 μH	32 μH to 800 μH	27 μH to 667 μH

■ Response: SLOW

Model		Single-phase output			Single-phase/three-phase switchable model					
		PCR 1000WEA	PCR 2000WEA	PCR 3000WEA2	PCR 6000WEA2	PCR 12000WEA2	PCR 18000WEA2	PCR 24000WEA2	PCR 30000WEA2	PCR 36000WEA2
					PCR 6000WEA2R	PCR 12000WEA2R	PCR 18000WEA2R	PCR 24000WEA2R	PCR 30000WEA2R	PCR 36000WEA2R
L range	1P	240 μH to 2000 μH	120 μH to 1000 μH	80 μH to 667 μH	40 μH to 333 μH	20 μH to 167 μH	13 μH to 111 μH	10 μH to 83 μH	8 μH to 67 μH	7 μH to 56 μH
	1P3W 3P	—	—	240 μH to 2000 μH	120 μH to 1000 μH	60 μH to 500 μH	40 μH to 333 μH	30 μH to 250 μH	24 μH to 200 μH	20 μH to 167 μH
H range	1P	960 μH to 8000 μH	480 μH to 4000 μH	320 μH to 2667 μH	160 μH to 1333 μH	80 μH to 667 μH	53 μH to 444 μH	40 μH to 333 μH	32 μH to 267 μH	27 μH to 222 μH
	1P3W 3P	—	—	960 μH to 8000 μH	480 μH to 4000 μH	240 μH to 2000 μH	160 μH to 1333 μH	120 μH to 1000 μH	96 μH to 800 μH	80 μH to 667 μH

**Limit Values and Protection Functions (Common Specification)**

		Setting range	Setting resolution	
Voltage protection	AC voltage upper limit	0.0 V to 322.0 V	0.1 V	
	AC voltage lower limit			
	DC voltage upper limit	-455 V to 455 V	0.1 V	
	DC voltage lower limit			
	Output overvoltage protection (OVP)	Rms value	14.0 V to 500.5 V	0.1 V
		Positive peak value	14.0 V to 500.5 V	0.1 V
Negative peak value		-500.5 V to -14.0 V		
Power module overvoltage protection	Fixed	—		
Output undervoltage protection (UVP)	0.0 V to 500.5 V	0.1 V		
Frequency protection	Frequency upper limit	1 Hz to 5000 Hz 500 Hz LMT model: 1 Hz to 500 Hz (Three-phase output)	0.01 Hz (1.00 Hz to 100.0 Hz)	
	Frequency lower limit		0.1 Hz (100.0 Hz to 1000 Hz), 1 Hz (1000 Hz to 5000 Hz)	
Current protection	Current limit *1	Maximum output current × 0.1 to maximum output current × 1.1	0.01 A (0.35 A to 100.0 A), 0.1 A (100.0 A to 1000 A)	
	Positive peak current limit	Maximum output current × 0.1 to maximum output current × 4.2		
	Negative peak current limit *2			
Overheat protection	Power module overheat protection	Fixed	—	
	Fan error	Fixed	—	
Overload protection	Rated current or current limit	Current limit resolution		
Independent operation detection	Fixed	—		
Sensing error detection	±(10 % +10 V) with respect to the output terminal voltage	—		

\*1 The current that can actually be supplied is 1.1 times the rated current or the current limit, whichever is less.

\*2 The current that can actually be supplied is the maximum peak current or the current limit, whichever is less.

**Communication Interface (Common Specification)**

USB	Complies with the USB 2.0 specifications; data rate: 480 Mbps (high speed), socket B type, self-powered, Complies with the USBTMC-USB488 device class specifications.
LAN	IEEE802.3, 100Base-TX Ethernet LXI Rev.1.5 2016 (extended functions: VXI-11, HiSLIP, IPv6), data rate: 100 Mbps (auto negotiation, full speed) AUTO MDIX function IPv4, RJ45 connector, category 5, straight cable Complies with SCPI Specification 1999.0
RS232C	Complies with the EIA232D specifications, asynchronous full duplex, D-SUB 9-pin connector (male), crossover cable (null modem), 9600bps/19200bps/38400bps/57600bps/115200bps
GPIB (option)	Complies with IEEE Std 488.1-1987 SH1, AH1, T8, L4, SR0, RL0, PP0, DC0, DT0, C0, E1 24-pin connector (receptacle)

**KIKUSUI** AC POWER SUPPLY  
PCR6000WEA2  
AC: 100V/0-320V  
DC: 226V/0-452V  
DC: 1.5kHz 6kVA MAX

OUTPUT



SLEEP



OUTPUT  
OFF

3P

U 0.0  
V 0.0  
W 0.0

F1

F2

**6U**

approx. **262 mm**  
(10.32 inch)

**6kVA**

**3 times**  
**the power**

\*of previous PCR-W series

**Actual**  
**size**

POWER





Dimensions (Unit:mm(inches))

■ PCR1000WEA/ PCR2000WEA/ PCR3000WEA2

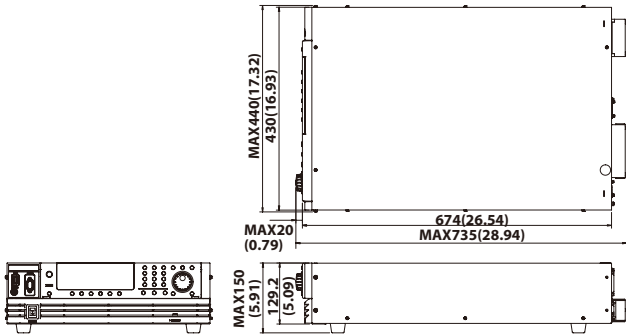

■ PCR1800WEA2/ PCR1800WEA2R  
PCR2400WEA2/ PCR2400WEA2R

- This figure shows 200 V model.
- The 400 V model includes a terminal block cover.

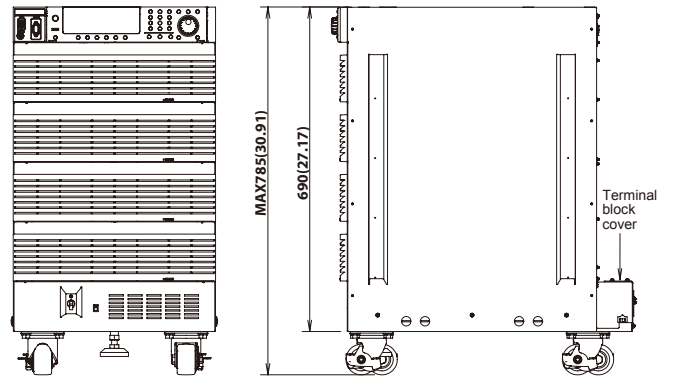
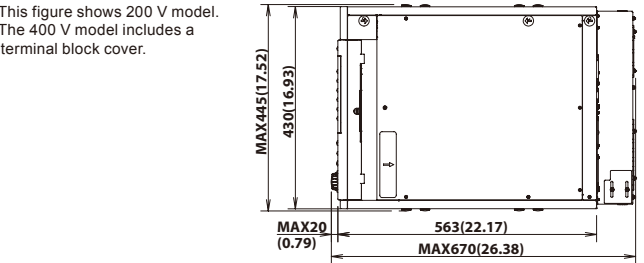

■ PCR6000WEA2/  
PCR6000WEA2R

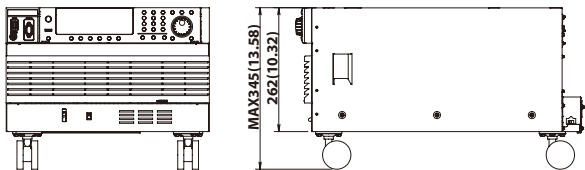
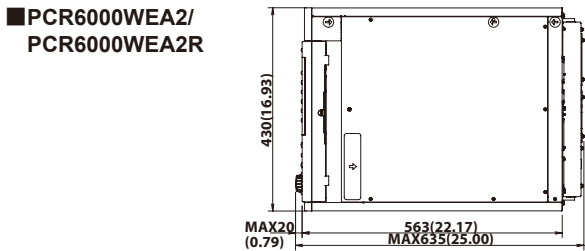

■ PCR3000WEA2/ PCR3000WEA2R  
PCR3600WEA2/ PCR3600WEA2R

- This figure shows 200 V model.
- The 400 V model includes a terminal block cover.

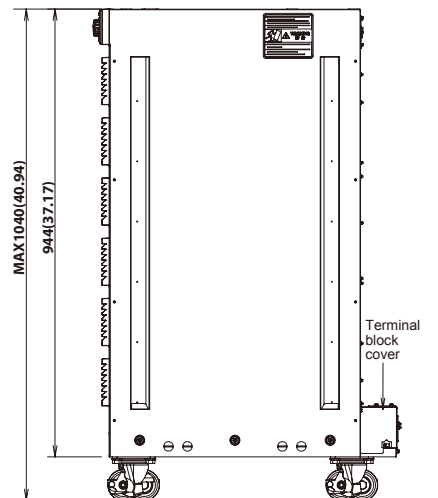
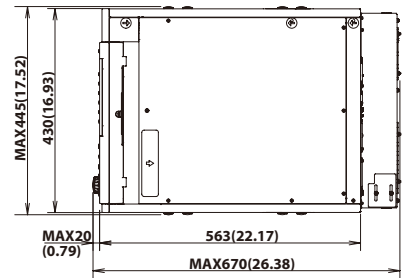

■ PCR1200WEA2/  
PCR1200WEA2R

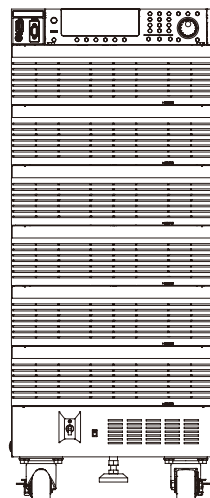
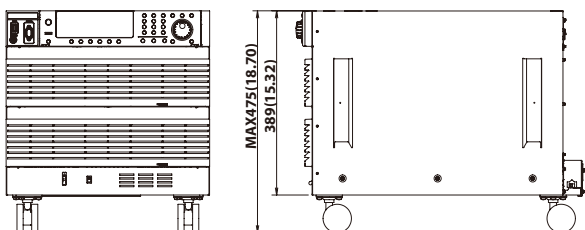
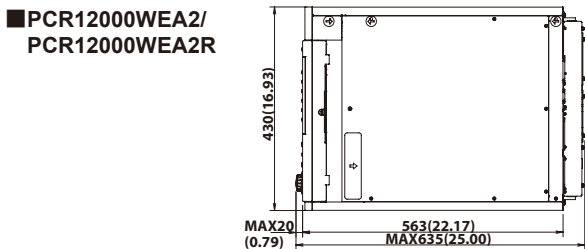

## Options



- GPIB Interface Boards  
**IB07-PCR-WE**  
This board enables you to control the PCR-WEA/  
WEA2 Series over GPIB.

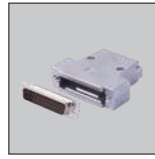

- External-control Connector  
**OP01-PCR-WE (for DIGITAL I/O)**



- Parallel-operation Cable (1 m)  
**PC01-PCR-WE**



- External-control Connector  
**OP02-PCR-WE (for ANALOG I/O)**



- Power-sync Cable (1 m)  
**LC01-PCR-LE**

- Rack Mount Brackets  
For PCR1000WEA/2000WEA/3000WEA2  
**KRB3-TOS (EIA inch rack)**  
**KRB150-TOS (JIS millimeter rack)**

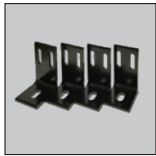

- Base Hold Angles  
**OP03-KRC**

- For PCR6000WEA2(R)  
**KRB6 (EIA inch rack)**  
**KRB300 (JIS millimeter rack)**  
For PCR12000WEA2(R)  
**KRB9 (EIA inch rack)**  
**KRB400-PCR-LE (JIS millimeter rack)**

## Output Terminal Box

Easy to select output mode “single-phase, single-phase 3-wire, and 3-phase” without re-wiring.

- 2 lineups depend on output power, “6 kVA to 18 kVA model” and “24 kVA to 36 kVA model”.
- Toggle between “single-phase” or “single-phase 3-wire/3-phase” output terminal using main unit switch.



An output terminal box gives output mode selection “single-phase, single-phase 3-wire and 3-phase” of PCR-WEA/WEA2 series. Selectable switches equipped in its body achieve multi-phase output without output cable re-wiring.

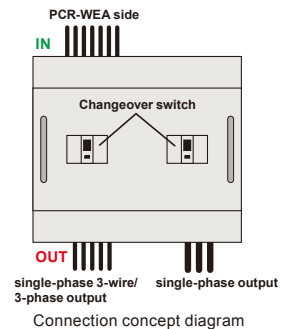
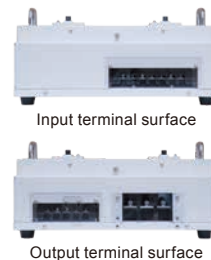

### Lineup

	Model
Output terminal box (18 kVA)	<b>OT01-PCR-WE</b>
Output terminal box (36 kVA)	<b>OT02-PCR-WE</b>

### Connecting cable

	Model		Model
For 6 k, 12 kVA (0.7 m)	<b>AC14-7P0.7M-M5M6</b>	For 24 kVA (0.7 m)	<b>AC22-7P0.7M-M6M8</b>
For 6 k, 12 kVA (1.4 m)	<b>AC14-7P1.4M-M5M6</b>	For 24 kVA (1.4 m)	<b>AC22-7P1.4M-M6M8</b>
For 18 kVA (0.7 m)	<b>AC22-7P0.7M-M6M6</b>	For 30 k, 36 kVA (0.7 m)	<b>AC38-7P0.7M-M8M8</b>
For 18 kVA (1.4 m)	<b>AC22-7P1.4M-M6M6</b>	For 30 k, 36 kVA (1.4 m)	<b>AC38-7P1.4M-M8M8</b>

### Specification

		OT01-PCR-WE	OT02-PCR-WE
Connectable models		PCR6000WEA2(R), PCR12000WEA2(R), PCR18000WEA2(R)	PCR24000WEA2(R), PCR30000WEA2(R), PCR36000WEA2(R)
Maximum input/output rating (AC)	Maximum voltage (phase voltage)	AC310 V	
	Maximum current (Single-phase 2 wire)	AC180 A	AC360 A
	Maximum current (Single-phase 3 wire/3-phase)	AC60 A	AC120 A
	frequency	45 Hz to 400 Hz	
Input terminal block	Shape	M6×7P screw terminal block	M8×7P screw terminal block
	Array/quantity	U-V-W-N-N-N-G / 1 piece	
Output terminal block (Single-phase 2 wire)	Shape/array/quantity	M10×3P screw terminal block / L-N-G / 1 piece	
Output terminal block (Single-phase 3 wire/3-phase)	Shape	M6×5P screw terminal block	M8×5P screw terminal block
	Array/quantity	U-V-W-N-N-G / 1 piece	
Dimensions(W×H×D)/Weight		445 mm×215 mm×410 mm / approx.13 kg	445 mm×270 mm×410 mm / approx.19 kg

## ■ Input Power Cable

Appropriate Model		Model	Cable	Length	Nominal cross sectional area	Input terminal
PCR1000WEA/2000WEA	Single-phase two-wire input	<b>AC5.5-1P3M-M6C-3S</b>	Three single-core cables	3 m	5.5 mm <sup>2</sup>	M6
PCR3000WEA2	Single-phase two-wire input	<b>AC14-1P3M-M6C-3S</b>	Three single-core cables	3 m	14 mm <sup>2</sup>	M6
PCR6000WEA2R	Three-phase three-wire input	<b>AC5.5-1P3M-M5C-4S</b>	Four single-core cables	3 m	5.5 mm <sup>2</sup>	M5
PCR6000WEA2	Three-phase four-wire input	<b>AC5.5-1P3M-M5C-5S</b>	Five single-core cables	3 m	5.5 mm <sup>2</sup>	M5
PCR12000WEA2R	Three-phase three-wire input	<b>AC14-1P3M-M5C-4S</b>	Four single-core cables	3 m	14 mm <sup>2</sup>	M5
PCR12000WEA2	Three-phase four-wire input	<b>AC5.5-1P3M-M5C-5S</b>	Five single-core cables	3 m	5.5 mm <sup>2</sup>	M5
PCR18000WEA2R	Three-phase three-wire input	<b>AC22-1P3M-M8C-4S</b>	Four single-core cables	3 m	22 mm <sup>2</sup>	M8
PCR18000WEA2	Three-phase four-wire input	<b>AC8-1P3M-M5C-5S</b>	Five single-core cables	3 m	8 mm <sup>2</sup>	M5
PCR24000WEA2R	Three-phase three-wire input	<b>AC38-1P3M-M8C-4S</b>	Four single-core cables	3 m	38 mm <sup>2</sup>	M8
PCR24000WEA2	Three-phase four-wire input	<b>AC14-1P3M-M5C-5S</b>	Five single-core cables	3 m	14 mm <sup>2</sup>	M5
PCR30000WEA2R	Three-phase three-wire input	<b>AC60-1P3M-M8C-4S</b>	Four single-core cables	3 m	60 mm <sup>2</sup>	M8
PCR30000WEA2	Three-phase four-wire input	<b>AC22-1P3M-M5C-5S</b>	Five single-core cables	3 m	22 mm <sup>2</sup>	M5
PCR36000WEA2R	Three-phase three-wire input	<b>AC60-1P3M-M8C-4S</b>	Four single-core cables	3 m	60 mm <sup>2</sup>	M8
PCR36000WEA2	Three-phase four-wire input	<b>AC22-1P3M-M5C-5S</b>	Five single-core cables	3 m	22 mm <sup>2</sup>	M5

## ■ Sequence Creation Software "Wavy" SD032-PCR-WE (Wavy for PCR-WE)

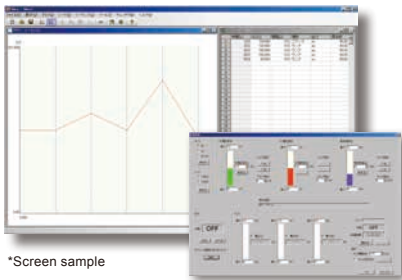

**The software that further enhances the waveform generation and sequence functions of the PCR-WEA/WEA2 Series.  
Easy sequence control without programming knowledge!**

Wavy is an application software that supports sequence creation and operation for Kikusui power supplies and electronic loads. Wavy allows you to create and edit sequences visually with just a mouse. Real-time graph-monitor function is equipped and enables monitoring and logging values of voltage and current. It is possible to operate the power supply with the feeling of remote control by direct control function.

# The never-ending evolution of power supplies!



## PCR-WEA/WEA2 Series

**5** POWER UP  
points

- 1** Output voltage up 310 Vrms **320 Vrms**
- 2** Transient response - response speed 55  $\mu$ s **40  $\mu$ s**
- 3** Output impedance reduction **Reduced by 50 %**
- 4** Improved output stability. **Increased stability in SLOW mode.**
- 5** Interface options **Analog monitor output**

### Comparison with previous model

Model	PCR-WE/WE2 Series	PCR-WEA/WEA2 Series
Firmware	Ver 1.24	Ver 3.12
Basic function	Output voltage 155/310 Vrms $\pm$ 219/438 Vdc	Output voltage 160/320 Vrms $\pm$ 226/452 Vdc
Applied functions	Same value regardless of the lower limit response setting for output impedance (reactance component).	Lower limit of output impedance (reactance component) FAST : reduced by 50 % MED : no change SLOW : 3x
Interface	None	Addition of analog monitor output option (factory option) * 6 kVA models and higher



### KIKUSUI ELECTRONICS CORPORATION

1-1-3, Higashiyamata, Tsuzuki-ku, Yokohama, Kanagawa, 224-0023, Japan  
Phone: (+81)45-593-0200, Facsimile: (+81)45-593-7591, <https://global.kikusui.co.jp/>

KIKUSUI AMERICA, INC. 1-310-214-0000 [www.kikusuiamerica.com](http://www.kikusuiamerica.com)



3625 Del Amo Blvd, Suite 160, Torrance, CA 90503  
Phone : 310-214-0000 Facsimile : 310-214-0014

KIKUSUI TRADING (SHANGHAI) Co., Ltd. [www.kikusui.cn](http://www.kikusui.cn)



Room 305, Shenggao Building, No.137, Xianxia Road, Shanghai City, China  
Phone : 021-5887-9067 Facsimile : 021-5887-9069

For our local sales distributors and representatives, please refer to "sales network" of our website.

Printed in Japan

### ●Distributor:

■ All products contained in this catalogue are equipment and devices that are premised on use under the supervision of qualified personnel, and are not designed or produced for home-use or use by general consumers. ■ Specifications, design and so forth are subject to change without prior notice to improve the quality. ■ Product names and prices are subject to change and production may be discontinued when necessary. ■ Product names, company names and brand names contained in this catalogue represent the respective registered trade name or trade mark. ■ Colors, textures and so forth of photographs shown in this catalogue may differ from actual products due to a limited fidelity in printing. ■ Although every effort has been made to provide the information as accurate as possible for this catalogue, certain details have unavoidably been omitted due to limitations of space. ■ If you find any misprints or errors in this catalogue, it would be appreciated if you would inform us. ■ Please contact our distributors to confirm specifications, prices, accessories or anything that may be unclear when placing an order or concluding a purchasing agreement.

Issue: Nov 2022 202211PDFEC41