



E5052B Signal Source Analyzer

10 MHz to 7 GHz, 26.5 GHz, or 110 GHz

Everything you need for signal source analysis in one instrument

Testing the performance of next-generation signal sources such as voltage-controlled oscillators (VCOs), surface acoustic wave (SAW) oscillators, dielectric resonator oscillator (DROs), PLL synthesizers, RFICs, transmitters, clock generators in high-speed data communication systems, and other devices can be challenging - especially with a bench full of instruments. Valuable time is spent learning to use multiple tools, determining the best tool to use, calibrating each instrument, setting up measurements, and then getting the right parameters. Capability restrictions in a number of the older instruments also make it difficult and time consuming to obtain right parameters to get accurate measurements.

With Keysight Technologies' new Signal Source Analyzer (SSA), engineers no longer need a bench full of tools. All they need is one comprehensive test solution to perform next-generation signal source analysis.

The Keysight E5052B Signal Source Analyzer:

- Performs all the critical signal source evaluations in one instrument
- Simplifies complicated, time-consuming measurements and dramatically reduces test time
- Provides excellent phase noise and transient measurements with performance to meet tough measurement challenges
- Has the right combination of performance and ease-of-use to significantly improve design and test productivity by reducing calibration cycles and switch maintenance.

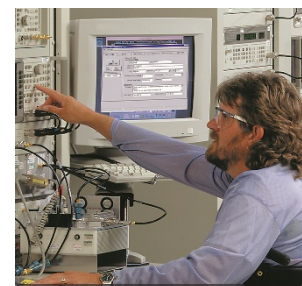

Engineers no longer need a bench full of tools to perform signal source analysis.



Today, engineers only need a single tool for signal source analysis.

Keysight's Signal Source Analyzer delivers unparalleled performance and versatility for a variety of signal sources in a wide range of industries such as wireless communications, aerospace & defense, satellite communications, automotive, education, and more.

Signal source analyzer frequency options

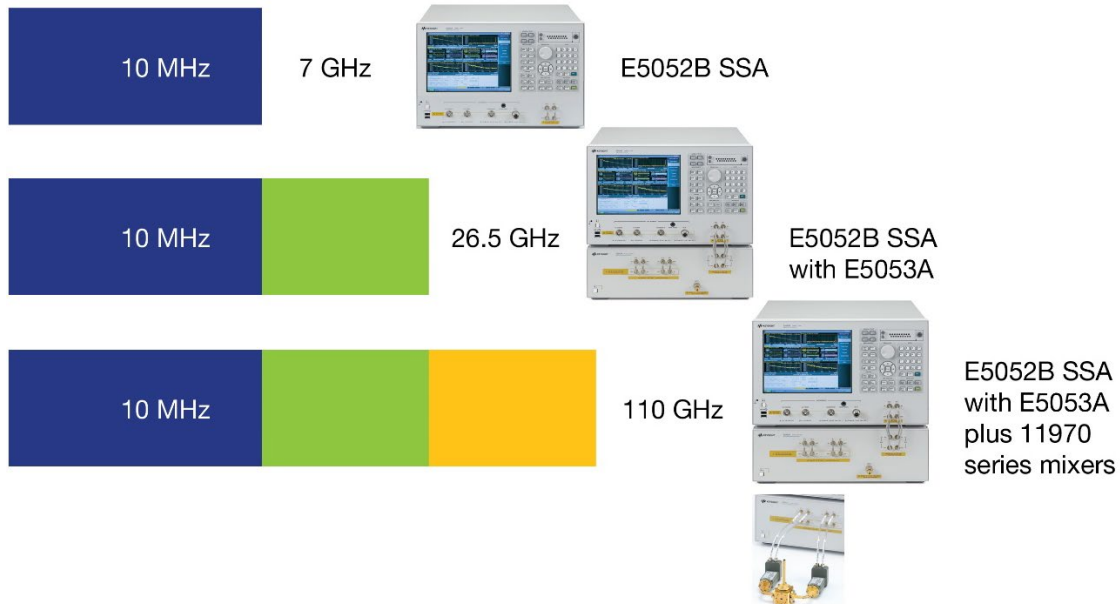

One instrument does it all...

Keysight's Signal Source Analyzer provides an indispensable set of measurements in one comprehensive tool:

- Phase noise
- Frequency, phase, and power, transients over time
- Frequency, RF power, and DC current
- Spectrum monitor
- AM noise measurement
- Baseband noise measurement

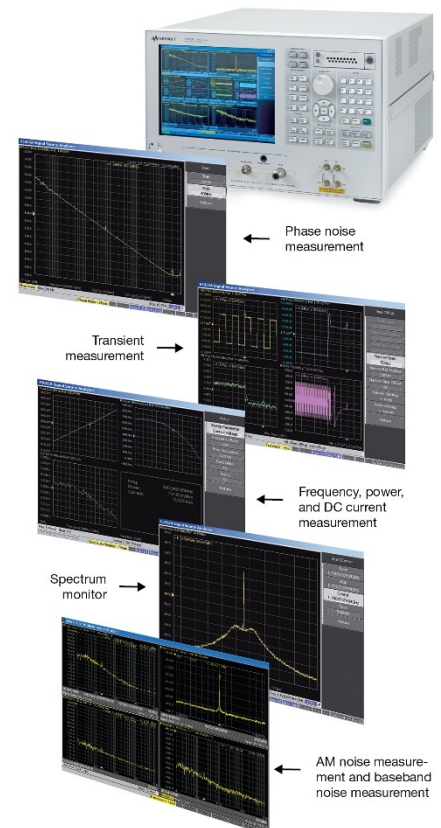

Features Benefits

True single-connection for signal source evaluations	<ul style="list-style-type: none">• Dramatically simplifies complicated measurement procedures and reduces test time by eliminating reconnection and set up of individual instruments.
One-step phase noise	<ul style="list-style-type: none">• Easy, one-step process eliminates measurement time-consuming tasks and provides measurement speeds more than 10 times faster than conventional methods.
Built-in low-noise reference	<ul style="list-style-type: none">• Fully-optimized for phase noise measurements sources and provides excellent phase noise sensitivity.• This technique is also available for AM noise and baseband noise measurements.
Cross-correlation technique	<ul style="list-style-type: none">• Lowers system phase noise providing exceptional phase noise sensitivity.
Simultaneous transient measurements for frequency, phase, and power over time	<ul style="list-style-type: none">• Provides a complete set of measurements to test frequency-switching sources.• Simultaneous measurements both in wideband and narrow-band.• Captures all behaviors of you to analyze very detailed information on signals.• Enhanced video trigger and x100 longer data memory available.
8 nsec sampling resolution with better frequency resolution	<ul style="list-style-type: none">• Enables high-speed switching source measurements with tighter tolerance of a settled frequency - even in a very short period.
Ultra low-noise DC sources	<ul style="list-style-type: none">• Outstanding low-noise DC sources provide accuracy and flexibility to improve throughput.
Multiple measurement windows and versatile analysis capabilities	<ul style="list-style-type: none">• Up to four measurement windows and a user window can be viewed simultaneously, allowing for faster analysis.
Built-in VBA® programming	<ul style="list-style-type: none">• Simplifies complicated measurements and eases automated tests.

Industry-leading performance in one easy-to-use instrument

Keysight's Signal Source Analyzer is the ultimate tool for signal source analysis. Using the latest innovative technology, it is specifically designed to provide you with all the critical measurements and performance you need in a single instrument.

This all-in-one solution is optimized for efficient measurements, high reliability, and offers easy-to-use features to minimize training and increase productivity.

The SSA provides the right combination of performance and flexibility to meet your signal source test needs now and well into the future.

Windows® style interface with touch screen enables intuitive operation.

Multi-window display speeds your measurement evaluation and provides useful design insights by allowing you to view multiple results simultaneously.

Large (10.4-inch) color LCD clearly displays your measurements with the parameters you need.

Ultra-low-noise DC source enables accurate oscillator tests with a wide range of tuning voltage (-15 to 35 V).

Low-noise DC power supply operates oscillators and eases frequency pushing measurements (0 to 16 V).

Baseband noise measurement input has a AC coupled 50 ohm BNC connector (1 Hz to 100 MHz signals).

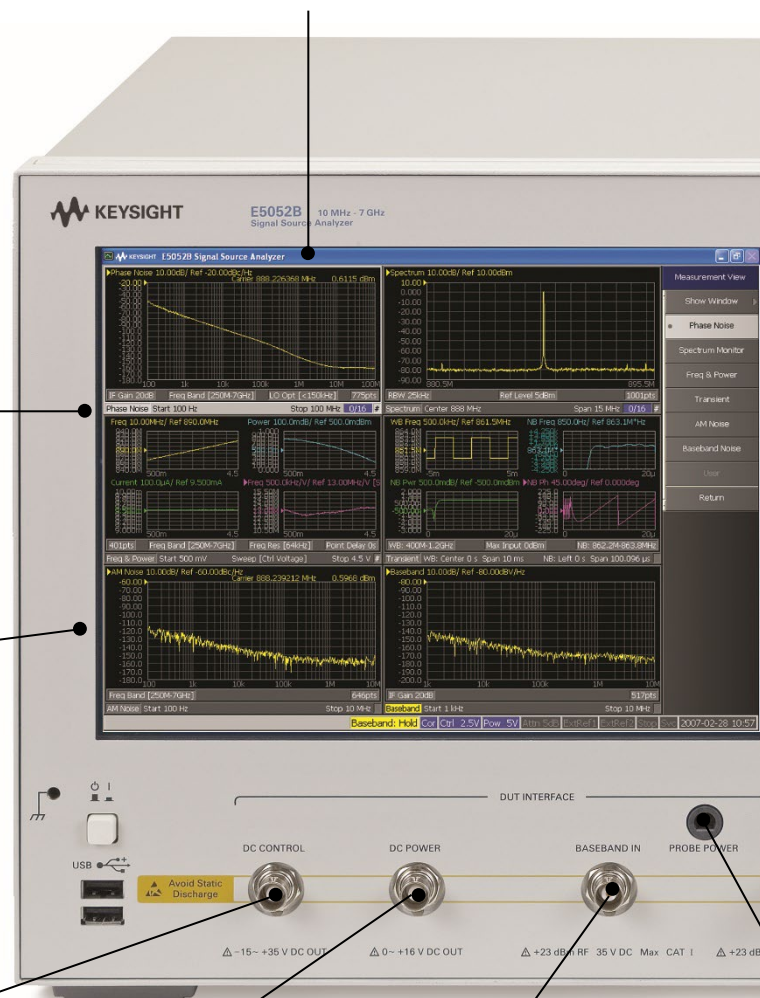

An easy to use interface makes tasks simple.

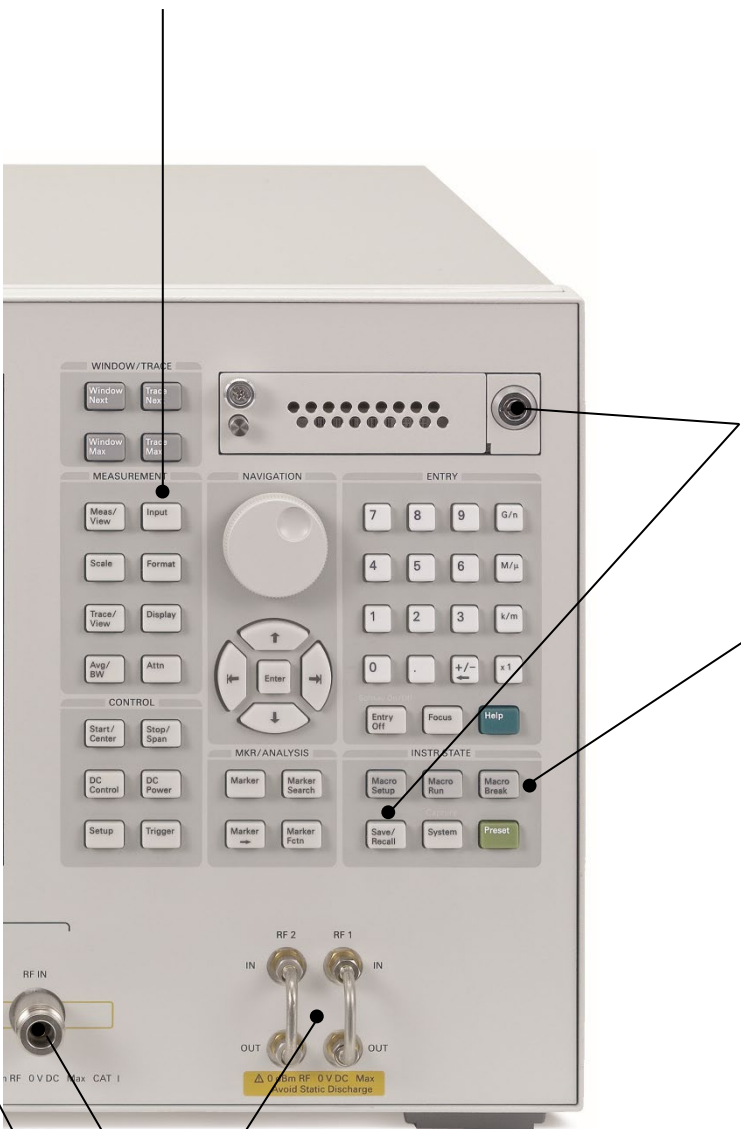

E5053A Microwave Downconverter access.

Single RF input for all measurements.

Probe power for high-impedance probes (+15 V, -12.6 V).



Flexible connectivity (through rear-panel connectors)

24 bit I/O: high-speed handshake with parts handler or other instruments with user defined I/O signals

GPIB: robust instrument control

LAN: high-speed instrument control and data transfer

USB: controls external instruments and peripherals

USB-TMC port: provides more flexibility

XGA: external display

Save/Recall (removable HDD)

- Instrument settings
- Screen capture in .bmp or .png
- Measured data pairs in .csv

Built-in VBA[®] programming simplifies complicated measurements and decreases operator error. Easily configure external automated measurements/procedures and create a graphic user interface tailored to your measurement needs.



Frequency extension from 7 to 26.5 GHz with the E5053A Microwave Downconverter. Phase noise measurements up to 110 GHz with 11970 series harmonic mixers.

Phase noise measurements are now more than 10 times faster!

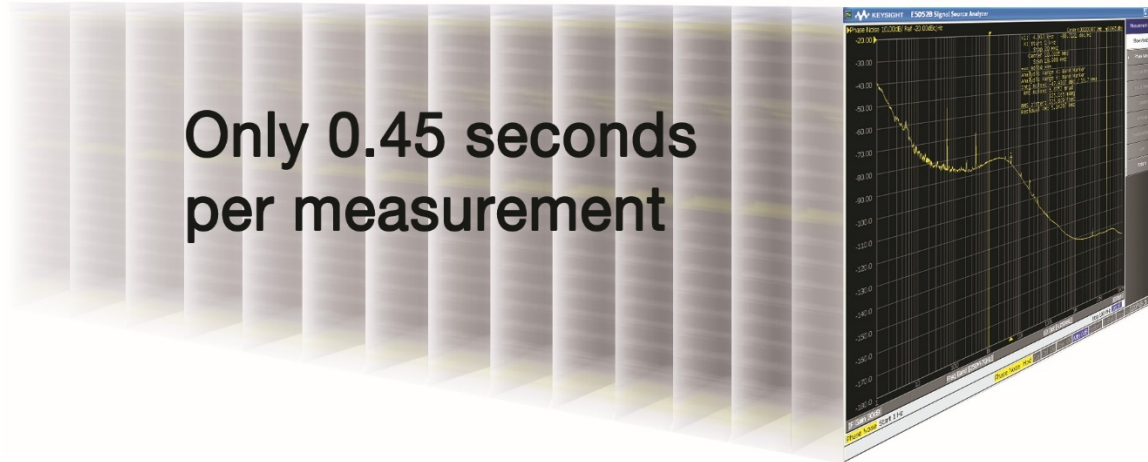

Only 0.45 seconds
per measurement

Easy one-step phase noise measurement

The Signal Source Analyzer provides a true one-step phase noise measurement. This eliminates time-consuming measurement set ups and system calibration. Built-in low-noise reference sources, lock the system to the carrier of the measured signal, automatically enabling and dramatically improving measurement speed. **Tedious phase noise measurements are now more than 10 times faster.**

Real-time phase noise measurement

The measurement speed is exceptionally fast. With a frequency offset range between 1 kHz to 100 MHz, measurements only take 0.45 seconds per measurement. Real-time phase noise measurements not only dramatically improve test time, they also quickly help identify the root cause of undesired behavior of a source-under-test.

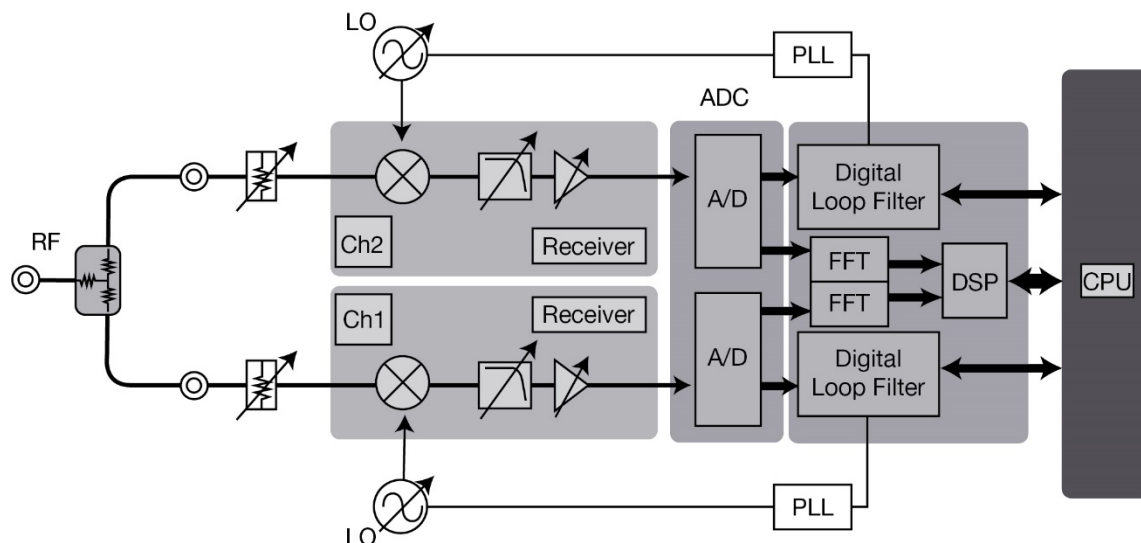

The Signal Source Analyzer's advanced architecture brings phase noise measurement to a new level.

Exceptional phase noise sensitivity

Cross-correlation technique provides exceptional phase noise sensitivity

Dual channel receivers enable a “cross-correlation” technique to lower the instrument’s noise floor at all offset frequencies. Traditionally the phase noise of reference source used in the system limits the measurement sensitivity. However, this technique essentially cancels noises of built-in reference sources and overcomes the limitation. The amount of noise cancellation depends on the “number” of correlations. For example, 100 times correlation reduces 10 dB of phase noise floor. Correlations of up to 10,000-times produces a 20 dB phase noise sensitivity improvement.

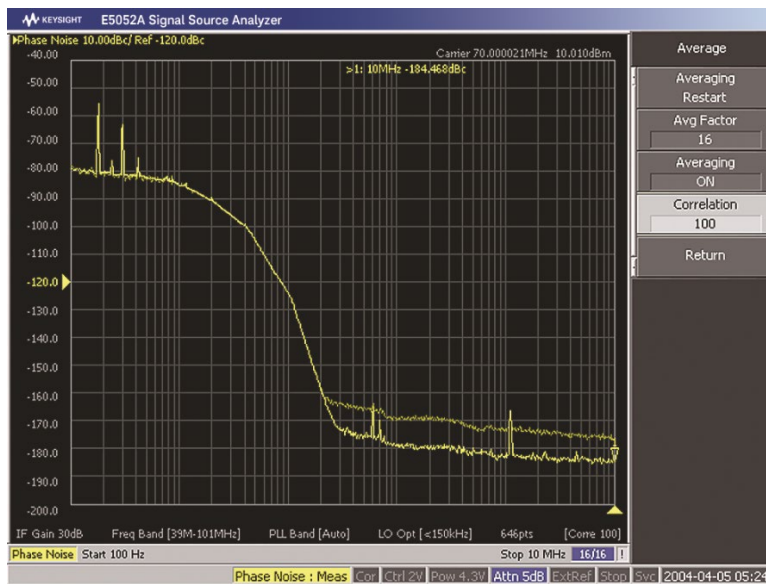

Cross-correlation technique enhances phase noise sensitivity.

Trace integration and jitter conversion offers quick and accurate jitter analysis

Integrated phase noise between two points specified by the band marker function can be automatically calculated. Both rms jitter and residual FM are also displayed. This function allows you to evaluate the noise contribution in the communication channels or the random jitter of clock sources quickly and accurately. When compared to oscilloscopes, the SSA provides better sensitivity of random jitter measurements (as low as femto second). Optional E5001A Precision Clock Jitter Analysis Software offers more usability on jitter evaluation such as RJ/PJ separation, jitter trend and histogram. (See page 22)

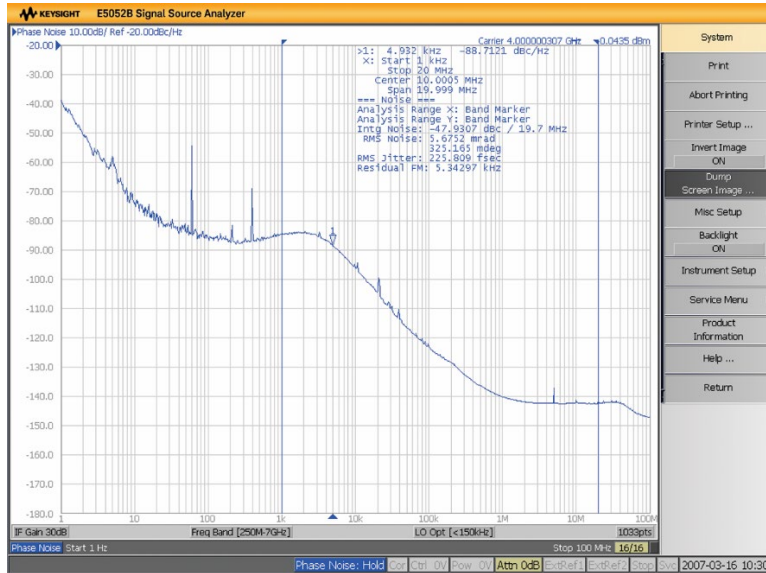

SSA phase noise to jitter conversion analysis. (Inverted color screen shown)

Outstanding low-noise DC sources provide accuracy and flexibility

The Signal Source Analyzer provides and controls the DC power supply as well as the DC control (tuning) voltage source. These DC sources are floated from the ground and isolated from external noise to ensure accuracy and repeatability.

In particular, the DC control voltage source supplies an ultra-low-noise DC signal ($1\text{nV}/\sqrt{\text{Hz}}$ at 10 kHz offset) to measure free-running voltage controlled oscillators. This enables you to make measures without a low pass filter. This is superior to the conventional methods because it reduces noise on the control signal (controlling voltage quickly), while improving flexibility and total test throughput.

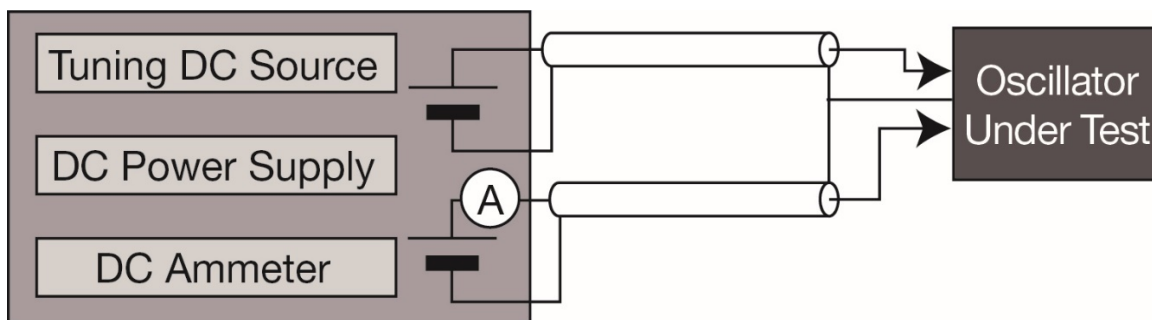

Built-in low-noise DC sources allow you to measure a voltage controlled oscillator without a low pass filter.

Versatility and performance to characterize high-speed frequency switching sources

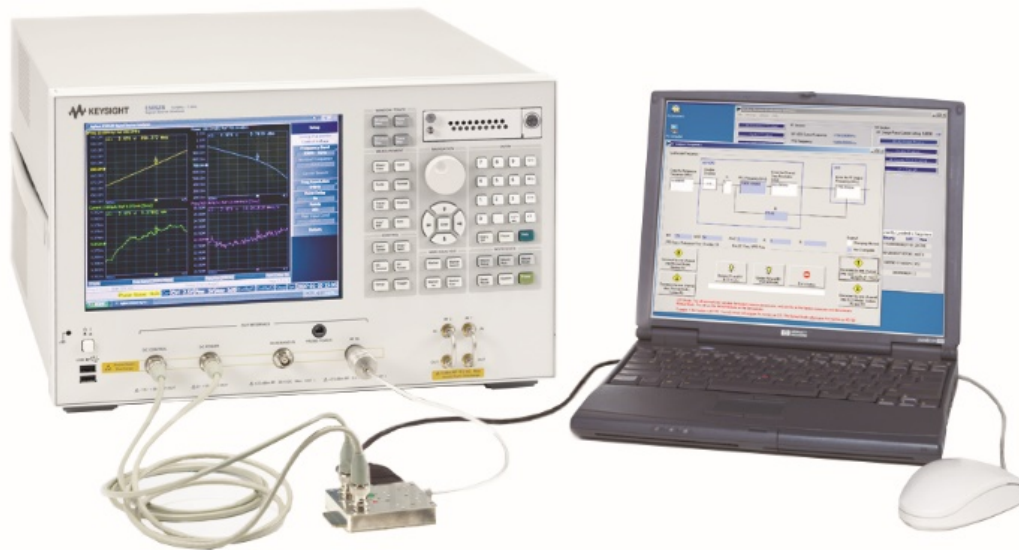

Synthesizer measurement: Multiple measurement windows provide more data and enable faster analysis.

A complete set of transient measurements

The Signal Source Analyzer provides dual channel measurements to fully characterize switching signal sources. In the wideband mode, the entire behavior of frequency jumps can be observed. In the narrowband mode, you can analyze detailed information of frequency, phase, and power over time. All of these measurements can be done simultaneously and displayed as multiple traces. This enables designers to evaluate the dynamic response of synthesizers, LO circuits, and transmitters quickly.

Better sampling rate, better frequency resolution

One of today's measurement challenges is testing fast frequency switching sources. These sources lock up within sub-micro seconds and are used in high-speed wireless data communication and aerospace/defense radars. To meet this requirement, the Signal Source Analyzer offers an 8 nsec sampling rate. This provides enhanced sampling resolution and better frequency resolution to meet the requirements of future high-speed switching source characterization (7 kHz of frequency resolution at 8 nsec sampling rate, and 0.2 Hz of frequency resolution at 8 usec sampling rate).

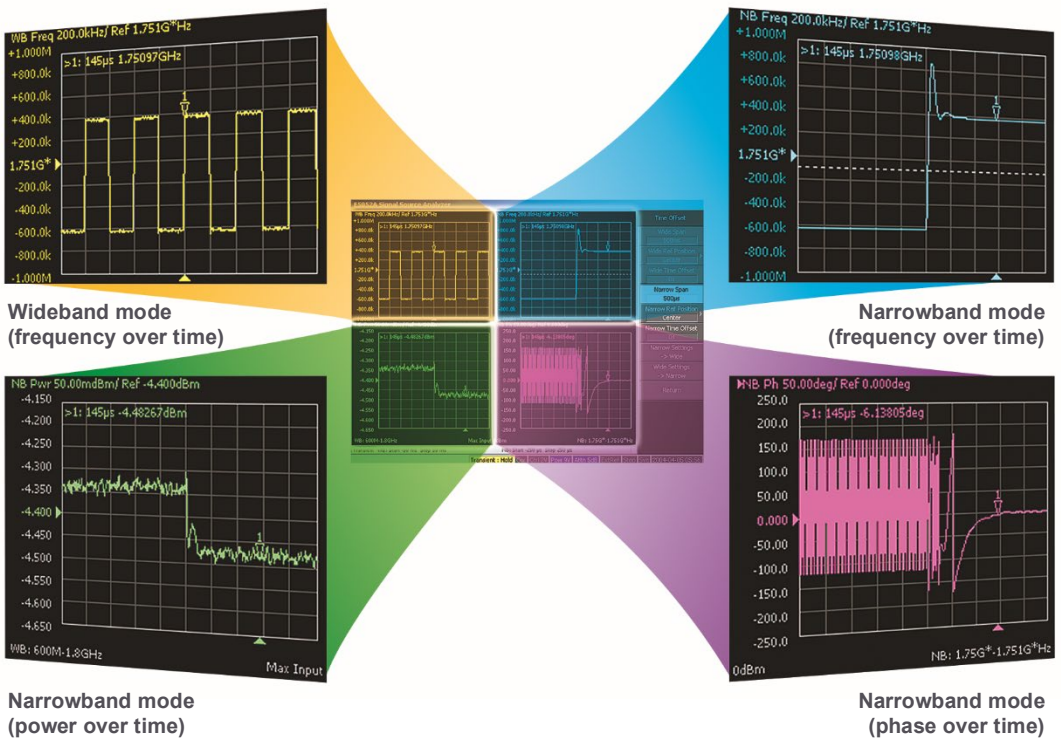

Simultaneous measurements, both in wide and narrow bandwidth, allow you to analyze detailed information of frequency, phase, and power over time.

Hardware trigger, video, and pre-trigger capabilities

The hardware trigger input port is provided with the analyzer to synchronize the source-under-test to change with the measurement trigger. Pre-trigger capability is available to observe phenomena before and after events. The enhanced video trigger capability is also useful to quickly check the behavior of frequency jumps at your bench.

Powerful analysis capabilities provide valuable design insights

Powerful analysis and band marker

Measurement results require quick and clear observation. The analyzer's unique band marker function allows you to define the range of measurement data you want to analyze on the X- and the Y-axis.

In the frequency over time measurement trace, delta-Hz, percent of the y-axis reference frequency, or ppm formats are supported; as well as limit line testing. Up to 10 markers can be used on one trace to search for peak/ maximum/minimum/target values allowing for detailed analysis. Markers on all traces can be coupled in the time axis allowing you to quickly evaluate PLL's lockup time with different parameters in frequency, phase, and power simultaneously.

Spectrum monitor function

The spectrum monitor function is tuned for measuring close-in spurious measurements with up to a 15 MHz span. This function helps you check unfavorable signals such as spurious products in a PLL synthesizer very quickly. The carrier/harmonics search function provides the center frequency of the spectrum monitor to the carrier frequency automatically. This allows you to quickly check the carrier signal, as well as the harmonics of your signal.

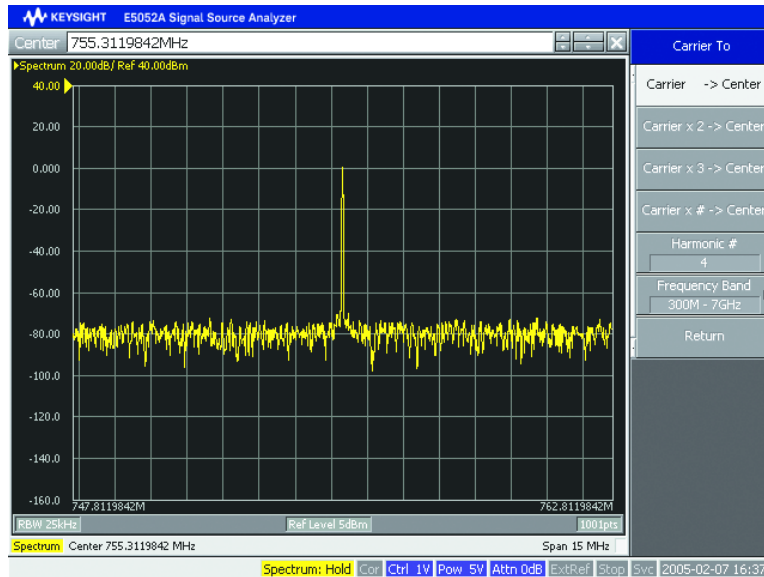

Now you can quickly check close-in-carrier spurious in a PLL synthesizer with the spectrum monitor function.



Limit line and pass/fail testing display.

AM noise and Baseband noise measurements

Besides precise phase noise measurement capability, the signal source analyzer features an AM noise measurement mode and a Baseband measurement mode to investigate efficiently potential noise causes on RF signal sources.

AM noise can be measured with the same connection as phase noise measuring at the RF input port.

Low frequency noise (1 Hz to 100 MHz) can be measured at the BNC baseband input port with AC coupled 50 ohm impedance.

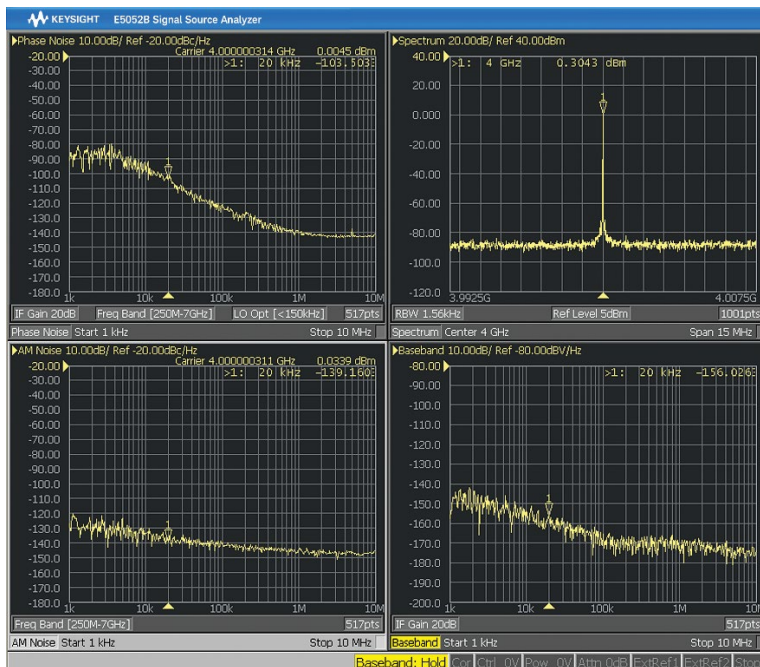

PM/AM/Baseband noise spectrum and signal monitoring at a glance.

Oscillator characterization made easy

Measure a wide variety of oscillator characteristics

The Signal Source Analyzer's frequency, power, and DC current measurement functions are tuned for characterizing oscillators (from fixed to voltage controlled oscillators). Frequency, RF power, and DC current (at DC power voltage port) measurements are synchronized with the voltage sweep on either DC control voltage or DC power voltage. The trace curve of each parameter is shown on the display with a single cabling hookup. The following parameters can be measured:

- Frequency versus DC control (tuning) voltage
- Tuning sensitivity (differential of frequency versus DC tuning voltage)
- Frequency versus DC power voltage
- Frequency pushing (differential of frequency versus DC power voltage)
- RF power versus DC control (tuning) voltage
- RF power versus DC power voltage
- DC current (at DC power voltage port)

Real-time monitoring of frequency, RF power, and DC current

The “tester mode” provides real-time monitoring of frequency, RF power, and DC current (at DC power voltage port). The numerical data appears on the display like a frequency counter, power meter, and DC ammeter, enabling high-speed manufacturing test in a single point measurement.

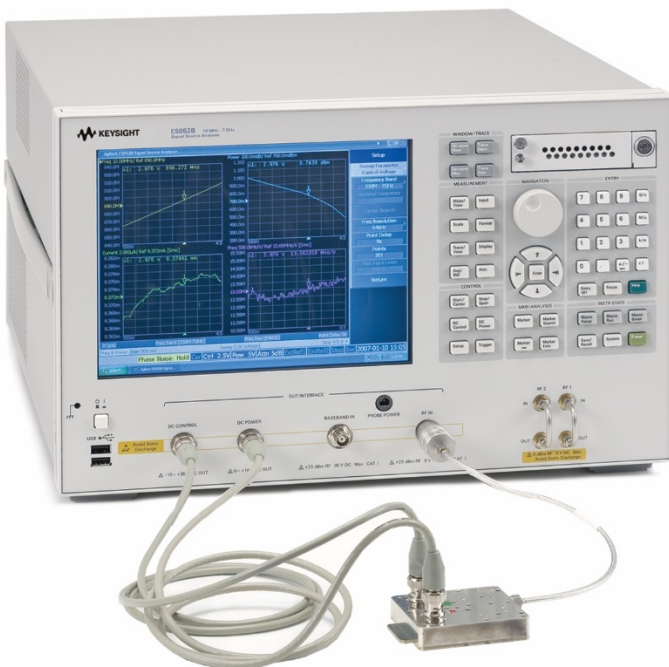

A true single-connection measurement for a voltage controlled oscillator speeds set-up time.

Oscillator characterization is comprehensive and simple

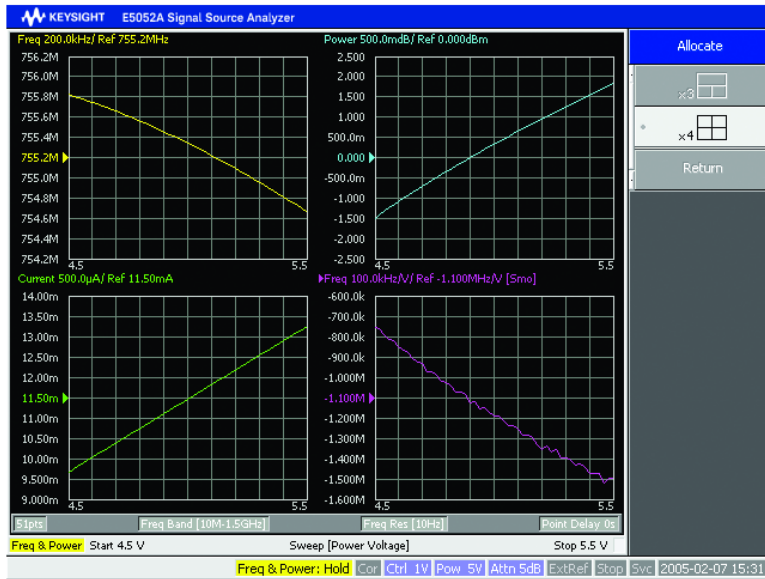

SSA analyzer mode



Tester mode display

Exceeding expectations in productivity with enhanced usability

Modern connectivity and flexible programming

Design characterization often requires you to analyze measured data on an external PC. The Signal Source Analyzer allows you to easily connect to external PCs, additional test equipment and other peripherals such as keyboards, mice, and printers through GPIB, LAN and USB ports.

The Signal Source Analyzer is equipped with various interfaces to help you maximize productivity, such as different views for measurement results and external test equipment controls. It is easily controlled from an external PC using your preferred programming language and method such as Socket or SIDL over LAN. A USB-TMC (type-B) port is also available.



Intuitive operation

A large 10.4-inch LCD display (1,024 x 768 resolution) provides a clear view of multiple traces in multiple windows. In addition, a touch screen eases interactive operation and minimizes operational errors.

Dedicated keys are available to select and maximize a display window or trace, allowing you to quickly enlarge measurement results.

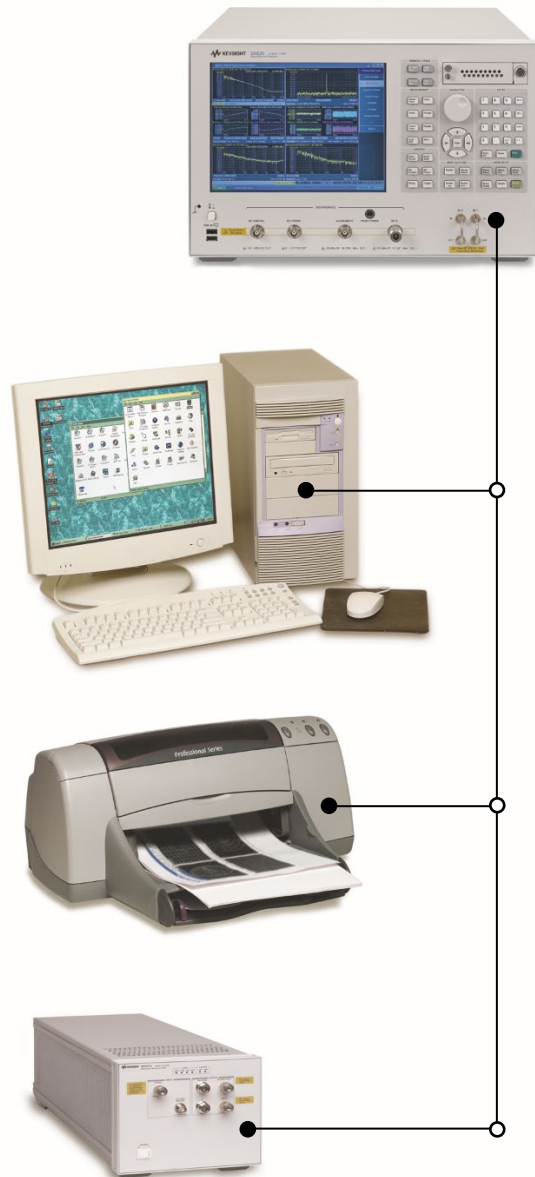

The Signal Source Analyzer supports a variety of I/O interfaces to provide maximum flexibility.

Gain a competitive advantage with powerful automation tools

Fast, accurate and integrated

The Signal Source Analyzer offers unparalleled performance. With fast, high-quality, repeatable measurements it's well-suited for the demanding requirements of high-speed manufacturing test. All this performance provides an integrated solution to help simplify your test procedures. Unlike "rack and stack" measurement systems, this comprehensive solution is compact, easy-to-use and saves valuable space on the manufacturing floor. Windows operating system environment provides more flexibility for automation.



The Signal Source Analyzer provides unprecedented simplicity to maximize your productivity.

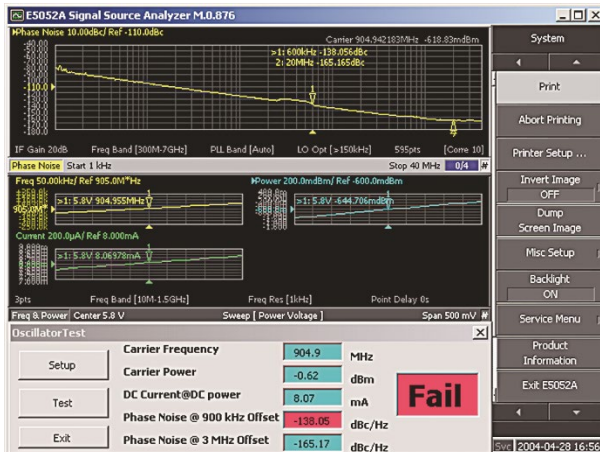

```

Dim freq As Variant, power As Variant, dci As Var
Dim pn1 As Variant, pn2 As Variant, pn3 As Variar
Dim i As Integer

Private Sub InitializeSSA_Click()

    ' Display setup
    SCPI.DISPLAY.ENABLE = True

    ' setup phase noise mode

    SCPI.SENSE.ATTenuation.LEVel = 0

    SCPI.SENSE.PN.FBAnd = "Band3"
    SCPI.SENSE.PN.IFGain = 0
    SCPI.SENSE.PN.CORrelation.Count = 1
    SCPI.SENSE.PN(1).PILBandwidth = "AUTO"

    SCPI.TRIGger.PN.Source = "INT"
    SCPI.INITiate.PN.CONTinuous = False

    SCPI.SENSE.PN(1).FREquency.START = 1000
    
```

Built-in VBA allows you to tailor and automate measurements to speed your test time.

Powerful built-in VBA for customization

Signal Source Analyzer's built-in VBA® programming function allows you to automate measurement procedures and easily create a graphic user interface, tailored to your measurement needs. In addition, test programs can be developed using a built-in editor.

Automation to reduce your test time

Automated test is yet another method to eliminate valuable seconds from your test processes. Use the analyzer's flexible automation environment to simplify your measurement procedures and lower your cost of test. A 24-bit interface is provided for faster handshaking with parts handler and can be customized using SCPI commands for your automated test environment needs.

Key Specifications¹

E5052A Signal Source Analyzer	
Frequency range	10 MHz to 7 GHz 10 MHz to 26.5 GHz with E5053A (up to 110 GHz with an external downconverter and harmonic mixers)
Input power level	-20 dBm to +20 dBm (RF > 30 MHz) -15 dBm to +20 dBm (RF < 30 MHz)
Measurement Parameters	
Frequency, RF power, and DC current	
Measurement parameters:	
Tester mode	
Frequency, RF power, DC current	
Analyzer mode (standard model ONLY)	
Frequency versus DC control voltage (tuning sensitivity)	
Frequency versus DC power voltage (frequency pushing)	
RF power versus DC control or power voltage	
DC current versus DC control or power voltage	
<hr/>	
RF power	
Resolution:	0.01 dB
Accuracy:	±0.5 dB (RF: 30 MHz to 3 GHz, > -10 dBm), ±1 dB
<hr/>	
Frequency	
Resolution:	10 Hz, 1 kHz, 64 kHz
Accuracy:	± (frequency resolution + time base accuracy)
<hr/>	
Phase noise	
Offset frequency range:	1 Hz to 100 MHz (standard model) 10 Hz to 100 MHz (Option E5052B-011)
Phase noise sensitivity:	See figures on phase noise plots (SPD)
Enhanced phase noise sensitivity technique:	Cross-correlation (1 to 10,000 times) Up to 20 dB improvement (standard model ONLY)
Accuracy:	±3 dB at 100 Hz to 1 kHz offset ±2 dB at 1 kHz to 40 MHz offset ±3 dB at 40 MHz to 100 MHz offset
Measurement time: ²	0.05 sec (1 kHz to 100 MHz offset) 0.41 sec (100 Hz to 100 MHz offset) 3.3 sec (10 Hz to 100 MHz offset) 12.9 sec (1 Hz to 100 MHz offset)

Transient

Measurement parameters:	Frequency over time, phase over time, power over time
Time span:	10 usec to 10 sec, 1, 2, 5 step
Time resolution:	8 nsec minimum
Input frequency range:	50 MHz to 7 GHz (wideband mode) 10 MHz to 7 GHz (narrowband mode)
Transient frequency range:	Frequency min.: Frequency max. = 1: 3 (wideband mode), 80 MHz, 25.6 MHz, 1.6 MHz, 200 kHz, 25 kHz, or 3.125 kHz (narrowband mode)

Narrowband mode frequency resolution:

3.125 kHz band:	0.0004 Hz to 0.01 Hz
25 kHz band:	0.01 Hz to 0.2 Hz
200 kHz band:	0.2 Hz to 5 Hz
1.6 MHz band:	5 Hz to 110 Hz
25.6 MHz band:	0.3 kHz to 7 kHz
80 MHz band:	0.9 kHz to 7 kHz
Phase transient accuracy:	0.1 deg/GHz (0.1 deg min.)
Power transient accuracy:	±2 dB
Resolution:	0.01 dB

Spectrum monitor 15 MHz max Span, RBW = 1 Hz to 100 kHz

DC sources:

Control voltage (Vc):	-15 to +35 volt, 20 mAmax
Power voltage (Vs):	0 to 16 volt, 80 mAmax
Noise density:	1nV/√Hz at 10 kHz offset (Vc) 10nV/√Hz at 10 kHz offset (Vs)

1. For additional specification details see the Keysight E5052B Signal Source Analyzer Data Sheet (literature number 5989-6388EN) available on our Website: www.keysight.com/find/ssa
2. Measurement time (sec) = 0.4 (capture: normal) plus the above value x number of correlation when applying cross-correlation function (standard model ONLY). For E5052B-011, number of correlation = 1

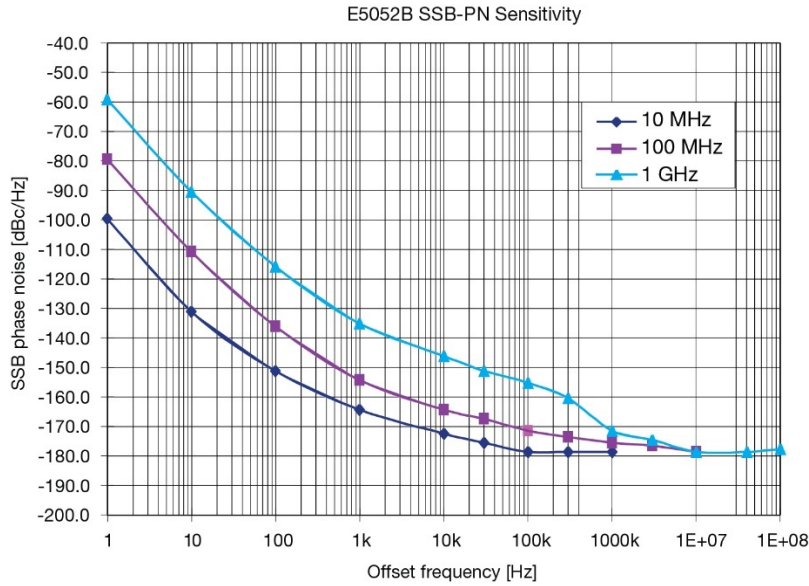

SSB phase noise sensitivity (SPD: Supplemental Performance Data) (standard, correlation = 1, start offset = 1 Hz, + 5 dBm input)

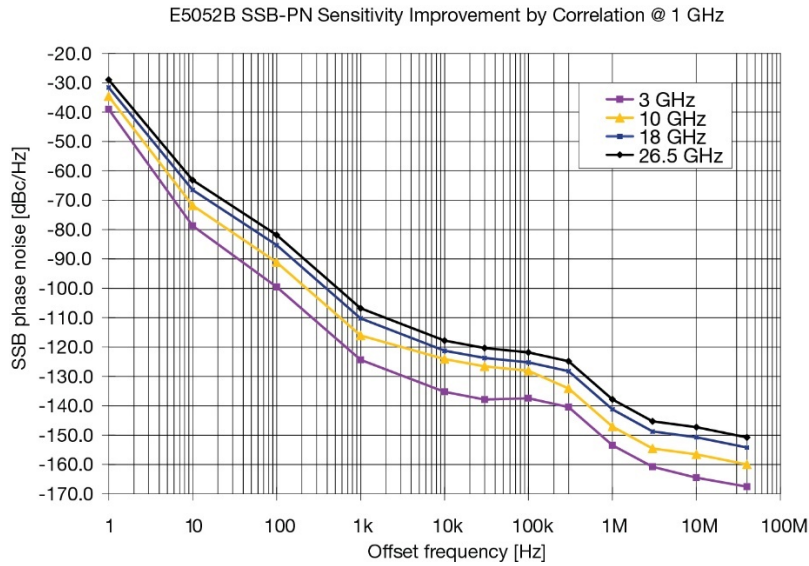

Phase noise improvement with 1, 10, 100 correlation at 1 GHz carrier (SPD)

Beyond RF to microwave and millimeter-wave frequencies

If your signal source design and test requires microwave or millimeter-wave frequencies, you can extend the frequency range of the instrument simply by adding mixers and a downconverter. Adding the E5053A Microwave Downconverter, as illustrated below, will extend your frequency range up to 26.5 GHz. Additionally, the E5053A Microwave Downconverter, used in conjunction with a pair of Keysight 11970 series harmonic mixers and an external power divider, will allow you to extend your frequency range up to 110 GHz.

The cross-correlation technique, which offers exceptional phase noise sensitivity, can also be expanded to microwave and millimeter wave frequencies. All functions of the E5052B SSA are seamlessly integrated into the instrument's user interface.



Specifications: E5052B Signal Source Analyzer with E5053A Microwave Downconverter

Key measurements	Specification
Carrier frequency range	10 MHz to 26.5 GHz, to 110 GHz ¹
Measurement Capabilities	Frequency, power, DC current, frequency versus control voltage (tuning sensitivity) frequency versus power voltage (frequency pushing), phase noise, frequency/phase/power over time (transient), spectrum
Input power range	-10 dBm to + 10 dBm
Phase noise sensitivity (typical)	See figures on phase noise plots
Transient measurement range	500 MHz max (wideband) 80 MHz, 25.6 MHz, 1.6 MHz or 200 kHz (narrowband)

1. Requires a pair of 11970 mixers and an external power divider. Please contact your local Keysight sales office for more details.

E5052B SSB-PN Sensitivity Improvement by Correlation @ 1 GHz

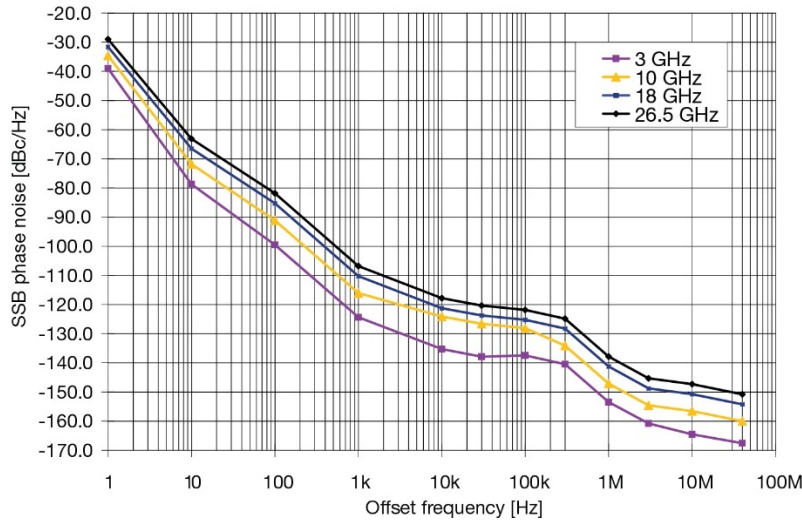

SSB phase noise sensitivity (typical performance) (standard, correlation = 1, start offset = 1 Hz)

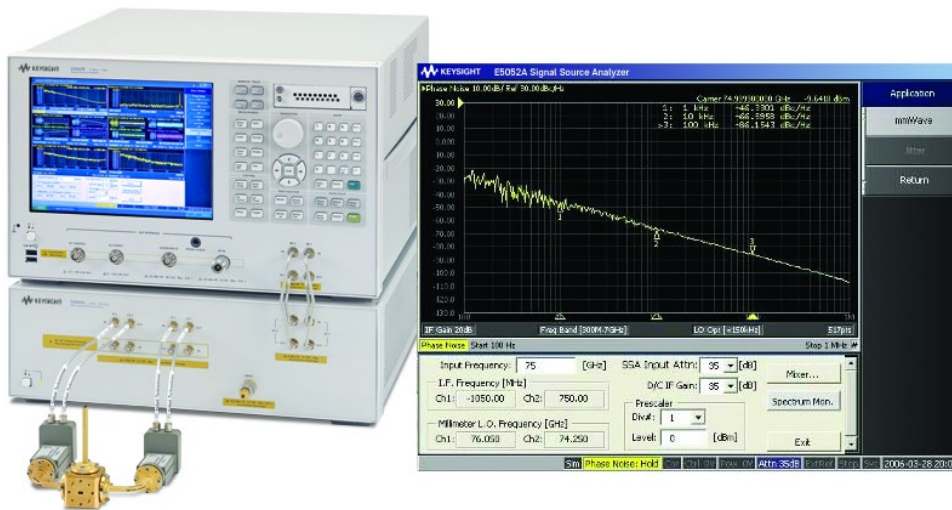

SSA millimeter wave phase noise configuration

Measurement assistant VBA

Precision clock Jitter Analysis

As the need to characterize clock jitter used in the digital communication systems increases, so increases the demand for the right measurement tools to measure jitter accurately. Keysight's E5052B Signal Source Analyzer offers a new tool delivering a powerful analysis capability on both random jitter (RJ) and periodic jitter (PJ) on a clock source. Optional E5001A Precision Clock Jitter Analysis software offers more usability by utilizing E5052B's phase noise/jitter measurement capability completely.

Ultra-low random jitter measurement through phase noise

The Keysight E5052B SSA provides exceptional low jitter measurement capability through phase noise measurement technique. For a 10 giga-bit clock rate, the random jitter noise floor reaches 9 femto seconds and representing 100 times the sensitivity of a high performance sampling oscilloscope.

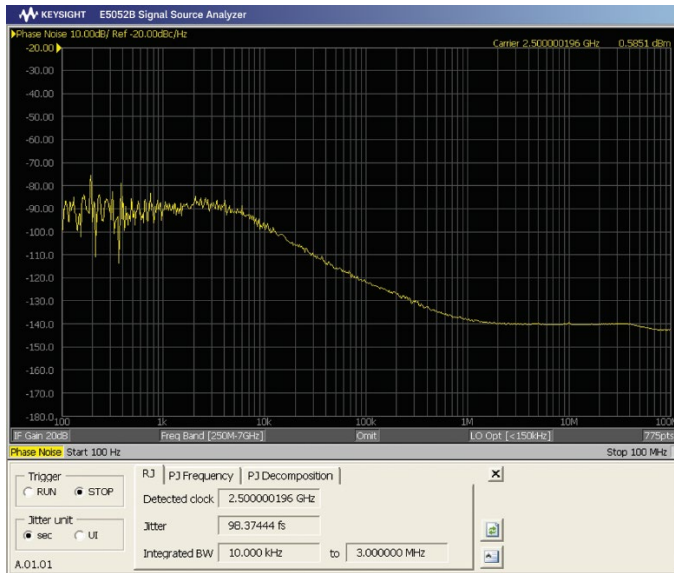

Jitter spectrum analysis

The Keysight E5052B SSA makes identifying the periodic jitter on a clock under test simple. Periodic jitter components are displayed in the PJ spectrum view. The periodic jitter frequency can help us better understand the jitter source of the periodic jitter and give more insights for designing clock signal quality better.

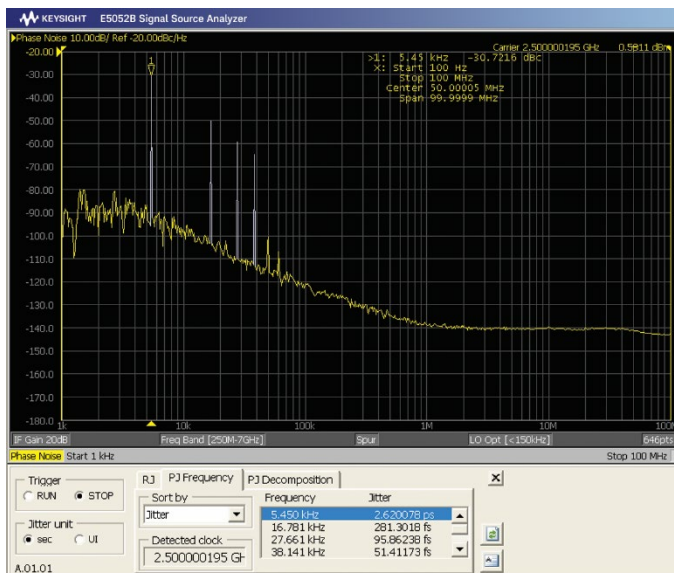

Precision RJ and PJ separation

By providing views of jitter trend, jitter histogram, and random and periodic jitter separation, you'll gain a clearer picture of your system's clock jitter characteristics enabling you to separate random jitter and periodic jitter from the total jitter on your system clock.

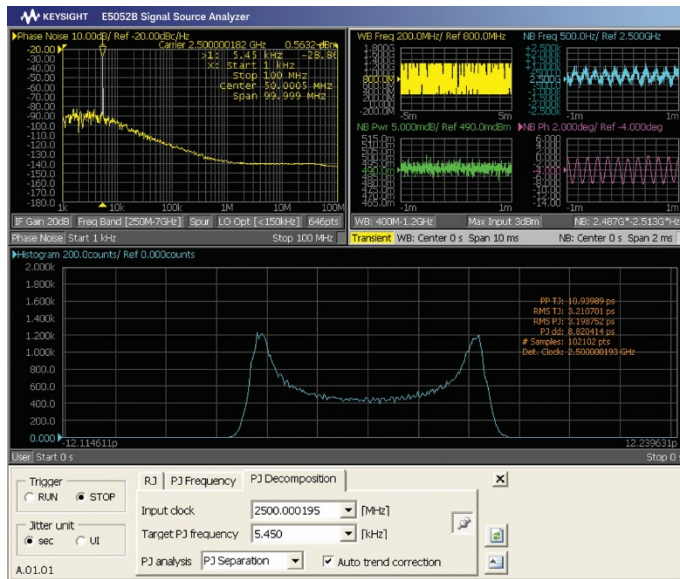

Ordering Information

Signal Source Analyzer Series

E5052B Signal Source Analyzer	10 MHz to 7 GHz
E5053A Microwave Downconverter	3 GHz to 26.5 GHz

Options

E5052B-011	Delete functions
E5052BU-058	Add removable SSD kit (For S/N MY474xxxxx)
E5052BU-041	Upgrade OS, from Windows XP to Windows 10, for E5052B
E5052BU-042	Upgrade OS, from Windows 7 to Windows 10, for E5052B
E5052BU-068	Solid state drive kit (SATA, Flex ATX, Win10)

Signal Source Analysis Software

E5001A-1FP	SSA-J Precision Clock Jitter Analysis
------------	---------------------------------------

Harmonic mixers

11970 series harmonic mixers can be used with the E5053A Microwave Downconverter or N5507A Downconverter.

11970A	26.5 to 40 GHz
11970Q	33 to 50 GHz
11970U	40 to 60 GHz
11970V	50 to 75 GHz
11970W	75 to 110 GHz

Preamplifiers

87405B	10 MHz to 4 GHz, 24 dB
87405C	100 MHz to 18 GHz, 25 dB

Accessories

82357B	USB-GPIB converter
41800A	Active Probe

Web Resources

Visit our Signal Source Analyzer Web site for additional product information and literature.

www.keysight.com/find/ssa

Phase noise measurements www.keysight.com/find/phasenoise

Learn more at: www.keysight.com

For more information on Keysight Technologies' products, applications or services, please contact your local Keysight office. The complete list is available at:

www.keysight.com/find/contactus

