

Keysight Technologies

# Implementing a Flexible Testbed for 5G Waveform Generation and Analysis

White Paper

Greg Jue, Keysight Technologies  
Sangkyo Shin, Keysight Technologies

## Abstract

A challenge of today's 5G research is the many waveforms, frequencies, and bandwidths being investigated. This includes waveforms at frequencies below 6 GHz, as well as waveforms at microwave and millimeter-wave frequencies. In addition, some of the waveforms may involve wide bandwidths. These introduce new test challenges for 5G signal generation and analysis--flexibility is key for today's 5G research. This whitepaper will discuss some of the candidate waveforms, and then introduce a new flexible testbed for 5G waveform generation and analysis. This testbed combines software solutions with test equipment to investigate and to perform "what-if" scenarios for new emerging 5G waveform applications. Co-existence scenarios between candidate 5G and 4G waveforms will be investigated. Wideband signal generation and analysis case studies will be shown at microwave and millimeter-wave frequencies with modulation bandwidths up to 2 GHz.



Unlocking Measurement Insights

## Introduction

Even as fourth-generation cellular systems—LTE and LTE-Advanced—are being deployed, research has begun on fifth-generation or 5G systems. 5G mobile networks offer a vision of “everything everywhere and always connected.”

Key attributes may include a dense, highly integrated network comprised of small cells supporting data rates on the order of 10 Gbps with roundtrip latency of 1 ms or less. Most studies assume multiple air interfaces, which will operate at microwave and millimeter frequencies. The use of high-order spatial multiplexing techniques such as MIMO will enhance capacity.

The combined network will be able to support everything from simple machine-to-machine (M2M) devices to immersive virtual-reality streaming. It will be capable of monitoring and controlling potentially billions of sensors and multiple simultaneous streaming services, and will support the massive data collection and distribution needs of the Internet of Things (IoT). In this environment, wireless data traffic is projected to increase 5000x by 2030.<sup>1</sup>

Making the leap from astonishing predictions to practical implementation starts with the creation, generation and analysis of prototype signals. Because 5G research is starting so early, the standardization process has not yet begun. Physical-layer waveforms have not been defined and, because there is no consensus on potential waveforms, several candidates are in the running: filter bank multi-carrier (FBMC), generalized frequency-division multiplexing (GFDM), universal filtered multi-carrier (UFMC), filtered orthogonal frequency-division multiplexing (F-OFDM), and many more.

That’s one reason why flexibility is paramount: it enables “what if?” analyses to be performed in the evaluation of early concepts and potential 5G waveforms that may use a variety of modulation schemes at many different frequencies and modulation bandwidths. For developers, the risk of choosing the wrong path further reinforces the need for flexibility, especially in the form of signal-creation and signal-analysis tools that enable rapid changes in direction as strong candidates emerge in the evolution of 5G.

This whitepaper describes a flexible 5G testbed that includes proven, off-the-shelf software and hardware. For signal development, the key software elements are SystemVue for simulation, what-if analysis and algorithm development, and Signal Studio for signal creation for early R&D testing. The hardware generation of test signals relies on the M8190A arbitrary waveform generator (AWG) to produce signals that drive the wideband I/Q modulation inputs of an E8267D PSG vector signal generator. Signal demodulation and analysis is performed with the 89600 VSA software, an X-Series signal analyzer and a wideband Infiniium oscilloscope.

1. IWPC Whitepaper: Evolutionary & Disruptive Visions Towards Ultra High Capacity Network, available at [www.iwpc.org](http://www.iwpc.org)

## Examining the Challenges in Design and Test

5G presents a myriad of new challenges in R&D. Some of the key discussions fall into a set of six technology characteristics<sup>2</sup>:

- 1000X higher mobile data volume per geographical area
- 10 to 100X more connected devices
- 10 to 100X higher typical user data rate
- 10X lower energy consumption
- End-to-end latency of < 1 ms
- Ubiquitous 5G access including in low density areas

Past generations of mobile technologies have typically been driven by incremental enhancements. Today, it's difficult to conceive of a new technology that can meet all six of the characteristics listed above. It seems more likely that research will take a divide-and-conquer approach to address some of the characteristics illustrated in Figure 1.

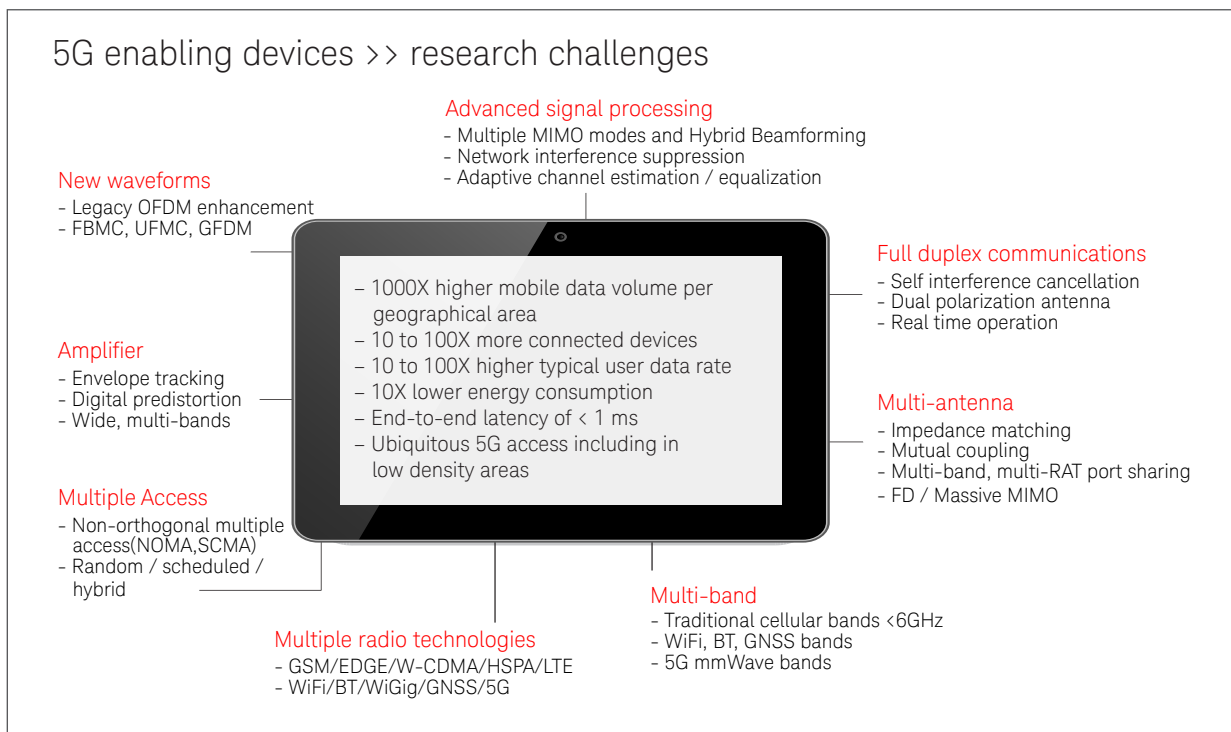

Figure 1. A variety of enabling technologies, devices and methods will be needed to achieve the six technical characteristics currently envisioned for 5G<sup>2</sup>.

Working around the diagram, new waveforms may be capable of supporting a greater density of users, higher data throughput and more efficient utilization of allocated spectrum. These waveforms may require advanced signal processing as well as adaptive channel estimation and equalization for robustness and improved immunity from interference.

Full-duplex communications may be used to improve spectral efficiency. Minimization of self-interference will contribute to better receiver sensitivity.

2. The 5G Infrastructure Public Private Partnership, details available at [www.5g-ppp.eu/kpis/](http://www.5g-ppp.eu/kpis/)

Multi-antenna technologies such as MIMO may be needed to support high data throughput, and advanced techniques such as massive MIMO and adaptive beamforming are also being investigated. Both of these, MIMO and adaptive beamforming, may require sophisticated algorithms.

It may be necessary to support multiple frequency bands with new and legacy radio access technologies (RAT), including 5G millimeter-wave frequency band extensions for high data throughput applications. Multiple access modes may be required, including non-orthogonal multiple access (NOMA) and random, scheduled and hybrid modes.

Finally, new waveforms, multiple frequency bands, wide bandwidths and higher-order modulation may present new challenges for power amplifier (PA) designs and may require new PA digital pre-distortion (DPD) techniques.

Coping with this array of challenges will benefit from a paradigm shift in design verification and testing during the early stages of research and development.

## Exploring the Candidate Waveforms

The pursuit of higher data throughput is a constant in the evolution of wireless standards. In 5G, this points toward the use of multi-carrier waveforms, microwave frequencies, millimeter-wave frequencies and wider modulation bandwidths. Some of the desired characteristics include the following:

- Flexible and scalable
- Optimized multiple access
- Efficient usage of the allocated spectrum
- Robustness to narrowband jammers and impulse noise
- Low latency
- Simultaneous operation of synchronous and asynchronous traffic
- High spectral and temporal fragmentation
- Coexistence with legacy OFDM waveforms

Figure 2 provides a visual overview of the waveforms currently under consideration. Several of these are worth a closer look.

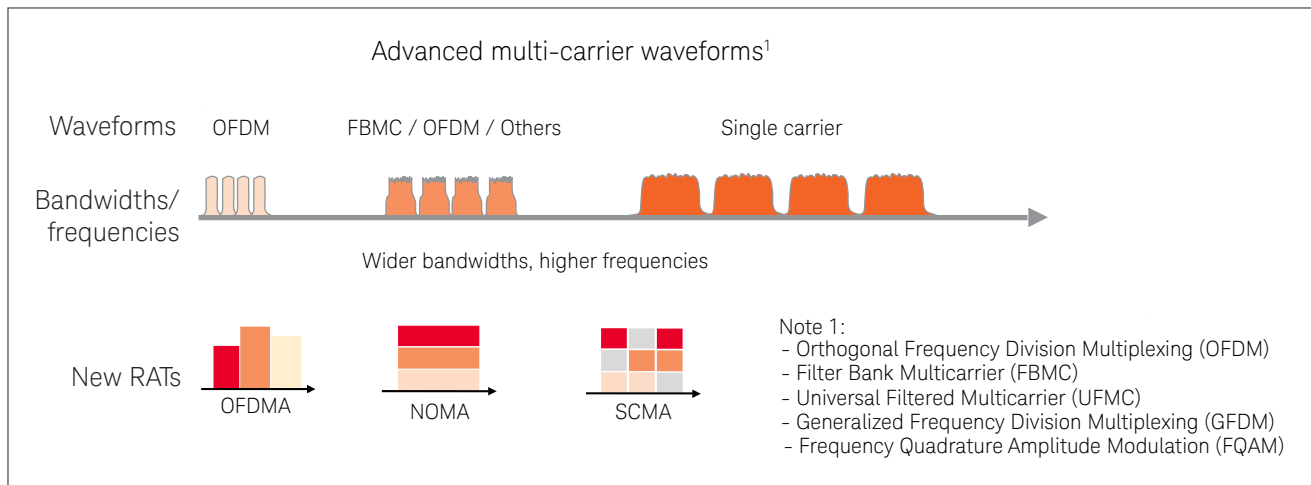

Figure 2. The candidate waveforms for 5G cover a wide range of possible approaches.

### Candidate: OFDM

Orthogonal frequency-division multiplexing (OFDM) is currently used in 4G and, for that reason and more, is under consideration for 5G through the use of filtered OFDM (F-OFDM). F-OFDM offers good spectral efficiency and resistance to multipath interference. Its subcarrier nulls correspond to the peaks of adjacent subcarriers, ensuring zero inter-carrier interference (Figure 3).

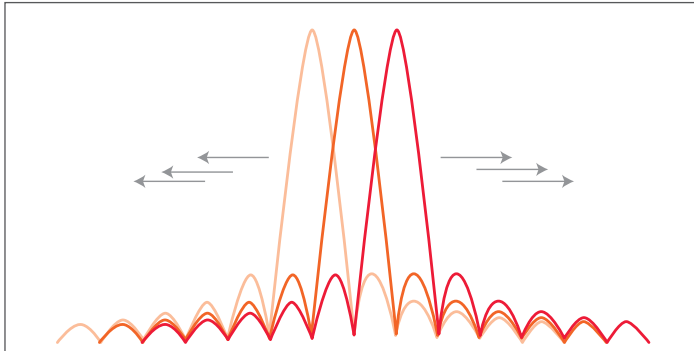

Figure 3. OFDM offers benefits such as spectral efficiency, resistance to multipath and zero inter-carrier interference.

### Candidate: FBMC

To provide improved out-of-band spectrum characteristics, FBMC applies filtering on a per-subcarrier basis. Its flexible approach to baseband filtering, using either a polyphase network or an extended IFFT, is shown in Figure 4.

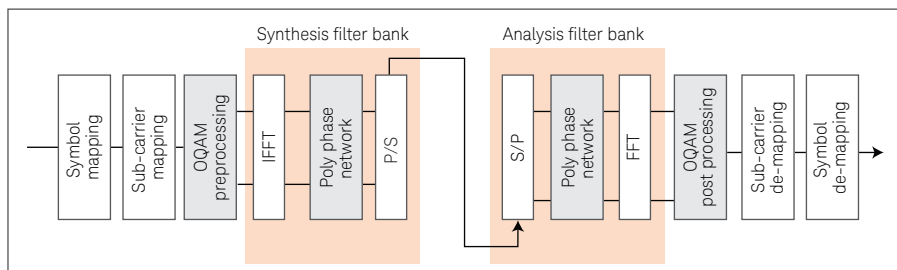

Figure 4. The filter banks in FBMC can apply filtering on a per-subcarrier basis.

Filtering can use different overlap factors (i.e., K factor) to provide varying levels of out-of-band rejection. In Figure 5, the red, blue and green traces show FBMC spectra with K factors of 4, 3 and 2, respectively. As K factor is reduced, the out-of-band characteristics have a spectrum-rejection profile similar to that of OFDM.

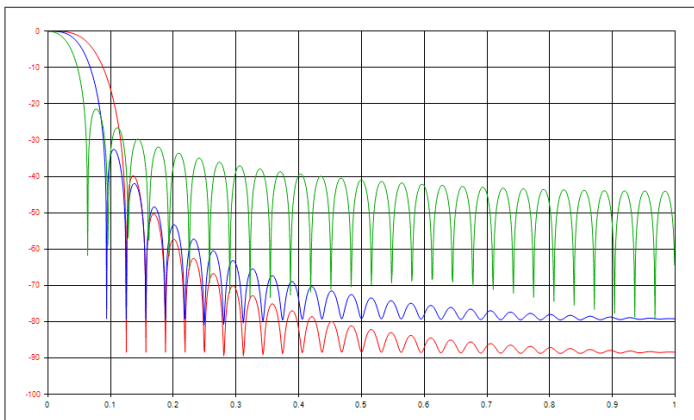

Figure 5. Changing the overlap factor (K) changes the out-of-band rejection profile of FBMC.

## Candidate: UFMC

This scheme applies filtering on a per-sub-band basis (Figure 6), and one possible benefit of UFMC is reduced complexity of the baseband algorithms. Figure 7 shows an example UFMC spectrum that was simulated using SystemVue.

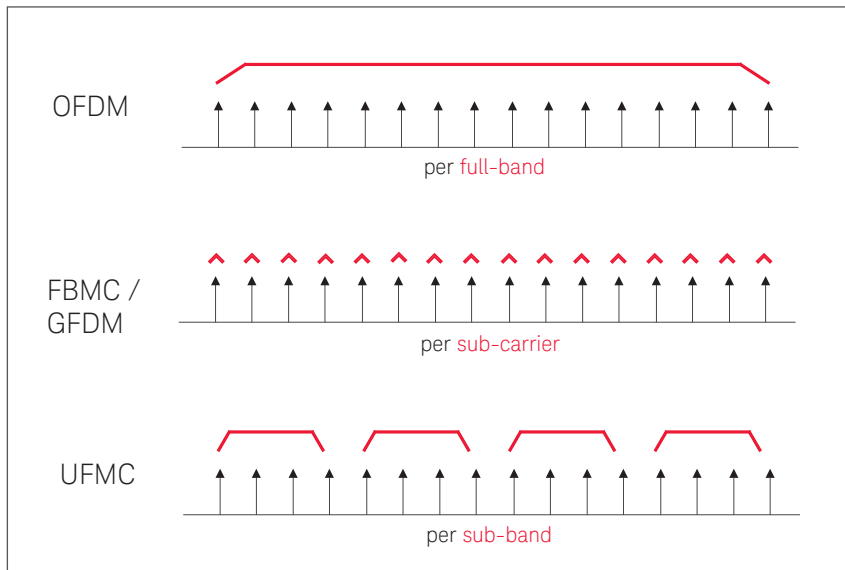

Figure 6. OFDM, FBMC and UFMC use strikingly different filtering methods.

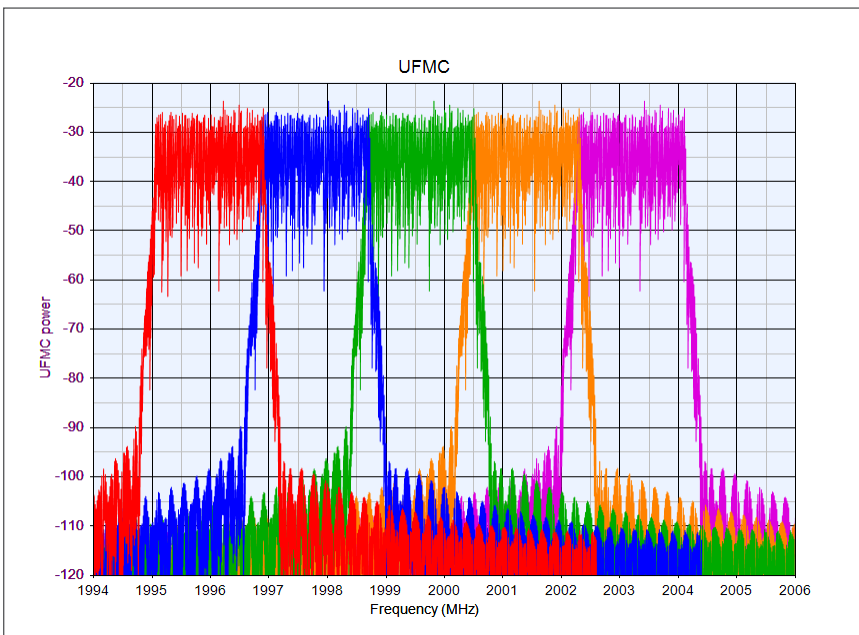

Figure 7. Created with SystemVue, this simulation of UFMC shows five multiplexed bands.

## Candidate: GFDM

This is another type of multi-carrier system, and it digitally implements the classic filter-band approach. The GFDM signal is based on a block structure of  $KM$  total data symbols ( $d_{k,m}$ ) from a specific constellation mapping. One cyclic prefix (CP) insertion for  $M$  symbols is used to allow for better spectral efficiency and less complex equalization at the receiver.

## Comparing OFDM and FBMC

Two notable drawbacks of OFDM are a loss in spectral efficiency due to cyclic prefix insertion and the presence of significant out-of-band emissions. In comparison, FBMC may offer advantages in efficient usage of allocated spectrum as well as the ability to create or occupy spectral “holes” for spectrum-sensing applications.

This can be illustrated using SystemVue with its 5G Baseband Exploration Library. Figure 8 shows simulations of OFDM (orange trace) and FBMC (blue, green and black) spectra. The FBMC spectra have different overlap factors, ranging from 2 (blue) to 4 (black), and the improvement in out-of-band spectrum power of FBMC relative to OFDM (orange) is clear.

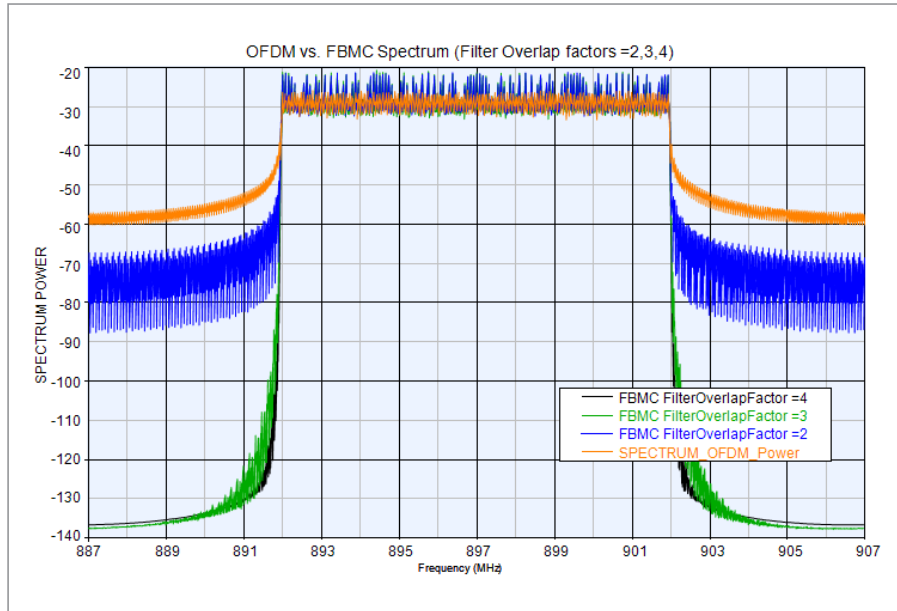

Figure 8. Using greater overlap in FBMC provides improved out-of-band power compared to OFDM.

## Assembling the Proposed Testbed

As developers experiment with those waveforms and more, a highly flexible testbed will enable them to evaluate proposed waveforms with prototype algorithms and hardware. It will also make it possible to quickly and easily transition between what-if scenarios in simulation and actual testing of the prototype algorithms and hardware.

More specifically, flexibility is needed in three key areas of 5G research and early testing:

- Generating and analyzing new waveforms
- Supporting a wide range of modulation bandwidths, from several megahertz to a few gigahertz
- Supporting a wide range of frequency bands, from RF to microwave to millimeter-wave

The proposed testbed provides this flexibility through its software and hardware elements. Software is used to create 5G and custom waveforms and also analyze those waveforms. Combining the signal-creation software with two pieces of hardware—a precision AWG and a vector signal generator with wideband I/Q inputs—enables generation of wideband test signals with up to 2 GHz of modulation bandwidth at frequencies up to 44 GHz (and higher with upconverters). For signal demodulation and analysis, VSA software can be used inside the simulation software and can run on a signal analyzer, an oscilloscope or a PC controlling a variety of instruments or digitizers. Figure 9 shows a conceptual arrangement of the software and hardware elements.

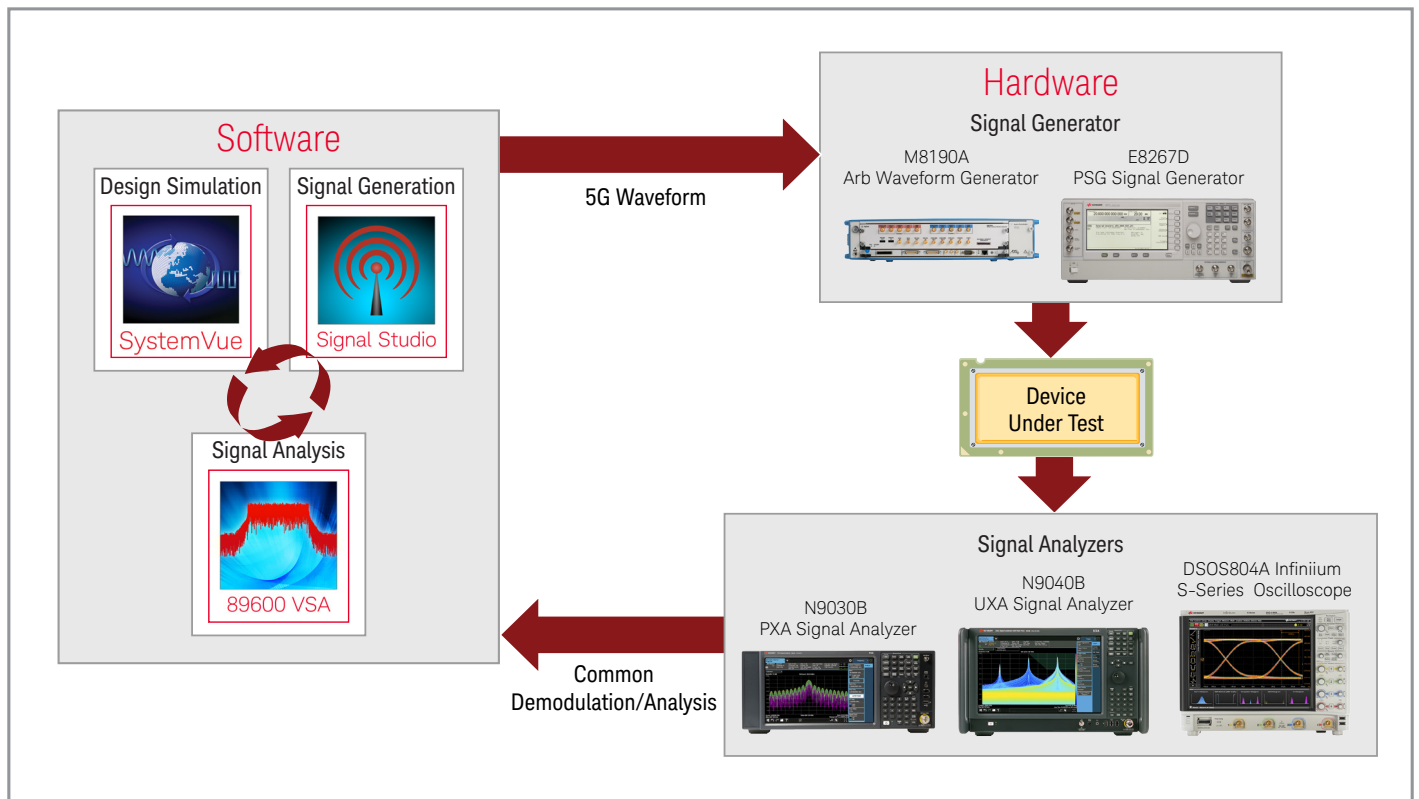

Figure 9. Hardware plus software plus a skilled developer leads to new insights in 5G.



## Assembling the Proposed Testbed (continued)

Figure 10 shows the proposed combination of software and hardware elements from Keysight.

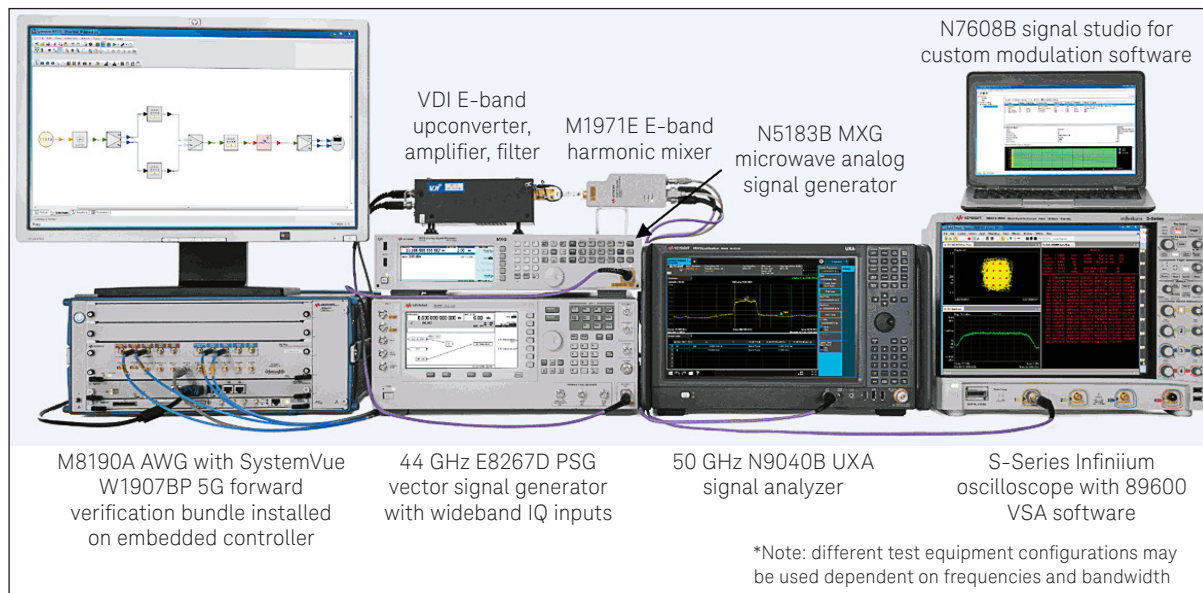

Figure 10. This combination of instrumentation and hardware provides a tremendous amount of flexibility in the exploration of possible 5G technologies.

## The software elements

Within the testbed hardware, the M8190A AWG is installed in an AXIe chassis that also contains an embedded controller. Two software elements run on that controller: SystemVue with the W1907BP 5G Forward Verification Bundle and N7608B Signal Studio for custom modulation.

SystemVue supports the simulation of candidate 5G waveforms as well as custom OFDM and I/Q waveforms that can be used to evaluate custom or proprietary algorithms. Although SystemVue is primarily used for system design and algorithm development, it can also download waveforms to the M8190A AWG.

Signal Studio for custom modulation has a parameterized graphical user interface (GUI) that makes it easy to create custom FBMC, UFMC, GFDM, F-OFDM, I/Q, and OFDM waveforms. Custom OFDM and custom I/Q VSA setup files can be saved for EVM testing using a variety of Keysight signal analyzers and oscilloscopes. Signal Studio can also be used to generate waveforms for the M8190A AWG and download waveforms to a trio of vector signal generators: the microwave E8267D PSG and the RF N5182B MXG and N5172B EXG.

89600 VSA software provides custom I/Q (option BHK) and custom OFDM (option BHF) demodulation analysis. As noted above, it can be used within SystemVue, will run inside a variety of Keysight signal analyzers and oscilloscopes, and can be run on a standalone PC connected to a variety of Keysight instruments. Signal Studio for custom modulation works with 89600/BHK for custom I/Q modulation analysis and 89600/BHF for custom OFDM analysis as companions for signal generation and analysis.

## The hardware elements

The M8190A is a two-channel precision AWG that can operate with 14-bit resolution at up to 8 GSa/s or 12-bit resolution up to 12 GSa/s. It has 5 GHz of analog bandwidth and 2 GSa of memory per channel.

The AWG is used to drive an E8267D PSG vector signal generator equipped with wideband differential external I/Q inputs (option 016). The wideband inputs can produce modulation bandwidths of up to 2 GHz on carrier signals up to 44 GHz. For signal generation at millimeter-wave frequencies, upconverters are available from Keysight (58–64 GHz with N5152A) and Virginia Diodes Inc. (60 GHz to 90 GHz). MXG microwave analog signal generators (N5183B) are used to provide the LOs for the millimeter-wave upconverters.

A Keysight N9040B UXA or N9030B PXA signal analyzer is used for spectrum analysis and demodulation analysis. A Keysight DSOS804A Infiniium S-Series oscilloscope with 89600 VSA software is used for multi-gigahertz demodulation analysis at millimeter-wave frequencies when combined with the M1971E harmonic mixer and X-Series signal analyzer.

This is an example configuration that can be used for RF, microwave and millimeter-wave signal generation and analysis. The best hardware configuration for a specific application depends on the actual frequencies, bandwidths and waveforms of interest. In some cases the recommended solution may include simplified instrument configurations and fewer instruments.

## Applying the Testbed: Four Case Studies

The versatility of the testbed enables it to address a variety of likely scenarios at RF, microwave and millimeter frequencies. These cases help illustrate the versatility of the testbed.<sup>3</sup>

### RF case study: Examining the coexistence of LTE and FBMC (< 6 GHz)

Generation of LTE and FBMC signals was accomplished using the SystemVue schematic shown in Figure 11. The two signals were resampled and combined into a composite waveform that was downloaded into the M8190A AWG. The output of the AWG was analyzed using a PXA signal analyzer and the 89600 VSA software.

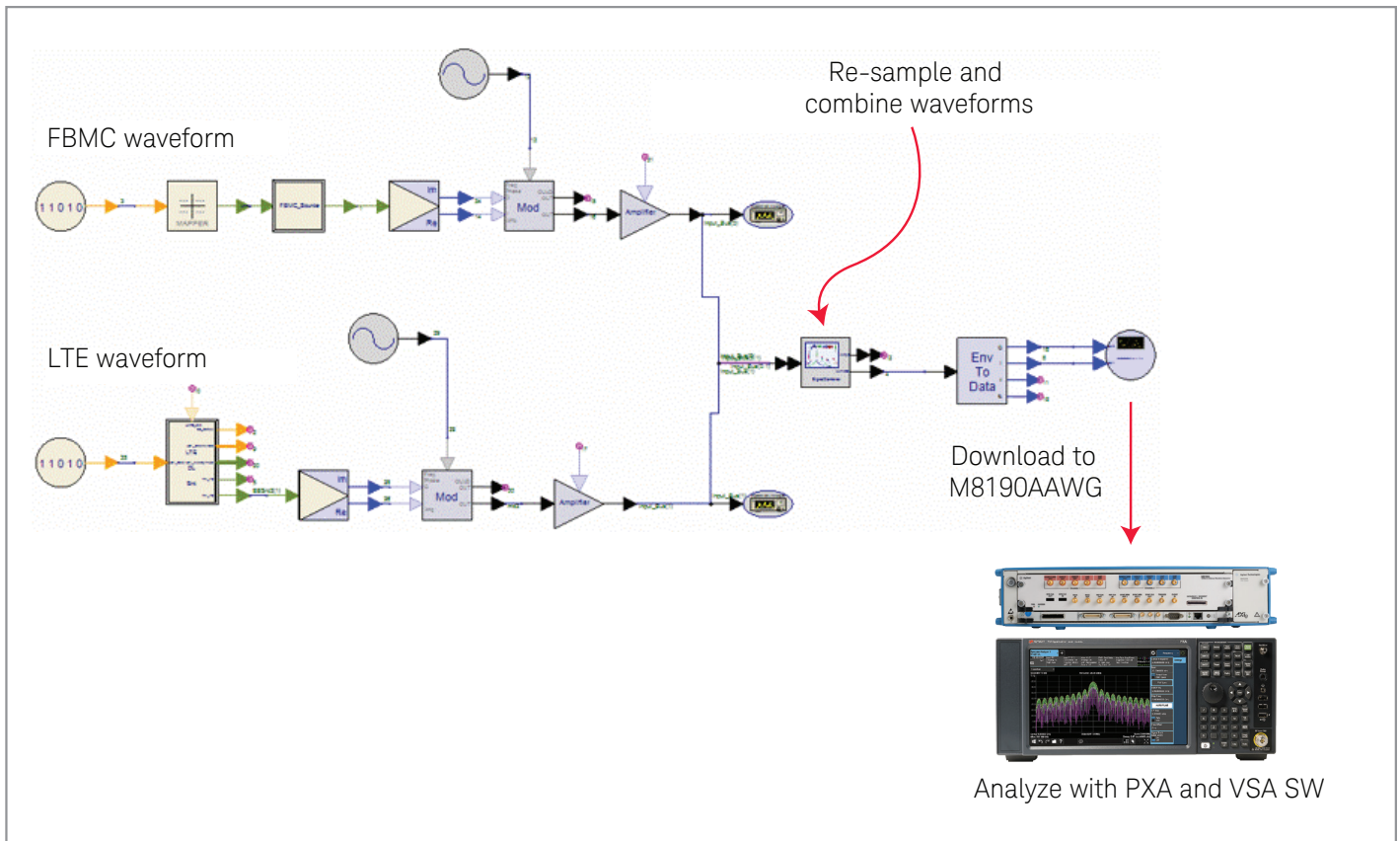

Figure 11. FBMC and LTE signals can be created in SystemVue and the composite waveform downloaded to the AWG.

3. One note: the technologies, waveforms, frequencies and bandwidths in these examples are used only to demonstrate the flexibility of this testbed approach, not as a recommendation of their suitability for 5G.

Figure 12 shows the resulting test signals, as measured with the PXA. Notice the sharp out-of-band spectrum roll-off of the FBMC spectrum compared to that of the LTE spectrum. This is due to the per-subcarrier filtering applied to the FBMC signal.

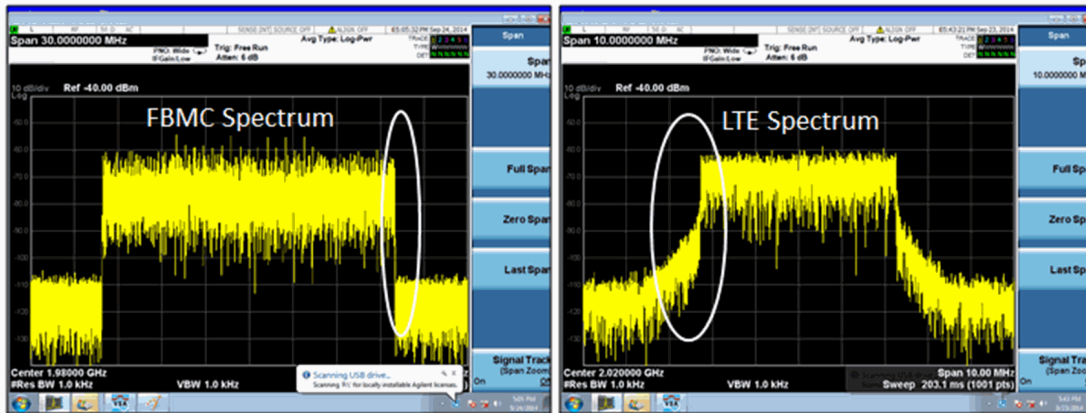

Figure 12. The out-of-band advantages of FBMC are clear when compared to LTE.

To evaluate the coexistence of LTE in the presence of FBMC, the test scenario was modified in SystemVue to notch out some of the active subcarriers in the FBMC signal. The LTE center frequency was then set to match the notched center frequency (Figure 13). One note: the composite LTE/FBMC waveform was produced using a single output channel of the M8190A; it did not require two separate signal generators.

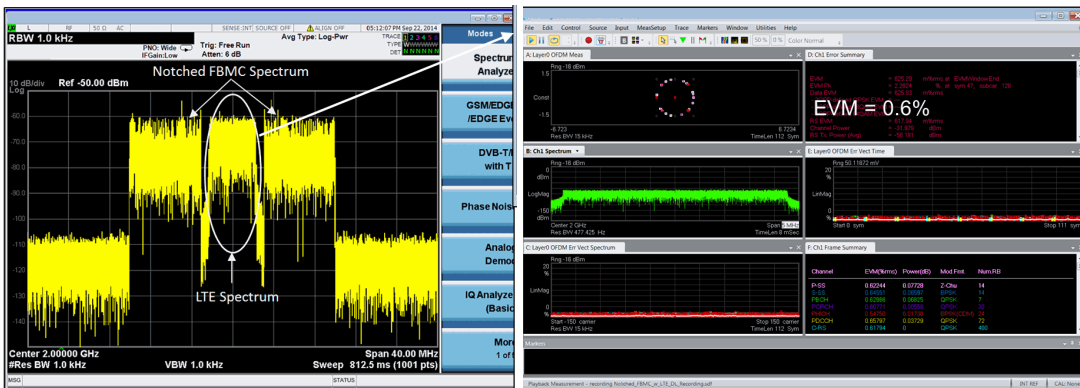

Figure 13. The LTE signal resides in the center of the notched FBMC spectrum.

The upper-right trace in Figure 13 was produced using the 89600 VSA software. It demodulated the LTE signal and calculated an EVM of 0.6%, which indicates that the FBMC out-of-band characteristics are having a minimal effect on the LTE signal with this notched arrangement.

The notch width is easily modified and the LTE EVM can be evaluated as a function of width based on the number of subcarriers and the resulting width in megahertz. Figure 14 shows a range of LTE EVM results relative to FBMC notch width. This is one example of a what-if scenario that can be easily evaluated with the testbed.

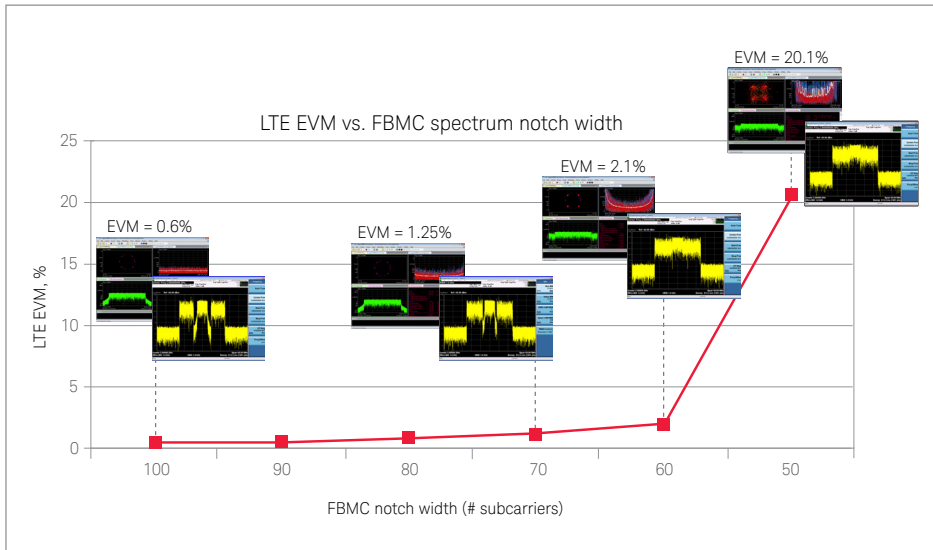

Figure 14. LTE EVM gets worse as the width of the notch decreases.

### RF case study: Examining 5G candidate waveform coexistence with 3G, 4G, and PAN waveforms (< 6 GHz)

The previously described LTE and FBMC coexistence scenario is extended to include additional candidate 5G waveforms GFDM, OFDM, UFMC, as well as legacy 3G and 4G waveforms GSM, EDGE, W-CDMA, WLAN, and ZigBee.

In this scenario, four different 5G candidate waveforms FBMC, GFDM, OFDM, UFMC and an LTE 4G waveform are re-sampled and combined in simulation into one composite waveform and downloaded to channel 1 on the M8190A AWG (Figure 15).

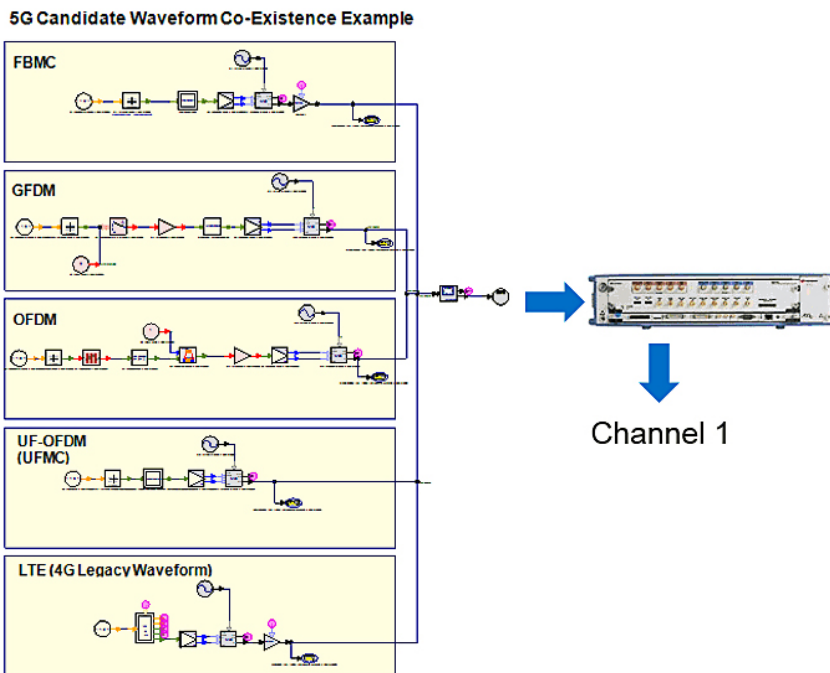

Figure 15. Candidate 5G waveforms and LTE (4G) waveform downloaded to channel 1 on the M8190A AWG

Channel 2 of the M8190A AWG plays the legacy 3G, 4G, and PAN waveforms (Figure 16). Six different waveforms are re-sampled and combined (LTE, EDGE, GSM, W-CDMA, WLAN, and ZigBee). The LTE, EDGE, GSM, and W-CDMA waveforms use model and file-based sources in SystemVue, however the WLAN and ZigBee sources use the 89600 VSA source to read in recorded .sdf files into SystemVue. The 86900 VSA software can be used with test equipment to capture real-world recordings (.sdf files), and those recordings can be read into SystemVue. MATLAB code can also be co-simulated in SystemVue, so this approach offers the flexibility of combining many different types of signals together in simulation, and re-sampling them to combine them together to download a composite waveform to the M8190A AWG.

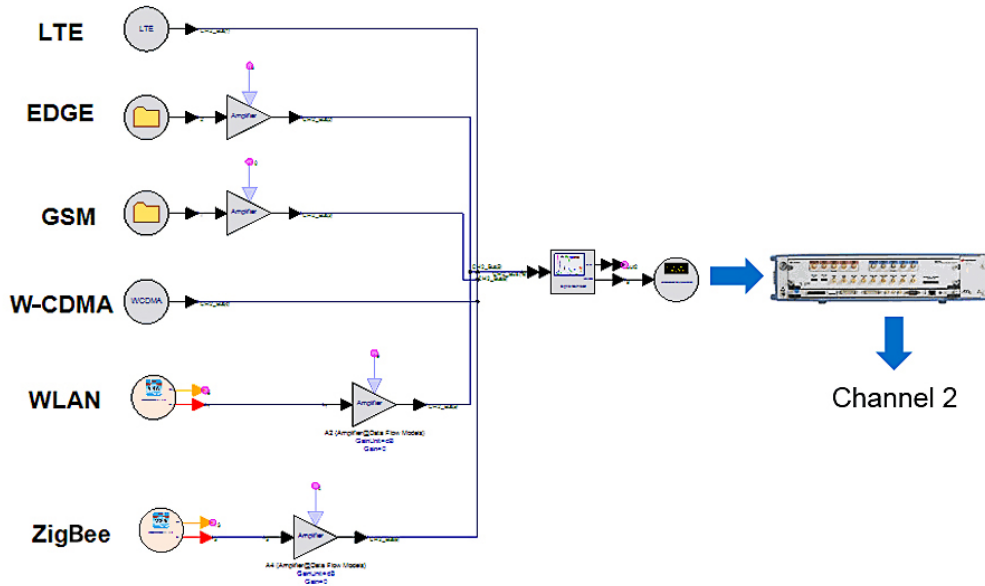

Figure 16. Legacy 3G, 4G, and PAN waveforms downloaded to channel 2 on the M8190A AWG

Channel 1 of the M8190A AWG plays the candidate 5G waveforms and LTE 4G waveform. Channel 2 of the M8190A AWG plays the legacy 3G, 4G, and PAN waveforms. These are combined together with an external power splitter (used as a power combiner) and the resulting combined output spectrum is shown in Figure 17.

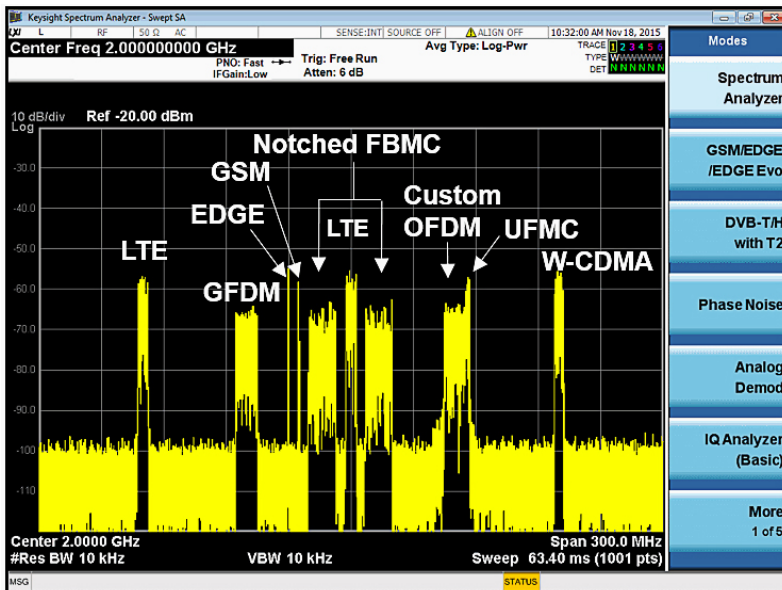

Figure 17. Candidate 5G waveforms and legacy 3G and 4G waveforms (PAN waveforms are not shown for this frequency span setting).



The 89600 VSA software is then used on the PXA signal analyzer to tune into each 3G, 4G, and PAN waveform to perform the demodulation and measure the EVM. The measured EVMs are low, even though the composite waveform includes many different types of signals.



Figure 18. Demodulation of the legacy 3G, 4G, and PAN waveforms using the 89600 VSA software

## Microwave case study: Wide-bandwidth signal generation and analysis (28 GHz)

As noted earlier, the testbed can be used to generate and analyze wideband waveforms with modulation bandwidths of up to 2 GHz at microwave frequencies. In this case, the combination of an M8190A AWG and an E8267D PSG vector signal generator with wideband I/Q inputs can be used to produce wideband microwave test signals up to 44 GHz.

A wideband FBMC signal was generated at 28 GHz with a 1 GHz modulation bandwidth using Signal Studio for custom modulation. Parameters such as the number of frames, sampling rate and oversampling rate were set using the software's parameterized graphical user interface (GUI). FBMC-OQAM waveform parameters such as FFT length, guard subcarriers (upper and lower), number of multi-carrier symbols and idle interval can also be set. The essential FBMC filter settings—K factor and filter-bank structure—can also be entered (Figure 19).

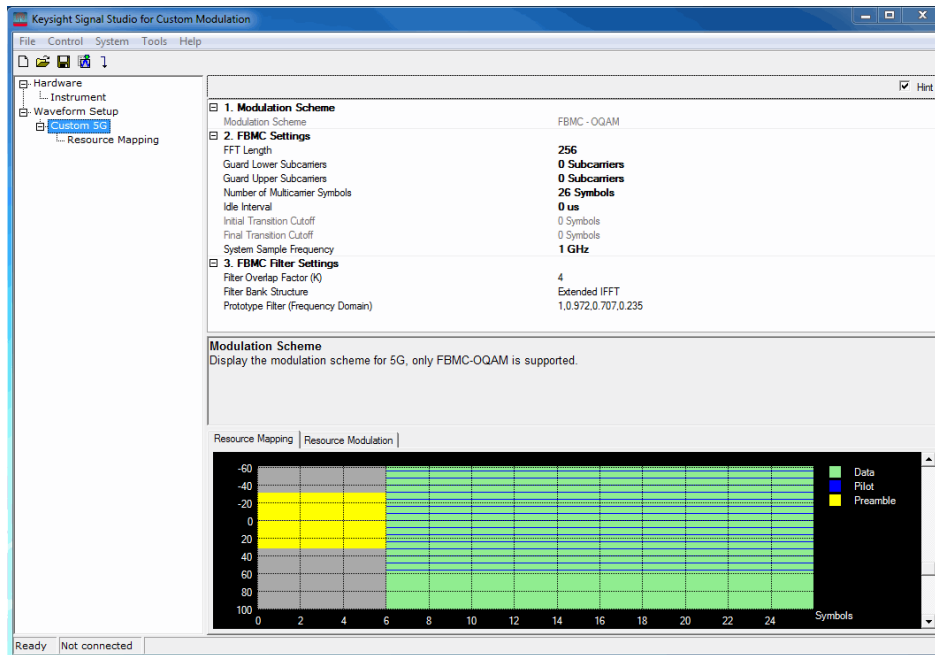

Figure 19. The Signal Studio for custom modulation GUI makes it easy to enter the complete set of FBMC parameters.



The resulting test signal is shown in Figure 20: the spectrum was centered at 28 GHz and the measurement span was 1.2 GHz, as measured with a 63 GHz Infiniium oscilloscope.

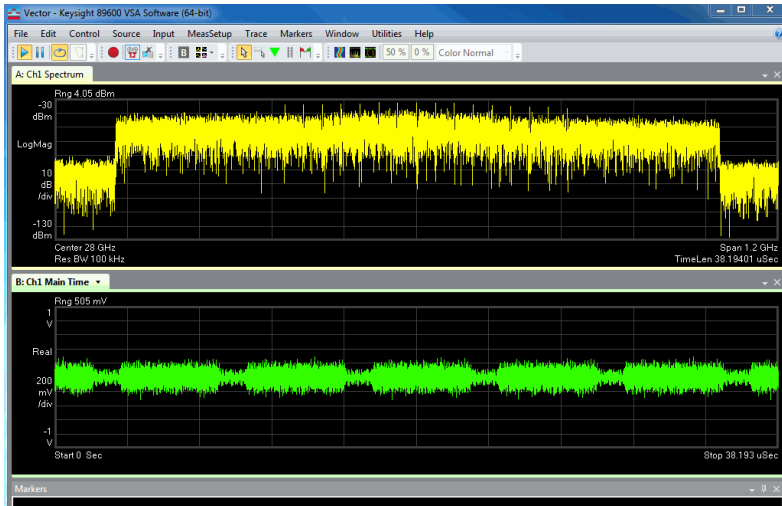

Figure 20. Signal Studio for custom modulation simplifies creation of FBMC waveforms.

Similarly, Signal Studio for custom modulation was used to create an OFDM waveform with ~1 GHz modulation bandwidth at 28 GHz. The GUI was used to set the essential parameters (e.g., number of frames, etc.). In addition, resource-mapping parameters were set for the preamble, pilot and data subcarriers, including the location and boosting of each resource block. I/Q values were set for the preamble, modulation and payload for pilot and data.

The resulting test signal is shown in Figure 21 in a six-trace display:

- Upper left: constellation
- Upper middle: EVM versus subcarrier
- Upper right: Search time
- Lower left: ~1 GHz wide spectrum at 28 GHz center frequency
- Lower middle: error summary
- Lower right: OFDM equalizer channel frequency response



Figure 21. This display from the 89600 VSA software provides multiple views of the demodulated OFDM signal, measured with a 63 GHz Infiniium oscilloscope.

## Millimeter-wave case study: Wide-bandwidth single-carrier modulation (73 GHz)

This example used a hardware configuration similar to the one shown in Figure 10. SystemVue was used to generate a wideband waveform with a 2 GHz symbol rate, 4x oversampling and a sample rate of 8 GSa/s. The waveform was downloaded to the M8190A AWG and its outputs were connected to the wideband I/Q inputs of the PSG vector signal generator. The PSG produced a signal at 6 GHz and this was translated to 73 GHz using a VDI E-band upconverter. An MXG analog signal generator provided the LO signal for the upconverter.

For 5G applications that use bandwidths of up to 2 GHz, it is important to consider the potential for amplitude and phase variations that can adversely affect signal quality. At these frequencies, linear errors in amplitude and phase may be caused within the signal chain: M8190A, PSG, cables, upconverter, cables and interconnects. These were reduced by deriving the necessary vector corrections using the adaptive equalizer in the 89600 VSA software. The equalizer produces a complex-valued frequency response that can be used to minimize amplitude and phase errors. This is done by reading the frequency response into SystemVue and using it to correct the waveform response (Figure 22).

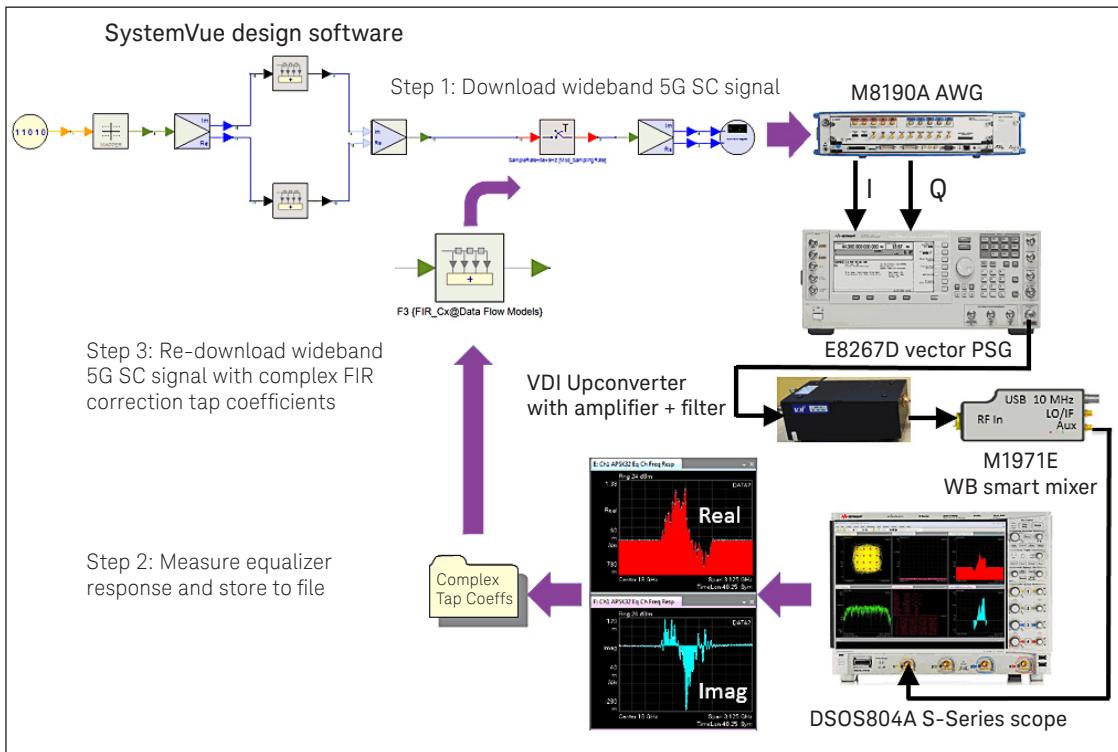

Figure 22. The frequency response produced by the adaptive equalizer can be used to compensate for linear amplitude and phase errors in the test signal.

Figure 23 shows the demodulation analysis of a vector-corrected signal at 73 GHz. Note that demodulating a 2 GHz wideband signal is typically quite difficult without adaptive equalization due to hardware impairments across the wide bandwidth. However, in this example the linear errors in amplitude and phase were corrected in simulation to generate a corrected waveform that produced a low EVM without adaptive equalization.

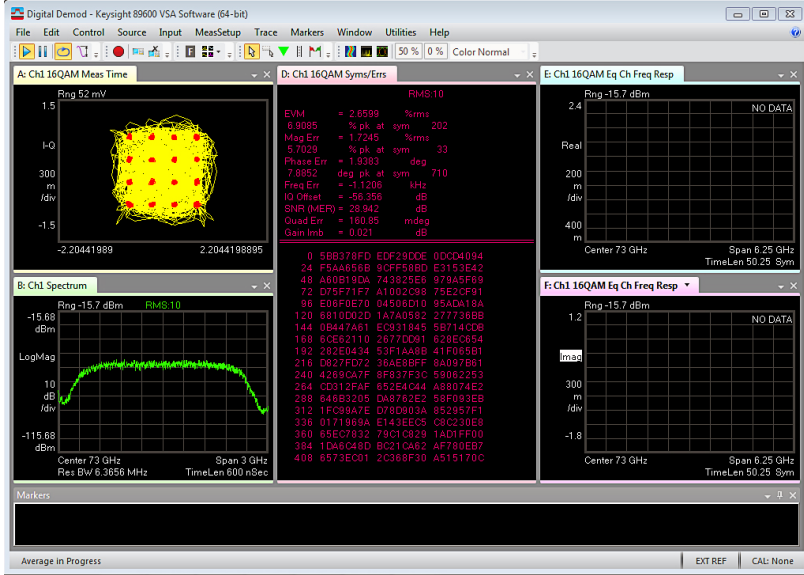

Figure 23. The demodulation results reveal the improvements provided by error compensation. Note: uses constellation maximum as the EVM normalization reference.

## Moving Forward

The development of 5G includes an aggressive set of characteristics that will be difficult to achieve. To help developers address the inherent challenges and quickly respond to changes in direction, Keysight's proposed testbed includes software and hardware elements that provide the flexibility needed to explore waveforms, algorithms and techniques. Because the testbed is based on off-the-shelf instruments and software, it provides accurate and repeatable results in what-if simulations and actual measurements of prototype devices.

Just as 5G is a work in progress, so is the proposed testbed. To stay abreast of the latest developments, please contact your local Keysight representative or visit our website at [www.keysight.com/find/5G](http://www.keysight.com/find/5G).

## References

| Title  | Publication number |
|--|--------------------|
| <i>SystemVue Electronic System-Level (ESL) Design Software - Brochure</i>        | 5992-0106EN        |
| <i>W1906BEL 5G Baseband Exploration Library - Data Sheet</i>                     | 5992-0218EN        |
| <i>Brochure: Simplify Signal Creation with Signal Studio Software - Brochure</i> | 5989-6448EN        |
| <i>N7608B Signal Studio for Custom Modulation - Technical Overview</i>           | 5992-0048EN        |
| <i>89600 VSA software - Brochure</i>   | 5990-6553EN        |
| <i>89601B/BN-AYA Vector Modulation Analysis - Technical Overview</i>             | 5990-6387EN        |
| <i>89601B/BN-BHF Custom OFDM Modulation Analysis - Technical Overview</i>        | 5990-6625EN        |
| <i>89601B/BN-BHK Custom I/Q Modulation Analysis - Technical Overview</i>         | 5991-4221EN        |
| <i>M8190A Arbitrary Waveform Generator - Data Sheet</i>                          | 5990-7516EN        |
| <i>PSG Signal Generators - Data Sheet</i>  | 5989-1324EN        |
| <i>X-Series Signal Generators - Technical Overview</i>                           | 5990-9957EN        |
| <i>N9040B UXA X-Series Signal Analyzer - Brochure</i>                            | 5992-0089EN        |
| <i>N9040B UXA X-Series Signal Analyzer - Data Sheet</i>                          | 5992-0090EN        |
| <i>N9030B PXA X-Series Signal Analyzer - Data Sheet</i>                          | 5992-1317EN        |
| <i>Infiniium S-Series Oscilloscopes - Data Sheet</i>                             | 5991-3904EN        |

## Evolving Since 1939

Our unique combination of hardware, software, services, and people can help you reach your next breakthrough. We are unlocking the future of technology.

From Hewlett-Packard to Agilent to Keysight.

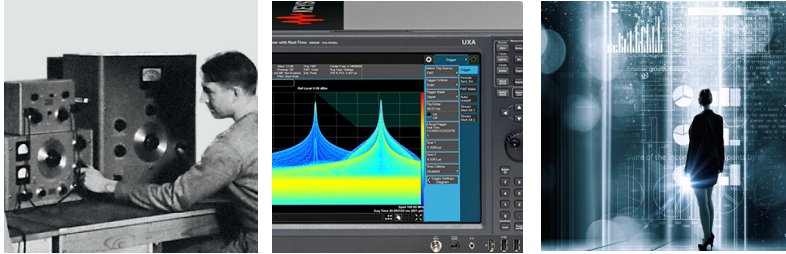

For more information on Keysight Technologies' products, applications or services, please contact your local Keysight office. The complete list is available at: [www.keysight.com/find/contactus](http://www.keysight.com/find/contactus)

### Americas

|               |                  |
|---------------|------------------|
| Canada        | (877) 894 4414   |
| Brazil        | 55 11 3351 7010  |
| Mexico        | 001 800 254 2440 |
| United States | (800) 829 4444   |

### Asia Pacific

|                    |                |
|--------------------|----------------|
| Australia          | 1 800 629 485  |
| China              | 800 810 0189   |
| Hong Kong          | 800 938 693    |
| India              | 1 800 11 2626  |
| Japan              | 0120 (421) 345 |
| Korea              | 080 769 0800   |
| Malaysia           | 1 800 888 848  |
| Singapore          | 1 800 375 8100 |
| Taiwan             | 0800 047 866   |
| Other AP Countries | (65) 6375 8100 |

### Europe & Middle East

|                |               |
|----------------|---------------|
| Austria        | 0800 001122   |
| Belgium        | 0800 58580    |
| Finland        | 0800 523252   |
| France         | 0805 980333   |
| Germany        | 0800 6270999  |
| Ireland        | 1800 832700   |
| Israel         | 1 809 343051  |
| Italy          | 800 599100    |
| Luxembourg     | +32 800 58580 |
| Netherlands    | 0800 0233200  |
| Russia         | 8800 5009286  |
| Spain          | 800 000154    |
| Sweden         | 0200 882255   |
| Switzerland    | 0800 805353   |
|                | Opt. 1 (DE)   |
|                | Opt. 2 (FR)   |
|                | Opt. 3 (IT)   |
| United Kingdom | 0800 0260637  |

For other unlisted countries: [www.keysight.com/find/contactus](http://www.keysight.com/find/contactus) (BP-9-7-17)

**DEKRA Certified**  
ISO 9001 Quality Management System

[www.keysight.com/go/quality](http://www.keysight.com/go/quality)  
Keysight Technologies, Inc.  
DEKRA Certified ISO 9001:2015  
Quality Management System

### myKeysight

#### myKeysight

[www.keysight.com/find/mykeysight](http://www.keysight.com/find/mykeysight)

A personalized view into the information most relevant to you.

[http://www.keysight.com/find/emt\\_product\\_registration](http://www.keysight.com/find/emt_product_registration)

Register your products to get up-to-date product information and find warranty information.

### KEYSIGHT SERVICES

Accelerate Technology Adoption.  
Lower costs.

#### Keysight Services

[www.keysight.com/find/service](http://www.keysight.com/find/service)

Keysight Services can help from acquisition to renewal across your instrument's lifecycle. Our comprehensive service offerings—one-stop calibration, repair, asset management, technology refresh, consulting, training and more—helps you improve product quality and lower costs.



#### Keysight Assurance Plans

[www.keysight.com/find/AssurancePlans](http://www.keysight.com/find/AssurancePlans)

Up to ten years of protection and no budgetary surprises to ensure your instruments are operating to specification, so you can rely on accurate measurements.

#### Keysight Channel Partners

[www.keysight.com/find/channelpartners](http://www.keysight.com/find/channelpartners)

Get the best of both worlds: Keysight's measurement expertise and product breadth, combined with channel partner convenience.

[www.keysight.com/find/5G-Insight](http://www.keysight.com/find/5G-Insight)

[www.keysight.com/find/solution-5Gtestbed](http://www.keysight.com/find/solution-5Gtestbed)



Unlocking Measurement Insights

This information is subject to change without notice.  
© Keysight Technologies, 2017  
Published in USA, December 1, 2017  
5992-0519EN  
[www.keysight.com](http://www.keysight.com)