

E5052B Signal Source Analyzer

10 MHz to 7 GHz, 26.5 GHz, or 110 GHz

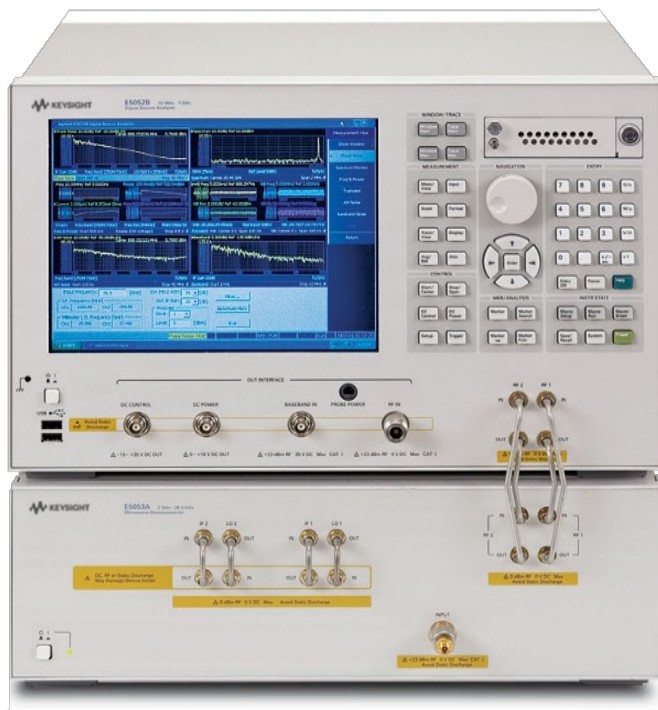

Table of Contents

Definitions.....	3
Specification (spec.).....	3
Typical (typ.).....	3
Supplemental performance data (SPD).....	3
General characteristics or nominal (nom.).....	3
RF Input Port.....	3
Phase Noise Measurement.....	4
Spectrum Monitor Measurement.....	8
Frequency and RF Power, DC Supply Current Measurements.....	9
Transient Measurement.....	10
AM Noise Measurement.....	13
Baseband Noise Measurement.....	14
Internal Timebase.....	14
General Information.....	15
EMC, safety, environment and compliance.....	17
Display Functions.....	19
Data Processing Capabilities.....	20
Optional Application Software.....	20
System Performance with the E5053A Microwave Downconverter.....	21
About “mmW application”.....	24
E5053A Microwave Downconverter Specifications and General Information Summary.....	25
Web Sources.....	29

Definitions

All specifications apply over a 23 °C ± 5 °C range (unless otherwise stated) and 30 minutes after the instrument has been turned on.

All specified and supplemental values for RF input signals are applicable to sinusoidal-wave carriers unless otherwise noted.

Specification (spec.)

Warranted performance. Specifications include guard-bands to account for the expected statistical performance distribution, measurement uncertainties, and changes in performance due to environmental conditions.

Following supplemental information is intended to provide information that is helpful for using the instrument.

Typical (typ.)

Describes performance that will be met by a minimum of 80% of all products.

Supplemental performance data (SPD)

Represents the value of a parameter that is most likely to occur; the expected mean or average.

General characteristics or nominal (nom.)

A general, descriptive term that does not imply a level of performance.

RF Input Port

Table 1-1. RF IN port

Description	Specification
RF IN connector	Type-N (female), 50 Ω nominal
RF IN frequency range	10 MHz to 7 GHz
RF IN measurement level	-20 dBm to +20 dBm (> 30 MHz) -15 dBm to +20 dBm (< 30 MHz)
Input attenuator	0 to 35 dB (in 5 dB step)
Input damage level	AC > +23 dBm, DC > 5V
Input VSWR @50 Ω	
10 MHz to 30 MHz	< 1.6
30 MHz to 2 GHz	< 1.2
2 GHz to 3 GHz	< 1.3
3 GHz to 4 GHz	< 1.3 typical
4 GHz to 7 GHz	< 1.5 typical

Phase Noise Measurement

Table 1-2. Phase noise measurement performance

Description	Specification (E5052B)	Specification (E5052B Option 011)
RF IN frequency range	10 MHz to 7 GHz	
Measurement frequency bands	10 MHz to 41 MHz, 39 MHz to 101 MHz, 99 MHz to 1.5 GHz, 250 MHz to 7 GHz ¹	
RF frequency tracking range	0.4% of carrier frequency	
Measurement parameters	SSB phase noise [dBc/Hz], Spurious noise [dBc], Integrated rms phase deviation [deg, rad] or time jitter [s], Residual FM [Hz rms]	
Number of trace	1 data trace and 1 memory trace with 'data math' functions	
Measurement trigger	continuous/single/hold source: internal/external/manual/bus	
Offset frequency range (effective)		
RF carrier signal > 1 GHz (> 400 MHz for wide capture mode)	1 Hz to 100 MHz 1 Hz to 40 MHz (wide capture mode)	10 Hz to 100 MHz 10 Hz to 40 MHz (wide capture mode)
RF carrier signal < 1 GHz (< 400 MHz for wide capture mode)	1 Hz to 10% of carrier frequency	10 Hz to 10% of carrier frequency
Phase noise uncertainty² at effective offset frequencies		
Offset 1 Hz to 10 Hz	± 4 dB (SPD)	N/A
Offset 10 Hz to 100 Hz	± 4 dB (SPD)	
Offset 100 Hz to 1 kHz	± 3 dB	
Offset 1 kHz to 40 MHz	± 2 dB (± 3 dB for wide capture range mode)	
Offset 40 MHz to 100 MHz	± 3 dB	
SSB phase noise sensitivity	See Table 1-3, 1-4, 1-5, Figure 1-1, 1-2, 1-3	
IF gain setting	0 dB to 50 dB in 10 dB step (not available in wide capture mode)	0 dB to 30 dB in 10 dB step (not available in wide capture mode)
Enhanced sensitivity	Cross-correlation method available. Number of correlation = 1 to 10,000 See Table 1-5 and Figure 1-3	N/A
Built-in LO phase noise optimization	< 150 kHz (optimized for better close-in phase noise measurement) > 150 kHz (optimized for better far-out phase noise measurement) See Figure 1-4.	
Reference oscillator bandwidth optimization	Narrow / Wide See Figure 1-5.	
Residual spurious response level	< -80 dBc (SPD) at > 10 kHz offset frequency with correlation > 120 sec. except for 23.5 MHz ± 1 MHz and 71 MHz ± 3 MHz of carrier frequency < -65 dBc (typical) at 1 kHz to 10 kHz offset frequency	
Measurement time	See Table 1-6	
Measurement range	Capture mode: Normal or Wide	

Description	Specification (E5052B)	Specification (E5052B Option 011)
PN mode (Regular)	RBW: Auto X-axis: Offset frequency in log scale	
Segment PN mode ³	RBW: 96 mHz to 25 kHz (stepped), Maximum offset frequency span: 93.2 Hz to 24.4 MHz (stepped) X-axis: Offset frequency in liner scale	N/A

1. Wide capture mode is available for 250 MHz to 7 GHz only

2. Phase noise uncertainty: specified at 10 MHz and 1 GHz of carrier frequency with 0 dBm level. PN level > -60 dBc

3. Segment PN mode is available with the firmware revision 3.20 or later. In this datasheet, specification of phase noise sensitivity, residual spurious response level and measurement time are applicable to the regular PN mode. In the segment PN mode, number of these parameters depend on the measurement setting. For more detail, refer to the user's manual.

Table 1-3. SSB phase noise sensitivity (dBc/Hz) in normal capture range mode (E5052B)

LO optimization: < 150 kHz, Ref. BW: narrow, correlation = 1, RF input: +5 dBm, start offset frequency: 1 Hz, measurement time = 12.9 sec

RF input frequency		Offset frequency [Hz] from the carrier									
		1	10	100	1 k	10 k	100 k	1 M	10 M	40 M	100 M
10 MHz	specification				-148	-156	-166	-168	-	-	-
	SPD	-100	-131	-151	-164	-172	-178	-178	-	-	-
100 MHz	specification				-147	-156	-163	-168	-170	-	-
	SPD	-80	-111	-136	-154	-164	-171	-175	-178	-	-
1 GHz	specification				-128	-137	-144	-160	-170	-168	-169
	SPD	-60	-91	-116	-135	-146	-155	-171	-178	-178	-177
3 GHz	specification				-118	-127	-133	-149	-163	-164	-165
	SPD	-50	-81	-106	-127	-135	-142	-161	-175	-177	-177
7 GHz	specification				-111	-120	-127	-143	-157	-158	-159
	SPD	-43	-74	-99	-121	-129	-138	-154	-171	-174	-175

Table 1-3-W. SSB phase noise sensitivity (dBc/Hz) in wide capture range mode (E5052B) (SPD)

LO optimization: < 150 kHz, Ref. BW: narrow, correlation = 1, RF input: +5 dBm, start offset frequency: 1 Hz, measurement time = 12.9 sec

RF input frequency		Offset frequency (Hz) from the carrier								
		1	10	100	1 k	10 k	100 k	1 M	10 M	40 M
1 GHz	SPD	-	-	-	-108	-128	-144	-155	-160	-160
3 GHz	SPD	-	-	-	-107	-119	-134	-150	-158	-158
7 GHz	SPD	-	-	-	-107	-112	-126	-146	-156	-156

Table 1-4. SSB phase noise sensitivity (dBc/Hz) in normal capture range mode (E5052B Option 011)

LO optimization: < 150 kHz, Ref. BW: narrow, correlation = 1, RF input: +5 dBm, start offset frequency: 10 Hz, measurement time = 3.3 sec

RF input frequency		Offset frequency [Hz] from the carrier								
		10	100	1 k	10 k	100 k	1 M	10 M	40 M	100 M
10 MHz	specification			-135	-147	-160	-160	-	-	-
	SPD	-120	-135	-151	-163	-170	-170	-	-	-
100 MHz	specification			-142	-152	-154	-156	-159	-	-
	SPD	-107	-128	-149	-160	-168	-170	-170	-	-
1 GHz	specification			-125	-134	-141	-157	-160	-160	-160
	SPD	-86	-111	-132	-143	-152	-168	-170	-170	-170
3 GHz	specification			-115	-124	-130	-146	-160	-160	-160
	SPD	-76	-101	-124	-132	-139	-158	-170	-170	-170
7 GHz	specification			-108	-117	-124	-140	-154	-155	-156
	SPD	-69	-94	-118	-126	-135	-151	-165	-170	-170

Table 1-5. SSB phase noise sensitivity improvement by correlation

Number of correlation	10	100	1,000	10,000
Improvement factor	5 dB	10 dB	15 dB	20 dB

Table 1-6. E5052B Typical measurement time (sec) for phase noise

LO optimization: < 150 kHz, Ref. BW: narrow, correlation = 1, RF input: +5 dBm

Stop frequency	Start frequency (Hz)			
	1	10	100	1 k
100 kHz	8.8	2.2	0.28	0.04
1 MHz	8.8	2.2	0.28	0.04
10 MHz	10	2.5	0.32	0.04
40 MHz	10	2.5	0.32	0.04
100 MHz	12.9	3.3	0.41	0.05

Measurement time (sec) = (0.4 (Capture range narrow) or 0.6 (Capture range wide)) + the above value x number of correlation when applying cross-correlation function (E5052B ONLY).

For E5052B Option 011, number of correlation = 1.

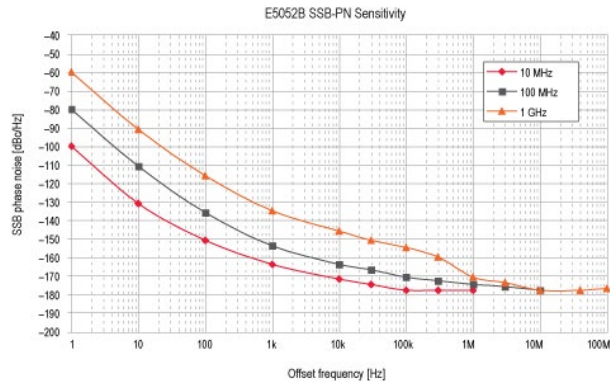

Figure 1-1. SSB phase noise sensitivity (E5052B, SPD) (LO < 150 kHz optimized, +5 dBm input, start offset frequency = 1 Hz, measurement time = 12.9 sec.)

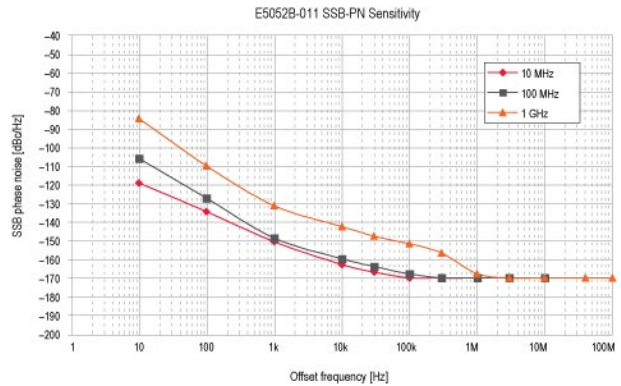

Figure 1-2. SSB phase noise sensitivity (E5052B Option 011, SPD) (LO < 150 kHz optimized, +5 dBm input, start offset frequency = 10 Hz, measurement time = 3.3 sec.)

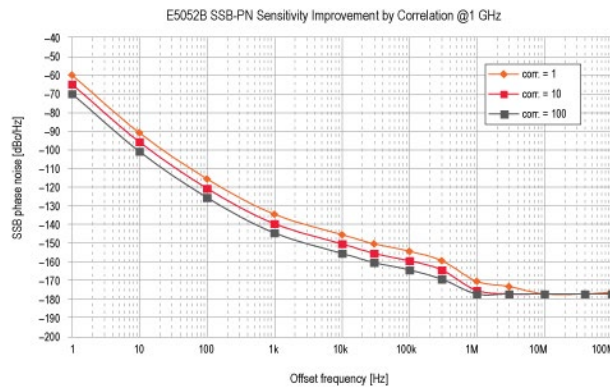

Figure 1-3. SSB phase noise sensitivity improvement by correlation (E5052B, SPD) (carrier 1 GHz, LO < 150 kHz optimized, +5 dBm input, start offset frequency = 1 Hz)

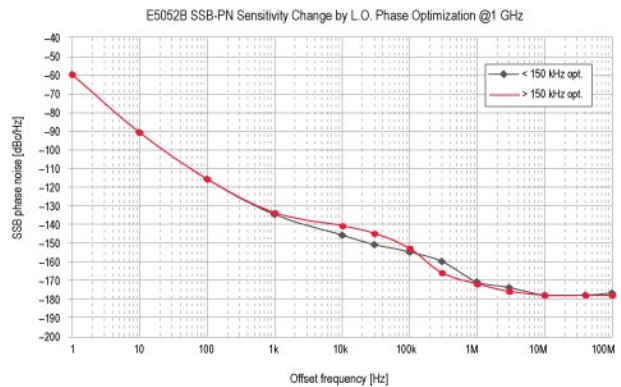

Figure 1-4. SSB phase noise change by LO optimization (SPD) (carrier 1 GHz, +5 dBm input, start offset frequency = 1 Hz, reference oscillator:narrowband)

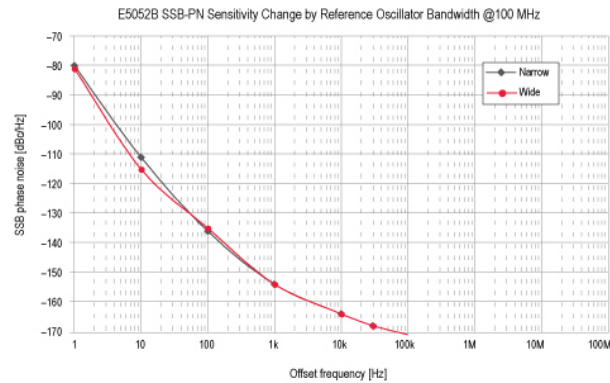

Figure 1-5. SSB phase noise sensitivity change by reference oscillator bandwidth (SPD) (carrier 100 MHz, +5 dBm input, start offset frequency = 1 Hz, LO optimization: < 150 kHz)

Spectrum Monitor Measurement

Table 2-1. Spectrum monitor performance

Description	Specification
RF frequency range	10 MHz to 7 GHz
Monitoring span	15 MHz maximum with linear scale
RBW	1.53 Hz to 400 kHz
Measurement parameters	dBm, dBV, watt, volt, dBm/Hz, dBV/Hz, watt/Hz, V/\sqrt{Hz}
Absolute measurement uncertainty	± 2 dB typical @ -10 dBm (att. = 10 dB)
Relative measurement uncertainty	± 1.5 dB (-60 dBm to -10 dBm, ratio)
Residual noise floor	-95 dBm typical @ RBW = 24.4 Hz
Measurement trigger	continuous/single/hold source: internal/external/manual/bus

Frequency and RF Power, DC Supply Current Measurements

Table 3-1. Frequency and power measurement performance

Description	Specification (E5052B)	Specification (E5052B-011)
RF frequency range	10 MHz to 7 GHz	
Measurement frequency bands	10 MHz to 1.5 GHz (low-band), 250 MHz to 7 GHz (high-band)	
Sweep parameters	DC control voltage (Vc) DC supply voltage (Vs)	N/A (Vc and Vs: constant)
Measurement parameters	Full analysis capability available for Frequency [Hz, Δ Hz, %, ppm], Tuning sensitivity ($\Delta f/\Delta Vc$)[Hz/V], frequency pushing ($\Delta f/\Delta Vs$)[Hz/V], RF power level [dBm], DC supply current [A], 'Meter mode' is also available.	No 'Analysis mode'. Only 'Meter mode' is available. Frequency [Hz], RF power [dBm], DC supply current [A]
Frequency resolution	10 Hz, 1 kHz, 64 kHz	
Frequency uncertainty	\pm (frequency resolution + time-base uncertainty)	
RF power measurement range	-20 dBm to +20 dBm (carrier 30 MHz to 7 GHz) -15 dBm to +20 dBm (carrier 10 MHz to 30 MHz)	
RF power resolution	0.01 dB	
RF power uncertainty (by peak detection)	\pm 0.5 dB (carrier 30 MHz to 3 GHz, > -10 dBm) \pm 1 dB (other than the above)	
DC (Vs) current measurement range	0 to 80 mA	
DC (Vs) current resolution	10 μ A	
DC (Vs) current uncertainty	\pm (0.2% of reading + 160 μ A)	
Swept measurement points	2 to 1,001	N/A
DC supply voltage source (Vs) output		
Setting range	0 to +16 V (sweep)	0 to +16 V (one point)
Setting resolution	1 mV	
Setting uncertainty	\pm (0.2% of setting + 2 mV)	
Maximum output current	80 mA	
Noise level	< 10 nVrms/ \sqrt{Hz} @ 10 kHz typical	
Output resistance	< 0.3 Ω typical	
DC control voltage source (Vc) output		
Setting range	-15 V to +35 V (sweep)	-15 V to +35 V (one point)
Setting resolution	0.1 mV	
Setting uncertainty	\pm (0.1% of (setting + 15 V) + 5 mV) (@Vc = -15 V to 0V) typical \pm (0.1% of setting + 2 mV) (@Vc = 0 to +35 V) typical	
Maximum output current	20 mA typical	
Noise level	1 nVrms/ \sqrt{Hz} @ 10 kHz (Vc = 0 to +20V) typical 1.5 nVrms/ \sqrt{Hz} @ 10 kHz (Vc: otherwise) typical	
Output resistance	< 50 Ω (DC) typical	
Output settling time	< 20 ms @ 0.1% uncertainty typical	
Measurement trigger	continuous/single/hold source: internal/external/manual/bus	

Transient Measurement

Table 4-1. Transient measurement performance

Description	Specification
Target frequency range	10 MHz to 7 GHz
Measurement parameters	
Narrowband mode	Frequency, RF power, phase
Wideband mode	Frequency
Frequency transient bandwidth	
Wideband	See Table 4-2.
Narrowband	3.125 kHz/ 25 kHz/ 200 kHz/ 1.6 MHz 25.6 MHz (> carrier 200 MHz) 80 MHz (> carrier 800 MHz)
Frequency measurement	
Resolution	See Table 4-2. through Table 4-8.
Uncertainty	± (resolution + time-base uncertainty)
Residual FM ¹	$0.2f^{\frac{1}{3}}\sqrt{1 + 11f^{\frac{2.5}{3}}}$ (Hz rms/GHz), SPD $f = \text{resolution}$
RF power measurement	
Power level range	-20 dBm to +20 dBm
Resolution	0.1 dB typical
Uncertainty	± 2 dB typical
Phase measurement (when DUT signal is locked to a target frequency)	
Uncertainty Trace noise	0.1 deg + 0.1 deg/GHz typical
Stability	0.02 deg + 0.02 deg/GHz typical 10 deg/sec typical
Uncertainty Trace noise	0.1 deg + 0.1 deg/GHz typical
Sweep measurement time	
Time span	10 μs to 10 s in 1,2,5 step (in advanced mode: maximum time span = time resolution * 10,000, up to 1000 sec.) See Table 4-2 through 4-8. in details
Time resolution	8 ns to 10 ms, See Table 4-2. to 4-8. in details. *Video filter time-constant: 260 ns to 16.78 ms
Measurement trigger	
Trigger mode Trigger source	continuous/single/hold
External trigger polarity Video trigger	internal/external/manual/bus/wide-video
Pre-trigger delay	/narrow-video positive/negative (TTL level)
External trigger delay adjustment External trigger detection jitter	positive/negative/frequency-band in/ frequency-band out
Trigger mode Trigger source	-80% of time span to + 1 s
External trigger polarity Video trigger	0 to 1 μs
Pre-trigger delay	< (1 μs + time resolution)

1. Equation is based on simplified model of phase noise characteristic of local oscillator in the E5052B.

Transient Measurement/Wideband Mode

Table 4-2. Wideband mode frequency resolution vs. time span and frequency band

Wideband mode	Transient time span (X-axis) setting																		
	10 μ	20 μ	50 μ	0.1 m	0.2 m	0.5 m	1 m	2 m	5 m	10 m	20 m	50 m	0.1	0.2	0.5	1	2	5	10
Time span [s]	8 n	16 n	40 n	80 n	0.16 μ	0.4 μ	1 μ	2 μ	5 μ	10 μ	20 μ	50 μ	125 μ	250 μ	625 μ	1.25 m	2.5 m	6.25 m	12.5 m
Time resolution [s]	1251	1251	1251	1251	1251	1251	1001	1001	1001	1001	1001	1001	801	801	801	801	801	801	801
Measurement point																			
Frequency band	Frequency resolution [Hz]																		
	0.05 to 0.15 GHz	28 k			9 k	3 k												1 k	
0.1 to 0.3 GHz	56 k			19 k	7 k												2 k		
0.2 to 0.6 GHz	112 k			39 k	14 k												4 k		
0.3 to 0.9 GHz	168 k			59 k	21 k												7 k		
0.4 to 1.2 GHz	225 k			79 k	28 k												9 k		
0.5 to 1.5 GHz	281 k			99 k	35 k												12 k		
0.6 to 1.8 GHz	337 k			119 k	42 k												14 k		
0.8 to 2.4 GHz	450 k			159 k	56 k												19 k		
1.0 to 3.0 GHz	562 k			198 k	70 k												24 k		
1.2 to 3.6 GHz	675 k			238 k	84 k												29 k		
1.4 to 4.2 GHz	787 k			278 k	98 k												34 k		
1.6 to 4.8 GHz	900 k			318 k	112 k												39 k		
1.8 to 5.4 GHz	1.012 M			357 k	126 k												44 k		
2.0 to 6.0 GHz	1.125 M			397 k	140 k												49 k		
2.2 to 6.6 GHz	1.237 M			437 k	154 k												54 k		
2.4 to 7.2 GHz	1.35 M			477 k	168 k												59 k		

Transient Measurement/Narrowband Mode

Table 4-3. Narrowband mode (80 MHz span)/frequency resolution vs. time span

Time span [s]	10 μ	20 μ	50 μ	0.1 m	0.2 m	0.5 m	1 m	2 m	5 m	10 m	20 m	50 m	0.1	0.2	0.5	1	2	5	10
Time resolution [s]	8 n	16 n	40 n	80 n	0.16 μ	0.4 μ	1 μ	2 μ	5 μ	10 μ	20 μ	50 μ	125 μ	250 μ	625 μ	1.25 m	2.5 m	6.25 m	12.5 m
Measurement point	1251	1251	1251	1251	1251	1251	1001	1001	1001	1001	1001	1001	801	801	801	801	801	801	801
Frequency resolution [Hz]	7 k					2.5 k		879											

Table 4-4. Narrowband mode (25.6 MHz span)/frequency resolution vs. time span

Time span [s]	10 μ	20 μ	50 μ	0.1 m	0.2 m	0.5 m	1 m	2 m	5 m	10 m	20 m	50 m	0.1	0.2	0.5	1	2	5	10
Time resolution [s]	8 n	16 n	40 n	80 n	0.16 μ	0.4 μ	1 μ	2 μ	5 μ	10 μ	20 μ	50 μ	125 μ	250 μ	625 μ	1.25 m	2.5 m	6.25 m	12.5 m
Measurement point	1251	1251	1251	1251	1251	1251	1001	1001	1001	1001	1001	1001	801	801	801	801	801	801	801
Frequency resolution [Hz]	7 k				2.5 k		879		311										

Table 4-5. Narrowband mode (1.6 MHz span)/frequency resolution vs. time span

Time span [s]	0.1 m ¹	0.2 m ¹	0.5 m ¹	1 m	2 m	5 m	10 m	20 m	50 m	0.1	0.2	0.5	1	2	5	10
Time resolution [s]	0.13 μ	0.26 μ	0.64 μ	0.64 μ	1.28 μ	3.2 μ	6.4 μ	16 μ	80 μ	160 μ	320 μ	800 μ	1.6 m	3.2 m	8 m	16 m
Measurement point	783	783	783	1564	1564	1564	1564	1251	626	626	626	626	626	626	626	626
Frequency resolution [Hz]	110			39				13.7				4.9				

Table 4-6. Narrowband mode (200 kHz span)/frequency resolution vs. time span

Time span [s]	1 m	2 m	5 m	10 m	20 m ¹	50 m ¹	0.1 ¹	0.2 ¹	0.5 ¹	1	2	5	10 ¹
Time resolution [s]	1 μ 1	2 μ 1	5 μ 1	10 μ 1	20 μ 1	51 μ 1	128 μ	256 μ	640 μ	1.28 m	2.56 m	6.4 m	12.8 m
Measurement point	978	978	978	978	978	978	783	783	783	783	783	783	783
Frequency resolution [Hz]	4.9	4.9	1.72	0.61	0.21								

Table 4-7. Narrowband mode (25 kHz span)/frequency resolution vs. time span

Time span [s]	10 m	20 m	50 m ¹	0.1 ¹	0.2 ¹	0.5 ¹	1	2	5	10
Time resolution [s]	8.2 μ	16.4 μ	41 μ	82 μ	164 μ	410 μ	1.02 m	2.05 m	5.12 m	10.24 m
Measurement point	1222	1222	1222	1222	1222	1222	978	978	978	978
Frequency resolution [Hz]	0.21		0.08	0.03	0.01					

Table 4-8. Narrowband mode (3.125 kHz span)/frequency resolution vs. time span

Time span [s]	0.2 ¹	0.5 ¹	0.5 ¹	1	2	5	10
Time resolution [s]	65 μ ¹	131 μ ¹	328 μ ¹	655 μ ¹	1.31 m	3.3 m ¹	8.2 m ¹
Measurement point	1527	1527	1527	1527	1527	1527	1222
Frequency resolution [Hz]	0.01		3 m	1 m	0.4 m		

1. Means approximately

AM Noise Measurement

Table 5-1. AM noise measurement performance

Description	Specification
RF frequency range	60 MHz to 7 GHz
Effective offset frequency range	10 Hz to 40 MHz (@ > carrier 400 MHz) 10 Hz to 10% of carrier frequency (@ < carrier 400 MHz)
AM noise sensitivity	See Table 5-2.
Measurement uncertainty ¹	\pm 4 dB (100 Hz to 1 kHz offset) typical \pm 2 dB (1 kHz to 1 MHz offset) typical \pm 3 dB (1 MHz to 40 MHz offset) typical
Spurious level	< -65 dBc/Hz (at > 1 kHz offset) typical
Measurement trigger	continuous/single/hold source: internal/external/manual/bus

Table 5-2. AM noise sensitivity [dBc/Hz] correlation = 1, RF input: 0 dBm, > 400 MHz

AM noise sensitivity	Offset frequency (Hz) from the carrier								
	1	10	100	1 k	10 k	100 k	1 M	10 M	40 M
E5052B start frequency = 1 Hz, measurement time = 13 s									
specification	-	-	-	-127	-138	-147	-150	-154	-155
typical	-	-103	-117	-131	-142	-151	-154	-158	-159
E5052B-011 (Option 011) start frequency = 10 Hz, measurement time = 3.3 s									
specification	-	-	-	-124	-135	-144	-147	-151	-152
typical	-	-100	-114	-128	-139	-148	-151	-155	-156

1. AM noise measurement uncertainty: specified at 1 GHz of carrier frequency with 0 dBm level. AM level > -60 dBc

Baseband Noise Measurement

Table 6-1. Baseband noise measurement performance

Description	Specification
Baseband input connector	BNC, 50 Ω nominal, AC coupled
Measurement frequency range	1 Hz to 100 MHz (E5052B) 10 Hz to 100 MHz (E5052B Option 011)
Measurement parameters	dBV/Hz, dBm/Hz, V/\sqrt{Hz}
Measurement level range	< +5 dBm
Baseband input damage level	> +23 dBm, > 35 V DC
Noise floor level	See Table 6-2.
Measurement uncertainty ¹	± 4 dB (< 1 kHz) SPD ± 2 dB (> 1 kHz) typical
Measurement trigger	continuous/single/hold source: internal/external/manual/bus

Table 6-2. Baseband noise floor [dBm/Hz] correlation = 1, baseband input: 0 Ω terminated

Internal Timebase

Table 7-1. Internal timebase (OCXO) performance

Description	Specification
Frequency uncertainty	± 5 Hz at 10 MHz (± 0.5 ppm)
Frequency temperature coefficient	< 0.5 ppb/ $^{\circ}$ C
Frequency aging rate	< 0.5 ppb/day 24 hours after a cold start for < 30 days continuous operation

1. Baseband measurement uncertainty: specified at > -60 dBm level.

General Information

Table 8-1. Front panel information

Description	Supplemental information (nominal)
Connectors/terminals	
RF IN	Type-N (female), 50 Ω
Baseband IN	BNC (female), 50 Ω , AC coupled
DC power	BNC (female),
DC control	BNC (female), 50 Ω
RF1/RF2, IN/OUT	SMA (female), 50 Ω See the simplified block diagram.
USB	2 ports (designed for USB2.0)
Probe DC power output	+15 V, 150 mA maximum -12.6 V, 150 mA maximum
Ground terminal	1
Display	10.4 inch TFT color LCD with touch screen 1,024 x 768 resolution ¹

1. Valid pixels > 99.998%. Below 0.002% of fixed points of black, blue, green or red are not regarded as failures









Table 8-2. Rear panel information

Description	Supplemental information (nominal)
External trigger input port	
Connector	BNC (female)
Input signal level	TTL level, (0 V to +5 V) Threshold Low: 0.5 V, High: 2.1V
Trigger pulse width	> 2 μ s
Trigger polarity	positive/negative edge selectable
Auxiliary output port	
Connector	BNC (female)
Output signal level	TTL level, L: 0 V, H:= +5 V, 50 mA max.
pulse width	1 μ s
Reference output port	
Connector	BNC (female), 50 Ω
Output frequency	same as timebase
Output level	2.5 dBm \pm 2 dB typical
Output signal waveform	Sinusoidal wave
Reference input ports	
(Ref In 1, Ref In 2)	
Connector	BNC (female), 50 Ω
Input frequency	10 MHz \pm 10 Hz

Description	Supplemental information (nominal)
Input signal level	0 dBm to 10 dBm
PC connection ports	
24 BIT I/O parallel port	36-pin D-sub (female) connector to a handler system TTL level, 8-bit I/O 16-bit Out
GPIB port	24-pin D-sub (female) connector (compatible with IEEE-488)
USB host ports	4 type-A (compatible with USB 2.0)
USB (USBTMC ¹) port	1 type-B (compatible with USBTMC-USB488 and USB 2.0)
LAN port	10/100 base-T ethernet
Video output port	15-pin mini D-sub (female) connector drives XGA compatible monitors
AC power line (a third-wire ground is required)	
Rated voltage	115 – 230 VAC
Voltage range	90 – 264 VAC
Rated frequency	50 / 60 Hz
Frequency range	47 – 63 Hz
AC power	500 VA maximum
Operating environment	
Temperature Humidity	+10 °C to +40 °C
Altitude	RH 20% to 80% at wet bulb temp.< 29 °C (non-condensing)
Vibration	0 to 2,000 m (0 to 6,561 feet)
Temperature Humidity	0.21 G maximum, 5 Hz to 500 Hz
Non-operating storage environment	
Temperature	-10 °C to +60 °C
Humidity	RH 20% to 90% at wet bulb temp.< 40 °C (non-condensing)
Altitude	0 to 4,572 m (0 to 15,000 feet)
Vibration	0.5 G maximum, 5 Hz to 500 Hz
Instrument dimensions	See Figure 8-1, 8-2, 8-3.
Weight (NET)	24.5 kg

1. USB test and measurement class (TMC) interface that communicates over USB, complying with the IEEE-488.1 and IEEE-488.2 standards.

EMC, safety, environment and compliance

EMC ¹	
Complies with the essential requirements of the European EMC Directive as well as current editions of the following standards (dates and editions are cited in the Declaration of Conformity).	
 ISM 1-A	<p>The CE mark is a registered trademark of the European Community (if accompanied by a year, it is the year when the design was proven). This product complies with all relevant directives.</p> <ul style="list-style-type: none"> • IEC 61326-1 • CISPR 11 Group 1, Class A
	UK conformity mark is a UK government owned mark. When affixed to the product is declaring all applicable Directives and Regulations have been met in full.
CAN ICES/NMB-001(A)	This ISM device complies with Canadian ICES-001. Cet appareil ISM est conforme a la norme NMB du Canada.
	<p>The RCM mark is a registered trademark of the Australian Communications and Media Authority.</p> <ul style="list-style-type: none"> • AS/NZS CISPR 11
	<p>South Korean Certification (KC) mark; includes the marking's identifier code: R-R-Kst-xxxxxx</p> <p>South Korean Class A EMC declaration: Information to the user: This equipment has been conformity assessed for use in business environments. In a residential environment this equipment may cause radio interference. ※ This EMC statement applies to the equipment only for use in business environment.</p> <p>사 용 자 안 내 문</p> <p>이 기기는 업무용 환경에서 사용할 목적으로 적합성평가를 받은 기기로서가정용 환경에서 사용하는 경우 전파간섭의 우려가 있습니다.</p> <p>※ 사용자 안내문은 “업무용 방송통신기자재”에만 적용한다.</p>
Safety ¹	
Complies with the essential requirements of the European Low Voltage Directive as well as current editions of the following standards (dates and editions are cited in the Declaration of Conformity). This product is designed for use in INSTALLATION CATEGORY II and POLLUTION DEGREE 2 and MEASUREMENT CATEGORY NONE per IEC standards. This product is intended for indoor use.	
 ISM 1-A	IEC/EN 61010-1
	<p>The CSA mark is a registered trademark of the CSA International.</p> <ul style="list-style-type: none"> • Canada: CSA C22.2 No. 610610-1 • USA: UL std no. 61010-1
1. To find a current Declaration of Conformity for a specific Keysight product, go to: http://www.keysight.com/go/conformity .	
Environment	
	<p>The crossed out wheeled bin symbol indicates that separate collection for waste electric and electronic equipment (WEEE) is required, as obligated by DIRECTIVE 2012/19/EU.</p> <p>Please refer to about.keysight.com/en/companyinfo/environment/takeback.shtml to understand your Trade in options with Keysight in addition to product takeback instructions.</p>
Compliance	
	Class C (only applies to units that are shipped with firmware revision A.03.10 or later)

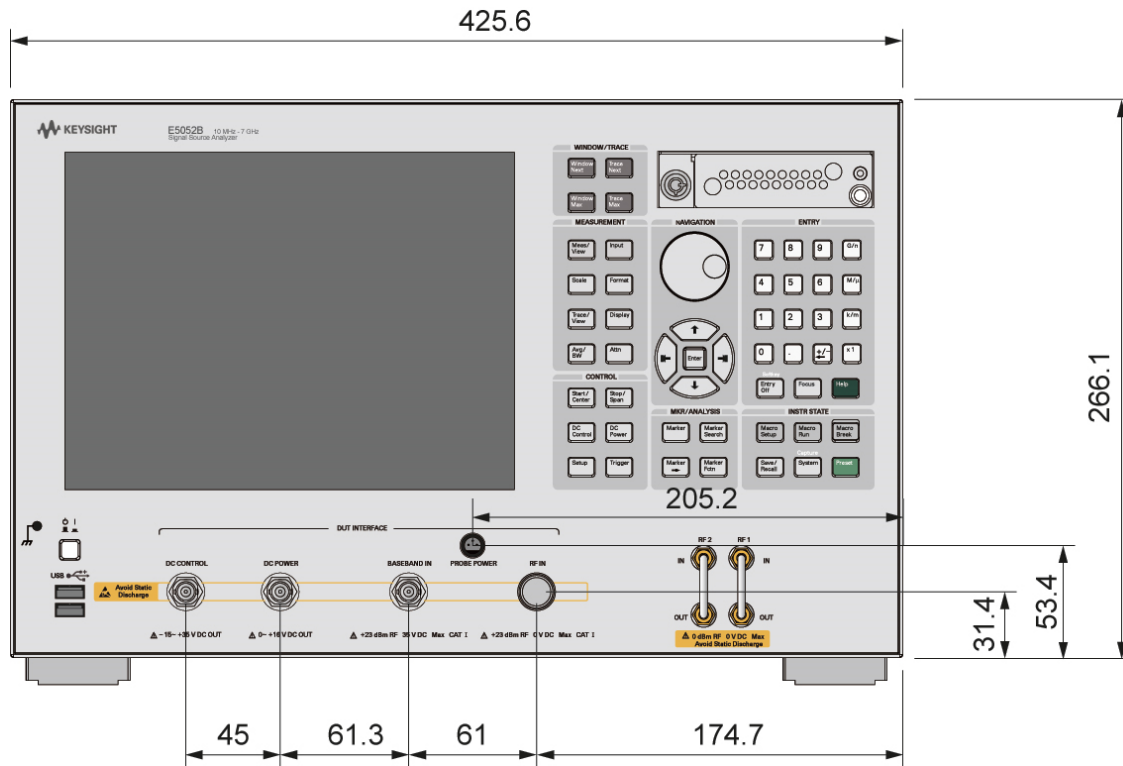

Figure 8-1. Front view

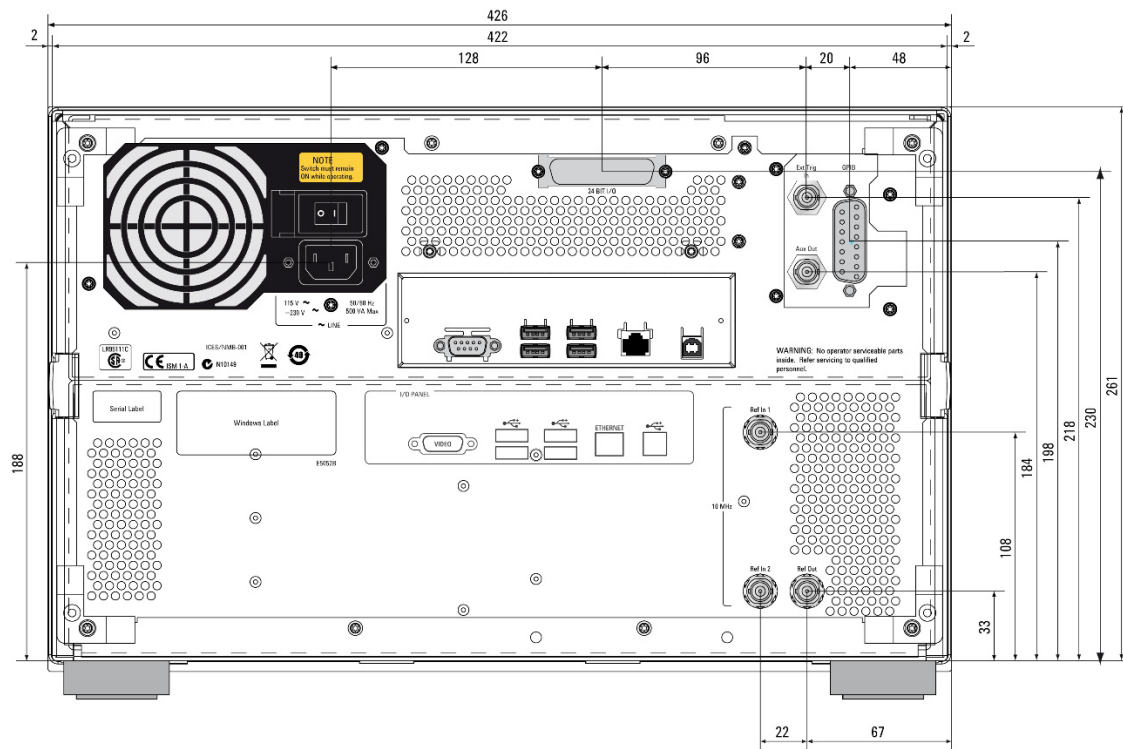

Figure 8-2. Rear view

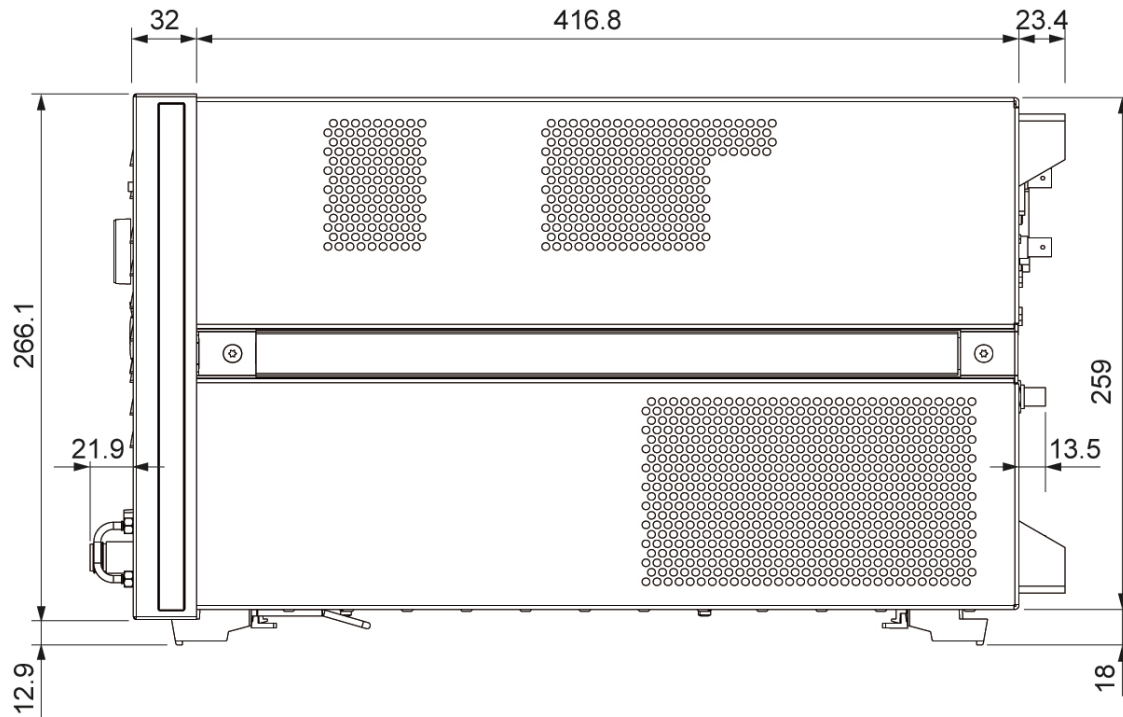

Figure 8-3. Side view

Display Functions

Table 9-1. Display functions (windows and traces)

Description	General characteristics
Measurement windows	Up to 6 windows, and 1 user definable window
User definable window	8 data traces and 8 memory traces
Trace functions	
Data traces	Display current measurement data and/or memory data
Trace math	Addition, subtraction, multiplication, or division of trace data
Title	Add customized title to each measurement window Titles are printed on hard copies of displayed measurements.
Auto scale	Automatically selects scale resolution and reference value to vertically center the trace.
Statistics	Calculates and displays mean, standard deviation, and peak-to-peak deviation of the trace.
Marker functions	
Data markers	10 independent markers per trace. Reference marker available for "delta marker" operation.
Marker search	Maximum value, minimum value, peak, peak-left, peak-right, target, target-left, target-right, multi-peak, and band markers with user-definable bandwidth value.
Marker-to	Set, start, stop, center to active marker stimulus value. Set reference to active marker response value.
Searching range	User definable
Tracking	Performs marker search continuously or on-demand.

Data Processing Capabilities

Table 9-2. Data processing capabilities

Description	General characteristics
Graphical user interface	The analyzer employs a graphical user interface based on Windows® OS. There are three ways to operate the instrument manually; you can use a hard key interface, a touch-screen interface, or a mouse interface.
Limit-line test	Define the test limit that appears on the display for pass/fail testing. Defined limits may be any combination of horizontal or sloping lines and discrete data points.
Data storage	
Internal removable SSD	Store and recall instrument states and trace data on internal removable solid state drive. Instrument states include all control settings and memory trace data.
File sharing	Files on user disk drive (F:) can be accessed from an external Windows PC through LAN or USB (USB-TMC)
Screen hard copy	Print-outs of instrument data are directly produced on a printer via USB.
Automation	
Built-in VBA®	Applications can be developed in a built-in VBA (Visual Basic for Applications) language.
Controlling via GPIB or USB	The GPIB interface operates with IEEE488.2 and SCPI protocols. The instrument can be controlled by a GPIB external controller. The instrument can control external devices using a USB/GPIB interface.
Controlling via USBTMC	The USB interface operates with USBTMC and SCPI protocols. The instrument can be controlled by an external PC using the USB interface with a USB cable.
LAN	(10/100 base-T) Telnet, SICL-LAN

Optional Application Software

Table 9-3. E5001A SSA-J precision clock jitter analysis software

Description	General characteristics
Measurement functions	RJ (random jitter), PJ (periodic jitter) frequency, PJ decomposition with auto-trend correction
Measurement parameters	RJ: rms, PJ: frequency, rms, p-p, d-d, TJ (total jitter): p-p, jitter trend (phase deviation waveform), jitter histogram
Jitter spectrum analysis range	1 Hz to 100 MHz (E5052B), 10 Hz to 100 MHz (E5052B Option 011)

System Performance with the E5053A Microwave Downconverter

The system performance is the combination of the E5052B SSA and the E5053A microwave downconverter. All data is typical performance.

Table 10-1. System performance characteristics

Description	Performance characteristics
RF input port	
Input connector	APC-3.5 (female), 50 Ω nominal (E5053A input) 10 MHz to 3 GHz (E5052B RF IN port)
Frequency range	3 to 26.5 GHz (E5053A Input port)
	3 to 10 GHz frequency band: fundamental mixing
	9 to 26.5 GHz frequency band: third harmonics mixing
Input level	-15 to +20 dBm (10 MHz to 3 GHz, E5052B RF IN port)
	-30 to +10 dBm (3 to 10 GHz frequency band)
	-20 to +5 dBm (9 to 26.5 GHz frequency band)
Carrier search range	-10 to +10 dBm (3 to 10 GHz frequency band)
	-10 to +5 dBm (9 to 26.5 GHz frequency band)
Spectrum monitor measurement¹	
Frequency span	15 MHz maximum
RBW (resolution bandwidth)	1.53 Hz to 400 kHz
Level uncertainty	± 4 dB
Frequency & RF power measurement	
Frequency measurement resolution	10 Hz, 1 kHz, or 64 kHz
RF power measurement uncertainty	± 2 dB (10 MHz to 3 GHz, E5052B RF IN port)
	± 3 dB (low band: 3 to 10 GHz)
	± 4 dB (high band: 9 to 26.5 GHz)
	Power uncertainty can be improved by applying the 'user power cal.' function.
Transient measurement	
Wideband frequency range	50 MHz to 3 GHz (E5052B RF IN port)
	500 MHz (E5053A Input port)
Narrowband frequency range	3.125 kHz, 25 kHz, 200 kHz, 1.6 MHz, 25.6 MHz, or 80 MHz
RF power measurement uncertainty	± 2 dB (10 MHz to 3 GHz, E5052B RF IN port)
	± 3 dB (low band: 3 to 10 GHz)
	± 4 dB (high band: 9 to 26.5 GHz)
	Power uncertainty can be improved by applying the 'user power cal.' function.

1. Segment PN mode is available with the firmware revision 3.20 or later. In segment PN mode, offset frequency range is limited up to 99.9 MHz when frequency range is 9 to 26.5 GHz frequency band.

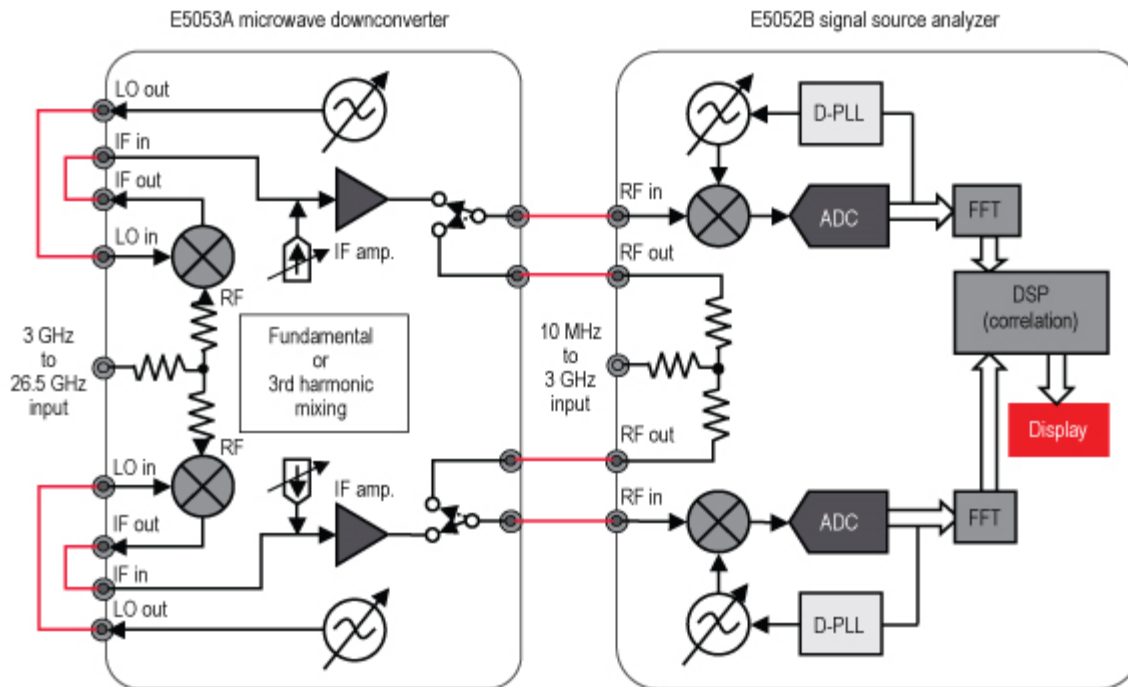

Figure 10-1. E5053A with E5052B simplified block diagram

Table 10-2. System SSB phase noise sensitivity (dBc/Hz) in normal capture range mode (E5053A + E5052B) (SPD) 0 dBm input, start offset frequency = 1 Hz, correlation = 1, LO optimization: < 150 kHz, measurement time = 13 sec

Input frequency	Offset frequency (Hz) from the carrier									
	1	10	100	1 k	10 k	100 k	1 M	10 M	40 M	100 M
3 GHz	-48	-79	-99	-124	-135	-137	-153	-164	-167	-167
10 GHz	-38	-72	-91	-116	-124	-128	-147	-156	-160	-160
18 GHz	-33	-66	-85	-110	-121	-125	-141	-150	-154	-154
26.5 GHz	-30	-63	-82	-107	-118	-122	-138	-147	-151	-151

Table 10-2-W. System SSB phase noise sensitivity (dBc/Hz) in wide capture range mode (E5053A+E5052B) (SPD) 0 dBm input, start offset frequency = 1 Hz, correlation = 1, LO optimization: < 150 kHz, measurement time = 13 sec

Input frequency	Offset frequency (Hz) from the carrier								
	1	10	100	1 k	10 k	100 k	1 M	10 M	40 M
3 GHz	-	-	-	-107	-127	-136	-150	-158	-159
10 GHz	-	-	-	-107	-122	-127	-146	-154	-157
18 GHz	-	-	-	-105	-120	-124	-140	-149	-153
26.5 GHz	-	-	-	-104	-117	-122	-137	-146	-150

Table 10-2-A. System AM noise sensitivity (dBc/Hz) (E5053A + E5052B) (SPD) correlation = 1, RF input: 0 dBm, > 400 MHz

AM noise sensitivity	Offset frequency (Hz) from the carrier								
	1	10	100	1 k	10 k	100 k	1 M	10 M	40 M
E5052B start frequency = 1 Hz, measurement time = 13 s									
3 to 10 GHz	-	-100	-110	-117	-127	-130	-137	-137	-137
10 to 26.5 GHz	-	-100	-110	-117	-127	-129	-129	-129	-129
5052B-011 (Option 011) start frequency = 10 Hz, measurement time = 3.3 s									
3 to 10 GHz	-	-97	-107	-114	-124	-127	-134	-134	-134
10 to 26.5 GHz	-	-97	-107	-114	-124	-126	-126	-126	-126

E5052B + E5053A System SSB-PN Sensitivity (SPD)

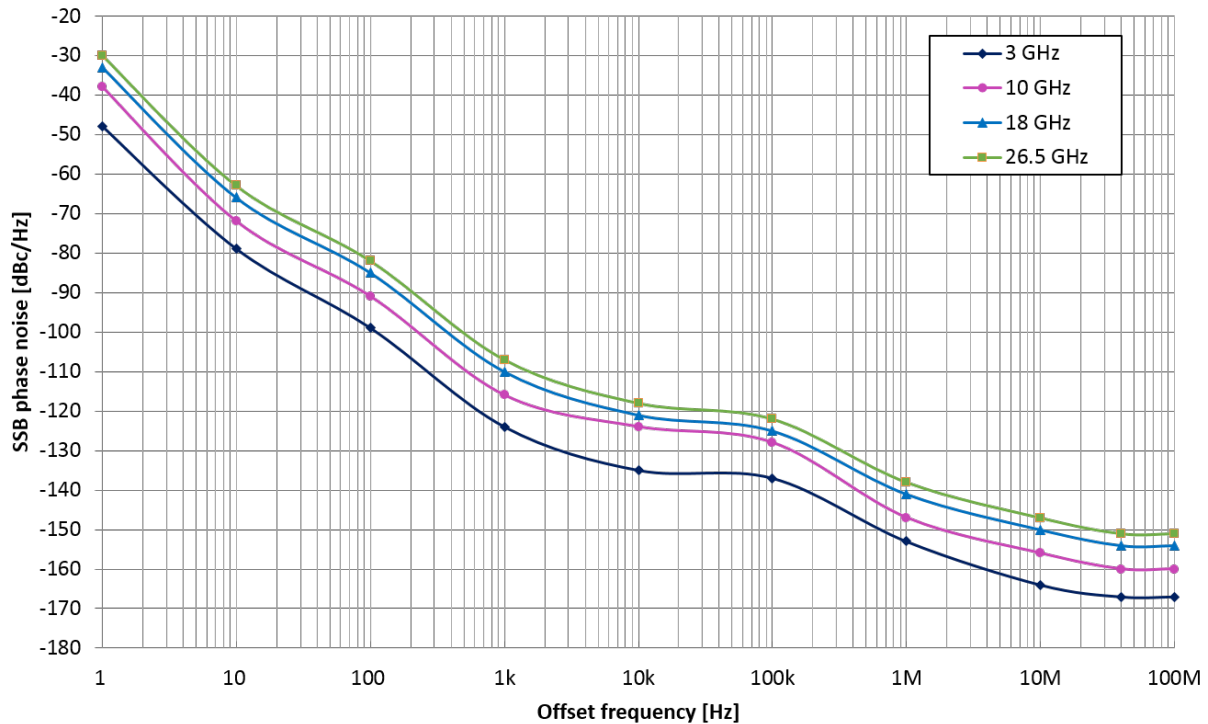

Figure 10-2. System phase noise sensitivity (E5053A + E5052B) (SPD)

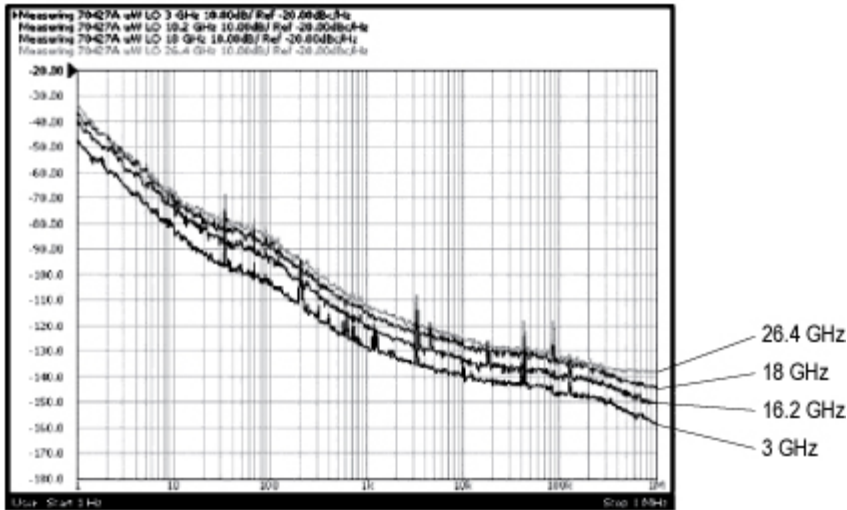

Figure 10-3. Measurement samples for the ultra-low noise N5507A LO

About “mmW application”:

Phase noise measurements above 26.5 GHz can be done by using external harmonic mixers (such as Keysight 11970 Series) and a power divider (splitter) with E5053A LO and IF terminals. The E5052B’s mmW application software sets up appropriate LO frequencies for the harmonic mixers.

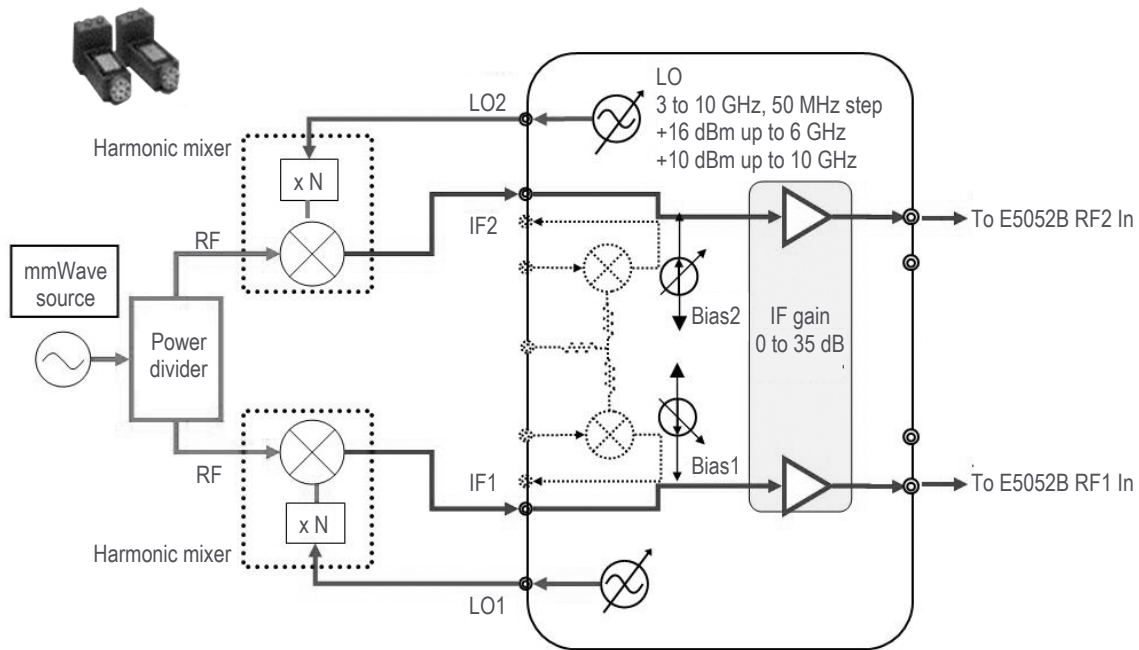

Figure 10-4. System set-up for harmonic mixers (E5053A + E5052B)

Table 10-2-H. Frequency band example of phase noise measurement with mmW harmonic mixers

Mixer model	Frequency band	N
11970A	26.5 to 40 GHz	8
11970Q	33 to 50 GHz	10
11970U	40 to 60 GHz	10
11970V	50 to 75 GHz	14
11970W	75 to 110 GHz	18

E5053A Microwave Downconverter Specifications and General Information Summary

Table 10-3. E5053A front ports

Description	Specification
RF Input port Input	
Input connector	APC-3.5 (female), 50 Ω nominal
Frequency range	3 GHz to 26.5 GHz 3 GHz to 10 GHz (fundamental mixing) 9 GHz to 26.5 GHz (third harmonics mixing)
Input level	< +10 dBm (3 GHz to 10 GHz band) < +5 dBm (9 GHz to 26.5 GHz band)
Input damage level	> +23 dBm
LO outputs	
Output connector	SMA (female), 50 Ω nominal 3 GHz to 10 GHz
Output frequency	50 MHz
Frequency resolution	10 dBm to 16 dBm (3 GHz to 6 GHz)
Output power	SMA (female), 50 Ω nominal 3 GHz to 10 GHz 10 dBm to 15 dBm (6 GHz to 10 GHz)
LO spurious	< -55 dBc (offset frequency > 300 Hz) typical
IF inputs	
Input connector	SMA (female), 50 Ω nominal
Frequency range	250 MHz to 1,250 MHz
Maximum input level	0 dBm typical
IF gain	0 dB to 35 dB in 5 dB step
Noise floor	< -162 dBm/Hz (SPD)
Mixer bias current	-10 mA to +10 mA

Table 10-4. General information

Description	Supplemental information (nominal)
External reference signal input port	
Input connector	BNC (female), 50 Ω nominal
Frequency range	10 MHz ± 10 Hz typical
Input level	-6 dBm to 6 dBm typical
Internal reference signal output port	
Output connector	BNC (female), 50 Ω nominal
Output frequency	10 MHz ± 50 Hz typical
Output level	2.5 dBm ± 3 dB typical
USB port	type-B (female), provides connection to E5052A/B
AC power Line (a third -wire ground is required)	
Rated voltage	115 – 230 VAC
Voltage range	90 – 264 VAC
Rated frequency	50 / 60 Hz
Frequency range	47 – 63 Hz
AC power	250 VA maximum

Table 10-5. Analyzer environmental and dimensions

Description	Supplemental information (nominal)
Operating environment	
Temperature	+10 °C to +40 °C
Humidity	RH 20% to 80% at wet bulb temp. < 29 °C (non-condensing)
Altitude	0 to 2,000 m (0 to 6,561 feet)
Vibration	0.21 G maximum, 5 Hz to 500 Hz
Non-operating storage environment	
Temperature	-10 °C to +60 °C
Humidity	RH 20% to 90% at wet bulb temp. < 40 °C (non-condensing)
Altitude	0 to 4,572 m (0 to 15,000 feet)
Vibration	0.5 G maximum, 5 Hz to 500 Hz
Instrument dimensions	See Figure 10-6, 10-7, 10-8.
Weight (NET)	11 kg

E5053A Microwave Downconverter Specifications and General Information Summary – continued

Table 10-6. E5053A LO phase noise performance (dBc/Hz)

RF input frequency		Offset frequency [Hz] from the carrier									
		1	10	100	1 k	10 k	100 k	1 M	10 M	40 M	100 M
E5052B start frequency = 1 Hz, measurement time = 13 s											
3 GHz	specification	–	–	–	-110	-116	-113	-127	-140	-140	-140
	typical	-49	-79	-94	-114	-120	-117	-131	-144	-144	-144
6 GHz	specification	–	–	–	-104	-110	-109	-123	-140	-140	-140
	typical	-43	-73	-88	-108	-114	-113	-127	-144	-144	-144
10 GHz	specification	–	–	–	-100	-103	-102	-119	-140	-140	-140
	typical	-39	-69	-84	-104	-107	-106	-123	-144	-144	-144

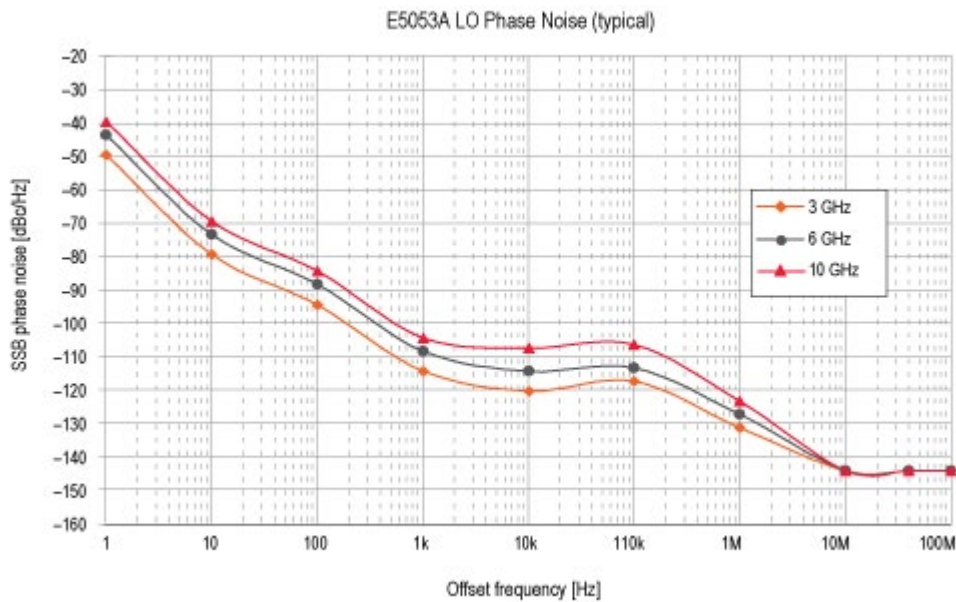

Figure 10-5. E5053A LO phase noise (typical)

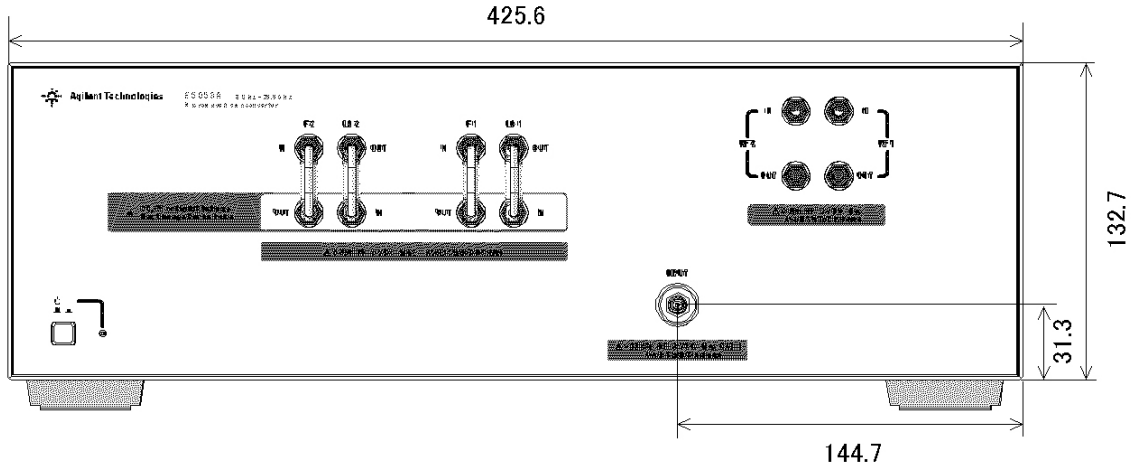

Figure 10-6. Front view

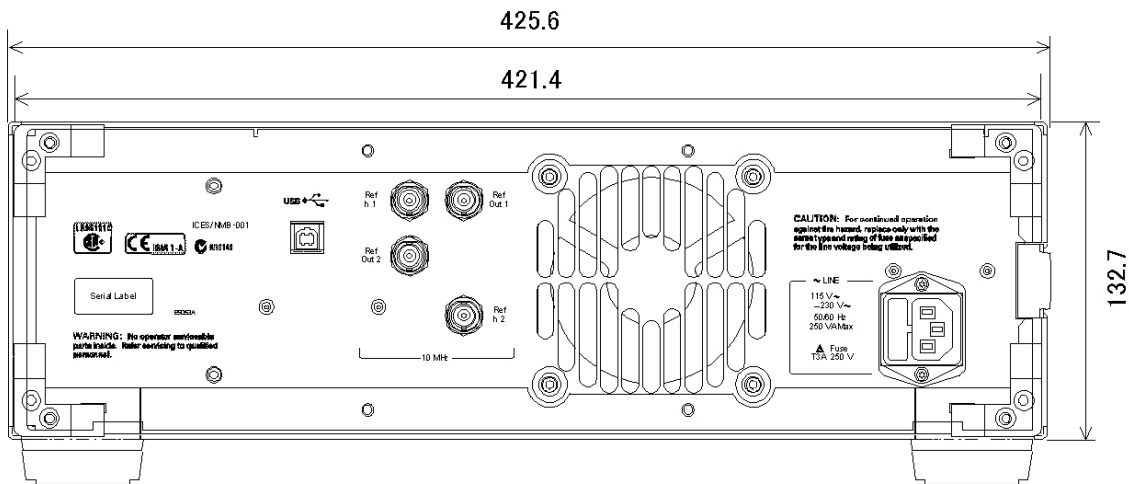

Figure 10-7. Rear view

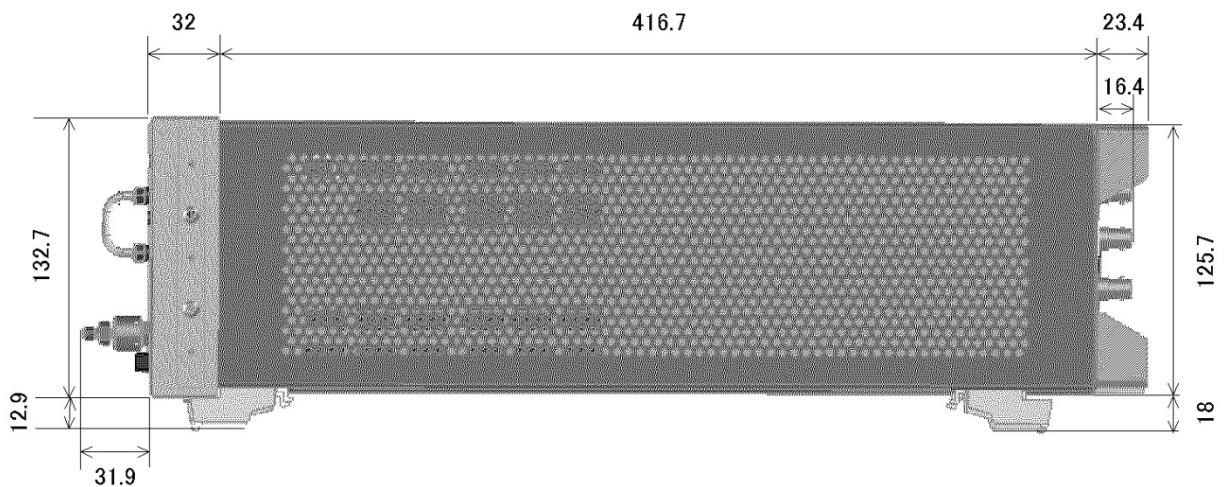

Figure 10-8. Side view

Web Sources

Visit our Signal Source Analyzer Web site for additional product information and literature.

www.keysight.com/find/ssa

Phase noise measurements: www.keysight.com/find/phasenoise

RF and microwave accessories: www.keysight.com/find/mta

Learn more at: www.keysight.com

For more information on Keysight Technologies' products, applications, or services, please contact your local Keysight office. The complete list is available at: www.keysight.com/find/contactus

