

Agilent Technologies
DC Power Analyzer
Model N6705

User's Guide

Legal Notices

© Agilent Technologies, Inc. 2007 - 2012

No part of this document may be photocopied, reproduced, or translated to another language without the prior agreement and written consent of Agilent Technologies, Inc. as governed by United States and international copyright laws.

Warranty

The material contained in this document is provided "as is," and is subject to being changed, without notice, in future editions. Further, to the maximum extent permitted by applicable law, Agilent disclaims all warranties, either express or implied, with regard to this manual and any information contained herein, including but not limited to the implied warranties of merchantability and fitness for a particular purpose. Agilent shall not be liable for errors or for incidental or consequential damages in connection with the furnishing, use, or performance of this document or of any information contained herein. Should Agilent and the user have a separate written agreement with warranty terms covering the material in this document that conflict with these terms, the warranty terms in the separate agreement shall control.

Manual Editions

Manual Part Number: N6705-90001
Ninth Edition, June, 2012
Printed in Malaysia.

Reprints of this manual containing minor corrections and updates may have the same printing date. Revised editions are identified by a new printing date.

Declaration of Conformity

Declarations of Conformity for this product and for other Agilent products may be downloaded from the Web. Go to <http://regulations.corporate.agilent.com> and click on "Declarations of Conformity." You can then search by product number to find the latest Declaration of Conformity.

Waste Electrical and Electronic Equipment (WEEE) Directive 2002/96/EC

This product complies with the WEEE Directive 2002/96/EC marketing requirement. The affixed product label (see below) indicates that you must not discard this electrical/electronic product in domestic household waste.

Product Category: With reference to the equipment types in the WEEE directive Annex 1, this product is classified as "Monitoring and Control instrumentation" product.

Do not dispose in domestic household waste.

To return unwanted products, contact our local Agilent office, or see www.agilent.com/environment/product for more information.



Certification

Agilent Technologies certifies that this product met its published specifications at time of shipment from the factory. Agilent Technologies further certifies that its calibration measurements are traceable to the United States National Institute of Standards and Technology, to the extent allowed by the Institute's calibration facility, and to the calibration facilities of other International Standards Organization members.

Exclusive Remedies

THE REMEDIES PROVIDED HEREIN ARE THE CUSTOMER'S SOLE AND EXCLUSIVE REMEDIES. AGILENT TECHNOLOGIES SHALL NOT BE LIABLE FOR ANY DIRECT, INDIRECT, SPECIAL, INCIDENTAL, OR CONSEQUENTIAL DAMAGES, WHETHER BASED ON CONTRACT, TORT, OR ANY OTHER LEGAL THEORY.

Assistance

This product comes with the standard product warranty. Warranty options, extended support contacts, product maintenance agreements and customer assistance agreements are also available. Contact your nearest Agilent Technologies Sales and Service office for further information on Agilent Technologies' full line of Support Programs.

Technologies Licenses

The hardware and or software described in this document are furnished under a license and may be used or copied only in accordance with the terms of such license.

U.S. Government Restricted Rights

Software and technical data rights granted to the federal government include only those rights customarily provided to end user customers. Agilent provides this customary commercial license in Software and technical data pursuant to FAR 12.211 (Technical Data) and 12.212 (Computer Software) and, for the Department of Defense, DFARS 252.227-7015 (Technical Data – Commercial Items) and DFARS 227.7202-3 (Rights in Commercial Computer Software or Computer Software Documentation).

Trademarks

Microsoft and Windows are U.S. registered trademarks of Microsoft Corporation.

Safety Notices

The following general safety precautions must be observed during all phases of operation of this instrument. Failure to comply with these precautions or with specific warnings or instructions elsewhere in this manual violates safety standards of design, manufacture, and intended use of the instrument. Agilent Technologies assumes no liability for the customer's failure to comply with these requirements.

General

Do not use this product in any manner not specified by the manufacturer. The protective features of this product may be impaired if it is used in a manner not specified in the operation instructions.

Before Applying Power

Verify that all safety precautions are taken. Make all connections to the unit before applying power. Note the instrument's external markings described under "Safety Symbols"

Ground the Instrument

This product is a Safety Class 1 instrument (provided with a protective earth terminal). To minimize shock hazard, the instrument chassis and cover must be connected to an electrical ground. The instrument must be connected to the AC power mains through a grounded power cable, with the ground wire firmly connected to an electrical ground (safety ground) at the power outlet. Any interruption of the protective (grounding) conductor or disconnection of the protective earth terminal will cause a potential shock hazard that could result in personal injury.

Load Connections

Power supplies can output high currents and high voltages. Make sure that the load or device under test can safely handle the output current and voltage. Also, make sure that the connection leads can safely withstand the expected currents and are insulated for the expected voltages.

Power supply outputs may be connected so as to float relative to earth ground. Isolation or floating voltage ratings are indicated on the instrument, near the output connectors (see example below).

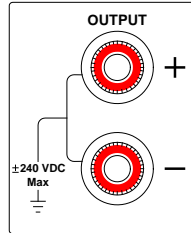

Do not float the power supply output on the line-voltage mains. Observe all safety markings and protection limits.

Fuses

The instrument contains an internal fuse, which is not customer accessible.

Do Not Operate in an Explosive Atmosphere

Do not operate the instrument in the presence of flammable gases or fumes.

Do Not Remove the Instrument Cover

Only qualified, service-trained personnel who are aware of the hazards involved should remove instrument covers. Always disconnect the power cable and any external circuits before removing the instrument cover.

Do Not Modify the Instrument

Do not install substitute parts or perform any unauthorized modification to the product. Return the product to an Agilent Sales and Service Office for service and repair to ensure that safety features are maintained.

In Case of Damage

Instruments that appear damaged or defective should be made inoperative and secured against unintended operation until they can be repaired by qualified service personnel.

Cleaning

Clean the outside of the instrument with a soft, lint-free, slightly dampened cloth. Do not use detergent or solvents.

Safety Symbols and Notices

	Direct current
	Alternating current
	Direct and alternating current
	3-phase alternating current
	Earth (ground) terminal
	Protective earth terminal
	Frame or chassis terminal
	Terminal is at earth potential
	Neutral conductor on permanently installed equipment
	Line conductor on permanently installed equipment.
	On supply
	Off supply
	Standby supply - unit is not completely disconnected from AC mains when switch is off
	In position of a bi-stable push switch
	Out position of a bi-stable push switch
	Caution, risk of electric shock
	Caution, hot surface
	Caution, refer to accompanying description

CAUTION

Denotes a hazard. It calls attention to an operating procedure, practice, or the like that, if not correctly performed or adhered to, could result in damage to the product or loss of important data. Do not proceed beyond a **CAUTION** notice until the indicated conditions are fully understood and met.

WARNING

Denotes a hazard. It calls attention to an operating procedure, practice, or the like that, if not correctly performed or adhered to, could result in personal injury or death. Do not proceed beyond a **WARNING** notice until the indicated conditions are fully understood and met.

In this Book

Specific chapters in this manual contain the following information:

- Quick Reference – Chapter 1 is a quick reference section that helps you quickly become familiar with your DC Power Analyzer.
- Installation – Chapter 2 describes how to install your DC Power Analyzer. It discusses topics such as how to connect loads to the output, 4-wire sensing, parallel and series connections.
- Using the Source functions – Chapter 3 describes how to use the power supply and the arbitrary waveform generator using the front panel and SCPI commands.
- Using the Measurement functions – Chapter 4 describes how to use the front panel output meters, scope view, and data logger.
- Using the System functions – Chapter 5 describes file functions and administrative functions.
- Advanced Source and Measurement Functions – Chapter 6 discusses advanced source functions and measurement functions such as lists, digitizing measurements, and external data logging.
- Specifications – Appendix A describes the mainframe characteristics.
- SCPI Commands – Appendix B summarizes the SCPI commands.
- Using the Digital Port – Appendix C describes how to configure and use the digital port on the instrument's rear panel.

For complete details on the SCPI (Standard Commands for Programmable Instruments) commands, refer to the N6705 Programmer's Reference Help file included on the Agilent N6705 Product Reference CD. This CD-ROM is shipped along with your instrument.

NOTE

You can contact Agilent Technologies at one of the following telephone numbers for warranty, service, or technical support information.

In the United States: (800) 829-4444

In Europe: 31 20 547 2111

In Japan: 0120-421-345

Or use our Web link for information on contacting Agilent in your country or specific location: www.agilent.com/find/assist

Or contact your Agilent Technologies Representative.

Updates

Firmware and Manual Updates

This manual describes firmware revision D.01.08 and up. Go to www.agilent.com/find/N6705firmware if you need to download this or any later versions of the firmware. Information on firmware differences is available on the web site.

Refer to “View Output Ratings” in chapter 2 to view the firmware version that is currently installed in your mainframe.

Refer to “Updating the Firmware” in chapter 5 for information on how to update your mainframe with the latest firmware. Note that Agilent N675xA power modules must have Option LGA to support the latest firmware versions.

Updated versions of this manual are also posted on the web. Go to www.agilent.com/find/N6705 to get the latest version of the manual.

Agilent N6705B Differences

- Voltage and Current knob push-button functions. Pushing the front panel voltage and current knobs displays a menu from which you can: 1. Lock/Unlock the knobs. 2. Select limit parameters or select limit tracking on Models N678xA.
- Rear panel output ports are provided for Agilent N6753A high current load leads. See “Agilent N6753A High Current Connections” in chapter 2 for details.
- Rear panel auxiliary terminals are provided for Agilent N6781A auxiliary measurement inputs. See “Connecting the Auxiliary Voltage Measurement Input” in chapter 2 for details.

Contents

1 - Quick Reference	11
The Agilent N6705 DC Power Analyzer – At a Glance	12
Source Features	12
Measurement Features	13
System Features	13
Power Module Features	14
Agilent N678xA Power Module Features	15
The Front Panel - At a Glance	16
The Rear Panel – At a Glance	17
Meter View	18
Scope View	19
Data Logger	20
Arb Preview	21
Front Panel Menu Reference	22
2 - Installation	25
General Information	26
Models	26
Options	26
Items Supplied	26
Inspecting the Unit	27
Installing the Unit	28
Safety Considerations	28
Environment	28
Cleaning	28
Power Module Location	28
Power Module Installation	29
High Current Output Connections	31
Bench Installation	32
Rack Installation	32
400 Hz Operation	32
Connecting the Line Cord	33
Connecting the Outputs	33
Wire Size and Length	34
Agilent N678xA SMU Wiring Requirements	35
Multiple Loads	37
4-Wire Sense Connections	37
Parallel Connections	40
Series Connections	41
Additional Load Considerations	42
Connecting the BNC Connectors	44
Installing a Redundant Ground for 400 Hz Operation	44



Connecting the Digital Port	45
Connecting the Auxiliary Voltage Measurement Input	46
Connecting to the Interfaces	47
GPIB/USB Interfaces	47
LAN Interface	49
Viewing the Active LAN Status	51
Modifying the LAN Settings	51
Communicating Over the LAN	54
Using the Web Server	54
Using Telnet	55
Using Sockets	55
3 - Using the Source Functions	57
Turning the Unit On	58
View the Error Log	58
View Output Ratings	59
Using the Power Supply	60
Controlling the Outputs	60
Additional Source Settings	62
Agilent N678xA SMU Emulation Settings	63
Configuring a Turn-On/Turn-Off Sequence	67
Configuring Advanced Properties	70
Configuring Protection Functions	72
Configuring Advanced Protection	74
Using the Arbitrary Waveform Generator	75
Configuring Pulse Arbs	76
Configuring User-Defined Arbs	78
Configuring Constant-Dwell Arbs	81
Configuring an Arb Sequence	84
Arbitrary Waveform Parameters	88
Arb Trigger Sources	99
Arb Triggers	100
Importing/Exporting User-Defined and Constant-Dwell Arb Data	102
4 - Using the Measurement Functions	103
Using the Meter Functions	104
Meter View	104
Meter Ranges	105
Agilent N678xA SMU Meter-Only Modes	106
Agilent N6781A Auxiliary Voltage Measurements	108
Using the Scope Functions	109
Making a Measurement	109
Scope View	112
Scope Properties	116

Scope Ranges.....	117
Scope Marker.....	118
Scope Horizontal.....	118
Scope Preset.....	118
Using the Data Logger Functions.....	119
Logging Data.....	119
Data Logger View.....	123
Data Logger Properties.....	127
Data Logger Ranges.....	128
Data Logger Trigger.....	129
Data Logger Filename.....	131
Data Logger Marker.....	131
Data Logger Preset.....	132
Data Logger Sampling Modes.....	133
Scope and Data Logger Display Differences.....	135

5 - Using the System Functions.....137

Using the File Functions.....	138
Save Function.....	138
Load Function.....	139
Export Function.....	139
Import Function.....	140
Screen Capture.....	140
Show Details.....	141
Delete Function.....	141
Rename Function.....	142
Copy Function.....	142
New Folder.....	143
Reset/Recall/Power-On State.....	143
Using an External USB Memory Device.....	144
Configuring User Preferences.....	145
Front Panel Preferences.....	145
Front Panel Lockout.....	146
Clock Setup.....	146
Using the Administrative Tools.....	147
Administrator Login/Logout.....	147
Instrument Calibration.....	147
Securing the USB, LAN, and Web Server.....	148
Restoring the Non-volatile Factory Settings.....	148
Disk Management.....	149
Updating the Firmware.....	149
Installing Options.....	150
Changing the Password.....	151

6 - Advanced Source and Measurement Functions.....	153
Source Operating Modes.....	154
Single Quadrant Operation.....	154
Autoranging.....	155
Downprogramming.....	155
CC Mode Delay.....	155
Power Limit Operation.....	156
Output Grouping.....	157
Agilent N678xA SMU Multi-Quadrant Operation.....	158
Output Bandwidth.....	161
Advanced Measurements.....	162
Digitizing Measurements.....	162
External Data Logging.....	168
Dynamic Current Correction Control.....	172
Measurement System Bandwidth.....	173
Averaged Measurements.....	174
Agilent N6781A and N6782A Current Histogram Measurements ..	175
Measurement Data Formats.....	178
 Appendix A - Specifications	 179
Agilent N6705A, N6705B DC Power Analyzer Mainframe.....	180
Supplemental Characteristics.....	180
Outline Diagram.....	182
 Appendix B - SCPI Commands and Instrument Settings.....	 183
SCPI Command Summary.....	184
Common Commands.....	193
Interface Settings.....	193
Power-On Settings.....	194
Agilent N678xA SMU Initial Emulation Mode Settings.....	196
 Appendix C - Using the Digital Port.....	 197
Configuring the Digital Port.....	198
Bi-directional Digital I/O.....	198
Digital Input.....	200
Fault Output.....	200
Inhibit Input.....	201
Fault/Inhibit Operating Mode.....	202
Fault/Inhibit System Protection.....	203
Trigger Input.....	203
Trigger Output.....	204
Output Couple Controls.....	205

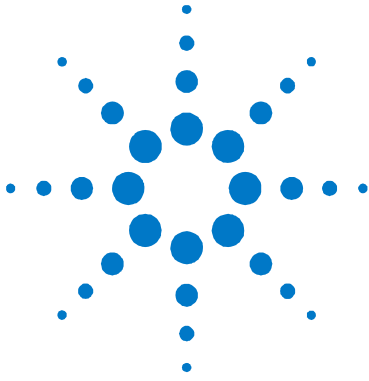

1 Quick Reference

The Agilent N6705 DC Power Analyzer – At a Glance	12
The Front Panel - At a Glance	16
The Rear Panel – At a Glance	17
Meter View	18
Scope View	19
Data Logger	20
Arb Preview	21
Front Panel Menu Reference	22

This chapter concisely describes the operation of the Agilent N6705 DC Power Analyzer.

This chapter does not describe every operating feature in detail. It is simply a quick reference guide to quickly become familiar with the operating features of the Agilent N6705 DC Power Analyzer.

NOTE

Unless otherwise noted, the Agilent N6705 DC Power Analyzer will also be referred to as “DC Power Analyzer” throughout this manual.



The Agilent N6705 DC Power Analyzer – At a Glance

The Agilent N6705 DC Power Analyzer is a multi-functional power system that combines the functions of a multiple-output DC voltage source with the waveform/data capturing capability of an oscilloscope and data logger.

As a multiple-output DC source, the Agilent N6705 provides up to four configurable outputs. Available power modules have power levels of 20 W through 500 W, have various voltage and current combinations, and provide a variety of performance features as described under “Power Module Capabilities”. Each output also has arbitrary (Arb) waveform generation capability, which lets you program predefined voltage and current waveforms – or define your own waveforms. Agilent N678xA Source/Measure Units (SMU) have a multiple-quadrant power mesh with separate voltage and current priority source modes.

As a measurement system, the Agilent N6705 displays the average output voltage and current in Meter View. Waveforms are displayed in Scope View, which you can adjust using vertical and horizontal controls. The Data Logger View measures and charts average and peak voltage and current measurements over an extended period.

Source Features

Color-coded display and output controls	Correspondence between color-coded information on the display and front panel connectors and keys.
Programmable voltage and current	Full programming capability is provided for the entire range of output voltage and current for all power modules.
Low output noise	Available on Agilent N676xA and N675xA power modules. Output noise is <4.5 mV peak-to-peak, which is comparable to linear supplies.
Fast up/down programming	Available on Agilent N675xA, N676xA, and N678xA SMU power modules. ≤1.5 millisecond response time from 10% to 90% of the output rating.
Fast transient response	Available on Agilent N675xA, N676xA, and N678xA SMU power modules. Transient response is less than 100 μs.
Output autoranging capability	Available on Agilent N676xA and N675xA power modules. Autoranging supplies the maximum rated power over a continuous range of voltage and current settings.
Output On/Off sequencing	A turn-on/turn-off delay capability for each output allows output on/off sequencing.
Front panel binding posts	+ and – output and + and – sense terminals are provided for each output. Sense terminals provide 4-wire voltage measurements.
Output protection	Outputs have over-voltage, over-current, and over-temperature protection.
Emergency shut-off	An emergency stop button to quickly shut down all outputs.
Multiple-Quadrant operation	Available on Agilent N678xA SMU and N6783A power modules. 2- and 4-quadrant operation provides source and sink output capability.

Measurement Features

Multiple-output/Single-output meter display	Switch between a 4-output summary view and a 1-output detailed view of power supply information. All power modules display real-time output voltage and current measurements as well as status information.
Scope-like display	Voltage and/or current waveforms of all outputs can be simultaneously displayed. Adjustable markers provide calculated measurements.
Data logging display	Average, minimum, and maximum voltage and current values can be logged over an extended time period to the display. Adjustable markers provide calculated measurements.
Measurement functions	Average, minimum, and maximum values are provided for all voltage and current measurements. Output power (Watts) is calculated for all outputs in single-output meter view.
Seamless measurement autoranging	Available on Agilent N6781A and N6782A SMU power modules. Output measurements seamlessly autorange between ranges – however, the 10 μ A current range must be selected manually.
Microampere current measurements	Available on Agilent N678xA SMU power modules. Current measurement can be made as low as 1 μ A in the 10 μ A range.
Fast digitizing	Available on Agilent N678xA SMU power modules. 5.12 μ s/sample for one parameter; 10.24 μ s/sample for two parameters.
Histogram measurement	Available on Agilent N6781A and N6782A SMU power modules. Provides a statistical measurement for profiling the measured current.

System Features

Choice of three interfaces	LAN, USB, and GPIB (IEEE-488) remote programming interfaces are built in. Menus let you set up GPIB and LAN parameters from the front panel.
Built-in Web server	A built-in Web server lets you control the instrument directly from an internet browser on your computer.
SCPI language	The instrument is compatible with the Standard Commands for Programmable Instruments (SCPI).
Savable instrument data	A file management system saves display bitmaps, instrument states, scope results, arbitrary waveforms, and data log results.
Memory port	Front USB port allows files to be saved to an external USB memory device.
Trigger connectors	Rear panel trigger in/out BNC connectors
Low acoustic noise	Low acoustic noise for quiet bench operation.
Universal AC input	Mainframes have universal input voltage capability with active power factor correction.

Power Module Features

Feature (● = available)	DC Power N673xB, N674xB, N677xA	High-Performance N675xA	Precision N676xA
50 W output rating	N6731B – N6736B	N6751A	N6761A
100 W output rating	N6741B – N6746B	N6752A	N6762A
300 W output rating	N6773A – N6777A	N6753A, N6754A	N6763A, N6764A
500 W output rating		N6755A, N6756A	N6765A, N6766A
Output disconnect relays	Option 761	Option 761	Option 761
Output disconnect/polarity reversal relays ^{NOTE 1}	Option 760	Option 760	Option 760
Arbitrary waveform generation	●	●	●
Autoranging output capability		●	●
Voltage or current turn-on priority			N6761A, N6762A
Precision voltage and current measurements			●
Low voltage and current output ranges			N6761A, N6762A
Low voltage and current measurement ranges			●
200 microampere measurement range ^{NOTE 2}			Option 2UA
Voltage or current scope traces	●	●	●
Simultaneous voltage and current scope traces			●
Simultaneous voltage and current data logging ^{NOTE 3}			●
Interleaved voltage and current data logging ^{NOTE 3}	●	●	
Dynamic current correction	●	N6751A, N6752A	N6761A, N6762A
SCPI command list capability ^{NOTE 4}	●	●	●
SCPI command array readback ^{NOTE 4}	●	●	●
SCPI command programmable sample rate ^{NOTE 4}	●	●	●
SCPI command external data logging ^{NOTE 4}	●	●	●
Double-wide (occupies 2 channel locations)		N6753A – N6756A	N6763A – N6766A
Large gate array ^{NOTE 5}		Option LGA	

Notes:

¹ Output current is limited to 10A max. on Models N6742B and N6773A with Option 760.

Option 760 is not available on Models N6741B, N6751A, N6752A, N6761A, and N6762A.

² Option 2UA is only available on Models N6761A and N6762A. It includes Option 761.

³ Option 055 deletes the Data Logger function on Model N6705.

⁴ Only available when using the remote interfaces; not from the front panel.

⁵ Option LGA is required on Models N6751A and N6752A.

Agilent N678xA Power Module Features

Feature (● = available)	Source/Measure Units (SMU)			Application-Specific	
	N6781A	N6782A	N6784A	N6783A-BAT	N6783A-MFG
Output rating	20 W	20 W	20 W	24 W	18 W
2-quadrant operation	●	●		●	●
4-quadrant operation			●		
Auxiliary voltage measurement input	●				
Output disconnect relays	●	●	●	Option 761	Option 761
Arbitrary waveform generation ^{NOTE 1}	●	●	●	●	●
Negative voltage protection	●	●	●	●	●
Voltage or current priority mode	●	●	●		
CC load/CV load	●	●	●		
Battery emulator/charger	●	●	●		
Voltage/current measurement only	●	●	●		
Programmable output resistance	●				
600 mV output range	●	●	●		
300 mA output range	●	●			
100 mA, 10 mA output ranges			●		
1 V, 100 mV measurement ranges	●	●	●		
100 mA, 1 mA, 10 μ A measurement ranges	●	●	●		
150 mA measurement range				●	●
Voltage or current scope traces	●	●	●	●	●
Simultaneous voltage and current scope traces	●	●	●		
Simultaneous voltage and current data logging ^{NOTE 2}	●	●	●		
Interleaved voltage and current data logging ^{NOTE 2}				●	●
Seamless measurement autoranging	●	●			
SCPI command list capability ^{NOTE 1, 3}	●	●	●	●	●
SCPI command array readback ^{NOTE 3}	●	●	●	●	●
SCPI command programmable sample rate ^{NOTE 3}	●	●	●	●	●
SCPI command external data logging ^{NOTE 3}	●	●	●	●	●
SCPI command histogram measurements ^{NOTE 3}	●	●			

Notes:

¹ Arbitrary waveform generation and List capability are not available on the negative current output on Model N6783A.

² Option 055 deletes the Data Logger function on Model N6705.

³ Only available when using the remote interfaces; not the front panel.

The Front Panel - At a Glance

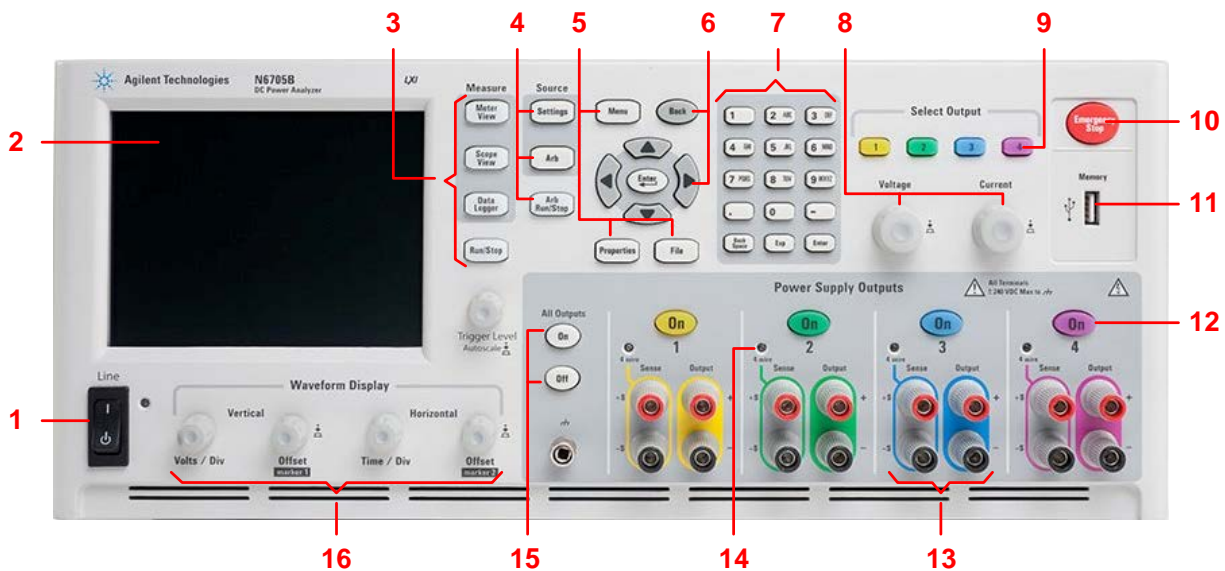

- | | |
|--------------------------------------|---|
| 1 Line switch | Turns the instrument On or Off. |
| 2 Display | Displays all instrument functions - information changes based on selected function. |
| 3 Measure keys | Selects the measurement function - Meter View, Scope View, or Data Logger. Run/Stop key starts or stops the scope or data log measurement. |
| 4 Source keys | Programs the source function – Source Settings or Arbitrary waveform. Arb Run/Stop key starts or stops the arbitrary waveform function. |
| 5 Menu, Properties, File keys | Menu key accesses all mode controls via a hierarchical command menu. Properties key displays information specific to the active view (this is a menu shortcut). File key lets you save the current display, instrument settings, and measurements. |
| 6 Navigation keys | Navigate through the control dialog windows; press the Enter key to select a control. Back key cancels the values entered into the dialog and backs out of the control. |
| 7 Numeric/Alpha Entry keys | Enters numeric and alpha values. Alpha keys automatically become active on fields that allow alpha character entry. Repeatedly pressing the key scrolls through the selections. |
| 8 Voltage/Current knobs | Sets the voltage and current of the selected output. |
| 9 Select Output keys | Selects an output to control. The lit key indicates the selected output. |
| 10 Emergency Stop | Turns off all outputs without any delays; aborts any arbitrary waveforms. |
| 11 Memory port | USB Memory device connector. Option AKY deletes the connector. |
| 12 On keys | Turns individual outputs On or Off; outputs are on when the key is lit. |
| 13 Binding posts | + and – output and sense banana terminals for all outputs. |
| 14 4 Wire | Indicates that 4 Wire sensing is enabled on the output. |
| 15 All Outputs On/Off keys | Turns all outputs On and Off according to the specified turn-on and turn-off delays. |
| 16 Waveform Display controls | Controls the scope and data logging views. Vertical knobs control the vertical size and position. Press Offset to set marker 1. Horizontal knobs control the horizontal size and position. Press Offset to set marker 2. The Trigger knob moves the trigger level up or down. Press this knob to autoscale. |

The Rear Panel – At a Glance

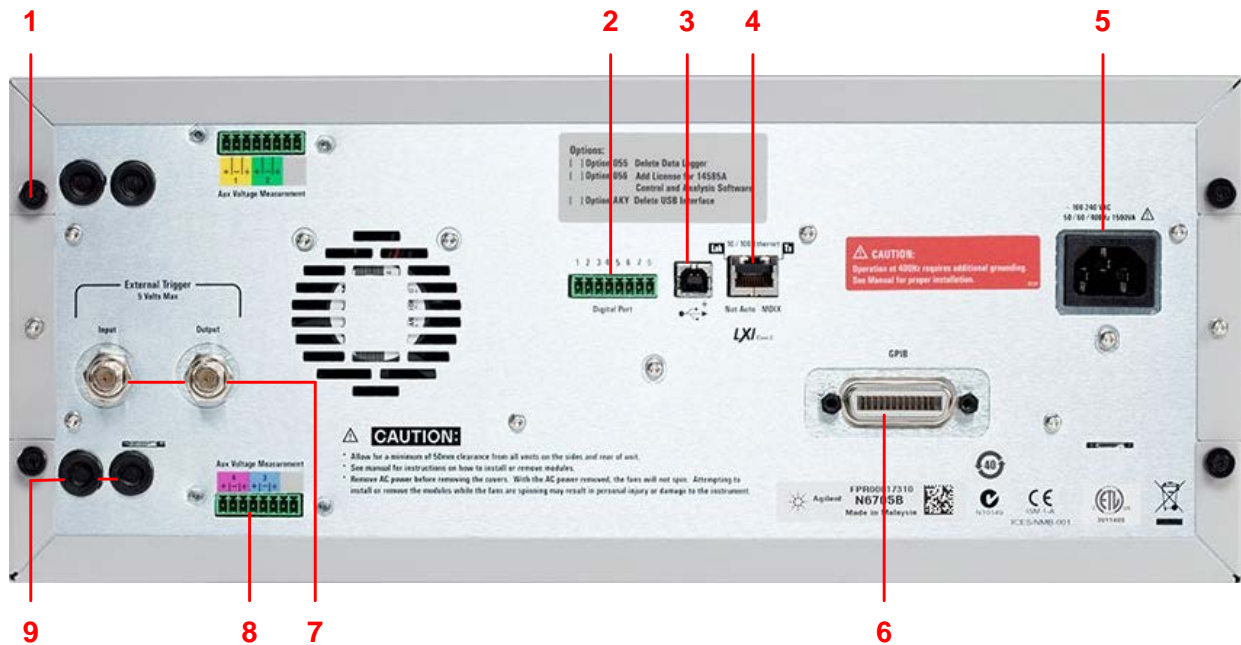

- | | |
|--|--|
| 1 Cover screw | Facilitates top and bottom cover removal for power module installation. |
| 2 Digital Port connector | Connects to the 8-pin digital port. Port functions are user-configurable. Refer to appendix C for details. |
| 3 USB interface connector | Connects to USB interface. May be disabled from front panel menu. Option AKY deletes the connector. |
| 4 LAN interface connector | Connects to 10/100 Base-T interface. Left LED indicates activity. Right LED indicates link integrity. May be disabled from front panel menu. |
| 5 AC input connector | 3-pin IEC 320 AC input connector. Power cord requires ground conductor. |
| 6 GPIB interface connector | Connects to GPIB interface. May be disabled from front panel menu. |
| 7 Trigger connectors | BNC connectors for trigger in and trigger out signals. Refer to Appendix A for signal descriptions. |
| 8 Aux Voltage Measurement connector | Auxiliary voltage measurement connector. Only available on Agilent N6705B mainframes for use with Agilent N6781A power modules. |
| 9 Wiring access ports | Access for sense and output wire connections. Only available on Agilent N6705B mainframes. Used for output connections on power modules rated > 20 A. Also used for Agilent N678xA SMU power modules when extremely precise measurements or output guarding is required. |

WARNING

SHOCK HAZARD The power cord provides a chassis ground through a third conductor. Be certain that your power outlet is of the three-conductor type with the correct pin connected to earth ground.

Meter View

Press
Meter View
 This key toggles between multiple and single output views

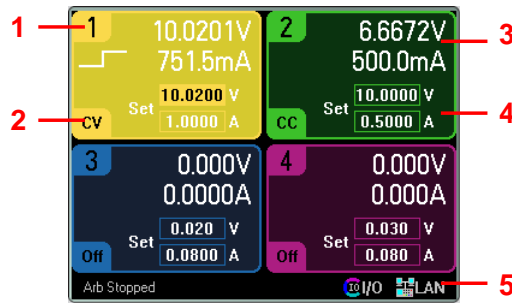

Multiple Output View

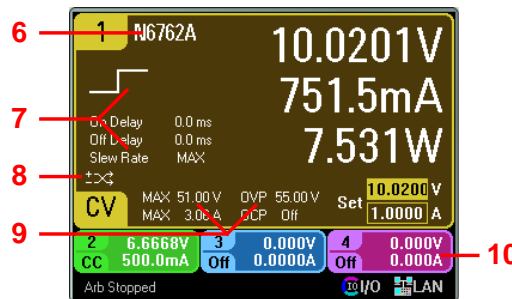

Single Output View

- | | | | | | | | | | | | | | | | | | |
|--|--|------------------------|-------------------------------------|--|--|--|-------------------------------------|--------------------------------|---|--|-------------------------------------|--|---|--|---|--|---|
| 1 Output Identifier | Identifies the output. When an output is selected, the background becomes highlighted. The selected output is displayed in an enlarged format in single output view. | | | | | | | | | | | | | | | | |
| 2 Output Status | <table border="0"> <tr> <td>Off: the output is off</td> <td>Ov: over-voltage protection tripped</td> </tr> <tr> <td>CV: the output is in constant voltage mode</td> <td>Ov-: negative voltage protection tripped</td> </tr> <tr> <td>CC: the output is in constant current mode</td> <td>OC: over-current protection tripped</td> </tr> <tr> <td>Unr: the output is unregulated</td> <td>OT: over-temperature protection tripped</td> </tr> <tr> <td>CP+, CP-: a positive or negative power limit</td> <td>PF: a power-fail condition occurred</td> </tr> <tr> <td>CL+, CL-: a positive or negative current limit</td> <td>Inh: an external inhibit signal is received</td> </tr> <tr> <td>VL+, VL-: a positive or negative voltage limit</td> <td>Osc: the oscillation protection tripped</td> </tr> <tr> <td></td> <td>Prot: a coupled output protect occurred</td> </tr> </table> | Off: the output is off | Ov: over-voltage protection tripped | CV: the output is in constant voltage mode | Ov-: negative voltage protection tripped | CC: the output is in constant current mode | OC: over-current protection tripped | Unr: the output is unregulated | OT: over-temperature protection tripped | CP+, CP-: a positive or negative power limit | PF: a power-fail condition occurred | CL+, CL-: a positive or negative current limit | Inh: an external inhibit signal is received | VL+, VL-: a positive or negative voltage limit | Osc: the oscillation protection tripped | | Prot: a coupled output protect occurred |
| Off: the output is off | Ov: over-voltage protection tripped | | | | | | | | | | | | | | | | |
| CV: the output is in constant voltage mode | Ov-: negative voltage protection tripped | | | | | | | | | | | | | | | | |
| CC: the output is in constant current mode | OC: over-current protection tripped | | | | | | | | | | | | | | | | |
| Unr: the output is unregulated | OT: over-temperature protection tripped | | | | | | | | | | | | | | | | |
| CP+, CP-: a positive or negative power limit | PF: a power-fail condition occurred | | | | | | | | | | | | | | | | |
| CL+, CL-: a positive or negative current limit | Inh: an external inhibit signal is received | | | | | | | | | | | | | | | | |
| VL+, VL-: a positive or negative voltage limit | Osc: the oscillation protection tripped | | | | | | | | | | | | | | | | |
| | Prot: a coupled output protect occurred | | | | | | | | | | | | | | | | |
| 3 Output Meters | Displays the actual output voltage and current. Displays power in single output view. | | | | | | | | | | | | | | | | |
| 4 Output Settings | Displays the present output voltage and current settings. Turn the front panel voltage or current knob to adjust these settings. Can also be changed using the numeric keypad. | | | | | | | | | | | | | | | | |
| 5 Interface Status | Error – an error has occurred (press the Menu key, select Utilities, then Error Log)
LAN – the LAN is connected and has been configured
IO – there is activity on one of the remote interfaces | | | | | | | | | | | | | | | | |
| 6 Model Number | Identifies the model number of the power module connected to this output. | | | | | | | | | | | | | | | | |
| 7 Arb, Delay, & Slew Rate | Displays the Arb waveform that is presently configured for this output. If no Arb is configured, no waveform will be displayed. Also displays the Output On and Output Off delay settings as well as the slew rate setting. | | | | | | | | | | | | | | | | |
| 8 Polarity Reverse | Indicates that the output and sense polarities are reversed. | | | | | | | | | | | | | | | | |
| 9 Ratings & Protection | Displays the maximum voltage and current ratings of the output. Also displays the present over-voltage protection setting and whether over-current protection is on or off. | | | | | | | | | | | | | | | | |
| 10 Other Outputs | Displays the actual voltage, current, and status of the other outputs. | | | | | | | | | | | | | | | | |

Scope View

Press

Scope View

This key toggles between standard and marker views.

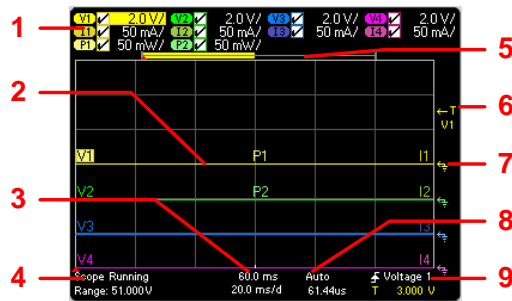

Standard View

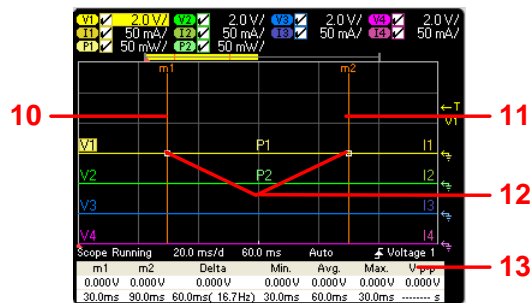

Marker View

- 1 Trace Controls** Identifies the voltage or current trace that will be displayed. Dashes (----) indicate that the specified trace is turned off. Select the trace and press Enter to turn it on or off.
- 2 Output Traces** V1, V2, V3, and V4 indicate voltage traces. I1, I2, I3, and I4 indicate current traces. P1 and P2 indicate power traces. Press Trigger Level knob to autoscale all traces.
- 3 Horizontal Time-base** Identifies the horizontal time-base settings. These can be adjusted using the front panel Horizontal Time/Div and Offset knobs.
- 4 Scope Status** Indicates whether the scope is idle, running, or waiting for a trigger.
- 5 Data Bar** The highlighted area shows how much of the entire measurement is actually shown on the display. Use the Horizontal Time/Div knob and Offset knob to adjust the display
- 6 Trigger Level** Identifies the trigger level through which the waveform must pass before the scope will trigger. This can be adjusted using the Trigger Level knob.
- 7 Ground** Identifies the ground reference level for the trace. This can be adjusted using the Vertical Offset knob. The initial vertical offset of each trace is set to a different level to prevent the traces from overlapping.
- 8 Trigger Mode** Identifies the trigger mode setting. This can be selected by pressing the Properties key.
- 9 Trigger Source** Identifies the trigger source and trigger level. Voltage 1 indicates a voltage level on output 1 is the trigger source (see #6).
- 10 M1 Marker** Measurement Marker 1 enabled. Adjust using Marker 1 knob. Press knob to reset.
- 11 M2 Marker** Measurement Marker 2 enabled. Adjust using Marker 2 knob. Press knob to reset.
- 12 Intersect Point** Shows where the measurement markers intersect the waveform.
- 13 Measurements** Shows the calculations of the waveform data between Marker 1 and Marker 2.

Data Logger

NOTE

Option 055 deletes the Data Logger function on Model N6705.

Press
Data Logger
 This key
 toggles
 between
 standard and
 marker views

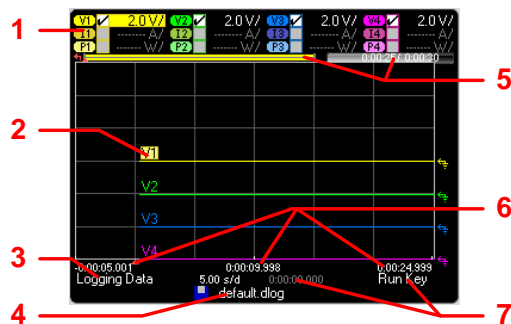

Standard View

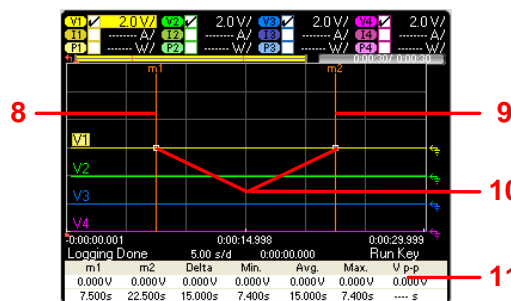

Marker View

- 1 Trace Controls** Identifies the voltage or current trace that will be displayed. Dashes (----) indicate that the specified trace is turned off. Select the trace and press Enter to turn it on or off.
- 2 Output Traces** Voltage, current, or power traces. Voltage traces V1,V2, V3 and V4 shown. Press Trigger Level knob to autoscale all traces.
- 3 Status** Indicates whether the Data Logger is logging data, done logging, or is empty.
- 4 Filename** Indicate the file to which the data is being logged.
- 5 Data Bar & Time Elapsed** Displays the progress of the data logger. The yellow bar indicates the visible data. Numbers to the right indicate time elapsed/total duration.
- 6 Time base Information** Displays the time remaining before the trigger point; the time at the center line of the grid in relation to trigger point; and the time elapsed since the trigger.
- 7 Trigger** Identifies the trigger source and trigger offset. The trigger offset is specified in % of the total duration, but shown in seconds on the display.
- 8 M1 Marker** Measurement Marker 1 enabled. Adjust using Marker 1 knob. Press knob to reset.
- 9 M2 Marker** Measurement Marker 2 enabled. Adjust using Marker 2 knob. Press knob to reset.
- 10 Intersect Point** Shows where the measurement markers intersect the waveform.
- 11 Measurements** Shows the calculations of the waveform data between Marker 1 and Marker 2.

Arb Preview

Press . This dialog displays the arbitrary waveforms that have been configured.

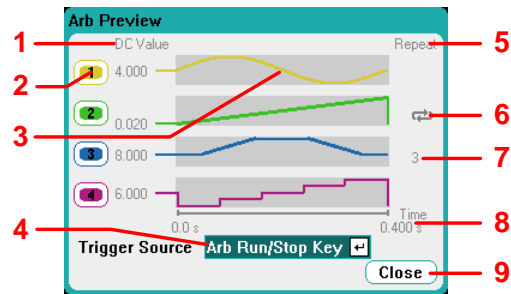

Arb Preview

- 1 DC Value** This column indicates the present output voltage or current setting that appears at the output before the Arb is run. The output will return to this value after the Arb complete if the **Return to DC value** box has been checked. If the **Last Arb Value** box is checked, the output will remain at the last programmed Arb value.
- 2 Output** This column identifies the output channel on which the associated waveform will run. Use the navigation keys to select an output if you wish to select an Arb or edit the Arb on that output channel.
- 3 Wave shapes** This column illustrates the waveshapes that will run on each output when the arb(s) are started. Note that all Arbs will run simultaneously.
- 4 Trigger Source** This dropdown list selects the trigger source for all configured Arbs.
- 5 Repeat** This column indicates how many times the Arb will repeat if it has been configured to repeat. If the column is blank, the Arb will only run once.
- 6 ** Indicates that the Arb on output 2 runs continuously.
- 7 3** Indicates that the Arb on output 3 repeats three times.
- 8 Time** Indicates the time that the longest Arb will run. In this example, all Arbs run the same amount of time.
- 9 Close** Closes the Arb Preview and returns to the previous measurement view.

Front Panel Menu Reference

Menu Heading	Description
Source Settings ▶	
Voltage and Current Settings...	Configures the voltage and current settings, ranges, and emulation modes.
Protection...	Configures the over-voltage and over-current protection. Enables output coupling so ALL outputs are disabled when a fault occurs. Also clears output protection.
Advanced Protection...	Enables/disables the output inhibit function.
Output On/Off Delays...	Configures output on/off delays.
Output On/Off Coupling...	Couples specific outputs for the output on/off and delay function.
Output Grouping...	Groups identical outputs for output paralleling function.
Advanced...	Configures advanced functions including voltage slew rate, sensing, and power limit.
Ratings...	Displays power module ratings, serial number, firmware, and option information.
Arb ▶	
Arb Preview	Displays the present status of the arbitrary waveforms that have been configured.
Arb Selection...	Selects arbitrary waveforms for each output. Arb Properties configures the selected Arb.
Meter ▶	
All Outputs Meter View	Displays the meter view of all outputs.
Single Output Meter View	Displays the meter view of the selected output.
Meter Properties...	Configures the meter view voltage and current measurement ranges.
Scope ▶	
Standard View	Displays the standard scope view including vertical, horizontal, and trigger settings.
Marker View	Displays the measurement markers and measurement calculations area.
Scope Properties...	Configures the scope traces and voltage and current measurement ranges for individual outputs. Also configures the trigger source, mode, and horizontal offset.
Marker Properties...	Configures the measurements that appear on the bottom of the display in Marker view.
Horizontal Properties...	Configures the horizontal offset reference and sample points.
Datalogger ▶	
Standard View	Displays the data log strip chart view including vertical, horizontal, and progress settings.
Marker View	Displays the measurement markers and measurement calculations area.
Datalogger Properties...	Configures the data log traces and voltage and current measurement ranges for individual outputs. Also configures the data log duration, sample period, and Min/Max values.
File Name Selection...	Specifies the filename for the next data logger acquisition.
Marker Properties...	Configures the measurements that appear on the bottom of the display in Marker view.
File ▶	
Save...	Saves an instrument state or a scope measurement.
Load...	Loads an instrument state, scope data, or logged data.
Export...	Exports scope data, logged data, or a user-defined arbitrary waveform
Import...	Imports a user-defined arbitrary waveform.
Screen Capture...	Captures the screen that was active when the File key was pressed.
File Management...	Accesses additional file functions: New Folder, Delete, Rename, Copy, File Details.
Reset/Recall/Power-On State...	Resets the instrument to factory defaults; Saves/recalls instrument states; and specifies the power-on turn on state.

Front Panel Menu Reference (continued)

Menu Heading	Description
Utilities ▶	
Error Log...	Lists all error messages.
I/O Configuration ▶	
Active LAN Status...	Displays the LAN status and active settings.
LAN Settings...	Configures the LAN interface.
GPIB/USB...	Configures the GPIB and USB interface.
User Preferences ▶	
Front Panel Preferences...	Configures screen saver, front panel key functions, and initial meter view.
Front panel Lockout...	Password-protects the front panel keys.
Clock Setup...	Sets up the internal clock.
Administrative Tools ▶	
Administrator Login/Logout...	Accesses the password-protected administrative functions.
Calibration ▶	Accesses the calibration functions.
I/O Access...	Enables/disables the LAN, Web server, and USB.
Nonvolatile RAM Reset...	Resets all non-volatile memory settings to the factory defaults.
Disk Management...	Checks the internal drive.
Firmware Update...	Installs updated firmware from the front panel Memory port.
Install Options...	Installs additional firmware options.
Change Admin Password...	Changes the administrator password.
Digital I/O...	Configures the digital port. All seven pins of the digital port can be individually configured.
Help ▶	
Overview...	A brief overview.
Quick Start ▶	How to quickly get started.
Using the Agilent N6705 ▶	How to use the Agilent N6705.
Using the Utilities ▶	How to use the utilities.
Front Panel Controls ▶	How to use the front panel controls.
Front Panel Navigation...	How to navigate the front panel display.
Module Capabilities and Ratings	How to obtain module capabilities/ratings.
About	Identifies the mainframe and the installed modules

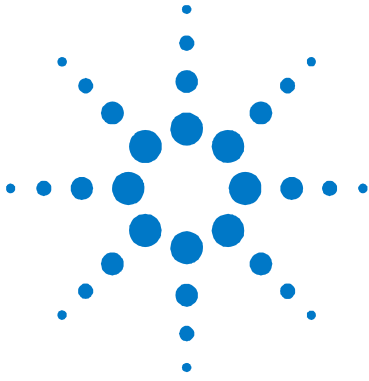

2 Installation

General Information	26
Inspecting the Unit	27
Installing the Unit	28
Connecting the Line Cord	33
Connecting the Outputs	33
Connecting the BNC Connectors	44
Connecting the Digital Port	45
Connecting the Auxiliary Voltage Measurement Input	46
Connecting to the Interfaces	47
Communicating Over the LAN	54

This chapter describes how to install your DC Power Analyzer. It discusses rack mounting and line cord connections.

This chapter also discusses how to connect your load to the output terminals, wiring considerations as well as series/parallel connections.

Finally, detailed information is provided about connecting to the GPIB, USB, and LAN interfaces.



General Information

Models

Agilent Model	Description
N6705A, N6705B	600 W DC Power Analyzer mainframe - without power modules
N6715A, N6715B	Build-to-order DC Power Analyzer system - mainframe with installed power modules
N6731B / N6741B	50 W / 100 W 5 V DC Power Module
N6732B / N6742B	50 W / 100 W 8 V DC Power Module
N6733B / N6743B / N6773A	50 W / 100 W / 300 W 20 V DC Power Module
N6734B / N6744B / N6774A	50 W / 100 W / 300 W 35 V DC Power Module
N6735B / N6745B / N6775A	50 W / 100 W / 300 W 60 V DC Power Module
N6736B / N6746B / N6776A, N6777A	50 W / 100 W / 300 W 100 V DC Power Module
N6751A / N6752A	50 W / 100 W High-Performance Autoranging DC Power Module
N6753A, N6754A / N6755A, N6756A	300 W / 500 W High-Performance Autoranging DC Power Module
N6761A / N6762A	50 W / 100 W Precision DC Power Module
N6763A, N6764A / N6765A, N6766A	300 W / 500 W Precision DC Power Module
N6781A, N6782A, N6784A	20 W Source/Measure Unit (SMU)
N6783A-MFG / N6783A-BAT	18 W / 24 W Application-Specific DC Power Module

Options

Mainframe Options	Description
ABA	English Manual Set. Contains User's Guide and Service Guide. Also available as p/n N6705-90000.
ABJ	Japanese Manual Set. Contains User's Guide and Service Guide. Also available as p/n N6705-90403.
AB1	Korean Manual Set. Contains User's Guide and Service Guide. Also available as p/n N6705-90406.
AB2	Chinese Manual Set. Contains User's Guide and Service Guide. Also available as p/n N6705-90408.
AKY	Deletes the front and rear panel USB connector.
055	Deletes the Data Logger function.
056	Agilent 14585A Control and Analysis Software.
908	Rack Mount Kit. For mounting in a 19-inch EIA rack cabinet. Also available as p/n 5063-9215.
909	Rack Mount Kit with handles. Also available as p/n 5063-9222.
Power Module Options	
760 ^{NOTE 1}	Output disconnect/polarity reversal. Disconnects the + and – output and sense terminals. Switches the + and – output and sense polarities. Not available on N6741B, N6751A, N6752A, N676xA, or N678xA.SMU.
761 ^{NOTE 1}	Output disconnect. Disconnects + and – output and sense terminals. Available for all power modules.
LGA	Large gate array. Required on Models N6751A, N6752A for use in the DC Power Analyzer.
UK6	Commercial calibration with test results data
1A7	ISO 17025 calibration certificate
2UA	200 microampere measurement range with output disconnect relays. Only on Models N6761A, N6762A.

¹ A small AC network is always present across the output terminals.

Items Supplied

Mainframe Items	Description	Part Number
Power Cord	A power cord suitable for your location.	Call Agilent Sales & Support Office
Digital Connector plug	8-pin connector for connecting signal lines to the digital port.	Agilent 1253-6408 Phoenix Contact MC 1,5/8-ST-3,5
AUX Measurement Connector plug (2)	8-pin connector plugs for connecting the auxiliary measurement inputs. Only used with Agilent Model N6781A.	Agilent 1253-6408 Phoenix Contact MC 1,5/8-ST-3,5
Spare grommets	Two spare grommets for rear panel sense and load wiring.	Agilent 0400-1009
Product Reference CD-ROM	Includes drivers and documentation.	Agilent 14585-13601
Automation-Ready CD-ROM	Contains Agilent IO Libraries Suite.	Agilent E2094R
Quick Start Tutorial	A tutorial to help you quickly get started.	Agilent N6705-90005
T-10 Torx tool	Torx tool for installing or removing power modules.	Agilent 8710-2416
Power Module Items		
8 A Output Connector plug	One 8 A, 8-pin connector plug for connecting power and sense leads. Only used in N678xA SMU.	Agilent 1253-6408 Phoenix Contact MC 1,5/8-ST-3,5
12 A Output Connector plug	One 12 A, 4-pin connector plug for connecting power and sense leads. Used in all except N6731B, N6741B, N6753A-N6756A, N6763A-N6766A, N6773A, N678xA SMU.	Agilent 1253-5826 Phoenix Contact MSTB 2,5/4-STF
20 A Output Connector plug	One 20 A, 4-pin connector plug for connecting power and sense leads. Only used in N6731B, N6741B, N6754A, N6756A, N6764A, N6766A, N6773A.	Agilent 1253-6211 Phoenix Contact PC 4/4-ST-7,62
50 A Output Connector plug	One 50 A, 2-pin connector plug for connecting power leads. Only used in N6753A, N6755A, N6763A, N6765A.	Agilent 1253-7187 Molex 39422-0002
AUX Measurement connector plug	A 2-pin connector plug for connecting the auxiliary measurement inputs. Only used in N6781A.	Agilent 1253-8485 Phoenix Contact FMC 1,5/2-ST-3,5
Small Sense Jumpers	Two small jumpers for local sensing at the output connector. Used in all except N6731B, N6741B, N6753A-N6756A, N6763A-N6766A, N6773A, N678xA SMU.	Agilent 8120-8821 Phoenix Contact EPB 2-5(1733169)
Large Sense Jumpers	Two large jumpers for local sensing at the output connector. Only used in N6731B, N6741B, N6754A, N6756A, N6764A, N6766A, N6773A.	Agilent 0360-2935 Phoenix Contact 3118151
Sense Connector	A 4-pin connector for connecting sense leads. Wires (p/n 5185-8847) are used for local sensing. Only used in N6753A, N6755A, N6763A, N6765A.	Agilent 1253-5830 Phoenix Contact MC 1,5/4-ST-3,5
Module Cal. Certificate	A certificate of calibration referenced to the serial number.	N/A

Inspecting the Unit

When you receive your DC Power Analyzer, inspect it for obvious damage that may have occurred during shipment. If there is damage, notify the shipping carrier and nearest Agilent Sales and Support Office immediately. Refer to www.agilent.com/find/assist.

Until you have checked out the DC Power Analyzer, save the shipping carton and packing materials in case the unit has to be returned. Check the list under “Items Supplied” and verify that you have received these items with your instrument. If anything is missing, please contact your nearest Agilent Sales and Support Office.



Installing the Unit

Safety Considerations

This DC Power Analyzer is a Safety Class 1 instrument, which means it has a protective earth terminal. That terminal must be connected to earth ground through a power source equipped with a ground receptacle.

Refer to the Safety Summary page at the beginning of this guide for general safety information. Before installation or operation, check the DC Power Analyzer and review this guide for safety warnings and instructions. Safety warnings for specific procedures are located at appropriate places throughout this Guide.

Environment

WARNING Do not operate the instrument in the presence of flammable gasses or fumes

The environmental conditions of the instrument are documented in Appendix A. Basically, the instrument should only be operated indoors in a controlled environment.

The dimensions of your instrument as well as an outline diagram are given in Appendix A. Fans cool the DC Power Analyzer by drawing air through the side and exhausting it out the opposite side and back. The instrument must be installed in a location that allows sufficient space at the sides and back of the unit for adequate air circulation.

Cleaning

WARNING **SHOCK HAZARD** To prevent electric shock, unplug the unit before cleaning.

Use a dry cloth or one slightly dampened with water to clean the external case parts. Do not use detergent or chemical solvents. Do not attempt to clean internally.

Power Module Location

The location of the power modules inside the mainframe determines their front panel output assignments. To view the module/output assignments, turn the unit on, press the **Settings** key, then press **Properties**. The power modules are listed under each output channel.

Outputs that are not connected to a power module will not be displayed in the Meter view.

Power Module Installation

NOTE

The information in this section applies if you have purchased an N6705 mainframe without the power modules installed, or if you are adding a power module to the mainframe.

CAUTION

Turn the mainframe off and disconnect the power cord before installing or removing power modules. Observe all standard electrostatic discharge precautions before handling electronic components.

Tools required: T10 Torx driver;
Small flat-blade screwdriver
5.5 mm hex wrench

Firmware Note: Newer power modules can only be installed in N6705 mainframes with the latest firmware. Refer to the “Updates” section in the front of this manual for more information. If your mainframe has the latest firmware version, install the power module. If not, download and install the latest version firmware from the web.

Step 1. Remove the top and bottom covers.

Loosen the thumb-screws to remove the covers. Turn the unit upside-down to remove the bottom cover.

Step 2. Place the power modules in the mainframe

Align the power module over the pins and gently push it down onto the connector. Install the screws at each end of the power module.

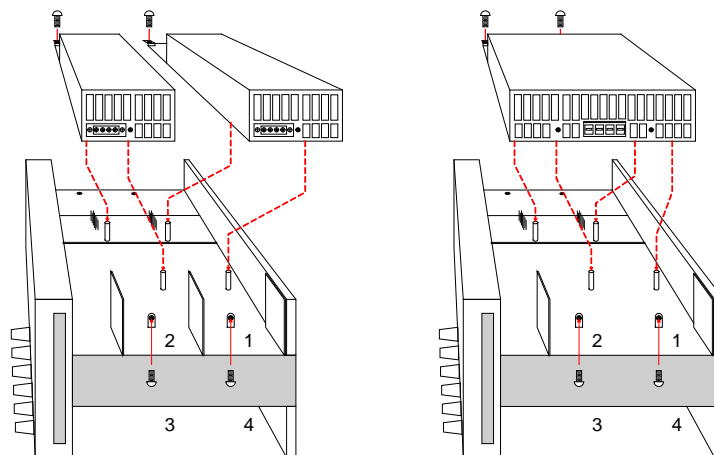

NOTE

If you are installing a double-wide power module, you must first remove the center deflector. Use a T10 Torx to remove the top deflector; use a 5.5 mm hex to remove the bottom deflector. Install the deflector in the storage location on the opposite end of the module. Connect the power module to output 1 or output 3 only.

Step 3. Connect the front panel wire harness.

For power modules that use 12 A output connectors –

Simply push the 12 A connector plug into the power module. Tighten the locking screws on the connector.

For power modules with 20 A output connectors –

On N6705B mainframes, remove the 12 A connector plug from the wire harness and install the 20 A connector plug provided with the power module. Observe the output color code. Tighten all connector screws. Install the connector in the module.

On N6705A mainframes, install the wire harness with the 20 A connector plug directly into the power module.

For power modules with 50 A output connectors –

see “High Current Output Connections”.

- 1. To front panel binding post.
- 2. 20 A connector

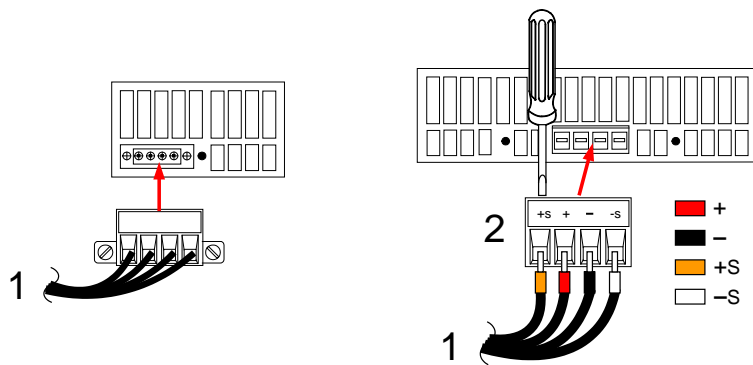

For Agilent N678xA SMU power modules –

Remove the 12A connector plug from the wire harness and install the 8-pin connector plug provided with the power module. Install the front panel cable wires in the output connector as shown. Observe the output color code. Tighten all connector screws. An adapter “A” is required to install modules in Agilent N6705A mainframes.

For model N6781A, install the auxiliary measurement (Aux Meas) cable. Remove the Aux Meas cable from its storage location and insert the connector into the power module. The color code corresponds to the rear panel Aux Voltage Measurement label.

- 1. To front panel binding post.
- 2. Aux Meas connector
- 3. To rear panel connector
- A. Adapter A required for N6705A mainframes only

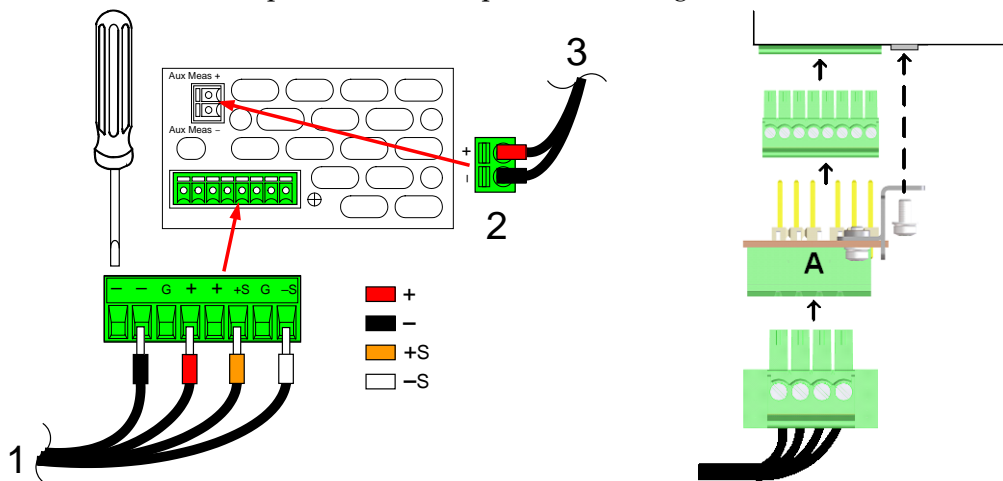

Step 4. Finish the Installation.

Place any unused cable harnesses in the clip ring located between the power modules and the front panel. Install the top and bottom covers. Push the covers into place and tighten the thumbscrews.

High Current Output Connections

NOTE

This information only applies to power modules with output current ratings of 50 A.

CAUTION

Do not connect the front panel cable assembly to the high current output power modules.

Because the front panel binding posts have a maximum current rating of 20 A, they are not available for use with the above models.

High current (50 A) load connections are made using the rear panel access ports of the Agilent N6705B. These access ports have a thin rubber membrane which can be pierced using the load wires.

User-supplied load and sense wires must be used to connect to the output and sense connector plugs on the high current power module.

Step 1. Route the load wires through the rear panel.

Push the high current load wires through the rear panel access port. If you are using remote sensing, route the sense wires through the second access port. Twist each wire pair.

Step 2. Connect the wires to the power module.

Connect the load wires to the output connector of the power module as shown. Connect the sense wires to the sense connector.

Step 3. Finish the Installation.

Place any unused cable harnesses in the clip ring located between the power modules and the front panel. Install the top and bottom covers. Push the covers into place and tighten the thumbscrews.

1. 50 A output connector
2. Sense connector
3. Twist leads
4. To load



Bench Installation

CAUTION

Do not block the air intake and exhaust at the sides, or the exhaust at the rear of the unit. Refer to the outline diagram in Appendix A.

Minimum clearances for bench operation are 2 inches (51 mm) along the sides and back.

For easier display viewing and binding post access, you can tilt the front of the unit up by rotating the extension bar down.

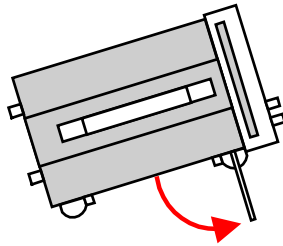

Rack Installation

CAUTION

Use Rack Mount kit (Option 908 or Option 909 with handles) to rack mount the instrument. Installation instructions are provided with the rack mount kit.

Agilent N6705 DC Power Analyzer mainframes can be mounted in a 19-inch EIA rack cabinet. They are designed to fit in four rack-units (4U) of space.

Remove the feet before rack mounting the unit. Do not block the air intake and exhausts at the sides and rear of the unit.

400 Hz Operation

Redundant Ground Requirement

At 400 Hz AC input operation, the leakage current of the unit exceeds 3.5 mA. This requires the installation of a permanent, redundant ground from the instrument chassis to earth ground. This ensures that ground will always be connected and that any leakage current will be diverted to ground. Refer to the “Connecting the BNC Connectors” later in this chapter for installation instructions.

Power Factor

Refer to Appendix A for power factor statistics at 400 Hz operation.

Connecting the Line Cord

WARNING

FIRE HAZARD Use only the power cord that was supplied with your instrument. Using other types of power cords may cause overheating of the power cord, resulting in fire.

SHOCK HAZARD The power cord provides a chassis ground through a third conductor. Be certain that your power outlet is of the three-conductor type with the correct pin connected to earth ground.

Connect the power cord to the IEC 320 connector on the rear of the unit. If the wrong power cord was shipped with your unit, contact your nearest Agilent Sales and Support Office.

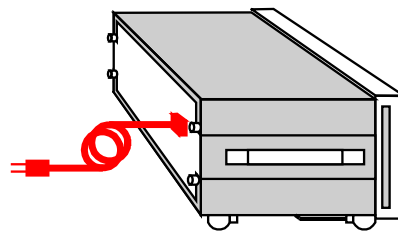

The AC input on the back of your unit is a universal AC input. It accepts nominal line voltages in the range of 100 VAC to 240 VAC. The frequency can be 50 Hz, 60 Hz, or 400 Hz.

NOTE

The detachable power cord may be used as an emergency disconnecting device. Removing the power cord will disconnect AC input power to the unit.

Connecting the Outputs

WARNING

SHOCK HAZARD Turn off all outputs before making front or rear panel connections. All wires and straps must be properly connected with the binding posts securely tightened.

The binding posts accept wires sizes up to AWG 14 in location (A). The maximum binding post current rating at location (A) is 20 A. Securely fasten all wires by hand-tightening the binding posts. A chassis ground binding post is located on the front panel for convenience.

You can also insert standard banana plugs into the front of the connectors as shown in (B). The maximum binding post current rating at location (B) is 15 A.

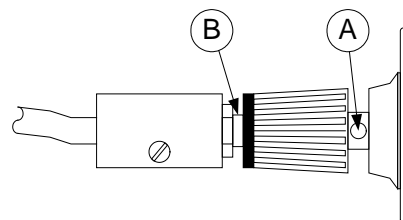

Wire Size and Length

WARNING

FIRE HAZARD Select a wire size large enough to carry short-circuit current without overheating (refer to the table below). To satisfy safety requirements, load wires must be heavy enough not to overheat while carrying the short-circuit output current of the unit. Agilent Model N678xA SMU wiring requirements are described on the following page.

Along with conductor temperature, you must also consider voltage drop when selecting wire sizes. The following table lists the resistance for various wire sizes and the maximum lengths to limit the voltage drop to 1.0 V per lead for various currents.

Note that the minimum wire size required to prevent overheating may not be large enough to prevent over-voltage tripping or maintain good regulation. Under most conditions, the load wires should also be heavy enough to limit the voltage drop to no more than 1.0 V per lead.

To help prevent nuisance tripping of the over-voltage circuit, select a wire size sufficient to handle the FULL output current of the unit no matter what the intended load current or current limit setting

Load lead resistance is also an important factor relating to the CV stability of the instrument when remote sensing capacitive loads. If high capacitance loads are expected, you should not use wire gauges heavier than 12 to 14 AWG for long runs of load lead.

Wire size	Current-carrying capacity in Amps for stranded copper wire		Resistance	Max. Length to Limit Voltage to 1 V/Lead			
	2 wires bundled	4 wires bundled		for 5 A	for 10 A	for 20A	for 50 A
AWG	2 wires bundled	4 wires bundled	Ω/foot	Wire length in feet			
20	7.8	6.9	0.0102	20	x	x	x
18	14.5	12.8	0.0064	30	15	x	x
16	18.2	16.1	0.0040	50	25	x	x
14	29.3	25.9	0.0025	80	40	20	x
12	37.6	33.2	0.0016	125	63	30	x
10	51.7	45.7	0.0010	200	100	50	20
8	70.5	62.3	0.0006	320	160	80	32
6	94	83	0.0004	504	252	126	50
Area in mm²	2 wires bundled	4 wires bundled	Ω/meter	Wire length in meters			
0.5	7.8	6.9	0.0401	5	x	x	x
0.75	9.4	8.3	0.0267	7.4	x	x	x
1	12.7	11.2	0.0200	10	5	x	x
1.5	15.0	13.3	0.0137	14.6	7.2	x	x
2.5	23.5	20.8	0.0082	24.4	12.2	6.1	x
4	30.1	26.6	0.0051	39.2	19.6	9.8	3.9
6	37.6	33.2	0.0034	58	29	14.7	5.9
10	59.2	52.3	0.0020	102	51	25	10.3

Notes: 1. Capacity for AWG wires derived from MIL-W-5088B. Max. ambient temp: 55°C. Max. wire temp: 105°C.

2. Capacity for metric wires are derived from IE Publication 335-1.

3. Capacity of aluminum wire is approximately 84% of that listed for copper wire.

4. "x" indicates wire is not rated for the maximum output current of the power module.

5. Because of wire inductance considerations, it is also recommended that you keep your load leads twisted, tie wrapped, or bundled together and less than 50 feet (14.7 meters) in length per lead.

Agilent N678xA SMU Wiring Requirements

NOTE

Because of the effect of wire inductance, the wire length information given in the previous table does not apply to Agilent Models N678xA SMU.

To minimize the effect of wire inductance, the following table describes the allowable load lead and wire length for several common cable types. Using longer (or shorter) cable lengths than those indicated in the table may cause output oscillation.

Cable Type	To N6705 front panel binding post		To N678xA module connector	
	Length in feet	Length in meters	Length in feet	Length in meters
Twisted pair (AWG 14 or smaller)	0 to 3.25 ft	0 to 1 m	1 to 4.25 ft	0.3 to 1.3 m
50 ohm coaxial (RG-58)	0 to 6.5 ft	0 to 2 m	2 to 10 ft	0.6 to 3 m
10 ohm coaxial (inductance per cable foot ≤ 32 nH)	0 to 26 ft	0 to 8 m	8.5 to 33 ft	2 to 10 m

High Bandwidth Modes with Remote Sensing

The following wiring requirements apply when using Agilent Models N678xA SMU in the High bandwidth modes with remote sensing.

Refer to chapter 6 under “Output Bandwidth” for more information about the bandwidth settings.

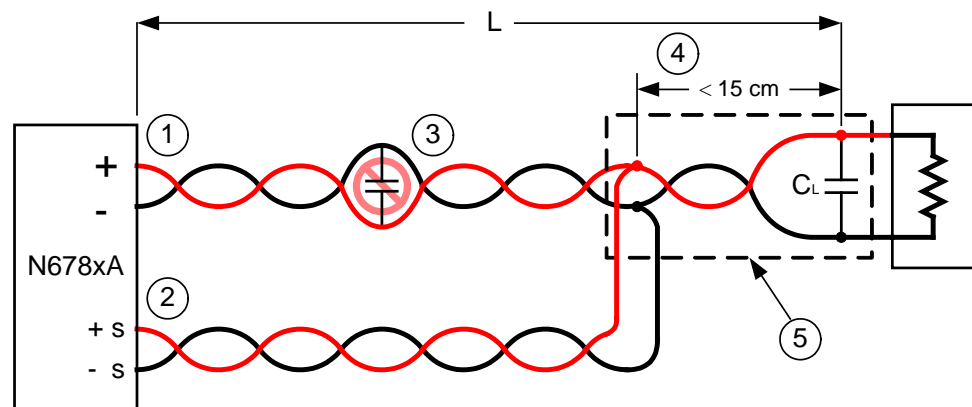

- 1) Load wires must be twisted-pair or coax and must *not* be twisted with the sense wires. Refer to the above table for length (L).
- 2) Sense wires must be twisted-pair or coax and must *not* be twisted with the load wires.
- 3) No capacitors are allowed within the sense-compensated load path.
- 4) If the load capacitor (C_L) is not located at the sense point, the distance from the sense point to the load capacitor cannot exceed 15 cm and must be twisted-pair, coax, or pc traces.
- 5) If the test fixture consists of pc traces, the positive and negative traces should be directly facing on adjacent layers.

To minimize inductance, the width (w) of the traces should be *at least* as great as the thickness of the dielectric (h). It is better to make the traces much wider than this minimum requirement in order to minimize the DC resistance.

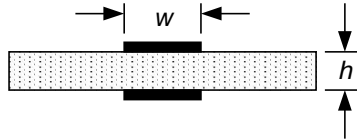

Low Bandwidth Mode with Remote or Local Sensing

All previously stated wiring requirements still apply in Low bandwidth mode except for the following.

The 15 cm maximum limit between the sense point and the load capacitor (see #4) does not apply when using Low bandwidth mode.

Guard Connection

The purpose of a cable guard is to eliminate the effects of leakage current that can exist in the current path of the external test circuit. The cable guard can be used when the test fixture requires guarding and the DC Power Analyzer is sourcing or measuring DC currents under $1\mu\text{A}$. Without a guard, leakage currents in the test circuit could affect the accuracy of the micro-ampere measurements. Guarding is generally not required when measuring currents $1\mu\text{A}$ and greater.

NOTE

You cannot connect to the front panel binding posts when using the Guard. You must route ALL wires (guard, load, and sense) through the rear panel access ports of the N6705B mainframe. Refer to the diagram under “High Current (50 A) Output Connections” for more information. These access ports can also be used when extremely precise output measurements are required.

As shown below, cable guards are available at the internal connector of Agilent Models N678xA SMU. The guard is typically used to drive the shields of cables and test fixtures. It provides a buffered voltage that is at the same potential as the + output terminals of the module connector. The guard current is limited to about $300\mu\text{A}$.

- 1. Internal N678xA SMU connector
- 2. Guard shield (can be the shield of a coaxial cable)

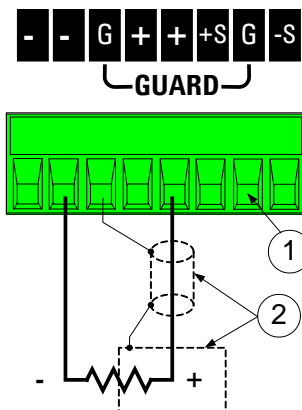

Multiple Loads

If you are connecting multiple loads to one output, connect each load to the output terminals using separate connecting wires as shown.

1. Twist leads
2. 4-wire disabled (indicator is off)

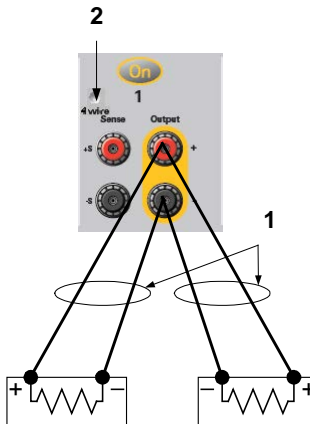

This minimizes mutual coupling effects and takes full advantage of the DC Power Analyzer's low output impedance. Keep each pair of wires as short as possible and twist or bundle them to reduce lead inductance and noise pickup. Keep the load leads under 14.7 meters (50 feet) per lead because of inductance effects.

Agilent Models N678xA SMU have additional wiring restrictions as discussed under “Agilent N678xA SMU Wiring Requirements”.

If load considerations require the use of distribution terminals that are located away from the instrument, connect the output terminals to the remote distribution terminals by a pair of twisted or bundled wires. Connect each load to the distribution terminals separately. 4-wire sensing is recommended under these circumstances. Sense either at the remote distribution terminals or, if one load is more sensitive than the others, directly at the critical load.

4-Wire Sense Connections

The DC Power Analyzer includes built-in relays that connect or disconnect the \pm sense terminals from their corresponding \pm output terminals. As shipped, the sense terminals are internally connected to the output terminals. This is referred to as Local sensing.

4-wire, or remote sensing improves the voltage regulation at the load by monitoring the voltage at the load rather than at the output terminals. This automatically compensates for the voltage drop in the load leads, which is especially useful for CV operation with load impedances that vary or have significant lead resistance. Because remote sensing is independent of other DC Power Analyzer functions, it can be used regardless of how the instrument is programmed. Remote sensing has no effect during CC operation.

The following figures illustrate load connections using local sensing (A), and 4-wire remote sensing (B). When the **4-wire** indicator above the sense terminals is on, it indicates that the sense terminals must be connected to the load.

2 Installation

1. Twist leads
2. 4-wire disabled (indicator is off)
3. 4-wire enabled (indicator is on)

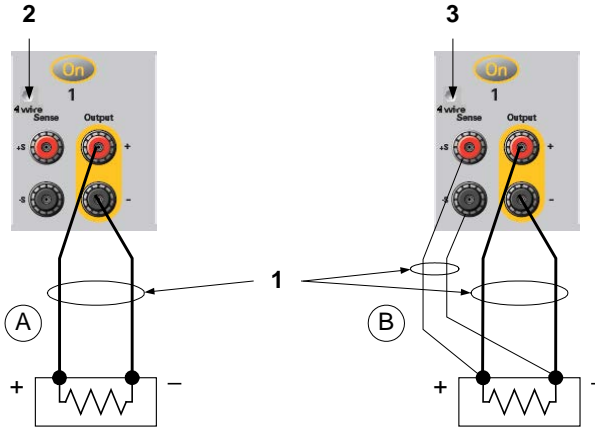

Connect the load to the output terminals using separate connecting wires. Keep the wire-pair as short as possible and twist or bundle it to reduce lead inductance and noise pickup. Keep the load leads under 14.7 meters (50 feet) per lead because of inductance effects.

Connect the sense leads as close to the load as possible. Do NOT bundle the sense wire-pair together with the load leads; keep the load wires and sense wires separate. The sense leads carry only a few milliamperes of current and can be a lighter gauge than the load leads. However, any voltage drop in the sense leads can degrade the voltage regulation of the instrument. Try to keep the sense lead resistance less than about 0.5Ω per lead (this requires 20 AWG or heavier for a 50 foot length).

Agilent Models N678xA SMU require remote sensing when using any of the High output bandwidth modes discussed in Chapter 6. Also, these models have additional wiring restrictions as discussed under “Agilent N678xA SMU Wiring Requirements”.

After turning the unit on, activate 4-wire remote voltage sensing by pressing the **Settings** key. Navigate to and select **Advanced**. In the Sense dropdown list select **4-Wire**.

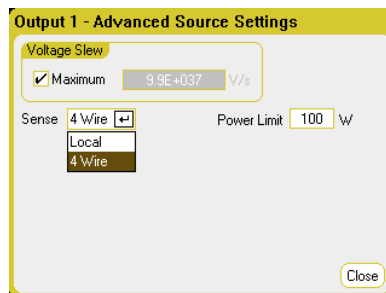

Open Sense Leads

The sense leads are part of the output's feedback path. Connect them so that they do not inadvertently open. The DC Power Analyzer has protection resistors that reduce the effect of open sense leads during 4-wire sensing. If the sense leads open during remote sensing, the output returns to local sensing mode, with the voltage at the output terminals approximately 1% higher than the programmed value.

Over-Voltage Protection Considerations

You must take into account any voltage drop in the load leads when setting the over-voltage trip point. This is because the OVP circuit senses at the output terminals and not at the sense terminals. Due to the voltage drop in the load leads, the voltage sensed by the OVP circuit could be higher than the voltage being regulated at the load.

Note that for Agilent Models N678xA SMU only, the OVP circuit senses at the 4-wire sense terminals rather than at the output terminals. This allows for more precise over-voltage monitoring directly at the load. Since incorrect sense terminal wiring could defeat this feature, there is also a backup local OVP function.

This local OVP function tracks the programmed OVP setting and trips if the voltage at the + and - output terminals rises more than 1.5 V above the programmed OVP setting. The local OVP also trips if the voltage at the + and - output terminals exceeds 7.5 V on the 6 V range and 21.5 V on the 20 V range.

Output Noise Considerations

Any noise picked up on the sense leads will appear at the output terminals and may adversely affect CV load regulation. Twist the sense leads to minimize the pickup of external noise. In extremely noisy environments it may be necessary to shield the sense leads. Ground the shield at the DC Power Analyzer end only; do not use the shield as one of the sensing conductors.

The noise specifications documented in the Agilent N6700 Modular Power System Family Specifications Guide apply at the output terminals when using local sensing. However, voltage transients may be produced at the load by noise induced in the leads or by load current transients acting on the inductance and resistance of the load lead. If it is desirable to keep voltage transient levels to a minimum, place an aluminum or tantalum capacitor, with an approximate value of 10 μF per foot (30.5 cm) of load lead, right across the load.

Parallel Connections

CAUTION

Only connect outputs that have identical voltage and current ratings in parallel. Agilent Models N678xA SMU cannot be connected in parallel.

Connecting outputs in parallel provides a greater current capability than can be obtained from a single output.

The following figures show how to connect two outputs in parallel. The figure on the left illustrates local sensing. If voltage drop in the load leads is a concern, the figure on the right shows how to connect the sense leads directly at the load (4-wire sensing).

Once outputs have been connected in parallel, they can be configured or “grouped” to act as a single, higher-power output. This applies when programming via the front panel or using SCPI commands. How to group outputs that have been connected in parallel is discussed in Chapter 6 under “Output Grouping”.

1. Twist leads
2. 4-wire disabled (indicator is off)
3. 4-wire enabled (indicator is on)

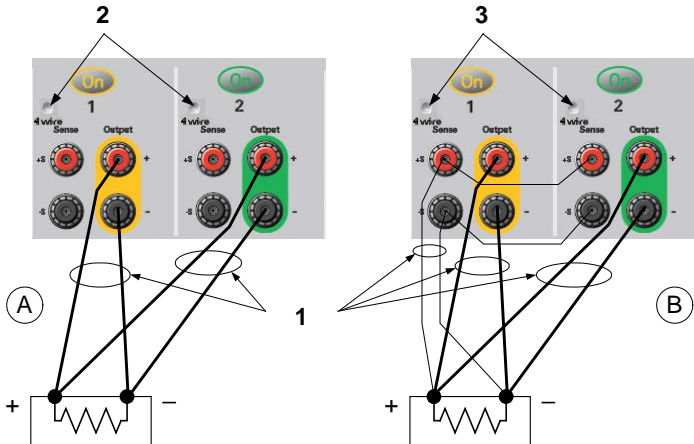

Effect on Specifications

Specifications for outputs operating in parallel can be obtained from the specifications for single outputs. Most specifications are expressed as a constant or as a percentage (or ppm) plus a constant. For parallel operation, the percentage portion remains unchanged while constant portions or any constants are changed as indicated below. For current readback accuracy and temperature coefficient of current readback, use the minus current specifications:

Current All parallel specifications referring to current are twice the single output specification except for programming resolution, which is the same for both single output and parallel output operation.

Voltage All parallel specifications referring to voltage are the same as for a single output except for CV load effect, CV load cross regulation, CV source effect, and CV short term drift. These are all twice the voltage programming accuracy (including the percentage portion) at all operating points.

Load Transient Recovery Time Load transient specifications are typically twice the single output.

Series Connections

WARNING

SHOCK HAZARD Floating voltages must not exceed 240 VDC. No output terminal may be more than 240 VDC from chassis ground.

CAUTION

Only connect outputs that have identical voltage and current ratings in series. Agilent Models N678xA SMU and N6783A-x cannot be connected in series.

To prevent reverse currents from damaging the DC Power Analyzer when the load is connected, always turn series-connected outputs on and off together. Do not leave one output on while the other is off.

NOTE

You can only use the series-connected outputs in “standard” power supply mode. You cannot generate arbitrary waveforms, make scope measurements or use data logging on outputs that are connected in series.

Connecting outputs in series provides a greater voltage capability than can be obtained from a single output. Because the current is the same through each element in a series circuit, outputs connected in series must have equivalent current ratings.

The following figures show how to connect two outputs in series to a single load. If voltage drop in the load leads is a concern, connect the sense leads of output 1 and output 2 for remote sensing as shown in the figure on the right. Connecting the +S terminal of output 2 to the -S terminal of output 1 and connecting a jumper between +S and + on output 2 compensates for the IR drop in the load lead from output 2 to output 1.

1. Twist leads
2. 4-wire disabled (indicator is off)
3. 4-wire enabled (indicator is on)

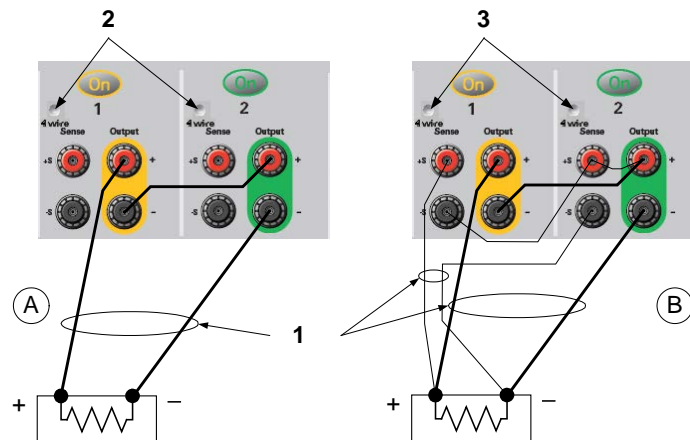

To program outputs connected in series, first program the current limit of each output to the total desired current limit point. Then program the voltage of each output so that the sum of both voltages equals the total desired operating voltage. The simplest way to accomplish this is to program each output to one half of the total desired operating voltage.

NOTE

The operating mode of each output is determined by the output's programmed settings, operating point, and load condition. Because these conditions may change during series operation, the operating status indicators on the front panel will reflect these changes. This is normal. Momentary status changes are also normal.

Effect on Specifications

Specifications for outputs operating in series can be obtained from the specifications for single outputs. Most specifications are expressed as a constant or a percentage (or ppm) plus a constant. For series operation, the percentage portion remains unchanged while constant portions or any constants are changed as indicated.

Voltage All series specifications referring to voltage are twice the single output specification except for programming resolution, which is the same as for a single output.

Current All series specifications referring to current are the same as for a single output except for CC load effect, CC load cross regulation, CC source effect, and CC short term drift. These are twice the current programming accuracy (including the percentage portion) at all operating points.

Load Transient Recovery Time Load transient specifications are typically twice the single output.

Additional Load Considerations

Response Time with an External Capacitor

When programming with an external capacitor, voltage response time may be longer than that for purely resistive loads. Use the following formula to estimate the additional up-programming response time:

$$\text{Response Time} = \frac{(\text{Added Output Capacitor}) \times (\text{Change in } V_{\text{out}})}{(\text{Current Limit Setting}) - (\text{Load Current})}$$

Note that programming into an external output capacitor may cause the DC Power Analyzer to briefly enter constant current or constant power operating mode, which adds additional time to the estimation.

Positive and Negative Voltages

Either positive or negative voltages with respect to ground can be obtained from the output by grounding (or "commoning") one of the output terminals. Always use two wires to connect the load to the output regardless of where or how the system is grounded. The instrument can be operated with any output terminal ± 240 VDC including output voltage from ground.

NOTE

Agilent Models N678xA SMU are optimized for grounding the negative output terminal. Grounding the positive terminal may result in increased current measurement noise and a reduction in current measurement accuracy.

Protecting Sensitive Loads from AC Power Switching Transients

NOTE

If your load is connected directly to the output binding posts and is **not** connected to chassis ground in any way, you do not need to worry about AC power switching transients appearing at the output binding posts.

Operating the AC line switch can inject common mode current spikes into the DC output leads, resulting in voltage spikes that may damage loads that are highly sensitive to voltage or current transients. Note that any electronic device meeting international standards for EMI compliance is likely to generate similar current spikes. This situation arises from the presence of EMI filters at both the AC input and the DC output. These filters typically include common mode capacitors connected to the chassis of the DC Power Analyzer. Since the AC input has an earth ground, any load that is also earth-grounded provides a possible return path for common mode currents.

The following steps will help mitigate common mode current spikes appearing at the output binding posts when the DC Power Analyzer is turned on or off by the AC line switch:

- Install a separate "bonding" wire from the load's common point, to the ground terminal of the DC Power Analyzer. This provides a lower impedance path that helps direct injected currents away from the DC output leads (and the sensitive load).
- Disconnect the load from the output *before* turning the unit on or off. This **always** protects the load from common mode currents.

Connecting the BNC Connectors

The rear panel BNC connectors let you apply trigger signals to the instrument as well as generate trigger signals from the instrument. This also applies to the digital port.

Trigger Input - Allows a negative-going external signal to trigger the instrument. The signal must have a minimum pulse width of two microseconds. Trigger input signals are used by the Arb, Scope, and Data Logger functions.

Trigger Output - Generates a negative-going 10 microsecond pulse when a triggered event has occurred on the instrument. Trigger output signals can be generated by the user-defined voltage or current Arb functions.



Information on configuring external triggers is found in Appendix C. The electrical characteristics are described in Appendix A.

Installing a Redundant Ground for 400 Hz Operation

Operation at 400 Hz requires the installation of a redundant ground from the instrument chassis to earth ground. The redundant ground must be permanently attached to the unit as well as to the earth ground point.

The following procedure describes how to make the permanent connection at the unit using **one** of the two rear panel BNC connectors. The user must ensure the integrity and permanence of the connection at the earth ground point.

The following customer-supplied hardware is required:

- Ground wire (14/16 AWG)
- Uninsulated ring terminal for attaching wire to unit (Tyco p/n 328976 or equivalent)
- Hardware for attaching wire to earth ground point

The following tools are required for installing the redundant ground:

- 5/8 inch nut driver

Step 1. Use the nut driver and remove the hex nut (1) from only **one** of the BNC connectors. Do not remove the lock washer located behind the hex nut.

Step 2. Crimp the ring terminal (2) onto the end of the ground wire.

- Step 3.** Place the ring terminal onto the threaded BNC connector. Make sure that the lock washer (3) is in place before installing the ring terminal.
- Step 4.** Tighten the hex nut onto the ring terminal.
- Step 5.** Attach the other end of the redundant ground wire to a convenient earth ground point.

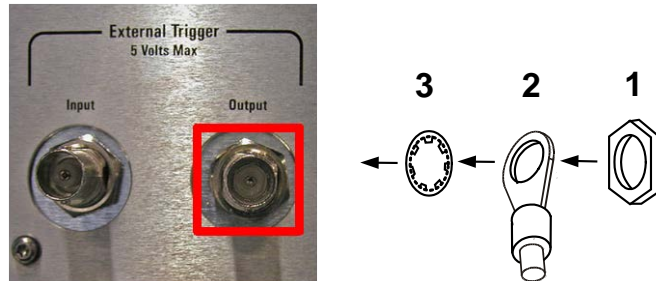

Connecting the Digital Port

NOTE

It is good engineering practice to twist and shield all signal wires to and from the digital connectors. If shielded wire is used, connect only one end of the shield to chassis ground to prevent ground loops.

An 8-pin connector and a quick-disconnect connector plug are provided for accessing the digital port functions. The connector plug accepts wire sizes from AWG 14 to AWG 30. Wire sizes smaller than AWG 24 are not recommended. Disconnect the connector plug to make your wire connections.

1. Insert wires
2. Tighten screws
3. Signal common
4. Digital I/O signals
5. FLT/INH signals
6. Output Couple controls

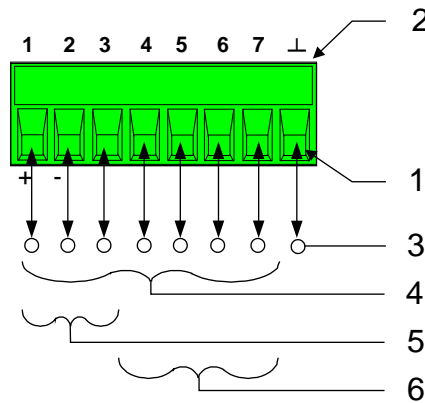

Information on configuring the digital port is found in Appendix C. The electrical characteristics are described in Appendix A.

Connecting the Auxiliary Voltage Measurement Input

NOTE

This information applies to Agilent Model N6781A only.

The auxiliary voltage measurement input is located on the rear panel of the Agilent N6705B. It is primarily used for battery voltage rundown measurements, but it is also suitable for general purpose DC measurements between ± 25 VDC. As shown in the following figure, auxiliary voltage measurements cannot be made on test points that are at a greater potential than ± 25 VDC from Common.

Refer to chapter 4 under “Agilent N6781A Auxiliary Voltage Measurements” for more information.

CAUTION

When using the auxiliary voltage measurement input on Model N6781A, no front panel output terminal or rear panel input terminal may be more than ± 60 VDC from any other terminal and chassis ground.

A. Aux Voltage Measurement input

B. Test Fixture

1. 36 V
2. 24 V
3. 12 V
4. Com.
5. -12 V
6. -24 V
7. -36 V

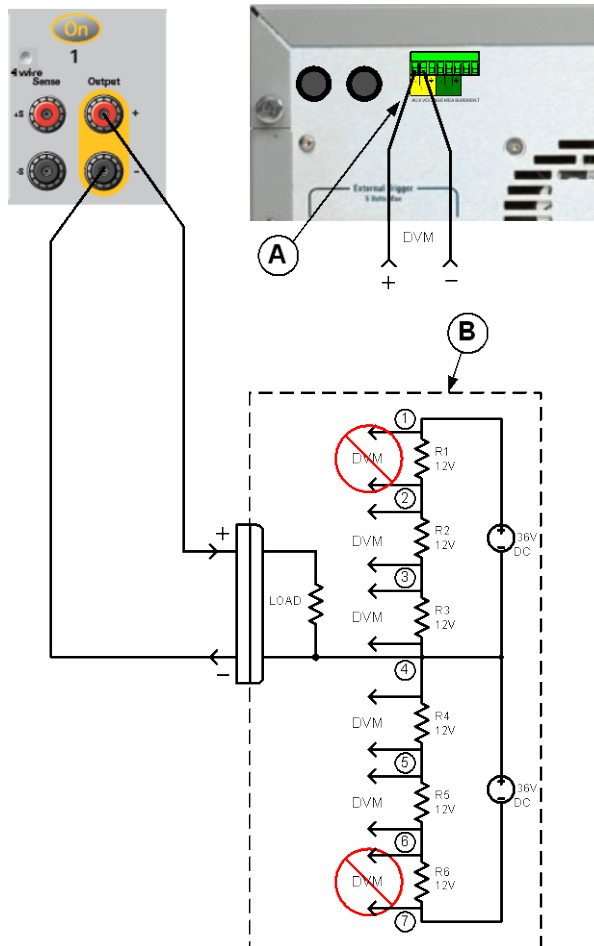

Connecting to the Interfaces

The DC Power Analyzer supports GPIB, LAN, and USB interfaces. All three interfaces are live at power-on. Connect your interface cable to the appropriate interface connector. Information on configuring the interfaces is found later in this chapter.

The front panel **IO** indicator comes on whenever there is activity on the interfaces. The front panel **LAN** indicator comes on when the LAN port is connected and configured.

The DC Power Analyzer provides Ethernet connection monitoring. With Ethernet connection monitoring, the instrument's LAN port is continually monitored, and automatically reconfigured when the instrument is unplugged for a minimum of 20 seconds and then reconnected to a network.

GPIB/USB Interfaces

NOTE

For detailed information about GPIB and USB interface connections, refer to the Agilent Technologies *USB/LAN/GPIB Interfaces Connectivity Guide*, located on the Automation-Ready CD that is shipped with your product.

The following steps will help you quickly get started connecting your instrument to the **GPIB** (General Purpose Interface Bus). The following figure illustrates a typical GPIB interface system.

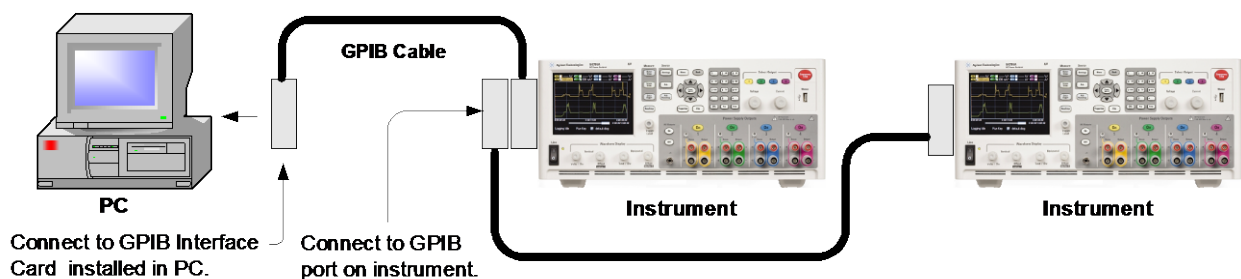

- 1 If you have not already done so, install the Agilent IO Libraries Suite from the Automation-Ready CD that is shipped with your product.
- 2 If you do not have a GPIB interface card installed on your computer, turn off your computer and install the GPIB card.
- 3 Connect your instrument to the GPIB interface card using a GPIB interface cable.
- 4 Use the Connection Expert utility of the Agilent IO Libraries Suite to configure the installed GPIB interface card's parameters.
- 5 The DC Power Analyzer is shipped with its GPIB address set to 5. To view or change the GPIB address, press the **Menu** key, select **Utilities**, then **I/O Configuration**, then **GPIB/USB**.

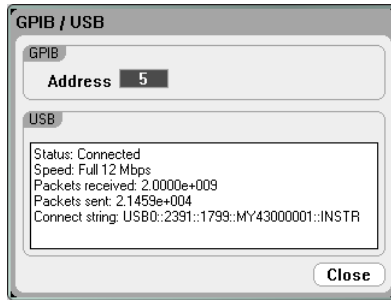

To change the GPIB address, use the numeric keys to enter a value in the GPIB address field. Valid addresses are from 0 to 30. Press **Enter** to enter the value.

- 6 You can now use Interactive IO within the Connection Expert to communicate with your instrument, or you can program your instrument using the various programming environments.

The following steps will help you quickly get started connecting your USB-enabled instrument to the **USB** (Universal Serial Bus). The following figure illustrates a typical USB interface system.

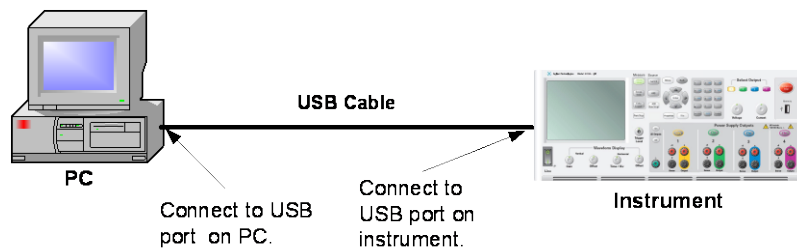

- 1 If you have not already done so, install the Agilent IO Libraries Suite from the Automation-Ready CD that is shipped with your product.
- 2 Connect the USB device port located on the back of your instrument to the USB port on your computer.
- 3 With the Connection Expert utility of the Agilent IO Libraries Suite running, the computer will automatically recognize the instrument. This may take several seconds. When the instrument is recognized, your computer will display the VISA alias, IDN string, and VISA address. This information is located in the USB folder.

You can also view the instrument's VISA address from the front panel. Use the front panel menu to access the **GPIB/USB** window as described above. The VISA address is shown in the connect string field.

- 4 You can now use Interactive IO within the Connection Expert to communicate with your instrument, or you can program your instrument using the various programming environments.

LAN Interface

NOTE

For detailed information about LAN interface connections, refer to the Agilent Technologies *USB/LAN/GPIB Interfaces Connectivity Guide*, located on the Automation-Ready CD that is shipped with your product.

The following steps will help you quickly get started connecting and configuring your instrument on a local area network. The two types of local area networks connections that are discussed in this section are site networks and private networks.

Connecting to a Site LAN

A site LAN is a local area network in which LAN-enabled instruments and computers are connected to the network through routers, hubs, and/or switches. They are typically large, centrally-managed networks with services such as DHCP and DNS servers.

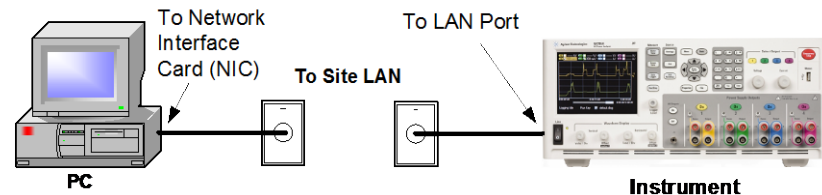

- 1 If you have not already done so, install the Agilent IO Libraries Suite from the Automation-Ready CD that is shipped with your product.
- 2 Connect the instrument to the site LAN. The factory-shipped instrument LAN settings are configured to automatically obtain an IP address from the network using a DHCP server (DHCP is set On). Note that this may take up to one minute. The DHCP server will register the instrument's hostname with the dynamic DNS server. The hostname as well as the IP address can then be used to communicate with the instrument. The front panel **LAN** indicator will come on when the LAN port has been configured.

NOTE

If you need to manually configure any instrument LAN settings, refer to "Configuring the LAN Parameters" later in this chapter for information about configuring the LAN settings from the front panel of the instrument.

- 3 Use the Connection Expert utility of the Agilent IO Libraries Suite to add the N6705 DC Power Analyzer and verify a connection. To add the instrument, you can request the Connection Expert to discover the instrument. If the instrument cannot be found, add the instrument using the instrument's hostname or IP address.

NOTE

If this does not work, refer to the chapter on "Troubleshooting Guidelines" in the Agilent Technologies *USB/LAN/GPIB Interfaces Connectivity Guide*.

- 4 You can now use Interactive IO within the Connection Expert to communicate with your instrument, or you can program your instrument using the various programming environments. You can also use the Web browser on your computer to connect to the instrument as described under “Connecting to the Web Server”.

Connecting to a Private LAN

A private LAN is a network in which LAN-enabled instruments and computers are directly connected, and not connected to a site LAN. They are typically small, with no centrally-managed resources.

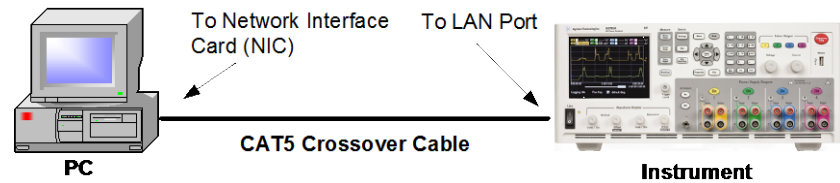

- 1 If you have not already done so, install the Agilent IO Libraries Suite from the Automation-Ready CD that is shipped with your product.
- 2 Connect the instrument to the computer using a LAN crossover cable. Alternatively, connect the computer and the instrument to a standalone hub or switch using regular LAN cables.

NOTE

Make sure your computer is configured to obtain its address from DHCP and that NetBIOS over TCP/IP is enabled. Note that if the computer had been connected to a site LAN, it may still retain previous network settings from the site LAN. Wait one minute after disconnecting it from the site LAN before connecting it to the private LAN. This allows Windows to sense that it is on a different network and restart the network configuration. (Windows 98 requires you to manually release the settings.)

- 3 The factory-shipped instrument LAN settings are configured to automatically obtain an IP address from a site network using a DHCP server, then to automatically choose an IP address using auto-IP if a DHCP server is not present. The instrument and computer are each assigned an IP address from the block 169.254.nnn. Note that this may take up to one minute. The front panel **LAN** indicator will come on when the LAN port has been configured.
- 4 Use the Connection Expert utility of the Agilent IO Libraries Suite to add the N6705 DC Power Analyzer and verify a connection. To add the instrument, you can request the Connection Expert to discover the instrument. If the instrument cannot be found, add the instrument using the instrument's hostname or IP address.

NOTE

If this does not work, refer to the chapter on “Troubleshooting Guidelines” in the Agilent Technologies *USB/LAN/GPIB Interfaces Connectivity Guide*.

- 5 You can now use Interactive IO within the Connection Expert to communicate with your instrument, or you can program your instrument using the various programming environments. You can also use the Web browser on your computer to connect to the instrument as described under “Connecting to the Web Server”.

Viewing the Active LAN Status

To view the currently active LAN settings, press the **Menu** key, scroll down and select the **Utilities**, then select **I/O Configuration**, then **Active LAN Status**.

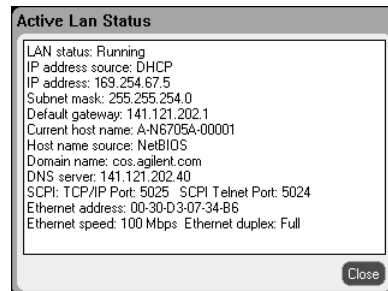

Note that the currently active LAN settings for the IP Address, Subnet Mask, and Default Gateway may be different from the settings specified in the “Modify LAN Settings” window - depending on the configuration of the network. If the settings are different, it is because the network has automatically assigned its own settings.

Modifying the LAN Settings

As shipped from the factory, the DC Power Analyzer’s pre-configured settings should work in most LAN environments. If you need to manually configure these settings, press the **Menu** key, scroll down and select **Utilities**, then **I/O Configuration**, then **LAN Settings**.

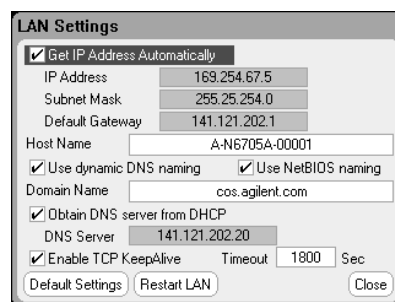

NOTE

Either the Restart LAN button must be selected, or the DC Power Analyzer must be rebooted for any LAN parameter modifications to take effect.

You can configure the following items in the LAN Settings window:

Get IP Address Automatically	<p>With this box checked, the instrument will first try to obtain an IP address from a DHCP server. If a DHCP server is found, the DHCP server will assign an IP address, Subnet Mask, and Default Gateway to the instrument. If a DHCP server is unavailable, the instrument will try to obtain an IP address using AutoIP. AutoIP automatically assigns an IP address, Subnet Mask, and Default Gateway on networks that do not have a DHCP server.</p> <p>With this box unchecked, you can configure the addresses manually by entering values in the following three fields.</p>
IP Address	<p>This value is the Internet Protocol (IP) address of the instrument. An IP address is required for all IP and TCP/IP communications with the instrument. An IP Address consists of 4 decimal numbers separated by periods. Each decimal number ranges from 0 through 255.</p>
Subnet Mask	<p>This value is used to enable the instrument to determine if a client IP address is on the same local subnet. When a client IP address is on a different subnet, all packets must be sent to the Default Gateway.</p>
Default Gateway	<p>This value is the IP Address of the default gateway that allows the instrument to communicate with systems that are not on the local subnet, as determined by the subnet mask setting. A value of 0.0.0.0 indicates that no default gateway is defined.</p>
Host Name	<p>This field registers the supplied name with the selected naming service. If the field is left blank, no name is registered. A hostname may contain upper and lower case letters, numbers and dashes(-). The maximum length is 15 characters. Use the numeric/alpha keys to enter letters or numbers. Repeatedly pressing a key cycles through the list of choices. After a short delay the cursor automatically moves to the right.</p> <p>Each DC Power Analyzer is shipped with a default hostname with the format: A-modelnumber-serialnumber, where <i>modelnumber</i> is the mainframe's 6-character model number (e.g. N6705B), and <i>serialnumber</i> is the last five characters of the 10-character mainframe serial number located on the label on the top of the unit (e.g. 45678 if the serial number is MY12345678). A-N6705B-45678 is an example of a hostname.</p>
Use Dynamic DNS naming	<p>Registers the hostname using the Dynamic DNS naming system.</p>
Use NetBIOS naming	<p>Registers the hostname using the RFC NetBIOS naming protocol.</p>
Domain Name	<p>Registers the Internet domain for the instrument. This is required if your DNS server requires an instrument to register not only the hostname, but also the domain name. The Domain must start with a letter and may contain upper and lower case letters, numbers, dashes(-) and dots(.). Use the numeric/alpha keys to enter letters or numbers. Repeatedly pressing a key cycles through the list of choices. After a short delay the cursor automatically moves to the right.</p>

Obtain DNS server from DHCP	DNS is an internet service that translates domain names into IP addresses. It is also needed for the instrument to find and display its hostname assigned by the network. Check this item to obtain the DNS server address from DHCP. You must have previously checked Get IP Address Automatically .
DNS server	This value is the address of the DNS server. It is used if you are not using DHCP or if you need to connect to a specific DNS server.
Enable TCP Keepalive	Check the Enable box to enable the TCP keepalive function. The instrument uses the TCP keepalive timer to determine if a client is still reachable. If there has been no activity on the connection after the specified time, the instrument will send keepalive probes to the client to determine if it is still alive. If not, the connection will be marked as down or "dropped." The instrument will release any resources that were allocated to that client.
Timeout	This is the delay in seconds before TCP keepalive probes will be sent to the client. It is recommended that the largest value be used that still meets the application's need for unreachable client detection. Smaller keepalive timeout values will generate more keepalive probes (network traffic), using more of the available network bandwidth. Allowed values: 720 - 99999 seconds.
Default Settings	Resets the LAN settings to the factory-shipped state. These settings are listed at the end of chapter 1.
Restart LAN	Restarts networking to use the modified configuration settings.

Communicating Over the LAN

Using the Web Server

Your Agilent N6705 DC Power Analyzer has a built-in Web server that lets you control it directly from an internet browser on your computer. Up to **two** simultaneous connections are allowed. With additional connections, performance will be reduced.

With the Web server, you can access the front panel control functions including the LAN configuration parameters. This is a convenient way to communicate with the DC Power Analyzer without using I/O libraries or drivers.

NOTE

The built-in Web server only operates over the LAN interface. It requires Internet Explorer 7+ or Firefox 2+. You also need the Java (Sun) Plug-in. This is included in the Java Runtime Environment. Refer to Sun Microsystem's website. If you are using Internet Explorer 7, open a separate browser window for each connection.

The Web server is enabled when shipped. To launch the Web server:

- 1 Open the internet browser on your computer.
- 2 Enter the instrument's hostname or IP address into the browser's Address field to launch the Web server. The following home page will appear:

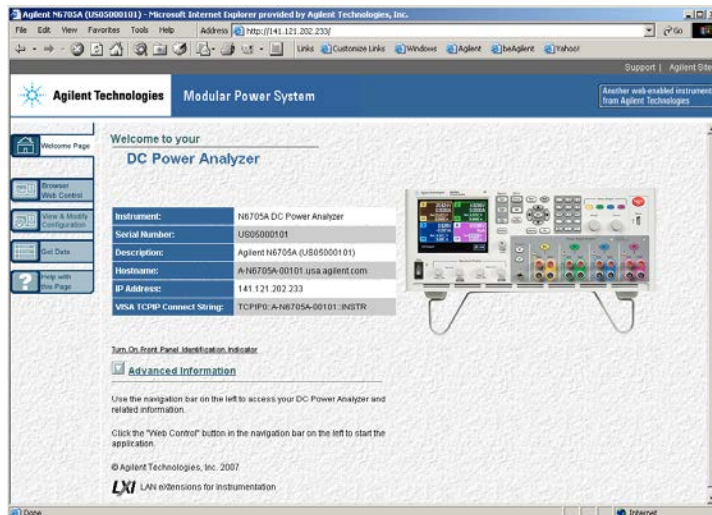

- 3 Click on the Browser Web Control button in the navigation bar on the left to begin controlling your instrument.
- 4 For additional help about any page, click Help with this Page.

If desired, you can control access to the Web server using password protection. As shipped from the factory, no password is set. To set a password, click on the View & Modify Configuration button. Refer to the on-line help for additional information about setting a password.

Using Telnet

The Telnet utility (as well as sockets), is another way to communicate with the DC Power Analyzer without using I/O libraries or drivers. In all cases, you must first establish a LAN connection from your computer to the DC Power Analyzer as previously discussed.

In an MS-DOS Command Prompt box type: *telnet hostname 5024* where *hostname* is the N6705 hostname or IP address, and 5024 is the instrument's telnet port. You should get a Telnet session box with a title indicating that you are connected to the DC Power Analyzer. Type the SCPI commands at the prompt.

Using Sockets

NOTE

Agilent N6705 mainframes allow any combination of up to **four** simultaneous data socket, control socket, and telnet connections to be made.

Agilent instruments have standardized on using port 5025 for SCPI socket services. A **data socket** on this port can be used to send and receive ASCII/SCPI commands, queries, and query responses. All commands must be terminated with a newline for the message to be parsed. All query responses will also be terminated with a newline.

The socket programming interface also allows a **control socket** connection. The control socket can be used by a client to send device clear and to receive service requests. Unlike the data socket, which uses a fixed port number, the port number for a control socket varies and must be obtained by sending the following SCPI query to the data socket: `SYSTem:COMMunicate:TCPip:CONTRol?`

After the port number is obtained, a control socket connection can be opened. As with the data socket, all commands to the control socket must be terminated with a newline, and all query responses returned on the control socket will be terminated with a newline.

To send a device clear, send the string "DCL" to the control socket. When the DC Power Analyzer has finished performing the device clear it echoes the string "DCL" back to the control socket.

Service requests are enabled for control sockets using the Service Request Enable register. Once service requests have been enabled, the client program listens on the control connection. When SRQ goes true the instrument will send the string "SRQ +nn" to the client. The "nn" is the status byte value, which the client can use to determine the source of the service request.

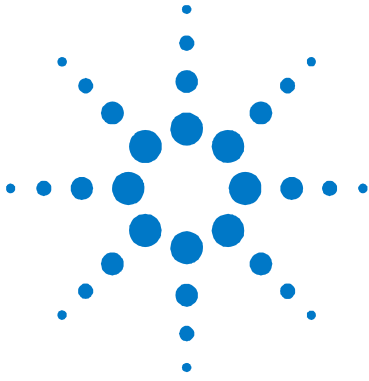

3 Using the Source Functions

Turning the Unit On	58
Using the Power Supply	60
Using the Arbitrary Waveform Generator	75

This chapter contains examples on how to operate your DC Power Analyzer. The examples provided show you how to use the:

- Power supply function
- Arbitrary waveform generator

Equivalent SCPI commands to program a specific function are included at the end of each topic. However some functions such as the front panel Scope View, Data Logger View, and some Administrative functions do not have equivalent SCPI commands. Appendix B lists all of the SCPI commands that can be used to program the instrument.

NOTE

For complete details on using the SCPI commands, refer to the Programmer's Reference Help file included on the Agilent N6705 Product Reference CD. This CD-ROM is shipped along with your instrument.



Turning the Unit On

After you have connected the line cord, turn the unit on using the Line switch. The front panel display lights up after a few seconds. When the front panel Meter View appears, use the front panel knobs to enter voltage and current values. Output 1 is selected by default.



Press one of the four **On** keys to enable an individual output. In Meter View the DC Power Analyzer continuously measures and displays the output voltage and current of each output.

NOTE

A *power-on* self-test occurs automatically when you turn the unit on. This test assures you that the instrument is operational. If the self-test fails, the front panel will display any errors.

View the Error Log

The front panel **Error** indicator comes on if self-test fails or if other operating problems occur with your instrument. To display the error list, press the **Menu** key, scroll and select **Utilities**, then **Error Log**.

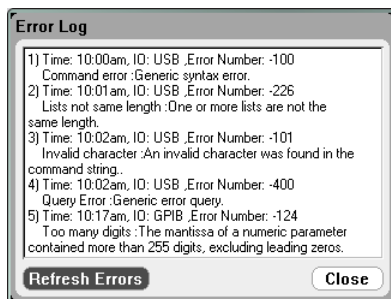

- Errors are stored in the order they are received. The error at the end of the list is the most recent error.
- If there are more errors than can fit in the queue, the last error stored is replaced with -350,"Error queue overflow". No more errors are stored until you remove errors from the queue. If there are no errors, the instrument responds with +0,"No error".
- Except for self-test errors, all errors are cleared when you exit the Error Log menu or when power is cycled.

If you suspect that there is a problem with the DC Power Analyzer, refer to the troubleshooting section in the N6705 Service Guide. The Service Guide is included as part of the optional Manual Set (Option 0L1). An electronic copy of the N6705 Service Guide is also included on the N6705 Product Reference CD-ROM.

Press **Meter View** to return to the meter view.

View Output Ratings

You can quickly view the output ratings, model numbers and options of all power modules installed in your instrument. You can also view the mainframe serial number and firmware revisions. Press the **Settings** key and then press the **Properties** key. The Power Supply Ratings window will appear.

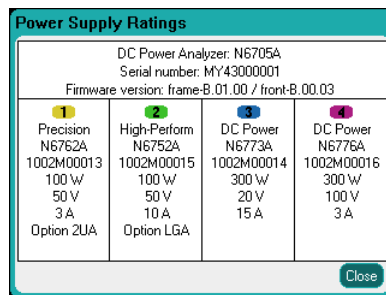

Press **Meter View** to return to the meter view.

From the remote interface:

To return the model number, serial number, and firmware revisions of the mainframe:

*IDN?

To return the model number, serial number, installed options, voltage, current and power rating of the module installed in the specified channel location:

SYST:CHAN:MOD? (@1)

SYST:CHAN:OPT? (@1)

SYST:CHAN:SER? (@1)

Using the Power Supply

Controlling the Outputs

NOTE

The figures on the right apply to Agilent Models N678xA SMU.

Step 1 – Select an output:

Press one of the Select Output keys to select an output to control. The lit key identifies the selected output. All subsequent output-specific front panel commands are sent to the selected output.



Step 2 – Set the output voltage and current:

Turn the Voltage and Current knobs. The output voltage or current setting changes when they are turned. These knobs are active in Meter View, Scope View, and Data Logger mode.

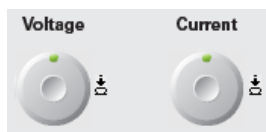

Push the voltage and current knobs to access a pop-up dialog that lets you: 1. Lock/Unlock the knobs. 2. Select limit parameters or select limit tracking on Agilent N678xA SMU and N6783A.

You can also enter the voltage and current values directly in the numeric entry fields (the Set fields) in the Meter-view display. Use the navigation keys to select the field; use the numeric entry keys to enter the value. The value becomes active when you press **Enter**.



Lastly, you can press the **Settings** key to access the Source Settings window. Use the navigation keys to highlight the **Voltage** or **Current** fields. Then enter the voltage and current values with the numeric keys. You can use the Voltage and Current knobs to adjust the values in the Voltage and Current fields. Press **Enter** to enter the value.

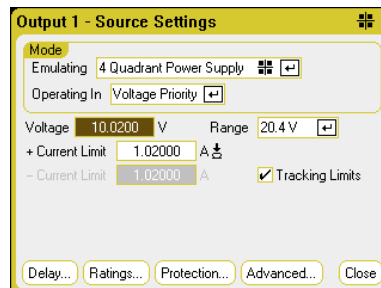
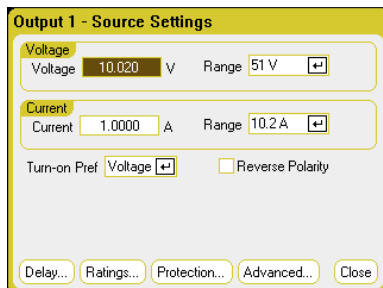

Step 3 – Enable the output:

Press the color-coded **On** key to enable an individual output. When an output is on, the **On** key for that output is lit. When an output is Off, the **On** key is not lit. The All Outputs **On** and **Off** keys turn all outputs on or off simultaneously.

The state of a disabled output (output off) is a condition of zero output voltage and zero source current.

NOTE

The red **Emergency Stop** key turns all outputs off immediately without any output off delays.

Step 4 – View the output voltage and current:

Select Meter View to view the output voltage and current. When an output is enabled, the front panel meters continuously measure and display the output voltage and current.

**From the remote interface:**

A channel parameter is required with each SCPI command to select an output. For example, (@1) selects output 1, (@2,4) selects output 2 and 4, and (@1:4) selects outputs 1 through 4. The output list must be preceded with an @ symbol and be enclosed in parentheses ().

To set only output 1 to 10.02 V and 1 A:

```
VOLT 10.02, (@1)
CURR 1, (@1)
```

To set the output current limit to 1 A for Agilent Models N678xA SMU and N6783A:

```
CURR:LIM 1, (@1)
```

To set the output voltage of **all** outputs to 10 V:

```
VOLT 10.02, (@1:4)
```

To enable only output 1:

```
OUTP ON, (@1)
```

To enable output 1 **and** output 3:

```
OUTP ON, (@1, 3)
```

To measure the output voltage and current of output 1:

```
MEAS:VOLT? (@1)
MEAS:CURR? (@1)
```

Additional Source Settings

In addition to setting the output voltage and current as previously discussed, you can program a number of additional output functions. Press the **Settings** key to access the Source Settings window.

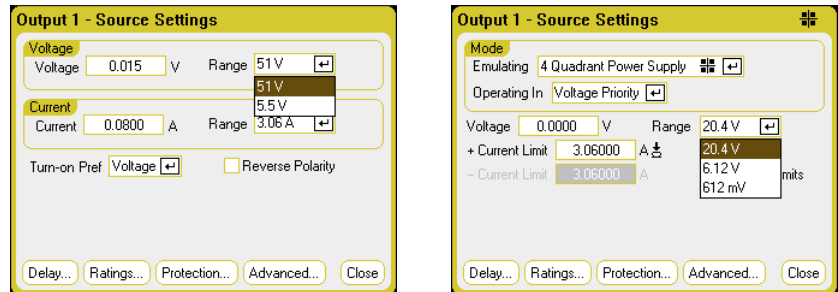

Voltage or Current Range - For outputs with multiple ranges, you can select a lower range if you need better output resolution. Use the navigation keys to highlight either the voltage or current **Range** field. Press the **Enter** key to access the dropdown range list. Use the navigation keys to select the desired output range.

Turn-on Pref - The turn-on preference function only applies to Agilent Models N6761A, N6762A. This specifies the preferred mode for output on/off transitions. It allows output state transitions to be optimized for either constant voltage or constant current operation. In the **Turn-on Pref** drop-down list, select either Voltage or Current. Selecting Voltage minimizes output on/off voltage overshoots in constant voltage operation. Selecting Current minimizes output on/off current overshoots in constant current operation.

Reverse Polarity - This control only applies if the power module has Option 760 installed. Check **Reverse Polarity** to reverse the polarity of the output terminals and the sense terminals. Uncheck to return the relay polarity to normal. The output is briefly turned off while the output and sense terminal polarities are switched. Note that when this option is installed, the maximum output current is limited to 10A. When the output and sense polarities are reversed, the following symbol appears on the front panel display: $\pm \rightarrow \leftarrow$

From the remote interface:

To select a lower voltage or current range on output 1, program a value that falls within the range:

```
VOLT:RANG 5, (@1)
CURR:RANG 1, (@1)
```

To set the Agilent N6761A turn on preference to current priority:

```
OUTP:PMOD CURR, (@1)
```

To reverse the relay polarity on units with Option 760:

```
OUTP:REL:POL REV, (@1)
```

To return the relay polarity to normal:

```
OUTP:REL:POL NORM, (@1)
```

Agilent N678xA SMU Emulation Settings

NOTE

The Source Settings window lets you access the specialized operating modes of the Agilent Models N678xA SMU when these power modules are installed.

The **Emulating** dropdown list lets you access the specialized operating modes of the Agilent Models N678xA SMU. Use the navigation keys to select one of the emulating modes.

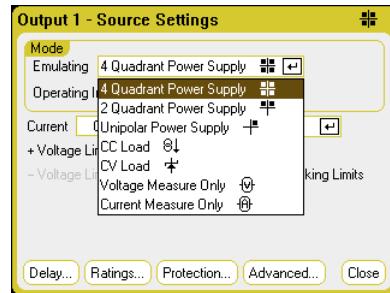

NOTE

Information about the Voltage Measure Only and Current Measure Only modes is discussed in chapter 4.

4-Quadrant Power Supply

4-quadrant operation is only available on Agilent Model N6784A. Operation is allowed in all four output quadrants. Refer to Chapter 6 under “Priority Mode Operation” for more information. The following figures show the 4-quadrant settings.

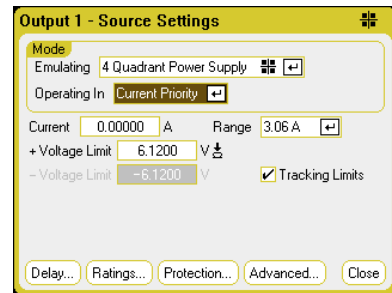
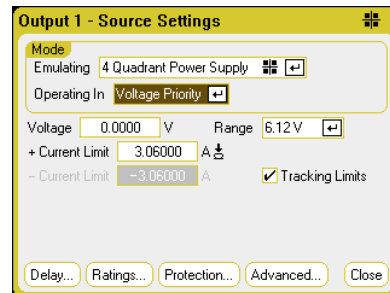

Operating in – selects either Voltage Priority or Current Priority. In voltage priority the output is controlled by a bi-polar constant voltage feedback loop, which maintains the output voltage at its positive or negative setting. In current priority the output is controlled by a bi-polar constant current feedback loop, which maintains the output source or sink current at its programmed setting.

NOTE

When switching between Voltage Priority and Current Priority, the output is turned off and the output settings revert to their Power-on or RST values. Refer to chapter 6 for a detailed description of voltage and current priority.

Depending on the priority mode, you can specify either the output **Voltage** or output **Current** setting. The **Range** function lets you select the appropriate output range. You can also specify a **Voltage Limit** or **Current Limit**, which limits the selected parameter at the specified value. In voltage priority mode, the output voltage remains at its programmed setting as long as the load current is within the positive or negative limit. In current priority mode, the output current remains at its programmed setting as long as the output voltage is within the positive or negative limit.

Tracking Limits lets the negative voltage or current limit track the positive voltage or current limit setting. By default, the negative limit will track the positive limit value. Un-check this box if you want to program asymmetrical positive and negative limits. If asymmetrical limits are programmed and tracking is turned on, the negative value is changed to track the positive limit.

2-Quadrant Power Supply

This operating mode is restricted to two quadrants (+V/+I and +V/- I). The following figures show the 2-quadrant settings.

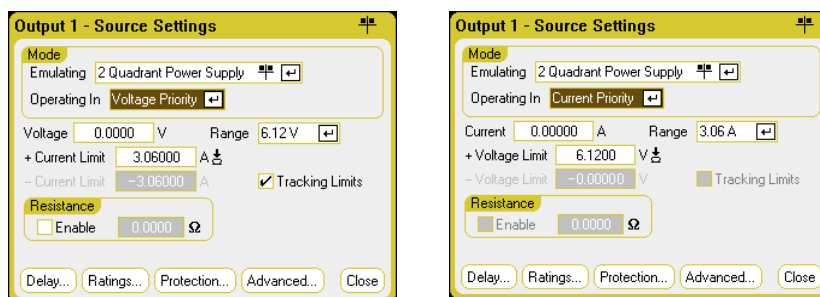

Operating in – selects either Voltage Priority or Current Priority. The other settings in 2-quadrant mode are the same as the settings in 4-quadrant mode except that you cannot program negative voltages or negative voltage limits. Because of this, voltage tracking is not available in Current Priority mode. Note that the negative voltage limit is fixed at -10 mV.

Resistance - This is only available on Agilent Model N6781A. Output resistance programming is primarily used in battery emulation applications, and only applies in Voltage Priority mode. Values are programmed in Ohms, from -40 m Ω to $+1$ Ω .

1-Quadrant Power Supply (unipolar)

This mode emulates a typical one quadrant or unipolar power supply with limited down-programming. The following figures show the 1-quadrant settings. The Voltage Priority and Current Priority selections determine which controls are displayed.

In 1-quadrant mode you cannot program negative voltages, negative currents, negative voltage limits, or negative current limits. Because of this, voltage tracking and current tracking are not available. Note that there is limited 2-quadrant operation with the negative current limit being fixed at 10% to 20% of the output current rating.

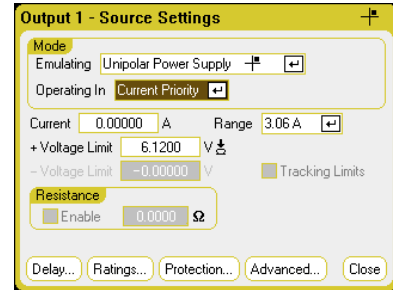
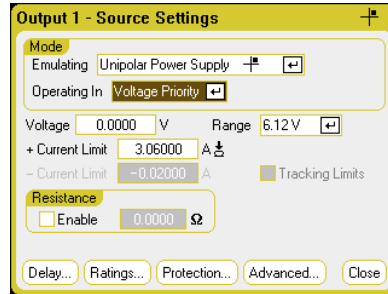

Resistance - This is only available on Agilent Model N6781A. Output resistance programming is primarily used in battery emulation applications, and only applies in Voltage Priority mode. Values are programmed in Ohms, from $-40\text{ m}\Omega$ to $+1\ \Omega$.

Battery Emulator/Battery Charger

Battery emulator and battery charger modes are only available on Agilent Model N6781A. A battery emulator imitates a battery's charging and discharging functions. A battery charger imitates a battery charger; it cannot sink current like a battery. The following figures show the Battery emulator/Battery charger settings.

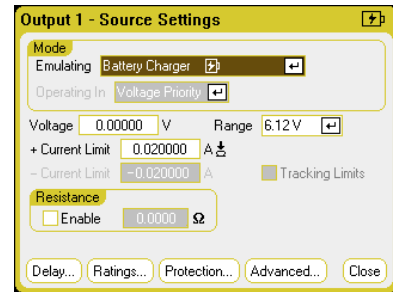
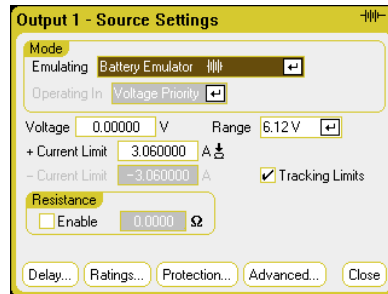

In Battery Emulator mode you can specify the battery voltage and range as well as the + and - current limits. The output resistance is programmable, from $-40\text{ m}\Omega$ to $+1\ \Omega$. Voltage Priority mode is locked. The voltage setting is limited to positive values. The + and - current limits are set to their maximum values. The - current limit setting sets the current limit when the battery is being charged.

In Battery Charger mode, you can specify the charge voltage and range as well as the positive current limit. Voltage Priority mode is locked. Because the battery charger can only source current, the voltage and current settings are limited to positive values.

CC Load/CV Load

The CC Load emulates a constant-current load. The CV Load emulates a constant-voltage load. The figures below show the CC and CV load settings.

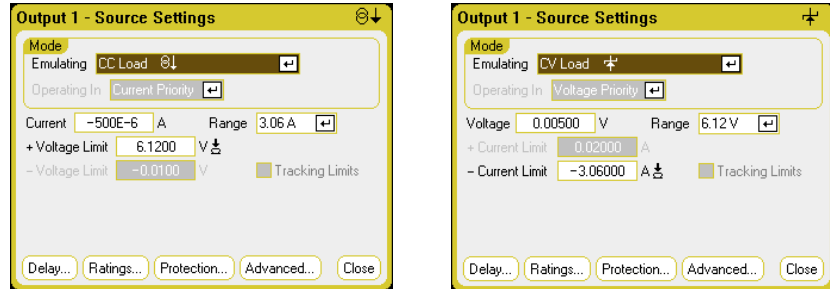

In CC load mode you can specify the input Current and Range as well as the + Voltage Limit. Current Priority mode is locked. Remember to set the input current to a negative value. The + Voltage Limit should normally be set to its maximum value. The – Voltage limit is not programmable. In Meter mode, the measurement polarities and current settings are shown as negative values.

In CV load mode you can specify the input Voltage and Range as well as the – Current Limit. Voltage Priority mode is locked. Set the input voltage to a positive value. The – Current Limit should normally be set to its maximum negative value. The + Current Limit is not programmable. In Meter mode, the measurement polarities and current settings are shown as negative values.

From the remote interface:

To specify the 4-quadrant, 2-quadrant, or 1-quadrant power supply emulation setting:

```
EMUL PS4Q, (@1)
EMUL PS2Q, (@1)
EMUL PS1Q, (@1)
```

To set the voltage priority mode:

```
FUNC VOLT, (@1)
```

To set the output voltage to 5 V and the low voltage range:

```
VOLT 5, (@1)
RANG 6, (@1)
```

To set the positive current limit of output 1 to 1 A:

```
CURR:LIM 1, (@1)
```

To set the negative current limit, you must first turn limit coupling (tracking) off. Then set the negative current limit to 0.5 A:

```
CURR:LIM:COUP OFF, (@1)
CURR:LIM:NEG 0.5, (@1)
```

Configuring a Turn-On/Turn-Off Sequence

Turn-on and turn-off delays control the turn-on and turn-off timing of the outputs in relation to each other.

NOTE

You can also synchronize Output On/Off delays across multiple mainframes. Refer to Appendix C under “Output Couple Controls” for further information.

Step 1 – Set the output voltage and current of the output channels:

Refer to steps 1 and 2 under “Controlling the Outputs” and set the output voltage and current values of all outputs that will be sequenced.

Step 2 – Configure the turn-on turn-off delays:

Press the **Settings** key twice to access the Output On/Off Delays window. Enter the **On Delays** and **Off Delays** for all outputs that will participate in the output on/off delay sequence. Values can range from 0 to 1023 seconds.

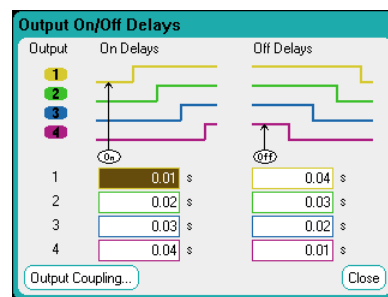

All power modules have an internal turn-on delay that applies from the time that the command to turn on the output is received until the output actually turns on. This turn-on delay is automatically added to the **On Delays** values. The turn-on delay does not apply when outputs turn off. To view the delay, select the **Output Coupling** button.

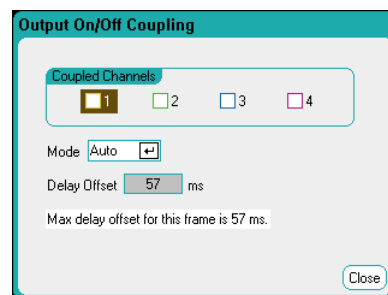

Normally, the firmware automatically calculates the delay offset based on the *longest* minimum turn-on delay of the installed power modules. However, if you will be excluding some outputs from participating in an output on/off delay sequence as described Step 3, the delay offset may be different based on the outputs that you will actually be sequencing. The minimum turn-on delays of the power modules are documented in the Agilent N6700 Modular Power System Family Specifications Guide.

Step 3 – Coupling selected outputs:**NOTE**

This step is only required if you will be excluding some outputs from participating in an output on/off delay sequence, or if you are coupling multiple mainframes. If all four outputs on a single mainframe are to be used in the sequence, you can skip this step.

In the Output On/Off Delays window, navigate to and select the **Output Coupling** Button.

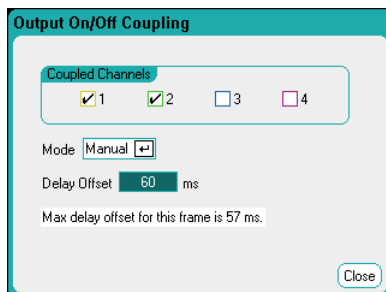



Under **Coupled Channels**, select the outputs that will be coupled. Outputs excluded from an output on/off delay sequence can be put to other uses. Turning the output on or off on *any* coupled output will cause *all* coupled outputs to turn on or off according to their user-programmed delays.

Mode – If the Mode setting is set to **Auto**, the delay offset is automatically calculated by the firmware based on the outputs that are coupled. This is displayed in the **Delay Offset** field. To manually program a different delay offset, change the Mode setting to **Manual**.

Delay Offset – Manually specifying a delay offset lets you configure longer turn-on delays than the automatically calculated delay offset. This is useful if you are sequencing turn-on/turn-off delays across multiple mainframes as discussed in Appendix C under “Output Couple Controls”. Also, if you are using the scope to view the output sequence, you may choose longer turn-on delays to make the internal delay offset line up with the grid on the display. Note however, that if you program a *shorter* delay than the automatic delay offset, you may experience improper synchronization across all outputs.

The **Max delay offset for this frame** field displays the maximum delay offset required for all the power modules that are installed in the DC Power Analyzer.

Step 4 – Use the All Outputs On and Off keys:

Once output delays have been set, use the **All Outputs On**  key to start the On delay sequence. Use the **All Outputs Off**  key to start the Off delay sequence.

NOTE

The All Outputs On/Off keys will turn ALL outputs on or off, whether they are configured to participate in an output on/off delay sequence or not.

From the remote interface:

To program turn-on and turn-off delays for channels 1 through 4:

```

OUTP:DEL:RISE .01,(@1)
OUTP:DEL:RISE .02,(@2)
OUTP:DEL:RISE .03,(@3)
OUTP:DEL:RISE .04,(@4)
OUTP:DEL:FALL .04,(@1)
OUTP:DEL:FALL .03,(@2)
OUTP:DEL:FALL .02,(@3)
OUTP:DEL:FALL .01,(@4)

```

To only include outputs 1 and 2 in a sequence and specify a different delay offset:

```

OUTP:COUP:CHAN 1,2
OUTP:COUP:DOFF:MODE MAN
OUTP:COUP:DOFF .050

```

To query the delay offset of the *slowest* power module in the mainframe (the maximum delay offset) in seconds:

```

OUTP:COUP:MAX:DOFF?

```

To turn on two coupled outputs in a sequence:

```

OUTP ON,(@1:2)

```

Configuring Advanced Properties

Advanced button - Advanced properties are configured in the Advanced Properties window. Press the **Settings** key to access the Source Settings window. Navigate to and select **Advanced**.

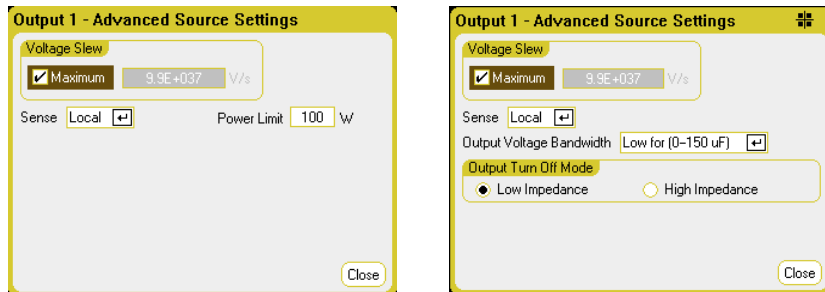

Voltage Slew - The voltage slew rate determines the rate at which the voltage changes to a new setting. To program a voltage slew rate, enter the rate (V/s) in the **Voltage Slew** field. Check **Maximum** to program the fastest rate. For Agilent Models N678xA SMU, the voltage slew control is only available in Voltage priority mode.

Note that the maximum slew rate is limited by the analog performance of the output circuit. The minimum slew rate is model-dependent and is a function of the full-scale voltage range. You can query the minimum voltage slew rate using the VOLT:SLEW? query.

Current Slew – This is only available on Agilent Models N678xA SMU operating in Current priority mode. The current slew rate determines the rate at which the current changes to a new setting. To program a current slew rate, enter the rate (A/s) in the **Current Slew** field. Check **Maximum** to program the fastest rate.

Note that the maximum slew rate is limited by the analog performance of the output circuit. The minimum slew rate is model-dependent and is a function of the full-scale current range. You can query the minimum current slew rate using the CURR:SLEW? query.

Sense - The default sense setting is **Local**, where the sense terminals are connected directly to the output terminals. If you are using remote voltage sensing as explained in chapter 2, you must disconnect the sense terminals from the output terminals. Use the navigation keys and select the Sense dropdown list. Selecting the **4-Wire** item disconnects the sense terminals from the output terminals. This lets you use remote voltage sensing.

Power Limit - For the majority of DC Power Analyzer configurations, full power is available from all installed power modules. However, it is possible to configure a mainframe in which the combined power module ratings exceed the 600 W power rating of the mainframe. The power limit field lets you reduce the power that can be sourced from an individual output, thereby preventing the combined power from exceeding the mainframe's power rating.

To set a lower power limit, select the **Power Limit** Field and enter the power limit value in Watts. Refer to chapter 6 under “Power Limit Operation” for more information.

Output Voltage Bandwidth – This is only available on Agilent Models N678xA SMU. Output voltage bandwidth settings allow you to optimize output response time with capacitive loads. Refer to Chapter 6 under “Output Bandwidth” for more information.

Output Turn-Off Mode – This is only available on Agilent Models N678xA SMU operating in Voltage priority mode. It lets you specify high impedance or low impedance mode at output on/off.

Low impedance - At turn-on the output relays are closed after which the output is programmed to the set value. At turn-off the output is first programmed to zero, after which the output relays are opened.

High impedance – At turn-on the output is programmed to the set value after which the output relays are closed. At turn-off the output relays are opened while the output remains at its set value. This reduces current pulses that may be undesirable in some applications.

From the remote interface:

To set the voltage slew rate to 5 Volt/second:

```
VOLT:SLEW 5, (@1)
```

To set the fastest voltage slew rate:

```
VOLT:SLEW INF, (@1)
```

To query the minimum slew rate:

```
VOLT:SLEW? MIN, (@1)
```

To set the current slew rate to 1 Amp/second:

```
CURR:SLEW 1, (@1)
```

To set the front panel sense terminals to local sensing:

```
VOLT:SENS:SOUR INT, (@1)
```

To set the front panel sense terminals to remote sensing:

```
VOLT:SENS:SOUR EXT, (@1)
```

To query the setting of the front panel sense terminals:

```
VOLT:SENS:SOUR? (@1)
```

The query returns INT if the terminals are set to local sensing, and EXT if the terminals are set to remote sensing.

To set the power limit of outputs 1 and 2 to 50 W:

```
POW:LIM 50, (@1, 2)
```

To set the power limit of outputs 1 and 2 to their maximum settings:

```
POW:LIM MAX, (@1, 2)
```

To set the output voltage bandwidth of output 1 to the default setting:

```
VOLT:BWID LOW, (@1)
```

To set the output turn-off mode to the high impedance setting:

```
OUTP:TMOD HIGHZ, (@1)
```

Configuring Protection Functions

Protection functions are configured in the Protection Configuration window. Press the **Settings** key to access the Source Settings window. Navigate to and select **Protection**. Then press **Enter**.

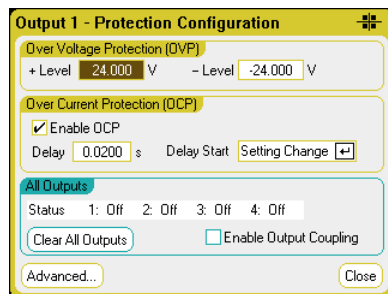

Over Voltage Protection - Over-voltage protection disables the output if the output voltage reaches the OVP level. To set the over-voltage protection, enter an over-voltage value in the **+Level** field.

For Agilent Models N678xA SMU, the OVP circuit senses at the 4-wire sense terminals rather than at the output terminals. This allows for more precise over-voltage monitoring directly at the load. Refer to “Over-Voltage Protection Considerations” in chapter 2 for a description of the OVP function. These models also have negative voltage protection, which disables the output if negative voltages are detected. Note that for Agilent Model N6784A, you can program a negative over-voltage protection level. Enter the value in the **-Level** field.

For Agilent Models N6783A, you can specify a delay to prevent momentary over-voltage excursions from tripping the over-voltage protection. Enter the value in the over-voltage **Delay** field. These models also have negative voltage protection, which disables the output if negative voltages are detected.

Over Current Protection - With over-current protection enabled, the DC Power Analyzer disables the output if the output current reaches the current limit setting, which causes a transition from CV to CC mode. To enable over-current protection, check the **Enable OCP** box.

Note that you can also specify a **Delay** to prevent momentary CV-to-CC status changes from tripping the over-current protection. The delay can be programmed from 0 to 0.255 seconds. You can specify if the **Start** of the delay is initiated by *any* transition into CC mode, or only at the end of a settings change in voltage, current, or output state. See chapter 6 under “CC Mode Delay” for more information.

All Outputs – the **Status** field shows the status of all outputs. This indicator also appears in the lower left corner of each output in Meter View. When a protection function trips the DC Power Analyzer disables the affected output and the status indicator shows which protection function was activated.

- OV** An over-voltage protection.
- OV–** A negative voltage protection. Only applies to Agilent N678xA SMU and N6783A.

OC	An over-current protection
OT	An over-temperature protection.
Osc	An oscillation protection. Only applies to Agilent N678xA SMU.
PF	A power-fail condition on the AC mains.
CP+	A positive power limit condition. See chapter 6 for further information.
CP-	A negative power limit condition. See chapter 6 for further information.
Prot	A coupled protection signal, or an expired watchdog timer.
Inh	An Inhibit input signal. See Appendix C for further information.

Clear All Outputs - To clear the protection function, first remove that condition that caused the protection fault. Then select **Clear All Outputs**. This clears the protection function and returns the output to its previous operating state.

Enable Output Coupling – Checking this box lets you couple the outputs so that when a protection fault occurs on one output, ALL outputs will be turned off.

Advanced button – Advanced protection properties are configured in the Advanced Protection window. Navigate to and select **Advanced**.

From the remote interface:

To program the OVP level for outputs 1 and 2 to 10 V:

```
VOLT:PROT 10, (@1, 2)
```

To enable OCP for outputs 1 and 2:

```
CURR:PROT:STAT 1, (@1, 2)
```

To specify a 10 millisecond delay for the OCP:

```
CURR:PROT:DEL.01, (@1, 2)
```

To start the delay timer by ANY output transition into CC mode:

```
CURR:PROT:DEL:STAR CCTR, (@1, 2)
```

To start the timer by a settings change in voltage current or output:

```
CURR:PROT:DEL:STAR SCH, (@1, 2)
```

To enable output protection coupling:

```
OUTP:PROT:COUP ON
```

To clear an output protection fault on output 1:

```
OUTP:PROT:CLE (@1)
```

Configuring Advanced Protection

Press the **Settings** key to access the Source Settings window. Navigate to and select Protection. Navigate to and select **Advanced**.

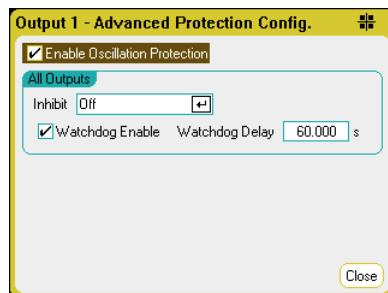

All Outputs – for all outputs you can program the **Inhibit** input (digital pin 3) on the rear panel to act as an external protection shutdown signal. The behavior of this signal can be set to either Latched or Live (non-latched). Off disables the remote inhibit. Refer to Appendix C for further information.

Watchdog – for all outputs you can program a watchdog timer function. The output watchdog timer causes all outputs to go into protection mode if there is no SCPI I/O activity on the remote interfaces (USB, LAN, GPIB) within the user-specified time period. Note that the watchdog timer function is NOT reset by activity on the front panel or when using the Web server – the outputs will still shut down after the time period has elapsed.

After the time period has expired, the outputs will be disabled, but the programmed output state is not changed. This condition is annunciated on the front panel by the **Prot** status. The delay is programmable from 1 to 3600 seconds in 1 second increments.

Enable Oscillation Protection - This is only available on Agilent Models N678xA SMU. If open sense leads or capacitive loads outside the allowable range cause the output to oscillate, the oscillation protection function detects the oscillation and latches the output off. The condition is annunciated on the front panel by the **Osc** status.

From the remote interface:

To program the INH signal to act as an external shutdown:

```
DIG:PIN3:FUNC INH
```

To configure the pin polarity for pin 3:

```
DIG:PIN3:POL POS
```

To enable the watchdog timer function and set the delay to 15 minutes (900 seconds):

```
OUTP:PROT:WDOG ON
OUTP:PROT:WDOG:DEL 900
```

To enable output oscillation protection:

```
OUTP:PROT:OSC ON, (@1)
```

Using the Arbitrary Waveform Generator

Each output on DC Power Analyzer can be modulated by the power module's built-in arbitrary waveform generator function. This allows the output to act as a DC bias transient generator or an arbitrary waveform generator. The maximum bandwidth is based on the type of power module that is installed. This is documented in the Agilent N6700 Modular Power System Family Specifications Guide. See the note in the beginning of Appendix A.

The arbitrary waveform generator has a variable dwell period, where each point in the waveform is defined by the voltage or current setting along with the dwell time or duration to stay at that setting. Waveforms can be generated by specifying only a small number of points. For example, a pulse would only take three points to define it. However, sine, ramp, trapezoid, and exponential waveforms have 100 points assigned to the portion of their waveform that continuously changes. Constant-dwell waveforms can have up to 65,535 points assigned to them.

Each waveform can be set to repeat continuously or repeat a specific number of times. For example, to generate a pulse train of 10 identical pulses, you can program the parameters for one pulse and then specify that you want it to repeat 10 times.

For the user-defined waveforms, you can specify up to 511 step-points of voltage or current. You can specify a different dwell time for each of the 511 step-points. The output will step through the user-defined values, staying at each point for the programmed dwell time, and then moving on to the next point.

You can also combine a number of individual arbitrary waveforms into an Arb sequence, as long as the total number of points of all waveforms does not exceed 511 points.

The following sections provide examples of how to configure a Pulse Arb, a User-defined Arb, a Constant-dwell Arb, and an Arb Sequence, which is a combination of Arb's combined in a sequence.

Configuring Pulse Arb

NOTE

The basic steps in this example are the same steps used to program the Sine, Step, Ramp, Staircase, and Exponential Arb. The only difference is in the individual Arb parameters. These differences are described in the reference section at the end of this chapter.

Step 1 – Select a Voltage or Current Pulse Arb:

Press the **Arb** key twice or press the **Arb** key and then **Properties** to access the Arb Selection window.

In the Arb Type dropdown menu, select either a **Voltage** or **Current** Arb type. Then navigate to and select the **Pulse** output type.

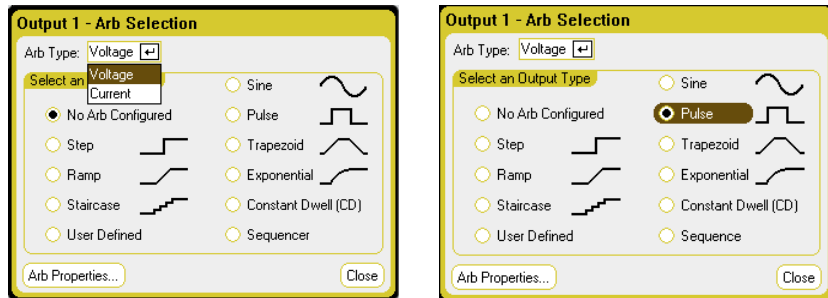

Step 2 – Configure the Pulse Properties:

To configure the parameters of the Pulse, press the **Properties** key or select the **Arb Properties** button.

Enter the voltage or current values for the level before and after the pulse (V_0 or I_0). Enter the amplitude of the pulse (V_1 or I_1).

Enter the time parameters: t_0 = the time before the pulse; t_1 = the time of the pulse; t_2 = the time after the pulse.

Specify what happens when the pulse completes – select whether the output returns to the DC value that was in effect before the pulse started, or whether the output should remain at the last Arb value.

Specify if the Arb should repeat, either continuously or only for a specified repeat count. A repeat count of 1 runs the Arb once.

Select **Edit Points** to convert the parameters to a User-defined Arb.

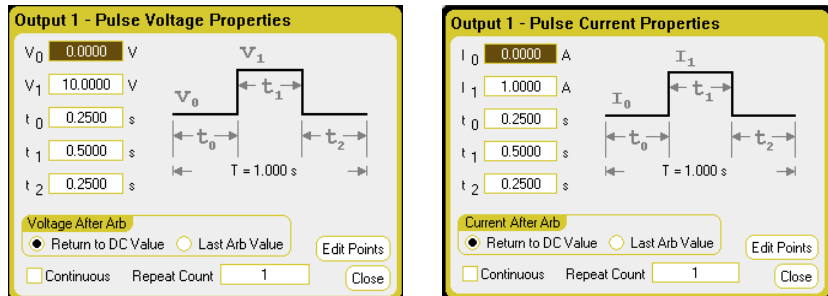

Step 3 – Select the Trigger Source:

To specify a Trigger source for the arbitrary waveforms, press the **Arb** key, then select the Trigger Source field. The same trigger source will be used to trigger all of the arbitrary waveforms.

Arb Run/Stop key selects the front panel **Arb Run/Stop** key as the trigger source. BNC Trigger In selects the rear trigger input BNC connector as the trigger source. Remote command selects a remote interface command as the trigger source.

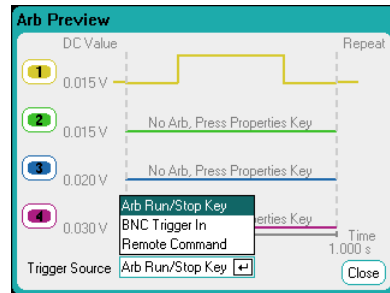

Step 4 – Preview and Run the Arb:

The Arb Preview dialog shown above provides a preview of the Pulse waveform that will be run on output 1.

Select **Meter View** or **Scope View** to display the Arb.

Press the Output 1 **On** key to enable the output.

Press the **Arb Run/Stop** key to run the Arb.

From the remote interface:

The following commands select, program, and trigger a voltage Pulse on output 1:

```
ARB:FUNC:TYPE VOLT, (@1)
ARB:FUNC:SHAP PULS, (@1)
ARB:VOLT:PULS:STAR 0, (@1)
ARB:VOLT:PULS:TOP 10, (@1)
ARB:VOLT:PULS:STAR:TIM .25, (@1)
ARB:VOLT:PULS:TOP:TIM .5, (@1)
ARB:VOLT:PULS:END:TIM .25, (@1)
ARB:TERM:LAST OFF, (@1)
```

To set up the transient trigger system and trigger the Arb:

```
VOLT:MODE ARB, (@1)
TRIG:ARB:SOUR BUS
OUTP ON, (@1)
INIT:TRAN(@1)
*TRG
```

Configuring User-Defined Arb

User-defined Arb can contain up to 511 voltage or current steps that are entered individually in the User-defined Properties window.

You can also populate the User-defined voltage or current Arb with values from a previously configured “standard” arbitrary waveform and then edit the steps in the User-defined Properties window.

To convert one of the standard Arb, program the standard Arb parameters and then select the **Edit Points** button to populate the User-defined Arb with the values from the standard Arb.

You can also import a User-defined Arb that was previously created using a spreadsheet as explained later in this chapter under “Importing and Exporting User-Defined and Constant-Dwell Arb Data”.

Step 1 – Select a voltage or current User-defined Arb:

Press the **Arb** key twice or press the **Arb** key and then **Properties** to access the Arb Selection window.

In the Arb Type dropdown menu, select either a **Voltage** or **Current** Arb type. Then select the **Pulse** output type.

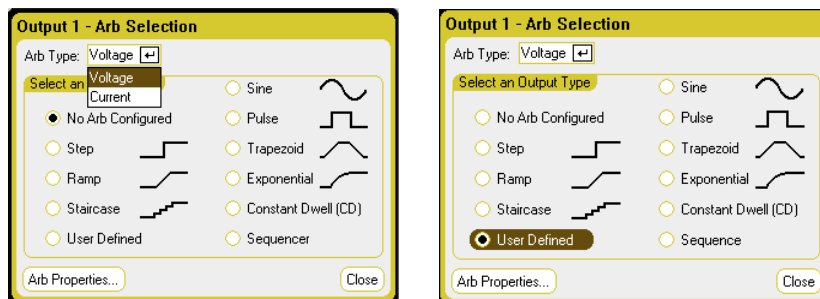

Step 2 – Configure the User-defined properties:

To configure the parameters of the User-defined waveform, press the **Properties** key or select the **Arb Properties** button.

For step 0, enter the voltage or current values. Then enter the time or dwell for the step. Check the **Trigger** box if you wish to generate an external trigger signal at the start of the step.

Select the **Add** button to insert a new step below the selected step. Note that the values in the new step are copied from the previous step. Edit the values in the step. Select **Clear** if you want to clear all values. Select **Delete** if you want to delete the selected step. Continue to Add steps until your waveform is complete. Use the ▲ ▼ navigation keys to move through the list.

Specify what happens when the waveform completes – select whether the output returns to the DC value that was in effect before the waveform started, or whether the output should remain at the last Arb value.

Specify if the Arb should repeat, either continuously or only for a specified repeat count. A repeat count of 1 runs the Arb once.

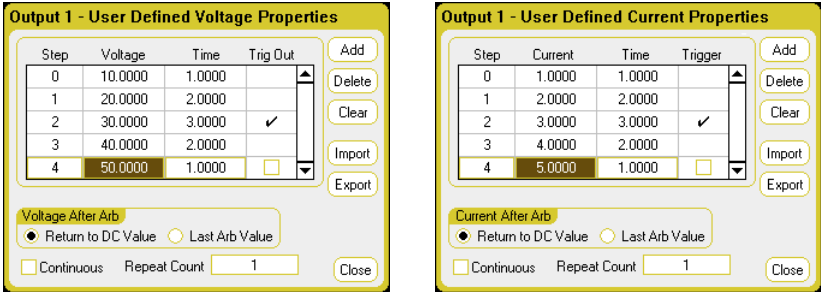

Step 3 – Exporting or importing User-defined Arb data

After you have configured the User-defined Arb, you can use the **Export** button to save the Arb list to a file. Conversely, if you have previously created or saved a User-defined data file, you can use the **Import** button to import the Arb list.

Refer to “Importing and Exporting User-Defined and Constant-Dwell Arb Data” later in this chapter for information on how to create .csv current or voltage data files.

Select the Arb.csv file type format. When importing, specify the output on which the User-defined Arb will run. When exporting, specify the output from which you want to export the Arb.

Under Path/File name, click Browse and specify the location where the import file is located or where the export file will be placed. Internal:\ specifies the instrument’s internal memory. External:\ specifies the Memory port on the front panel.

Select **Import** to import the file. Select **Export** to export the file.

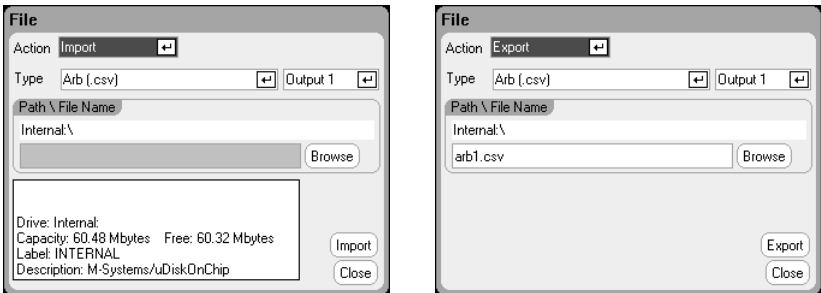

Step 4 – Select the trigger source:

To specify a Trigger source for the arbitrary waveforms, press the **Arb** key, then select the **Trigger Source** field. The same trigger source will be used to trigger all of the arbitrary waveforms.

Arb Run/Stop key selects the front panel **Arb Run/Stop** key as the trigger source. BNC Trigger In selects the rear trigger input BNC connector as the trigger source. Remote command selects a remote interface command as the trigger source.

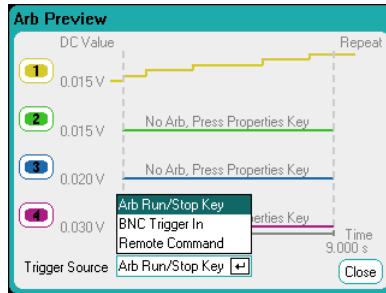
**Step 4 – Preview and run the Arb:**

The Arb Preview dialog shown above provides a preview of the User-defined waveform that will be run on output 1.

Select **Meter View** or **Scope View** to display the Arb.

Press the Output 1 **On** key to enable the output.

Press the **Arb Run/Stop** key to run the Arb.

From the remote interface:

The following commands select, program, and trigger a User-defined voltage waveform of five steps on output 1:

```
ARB:FUNC:TYPE VOLT, (@1)
ARB:FUNC:SHAP UDEF, (@1)
ARB:VOLT:UDEF:LEV 10, 20, 30, 40, 50, (@1)
ARB:VOLT:UDEF:DWEL 1, 2, 3, 2, 1, (@1)
ARB:VOLT:UDEF:BOST 0, 0, 1, 0, 0, (@1)
ARB:TERM:LAST OFF, (@1)
```

To set up the transient trigger system and trigger the Arb:

```
VOLT:MODE ARB, (@1)
TRIG:ARB:SOUR BUS
OUTP ON, (@1)
INIT:TRAN(@1)
*TRG
```

Configuring Constant-Dwell Arbs

Constant-Dwell (CD)Arbs are a unique type of Arb that have some useful differences from other types. CD Arbs are not limited to 511 points, they can contain up to 65,535 points. Unlike other Arbs, they do not have separate dwell values associated with each point; a single dwell value applies to every point in the CD Arb. Also, the minimum dwell time of a CD Arb is 10 .24 microseconds, instead of the 1 microsecond resolution of the other Arbs.

A CD Arb can run along with other Arbs on other outputs. If multiple outputs run a CD Arb, all CD Arbs must have the same dwell time. If a repeat count is specified, all CD Arbs must have the same length and repeat count.

Because the CD Arbs can have such a large number of points, you cannot define the individual voltage or current values from the front panel. Instead, the CD Arb data must be imported into the instrument from a file. This is explained later in this chapter under “Importing and Exporting User-Defined and Constant-Dwell Arb Data”.

Step 1 – Select a voltage or current Constant-dwell Arb:

Press the **Arb** key twice or press the **Arb** key and then **Properties** to access the Arb Selection window.

In the Arb Type dropdown menu, select either a **Voltage** or **Current** Arb type. Navigate to and select the **Constant-Dwell** output type.

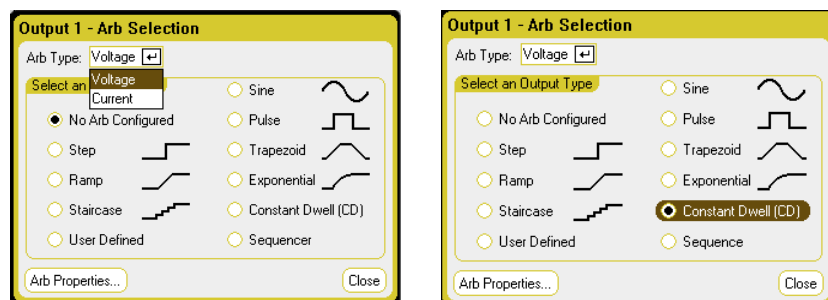

Step 2 – Configure the Constant-dwell properties:

To configure the parameters of the Constant-dwell waveform, press the **Properties** key or select the **Arb Properties** button.

Use the **Import** button to import a previously created CD Arb. Conversely, use the **Export** button to export the CD-Arb to a file.

Once the file has been imported the Arb Properties window will display the following information about the Arb: minimum value, maximum value, average value, length in points, and the total time.

You can change the dwell per step of the Arb after it has been imported. When an Arb file is imported, the dwell time specified in the file will be entered in the Dwell per step field.

Specify what happens when the waveform completes – select whether the output returns to the DC value that was in effect before the waveform started, or whether the output should remain at the last Arb value.

Specify if the Arb should repeat, either continuously or only for a specified repeat count. A repeat count of 1 runs the Arb once.

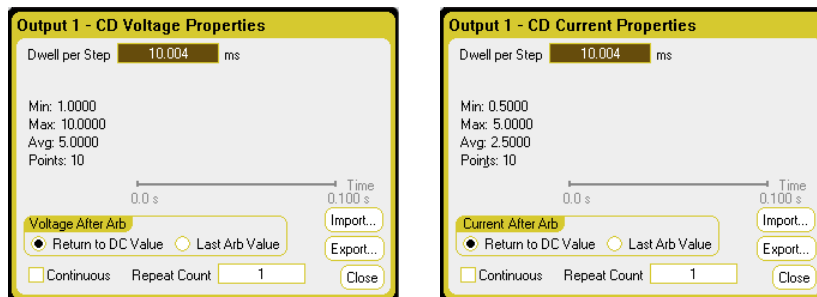

Step 3 – Importing or exporting Constant-dwell Arb data

Refer to “Importing and Exporting User-Defined and Constant-Dwell Arb Data” later in this chapter for information on how to create .csv current or voltage data files.

Select the Arb.csv file type format. When importing, specify the output on which the Constant-dwell Arb will run. When exporting, specify the output from which you want to export the Arb.

Under Path/File name, click Browse and specify the location where the import file is located or where the export file will be placed. Internal:\ specifies the instrument’s internal memory. External:\ specifies the Memory port on the front panel.

Select **Import** to import the file. Select **Export** to export the file.

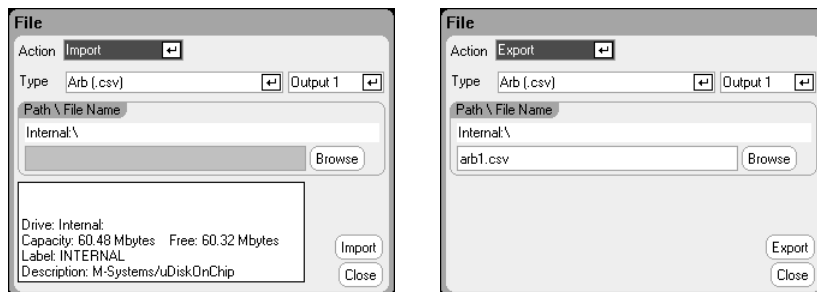

Step 4 – Select the trigger source:

To specify a Trigger source for the arbitrary waveforms, press the **Arb** key, then select the **Trigger Source** field. The same trigger source will be used to trigger all of the arbitrary waveforms.

Arb Run/Stop key selects the front panel **Arb Run/Stop** key as the trigger source. BNC Trigger In selects the rear trigger input BNC connector as the trigger source. Remote command selects a remote interface command as the trigger source.

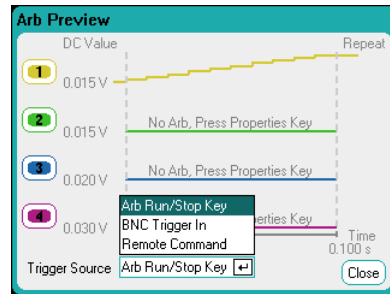

Step 5 – Preview and run the Arb:

The Arb Preview dialog shown above provides a preview of the Constant-dwell waveform that will be run on output 1.

Select **Meter View** or **Scope View** to display the Arb.

Press the Output 1 **On** key to enable the output.

Press the **Arb Run/Stop** key to run the Arb.

From the remote interface:

The following commands select, program, and trigger a Constant-dwell voltage waveform of one second with ten steps on output 1:

```
ARB:FUNC:TYPE VOLT, (@1)
ARB:FUNC:SHAP CDW, (@1)
ARB:VOLT:CDW:DWEL .01, (@1)
ARB:VOLT:CDW 1,2,3,4,5,6,7,8,9,10, (@1)
ARB:TERM:LAST OFF, (@1)
```

The list of constant-dwell levels can be a list of comma-separated ASCII values (the default setting), or for better performance, it can be sent as a definite length binary block as described in IEEE 488.2.

NOTE

If you are sending data as a definite length binary block, the instrument will recognize the data format; however, you must specify the byte order. Refer to “Measurement Data Formats” in chapter 6 for more information.

To set up the transient trigger system and trigger the CD Arb:

```
VOLT:MODE ARB, (@1)
TRIG:ARB:SOUR BUS
OUTP ON, (@1)
INIT:TRAN (@1)
*TRG
```

Configuring an Arb Sequence

The Arb Sequence allows multiple and different Arb types to run one after another in succession. Any of the standard Arb types, except for Constant Dwell Arb, can be included in the Arb sequence. All Arb types in the sequence must be of the same type; either voltage or current.

As with single Arb types, each Arb in the sequence has its own repeat count, can be set for dwell or trigger pacing, and can be set to repeat continuously. Note also that a repeat count can be set for the entire sequence, and it can also be set to repeat continuously.

The following figure illustrates a sequence comprised of a pulse Arb, a ramp Arb, and a sine Arb. The repeat count value indicates how many times each Arb repeats before moving to the next type.

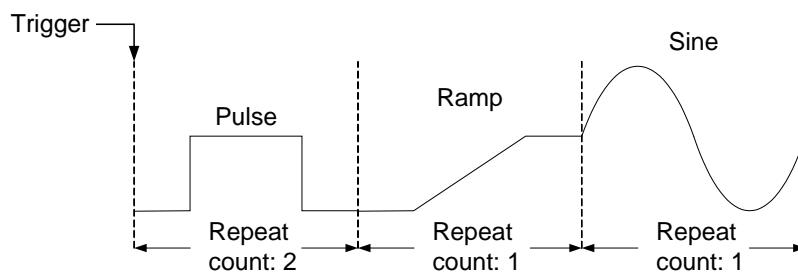

Step 1 – Select a voltage or current Arb Sequence:

Press the **Arb** key twice or press the **Arb** key and then **Properties** to access the Arb Selection window.

In the Arb Type dropdown menu, select either a **Voltage** or **Current** Arb type. Then navigate to and select the **Sequence** output type.

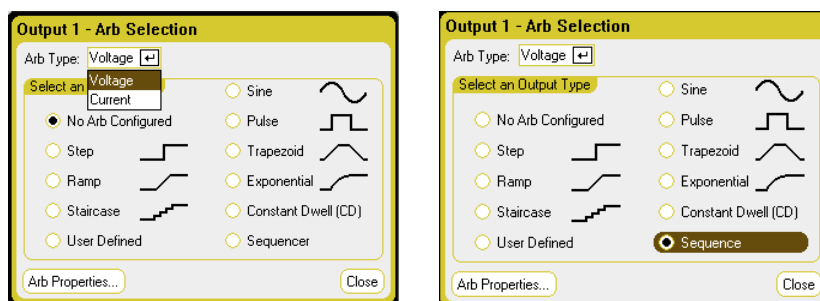

Step 2 – Configure the Arb Sequence:

To configure the parameters of the Arb sequence, press the **Properties** key or select the **Arb Properties** button.

For step 0, select an Arb type from the **Name** dropdown list. Select the **Edit** button or **Properties** key to edit the waveform. The example below shows the Pulse waveform type. Refer to “Configuring Pulse Arb” for information on setting the Pulse parameters.

The only additional step that you need to program is the Pacing. At the end of the step you must specify if the next step will start when the dwell time has elapsed or when an external trigger is received.

Once the step is configured, the **Time** field will indicate the time that is allocated to the step. The **Pacing** field indicates the method of transitioning to the *next* step; either dwell time or external trigger.

Select the **Add** button to insert a new step below the selected step. Note that the values in the new step are copied from the previous step. Select and edit another Arb from the **Name** dropdown list.. Select **Delete** if you want to delete the selected step. Continue to Add steps until your sequence is complete. Use the **Up** and **Down** buttons or the ▲ ▼ navigation keys to move through the list.

Total Time indicates the total run-time of the sequence.

Waveform Quality indicates the number of points allocated to the portions of the sine, ramp, trapezoid, and exponential waveforms that change continuously over time. Normally, each continuous section is approximated using 100 points, but in an Arb sequence this could result in exceeding the 511-point limit as more waveforms are added. The more of these waveforms that are added to the sequence, the fewer points will be allocated, down to a minimum of 16 points.

Output 1 - Sequence Voltage Properties

Step	Name	Time	Pacing
0	Pulse	2.000	Dwell
1	Exp.	1.000	Dwell
2	Pulse	1.000	Dwell
	Ramp		
	Sine		
	Staircase		
	Step		
	Trapezoid		
	User	4.000 s	

Waveform quality: 100

Advanced... *Press Properties to Edit Step

Output 1 - Pulse Voltage - Step 0

V₀ 0.0000 V
V₁ 10.0000 V
t₀ 0.2500 s
t₁ 0.5000 s
t₂ 0.2500 s
T = 1.000 s

Move to next step via Dwell

Continuous Repeat Count 2

Use the **Advanced** button to specify what happens when the Arb sequence completes – select whether the output Returns to the DC Value that was in effect before the waveform started, or whether the output should remain at the Last Arb Value. Also specify if the Arb sequence should repeat, either continuously or only for a specified repeat count. A repeat count of 2 runs the Arb sequence twice.

Output 1 - Sequencer Advanced Properties

Voltage After Arb

Return to DC Value Last Arb Value

Continuous Repeat Count 2

Close

Step 3 –Saving and loading an Arb Sequence

Arb sequences are saved and recalled in instrument state files, but you can also save and load them in files that are separate from other instrument settings using the **Save** and **Load** buttons.

Select the Sequence file type .seq. When loading a sequence, specify the output on which the Sequence will run. When saving a Sequence, specify the output from which you want to save the Sequence.

Under Path/Filename, click Browse and specify the location where the import file is located or where the export file will be placed. Internal:\ specifies the instrument's internal memory. External:\ specifies the Memory port on the front panel.

Select **Load** to load the file. Select **Save** to save the file.

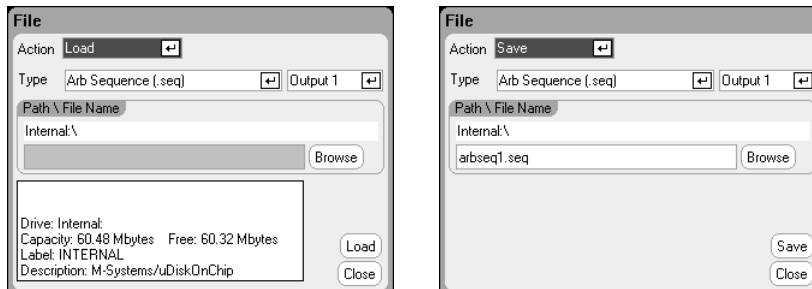

Step 4 – Select the trigger source:

To specify a Trigger source for the arbitrary waveforms, press the **Arb** key, then select the **Trigger Source** field. The same trigger source will be used to trigger all of the arbitrary waveforms.

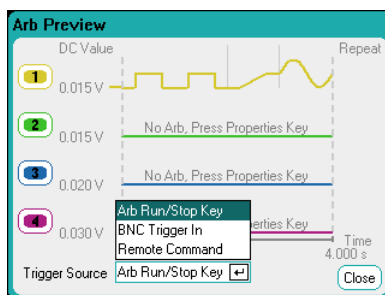

Arb Run/Stop key selects the front panel **Arb Run/Stop** key as the trigger source. This means that the Arb will be triggered as soon as you run it. BNC Trigger In selects the rear trigger input BNC connector as the trigger source. Remote command selects a remote interface command as the trigger source.

Step 4 – Preview and run the Arb:

The Arb Preview dialog shown above provides a preview of the Arb Sequence that will be run on output 1.

Select **Meter View** or **Scope View** to display the Arb.

Press the Output 1 **On** key to enable the output.

Press the **Arb Run/Stop** key to run the Arb.

From the remote interface:

Observe the following when creating or editing an Arb sequence:

- The Arb function type (voltage or current) must match the Arb type specified in each sequence step.
- Sequence steps must be specified sequentially. The *last* value in the parameter list is the sequence step number.

- When a step type is added, all parameters must be entered.

The following commands program a sequence comprised of a pulse, a ramp, and a sine Arb with the pulse Arb repeated twice.

To set up output 1 to program a sequence of voltage waveforms:

```
ARB:FUNC:TYPE VOLT, (@1)
ARB:FUNC:SHAP SEQ, (@1)
ARB:SEQ:RESet (@1)
```

To program step 0 as a voltage pulse:

```
ARB:SEQ:STEP:FUNC:SHAP PULS, 0, (@1)
ARB:SEQ:STEP:VOLT:PULS:STAR:TIM 0.25, 0, (@1)
ARB:SEQ:STEP:VOLT:PULS:TOP 10.0, 0, (@1)
ARB:SEQ:STEP:VOLT:PULS:TOP:TIM 0.5, 0, (@1)
ARB:SEQ:STEP:VOLT:PULS:END:TIM 0.25, 0, (@1)
```

To program step 1 as a voltage ramp:

```
ARB:SEQ:STEP:FUNC:SHAP RAMP, 1, (@1)
ARB:SEQ:STEP:VOLT:RAMP:STAR:TIM 0.25, 1, (@1)
ARB:SEQ:STEP:VOLT:RAMP:END 10.0, 1, (@1)
ARB:SEQ:STEP:VOLT:RAMP:RTIM 0.5, 1, (@1)
ARB:SEQ:STEP:VOLT:RAMP:END:TIM 0.25, 1, (@1)
```

To program step 2 as a voltage sine wave:

```
ARB:SEQ:STEP:FUNC:SHAP SIN, 2, (@1)
ARB:SEQ:STEP:VOLT:SIN:FREQ 0.0167, 2, (@1)
ARB:SEQ:STEP:VOLT:SIN:OFFS 10.0, 2, (@1)
ARB:SEQ:STEP:VOLT:SIN:AMPL 20.0, 2, (@1)
```

To repeat step 0 twice:

```
ARB:SEQ:STEP:COUN 2, 0, (@1)
```

To set the pacing for step 2 to triggered:

```
ARB:SEQ:STEP:PAC TRIG, 2, (@1)
```

To select the trigger source for step 2:

```
TRIG:ARB:SOUR BUS, 2, (@1)
```

To end the sequence at the last Arb value:

```
ARB:SEQ:TERM:LAST ON, (@1)
```

To make the entire sequence repeat twice:

```
ARB:SEQ:COUN 3, (@1)
```

To set up the transient trigger system and trigger the sequence:

```
VOLT:MODE ARB, (@1)
TRIG:ARB:SOUR BUS
OUTP ON, (@1)
INIT:TRAN(@1)
*TRG
```

Arbitrary Waveform Parameters

Common Parameters

The following properties are common to most Arb functions:

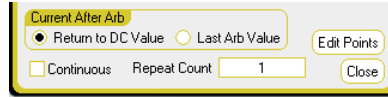

Parameter:	Description:
Return to DC Value	The parameter setting returns to the DC value that was in effect prior to the Arb.
Last Arb Value	The parameter setting remains at the last Arb value after the Arb completes.
Edit Points	Create a user-defined Arb from the present Arb property values. This lets you edit specific points in the standard arbitrary waveform.
Continuous	Check to repeat the Arb continuously.
Repeat Count	The number of times the Arb repeats. Except for CD Arbs, the maximum repeat count is about 16 million. The maximum repeat count for voltage and current CD Arbs is 256.
Close	Saves and closes the Properties window.

From the remote interface:

The parameter setting returns to the DC value that was in effect prior to the Arb.

```
ARB:TERM:LAST OFF, (@1)
```

The parameter setting remains at the last Arb value after the Arb completes.

```
ARB:TERM:LAST ON, (@1)
```

Create a user-defined current or voltage Arb from the present Arb property values:

```
ARB:CURR:CONV (@1)
```

```
ARB:VOLT:CONV (@1)
```

Repeat the Arb continuously.:

```
ARB:COUN INF, (@1)
```

The number of times the Arb repeats.

```
ARB:COUN 10, (@1)
```

Step Parameters

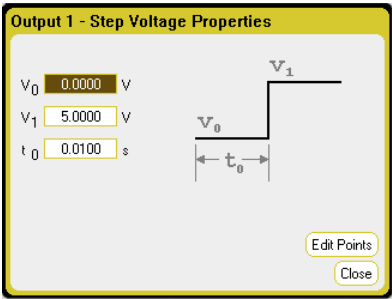
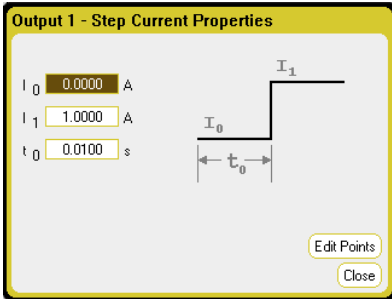

Parameter:	Description:
Start Setting (I_0 or V_0)	The setting before the step.
End Setting (I_1 or V_1)	The setting after the step.
Delay (T_0)	The delay after the trigger is received before the step occurs.

From the remote interface:

The setting before the step:

```
ARB:CURR:STEP:STAR 0,(@1)
ARB:VOLT:STEP:STAR 0,(@1)
```

The setting after the step:

```
ARB:CURR:STEP:END 1,(@1)
ARB:VOLT:STEP:END 5,(@1)
```

The delay after the trigger is received before the step occurs:

```
ARB:CURR:STEP:STAR:TIM 0.01,(@1)
ARB:VOLT:STEP:STAR:TIM 0.01,(@1)
```

Ramp Parameters

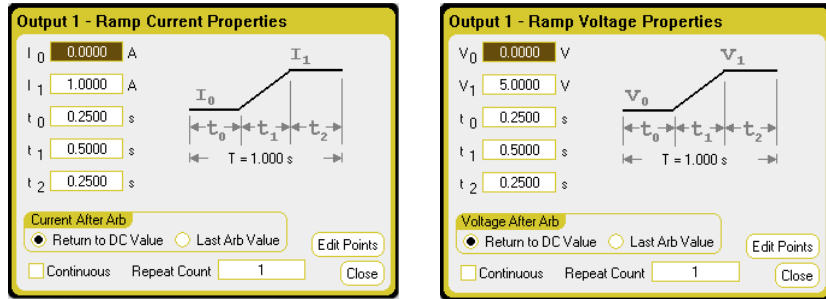

Parameter:	Description:
Start Setting (I_0 or V_0)	The setting before the ramp.
End Setting (I_1 or V_1)	The setting after the ramp.
Delay (T_0)	The delay after the trigger is received but before the ramp starts.
Ramp Time (T_1)	The time that the output ramps up.
End Time (T_2)	The time the output remains at the end setting after the ramp completes.

From the remote interface:

The setting before the ramp:

```
ARB:CURR:RAMP:STAR 0, (@1)
ARB:VOLT:RAMP:STAR 0, (@1)
```

The setting after the ramp:

```
ARB:CURR:RAMP:END 1, (@1)
ARB:VOLT:RAMP:END 5, (@1)
```

The delay after the trigger is received but before the ramp starts:

```
ARB:CURR:RAMP:STAR:TIM 0.25, (@1)
ARB:VOLT:RAMP:STAR:TIM 0.25, (@1)
```

The time that the output ramps up:

```
ARB:CURR:RAMP:RTIM 0.5, (@1)
ARB:VOLT:RAMP:RTIM 0.5, (@1)
```

The time the output remains at the end setting after the ramp:

```
ARB:CURR:RAMP:END:TIM 0.01, (@1)
ARB:VOLT:RAMP:END:TIM 0.01, (@1)
```

Staircase Parameters

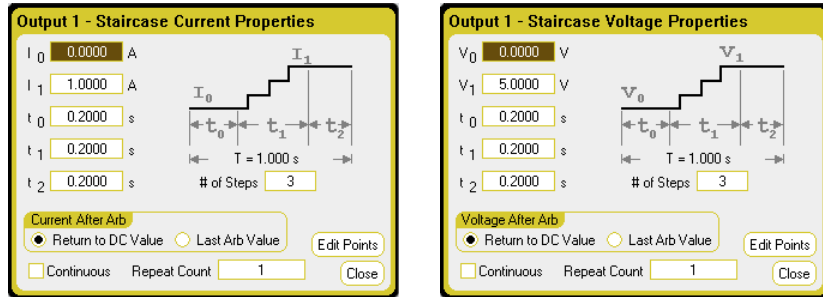

Parameter:	Description:
Start Setting (I_0 or V_0)	The setting before the staircase.
End Setting (I_1 or V_1)	The setting after the final stair step (the difference between the start and end setting is divided equally between the steps).
Delay (T_0)	The delay after the trigger is received but before the staircase starts.
Step Time (T_1)	The time to complete all staircase steps.
End Time (T_2)	The time the output remains at the end setting after the staircase completes.
# of Steps	The total number of staircase steps.

From the remote interface:

The setting before the staircase:

```
ARB:CURR:STA:STAR 0, (@1)
ARB:VOLT:STA:STAR 0, (@1)
```

The setting after the final stair step:

```
ARB:CURR:STA:END 1, (@1)
ARB:VOLT:STA:END 5, (@1)
```

The delay after the trigger is received but before the staircase starts:

```
ARB:CURR:STA:STAR:TIM 0.2, (@1)
ARB:VOLT:STA:STAR:TIM 0.2, (@1)
```

The time to complete all staircase steps:

```
ARB:CURR:TIM 0.2, (@1)
ARB:VOLT:TIM 0.2, (@1)
```

The time the output remains at the end setting after the staircase:

```
ARB:CURR:STA:END:TIM 0.2, (@1)
ARB:VOLT:STA:END:TIM 0.2, (@1)
```

The total number of staircase steps:

```
ARB:CURR:STA:NST 3, (@1)
ARB:VOLT:STA:NST 3, (@1)
```

Sine Parameters

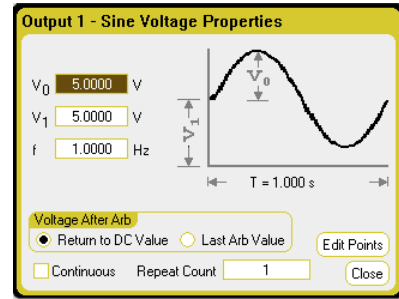
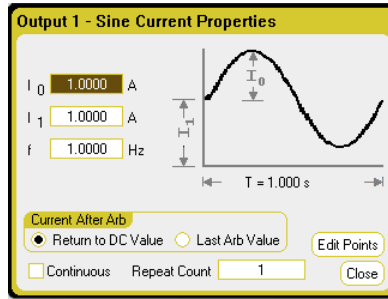

Parameter:	Description:
Amplitude (I_0 or V_0)	The amplitude or peak value.
Offset (I_1 or V_1)	The offset from zero. <i>For power modules that cannot generate negative voltages or currents, the offset cannot be less than the amplitude.</i>
Frequency (f)	The frequency of the sine wave.

From the remote interface:

The amplitude or peak value:

```
ARB:CURR:SIN:AMPL 1, (@1)
ARB:VOLT:SIN:AMPL 5, (@1)
```

The offset from zero:

```
ARB:CURR:SIN:OFFS 1, (@1)
ARB:VOLT:SIN:OFFS 5, (@1)
```

The frequency of the sine wave:

```
ARB:CURR:SIN:FREQ 1, (@1)
ARB:VOLT:SIN:FREQ 1, (@1)
```

Pulse Parameters

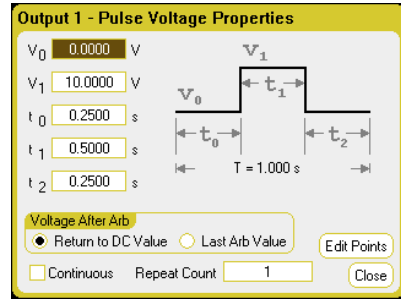
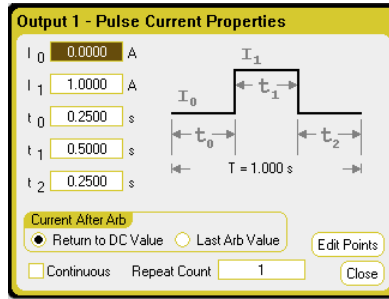

Parameter:	Description:
Start Setting (I_0 or V_0)	The setting before and after the pulse.
Pulse Setting (I_1 or V_1)	The amplitude of the pulse.
Delay (T_0)	The delay after the trigger is received but before the pulse starts.
Pulse Width (T_1)	The width of the pulse.
End Time (T_2)	The time the output remains at the end setting after the pulse completes.

From the remote interface:

The setting before and after the pulse:

```
ARB:CURR:PULS:STAR 0,(@1)
ARB:VOLT:PULS:STAR 0,(@1)
```

The amplitude of the pulse:

```
ARB:CURR:PULS:TOP 1,(@1)
ARB:VOLT:PULS:TOP 10,(@1)
```

The delay after the trigger is received but before the pulse starts:

```
ARB:CURR:PULS:STAR:TIM 0.25,(@1)
ARB:VOLT:PULS:STAR:TIM 0.25,(@1)
```

The width of the pulse:

```
ARB:CURR:PULS:TOP:TIM 0.5,(@1)
ARB:VOLT:PULS:TOP:TIM 0.5,(@1)
```

The time the output remains at the end setting after the pulse:

```
ARB:CURR:PULS:END:TIM 0.25,(@1)
ARB:VOLT:PULS:END:TIM 0.25,(@1)
```

Trapezoid Parameters

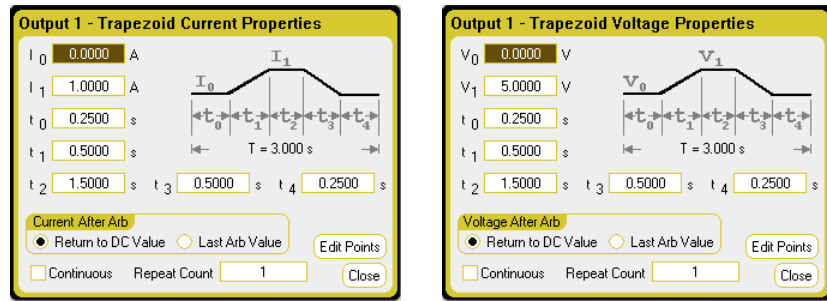

Parameter:	Description:
Start Setting (I₀ or V₀)	The setting before and after the trapezoid.
Peak Setting (I₁ or V₁)	The peak setting.
Delay (T₀)	The delay after the trigger is received but before the trapezoid starts.
Rise Time (T₁)	The time that the trapezoid ramps up.
Peak Width (T₂)	The width of the peak.
Fall Time (T₃)	The time that the trapezoid ramps down.
End Time (T₄)	The time the output remains at the end setting after the trapezoid completes.

From the remote interface:

The setting before and after the trapezoid:

```
ARB:CURR:TRAP:STAR 0, (@1)
ARB:VOLT:TRAP:STAR 0, (@1)
```

The peak setting:

```
ARB:CURR:TRAP:TOP 1, (@1)
ARB:VOLT:TRAP:TOP 5, (@1)
```

The delay after the trigger is received but before the trapezoid starts:

```
ARB:CURR:TRAP:STAR:TIM 0.25, (@1)
ARB:VOLT:TRAP:STAR:TIM 0.25, (@1)
```

The time that the trapezoid ramps up (RTIM) and down (FTIM):

```
ARB:CURR:TRAP:RTIM 0.5, (@1)
ARB:VOLT:TRAP:RTIM 0.5, (@1)
ARB:CURR:TRAP:FTIM 0.5, (@1)
ARB:VOLT:TRAP:FTIM 0.5, (@1)
```

The width of the peak:

```
ARB:CURR:TRAP:TOP:TIM 1.5, (@1)
ARB:VOLT:TRAP:TOP:TIM 1.5, (@1)
```

The time the output remains at the end setting after the trapezoid:

```
ARB:CURR:PULS:END:TIM 0.25, (@1)
ARB:VOLT:PULS:END:TIM 0.25, (@1)
```

Exponential Parameters

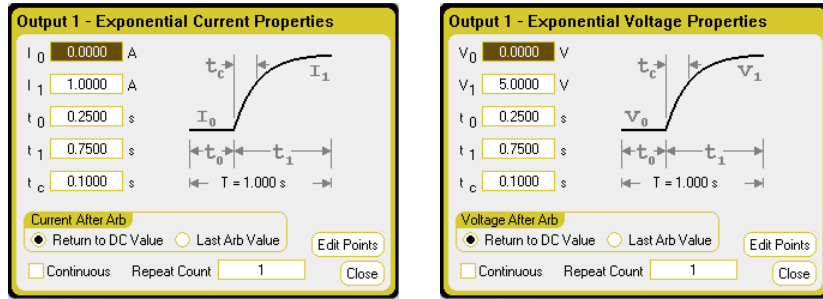

Parameter:	Description:
Start Setting (I_0 or V_0)	The setting before the waveform.
End Setting (I_1 or V_1)	The end setting of the waveform.
Delay (T_0)	The delay after the trigger is received but before the waveform starts.
Time (T_1)	Time for the amplitude to go from the start setting to the end setting.
Time Constant (T_c)	The time constant of the curve.

From the remote interface:

The setting before the waveform:

```
ARB:CURR:EXP:STAR 0, (@1)
ARB:VOLT:EXP:STAR 0, (@1)
```

The end setting of the waveform:

```
ARB:CURR:EXP:END 1, (@1)
ARB:VOLT:EXP:END 5, (@1)
```

The delay after the trigger is received but before the waveform starts:

```
ARB:CURR:EXP:STAR:TIM 0.25, (@1)
ARB:VOLT:EXP:STAR:TIM 0.25, (@1)
```

Time for the amplitude to go from the start setting to the end setting:

```
ARB:CURR:EXP:TIM 0.75, (@1)
ARB:VOLT:EXP:TIM 0.75, (@1)
```

The time constant of the curve:

```
ARB:CURR:EXP:TCON 0.1, (@1)
ARB:VOLT:EXP:TCON 0.1, (@1)
```

User-Defined Parameters

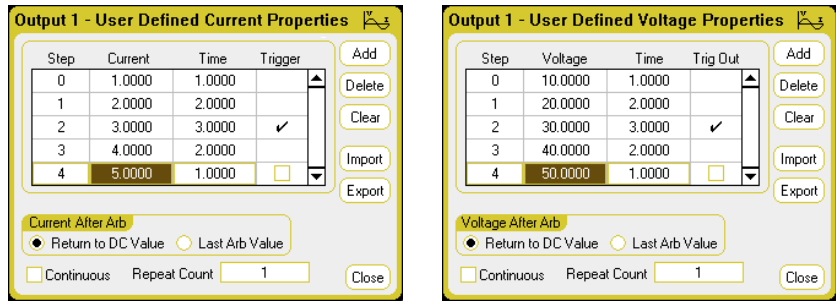

Parameter:	Description:
Step <n>	Each step of the waveform includes a voltage or current parameter, dwell time, and trigger option. The total number of steps determines the length. Use the ▲ ▼ navigation keys to scroll through the steps.
Current or Voltage	The current or voltage value of the step.
Time	The time that the output stays at the step.
Trigger	Generate an external trigger signal at the start of the step when checked.
Add	Inserts a step below the selected step; values are copied from the previous step.
Delete	Deletes the presently selected step.
Clear	Clears all steps.
Import (.csv format)	Imports a current or voltage Arb list.
Export (.csv format)	Exports a voltage or current Arb list.

From the remote interface:

The current or voltage value of five steps:

```
ARB:CURR:UDEF:LEV 1,2,3,4,5,(@1)
ARB:VOLT:UDEF:LEV 1,2,3,4,5,(@1)
```

The time that the output stays at the steps:

```
ARB:CURR:UDEF:DWEL 1,2,3,2,1,(@1)
ARB:VOLT:UDEF:DWEL 1,2,3,2,1,(@1)
```

Generate an external trigger signal at the start of the step (the trigger is generated at the start of step #3):

```
ARB:CURR:UDEF:BOST 0,0,1,0,0,(@1)
ARB:VOLT:UDEF:BOST 0,0,1,0,0,(@1)
```

Constant-Dwell Parameters

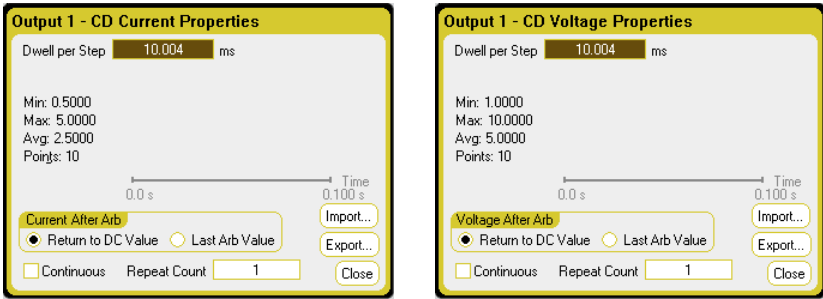

Parameter:	Description:
Dwell per Step	The dwell time for each step in seconds. Values range from 10.24 μs to 0.30 s.
Import (.csv format)	Imports a current or voltage CD Arb list.
Export (.csv format)	Exports a current or voltage CD Arb list.
Min	The minimum value of the imported Arb
Max	The maximum value of the imported Arb
Avg	The average value of the imported Arb
Points	The number of points in the imported Arb
Time	The total time of the imported Arb
Repeat Count	The maximum repeat count for CD Arbs is 256.

From the remote interface:

The dwell time for each step in seconds.:

```
ARB:CURR:CDW:DWEL 0.01, (@1)
ARB:VOLT:CDW:DWEL 0.01, (@1)
```

The current or voltage value of ten steps:

```
ARB:CURR:CDW 0.5,1,1.5,2,2.5,3,3.5,4,4.5,5, (@1)
ARB:VOLT:CDW 1,2,3,4,5,6,7,8,9,10, (@1)
```

Arb Sequence Parameters

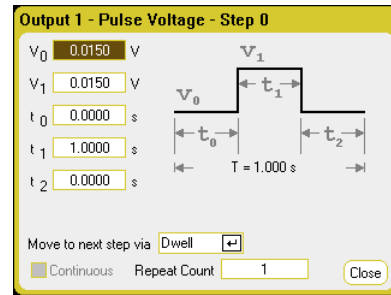
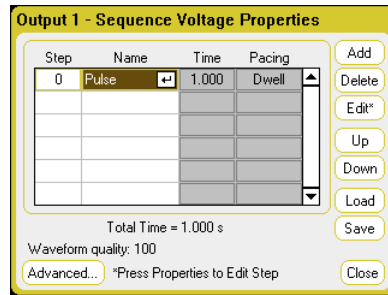

Parameter:	Description:
Step <n>	Each step of the sequence includes a step number, an arbitrary waveform, step time, and pacing option. The total number of steps determines the length. Use the ▲ ▼ navigation keys to scroll through the steps.
Name	The name of the Arb. Select an Arb from the dropdown list. Select Edit or Properties to edit the waveform. The Pulse waveform edit fields are shown above.
Time	Displays the time that is allocated to the step in the Edit function. This time does not include the number of repeat counts.
Pacing	Displays the pacing of the step. Dwell-paced transitions to the next step when the dwell time has elapsed. Trigger-paced transitions to the next step when an external trigger is received. If the step time completes before the trigger occurs, the step remains at the last Arb value while waiting for the trigger.
Add	Inserts a step below the selected step; values are copied from the previous step.
Delete	Deletes the presently selected step.
Edit	Edits the selected Arb. The Pulse waveform edit fields are shown above. Move to the next step specifies the step pacing. Repeat count specifies how many times the Arb repeats. Continuous can only be selected if the Arb is trigger-paced.
Up	Move up through the steps.
Down	Move down through the steps.
Loads (.seq format)	Loads a previously created sequence file.
Save (.seq format)	Saves the present voltage or current sequence.
Total time	Indicates the total run-time of the sequence.
Waveform Quality	Indicates the number of points allocated to the continuously changing portion of the following waveforms: sine, trapezoid, ramp, and exponential. The more of these waveforms that are added to the sequence, the fewer points will be allocated, down to a minimum of 16 points.
Advanced	Lets you edit the common properties that apply to the entire sequence. See "Configure the Common Properties".

From the remote interface:

The following must be observed when creating or editing an Arb sequence:

- The Arb function type (voltage or current) must match the Arb type specified in each sequence step.
- The Arb sequence step function waveshape must match the shape used in the parameter commands that follow.
- The *last* value in the parameter list is the sequence step number.

To set up output 1 to program a voltage sequence:

```
ARB:FUNC:TYPE VOLT, (@1)
ARB:FUNC:SHAP SEQ, (@1)
ARB:SEQ:RESet (@1)
```

To program step 0 as the voltage pulse:

```
ARB:SEQ:STEP:FUNC:SHAP PULS, 0, (@1)
ARB:SEQ:STEP:VOLT:PULS:STAR:TIM 0.25, 0, (@1)
ARB:SEQ:STEP:VOLT:PULS:TOP 10.0, 0, (@1)
ARB:SEQ:STEP:VOLT:PULS:TOP:TIM 0.5, 0, (@1)
ARB:SEQ:STEP:VOLT:PULS:END:TIM 0.25, 0, (@1)
```

Note that the time of step 0 is the sum of the Start Time, Top Time and End Time. The default pacing for sequence steps is Dwell-pacing.

Arb Trigger Sources

Specify a Trigger source for the arbitrary waveforms. The same trigger source will be used to trigger all of the arbitrary waveforms.

From the front panel

Press the **Arb** key, then select the **Trigger Source** field.

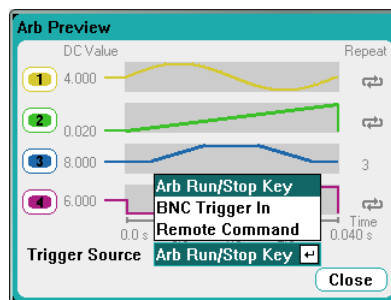

Trigger Source:	Description:
Arb Run/Stop key	The front panel Run/Stop key
BNC Trigger in	The rear trigger input BNC connector
Remote Command	A remote interface command.

From the remote interface:

Select from one of the following SCPI trigger sources:

- BUS** Selects a GPIB device trigger, *TRG, or <GET> (Group Execute Trigger).
- IMMEDIATE** Selects the immediate trigger source. This triggers the Arb immediately when the INITiate command is sent.
- EXTERNAL** Selects the trigger input BNC connector on the rear panel. You must provide a low-true signal to the connector

To specify arbitrary waveforms as the output trigger response::

```
CURR:MODE ARB(@1)
VOLT:MODE ARB(@1)
```

To select a BUS trigger source:

```
TRIG:ARB:SOUR BUS
```

To select the immediate trigger source:

```
TRIG:ARB:SOUR IMM
```

To select the rear panel trigger input BNC connector:

```
TRIG:ARB:SOUR EXT
```

Arb Triggers

NOTE

For the arbitrary waveform to appear at the output terminals, the selected output must be turned on *before* the Arb is run. When the arbitrary waveform runs, front panel voltage and current controls as well as any remote voltage and current commands are ignored until after the Arb completes.

From the front or rear panel

Depending upon the selected trigger source, you can trigger the arbitrary waveforms as follows:

Trigger Source:	Description:
Arb Run/Stop key	Press the <u>Arb Run/Stop</u> key to initiate and start the Arbs. All Arbs are triggered simultaneously. Press the <u>Arb Run/Stop</u> key again to stop the Arbs.
Rear Trigger input	Provide a low-true signal to the Trigger In BNC connector. The signal must persist for at least 2 microseconds. All Arbs are triggered simultaneously.

Once configured, the instrument will wait indefinitely for the trigger signal. If the trigger does not occur, and you wish to cancel the arbitrary waveform, press the Arb Run/Stop key to stop the Arb.

From the remote interface:

To initiate the transient trigger system:

```
INIT:TRAN(@1)
```

It takes a few milliseconds for the instrument to be ready to receive a trigger signal after receiving the INITiate:TRANsient command. If a trigger occurs before the trigger system is ready for it, the trigger will be ignored. You can test the WTG_tran bit in the operation status register to know when the instrument is ready to receive a trigger after being initiated.

To query the WTG_tran bit (bit 4):

```
STAT:OPER:COND? (@1)
```

If a bit value of 16 is returned in the query, the WTG_tran bit is true, and the instrument is ready to receive the trigger signal. Refer to the N6705 Programmer's Reference Help file for more information.

NOTE

Unless INITiate:TRANsient;CONTinuous is programmed, it will be necessary to initiate the transient trigger system each time a triggered action is desired.

To trigger the Arb if the trigger source is BUS:

```
*TRG
```

As previously discussed, a trigger can also be generated by a trigger signal applied to the rear panel trigger input BNC connector. If this is configured as the trigger source, the instrument will wait indefinitely for the trigger signal. If the trigger does not occur, you must manually return the trigger system to the idle state.

If the trigger does not occur, and you wish to cancel the arbitrary waveform, send

```
ABOR:TRAN
```

When a trigger is received, the Arb runs. When the Arb completes, the trigger system returns to the idle state. You can test the TRAN_active bit in the operation status register to know when the transient trigger system has returned to the idle state.

To query the TRAN_active bit (bit 6):

```
STAT:OPER:COND? (@1)
```

If a bit value of 64 is returned in the query, the TRAN_active bit is true, and the Arb has NOT completed. When the TRAN_active bit is false, the Arb has completed. Refer to the N6705 Programmer's Reference Help file for more information.

Importing/Exporting User-Defined and Constant-Dwell Arb Data

You can create an arbitrary waveform in a Microsoft Excel spreadsheet and import it into the instrument using the **Import** function as previously explained in this chapter under “Configuring User-Defined Properties” and “Configuring Constant-Dwell Properties”. Likewise, you can also **Export** an arbitrary waveform from the instrument to a spreadsheet.

In the following spreadsheet examples, the file format for user-defined Arbs and constant-dwell Arbs is shown. The format includes a notes section, tag header, and the appropriate number of data header and data row columns.

	A	B	C	D	E
1	Arb User-Defined Waveform				
2	%arbtype=arbuservolt				
3	VALUE	TIME	TRIGGER		
4	1	1	0		
5	2	1	0		
6	3	1	0		
7	4	1	0		
8	5	1	0		
9	6	1	0		
10	7	1	0		
11					
12					
13					
14					
15					
16					
17					

	A	B	C	D	E
1	Arb Constant-Dwell Waveform				
2	%arbtype=arbcdvolt				
3	%constantdwell=0.1				
4	VALUE				
5	1				
6	2				
7	3				
8	4				
9	5				
10	6				
11	7				
12					
13					
14					
15					
16					
17					

Notes section - This section contains text to describe the file. It can also contain empty rows. Notes rows are generally one column wide.

Tag header - This row must contain *one* of the following tags:

%arbtype=arbuservolt

%arbtype=arbusercurr

%arbtype=arbcdvolt

%arbtype=arbcdcurr

For constant-dwell Arbs, a second tag row must specify the dwell:

%constantdwell=<float>

Data header - For user-defined Arbs, the data header row must have 3 columns with the following headings: VALUE, TIME, and TRIGGER. For constant-dwell Arbs, the header row has one column with the heading: VALUE. All rows following the header are the data rows.

Data rows - For user-defined Arbs, the data in the VALUE column must match the Arb type; either voltage or current values. The TIME column specifies the dwell time of the step in seconds. The TRIGGER column requires a value of zero as the default. If you want the Arb to generate an external trigger signal at the start of the step, replace the zero with a one. For constant-dwell Arbs, the data in the VALUE column must match the Arb type; either voltage or current values.

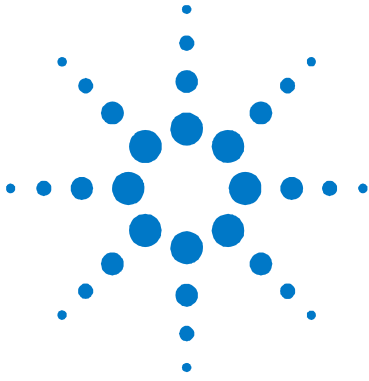

4 Using the Measurement Functions

Using the Meter Functions	104
Using the Scope Functions	109
Using the Data Logger Functions	119

This chapter contains examples on how to operate your DC Power Analyzer. The examples provided show you how to use the:

- Meter function
- Scope measurement function
- Data logging function

Equivalent SCPI commands to program a specific function are included at the end of each topic. However some functions such as the front panel Scope View, Data Logger View, and some Administrative functions do not have equivalent SCPI commands. Appendix B lists all of the SCPI commands that can be used to program the instrument.

NOTE

For complete details on using the SCPI commands, refer to the Programmer's Reference Help file included on the Agilent N6705 Product Reference CD. This CD-ROM is shipped along with your instrument.



Using the Meter Functions

Each power module has a fully integrated voltmeter and ammeter to measure the actual voltage and current being sourced from the output to the device under test. The accuracy of the voltage and current measurements is based on the type of power modules that are installed, as documented in the Agilent N6700 Modular Power System Family Specifications Guide.

Meter View

From the front panel

Each output has its own measurement capability. When the Meter view is displayed, the measurement system continuously measures the output voltage and current. The measurement system acquires as many points as needed based on the number of power line cycles (NPLC) and the time interval, and *averages* the samples. The default view displays all four outputs.

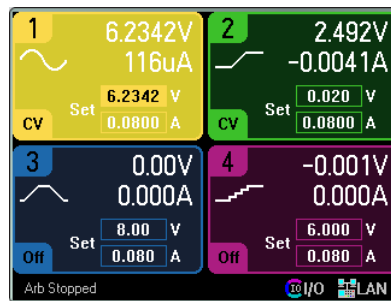

A single-output view displays more information about the selected output. Press the **Meter View** key to toggle between the two views.

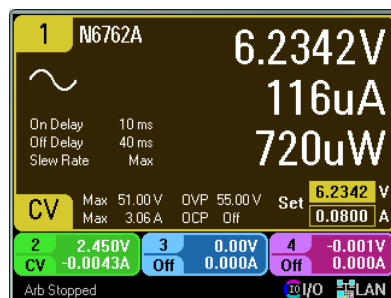

From the remote interface:

To trigger and return DC current or voltage measurements:

```
MEAS:CURRE? (@1)
MEAS:VOLT? (@1)
```

To return a previously triggered DC current or voltage:

```
FETC:CURRE? (@1)
FETC:VOLT? (@1)
```

Meter Ranges

Some power modules have multiple voltage and current measurement ranges (see chapter 1 under “Power Module Features”). Selecting a lower measurement range provides greater measurement accuracy, provided that the measurement does not exceed the range. If the measurement exceeds the range, an “Overload” error will occur.

From the front panel

To specify a measurement range, press the **Meter View** key, then press **Properties**.

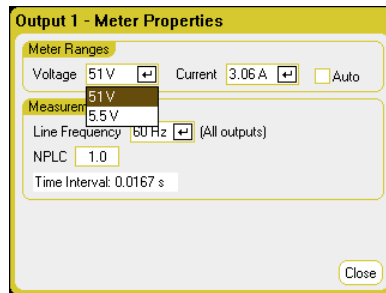

Meter Ranges - In the **Voltage** or **Current** dropdown menu, select the desired lower measurement range. Check the **Auto** box to enable measurement autoranging. The instrument automatically selects the best measurement range for the amplitude of the measurement.

Measurement Time – Lets you specify the **Line Frequency** of the ac mains; either 50 Hz or 60 Hz.

NPLC - For better measurement accuracy and to reduce measurement noise on low current and voltage measurements, you can specify the number of power line cycles (**NPLC**) that the measurement will span.

Time Interval - This field indicates the integration time of each measurement.

NOTE

The measurement time settings in the Meter Properties window apply to the front panel voltage and current meters only. These settings are completely independent from the measurement settings for SCPI measurements, Scope View, Data Logger View, Elog, and histogram.

From the remote interface:

To specify a voltage or current measurement range:

```
SENS:CURR:RANG <current>, (@1)
SENS:VOLT:RANG <voltage>, (@1)
```

The value that you send should be the maximum current that you expect to measure. The instrument selects the range with the best resolution for the value entered.

Seamless voltage and current measurement autoranging is available on Agilent Models N6781A and N6782A. This enables a wide dynamic measurement range with no data lost across ranges. Autoranging does not include the 10 μ A range, which must be selected manually.

To enable seamless voltage or current autoranging on channel 1:

```
SENS:CURR:RANG:AUTO ON, (@1)
SENS:VOLT:RANG:AUTO ON, (@1)
```

Agilent N678xA SMU Meter-Only Modes

NOTE

The following information only applies to Agilent Models N678xA SMU.

Agilent Models N678xA SMU can measure voltage or current at the output terminals without involving the source function of the instrument.

Make all measurement connections *before* selecting the Measure Only functions. This is because when the Measure Only functions are selected, the instrument goes through an initialization sequence that minimizes the amount of disturbances imposed on the DUT. The output is also enabled to allow the meters to measure correctly.

From the front panel

In the Source Settings window, select one of the Measure Only functions in the Emulating dropdown list.

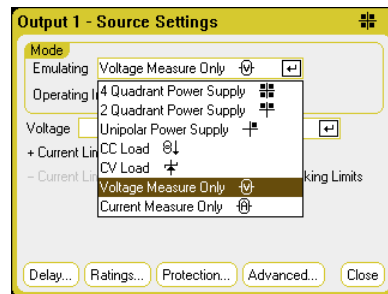

The **Voltage Measure Only** selection emulates a voltmeter. Current priority mode is set by default. The +/- Voltage Limits are set to their maximum values. No additional settings are required.

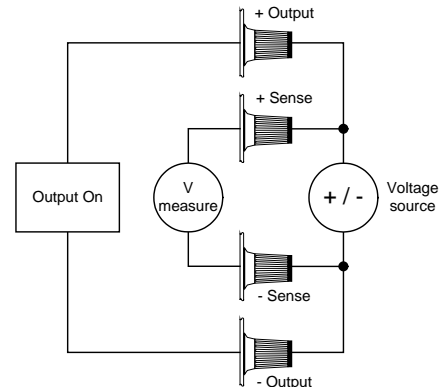
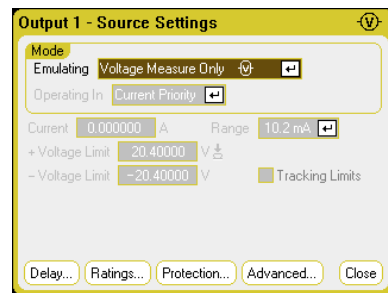

The Voltage Measure Only mode works best when the sense terminals are connected to the output terminals, either by connecting the sense and load leads to directly to the DUT, or by using the local sensing on the front panel. Note that the input impedance in Voltage Measure Only mode will be somewhere around 2000 pF depending on the grounding of the DUT. This may draw up to a few microamperes of current from the nodes that are being measured.

NOTE

The voltage measurement cannot exceed the voltage ratings of the unit as indicated in the +/- Voltage Limit fields.

The **Current Measure Only** selection emulates a zero-burden ammeter. Voltage priority mode is set by default. The +/- Current Limits are set to their maximum values. No additional settings are required.

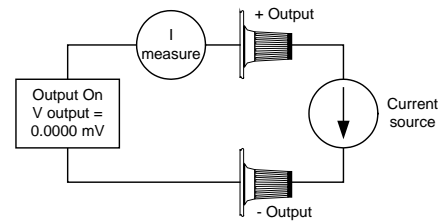
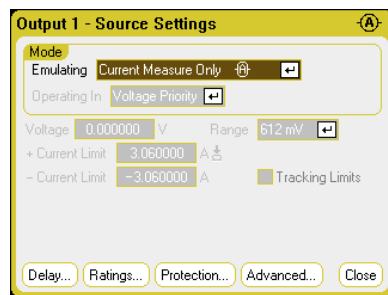
**NOTE**

The current measurement cannot exceed the current ratings of the unit as indicated in the +/- Current Limit fields.

When the Measure Only modes are selected, the output is enabled and the voltage or current measurement is continuously displayed on the Meter View as shown below. Note that *both* voltage and current meter functions are active in either mode.

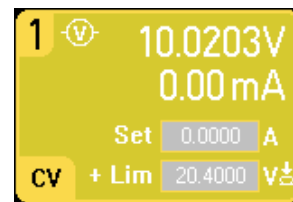
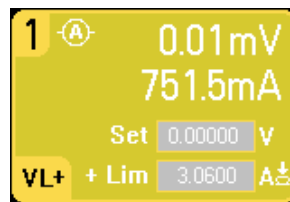
**From the remote interface:**

To specify voltage measure only:

```
EMUL VMET, (@1)
```

To measure the voltage:

```
MEAS:VOLT? (@1)
```

To specify current measure only:

```
EMUL AMET, (@1)
```

To measure the current:

```
MEAS:CURR? (@1)
```

Agilent N6781A Auxiliary Voltage Measurements

NOTE

The following information only applies to Agilent Model N6781A.

The Agilent N6781A has an auxiliary voltage measurement input, whose primary use is for battery voltage rundown measurements. It may also be suitable for other applications including general purpose DC voltage measurements between +/-25 VDC. The auxiliary voltage measurement input is isolated from other commons. It has a bandwidth of about 2 kHz. It has one input range: -25 to +25 VDC.

Auxiliary voltage measurements cannot be made along with output voltage measurements. When the auxiliary voltage measurement input is selected, all voltage measurement functions receive their input from this source instead of the normal + and - sense terminals. These functions include the front panel, SCPI measurements, Scope View, Data Logger View, Elog, and histogram measurements.

From the front panel

To enable auxiliary voltage measurements, select Meter View, then Properties, then select Aux Voltage.

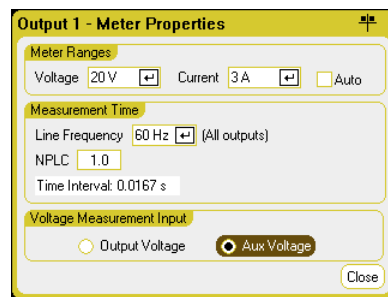

The instrument will continuously display the auxiliary voltage measurement on the front panel Meter View:

NOTE

When the auxiliary voltage measurement terminals are left unconnected, the front panel meter will indicate a voltage reading of approximately 1.6V. This is a normal indication which does not affect the external voltage measurement once the measurement terminals are connected.

From the remote interface:

To specify the auxiliary voltage measurement input:

```
SENS:FUNC:VOLT:INP AUX, (@2)
```

Using the Scope Functions

The DC Power Analyzer's scope function is similar to a bench oscilloscope, displaying output voltage and current signals as a function of time. It has controls that select which outputs and functions to display, front panel knobs that adjust gain and offset, and configurable triggers and markers.

You can configure the Scope View to display voltage or current waveforms for all outputs. Power waveforms can only be displayed on Agilent Models N676xA and N678xA SMU, as these have simultaneous voltage and current measurement capability (see chapter 1, "Power Module Features"). As explained under "Scope Horizontal", the maximum sampling rate of the scope varies, depending on the number of waveforms that are displayed. Note that in the Scope View there is only one time-base and trigger configuration for all outputs.

Making a Measurement

In the following measurement example, an output turn-on sequence is displayed using the oscilloscope. The oscilloscope measures the actual voltages as the outputs turn on.

Step 1 – Program the output voltage and current values:

In Meter View, set the output voltage and currents of all four outputs of the DC Power Analyzer to 10 volts and 1 ampere. This is described in chapter 3 under "Controlling the Outputs".



Step 2 – Configure the output turn-on sequence:

Configure the output turn-on sequence as described in chapter 3 under "Configuring a Turn-On/Turn-Off Sequence". Note that you will only need to configure the Turn-on delays, not the turn off delays. The turn on delays for the output channels are as follows:

- Output 1: 10 ms
- Output 1: 20 ms
- Output 1: 30 ms
- Output 1: 40 ms

4 Using the Measurement Functions

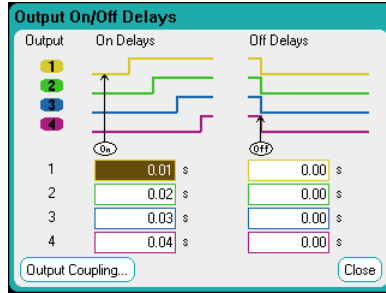

Step 3 – Configure the Scope View traces:

- Check V1 through V4
- Uncheck I1 through I4
- Use the Vertical Volts/Div. knob to set V1 through V4 to 10 V/Div.
- Use the Offset knob to move the four traces so that they are separated by at least one space on the vertical grid.
- Use the Horizontal Time/Div. knob to set the timebase to 20 ms.

Traces are color coded according to output.

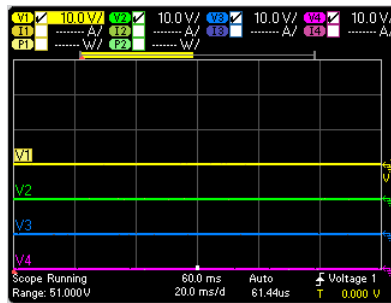

Step 4 – Configure the Scope properties:

Press the **Properties** key to configure the scope properties as follows:

- In the Trigger Source dropdown list, select **Output ON/Off Key**.
- In the Mode dropdown list, select **Single**.
- Select the **Horizontal** button and make sure that the Horizontal Offset Reference is set to **Left**.

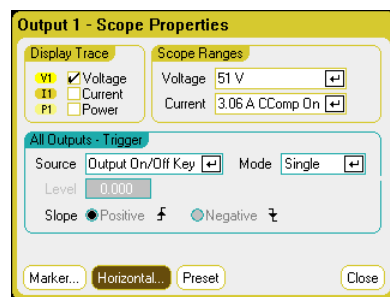

Step 5 – Turn on the outputs and measure the voltage:

Press **Scope View** to return the display the scope view.

- Press the **Run/Stop** key to run the scope. When this key is lit, it indicates that the scope is running.
- Press the **All Outputs On** key to start the output sequence and trigger the scope.

You should see the output waveforms displayed as follows:

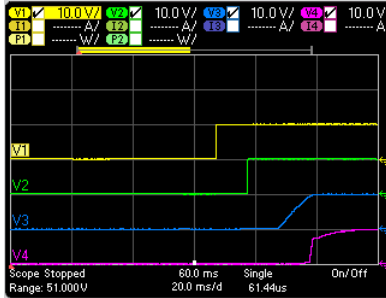

Note that the delay for output 1 does not start until 57 milliseconds have elapsed. This is because the internal delay for the mainframe used in this example is 57 milliseconds. This built in delay precedes any user-defined delays that have been programmed.

Also note that outputs 3 and 4 start at the specified delay time but do not ramp up as fast as outputs 1 and 2. This is because Outputs 1 and 2 are “Precision” and “High Performance” modules, while outputs 3 and 4 are “DC Power” modules, which have a slower turn-on ramp. Refer to chapter 1 under “Power Module Features”.

From the remote interface:

You cannot program the scope from the remote interface.

Scope View



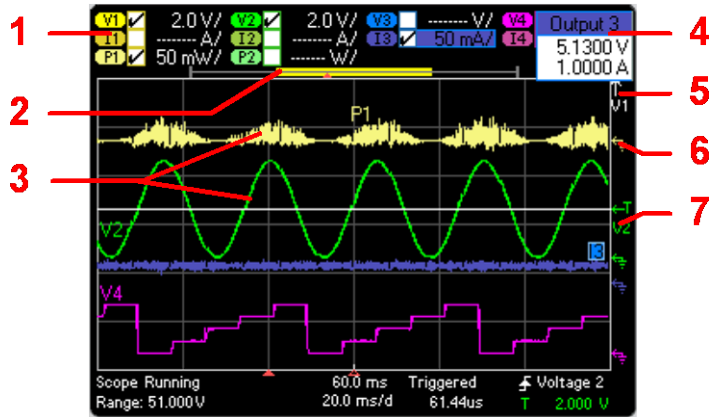

Press the **Scope View** key to view the scope. This key toggles between the Standard view shown below, and Marker view, which enables markers and marker calculations.

Standard View

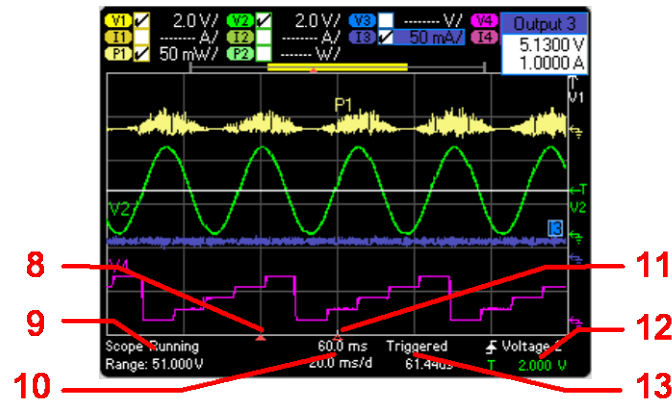

Symbol/Field:	Description:
1 Trace Controls 	Identifies the volt/div. or curr/div. setting. indicates the trace is on. Dashes (----) indicate the trace is off. Select the trace and press Enter to turn it on or off.
2 Data Bar 	The data bar represents all of the waveform data that has been collected. The yellow part indicates the portion of the data that is visible on the display. The black part represents the data that is not visible.
3 Scope Traces 	Voltage trace labels appear on the left side of the grid (V1 V2, V3, V4). Current trace labels appear on the right side of the grid (I1, I2, I3, I4). Power trace labels appear on the center of the grid (P1, P2, P3, P4). If a portion of a trace is red, it means that portion of the trace is out of range. Only Models N676xA and N678xA SMU can display power traces.
4 Output Pop-ups 	If you turn the voltage and current knobs, a pop-up dialog will indicate the present output settings. If you push the voltage and current knobs, a pop-up dialog appears to allow the following actions: <div style="display: flex; justify-content: space-around;"> <div> <p>Voltage</p> </div> <div> <p>Current</p> </div> </div> <p>Lock/Unlock the voltage or current knobs. On Models N678xA, select a limit parameter to control or select limit tracking.</p>
5 Out of View Arrows 	Indicates that the trace, V1 in this example, is out of view. Use the Vertical Volt/Div knob or the Vertical Offset knob to bring the trace into view. Push the Trigger Level knob to autoscale the traces so that all of them will appear on the display. This will trigger a new measurement.
6 Ground Reference 	The ground reference of the trace. Ground references are offset so that they do not overlap. The ground reference offset value is referenced to the horizontal center line of the grid.
7 Trigger Level 	Shows the location of the voltage or current trigger level and output. In this example, the voltage trigger level of output 2 is shown. The trigger source and amplitude are shown at the bottom right of the display.



Symbol/Field:	Description:
8 Trigger Indicator 	Shows the position of the trigger with respect to the waveform. In this example, the trigger is offset to the left of the original point. The trigger point corresponds to the offset reference when the offset is zero.
9 Scope Status Range	Indicates whether the scope is Running, Stopped, or Waiting for a trigger. Range indicates the measurement range setting of the selected trace. If the range field is red, it means that portions of the selected trace are out of range.
10 Time Time/Div.	Indicates the time from the trigger point indicator to the vertical center line of the grid. Negative values indicate the center line is to the left of the trigger point. Positive values indicate the center line is to the right of the trigger point. Use the front panel Horizontal Offset knob to adjust the trigger point. Identifies the horizontal time-base setting. This can be adjusted using the front panel Horizontal Time/Div knob.
11 Horizontal Reference 	Indicates the horizontal reference. In this example, the reference is centered. Change the reference justification in the Scope Horizontal Properties window.
12 Trigger Source Amplitude	The scope's trigger source. In this example, the trigger source is a voltage level on output 2.  Indicates the measurement will be triggered on the up-slope (positive).  Indicates the measurement will be triggered on the down-slope (negative). If the trigger source is set to a voltage or current level, the amplitude of the trigger level is indicated below the trigger source. In this example, the voltage trigger level is set to 4.5V.
13 Trigger Mode Sample Rate	Indicates the trigger mode (Auto, Single, or Triggered). The indicated scope sample rate is based on the horizontal time/div. setting. When the time/div. setting is less than 20 ms/division, the scope will sample at its fastest rate, depending on the number of traces selected: 1 trace (Model N678xA SMU only): 5.12 microseconds 1 to 2 traces (all modules): 10.24 microseconds 3 to 4 traces (all modules): 20.48 microseconds



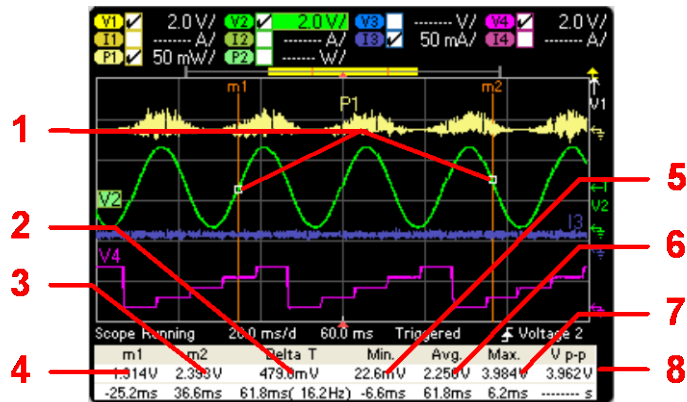



Marker View

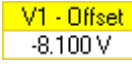

Symbol/Field:	Description:
1 m1/m2 points	Shows where the measurement markers intersect the selected waveform. Data values at the bottom of the display are referenced to the intersect locations of the markers. Calculations are based on the data points in between the intersect locations.
2 Delta	Indicates the delta or absolute difference between the markers in units (volts, amps, or watts) and in time (seconds). The value in parenthesis is the frequency, which is the reciprocal of the time (1/time).
3 m2	Indicates the m2 marker value in volts, amps, or watts at the intersection point. Also indicates the distance in time that the m2 marker is in relation to the present trigger position.
4 m1	Indicates the m1 marker value in volts, amps, or watts at the intersection point. Also indicates the distance in time of the m1 marker in relation to the present trigger position.
5 Min	Indicates the minimum data value (in volts, amps, or watts) between the marker locations of the selected waveform. Also indicates the distance in time of the minimum value in relation to the present trigger position.
6 Avg	Calculates the average data value (in volts, amps, or watts) between the marker locations of the selected waveform. Time indicates the time between markers over which the average value is calculated.
7 Max	Indicates the maximum data value (in volts, amps, or watts) between the marker locations of the selected waveform. Also indicates the distance in time of the maximum value in relation to the present trigger position.
8 V p-p	Calculates the difference between the maximum and minimum values. Time information is not valid for calculated p-p values.
RMS (if selected)	Calculates the rms value between the marker locations. To view the rms values, you must unselect one of the other measurements in the Scope Marker Properties window. Only 5 measurements may be displayed at a time.

Using the Waveform Display Knobs

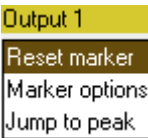

Knob:	Description:
1 Vertical Volts/Div	Makes the waveform bigger or smaller vertically in relation to its ground reference. Specified in volts/division or amps/division on the y axis. On outputs with multiple ranges, when Knob Control is selected in the Scope Range Property window, adjusting the vertical gain will automatically select lower measurement ranges for better resolution. If the vertical gain causes the trace to be out of view, arrow symbols   will indicate the direction of the trace.
2 Vertical Offset	Moves the ground reference of the trace up or down in relation to the horizontal <i>center line</i> of the grid. The offset popup that appears in the upper right corner of the display shows  how far the ground reference of the selected trace is above or below the horizontal center line of the grid. Positive values indicate that the center line is <i>above</i> the ground reference. Negative values indicate that the center line is <i>below</i> the ground reference.
3 Trigger Level	Moves the trigger level up and down when a voltage or current level is the trigger source. The trigger level is identified by the  symbol. If the trigger level is out of view, an arrow  indicates the direction of the trigger level. Push the Trigger Level knob to auto-scale the traces on the display. This will trigger a new measurement.
4 Horizontal Time/Div	Stretches or shrinks the waveform horizontally around the horizontal offset reference. Specified in time/division on the x axis. Applies to ALL traces.
5 Horizontal Offset	Moves the waveform to the right or left of the horizontal offset reference. The trigger point is indicated by the solid arrow. 
6 Marker 1/Marker 2	Moves the measurement markers right or left. Press <code>Scope View</code> to display the markers. Markers are displayed on the selected trace. Values at the bottom of the display are referenced to the intersection of the markers. If a marker is out of view, an arrow indicates the direction of the marker.  Push the Marker 1 or Marker 2 knobs to reset the markers. When pushed, the following menu appears.  Push the <code>Enter</code> key to Reset the marker. Push <code>Enter</code> again to undo the reset action. Scroll down and select Marker options to access the Scope Marker Properties window. Scroll down and select Jump to peak to move the marker to the peak measurement point of the trace.

Scope Properties

NOTE

There are no remote interface commands that correspond directly to the front panel Scope functions. See chapter 5, “Digitizing Measurements” for information on programming digitized measurements from the remote interface.

With the Scope View displayed, press the **Properties** key to access the Scope Properties window.

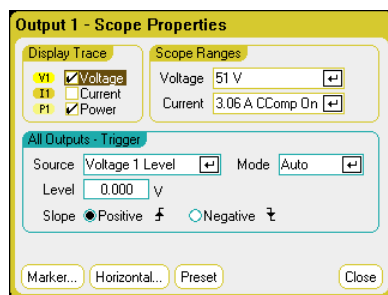

In the **Display Trace** area, select which traces to display for the output. If no box is checked, no traces will be displayed for that output. Voltage, current, and power traces can be displayed simultaneously only on Agilent Models N676xA and N678xA SMU, as these models have simultaneous voltage and current measurement capability (see chapter 1, “Power Module Features”). All other power modules can display either voltage or current traces, but not simultaneously.

In the **Trigger** area, use the **Source** dropdown list to select a trigger source. This trigger source will trigger the scope measurements on **all** output channels. Depending upon the selected trigger source, you can trigger the scope as follows:

Trigger Source:	Description:
Voltage <1-4> level	Triggers the measurement when the voltage or current of the corresponding output passes through the specified level.
Current <1-4> level	Triggers the measurement when the voltage or current of the corresponding output passes through the specified level.
Arb Run/Stop key	Trigger the measurement when the Arb Run/Stop key is pressed.
Output On/Off key	Trigger the measurement when any of the Output On/Off keys are pressed. Also applies to the All Outputs On/Off key.
BNC Trigger In	Provide a low-true signal to the BNC trigger input connector. The signal must have a minimum pulse width of 2 microseconds. Selecting BNC Trigger In also enables any digital I/O pins configured as Trigger Outputs (see Appendix C).
Remote Command	Send a trigger command over one of the three interfaces (i.e. *TRG).

If a trigger source is grayed out, it is unavailable. This can happen on power modules that cannot simultaneously display voltage and current. For these power modules, if one of the traces has been turned on, you cannot use the other trace as the trigger source. Also, current levels are not available as trigger sources on outputs that have been grouped (paralleled).

The **Level** field lets you specify a trigger level if you selected a Voltage level or Current level as the trigger source. The **Slope** selection specifies if the measurement will be triggered on the positive (up-slope) or negative (down-slope) portion of the waveform.

Use the **Mode** dropdown list to select a trigger mode.

Trigger Mode:	Description:
Auto	Configures the scope to display a single-sweep measurement when a trigger is received, or automatically if a trigger is not received. The scope continues running and waits for another trigger when the measurement completes.
Single	Configures the scope to display a single-sweep measurement when a trigger is received. The scope stops running when the measurement completes.
Triggered	Configures the scope to display a single-sweep measurement when a trigger is received. The scope continues running and waits for the next trigger when the measurement completes.

Scope Ranges

For outputs that have multiple measurement ranges, you can select a lower range for better measurement resolution. Scope range settings are independent of the Meter View and Data Logger range settings.

In the **Scope Ranges** area, select the desired lower measurement range from the **Voltage** or **Current** dropdown menus.

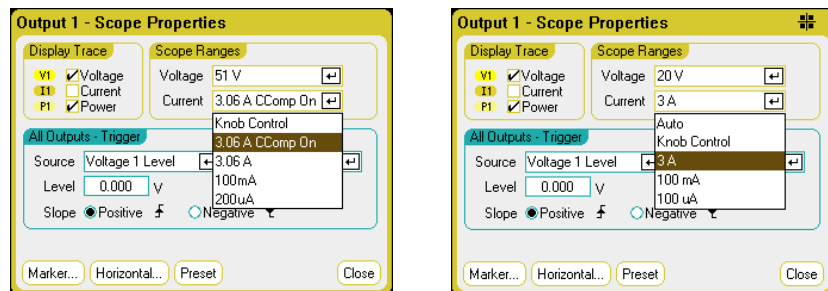

Selecting **Knob Control** allows the **Vertical Volts/Div** knob on the front panel to automatically select lower measurement ranges at lower measurement resolutions. For higher measurement resolution a higher range is automatically selected. The present range is displayed on the lower left corner of the Scope View window.

Some models have a high measurement range labeled **CComp On**, which is selected by default. The CComp On range compensates output current measurements during voltage transients. For more information, see chapter 6 under “Dynamic Current Correction”.

Seamless Measurements

For Agilent Models N6781A and N6782A only, you can select seamless voltage and current measurements. The **Auto** selection provides seamless measurement ranging, which results in a wide dynamic range with no data being lost across ranges. Autoranging does not include the 10 μ A range, which must be selected manually.

Scope Marker

Select the **Markers** button to configure the measurements that appear on the bottom of the display in Marker view. Measurements apply to the portion of the waveform between the two markers. You can only select a maximum of five measurements to be displayed.

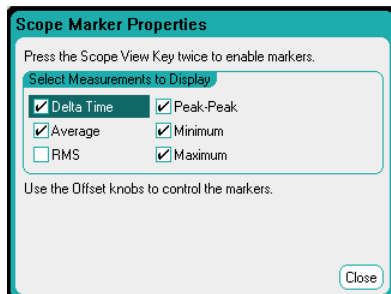

Scope Horizontal

Select the **Horizontal** button to configure the horizontal properties.

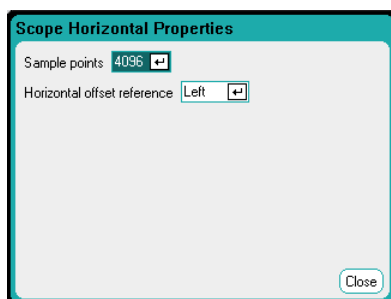

The **Sample Points** field lets you specify the number of points in a scope trace. The maximum number of points that can be specified depends on the number of scope traces that have been enabled. The minimum number of points that can be specified is 1024.

- | | |
|---------------------------------------|--------------------------------------|
| 1 trace enabled: 256 K points | 4 traces enabled: 64 K points |
| 2 traces enabled: 128 K points | 8 traces enabled: 32 K points |
| (maximum points = 256 K/# of traces) | |

The Power trace counts as 2 traces, since voltage and current must be measured to calculate power. If the voltage and current traces have already been selected, the Power trace is not counted.

The **Horizontal Offset Reference** places the reference point on the left, right, or center of the display. This is the position of the trigger if no offset has been set. Left lets you see the waveform after the trigger event. Center lets you see the waveform before and after the trigger event. Right lets you see the waveform up to the trigger event.

Scope Preset

Select the **Preset** button to return the Scope View to the power-on display settings. The vertical offset of each trace will be set to a different value. This is to prevent the traces from overlapping. The offset is referenced to the horizontal center line of the grid.

Using the Data Logger Functions

NOTE

The Data Logger function is not available if Option 055 has been ordered.

The Data Logger is similar to the Scope View function except that it lets you view and log output voltage and current data for up to 99,999 hours.

As in Scope View, you can configure the Data Logger View to display voltage or current waveforms for all outputs. Power waveforms can be displayed for *all* outputs because of the interleaved data logging capability. See “Data Logger Sampling Modes” later in this chapter.

The display functions like a strip chart recorder. Use the Waveform Display knobs to scroll through the data. Unless specified otherwise, data is automatically stored to a file named *default.dlog*.

Logging Data

In the following data log example, a user-defined arbitrary waveform is captured on the data logger. The data logger records the actual output voltage of the arbitrary waveform.

Step 1 – Program the arbitrary waveform:

Configure the user-defined arbitrary waveform as described in chapter 3 under “Configuring User-Defined Arbs”. Program the voltage and time values as follows:

- Step 0: 10 V; 1 s
- Step 1: 20 V; 1 s
- Step 2: 30 V; 1 s
- Step 3: 40 V; 1 s
- Step 4: 50 V; 1 s
- Repeat Count: 5

Output 1 - User Defined Voltage Properties

Step	Voltage	Time	Trig Out
0	10.0000	1.0000	
1	20.0000	1.0000	
2	30.0000	1.0000	
3	40.0000	1.0000	
4	50.0000	1.0000	

Buttons: Add, Delete, Clear, Import, Export

Voltage After Arb:
 Return to DC Value Last Arb Value

Continuous Repeat Count: 5 Close

Step 2 – Configure the Data Logger traces:

- Check V1
- Uncheck V2 through V4 as well as the current and power traces.
- Use the Vertical Volts/Div. knob to set V1 10 V/Div.
- Use the Offset knob to move the V1 trace to the bottom of the grid.

Traces are color coded according to output. The ground symbol on the right side of the display indicates the ground reference of the trace.

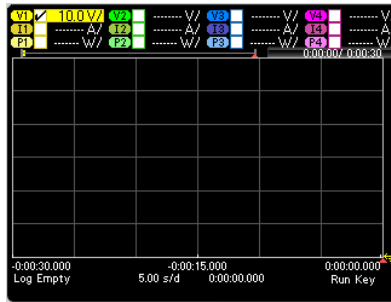

Step 3 – Configure the Data Logger properties:

Press the **Properties** key to configure the data logger properties:

- Leave the default Duration and Sample Period at 30 seconds and 100 milliseconds respectively.
- Select the **Trigger** button and set the trigger source to **Arb Run/Stop Key**.

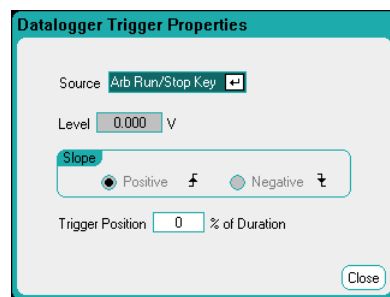
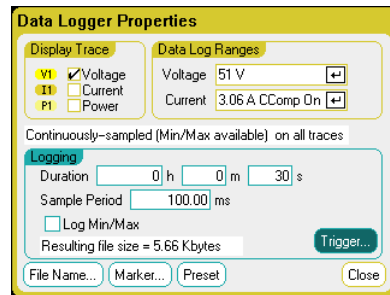

Step 4 – Turn on output 1, start the Arb, and log the data:

Press **Data Logger** to return the display to the data logger view.

- Press the **Output 1 On** key to turn on output 1.
- Press the **Run/Stop** key to run the data logger. When this key is lit, the data logger is initiated and the output 1 trace is displayed on the screen.
- Press the **Arb Run/Stop** key to start the user-defined Arb and trigger the data logger.

The data logger will run for 30 seconds and log the voltage data from output 1. When the data log completes, you should see the output waveform displayed as follows:

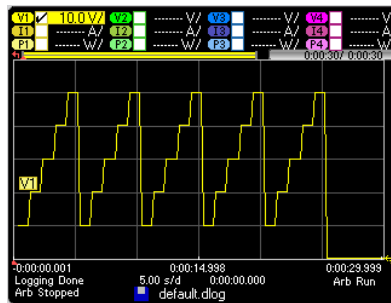

A message will indicate that the logged data has been saved in a file named default.dlog. If you wish to save the data under a different filename, you must specify the filename *before* the data logger runs. Select the **Filename** button located in the **Datalogger Properties** dialog to specify a filename.

Step 5 – Use the marker controls to measure the logged data:

Press **Data Logger** to display the marker controls.

- Use the marker 1 and Marker 2 knobs to move the markers along the voltage trace. Measurements between the markers are displayed on the bottom of the display.
- You can also use the **Vertical Volts/Div** knob and the **Horizontal Time/Div** knob to zoom in on any portion of the logged data.

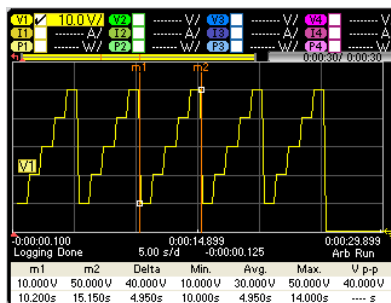

From the remote interface:

To program a User-defined voltage waveform of 5 steps on output 1:

```
ARB:FUNC:TYPE VOLT, (@1)
ARB:FUNC:SHAP UDEF, (@1)
ARB:VOLT:UDEF:LEV 10, 20, 30, 40, 50, (@1)
ARB:VOLT:UDEF:DWEL 1, (@1)
ARB:VOLT:UDEF:BOST 0, (@1)
ARB:TERM:LAST OFF, (@1)
```

To initiate the transient trigger system:

```
VOLT:MODE ARB, (@1)
TRIG:ARB:SOUR BUS
INIT:TRAN (@1)
```

To set up the data log for output 1:

```
SENS:DLOG:VOLT ON, (@1)
SENS:DLOG:TIME 30
SENS:DLOG:PER .1
```

To initiate that data logger and specify the filename in which to save the data:

```
TRIG:DLOG:SOUR BUS, (@1)
INIT:DLOG "internal:\data1.dlog"
```

To turn on output 1 and trigger the Arb and the data logger:

```
OUTP ON, (@1)
*TRG
```

Once the data log completes, you can position the data log markers and return data from between the marker locations. To position the two data log markers at 10 seconds and at 15 seconds from the start trigger of the data log:

```
SENS:DLOG:MARK1 10
SENS:DLOG:MARK2 15
```

The following commands return either the average, minimum, or maximum values between the marker positions:

```
FETC:DLOG:VOLT? (@1)
FETC:DLOG:VOLT:MIN? (@1)
FETC:DLOG:VOLT:MAX? (@1)
```

Data Logger View



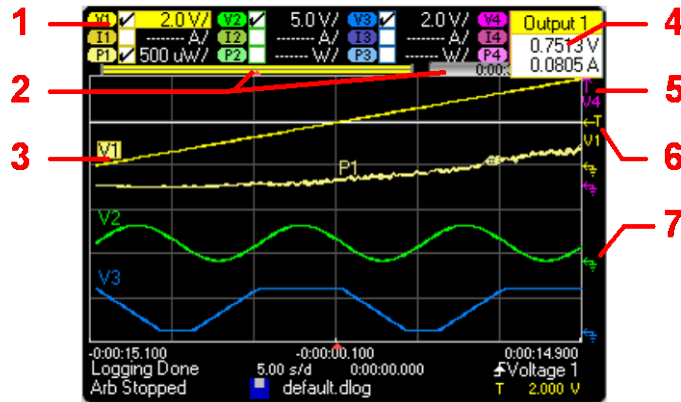

Press the **Data Logger** key to access the Data Logger. This key toggles between the Standard view shown below, and Marker view, which enables markers and marker calculations.

Standard View

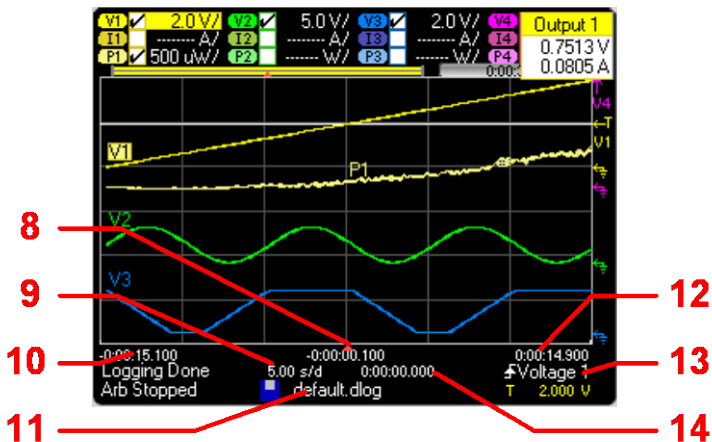

Symbol/Field:	Description:																
1 Trace Controls	Identifies the volt/div. or curr/div. settings. <input type="checkbox"/> indicates the trace is on. Dashes (---) indicate the trace is off. Select the trace and press Enter to turn it on or off.																
2 Data Bar	Represents all of the logged data. The yellow part indicates the data that is visible on the display. The black part represents the data that is not visible.																
Time Elapsed	Indicates the time elapsed during the data log and the total duration. The values match when data logging finishes.																
3 Data Traces	Voltage trace labels appear on the left side of the grid (V1 V2, V3, V4). Current trace labels appear on the right side of the grid (I1, I2, I3, I4). Power trace labels appear on the center of the grid (P1, P2, P3, P4). If a portion of a trace is red, it means that portion of the trace is out of range. Push the Trigger Level knob to auto-scale the data traces.																
4 Output Pop-ups	If you turn the voltage and current knobs, a pop-up dialog will indicate the present output settings. If you push the voltage and current knobs, a pop-up dialog appears to allow the following actions: <div style="display: flex; align-items: center;"> <div style="margin-right: 20px;"> <table border="1"> <tr><td>Output 1</td><td>Output 1</td></tr> <tr><td>5.5300 V</td><td>+ Current Limit</td></tr> <tr><td>2.0000 A</td><td>- Current Limit</td></tr> <tr><td></td><td><input checked="" type="checkbox"/> Tracking</td></tr> <tr><td></td><td>Lock Current Knob</td></tr> <tr><td></td><td><input checked="" type="checkbox"/> Unlock Knob</td></tr> </table> </div> <div> <table border="1"> <tr><td>Voltage</td><td>Current</td></tr> <tr><td></td><td></td></tr> </table> </div> </div> <p>Lock/Unlock the voltage or current knobs. On Models N678xA, select a limit parameter to control or select limit tracking.</p>	Output 1	Output 1	5.5300 V	+ Current Limit	2.0000 A	- Current Limit		<input checked="" type="checkbox"/> Tracking		Lock Current Knob		<input checked="" type="checkbox"/> Unlock Knob	Voltage	Current		
Output 1	Output 1																
5.5300 V	+ Current Limit																
2.0000 A	- Current Limit																
	<input checked="" type="checkbox"/> Tracking																
	Lock Current Knob																
	<input checked="" type="checkbox"/> Unlock Knob																
Voltage	Current																
5 Out of View Arrows	Indicates that the trace, V4 in this example, is out of view. Use the Vertical Volt/Div knob or the Vertical Offset knob to bring the trace into view. Push the Trigger Level knob to auto-scale the traces.																
6 Trigger Level	Shows the location of the voltage or current trigger level and output. In this example, the voltage trigger level of output 1 is shown. The trigger source and amplitude are shown at the bottom right of the display.																
7 Ground Reference	The ground reference of the trace. Ground references are offset so that they do not overlap. The ground reference offset value is referenced to the horizontal center line of the grid.																



Symbol/Field:	Description:
8 Trigger Point Indicator 	Indicates the trigger position in the data log. In this example the trigger point was offset by 50%, and the pre trigger data and the post trigger data was logged. The time at the trigger point is always zero. Change the trigger offset in the Datalogger Trigger Properties window.
9 Time/Div.	Identifies the horizontal time-base setting. This can be adjusted using the front panel Horizontal Time/Div knob.
10 Left-Grid Time	Identifies the time at the left gridline in relation to the trigger point. If the trigger is at the left of the grid, the time will be zero.
11 Filename	Indicate the filename to which the data will be logged.
12 Right-Grid Time	Identifies the time at the right gridline in relation to the trigger point. If the trigger point is at the start of the data log, the time will equal the total duration of the data log.
13 Trigger Source	Indicates the trigger source; in this example, the trigger source is a voltage level on output 1. The Data Logger starts logging data when the indicated level is reached.  indicates the Data Logger will be triggered on the up-slope (positive).  indicates the Data Logger will be triggered on the down-slope (negative).
Amplitude	If the trigger source is set to a voltage or current level, the amplitude of the trigger level is indicated below the trigger source. In this example, the voltage trigger level is set to 2V.
14 Offset Time 	Indicates the time that the right gridline is offset or away from the end of the data log. When this value is zero, it means that the right gridline is positioned at the end of the data log. Turning the offset knob will move the grid away from the end of the data log, as indicated by the Offset Time. The yellow part of the bar represents the data that is visible on the display. The black part represents the offset time.



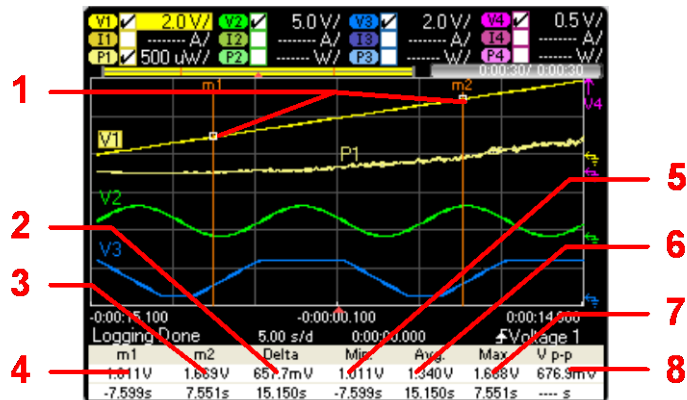



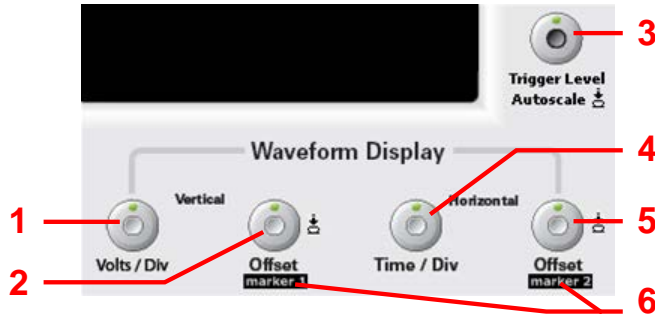

Marker View

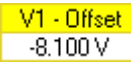

Symbol/Field:	Description:
1 m1/m2 points	Shows where the measurement markers intersect the selected waveform. Data values at the bottom of the display are referenced to the intersect locations of the markers. Calculations are based on the data points in between the intersect locations.
2 Delta	Indicates the delta or absolute difference between the markers in units (volts, amps, or watts) and in time (seconds).
3 m2	Indicates the m2 marker value in volts, amps, or watts at the intersection point. Also indicates the distance in time that the m2 marker is in relation to the present trigger position.
4 m1	Indicates the m1 marker value in volts, amps, or watts at the intersection point. Also indicates the distance in time of the m1 marker in relation to the present trigger position.
5 Min	Indicates the minimum data value (in volts, amps, or watts) between the marker locations of the selected waveform. Also indicates the distance in time of the minimum value in relation to the present trigger position.
6 Avg	Calculates the average data value (in volts, amps, or watts) between the marker locations of the selected waveform. Time indicates the time between markers over which the average value is calculated.
7 Max	Indicates the maximum data value (in volts, amps, or watts) between the marker locations of the selected waveform. Also indicates the distance in time of the maximum value in relation to the present trigger position.
8 V p-p	Calculates the difference between the maximum and minimum values. Time information is not valid for calculated p-p values.
Ah (if selected)	Calculates the Amp-hours between the marker locations. To view the Amp hours, you must unselect one of the other measurements in the Datalogger Marker Properties window. Only 5 measurements may be displayed at a time.
Wh (if selected)	Calculates the Watt-hours between the marker locations. To view the Watt hours, you must unselect one of the other measurements in the Datalogger Marker Properties window. Only 5 measurements may be displayed at a time.

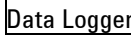
Using the Waveform Display Knobs

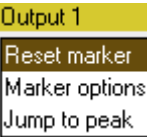

Knob:	Description:
1 Vertical Volts/Div	Makes the waveform bigger or smaller vertically in relation to its ground reference. Specified in volts/division or amps/division on the y axis. If the vertical gain causes the trace to be out of view, arrow symbols   will indicate the direction of the trace.
2 Vertical Offset	Moves the ground reference of the trace up or down in relation to the horizontal <i>center line</i> of the grid. The offset popup that appears in the upper right corner of the display shows  how far the ground reference of the selected trace is above or below the horizontal center line of the grid. Positive values indicate that the center line is <i>above</i> the ground reference. Negative values indicate that the center line is <i>below</i> the ground reference.
3 Trigger Level	Moves the trigger level up and down when a voltage or current level is the trigger source. The trigger level is identified by the  symbol. If the trigger level is out of view, an arrow  indicates the direction of the trigger level. Note that trigger levels are not available in Normal (interleaved) mode. Push the Trigger Level knob to auto-scale the traces on the display.
4 Horizontal Time/Div	Zooms in or out of the data so that you can view waveform details. The numbers on the bottom of the display indicate the location of the data that is being viewed relative to the entire data log.
5 Horizontal Offset	Moves the grid area to the right or left along the logged data.
6 Marker 1/Marker 2	Moves the measurement markers right or left. Press  to display the markers. Markers are displayed on the selected trace. Values at the bottom of the display are referenced to the intersection of the markers. If a marker is out of view, an arrow indicates the direction of the marker.  Push the Marker 1 or Marker 2 knobs to reset the markers. When pushed, the following menu appears.  Push the  key to Reset the marker. Push  again to undo the reset action. Scroll down and select Marker options to access the Datalogger Marker Properties window. Scroll down and select Jump to peak to move the marker to the peak measurement point of the trace.

Data Logger Properties

From the front panel:

With the Data Logger view displayed, press the **Properties** key.

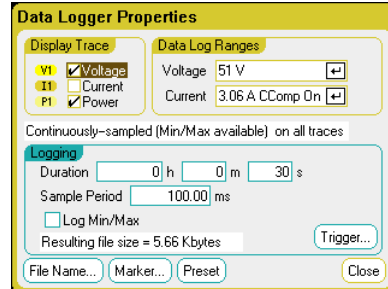

In the **Display Trace** area, select which traces to display for the output. If no box is checked, no data logging will occur on the output.

The text line under the traces identifies the data logging mode. *Continuously-sampled* mode continuously samples the voltage or current data at a 20.48-microsecond rate and stores one averaged value per sample period. Selecting Log Min/Max also stores the minimum and maximum values per sample period. *Normal (interleaved)* mode alternates voltage and current measurements. One voltage and one current value is returned per sample period.

NOTE

Depending on which traces are enabled on specific power modules, the Data Logger selects between Continuously-sampled mode and Normal (interleaved) mode. Refer to “Data Logger Sampling Modes” later in this chapter for details.

In the **Logging** area, the **Duration** fields let you specify the duration of the data log in hours, minutes, and seconds. The maximum duration is 99,999 hours. The logging information applies to data logger measurements on **all** output channels.

The **Sample period** specifies the interval between data samples in milliseconds, which can be set from 20 microseconds to 60 seconds.

Check **Log Min/Max** to log the minimum and maximum values to the data log file when in Continuously-sampled mode. When Log Min/Max is checked, it will triple the resulting file size.

The **Resulting file size** text box indicates the file size when the data log completes. The maximum file size is 2E9 bytes (1.87 Gbytes in Microsoft Windows units). If settings exceed this limit, the logging interval will automatically increase to keep the size within the limit. If the file size exceeds the available space on the drive to which it will be written, an error is generated and the Data Logger will not run.

From the remote interface:

To enable current or voltage data logging on outputs 1 and 2:

```
SENS:DLOG:CURR ON, (@1, 2)
SENS:DLOG:VOLT ON, (@1, 2)
```

You cannot data log output power from the remote interface. To obtain power data, you need to data log both voltage and current and then calculate the power from the resulting voltage and current data.

To log the minimum and maximum values to the data log file for all enabled outputs:

```
SENS:DLOG:MINM ON
```

To specify a data log of 1000 seconds on all enabled outputs:

```
SENS:DLOG:TIME 1000
```

To specify a sample period of 50 milliseconds between data samples on all enabled outputs:

```
SENS:DLOG:PER .05
```

Data Logger Ranges

For outputs with multiple measurement ranges, you can select a lower range for better measurement resolution. Data Logger range settings are independent of the Meter View and Scope range settings.

From the front panel:

In the **Data Log Ranges** area, select the desired lower measurement range from the **Voltage** or **Current** dropdown menus.

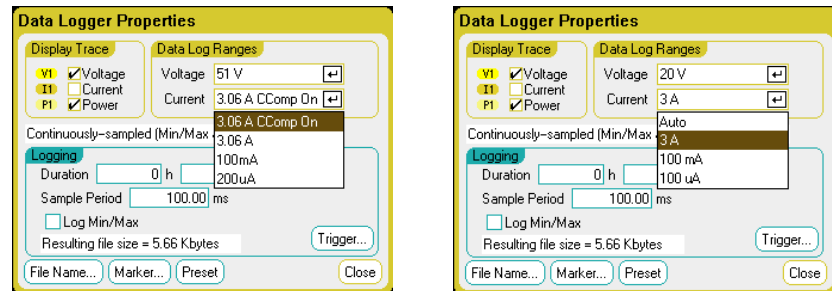

Some models have a high measurement range labeled **CComp On**, which is selected by default. The CComp On range compensates output current measurements during voltage transients. For more information, see chapter 6 under “Dynamic Current Correction”.

Seamless Measurements

For Agilent Models N6781A and N6782A only, you can select seamless voltage and current measurements. The **Auto** selection provides seamless measurement ranging, which results in a wide dynamic range with no data being lost across ranges. Autoranging does not include the 10 μ A range, which must be selected manually.

From the remote interface:

To select a lower current or voltage measurement range:

```
SENS:DLOG:CURR:RANG 0.1, (@1)
SENS:DLOG:VOLT:RANG 5, (@1)
```



Data Logger Trigger

NOTE

Once the Data Logger has been triggered, do not change the display to Scope View or Meter View; otherwise Data Logger will stop.

From the front panel:

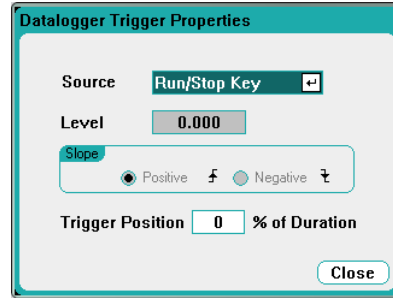
Select the **Trigger** button to configure the trigger properties. The Data Logger uses triggers to synchronize itself with an external event.



The **Source** dropdown list lets you select a trigger source. The same trigger source will be used to trigger all of the outputs that have been configured for data logging. Depending upon the selected trigger source, you can trigger the Data Logger as follows:

Trigger Source:	Description:
Voltage <1-4> level	Triggers the Data Logger when the voltage or current of the corresponding output passes through the specified level.
Current <1-4> level	Triggers the Data Logger when the voltage or current of the corresponding output passes through the specified level.
Run/Stop key	Trigger the Data Logger when the Run/Stop key is pressed. This is the default trigger source.
Arb Run/Stop key	Trigger the Data Logger when the Arb Run/Stop key is pressed.
Output On/Off key	Trigger the Data Logger when any of the Output On/Off keys are pressed. Also applies to the All Outputs On/Off key.
BNC Trigger input	Provide a low-true signal to the BNC trigger input connector. The signal must have a minimum pulse width of 2 microseconds. Selecting BNC Trigger In also enables any digital I/O pins configured as Trigger Outputs (see Appendix C).
Remote Command	Send a trigger command over one of the three interfaces (i.e. *TRG).

If a trigger source is grayed out, it is unavailable. For example, current levels are not available as trigger sources on outputs that have been grouped (paralleled). Note also that a trace *must* be turned on for it to be used as a trigger source.

Level - specifies a trigger level if you selected a Voltage level or Current level as the trigger source. Along with the level, you must also specify a **Slope** - if the measurement will be triggered on the positive (up-slope) or negative (down-slope) portion of the waveform.

Trigger Position % of Duration - specifies a trigger offset. This allows the specified percent of pre-trigger data to be logged to the file. The trigger position is expressed as a percentage of the data log duration.

For example, if you specified a data log duration of 30 minutes and a trigger position of 50%, the Data Logger will log 15 minutes of pre-trigger data to the file before the trigger occurs. Subsequently, 15 minutes of post-trigger data will then be logged to the data file.

From the remote interface:

To select the immediate trigger source (triggers the Data Logger immediately when initiated):

```
TRIG:DLOG:SOUR IMM
```

To select the rear panel trigger input BNC connector:

```
TRIG:DLOG:SOUR EXT
```

To select a BUS trigger source:

```
TRIG:DLOG:SOUR BUS
```

To select a voltage level of *another* output as the trigger (output 3 will generate the voltage level trigger):

```
TRIG:DLOG:SOUR VOLT3
```

To select a current level of *another* output as the trigger (output 4 will generate the current level trigger):

```
TRIG:DLOG:SOUR CURR4
```

To select the Arb Run/Stop key as the trigger source:

```
TRIG:DLOG:SOUR ARSK
```

To select the Output On/Off key as the trigger source for output 1:

```
TRIG:DLOG:SOUR OOOK
```

To select a voltage trigger level and slope on output 3 for the datalog:

```
TRIG:DLOG:VOLT 10, (@3)  
TRIG:DLOG:VOLT:SLOP POS, (@3)
```

To select a current trigger level and slope on output 4 for the datalog:

```
TRIG:DLOG:CURR 1, (@4)  
TRIG:DLOG:CURR:SLOP POS, (@4)
```

To specify a trigger offset at 25 percent of the duration of the datalog:

```
SENS:DLOG:OFFS 25
```

To trigger the Data Logger measurement:

```
TRIG:DLOG (@1)
```

(If the trigger source is BUS, you can also program *TRG or <GET>.)

Data Logger Filename

From the front panel:

Select the **Filename** button to specify a filename in which to save the data. Data will be logged to this filename the next time the Data Logger runs. If you do not specify a filename, the data will be logged to *default.dlog*, which is overwritten each time the Data Logger runs.

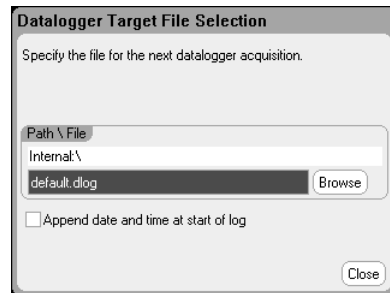

Enter the filename in the Path\File field. Check **Append date and time at start of log** to include time-stamp information in the file.

From the remote interface:

To specify the filename in which to save the data:

```
INIT:DLOG "datalog1.dlog"
```

To export a data log from the front panel display after it has been run to a file:

```
MMEM:EXP:DLOG "datalog1.dlog"
```

Data Logger Marker

From the front panel:

Select the **Markers** button to configure the measurements that appear on the bottom of the display in Marker view. Measurements apply to the portion of the trace between the two markers. You can only select a maximum of five measurements to be displayed.

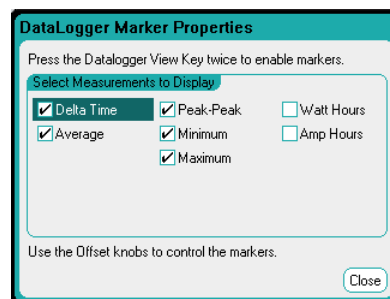

From the remote interface:

The following commands position the markers. To position the two data log markers at 100 seconds and at 200 seconds from the start trigger on the data log:

```
SENS:DLOG:MARK1 100  
SENS:DLOG:MARK2 200
```

The following commands return data between the two markers. To return the average current or voltage between the markers:

```
FETC:DLOG:CURR? (@1)  
FETC:DLOG:VOLT? (@1)
```

To return the minimum current or voltage between the markers:

```
FETC:DLOG:CURR:MIN? (@1)  
FETC:DLOG:VOLT:MIN? (@1)
```

To return the maximum current or voltage between the markers:

```
FETC:DLOG:CURR:MAX? (@1)  
FETC:DLOG:VOLT:MAX? (@1)
```

To return the peak-to-peak current or voltage between the markers:

```
FETC:DLOG:CURR:PTP? (@1)  
FETC:DLOG:VOLT:PTP? (@1)
```

Data Logger Preset

Select the **Preset** button to return the Data Logger View to the power-on display settings. In the power-on settings, the vertical offset of each trace is set to a different value. This is to prevent the traces from overlapping. The offset is referenced to the horizontal center line of the grid.

Data Logger Sampling Modes

The DC Power Analyzer provides two modes of data logging: Continuously-sampled mode (the default), and Standard (or interleaved) mode. The mode is automatically selected based on the installed power module types and the selected measurements, and **applies to all outputs**. A text message in the Display Trace area of the Data Logger Properties window indicates which mode is in effect.

Continuously-sampled mode

Continuously-sampled continuously samples the voltage or current data at about 50 kHz. Both voltage **and** current can be continuously sampled on Agilent Models N676xA and N678xA SMU. Power is calculated from the instantaneous voltage and current values. Only voltage **or** current can be continuously sampled on all other power modules. An average value (and optionally, a minimum and maximum value) is returned for each sample period. Continuous data sampling is used for the following Power Module/Display Trace selections:

Power Module	Display Trace selection
N676xA, N678xA SMU	Voltage, Current, & Power (24 parameters maximum)
N673xB, N674xB	Voltage or Current (12 parameters maximum)
N675xA, N677xA	Voltage or Current (12 parameters maximum)
N6783A	Voltage or Current (12 parameters maximum)

Available capabilities for ALL outputs

- Sample period: 20.48 microseconds to 60 seconds
- Trigger source: all trigger sources available
- Trigger offset: 0 to 100%
- Values logged: average, minimum, maximum
(minimum/maximum values must be selected)

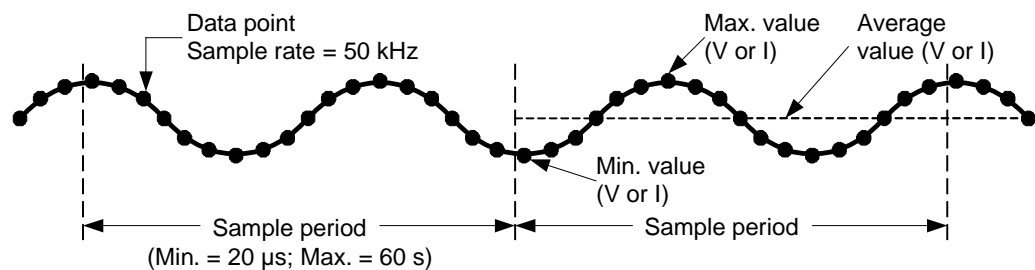

The fastest sample period that can be programmed for continuously-sampled measurements is 20.48 microseconds. However, this speed is only possible if *one* parameter is being measured. Note that you can measure up to 24 parameters (average voltage+min+max X 4 outputs, and average current+min+max X 4 outputs) with a corresponding decrease in measurement sample rate. The following typical sample periods are based on the number of parameters selected:

1 parameter (voltage or current)	20 microseconds (rounded)
3 parameters (voltage+min+max)	60 microseconds (rounded)
6 parameters (voltage+min+max X 2 outputs)	120 microseconds (rounded)
12 parameters (voltage+min+max X 4 outputs)	240 microseconds (rounded)
24 parameters (voltage+min+max X 4 outputs & current+min+max X 4 outputs)	480 microseconds (rounded)

NOTE

When the Power trace is selected, it counts as 2 parameters, since voltage and current must be measured to calculate power. If voltage and current traces have already been selected, the Power trace is not counted as a parameter.

Standard mode (interleaved)

Standard (interleaved) mode only applies when **both** voltage and current measurement traces are selected on power modules other than Agilent Models N676xA and N678xA SMU. These other power modules cannot measure voltage and current simultaneously; hence, the voltage and current measurements must be interleaved. Each measurement is sampled for about 5 milliseconds at the beginning of every sample period. Power is calculated from the interleaved measurements. Standard data sampling is used for the following Power Module/Display Trace selections:

Power Module	Display Trace selection
N673xB, N674xB	Voltage, Current, and Power
N675xA, N677xA	Voltage, Current, and Power

Available capabilities for ALL outputs

- Sample period: 75 milliseconds to 60 seconds
- Trigger source: Run/Stop key only
- Trigger offset: 0 (offset not available)
- Values logged: average only

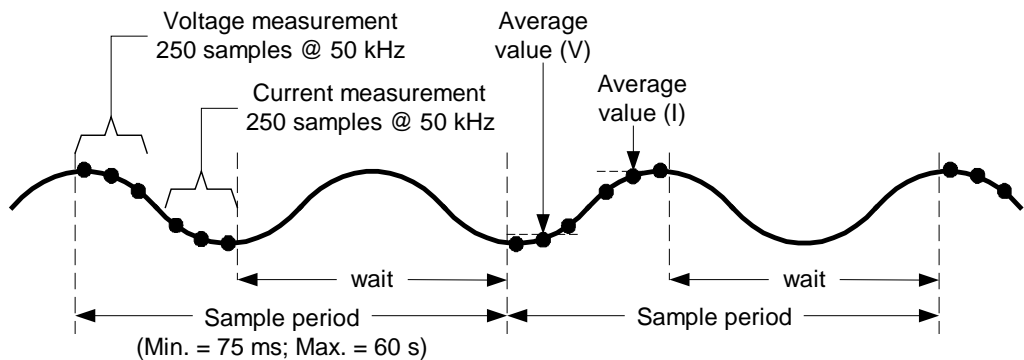

Scope and Data Logger Display Differences

The Scope View and Data Logger displays are similar in many respects, such as the way traces are displayed, how traces are selected, and the marker controls - to name a few. This similarity makes it easier to program each function.

However, there are important differences in the Scope and Data Logger displays that may not be obvious at first glance. To help eliminate confusion when using both Scope and Data Logger, the following table lists the major differences in the display functions.

Function	Scope View	Data Logger
Graph	Waveform capture	Strip chart
Trace selection	Voltage, current, and power traces - for N676xA and N678xA SMU power modules Voltage or current trace - for all other power modules	<i>Continuous mode:</i> Voltage, current, and power traces - for N676xA and N678xA SMU power modules Voltage or current trace - for all other power modules <i>Interleaved mode:</i> Voltage and current, or power
Trigger level selection	Note that current levels cannot be selected as triggers on outputs that have been grouped.	<i>Continuous mode:</i> Voltage or current level of checked trace - for all power modules <i>Interleaved mode:</i> Run Stop key only - for all power modules Note that current levels cannot be selected as triggers on outputs that have been grouped.
Trigger mode	Auto, single, or triggered	Does not apply
Trigger position	Turn the horizontal offset knob	Press Properties, select Trigger. Trigger position is specified as a % of the data log duration.
Horizontal trigger offset reference	Left, center, or right	Does not apply to strip chart
Trace save	Press File, select Save	Automatically saved to default.dlog file (A different file name can be specified prior to running the datalog.)

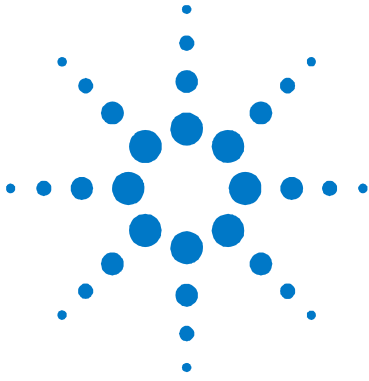

5 Using the System Functions

Using the File Functions	138
Configuring User Preferences	145
Using the Administrative Tools	147

This chapter contains information about the following system utilities:

- File functions
- Configuring user preferences.
- Using administrative functions, including security features that let you lock out the front panel and remote interfaces. Information on clearing the instrument's memory is also provided.

NOTE

You cannot program the system utilities from the remote interface.



Using the File Functions

Press the **File** key, then scroll to and select from the following:

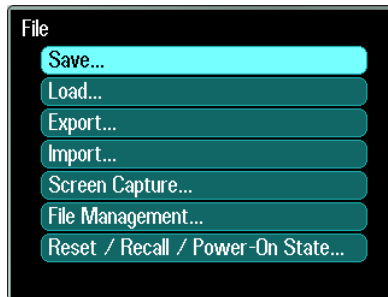

Save Function

To save the instrument state, scope data, or an Arb sequence, press the **File** key, then scroll to and select **Save**.



Parameter:	Description:
Type	Specifies the data type: instrument state or scope data or Arb sequence.
Path \ File Name	Specifies a file name in which to save the data. Internal:\ specifies the instrument's internal memory. External:\ specifies the Memory port on the front panel. Enter a name in the text field. See "Enter the File Name"
Browse	Lets you browse another directory or USB memory device.
Save	Saves the data to the file name in binary format.

Enter the File Name

Use the navigation keys to scroll to and select the **File Name** field. Use the alpha/numeric keys to enter a file name.

Alpha keys automatically become active on data entry fields that allow alpha as well as numeric characters. Repeatedly pressing a key cycles through the choices. This is similar to the way cell phones work. For example, repeatedly pressing **2 ABC** cycles as follows:
a, b, c, A, B, C, 2

After a brief pause, the cursor will accept the displayed character and move one position to the right. Use **Backspace** to back up and delete an entry. Use **▶** to enter a space. Press **Enter** when finished.

Load Function

To load an instrument state, scope data, logged data, or an Arb sequence, press the **File** key, then scroll to and select **Load**. You can only load binary files. You cannot load data files in .csv format.

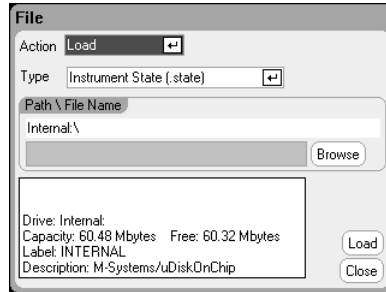

Parameter:	Description:
Type	Data type: instrument state, scope data, or logged data, or Arb sequence.
Path \ File Name	Displays the file where the data is located. Internal:\ specifies the instrument's internal memory. External:\ specifies the Memory port on the front panel.
Browse	Lets you browse another directory or USB memory device.
Load	Loads the data from the binary file into the instrument.

Export Function

To export (and convert) scope data, logged data, or Arb data (user-defined or CD), press the **File** key, then scroll to and select **Export**.



Parameter:	Description:
Type	Data type: scope data, logged data, or Arb (User or CD). All data is exported in .csv format (comma separated values).
Path \ File Name	Specifies a file name in which to export the data. Internal:\ specifies the instrument's internal memory. External:\ specifies the Memory port on the front panel. Enter a name in the text field. See "Enter the File Name"
Browse	Lets you browse another directory or USB memory device.
Export	Exports the data to the file name in .csv format.

Import Function

To import (and convert) Arb data (user-defined or CD), press the **File** key, then scroll to and select **Import**.

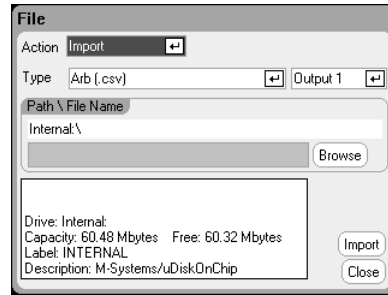

Parameter:	Description:
Type	Data type: Arb data (user-defined or CD). Data is converted from .csv format to an internal file format.
Output <1-4>	Specifies the output that will receive the Arb data.
Path \ File Name	Displays the file where the data is located.
Name	Internal:\ specifies the instrument's internal memory. External:\ specifies the Memory port on the front panel.
Browse	Lets you browse another directory or USB memory device.
Import	Imports the .csv data from the file into the instrument.

Screen Capture

To capture a screen, press the **File** key, then scroll and select **Screen Capture**. This saves the screen that was active when you pressed **File**.

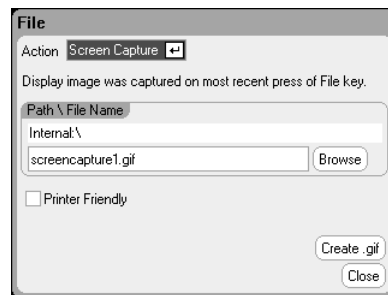

A copy of the current screen is saved whenever the **File key is pressed.**

Parameter:	Description:
Path \ File Name	Specifies a file name in which to save the image. Screens are saved in .gif format (graphics interchange format). Internal:\ specifies the instrument's internal memory. External:\ specifies the Memory port on the front panel. Enter a name in the text field. See "Enter the File Name"
Browse	Lets you browse another directory or USB memory device.
Print Friendly	Check this box to save Scope View and Data Logger screens with a white instead of a dark background.
Create .gif	Saves the image to the specified .gif file.

Show Details

To view the details of a specific file, press the **File** key, then scroll to and select **File Management**.

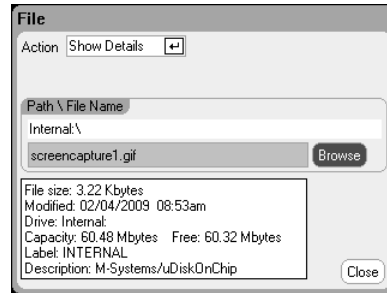

Parameter:	Description:
Path \ File Name	Specifies the file.
Name	Internal:\ specifies the instrument's internal memory. External:\ specifies the Memory port on the front panel.
Browse	Lets you browse another directory or USB memory device.
Details	File details are displayed in the text box.

Delete Function

To delete a file, press the **File** key, then scroll to and select **File Management**. In the Action dropdown box, select **Delete**.



Parameter:	Description:
Path \ File Name	Specifies the file or directory to be deleted.
Name	Internal:\ specifies the instrument's internal memory. External:\ specifies the Memory port on the front panel.
Browse	Lets you browse another directory or USB memory device.
Delete	Deletes the selected file.

Rename Function

To rename a file, press the **File** key, then scroll to and select **File Management**. In the Action dropdown box, select **Rename**.

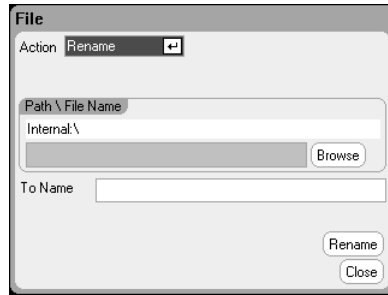

Parameter:	Description:
Path \ File Name	Specifies the file or directory to be renamed. Internal:\ specifies the instrument's internal memory. External:\ specifies the Memory port on the front panel.
Browse	Lets you browse another directory or USB memory device.
To Name	Enter the name that you wish to rename the file to in this text field. See "Enter the File Name".
Rename	Renames the selected file.

Copy Function

To copy the selected file to another directory or an external USB memory device, press the **File** key, then scroll to and select **File Management**. In the Action dropdown box, select **Copy**.

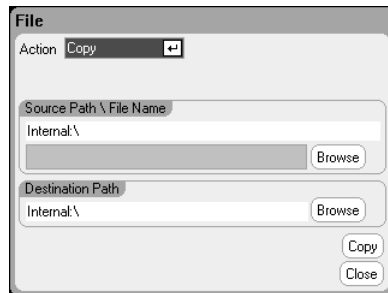

Parameter:	Description:
Source Path \ File Name	Specifies the file to be copied. Internal:\ specifies the instrument's internal memory. External:\ specifies the memory port on the front panel.
Destination Path	Specifies a destination directory. Internal:\ specifies the instrument's internal memory. External:\ specifies the Memory port on the front panel.
Browse	Lets you browse another directory or USB memory device.
Copy	Copies the selected file to the specified destination.

New Folder

To create a new folder at the present directory level, press the **File** key, then scroll to and select **File Management**. In the Action dropdown box, select **New Folder**.

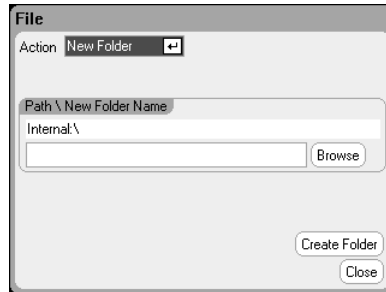

Parameter:	Description:
Path \ New Folder Name	Specifies a name for the folder. Internal:\ specifies the instrument's internal memory. External:\ specifies the Memory port on the front panel. Enter the name in the text field. See "Enter the File Name"
Browse	Lets you browse another directory or USB memory device.
Create Folder	Creates the new folder in the specified location.

Reset/Recall/Power-On State

As shipped, the DC Power Analyzer is configured to automatically recall the Reset State (*RST) settings at power-on. However, you can configure the reset, recall, and power-on state of the instrument. Press the **File** key, then scroll and select **Reset/Recall/Power-On State**.

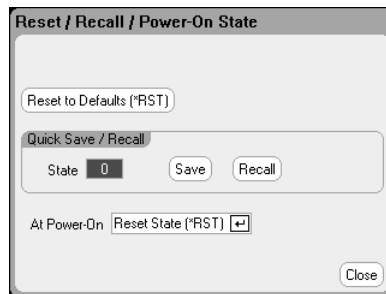

Selecting **Reset to Defaults** lets you immediately return the instrument to its factory default settings as described in chapter 1.

Quick Save/Recall lets you save and subsequently recall an instrument state in memory locations 0 through 9. This is the same as saving an instrument state to a file name, but quicker. These functions can also be accessed using the SCPI *SAV and *RCL commands.

At Power-On lets you recall the Reset State (*RST), or recall the instrument state stored in location 0.

Using an External USB Memory Device

You can use an external USB memory device (commonly referred to as a flash drive) to transfer files to and from the DC Power Analyzer. Connect the memory device to the front panel Memory port, which is specifically designed for this purpose. The rear panel USB connector should only be used for connecting to a PC.

When using an external USB memory device, be aware of the following cautions:

- While the DC Power Analyzer supports the majority of USB memory devices, there may be differences in manufacturing standards of some devices that will prevent them from working in the DC Power Analyzer.
- It is recommended that you test your USB device by importing and exporting a file before you actually use it to save data directly from the test you will be running. If the USB memory device does not work in the DC Power Analyzer, try a device from a different manufacturer.

Exporting Data to a Spreadsheet

You can export scope data and logged data to a spreadsheet such as Microsoft Excel on your PC as follows:

1. Collect the scope or logged data using the DC Power Analyzer.
2. Insert a USB memory device into the Memory port on the front of the DC Power Analyzer.
3. Export the scope data or logged data to the memory device using the Export file function as previously discussed. Note that the export file format is .csv (comma separated values).
4. Inset the memory device into the USB port on your computer.
5. Run Microsoft Excel and select File, then Open. Navigate to the USB memory device. Under Files of type:, select Text Files (*.csv). Open the scope data or data log file.

Logging Data Directly to the Memory Device

You can save logged data directly to the USB memory device rather than to the instrument's internal memory as follows:

1. Insert a USB memory device into the Memory port on the front of the DC Power Analyzer.
2. In the Datalogger Target File Selection window (located under Datalogger Properties/File Name), use the Browse button and select External:\. Enter a filename in the text field. The data will now be placed on the USB memory device.

NOTE

Data is saved in binary format. To export in .csv format you must Load the data from the USB memory device back into the instrument and Export the data in .csv format as described under "Exporting Data to a Spreadsheet".

Configuring User Preferences

To configure the User Preferences, press the **Menu** key, scroll down and select the **Utilities** item, then select **User Preferences**. Then scroll to and select one of the following User Preferences:

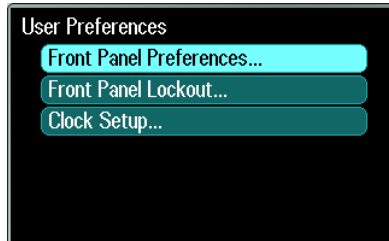

Front Panel Preferences

The DC Power Analyzer has a front panel screen saver that increases the life of the LCD display by turning it off during periods of inactivity. As shipped from the factory, the screen saver comes on one hour after activity on the front panel or interface has ceased.

When the screen saver is active, the front panel display turns off, and the LED next to the Line switch changes from green to amber. To restore the front panel display, simply press one of the front panel keys.

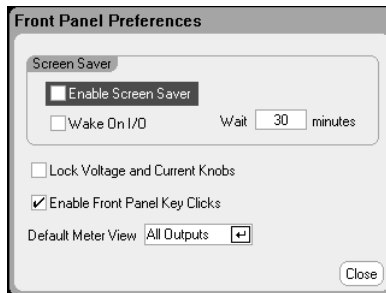

Check **Enable Screen Saver** to enable the screen saver. Uncheck to disable the screen saver. When enabled, enter a value in minutes in the **Wait** field to specify the time when the screen saver will activate. The wait can be set from 30 to 999 minutes in 1 minute increments.

Check **Wake on I/O** to activate the display with I/O bus activity. If Wake on I/O is enabled, the display is restored whenever there is activity on the remote interface. This also resets the Wait timer.

Check **Lock Voltage and Current Knobs** to disable the front panel voltage and current knobs. This is useful if you wish to prevent someone from changing the voltage or current settings if a test is in progress. Uncheck to enable the voltage and current knobs.

Check **Enable Front Panel Key Clicks** to enable key clicks. Uncheck to disable key clicks.

Under **Default Meter View**, you can specify if the instrument turns on with single-output view or all-outputs view.

Front Panel Lockout

You can password-protect the front panel keys to prevent unwanted control of the instrument from the front panel. The lock setting and password is saved in non-volatile memory so that the front panel remains locked even when AC power is cycled. To access the front panel lockout function press the **Menu** key, scroll down and select **Utilities**, then **User Preferences**, then **Front Panel Lockout**.

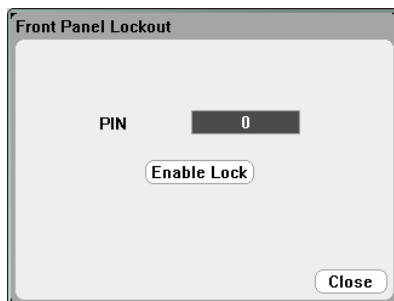

In the **PIN** text box, enter the numeric password that you wish to use to *unlock* the front panel. Then click **Enable Lock** to lock the front panel keys. A dialog prompting the user to unlock the front panel appears every time a key is pressed. Enter the password to unlock the front panel.

NOTE

If the password is lost, the `SYSTEM:PASSWORD:FPANEL:RESET` command can reset the front panel lockout password. Refer to the Programmer's Reference Help file on your Agilent N6705 Product Reference CD for more information.

Clock Setup

When shipped from the factory, the DC Power Analyzer's clock is set to Greenwich mean time. To access the clock function press the **Menu** key, scroll down and select **Utilities**, then **User Preferences**, then **Clock Setup**.

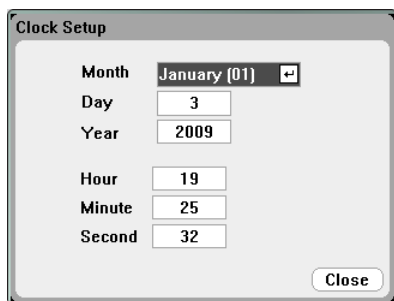

Select a **Month** from the dropdown list. Enter the **Day**. Then enter the **Year**.

Enter the **Hour**, **Minute**, and **Second**. The time becomes active when the values are entered.

Using the Administrative Tools

To enter the Administrative Utilities menu, press the **Menu** key, scroll down and select **Utilities**, then select **Administrative Tools**. Access to the Administrative Tools menu is password protected. Select **Administrator Logout/Login** to enter the password.



Administrator Login/Logout

If a password is required, enter it in to the PIN field, select the **Login** button and press [Enter].

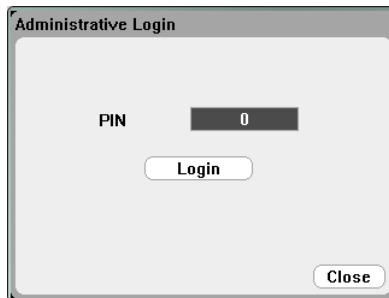

As shipped from the factory, the password is 0 (zero). If the PIN field shows 0; simply select the **Login** button and press [Enter].

Instrument Calibration

The calibration functions are located in the Administration Tools menu and are password-protected from unauthorized use.

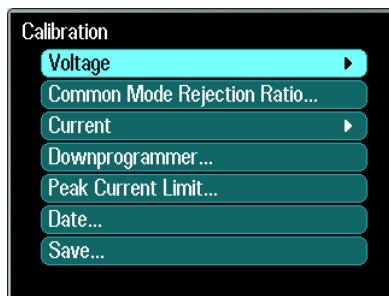

For complete information about calibrating the instrument, refer to the calibration section in the N6705 Service Guide. The Service Guide is included with the optional Manual Set (Option 0L1). An electronic copy is included on the N6705 Product Reference CD.

Securing the USB, LAN, and Web Server

The USB interface, LAN interface, and the Web server are enabled when shipped. Log into the **Administrative Tools** menu to secure or allow access to the LAN, USB, or Web server.

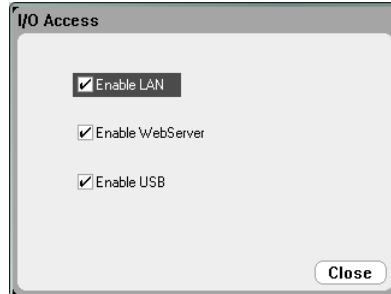

Check the **Enable LAN** box to enable the LAN. Uncheck this box to disable the LAN.

Check the **Enable WebServer** box to enable the Web server. Uncheck this box to disable the Web server. If the **Enable LAN** box is not checked, the Web server will not be available.

Check the **Enable USB** box to enable the USB. Uncheck this box to disable the USB.

Restoring the Non-volatile Factory Settings

To erase all files on the internal drive and restore the factory-shipped settings and the non-volatile settings, log into the **Administrative Tools** menu. Select **Nonvolatile RAM Reset** and press the **Reset** button.

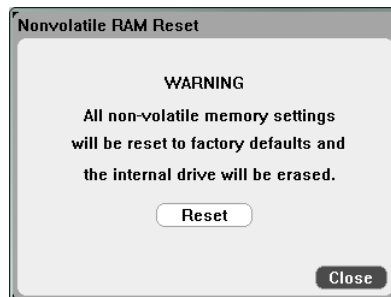

Refer to Appendix B for the non-volatile factory settings.

Disk Management

The Disk Management function checks the internal drive for file system consistency and file integrity. Any file errors or discrepancies are automatically fixed.

To access the disk management utilities, log into the **Administrative Tools** menu, then select **Disk Management**. Press the **Check Internal Drive** button to check the internal drive.

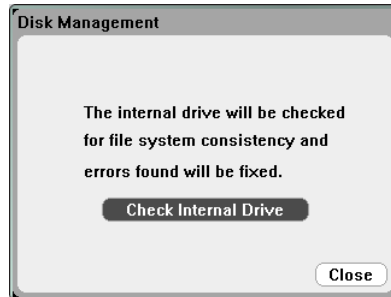

Updating the Firmware

The easiest way to update the firmware on your DC Power Analyzer is to go to the web at <http://www.agilent.com/find/N6705firmware> and download the firmware to a USB memory device connected to your computer.

After the file has been downloaded to the USB memory device, remove the device and insert it into USB port on the front of the DC Power Analyzer.

Log into the **Administrative Tools** menu, then select **Firmware Update**.

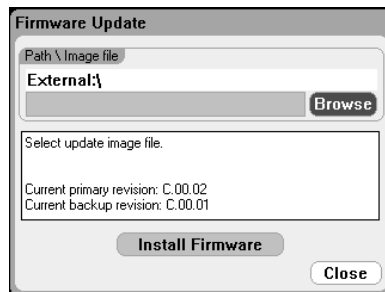

Click the **Browse** button and navigate to the firmware file on the External USB memory Device. Press the **Install Firmware** button to update the firmware.

A message will then appear instructing you to reboot the instrument and activate the firmware. Press Reboot or cycle AC power.

Installing Options

The Install Options function lets you install firmware options into the DC Power Analyzer.

Option:	Description:
001	Data Logger Software This option is only available on instruments that have been purchased with Option 055 – Delete Data Logger.
056	Agilent 14585A Control and Analysis Software

To access the disk management utilities, log into the **Administrative Tools** menu, then select **Install Options**. From the dropdown menu, select the option you wish to install and enter the Access Key number from your software license documentation.

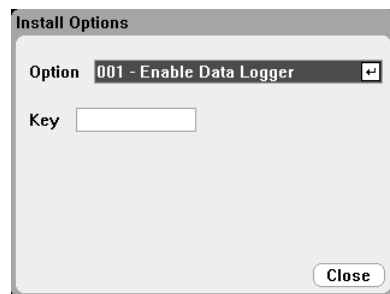

Obtaining the License

To obtain the license, you must first purchase the option. After you have purchased the option, you will receive a Software Entitlement Certificate. When this is received, you can obtain the license.

To get the license key, log onto the website <https://software.business.agilent.com/asm> and follow the on-screen directions. These include:

1. Creating a user account (if not already set up).
2. Entering your Order and Certificate number (these appear in your Software Entitlement Certificate).
3. Entering the Host instrument's 10-character serial number (this is located on the rear panel of the instrument).
4. Selecting the software license for the instrument.

When you have completed the license request, a license key will be sent to your email. Enter the Access Key into the Key field of the Install Options window shown above.

Changing the Password

To password-protect or change the password for the Administrative Tools menu, log into the Administrative Tools menu as previously described and select **Change Password**. Select a password that is numeric and up to 15 digits long. Enter it into the PIN field and then select **Change Pin**. When done, select **Administrator Login/Logout** to log out of the Administrative Tools menu and activate the password. You can now only enter the Administrative Tools menu by providing the new password.

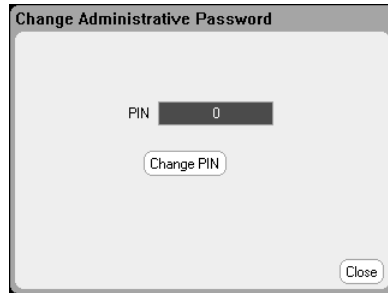

If the password is lost or forgotten, access to the Administrative Tools menu can be restored by setting an internal switch to reset the password to 0. If the message “Locked out by internal switch setting” or “Calibration is inhibited by switch setting” appears, the internal switch is set to prevent the password from being changed (Refer to the Service Guide).

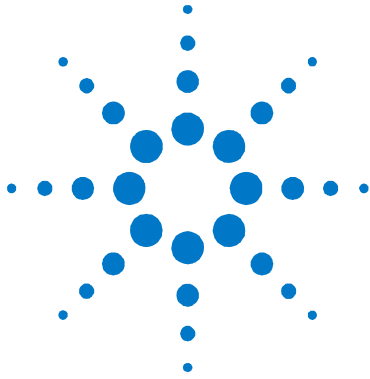

6 Advanced Source and Measurement Functions

Source Operating Modes	154
Advanced Measurements	162

This chapter discusses the difference between constant voltage and constant current operating modes, multiple output quadrant operation, and other advanced source functions. It also discusses advanced measurement functions such as digitizing measurements, external data logging, histogram measurements, and other advanced measurement functions.



Source Operating Modes

Single Quadrant Operation

The DC Power Analyzer can operate in either constant voltage (CV) or constant current (CC) over the rated output voltage and current. Constant voltage mode is defined as an operating mode in which the dc source maintains its output voltage at the programmed voltage setting in spite of changes in load, line, or temperature. Thus, when the load resistance changes, the output voltage remains constant while the output current changes to accommodate the change in load.

Constant current mode is defined as an operating mode in which the dc source maintains its output current at the programmed current limit in spite of changes in load, line, or temperature. Thus, when the load resistance changes, the output current remains constant while the output voltage changes to accommodate the change in load.

All DC power modules, except for Agilent Models N678xA SMU, are designed as *constant voltage* sources. This means that the specifications and operating characteristics are optimized for constant voltage mode operation. Note that these power modules cannot be programmed to operate in a specific mode. At turn-on, the operating mode will be determined by the voltage setting, current setting, **and** the load resistance. In the following figure, operating point 1 is defined by a fixed load line traversing the positive operating quadrant in the constant voltage region. Operating point 2 is defined by a fixed load line traversing the positive operating quadrant in the constant current region.

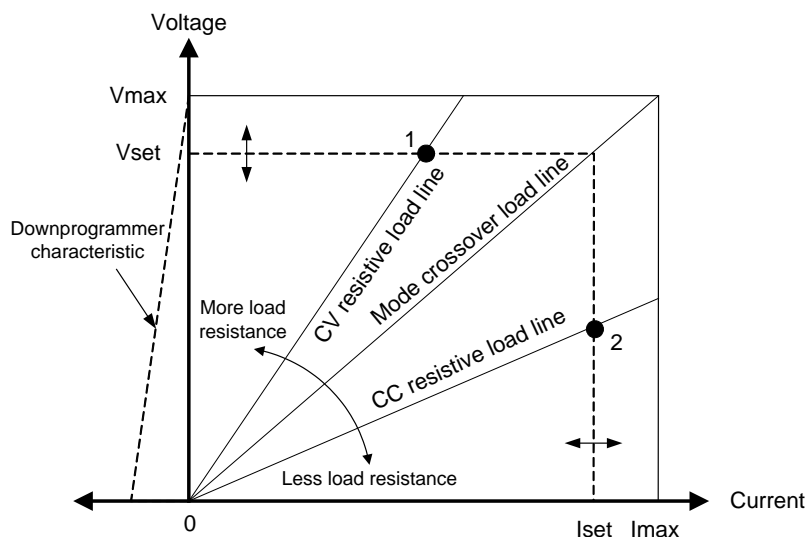

Autoranging

NOTE

Autoranging only applies to Agilent N675xA and N676xA power modules.

The following figure illustrates the autoranging output characteristic of the Agilent N675xA and N676xA power modules. Point 3 shows a situation in which the voltage and current settings are such that the operating locus is limited by the maximum output power boundary of the output. Depending on the power module, this may be greater than the output power rating of the module. In this situation, the output is not guaranteed to meet its operating specifications because it is operating in an area that is outside its specified power rating.

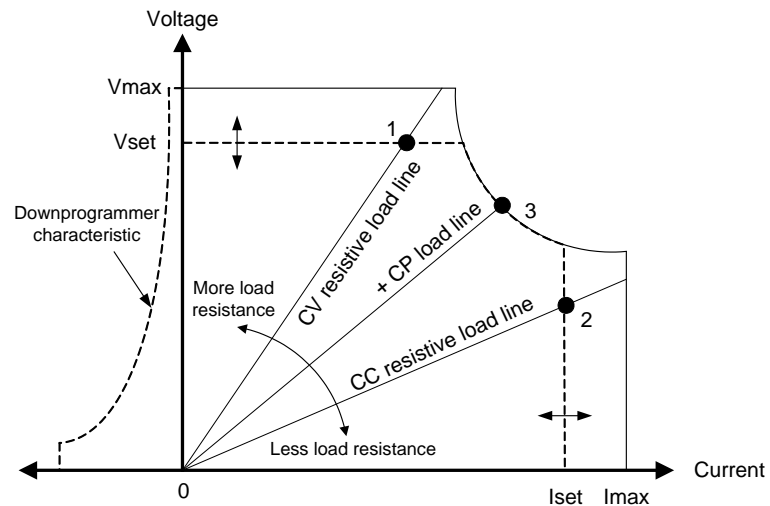

Downprogramming

As shown by the dashed line on the left in the figures, the DC Power Analyzer is capable of sinking current over the output voltage range from zero volts to the rated voltage. This negative current sinking capability provides fast downprogramming of the output. The negative current is not programmable.

CC Mode Delay

The power supply may momentarily cross into constant-current (CC) mode when it is turned on, when an output value is programmed, or when the output load is connected. In most cases these temporary conditions would not be considered an over-current protection fault, and having an OCP condition disable the output when the CC status bit is set would be a nuisance. Specifying an OCP delay will ignore the CC status bit during the specified delay period. For example, if the OCP delay is 100 ms, and the output goes into CC mode for 80 ms and then back to CV mode, the output will not shut down. If the CC mode persists for more than 100 ms, the output will shut down.

To program a delay time, press the **Settings** key to access the Source Settings. Navigate to and select **Protection**. Then press **Enter**.

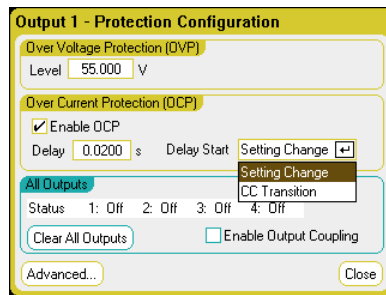

You can specify if the delay timer is started by *any* transition of the output into CC mode (select **CC Transition**), or if the delay timer is started at the end of a *settings* change in voltage, current, or output state (select **Settings Change**).

Factors that influence how long the settings change or output load change may last include: difference between old output value and new output value, the current limit setting, and the load capacitance in CV mode or load inductance in CC mode. The delay required must be determined empirically; the power module programming-response time characteristics may be used as guidelines.

Also, the time it takes the output to go into CC mode varies - depending on the magnitude of the over-current condition compared to the current limit setting. For example, if the over-current is only slightly greater than the current limit setting, it may take several tens of milliseconds, depending on the power module type, for the output to set the CC status bit. If the over-current is significantly greater than the current limit setting, it may only take a few milliseconds or less, depending on power module type, for the output to set the CC status bit. To determine when the output will shut down, you must add the time it takes to set the CC status bit to the over-current protection delay time. If the over-current persists beyond the sum of these two time intervals, the output will shut down.

Power Limit Operation

For Agilent N6705 mainframes, the instrument will operate normally as long as the combined output power is within the power rating of the mainframe. If the combined power drawn from all of the outputs exceeds the mainframe's power rating of 600 W, a power fault protection event will occur. This causes ALL outputs to turn off and remain off until a protection clear command is given. A status bit (PF) will indicate that a power fault protection event has occurred.

For Agilent N678xA SMU, the power limit function does not apply because their maximum output power is rated at 20W.

For Agilent N675xA, and N676xA power modules, the power limit function limits the output power at its programmed setting. A status bit (CP+) will indicate that the output is in power limit mode. When the power drawn by the load is reduced below the power limit setting, the output returns to normal operation. Note that these power modules contain an active down-programmer circuit, which is limited to about 7 W continuous power. A status bit (CP-) will indicate that the output has reached the negative limit.

For Agilent N673xB, N674xB, and N677xA power modules, the power limit function turns the output off after a power limit persists for about 1 millisecond. A status bit (CP+) will indicate that the output has been turned off by a power limit condition. To restore the output, you must first adjust the load so that it draws less power. Then clear the protection function as previously explained. For these power modules, it may be preferable to use the current or voltage setting to limit the output power so as to avoid turning the output off.

NOTE

If the power limit is left at the maximum rating, these power modules will *not* enable the power limit protection. The power limit protection will only activate when the power limit is set to a value *less* than the maximum rating of the power module and the output power subsequently exceeds this limit setting.

To specify a power limit, press the **Settings** key to access the Source Settings window. Navigate to and select the **Advanced** button.

Output Grouping**NOTE**

Output grouping does not apply to Agilent Models N678xA SMU.

Up to four identical outputs can be configured or “grouped” to create a single output with higher current and power capability. The following conditions apply for grouped outputs:

- Only *identical* outputs can be grouped. Outputs without identical model numbers and options will be unavailable for grouping.
- Grouped outputs *must* be connected in parallel (see chapter 2).
- On Agilent N676xA power modules, low current *measurement* ranges are unavailable. Low current output ranges, are available.
- Current-level triggering is unavailable for grouped outputs.
- Over-current protection delay has a slightly slower response time (~10 ms) and slightly less resolution than an ungrouped output.
- The power limit setting for Agilent N673xB, N674xB, N677xA, and N6783A power modules must be set to its maximum value.

From the front panel:

To group outputs, press the **Menu** key. Select **Source Settings**, then **Output Grouping**. Check the outputs that you wish to group.

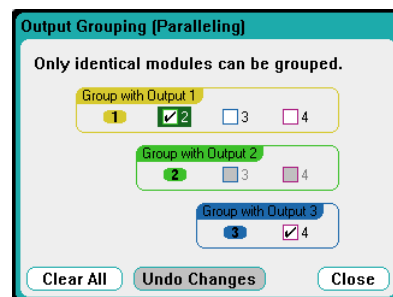

Grouped outputs are controlled using the output number of the **lowest** output in the group. As shown in the following figure, output 1 is grouped with output 2 and output 3 is grouped with output 4.

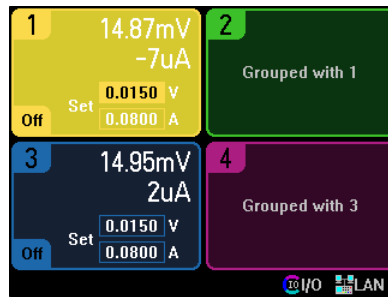

To return grouped outputs back to an ungrouped state, turn the output off and remove the parallel connections between the outputs. Then uncheck the check boxes. Then cycle AC power to the unit for the grouping or ungrouping changes to take effect. Grouped settings are saved in non-volatile memory.

From the remote interface:

Send the following command to group channels 2 through 4. To address this group, use channel 2.

```
SYST:GRO:DEF(@2,3,4)
```

To ungroup all channels:

```
SYST:GRO:DEL:ALL
```

To reboot the instrument for the grouping changes to take effect either cycle AC power, or sent the following command:

```
SYST:REB
```

Agilent N678xA SMU Multi-Quadrant Operation

Agilent Models N678xA SMU can be operated in either voltage or current priority mode. They can source as well as sink output power. Note that Agilent Models N6781A and N6782A operate only in the + Voltage quadrants.

Voltage Priority Mode

In voltage priority mode, the output voltage should be programmed to the desired positive or negative value. A positive current limit value should also be set. The current limit should always be set higher than the actual output current requirement of the external load. With tracking enabled, the negative current limit tracks the positive current limit setting. With tracking disabled, you can set different values for the positive and negative current limits.

The following figure shows the voltage priority operating locus of the power modules. The area in the white quadrants shows the output as a source (sourcing power). The area in the shaded quadrants shows the output as a load (sinking power).

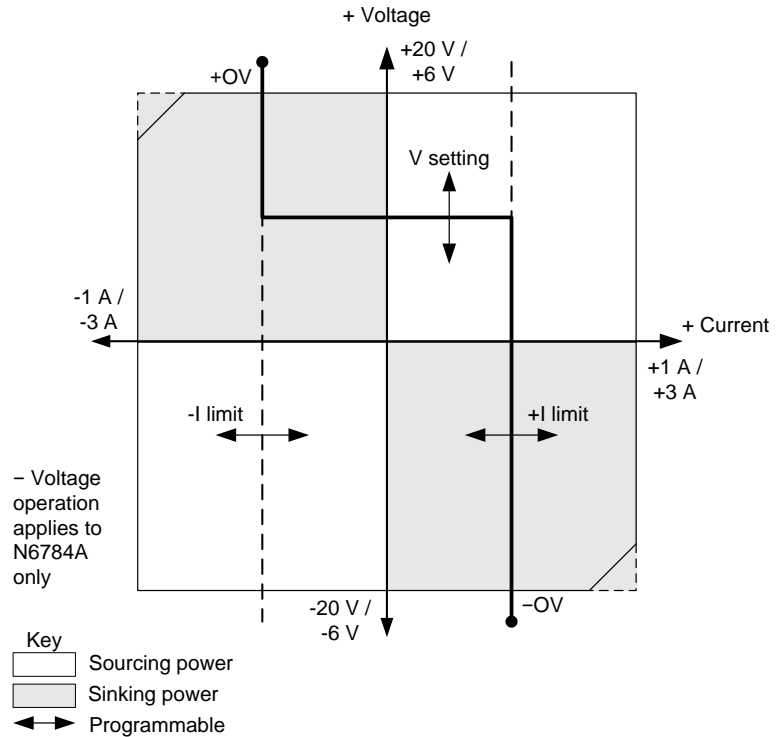

The heavy solid line illustrates the locus of possible operating points as a function of the output load. As shown by the horizontal portion of the line, the output voltage remains regulated at its programmed setting as long as the load current remains within the positive or negative current limit setting. A CV (constant voltage) status flag indicates that the output current is within the limit settings.

When the output current reaches either the positive or negative current limit, the unit no longer operates in constant voltage mode and the output voltage is no longer held constant. Instead, the power supply will now regulate the output current at its current limit setting. Either a CL+ (positive current limit), or CL- (negative current limit) status flag is set to indicate that a current limit has been reached.

As shown by the vertical portions of the load line, when the unit is sinking power, the output voltage may continue to increase in the positive or negative direction as more current is forced into the unit. When the output voltage exceeds either the positive or negative over-voltage setting, the output will shut down, the output relays will open, and either the OV or OV- and the PROT status bits will be set. Either the user-defined over-voltage setting or the local over-voltage function can trip the over-voltage protection.

Current Priority Mode

In current priority mode, the output current should be programmed to the desired positive or negative value. A positive voltage limit value should also be set. The voltage limit should always be set higher than the actual output voltage requirement of the external load. With

tracking enabled, the negative voltage limit tracks the positive voltage limit setting. With tracking disabled, you can set different values for the positive and negative voltage limits.

The following figure shows the current priority operating locus of the power modules. The area in the white quadrants shows the output as a source (sourcing power). The area in the shaded quadrants shows the output as a load (sinking power).

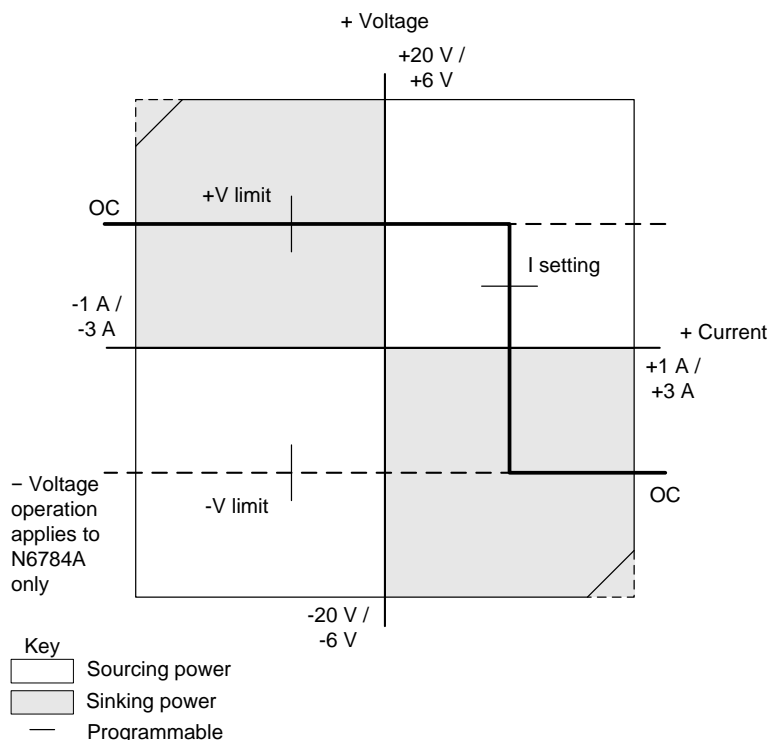

The heavy solid line illustrates the locus of possible operating points as a function of the output load. As shown by the vertical portion of the line, the output current remains regulated at its programmed setting as long as the output voltage remains within the positive or negative voltage limit setting. A CC (constant current) status flag indicates when the output voltage is within the limit settings.

If the output voltage reaches either the positive or negative voltage limit, the unit no longer operates in constant current mode and the output current is no longer held constant. Instead, the power supply will now regulate the output voltage at its voltage limit setting. Either a VL+ (positive voltage limit) or VL- (negative voltage limit) status flag is set to indicate that either the positive or negative voltage limit has been reached.

As shown by the horizontal portions of the load line, when the unit is sinking power, the output current may continue to increase in the positive or negative direction as more current is forced into the unit. Once the current exceeds 12% of the rated current of the range (1.12 A on the 1 A range; 3.36 A on the 3 A range), the output will shut down, the output relays will open, and the OC and PROT status bits will be set.

Output Bandwidth

Agilent Models N678xA SMU have several voltage bandwidth modes that let you optimize output response time with capacitive loads.

The Low bandwidth setting provides stability with a wide range of load capacitors. Additional bandwidth modes provide faster output response when the load capacitance is restricted to smaller ranges.

If capacitive loads cause the output to oscillate on the default (Low bandwidth) or any of the other bandwidth settings, a protection function will detect the oscillation and latch the output off. The condition is annunciated by the OSC status bit. At power-on the oscillation protection function is enabled.

From the front panel:

Press the **Settings** key to access the Source Settings window. Navigate to and select Advanced.

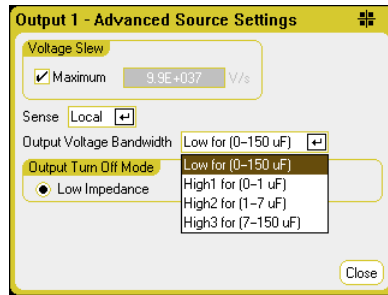

Select a bandwidth according to the following load capacitances and load lead lengths:

Setting	Load Capacitance	Sensing	Maximum distance from sense point to load capacitor	ESR @100 kHz
Low	0–150 μF	Local or remote	Full lead length (see chapter 2)	50 to 200 m Ω
High1	0–1 μF	Remote only	6 inches (15 cm)	50 to 200 m Ω
High2	1–7 μF	Remote only	6 inches (15 cm)	50 to 200 m Ω
High3	7–150 μF	Remote only	6 inches (15 cm)	50 to 200 m Ω

See Chapter 2 under “Agilent N678xA SMU Wiring Requirements” for additional information on allowable load lead lengths.

NOTE

Connecting capacitive loads that fall outside the indicated ranges may result in output instability or oscillation, and cause the output to turn off, setting the OSC status bit.

From the remote interface:

The compensation function is set using the following SCPI command::

```
[SOURce:]VOLTage:BWIDth LOW | HIGH1 | HIGH2 | HIGH3, (@1)
```

When queried, the returned value is the bandwidth that was selected.

Advanced Measurements

Digitizing Measurements

The digitizing measurements discussed in this section allow you to perform most but not all of the scope measurement function available on the front panel. One example of functionality not available over the remote interface is the ability to program markers and make calculated measurements between markers.

With the digitizing measurement functions you can:

- Specify a measurement function and range.
- Adjust the measurement sample rate.
- Adjust the measurement to capture pre-trigger data.
- Select a measurement window that can attenuate AC noise.
- Select the measurement trigger source.
- Initiate the trigger system and generate a trigger.
- Retrieve the digitized measurements.

NOTE

When a measurement is in progress over the remote interface, the front panel display may indicate “- - - - -”. Front panel measurements resume when the remote measurement completes.

Select the Measurement Function and Range

The following commands select a measurement function. To enable voltage measurements on channels 1 through 4:

```
SENS:FUNC:VOLT ON, (@1:4)
```

To enable current measurements on channels 1 through 4:

```
SENS:FUNC:CURR ON, (@1:4)
```

If a model has simultaneous measurements (see chapter 1, “Power Module Features”), then BOTH voltage and current measurements can be enabled.

Some models also have multiple measurement ranges. Selecting a lower measurement range provides greater measurement accuracy, provided that the measurement does not exceed the range. To select the low voltage range on channel 1:

```
SENS:VOLT:RANG 5, (@1)
```

To select the 1 A current range on channel 1:

```
SENS:CURR:RANG 1, (@1)
```

Seamless Measurements

Seamless voltage and current measurement autoranging is available on Agilent Models N6781A and N6782A. This enables a wide dynamic measurement range with no data lost across ranges. Autoranging does not include the 10 μ A range, which must be selected manually.

To enable seamless voltage or current autoranging on channel 1:

```
SENS:VOLR:RANG:AUTO ON, (@1)
SENS:CURR:RANG:AUTO ON, (@1)
```

Adjust the Measurement Sample Rate

The following figure illustrates the relationship between measurement samples (or points), and the time interval between samples in a typical measurement.

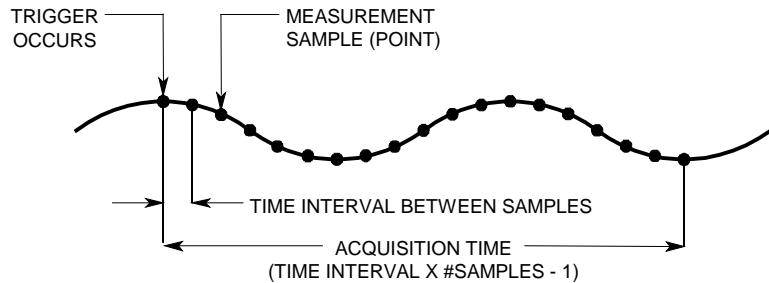

You can vary the measurement data sampling rate using the following commands. For example, to set the time interval to 60 microseconds with 4096 samples, use:

```
SENS:SWE:TINT 60E-6, (@1)
SENS:SWE:POIN 4096, (@1)
```

The maximum number of sample points that are available for all measurements is 512 K points (K = 1024). If you specify a voltage measurement with 500 K points on channel 1 for example, you will only have 12 K points available for all other measurements.

Time interval values can range from 5.12 microseconds (for one parameter on Models N678xA SMU) to 40,000 seconds. Note that the shortest time interval (fastest speed) that can be specified depends on the number of parameters that are being measured, the model that is doing the measuring, and the time interval resolution.

5.12 microseconds:	1 parameter (models N678xA SMU only)
10.24 microseconds:	1 or 2 parameters (all models)
20.48 microseconds:	3 or 4 parameters (all models, with 20 μ s resolution)
20.48 microseconds:	Up to 8 parameters (all models, with 40 μ s resolution)

Time interval values from 10.24 up to 20.48 microseconds are rounded to the nearest 10.24-microsecond increment. Values above 20.48 microseconds are rounded to the nearest 20.48-microsecond increment when the resolution is set to RES20. Values above 20.48 microseconds are rounded to the nearest 40.96-microsecond increment when the resolution is set to RES40.

You can change the time interval resolution as follows:

```
SENS:SWE:TINT:RES RES20, (@1)
SENS:SWE:POIN:RES RES40, (@1)
```

Capture Pre-trigger Data

The measurement system lets you capture data before, after, or at the trigger signal. As shown in the following figure, you can move the block of data being read into the acquisition buffer with reference to the trigger. This allows pre- or post-trigger data sampling.

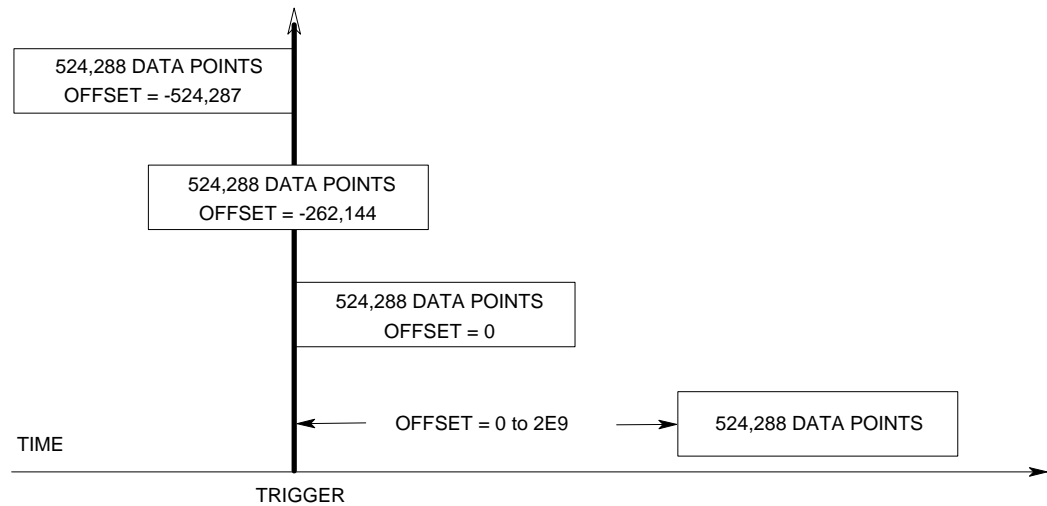

The following command offsets the beginning of the acquisition buffer relative to the trigger by 100 points on channel 1:

```
SENS:SWE:OFFS:POIN 100, (@1)
```

When the value is 0, all values are taken after the trigger. Values greater than 0 can be used to program a delay time from the receipt of the trigger until the values entered into the buffer are valid. (Delay time = offset x sample period). Negative values let you acquire samples prior to the trigger.

NOTE

If, during a pre-trigger data acquisition, a trigger occurs before the pre-trigger data count is completed, the measurement system ignores this trigger. This will prevent the completion of the measurement if another trigger is not generated.

Specify a Window Function

Windowing is a signal conditioning process that reduces the error in average measurements made in the presence of periodic signals and noise. Two window functions are available: Rectangular and Hanning. At power-on, the measurement window is RECTangular.

The Rectangular window calculates average measurements without any signal conditioning. However, in the presence of periodic signals such as AC line ripple, a Rectangular window can introduce errors when calculating average measurements. This can occur when a non-integral number of cycles of data has been acquired due to the last partial cycle of acquired data.

One way of dealing with AC line ripple is to use a Hanning window. The Hanning window applies a \cos^4 weighting function to the data when calculating average measurements. This attenuates the AC noise in the measurement window. The best attenuation is achieved when at least three or more waveform cycles are in the measurement.

To select the Hanning window function, use:

```
SENS:WIND HANN, (@1)
```

Select the Measurement Trigger Source

NOTE

An immediate trigger command over the bus will generate an immediate trigger regardless of the trigger source.

Unless you are using a TRIG:ACQ command to trigger the measurement, select a trigger source from the following:

BUS	Selects GPIB device trigger, *TRG, or <GET> (Group Execute Trigger).
CURRENT<1-4> VOLTage<1-4>	Triggers the measurement when the current or voltage of the corresponding output passes through the specified level.
EXTERNAL	Selects the trigger input BNC connector. Requires a low-true trigger signal.
PIN<n>	Selects a pin on the digital port. <n> specifies the pin number. The pin must be configured as a Trigger Input to be used as a trigger source (see Appendix C).
TRANSient<1-4>	Selects the output channel's transient system as the trigger source. <n> specifies the channel.

The following commands select a trigger source. To select Bus triggers for output 1:

```
TRIG:ACQ:SOUR BUS, (@1)
```

To select Digital pin triggers on pin 3 for output 1:

```
TRIG:ACQ:SOUR PIN3, (@1)
```

To select transient output triggers *from* output 3 for output 1: (Output 3 will generate the trigger signal for output 1)

```
TRIG:ACQ:SOUR TRAN3, (@1)
```

To enable trigger signals for output Steps or Lists: (Specify if the list trigger occurs at the Beginning Of the Step, or End Of the SStep.)

```
STEP:TOUT ON, (@3)
LIST:TOUT:BOST 1, (@3)
LIST:TOUT:EOST 1, (@3)
```

To select a voltage or current level of *another* output as the trigger for output 1: (Output 3 will generate the voltage or current level to trigger output 1.)

```
TRIG:ACQ:SOUR VOLT3, (@1)
TRIG:ACQ:SOUR CURR3, (@1)
```

To specify the voltage or current trigger level and slope of output 3:

```
TRIG:ACQ:CURR 10, (@3)
TRIG:ACQ:CURR:SLOP POS, (@3)
TRIG:ACQ:VOLT 10, (@3)
TRIG:ACQ:VOLT:SLOP POS, (@3)
```

NOTE

A non-programmable hysteresis for level triggers reduces false triggering on slow signals. The hysteresis is set to 0.0005 X maximum range value. For example, on the 50 V range, the hysteresis is approximately 25 mV.

Initiate the Measurement

When the DC Power Analyzer is turned on, the trigger system is in the Idle state. In this state, the trigger system is disabled, ignoring all triggers. The INITiate command enables the measurement system to receive triggers. To initiate the trigger system for all four outputs:

```
INIT:ACQ (@1:4)
```

It takes a few milliseconds for the instrument to be ready to receive a trigger signal after receiving the INIT:ACQ command, and it can take longer for Agilent Models N678xA SMU.

If a trigger occurs before the trigger system is ready for it, the trigger will be ignored. You can test the WTG_meas bit in the operation status register to know when the instrument is ready to receive a trigger after being initiated. To query the WTG_meas bit (bit 3):

```
STAT:OPER:COND? (@1)
```

If a bit value of 8 is returned in the query, the WTG_meas bit is true, and the instrument is ready to receive the trigger signal. Refer to the N6705 Programmer's Reference Help file for more information.

NOTE

It will be necessary to initiate the measurement trigger system each time a triggered measurement is desired.

Trigger the Measurement

The trigger system is waiting for a trigger signal in the initiated state. You can immediately trigger the measurement as follows:

```
TRIG:ACQ (@1)
```

Alternately, if the trigger source is BUS, you can also program *TRG or <GET> command.

As previously discussed, a trigger can also be generated by another output channel or an input pin on the digital port connector. If any of these systems are configured as the trigger source, the instrument will wait indefinitely for the trigger signal. If the trigger does not occur, you must abort the measurement.

To abort the measurement and return the trigger system to the Idle state:

```
ABOR:ACQ (@1)
```

Retrieve the Measurement Data

After a trigger is received and the data acquisition completes, the trigger system will return to the Idle state. When this occurs, you can use FETCh queries to return specific voltage or current data from a previously triggered measurement. FETCh queries do not alter the data in the measurement buffer.

FETC:CURR[:DC]?(@1)	(DC current)
FETC:CURR:ACDC?(@1)	(total RMS current)
FETC:CURR:HIGH?(@1)	(high level of current pulse)
FETC:CURR:LOW?(@1)	(low level of current pulse)
FETC:CURR:MAX?(@1)	(maximum current)
FETC:CURR:MIN?(@1)	(minimum current)
FETC:VOLT[:DC]?(@1)	(DC voltage)
FETC:VOLT:ACDC?(@1)	(total RMS voltage)
FETC:VOLT:HIGH?(@1)	(high level of voltage pulse)
FETC:VOLT:LOW?(@1)	(low level of voltage pulse)
FETC:VOLT:MAX?(@1)	(maximum voltage)
FETC:VOLT:MIN?(@1)	(minimum voltage)
FETC:POW?(@1)	(output power)

Power can only be measured on power modules with simultaneous measurement capability (see chapter 1, “Power Module Differences”)

If a FETCh query is sent before the measurement is finished, the response will be delayed until the measurement trigger occurs and the acquisition completes. You can test the MEAS_active bit in the operation status register to know when the measurement trigger system has returned to the idle state. To query the MEAS_active bit:

```
STAT:OPER:COND?(@1)
```

If a bit value of 32 is returned in the query, the MEAS_active bit is true, and the measurement is NOT complete. When the MEAS_active bit is false, you can retrieve the measurement. Refer to the N6705 Programmer’s Reference Help file for more information. Use Array queries to return all data from the measurement buffer.

```
FETC:ARR:VOLT?(@1)
FETC:POW?(@1)
FETC:ARR:CURR?(@1)
```

NOTE

You can specify the format of the array data. Refer to “Measurement Data Formats” later in this chapter for more information.

ASCII data (the default format) is returned as comma-separated ASCII numeric voltage or current data terminated by a newline. An ASCII query can only fetch data from one channel at a time.

Binary data is returned as a comma-separated list of data for each channel requested. The data for each channel is a definite length binary block, with the byte order specified by the BORDer command.

Each FETCh command also has a corresponding MEASure command. Measurement commands initiate, trigger, and return the data all in one step. Each measurement command overwrites previous data. Appendix B lists the Measurement commands.

External Data Logging

NOTE

The external Data Logger function is not available if Option 055 has been ordered.

In addition to the built-in data logger, the DC Power Analyzer has an external data logger (Elog) function that lets you log voltage and current measurements from all four outputs directly to an internal FIFO (first-in, first-out) buffer. Note that this buffer is only large enough to hold about 20 seconds of accumulated measurements. The following table lists the major differences between the built-in and external data loggers.

Function	Built-in Data Logger	External Data Logger
Data viewing	Optimized for viewing the measurements on the DC Power Analyzer's display.	No front panel view or front panel control.
Data storage	Stores the measurements to an internal file. Can be left unattended for an extended time and results can be viewed afterward.	Buffers measurements for about 20 seconds and requires that the computer periodically reads measurements to prevent the DC Power Analyzer's buffer from overflowing. The computer needs to provide the data storage function.
Measurement resources	Allocates all the measurement resources of ALL outputs, even if data logging is only enabled on some of the outputs.	Runs independently on each output. Some outputs can be running an external data log, while the remaining outputs can be used in front panel control or used for other SCPI functions.
Interleaved mode	Interleaved mode allows the data logger to log both voltage and current on power modules that have only one measurement converter.	Interleaved mode is not available. If a power module has only one measurement converter, then either voltage or current can be logged, but not both.
Logging rate	Can log data at up to 20.48 microseconds for one parameter.	Can log data at up to 102.4 microseconds for one parameter with data format = real.

Programming the external data logger consists of:

- Selecting the measurement functions and ranges.
- Specifying the measurement integration period.
- Selecting the trigger source.
- Triggering the data logger.
- Retrieving the data log measurement.

The external data logger function cannot be programmed from the front panel. When an external data log measurement is initiated on an output channel, the front panel changes to Meter View. Any channel that is performing an external data log measurement displays a message to this effect. Switching to Scope or Data Logger view will terminate the external data log measurement.

Select the Measurement Functions and Ranges

The following commands select a measurement function. To enable voltage measurements and min/max measurements on channel 1:

```
SENS:ELOG:FUNC:VOLT ON, (@1)
SENS:ELOG:FUNC:VOLT:MINM ON, (@1)
```

To enable current measurements and min/max measurements on channel 1:

```
SENS:ELOG:FUNC:CURR ON, (@1)
SENS:ELOG:FUNC:CURR:MINM ON, (@1)
```

The following commands select the range. To select the 5 V voltage range on channel 1:

```
SENS:ELOG:VOLT:RANG 5, (@1)
```

To select the 1 A current range on channel 1:

```
SENS:ELOG:CURR:RANG 1, (@1)
```

In order to log both voltage and current on an output channel, that channel must have simultaneous measurement capability (see chapter 1, “Power Module Features”), Models that do not have simultaneous measurement capability cannot externally log both voltage and current. There is no interleaved voltage/current mode as there is with the instrument’s internal data logger.

Seamless Measurements

Seamless voltage and current measurement autoranging is available on Agilent Models N6781A and N6782A. This enables a wide dynamic measurement range with no data lost across ranges. Autoranging does not include the 10 μ A range, which must be selected manually.

To enable seamless elog autoranging on channel 1:

```
SENS:ELOG:VOLT:RANG:AUTO ON, (@1)
SENS:ELOG:CURR:RANG:AUTO ON, (@1)
```

Specify the Integration Period

The integration period can be set from a minimum of 102.4 microseconds to a maximum of 60 seconds. The following specifies an integration period of 600 microseconds:

```
SENS:ELOG:PER 600E-6, (@1)
```

During the integration period, data log samples are averaged, and the minimum and maximum values are tracked. At the end of each integration period the average, minimum, and maximum values are added to the internal FIFO buffer.

Although the absolute minimum integration period is 102.4 microseconds, the actual minimum varies as a function of the number of parameters that are being logged. The actual minimum is 102.4 microseconds times the number of parameters being logged at each interval. Note that you can measure up to 4 parameters with the time interval resolution set to 20 microseconds, and up to 8 parameters with the resolution set to 40 microseconds.

102.4 microseconds:	1 parameter (voltage or current)
204.8 microseconds:	2 parameters (voltage+current)
409.6 microseconds:	4 parameters (voltage+min+max+current) with 20 μ s time interval resolution)
409.6 microseconds:	Up to 8 parameters with 40 μ s time interval resolution

You can change the time interval resolution. To set the resolution to 20 microseconds:

```
SENS:SWE:TINT:RES RES20, (@1)
```

To set the resolution to 40 microseconds:

```
SENS:SWE:TINT:RES RES40, (@1)
```

If the specified integration period is at or near the minimum logging intervals, the data format must be specified as binary. If binary format is not specified, the data will be in ASCII format and the minimum logging intervals will typically be up to five times longer than what can be achieved with binary format.

To set the data format to binary:

```
FORM[:DATA] REAL
```

NOTE

Refer to “Measurement Data Formats” later in this chapter for more information.

Select the Data Logger Trigger Source

The TRIGger:ELOG command generates an immediate trigger regardless of the trigger source. Unless you are using this command, select a trigger source from the following:

BUS	Selects GPIB device trigger, *TRG, or <GET> (Group Execute Trigger).
EXTernal	Selects the trigger input BNC connector. Requires a low-true trigger signal.
IMMediate	Selects the immediate trigger source. This triggers the data logger immediately when initiated.
PIN<n>	Selects a pin on the digital port. <n> specifies the pin number. The pin must be configured as a Trigger Input to be used as a trigger source (see Appendix C).

Use the following commands to select a trigger source. To select Bus triggers for output 1:

```
TRIG:ELOG:SOUR BUS, (@1)
```

To select the IMMEDIATE trigger source for output 1:

```
TRIG:ELOG:SOUR IMM, (@1)
```

To select the EXTERNAL trigger source for output 1:

```
TRIG:ELOG:SOUR EXT, (@1)
```

To select Digital pin triggers on pin 3 for output 1:

```
TRIG:ELOG:SOUR PIN3, (@1)
```

Initiate and Trigger the Data Logger

When the DC Power Analyzer is turned on, the trigger system is in the Idle state. In this state, the trigger system is disabled, ignoring all triggers. The INITiate command enables the measurement system to receive triggers. To initiate data logger measurements on output 1:

```
INIT:ELOG (@1)
```

You can then trigger the data logger as follows:

```
TRIG:ELOG (@1)
```

If the trigger source is BUS, you can also program *TRG or <GET> to trigger the data logger.

When triggered, the data logger starts placing data in the internal measurement buffer. Because the buffer is only large enough to hold 20 seconds of accumulated measurement your PC application must periodically retrieve (or fetch) the data from this buffer.

Periodically Retrieve the Data log Measurement

Each FETCh command returns number of requested records of the data in the buffer and removes them, making room available for more data. The measurement continues until it is aborted. To retrieve a maximum of 1000 records:

```
FETC:ELOG? 1000, (@1)
```

ASCII data (the default format) is returned as comma-separated ASCII numeric data sets of average/min/max values terminated by a newline. ASCII queries can only fetch data from one channel at a time.

Binary data is returned as a comma-separated list of data for each channel requested. The data for each channel is a definite length binary block, with the byte order specified by the FORMat:BOReR command.

Terminate the Measurement

To abort the external data logger:

```
ABOR:ELOG (@1)
```

Dynamic Current Correction Control

NOTE

This control is used when making dynamic current measurements; it is not required for static (or dc) measurements. On Models N678xA SMU, N6753A - N6756A, and N6763A - N6766A, the designs are such that dynamic current correction is not needed and the control is therefore unavailable.

The DC Power Analyzer measures the output current across an internal current monitor. For most power modules this current monitor is located on the inboard side of the output capacitor.

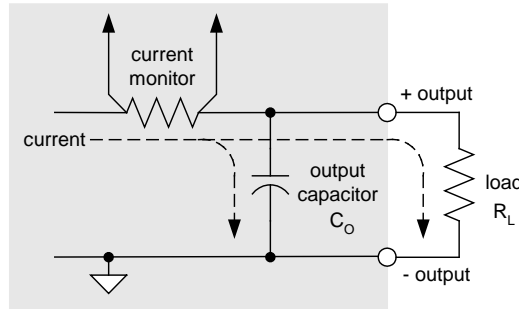

For static (or dc) measurement applications this measurement method yields accurate measurements. However, due to the output capacitor C_o , when there is a significant and rapid change in output voltage, the additional output current does not all flow into load R_L ; some of it flows through the output capacitor. In this momentary situation the measurement circuit is not only measuring the output current going into the load, but also the output current flowing through the output capacitor. Since the load never sees the additional current, this results in an inaccurate output current measurement.

When the output current is measured and averaged over a number of samples as in the case of static measurements, the inaccuracy is insignificant. However, because the DC Power Analyzer has built-in scope and data logging functions, which can sample the output current at up to about 50 kHz, this inaccuracy becomes evident.

Dynamic current correction compensates for the current flowing into the output capacitor. The DC Power Analyzer calculates what the additional current is and subtracts it from the current measurement, thus providing accurate output current measurements. This feature is turned on by default and only applies to the high current range.

NOTE

Dynamic current correction increases the peak to peak noise in current measurements on some power modules. It may also limit the measurement bandwidth as explained in the next section. If either condition is a significant factor in your application, you should turn dynamic current correction off.

To turn dynamic current correction on or off, press **Scope View** or **Data Logger**, then press **Properties**. In the current range dropdown box, select the range labeled “CComp On” to turn current correction on. Un-select the “CComp On” range to turn current correction off.

Measurement System Bandwidth

NOTE

The following applies when making dynamic current measurements; not when making static (or DC) measurements. This information does not apply to models N678xA SMU. For N678xA bandwidth information, refer to the Agilent N6700 Modular Power System Family Specifications Guide.

The measurement bandwidth of the DC Power Analyzer is dependent on the following factors:

- Whether voltage or current is being measured.
- Whether dynamic current correction has been turned on or off.
- The analog bandwidth of the power module.

The following table documents the bandwidth for the above-mentioned factors.

Power Module	Dynamic Current Correction turned on	Dynamic Current Correction turned off
Voltage measurements		
N6751A/52A, N6761A/62A	10 kHz BW (– 3dB)	10 kHz BW (– 3dB)
N6753A–56A, N6763A–66A	N/A	10 kHz BW (– 3dB)
N673xB, N674xB, N677xA	10 kHz BW (– 3dB)	25 kHz ^{Note}
Current measurements		
N6751A, N6752A	2 kHz BW (– 3dB)	10 kHz BW (– 3dB)
N6753A–N6756A	N/A	10 kHz BW (– 3dB)
N6761A, N6762A	2 kHz BW (– 3dB)	2 kHz BW (– 3dB)
N6763A–N6766A	N/A	2 kHz BW (– 3dB)
N673xB, N674xB, N677xA	2 kHz BW (– 3dB)	25 kHz ^{Note}

^{Note} Nyquist-limited to 25 kHz due to 50 kHz digitization rate.

Note that when dynamic current correction is turned off, you will see additional current in the output current measurement as the output capacitor charges and discharges when changing from one voltage value to another voltage value.

The values in the shaded areas of the table will change based on the resistance of the output load. The values specified in the table only apply when the output load resistance is at or close to zero ohms. At larger resistance values, errors are introduced into the measurement due to the interaction of the output load and the power module's output capacitor. Use the following formula to calculate the largest frequency that can be measured without errors.

$$f = \frac{1}{2\pi C_o R_L}$$

f = maximum measurable frequency without measurement errors
 C_o = the output capacitor value (from the following table)
 R_L = the load resistance

Power Module	C ₀ Value	Power Module	C ₀ Value
N6751A, N6752A, N6761A, N6762A	25.4 μF	N6731B, N6741B	30 μF
N6753A, N6755A, N6763A, N6765A	4.7 μF	N6732B, N6742B	23.5 μF
N6754A, N6756A, N6764A, N6766A	2.2 μF	N6733B, N6743B	13.4 μF
N6773A	13.2 μF	N6734B, N6744B	9.8 μF
N6774A	11.2 μF	N6735B, N6745B	12.8 μF
N6775A	4.02 μF	N6736B, N6746B	3.52 μF
N6776A, N6777A	3.54 μF		

For example, if you are measuring the output current on an Agilent N6731B with a 10 ohm load connected to the output, and with dynamic current correction turned off, the largest frequency that can be measured without introducing measurement errors is 530 Hz. If a 1 ohm load were connected to the output, the largest frequency that could be measured without errors would be 5.3 kHz.

For frequencies above the maximum measurable frequency, the current flowing in the output capacitor causes the measured current to be greater than the actual output current by a factor of +20 dB per decade increase of frequency.

Averaged Measurements

Measurement values returned in Meter View, Scope View, and by the Data Logger are averaged. Each measurement value is an arithmetic average of all the data points in the specified sample period. The average is calculated as follows:

$$A = \frac{\sum_{i=1}^N x_i}{N}$$

A = the average
 N = the number of data points
 x_i = the ith data point

The sample period of the Meter View depends on the number of power line cycles (NPLC) specified for each measurement sample. The sample period of the Scope View can be adjusted indirectly by using the Horizontal Time/Div knob to adjust the horizontal time base. The sample period of the Data Logger can be adjusted by pressing **Data Logger**, then **Properties**, and entering a value in the Sample Period field.

Note that in the Scope Marker View, you can view the average value as well as the minimum and maximum value of the sample period that is located between the two markers.

Agilent N6781A and N6782A Current Histogram Measurements

NOTE

The following information only applies to Agilent Models N6781A and N6782A. Histogram measurements are not available if option 055 (delete data logger) has been ordered.

A current histogram measurement provides a statistical measurement for profiling the measured current. The acquisition generates an array of frequency of occurrence vs. current amplitude data that can be analyzed using a CCDF function. The value of each element represents the number of times an amplitude within the range of that element has been detected.

There are two ranges of histogram bins. The high range has 4096 bins with min and max bin amplitudes of -8A and +8A, and a bin size of 3.9 mA (16 A/4096). The low range has 4096 bins with min and max bin amplitudes of -3.9 mA and +3.9 mA, and a bin size of 1.9 uA (7.8 mA/4096). Both ranges are filled when the histogram runs. Current measurement magnitudes of 3.9 mA or less are automatically placed in the low-range histogram.

The values for both histogram ranges can be queried as follows:

```
SENS:HIST:CURR:BIN:RANG? (@1)
```

This query returns two values, 8 and 0.0039. The range values are subsequently used by other SCPI commands when returning the histogram counts for the specified range.

Programming a current histogram measurement consists of:

- Selecting the histogram measurement function and range.
- Specifying the trigger source.
- Initiating and triggering the histogram.
- Retrieving the histogram measurement.
- Querying the histogram bin and offset to calculate amperes.

Histograms cannot be programmed from the front panel and cannot run simultaneously with any other measurement. When a histogram measurement is initiated on an output channel, the front panel changes to Meter view. Any channel that is performing a histogram measurement displays a message to this effect. Switching to Scope or Data Logger view will terminate the histogram measurement.

Select the Measurement Function and Range

The following command selects a measurement function. To enable current histogram measurements on channel 1:

```
SENS:HIST:FUNC:CURR ON, (@1)
```

Each output channel uses its own current measurement range, which includes autoranging. To select the 3 A current range on channel 1:

```
SENS:HIST:CURR:RANG 3, (@1)
```

Seamless Measurements

For Agilent Models N6781A and N6782A only, you can select seamless voltage and current measurements. The **Auto** selection provides seamless measurement ranging, which results in a wide dynamic range with no data being lost across ranges. Autoranging does not include the 10 μ A range, which must be selected manually.

To select current autoranging on channel 1:

```
SENS:HIST:CURR:RANG AUTO, (@1)
```

Specify the Trigger Source

The TRIGger:HIST command generates an immediate trigger regardless of the trigger source. Unless you are using this command, select a trigger source from the following:

BUS	Selects GPIB device trigger, *TRG, or <GET> (Group Execute Trigger).
EXTernal	Selects the trigger input BNC connector. Requires a low-true trigger signal.
IMMEDIATE	Selects the immediate trigger source. This triggers the histogram immediately when initiated.
PIN<n>	Selects a pin on the digital port. <n> specifies the pin number. The pin must be configured as a Trigger Input to be used as a trigger source (see Appendix C).

Use the following commands to select a trigger source. To select Bus triggers for output 1:

```
TRIG:HIST:SOUR BUS, (@1)
```

To select the IMMEDIATE trigger source for output 1:

```
TRIG:HIST:SOUR IMM, (@1)
```

To select the EXTernal trigger source for output 1:

```
TRIG:HIST:SOUR EXT, (@1)
```

To select Digital pin triggers on pin 3 for output 1:

```
TRIG:HIST:SOUR PIN3, (@1)
```

Initiate and Trigger the Histogram

When the DC Power Analyzer is turned on, the trigger system is in the Idle state. In this state, the trigger system is disabled, ignoring all triggers. The INITiate command enables the measurement system to receive triggers. To initiate histogram measurements on output 1:

```
INIT:HIST (@1)
```

You can then trigger the histogram as follows:

```
TRIG:HIST (@1)
```

(If the trigger source is BUS, you can also program *TRG or <GET>.)

When a histogram measurement is initiated and triggered, the current is continuously sampled. Histograms sample at the rate of 20.48 microseconds per sample. Each sampled value is compared to

the amplitude range of each bin of the histogram and the value of the bin that the sampled value falls within is incremented by 1. There is some overlap between the lowest bins of the high range and the highest bins of the low range; values that overlap both ranges are placed in the low range buckets. Each Fetch returns the latest cumulative histogram data. The measurement continues until it is aborted. The count bins are 64-bits wide, which eliminates any concern for overflow.

Terminate the Measurement

Measurements continue until the histogram is aborted. To abort the histogram measurement:

```
ABOR:HIST (@1)
```

Retrieve the Histogram Measurement

The following command returns the histogram counts for the 3.9 mA histogram range from output 1:

```
FETC:HIST:CURRE? 0.0039, (@1)
```

The following command returns the histogram counts for the 8 A histogram range from output 1:

```
FETC:HIST:CURRE? 8, (@1)
```

Histogram data is returned as 4096 comma-separated ASCII values terminated by a newline. A histogram query can only fetch data from one histogram range at a time.

Query the Histogram Bin and Offset to Calculate Amperes

The gain and offset are needed to convert a bin number to amperes. Therefore, the bin gain and offset can be queried for each histogram range. For example, to query the gain and offset value for the 3.9 mA histogram range, use:

```
SENS:HIST:CURRE:BIN:GAIN? 0.0039, (@1)
SENS:HIST:CURRE:BIN:OFFS? 0.0039, (@1)
```

To query the gain and offset value for the 8 A histogram range, use:

```
SENS:HIST:CURRE:BIN:GAIN? 8, (@1)
SENS:HIST:CURRE:BIN:OFFS? 8, (@1)
```

The median current in amperes of a bin can then be calculated using:

$$\text{current} = (\text{bin number}) \times \text{gain} + \text{offset}$$

where (bin number) is an integer number between 0 and 4095 corresponding to the 4096 counts returned by FETC:HIST:CURRE? Because the current measurements can be positive or negative, bin 0 represents the most negative current, bin 2048 represents 0, and bin 4095 is the most positive current.

Measurement Data Formats

The default data format for measurement queries is ASCII. You can also specify Real data format when returning SCPI array and external datalog measurements as well as for setting and querying constant-dwell Arb levels.

ASCII	Numeric data is transferred as ASCII bytes in <NR1>, <NR2>, or <NR3> format as appropriate. The numbers are separated by commas
Real	Data is returned in binary IEEE single precision floating point. In this case the four bytes of each value can be returned in either big-endian or little-endian byte order, determined by the FORMat:BOARDer setting.

The following command specifies the data format:

```
FORM ASCII | REAL
```

You can also specify how binary data is transferred. This only applies when the FORMat:DATA is set to REAL

Normal	Binary data is transferred in normal order. The most significant byte is returned first, and the least significant byte is returned last (big-endian).
Swapped	Binary data is transferred in swapped-byte order. The least significant byte is returned first, and the most significant byte is returned last (little-endian).

The following command specifies the byte order of the data:

```
FORM:BORD NORM | SWAP
```

Use swapped format if you are using a little-endian data processor.

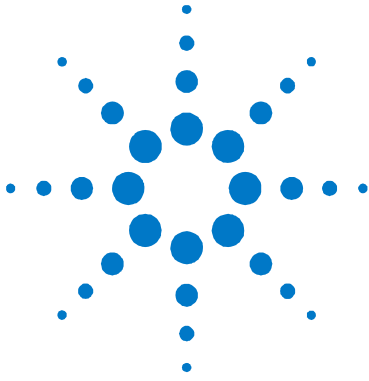

Appendix A Specifications

[Agilent N6705A, N6705B DC Power Analyzer Mainframe](#)..... 180

This appendix lists the supplemental characteristics of the Agilent N6705 DC Power Analyzer. A dimensional line drawing of the mainframe is included at the end of the appendix.

Supplemental characteristics are not warranted but are descriptions of performance determined either by design or by type testing. All supplemental characteristics are typical unless otherwise noted.

NOTE

Complete specifications and supplemental characteristics information for all power modules are included in the Agilent N6700 Modular Power System Family Specifications Guide. This document is available on the Agilent N6705 Product Reference CD that is shipped along with your instrument as well as on the web at www.agilent.com/find/N6705.



Agilent N6705A, N6705B DC Power Analyzer Mainframe

Supplemental Characteristics

N6705A, N6705B	
Maximum Power Available for Modules: (sum of total module output power)	
600 W	
Front Panel Output Terminals:	
Maximum current rating	20 A
BNC Trigger Connectors:	
I/O	Digital TTL level compatible
Maximum voltage	5 V
USB Current Ratings:	
Front panel USB connector	200 mA
Rear panel USB connector	300 mA
Data Storage:	
Internal flash memory	4 Gbyte (Earlier N6705 models have less memory)
Protection Response Characteristics:	
INH input	5 μ s from receipt of inhibit to start of shutdown
Fault on coupled outputs	< 10 μ s from receipt of fault to start of shutdown
Command Processing Time:	
\leq 1 ms from receipt of command to start of output change	
Digital Port Characteristics:	
Maximum voltage ratings	+16.5 VDC/– 5 VDC between pins (pin 8 is internally connected to chassis ground).
Pins 1 and 2 as FLT output	Maximum low-level output voltage = 0.5 V @ 4 mA Maximum low-level sink current = 4 mA Typical high-level leakage current = 1 mA @ 16.5 VDC
Pins 1 - 7 as digital/trigger outputs (pin 8 = common)	Maximum low-level output voltage = 0.5 V @ 4 mA; 1 V @ 50 mA; 1.75 V @ 100 mA Maximum low-level sink current = 100 mA Typical high-level leakage current = 0.8 mA @ 16.5 VDC
Pins 1 - 7 as digital/trigger inputs and pin 3 as INH input (pin 8 = common)	Maximum low-level input voltage = 0.8 V Minimum high-level input voltage = 2 V Typical low-level current = 2 mA @ 0 V (internal 2.2k pull-up) Typical high-level leakage current = 0.12 mA @ 16.5 VDC
Interface Capabilities:	
GPIB	SCPI - 1993, IEEE 488.2 compliant interface
LXI Compliance	Class C
USB 2.0	Requires Agilent IO Library version M.01.01 or 14.0 and up
10/100 LAN	Requires Agilent IO Library version L.01.01 or 14.0 and up
Built-in Web server	Requires Internet Explorer 7+ or Firefox 2+

Supplemental Characteristics (continued)

N6705A, N6705B

Regulatory Compliance:

EMC	Complies with European EMC Directive for test and measurement products. <ul style="list-style-type: none"> • IEC/EN 61326-1 • CISPR 11 Group 1, class A • AS/NZS CISPR 11 • ICES/NMB-001 Complies with Australian standard and carries C-Tick mark. This ISM device complies with Canadian ICES-001. Cet appareil ISM est conforme à la norme NMB-001 du Canada.
Safety	Complies with European Low Voltage Directive and carries the CE-marking. Conforms to UL 61010-1 and CSA C22.2 61010-1.

Environmental Conditions

Operating environment	Indoor use, installation category II (for AC input), pollution degree 2
Temperature range	0°C to 55°C (output current is derated 1% per °C above 40°C ambient temperature)
Relative humidity	Up to 95%
Altitude	Up to 2000 meters
Storage temperature	-30°C to 70°C

Acoustic Noise Declaration:

This statement is provided to comply with the requirements of the German Sound Emission Directive, from 18 January 1991.	Sound Pressure Lp <70 dB(A), At Operator Position, Normal Operation, According to EN 27779 (Type Test). Schalldruckpegel Lp <70 dB(A), Am Arbeitsplatz, Normaler Betrieb, Nach EN 27779 (Typprüfung).
--	---

Output Terminal Isolation:

Maximum rating	No output terminal may be more than ±240 VDC from any other terminal or chassis ground.
N6781A Note	When using the AUX measurement input terminals on Model N6781A, no front panel output terminal or rear panel input terminal may be more than ±60 VDC from any other terminal and chassis ground.

AC Input:

Input Ratings	~ 100 VAC – 240 VAC; 50/60/400Hz
Power Consumption	1440 VA
Power Factor ^{NOTE 1}	0.99 @ nominal input and rated power
Fuse	Internal fuse - not customer accessible.

Net Weight:

N6705 with 4 modules (typical)	16 kg / 35 lbs
Single power module (typical)	1.23 kg / 2.71 lbs

Dimensions:

Refer to the outline diagrams on the following page.

¹ Under full load at 400 Hz, power factor drops from 0.99 @ 120 VAC to as low as 0.76 @ 265 VAC. Power factor degrades further under no load conditions.

Outline Diagram

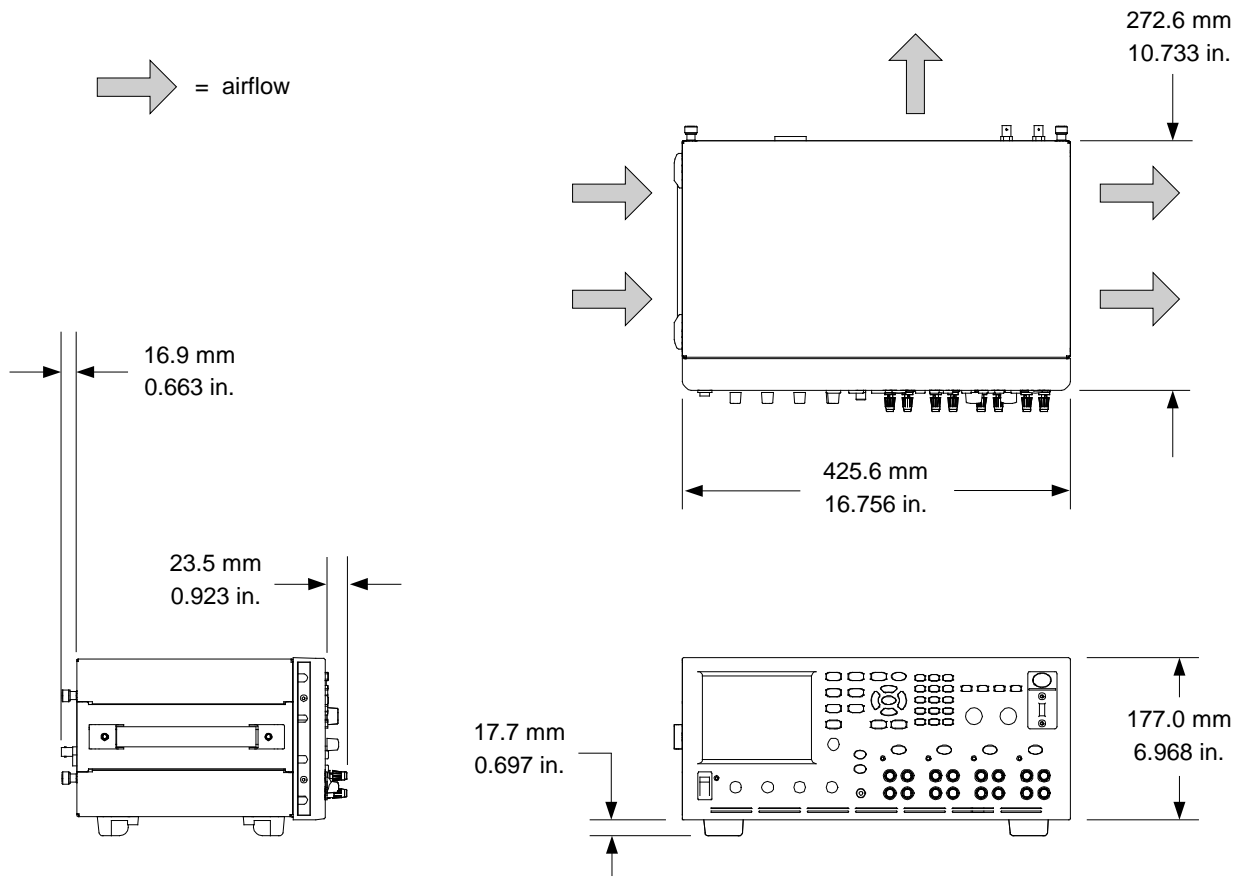



Appendix B SCPI Commands and Instrument Settings

[SCPI Command Summary](#) 184

This appendix gives the list of SCPI commands that are used to program the Agilent N6705 DC Power Analyzer.

NOTE

For complete details on programming the instrument using SCPI commands, refer to the Programmer's Reference Help file included on the Agilent N6705 Product Reference CD. This CD-ROM is shipped along with your instrument.



SCPI Command Summary

NOTE

Some [optional] commands have been included for clarity. All settings commands have a corresponding query. Not all commands apply to all models.

SCPI Command	Description
ABORt	
:ACQuire (@chanlist)	Resets the measurement trigger system to the Idle state
:DLOG	Stops the internal data logger
:ELOG (@chanlist)	Stops the external data logger
:HISTogram (@chanlist)	Stops the histogram current measurement
:TRANSient (@chanlist)	Resets the transient trigger system to the Idle state
CALibrate	
:CURRent	
[:LEVel] <NRf>, (@channel)	Calibrates the output current programming
:LIMit	
:NEGative <NRf>, (@channel)	Calibrates the negative current limit (only on N6783A)
:POSITive <NRf>, (@channel)	Calibrates the positive current limit (only on N678xA SMU)
:MEASure <NRf>, (@channel)	Calibrates the current measurement
:PEAK (@channel)	Calibrates the peak current limit (only on N675xA, N676xA)
:DATA <NRf>	Enters the calibration value
:DATE <"date">, (@channel)	Sets the calibration date
:DPRog (@channel)	Calibrates the current downprogrammer
:LEVel P1 P2 P3	Advances to the next calibration step
:PASSword <NRf>	Sets the numeric calibration password
:RESistance 20 6, (@channel)	Calibrates the output resistance (only on N6781A)
:SAVE	Saves the new cal constants in non-volatile memory
:STATE <Bool> [, <NRf>]	Enables/disables calibration mode
:VOLTage	
[:LEVel] <NRf>, (@channel)	Calibrates the output voltage programming
:CMRR (@channel)	Calibrates common mode rejection ratio (only N675xA, N676xA)
:LIMit	
:POSITive <NRf>, (@channel)	Calibrates the positive voltage limit (only on N678xA SMU)
:MEASure <NRf>, (@channel)	Calibrates the voltage measurement
:AUXiliary (@channel)	Calibrates the auxiliary voltage measurement (only on N6781A)
DISPlay	
[:WINDow]	
:VIEW METER1 METER4	Selects 1-channel or 4-channel meter view
FETCh	
[:SCALar]	
:CURRent	
[:DC]? (@chanlist)	Returns the average current
:ACDC? (@chanlist)	Returns the total rms current (AC + DC)
:HIGH? (@chanlist)	Returns the high level of a current pulse
:LOW? (@chanlist)	Returns the low level of a current pulse
:MAXimum? (@chanlist)	Returns the maximum current
:MINimum? (@chanlist)	Returns the minimum current
:POWer	
[:DC]? (@chanlist)	Returns the average output power

SCPI Command	Description
FETCh[:SCALar] (continued)	
:VOLTage	
[:DC]? (@chanlist)	Returns the average voltage
:ACDC? (@chanlist)	Returns the total rms voltage (AC + DC)
:HIGH? (@chanlist)	Returns the high level of a voltage pulse
:LOW? (@chanlist)	Returns the low level of a voltage pulse
:MAXimum? (@chanlist)	Returns the maximum voltage
:MINimum? (@chanlist)	Returns the minimum voltage
:ARRay	
:CURRent [:DC]? (@chanlist)	Returns the instantaneous output current
:POWer [:DC]? (@chanlist)	Returns the instantaneous output power
:VOLTage [:DC]? (@chanlist)	Returns the instantaneous output voltage
:DLOG	
:AHOur? (@chanlist)	Returns the amp-hours between markers
:CURRent	
[:DC]? (@chanlist)	Returns the average current between markers
:MAXimum? (@chanlist)	Returns the maximum current between markers
:MINimum? (@chanlist)	Returns the minimum current between markers
:PTPeak? (@chanlist)	Returns the peak-to-peak current between markers
:VOLTage	
[:DC]? (@chanlist)	Returns the average voltage between markers
:MAXimum? (@chanlist)	Returns the maximum voltage between markers
:MINimum? (@chanlist)	Returns the minimum voltage between markers
:PTPeak? (@chanlist)	Returns the peak-to-peak voltage between markers
:WHOur? (@chanlist)	Returns the watt-hours between markers
:ELOG <NR1>, (@chanlist)	Returns the most recent external data log records
:HISTogram	
:CURRent? 8 0.0039, (@chanlist)	Returns the cumulative histogram current data (N6781A, N6782A)
FORMat	
[:DATA] ASCII REAL	Returns data as ASCII or binary
:BORDER NORMal SWAPped	Sets the byte order of the external data log data
HCOPY:SDUMp:DATA?	Returns an image of the display in .gif format
INITiate	
[:IMMediate]	
:ACQuire (@chanlist)	Enables measurement triggers
:DLOG <"filename">	Enables the data logger function
:ELOG (@chanlist)	Enables external data logger measurements
:HISTogram (@chanlist)	Enables histogram measurements (only on N6781A, N6782A)
:TRANSient (@chanlist)	Enables output triggers
:CONTinuous	
:TRANSient <Bool>, (@chanlist)	Enables/disables continuous transient triggers
MEASure	
[:SCALar]	
:CURRent	
[:DC]? (@chanlist)	Takes a measurement; returns the average current
:ACDC? (@chanlist)	Takes a measurement; returns the total rms current (AC + DC)
:HIGH? (@chanlist)	Takes a measurement; returns the high level of a current pulse
:LOW? (@chanlist)	Takes a measurement; returns the low level of a current pulse
:MAXimum? (@chanlist)	Takes a measurement; returns the maximum current
:MINimum? (@chanlist)	Takes a measurement; returns the minimum current

SCPI Command	Description
MEASure[:SCALar] (continued)	
:POWer [:DC]? (@chanlist)	Takes a measurement, returns the average output power
:VOLTagE [:DC]? (@chanlist)	Takes a measurement; returns the average voltage
:ACDC? (@chanlist)	Takes a measurement; returns the total rms voltage (AC + DC)
:HIGH? (@chanlist)	Takes a measurement; returns the high level of a voltage pulse
:LOW? (@chanlist)	Takes a measurement; returns the low level of a voltage pulse
:MAXimum? (@chanlist)	Takes a measurement; returns the maximum voltage
:MINimum? (@chanlist)	Takes a measurement; returns the minimum voltage
:ARRay	
:CURRent [:DC]? (@chanlist)	Takes a measurement; returns the instantaneous output current
:POWer [:DC]? (@chanlist)	Takes a measurement; returns the instantaneous output power
:VOLTagE [:DC]? (@chanlist)	Takes a measurement; returns the instantaneous output voltage
MMEMory	
:ATTRibute? <"object">, <"attribute">	Gets the attributes of a file system object
:DATA [:DEFinite]? <"filename">	Copies file contents; response is a definite length binary block
:DELete <"filename">	Deletes a file
:EXPort :DLOG <"filename">	Exports a data log from the display to a file
:LOAD :ARB:SEquence <"filename">, (@chanlist)	Loads an Arb sequence
:STORe :ARB:SEquence <"filename">, (@chanlist)	Stores an Arb sequence
OUTPut	
[:STATe] <Bool> [,NORelay], (@chanlist)	Enables/disables the specified output channel(s)
:COUPLe :CHANNel [<NR1> {,<NR1>}]	Selects which channels are coupled
:DOFFset <NRf> :MODE AUTO MANUal	Specifies a maximum delay offset to synchronize output changes Specifies the output delay coupling mode
:MAX :DOFFset?	Returns the maximum delay offset required for a mainframe
:DELay :FALL <NRf+>, (@chanlist) :RISE <NRf+>, (@chanlist)	Sets the output turn-off sequence delay Sets the output turn-on sequence delay
:PMODe VOLTagE CURRent, (@chanlist)	Sets the mode for turn on/off transitions (N6761A, N6762A)
:TMODe HIGHZ LOWZ, (@chanlist)	Specifies the turn-off output impedance (only on N678xA SMU)
:INHibit :MODE LATCHing LIVE OFF	Sets the remote inhibit input
:PON :STATe RST RCL0	Programs the power-on state
:PROTection :CLEar (@chanlist) :COUPLe <Bool>	Resets latched protection Enables/disables channel coupling for protection faults
:DELay <NRf+>, (@chanlist)	Sets the over-current protection programming delay
:OSCillation[:STATe] <Bool>, (@chanlist)	Enables/disables output oscillation protection (N678xA SMU)
:WDOG [:STATe] <Bool> :DELay <NRf+>	Enables/disables the I/O watchdog timer Sets watchdog timer delay
:RELay :POLarity NORMal REVerse, (@chanlist)	Sets the output relay polarity (only on option 760)

SCPI Command	Description
SENSe	
:CURRent	
:CCOMpensate <Bool>, (@chanlist)	Enables/disables the capacitive current compensation
[:DC]:RANGe	
[:UPPer] <NRf+>, (@chanlist)	Selects the current measurement range
:AUTO <Bool>, (@chanlist)	Enables/disables measurement autoranging (N6781A, N6782A)
:DLOG	
:CURRent	
[:DC]:RANGe	
[:UPPer] <NRf+>, (@chanlist)	Sets the internal data log current range
:AUTO <Bool>, (@chanlist)	Enables/disables measurement autoranging (N6781A, N6782A)
:FUNCTion	
:CURRent <Bool>, (@chanlist)	Enables/disables current data logging
:MINMax <Bool>	Enables/disables min/max data logging
:VOLTage <Bool>, (@chanlist)	Enables/disables voltage data logging
:MARKer<1,2>	
:POINt <NRf+>	Positions the data log markers
:OFFSet <NR1>	Sets trigger offset as a percent from start of data log duration
:PERiod <NRf+>	Sets the interval between samples (replaces TINTerval)
:TIME <NRf+>	Sets the duration of the data log in seconds
:TINTerval <NRf+>	Sets the interval between samples (for backward compatibility)
:VOLTage	
[:DC]:RANGe	
[:UPPer] <NRf+>, (@chanlist)	Sets the internal data log voltage range
:AUTO <Bool>, (@chanlist)	Enables/disables measurement autoranging (N6781A, N6782A)
:ELOG	
:CURRent	
[:DC]:RANGe	
[:UPPer] <NRf+>, (@chanlist)	Sets the external data log current range
:AUTO <Bool>, (@chanlist)	Enables/disables measurement autoranging (N6781A, N6782A)
:FUNCTion	
:CURRent <Bool>, (@chanlist)	Enables/disables external current data logging
:MINMax <Bool>, (@chanlist)	Enables/disables external min/max current data logging
:VOLTage <Bool>, (@chanlist)	Enables/disables external voltage data logging
:MINMax <Bool>, (@chanlist)	Enables/disables external min/max voltage data logging
:PERiod <NR1>, (@chanlist)	Sets the integration time of the external data logging
:VOLTage	
[:DC]:RANGe	
[:UPPer] <NRf+>, (@chanlist)	Sets the external data log voltage range
:AUTO <Bool>, (@chanlist)	Enables/disables measurement autoranging (N6781A, N6782A)
:FUNCTion "VOLTage" "CURRent" "NONE", (@chanlist)	Enables the measurement function (for backward compatibility)
:CURRent <Bool>, (@chanlist)	Enables/disables current measurements (replaces FUNCTion)
:VOLTage <Bool>, (@chanlist)	Enables/disables voltage measurements (replaces FUNCTion)
:INPut MAIN AUXiliary, (@chanlist)	Selects the voltage measurement input (only on N6781A)
:HISTogram	
:CURRent	
[:DC]:BIN	
:GAIN? 8 0.0039, (@chanlist)	Queries the LSB weight of the histogram (N6781A, N6782A)
:OFFSet? 8 0.0039, (@chanlist)	Queries the weight of the histogram (N6781A, N6782A)
:RANGes? (@chanlist)	Queries the values of the bin ranges (N6781A, N6782A)
[:DC]:RANGe	
[:UPPer] <NRf+>, (@chanlist)	Sets the measurement range of the histogram (N6781A, N6782A)
:AUTO <Bool>, (@chanlist)	Enables/disables measurement autoranging (N6781A, N6782A)

SCPI Command	Description
SENSE:HISTogram (continued)	
:FUNction	
:CURRent <Bool>, (@chanlist)	Enables/disables current histogram (only on N6781A, N6782A)
:SWEep	
:OFFSet	
:POINTs <NRf+>, (@chanlist)	Defines the trigger offset in the measurement sweep
:POINTs <NRf+>, (@chanlist)	Defines the number of data points in the measurement
:TINTerval <NRf+>, (@chanlist)	Sets the measurement sample interval
:RESolution RES20 RES40, (@chanlist)	Sets the measurement resolution
:VOLTage	
[:DC]:RANGe	
[:UPPer] <NRf+>, (@chanlist)	Selects the voltage measurement range
:AUTO <Bool>, (@chanlist)	Enables/disables measurement autoranging (N6781A, N6782A)
:WINDow	
[:TYPE] HANNing RECTangular, (@chanlist)	Selects the window type
[SOURce:]ARB	
:COUNT <NRf+> INfinity, (@chanlist)	Sets the Arb repeat count
:CURRent :VOLTage	Specifies current or voltage Arbs
:CDWell	
[:LEVel] < NRf+> {,<NRf+>}, (@chanlist)	Sets the list of the constant dwell Arb
:DWELl < NRf+>, (@chanlist)	Sets the dwell time for the constant dwell Arb
:POINTs? (@<chanlist>)	Returns the number of constant-dwell Arb points
:CONVert (@chanlist)	Converts the selected Arb to a user-defined list
:EXPonential	
:END	
[:LEVel] < NRf+>, (@chanlist)	Sets the end level of the exponential Arb
:START	
[:LEVel] < NRf+>, (@chanlist)	Sets the initial level of the exponential Arb
:TIMe < NRf+>, (@chanlist)	Sets the length of the start time or delay
:TCONstant < NRf+>, (@chanlist)	Sets the time constant of the exponential Arb
:TIMe < NRf+>, (@chanlist)	Sets the time of the exponential Arb
:PULSe	
:END	
:TIMe < NRf+>, (@chanlist)	Sets the length of the end time
:START	
[:LEVel] < NRf+>, (@chanlist)	Sets the initial level of the pulse
:TIMe < NRf+>, (@chanlist)	Sets the length of the start time or delay
:TOP	
[:LEVel] < NRf+>, (@chanlist)	Sets the top level of the pulse
:TIMe < NRf+>, (@chanlist)	Sets the length of the pulse
:RAMP	
:END	
[:LEVel] < NRf+>, (@chanlist)	Sets the end level of the ramp
:TIMe < NRf+>, (@chanlist)	Sets the length of the end time
:RTIME < NRf+>, (@chanlist)	Sets the rise time of the ramp
:START	
[:LEVel] < NRf+>, (@chanlist)	Sets the initial level of the ramp
:TIMe < NRf+>, (@chanlist)	Sets the length of the start time or delay
:SINusoid	
:AMPLitude < NRf+>, (@chanlist)	Sets the amplitude of the sine wave
:FREQuency < NRf+>, (@chanlist)	Sets the frequency of the sine wave
:OFFSet < NRf+>, (@chanlist)	Sets the DC offset of the sine wave

SCPI Command	Description
[SOURce:]ARB (continued)	
:STAircase	
:END	
[:LEVel] < NRf+>, (@chanlist)	Sets the end level of the staircase
:TIME < NRf+>, (@chanlist)	Sets the length of the end time
:NSTeps < NRf+>, (@chanlist)	Sets the number of steps in the staircase
:STARt	
[:LEVel] < NRf+>, (@chanlist)	Sets the initial level of the staircase
:TIME < NRf+>, (@chanlist)	Sets the length of the start time or delay
:TIME <NRf+>, (@chanlist)	Sets the length of the staircase
:STEP	
:END	
[:LEVel] < NRf+>, (@chanlist)	Sets the end level of the step
:STARt	
[:LEVel] < NRf+>, (@chanlist)	Sets the initial level of the step
:TIME < NRf+>, (@chanlist)	Sets the length of the start time or delay
:TRAPezoid	
:END	
:TIME < NRf+>, (@chanlist)	Sets the length of the end time
:FTIME < NRf+>, (@chanlist)	Sets the length of the fall time
:RTIME < NRf+>, (@chanlist)	Sets the length of the rise time
:STARt	
[:LEVel] < NRf+>, (@chanlist)	Sets the initial level of the trapezoid
:TIME < NRf+>, (@chanlist)	Sets the length of the start time or delay
:TOP	
[:LEVel] < NRf+>, (@chanlist)	Sets the top level of the trapezoid
:TIME < NRf+>, (@chanlist)	Sets the length of the top of the trapezoid
:UDEfined	
:BOSTep	
[:DATA] <Bool> {,<Bool>}, (@chanlist)	Generate triggers at the Beginning Of SStep
:POINts? (@chanlist)	Returns the number of BOST points
:DWELl <NRf> {,<NRf>}, (@chanlist)	Sets the user-defined dwell values
:POINts? (@chanlist)	Returns the number of dwell points
:LEVel <NRf> {,<NRf>}, (@chanlist)	Sets the user-defined level values
:POINts? (@chanlist)	Returns the number of points
:FUNction <function>, (@chanlist)	Selects the Arb function (for backward compatibility)
:SHAPE <function>, (@chanlist)	Selects the Arb function (replaces ARB:FUNction)
:TYPE CURRent VOLTage, (@chanlist)	Selects the Arb type (replaces ARB:FUNction)
:SEquence	
:COUNT <NRf+> INFIinity, (@chanlist)	Sets the number of times the sequence is repeated
:LENgth? (@chanlist)	Returns the number of steps in the sequence
:QUALity? (@chanlist)	Returns the quality of the waveforms in the sequence
:RESet (@chanlist)	Resets the sequence to its power-on default setting
:STEP	
:COUNT <NRf+> INFIinity, <step#>, (@chanlist)	Sets the number of times the sequence step is repeated
:CURRent <ARB_function>, <step#>, (@chanlist)	Programs the waveform steps within a current sequence
:FUNction	
:SHAPE <function>, <step#>, (@chanlist)	Creates a new sequence step
:PACing DWELl TRIGger, <step#>, (@chanlist)	Specifies the type of pacing for the step
:VOLTage <ARB_function>, <step#>, (@chanlist)	Programs the waveform steps within a voltage sequence
:TERMinate	
:LAST <Bool>, (@chanlist)	Sets the sequence termination mode
:TERMinate:LAST <Bool>, (@chanlist)	Sets the Arb termination mode

SCPI Command	Description
[SOURce:]CURRent	
[:LEVel]	
[:IMMediate][:AMPLitude] <NRf+>, (@chanlist)	Sets the output current
:TRIGgered [:AMPLitude] <NRf+>, (@chanlist)	Sets the triggered output current
:LIMit	
[:POSitive]	
[:IMMediate][:AMPLitude] <NRf+>, (@chanlist)	Sets the positive current limit (only on N678xA SMU, N6783A)
:COUPle <Bool>, (@chanlist)	Sets the current limit tracking state (only on N678xA SMU)
:NEGative	
[:IMMediate][:AMPLitude] <NRf+>, (@chanlist)	Sets the negative current limit (only on N678xA SMU, N6783A-BAT)
:MODE FIXed STEP LIST ARB, (@chanlist)	Sets the current trigger mode
:PROtection	
:DELay	
[:TIME] <NRf+> (@chanlist)	Sets the over-current protection programming delay
:STARt SCHange CCTRans, (@chanlist)	Sets the over-current protection programming mode
:STATe <Bool>, (@chanlist)	Enables/disables over-current protection on the selected output
:RANGe <NRf+>, (@chanlist)	Sets the output current range
:SLEW	
[:IMMediate] <NRf+> INFInity, (@chanlist)	Sets the output current slew rate (N678xA SMU)
MAXimum <Bool>, (@chanlist)	Enables/disables the maximum slew rate override (N678xA SMU)
[SOURce:]DIGital	
:INPut	
:DATA?	Reads the state of the digital port pins
:OUTPut	
:DATA <NRf>	Sets the digital port
:PIN<1-7>	
:FUNctIon <function>	Sets the selected pin's function <function>= DIO, DINPut, TOUTput, TINPput, FAULt, INHibit, ONCOuple, OFFCOuple
:POLarity POSitive NEGative	Sets the selected pin's polarity
:TOUTput	
:BUS [:ENABle] <Bool>	Enables/disables BUS-generated triggers on digital pins
[SOURce:]EMULation <type>, (@chanlist)	Specifies the emulation mode on N678xA <type> = PS4Q, PS2Q, PS1Q, BATTery, CHARger, CCLoad, CVLoad, VMETer, AMETer
[SOURce:]FUNctIon CURRent VOLTage, (@chanlist)	Specifies current priority or voltage priority mode (N678xA SMU)
[SOURce:]LIST	
:COUNT <NRf+> INFInity, (@chanlist)	Sets the list repeat count
:CURRent	
[:LEVel] <NRf> {,<NRf>}, (@chanlist)	Sets the current list
:POINts? (@chanlist)	Returns the number of current list points
:DWELI <NRf> {,<NRf>}, (@chanlist)	Sets the list of dwell times
:POINts? (@chanlist)	Returns the number of dwell list points
:STEP ONCE AUTO, (@chanlist)	Specifies how the list responds to triggers
:TERMinate	
:LAST <Bool>, (@chanlist)	Sets the list termination mode
:TOUTput	
:BOSTep	
[:DATA] <Bool> {,<Bool>}, (@chanlist)	Generate triggers at the Beginning Of STep
:POINts? (@chanlist)	Returns the number of BOST list points

SCPI Command	Description
[SOURce:]LIST:TOUTput (continued)	
:EOSTep [:DATA] <Bool> {,<Bool>}, (@chanlist) :POINts? (@chanlist)	Generate triggers at the End Of STep Returns the number of EOSt list points
:VOLTage [:LEVel] <NRf> {,<NRf>}, (@chanlist) :POINts? (@chanlist)	Sets the voltage list Returns the number of voltage list points
[SOURce:]POWer :LIMit <NRf+>, (@chanlist)	Sets the power limit on output channels
[SOURce:]RESistance [:LEVel] [:IMMEDIATE][:AMPLitude] <NRf+>, (@chanlist) :STATe <Bool>, (@chanlist)	Sets the output resistance (only on N6781A) Enables/disables output resistance programming (N6781A)
[SOURce:]STEP :TOUTput <Bool>, (@chanlist)	Generate a trigger output on the voltage or current step
[SOURce:]VOLTage [:LEVel] [:IMMEDIATE][:AMPLitude] <NRf+>, (@chanlist) :TRIGgered [:AMPLitude] <NRf+>, (@chanlist) :BWIDth DEFault FAST1 FAST2 FAST3, (@chanlist) :LIMit [:POSitive] [:IMMEDIATE][:AMPLitude] <NRf+>, (@chanlist) :COUple <Bool>, (@chanlist) :NEGative [:IMMEDIATE][:AMPLitude] <NRf+>, (@chanlist) :MODE FIXed STEP LIST ARB, (@chanlist) :PROTection [:LEVel] <NRf+>, (@chanlist) :DELay[:TIME] <NRf+>, (@chanlist) :REMote [:POSitive][:LEVel] <NRf+>, (@chanlist) :NEGative[:LEVel] <NRf+>, (@chanlist) :RANGe <NRf+>, (@chanlist) :SENSe :SOURce INTernal EXTernal, (@chanlist) :SLEW [:IMMEDIATE] <NRf+> INFInity, (@chanlist) MAXimum <Bool>, (@chanlist)	Sets the output voltage Sets the triggered output voltage Sets the voltage bandwidth (only on N678xA SMU) Sets the positive voltage limit (only on N678xA SMU) Sets the voltage limit tracking state (only on N6784A) Sets the negative voltage limit (only on N6784A) Sets the voltage trigger mode Sets the over-voltage protection level Sets the over-voltage protection delay (only on N6783A) Sets the positive remote OV protection level (only on N678xA SMU) Sets the negative remote OV protection level (only on N6784A) Sets the output voltage range Sets the remote sense relays Sets the output voltage slew rate Enables/disables the maximum slew rate override
STATus	
:OPERation [:EVENT]? (@chanlist) :CONDition? (@chanlist) :ENABle <NRf>, (@chanlist) :NTRansition <NRf>, (@chanlist) :PTRansition <NRf>, (@chanlist)	Returns the value of the operation event register Returns the value of the operation condition register Enables specific bits in the event register Sets the negative transition filter Sets the positive transition filter
:PRESet	Presets all enable and transition registers to power-on

SCPI Command	Description
STATus (continued)	
:QUESTionable	
[:EVENT]? (@chanlist)	Returns the value of the questionable event register
:CONDition? (@chanlist)	Returns the value of the questionable condition register
:ENABle <NRf>, (@chanlist)	Enables specific bits in the event register
:NTRansition <NRf>, (@chanlist)	Sets the negative transition filter
:PTRansition <NRf>, (@chanlist)	Sets the positive transition filter
SYSTem	
:CHANnel	
[:COUNt]?	Returns the number of output channels in a mainframe
:MODel? (@chanlist)	Returns the model number of the selected channel
:OPTion? (@chanlist)	Returns the option installed in the selected channel
:SERial? (@chanlist)	Returns the serial number of the selected channel
:COMMunicate	
:RLSTate LOCAL REMote RWLock	Specifies the Remote/Local state of the instrument
:TCPip:CONTRol?	Returns the control connection port number
:DATE <yyyy>,<mm>,<dd>	Sets the date of the system clock
:ERRor?	Returns the error number and error string
:GROup	
:CATalog?	Returns the groups that have been defined (NOT for N678xA SMU)
:DEFine (@chanlist)	Group channels to create a single output (NOT for N678xA SMU)
:DELete <channel>	Deletes the specified channel from a group (NOT for N678xA SMU)
:ALL	Ungroups all channels (NOT for N678xA SMU)
:PASSword:FPANel:RESet	Resets the front panel lock password to zero
:REBoot	Returns the unit to its power-on state
:TIME <hh>,<mm>,<ss>	Sets the time of the system clock
:VERSion?	Returns the SCPI version number
TRIGger	
:ACQuire	
[:IMMEDIATE] (@chanlist)	Triggers the measurement immediately
:CURRent	
[:LEVel] <NRf>, (@chanlist)	Sets the current trigger level
:SLOPe POSitive NEGative, (@chanlist)	Sets the current trigger slope
:SOURce <source>, (@chanlist)	Sets the measurement trigger source <source> = BUS, CURRent<n>, EXTernal, PIN<n>, TRANsient<n>, VOLTage<n>
:TOUTput	
[:ENABle] <Bool>, (@chanlist)	Enables measurement triggers to be sent to a digital port pin
:VOLTage	
[:LEVel] <NRf>, (@chanlist)	Sets the voltage trigger level
:SLOPe POSitive NEGative, (@chanlist)	Sets the voltage trigger slope
:ARB:SOURce BUS IMMEDIATE EXTernal	Sets the arbitrary waveform trigger source
:DLOG	
[:IMMEDIATE]	Triggers the internal data logger immediately
:CURRent	
[:LEVel] <NRf>, (@chanlist)	Sets the current trigger level of the data logger
:SLOPe POSitive NEGative, (@chanlist)	Sets the current trigger slope of the data logger
:SOURce <source>	Sets the internal data logger trigger source <source> = BUS, CURRent<n>, EXTernal, IMMEDIATE, VOLTage<n>, ARSK, OOOK
:VOLTage	
[:LEVel] <NRf>, (@chanlist)	Sets the voltage trigger level of the data logger
:SLOPe POSitive NEGative, (@chanlist)	Sets the voltage trigger slope of the data logger

SCPI Command	Description
TRIGger:DLOG (continued)	
:ELOG	
[:IMMEDIATE] (@chanlist)	Triggers the external data logger immediately
:SOURce <source>, (@chanlist)	Sets the external data logger trigger source <source> = BUS, EXTernal, IMMEDIATE, PIN<n>
:HISTogram	
[:IMMEDIATE] (@chanlist)	Triggers the current histogram immediately (N6781A, N6782A)
:SOURce <source>, (@chanlist)	Sets the current histogram trigger source (N6781A, N6782A) <source> = BUS, EXTernal, IMMEDIATE, PIN<n>
:TRANSient	
[:IMMEDIATE] (@chanlist)	Triggers the output immediately
:SOURce <source>, (@chanlist)	Sets the output trigger source <source> = BUS, EXTernal, IMMEDIATE, PIN<n>, TRANSient<n>

Common Commands

Command	Description	Command	Description
*CLS	Clear status	*RST	Reset
*ESE <NRf>	Standard event status enable	*SAV <NRf>	Saves an instrument state
*ESR?	Return event status register	*SRE <NRf>	Set service request enable register
*IDN?	Return instrument identification	*STB?	Return status byte
*OPC	Enable "operation complete" bit in ESR	*TRG	Trigger
*OPT?	Return option number	*TST?	Performs self-test, then returns result
*RCL <NRf>	Recalls a saved instrument state	*WAI	Pauses additional command processing until all device commands are done
*RDT?	Return output channel descriptions		

Interface Settings

Factory-shipped non-volatile LAN settings			
Get IP Address	Automatic	Dynamic DNS naming service	Enabled
IP Address	169.254.67.5	NetBIOS naming service	Enabled
Subnet Mask	255.255.0.0	Domain name	Blank
Default Gateway	0.0.0.0	TCP keepalive	Enabled
Obtain DNS server from DHCP	Enabled	TCP keepalive seconds	1800
DNS server	Blank	Ethernet Auto-negotiation	Enabled
Host name	A-N6705B-xxxxx	Ping server	Enabled
		Web password	Blank
Other factory-shipped non-volatile settings			
Admin/Calibration password	0 (zero)	LAN interface	Enabled
Calibration date	March 5, 2007	Output Inhibit mode	Off
Channel grouping	No groups	Saved states	*RST command
Digital port function (all pins)	Digital In	Voltage and Current knobs	Unlocked
Digital port polarity (all pins)	Positive	Screen saver	Enabled
Front panel lockout	Disabled	Screen saver delay	60 minutes
Front panel meter view	Single-channel	USB interface	Enabled
GPIB Address	5	Wake on I/O	Enabled
Key clicks	Enabled	Web server	Enabled

Power-On Settings

These settings are set by the Reset (*RST) command			
ARB:COUNt	1	ARB:FUNcTion:SHAPe	NONE
ARB:CURRent VOLTage:CDWell:DWELI	0.001	ARB:FUNcTion:TYPE	VOLT
ARB:CURRent VOLTage:CDWell:LEVel	MIN	ARB:SEQUence:COUNt	1
ARB:CURRent VOLTage:EXPOntial:END	MIN	ARB:SEQUence:STEP:COUNt	1
ARB:CURRent VOLTage:EXPOntial:STARt	MIN	ARB:SEQUence:STEP:FUNcTion:SHAPe	PULS
ARB:CURRent VOLTage:EXPOntial:STARt:TIME	0	ARB:SEQUence:STEP:PACing	DWEL
ARB:CURRent VOLTage:EXPOntial:TCONstant	1	ARB:SEQUence:TERMinate:LAST	ON
ARB:CURRent VOLTage:EXPOntial:TIME	1	ARB:TERMinate:LAST	OFF
ARB:CURRent VOLTage:PULSe:END	0	CALibrate:STATe	OFF
ARB:CURRent VOLTage:PULSe:STARt	MIN	CURRent	0.08 or MIN
ARB:CURRent VOLTage:PULSe:STARt:TIME	0	CURRent:LIMit	MAX
ARB:CURRent VOLTage:PULSe:TOP	MIN	CURRent:LIMit:COUPlE	ON
ARB:CURRent VOLTage:PULSe:TOP:TIME	1	CURRent:LIMit:NEGative	MIN
ARB:CURRent VOLTage:RAMP:END	MIN	CURRent:MODE	FIX
ARB:CURRent VOLTage:RAMP:END:TIME	0	CURRent:PROTection:DELay	0.02
ARB:CURRent VOLTage:RAMP:RTIME	1	CURRent:PROTection:DELaySTARt	SCH
ARB:CURRent VOLTage:RAMP:STARt	MIN	CURRent:PROTection:STATe	OFF
ARB:CURRent VOLTage:RAMP:STARt:TIME	0	CURRent:RANGe	MAX
ARB:CURRent VOLTage:SINusoid:AMPLitude	MIN	CURRent:TRIGger	MIN
ARB:CURRent VOLTage:SINusoid:FREQuency	1	CURRent:SLEW	9.9E+37
ARB:CURRent VOLTage:SINusoid:OFFSet	0	CURRent:SLEW:MAX	ON
ARB:CURRent VOLTage:STAIrcase:END	0	DIGital:OUTPut:DATA	0
ARB:CURRent VOLTage:STAIrcase:END:TIME	MIN	DISPLay:VIEW	METER1
ARB:CURRent VOLTage:STAIrcase:NSTeps	10	EMULation	PS4Q (N6784A); PS2Q (N6781A, N6782A)
ARB:CURRent VOLTage:STAIrcase:STARt	MIN	FUNcTion	VOLT
ARB:CURRent VOLTage:STAIrcase:STAR:TIME	0	FORMat:DATA	ASCII
ARB:CURRent VOLTage:STAIrcase:TIME	1	FORMat:BORDer	NORM
ARB:CURRent VOLTage:STEP:END	MIN	INITiate:CONTInuous:TRANsient	OFF
ARB:CURRent VOLTage:STEP:STARt	MIN	LIST:COUNt	1
ARB:CURRent VOLTage:STEP:STARt:TIME	0	LIST:CURRent	MIN
ARB:CURRent VOLTage:TRAPezoid:END:TIME	0	LIST:DWELI	0.001
ARB:CURRent VOLTage:TRAPezoid:FTIME	1	LIST:STEP	AUTO
ARB:CURRent VOLTage:TRAPezoid:RTIME	1	LIST:TERMinate:LAST	OFF
ARB:CURRent VOLTage:TRAPezoid:STARt	MIN	LIST:TOUTput:BOST	OFF
ARB:CURRent VOLTage:TRAPezoid:STARt:TIME	0	LIST:TOUTput:EOST	OFF
ARB:CURRent VOLTage:TRAPezoid:TOP	MIN	LIST:VOLTage	MIN
ARB:CURRent VOLTage:TRAPezoid:TOP:TIME	1	OUTPut	OFF
ARB:CURRent VOLTage:UDEfined:BOSTep	OFF	OUTPut:COUPlE	OFF
ARB:CURRent VOLTage:UDEfined:DWELI	0.001	OUTPut:DELay:FALL	0
ARB:CURRent VOLTage:UDEfined:LEVel	MIN	OUTPut:DELay:RISE	0

These settings are set by the Reset (*RST) command			
OUTPut:PMODE	VOLT	SENSe:SWEEp:POINts	1024 or 4883
OUTPut:PROTection:COUPlE	OFF	SENSe:SWEEp:OFFSet:POINts	0
OUTPut:PROTection:DElAY	0.02	SENSe:SWEEp:TINterval	20.48E-6
OUTPut:PROTection:OSCillation	ON	SENSe:SWEEp:TINterval:RESolution	RES20
OUTPut:PROTection:WDOG	OFF	SENSe:VOLTage:RANGe	MAX
OUTPut:RElAY:POLarity	NORM	SENSe:VOLTage:RANGe;AUTO	OFF
OUTPut:TMODE	LOWZ	SENSe:WINDow	RECT
POWER:LIMit	MAX	STEP:TOUTput	FALSE
RESistance	0	TRIGger:ACQuire:CURRent	MIN
RESistance:STATe	OFF	TRIGger:ACQuire:CURRent:SLOPe	POS
SENSe:CURRent:CCOMpensate	ON	TRIGger:ACQuire:SOURce	BUS
SENSe:CURRent:RANGe	MAX	TRIGger:ACQuire:TOUTput	OFF
SENSe:CURRent:RANGe:AUTO	OFF	TRIGger:ACQuire:VOLTage	MIN
SENSe:DLOG:CURRent:RANGe:AUTO	OFF	TRIGger:ACQuire:VOLTage:SLOPe	POS
SENSe:DLOG:FUNCTion:CURRent	OFF	TRIGger:ARB:SOURce	IMM
SENSe:DLOG:FUNCTion:MINMax	OFF	TRIGger:DLOG:CURRent	MIN
SENSe:DLOG:FUNCTion:VOLTage	ON	TRIGger:DLOG:CURRent:SLOPe	POS
SENSe:DLOG:OFFset	0	TRIGger:DLOG:SOURce	IMM
SENSe:DLOG:TINterval	0.1	TRIGger:DLOG:VOLTage	MIN
SENSe:DLOG:TIME	30	TRIGger:DLOG:VOLTage:SLOPe	POS
SENSe:DLOG:VOLTage:RANGe:AUTO	OFF	TRIGger:ELOG:SOURce	BUS
SENSe:ELOG:CURRent:RANGe:AUTO	OFF	TRIGger:HISTogram:SOURce	BUS
SENSe:ELOG:FUNCTion:CURRent	ON	TRIGger:TRANSient:SOURce	BUS
SENSe:ELOG:FUNCTion:CURRent:MINMax	OFF	VOLTage	MIN
SENSe:ELOG:FUNCTion:VOLTage	OFF	VOLTage:BWIDth	LOW
SENSe:ELOG:FUNCTion:VOLTage: MINMax	OFF	VOLTage:LIMit	MAX
SENSe:ELOG:PERiod	0.1	VOLTage:LIMit:COUPlE	ON
SENSe:ELOG:VOLTage:RANGe:AUTO	OFF	VOLTage:LIMit:NEGative	MIN
SENSe:FUNCTion	"VOLT"	VOLTage:MODE	FIX
SENSe:FUNCTion:CURRent	OFF	VOLTage:PROTection:DElAY	0
SENSe:FUNCTion:VOLTage	ON	VOLTage:PROTection:REMote	MAX
SENSe:FUNCTion:VOLTage:INPut	MAIN	VOLTage:PROTection:REMote:NEGative	MIN
SENSe:HISTogram:CURRent:RANGe	MAX	VOLTage:RANGe	MAX
SENSe:HISTogram:CURRent:RANGe:AUTO	OFF	VOLTage:SLEW	9.9E+37
SENSe:HISTogram:FUNCTion:CURRent	ON	VOLTage:SLEW:MAX	ON
		VOLTage:TRIGger	MIN

Agilent N678xA SMU Initial Emulation Mode Settings

The following tables document the emulation mode settings that are applied when the emulation mode is selected. Emulation mode settings are not saved.

	4 Quadrant Power Supply ¹		2 Quadrant Power Supply		1 Quadrant Power Supply	
Priority mode	voltage	current	voltage	current	voltage	current
Quadrants	4	4	2	2	1	1
Voltage range	6.12 V	n/a	6.12 V	n/a	6.12 V	n/a
Voltage	0 V	n/a	0 V	n/a	0 V	n/a
I limit range	3.06 A	n/a	3.06 A	n/a	3.06 A	n/a
+I limit	3.06 A	n/a	3.06 A	n/a	min	n/a
-I limit	-3.06 A	n/a	-3.06 A	n/a	-0.612 A	n/a
Current range	n/a	3.06 A	n/a	3.06 A	n/a	3.06 A
Current	n/a	0 A	n/a	0 A	n/a	0 A
V limit range	n/a	6.12 V	n/a	6.12 V	n/a	6.12 V
+V limit	n/a	6.12 V	n/a	6.12 V	n/a	6.12 V
-V limit ¹	n/a	-6.12 V	n/a	min	n/a	min
Output resistance ²	0 Ω/off	n/a	0 Ω/off	n/a	0 Ω/off	n/a
Output state	off	off	off	off	off	off
I limit tracking	on	on	on	off	off	off
V limit tracking ¹	on	on	off	off	off	off

	Battery Emulator ²	Battery Charger ²	CC Load	CV Load	Voltmeter	Ammeter
Priority mode	voltage	Voltage	current	voltage	current	voltage
Quadrants	2	1	1	1	4	4
Voltage range	6.12 V	6.12 V	n/a	6.12 V	n/a	lowest
Voltage	0 V	0 V	n/a	5 mV	0 V	0 V
I limit range	3.06 A	3.06 A	n/a	3.06 A	n/a	3.06 A
+I limit	3.06 A	min	n/a	min	n/a	3.06 A
-I limit	-3.06 A	min	n/a	max	n/a	-3.06 A
Current range	n/a	n/a	3.06 A	n/a	lowest	n/a
Current	n/a	n/a	-0.5 mA	n/a	0 A	n/a
V limit range	n/a	n/a	6.12 V	n/a	20.4 V	n/a
+V limit	n/a	n/a	6.12 V	n/a	20.4 V	n/a
-V limit ¹	n/a	n/a	min	n/a	-20.4 V	n/a
Output resistance ²	0 Ω/off	0 Ω/off	n/a	0 Ω/off	n/a	0 Ω/off
Output state	off	off	off	off	on	on
I limit tracking	off	off	off	off	off	off
V limit tracking ¹	off	off	off	off	off	off

Note 1: N6784A only

Note 2: N6781A only

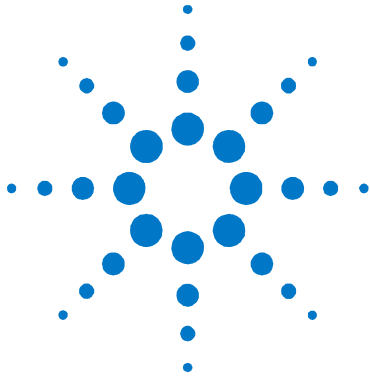

Appendix C Using the Digital Port

Configuring the Digital Port	198
--	-----

A Digital Control Port consisting of seven I/O pins is provided to access various control functions. Each pin is user-configurable. The following control functions are available for the I/O pins:

- Bi-directional Digital I/O
- Digital Input only
- External Trigger
- Fault Output
- Inhibit Input
- Output Couple Controls



Configuring the Digital Port

The following table describes the possible pin configurations for the digital port functions. For a complete description of the electrical characteristics of the digital port, refer to Appendix A.

Pin Function	Available configurable pins
Digital I/O and Digital In	Pins 1 through 7
External Trigger In/Out	Pins 1 through 7
Fault Out	Pins 1 and 2
Inhibit In	Pin 3
Output Couple	Pins 4 through 7
Common (\perp)	Pin 8

In addition to the configurable pin functions, the active signal polarity for each pin is also configurable. When **Positive** polarity is selected, a logical true signal is a voltage high at the pin. When **Negative** polarity is selected, a logical true signal is a voltage low at the pin.

Bi-directional Digital I/O

Each of the seven pins can be configured as general-purpose bi-directional digital inputs and outputs. The ground reference for the pins is Signal Common on pin 8. Bit assignments are as follows:

Pin	7	6	5	4	3	2	1
Bit weight	6 (msb)	5	4	3	2	1	0 (lsb)

The I/O pins can be used to control both relay circuits as well as digital interface circuits, as illustrated in the following figure.

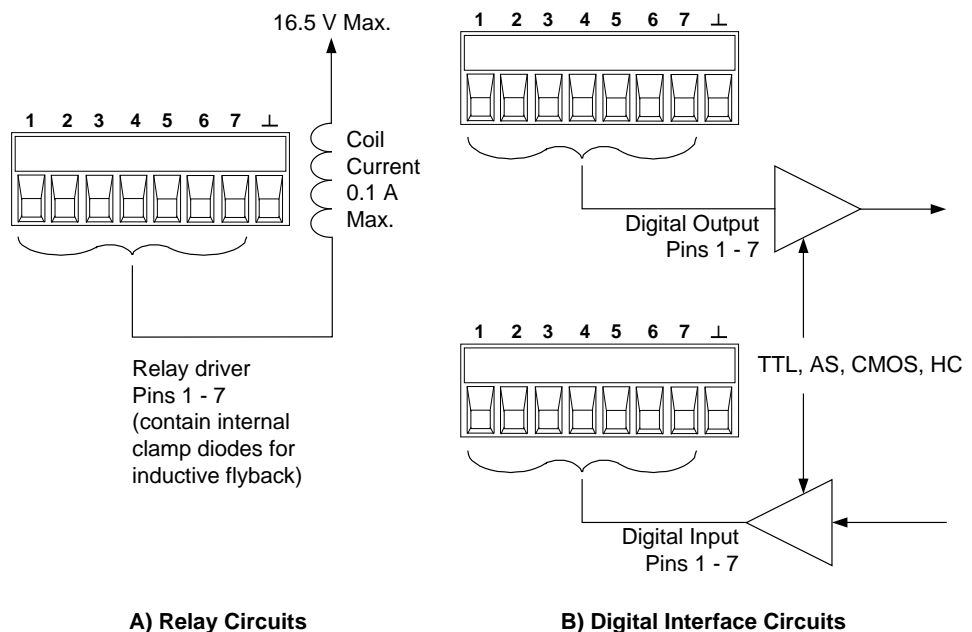

From the front panel:

To configure the bi-directional digital I/O, press the **Menu** key, scroll down and select the **Utilities** item, then select **Digital I/O**. Then press **Enter**.

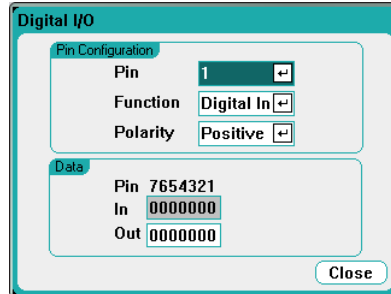

Select the pin you wish to configure from the **Pin** dropdown list.

Select the Digital I/O function from the **Function** dropdown list. Select and program the remaining pins in the same manner.

Configure the polarity for each pin by selecting the **Polarity** dropdown menu. Select either Positive or Negative. Select and program the remaining pins in the same manner.

The **Data** fields only apply to the Digital I/O and Digital In functions. Enter the binary word into the **Out** field of the Digital I/O window. The **In** field reflects the condition of the external signal that is applied to the pins.

From the remote interface:

To configure the digital I/O function for pins 1 through 4:

```
DIG:PIN1:FUNC DIO
DIG:PIN2:FUNC DIO
DIG:PIN3:FUNC DIO
DIG:PIN4:FUNC DIO
```

To configure the pin polarity to positive for pins 1 through 4:

```
DIG:PIN1:POL POS
DIG:PIN2:POL POS
DIG:PIN3:POL POS
DIG:PIN4:POL POS
```

To send a binary weighted value to configure pins 1 through 7 as “0000111”:

```
DIG:OUTP:DATA 7
```

Digital Input

Each of the seven pins can be configured as digital input only. The ground reference for the input pins is Signal Common on pin 8.

The **In** field of the Digital I/O window reflects the condition of the external signal that is applied to the pin. The pin state is not affected by the value of the binary output word.

From the front panel:

To configure the digital input function, press the **Menu** key, scroll down and select the **Utilities** item, then select **Digital I/O**. Then press **Enter**. The Digital I/O window will appear as previously shown under “Bi-directional Digital I/O”.

Select the pin you wish to configure from the **Pin** dropdown list.

Select the Digital In function from the **Function** dropdown list. Select and program the remaining pins in the same manner.

Configure the polarity for each pin by selecting the **Polarity** dropdown menu. Select either Positive or Negative. Select and program the remaining pins in the same manner.

The **Data** fields only apply to the Digital I/O and Digital In functions. The **In** field reflects the condition of the external signal that is applied to the pins.

From the remote interface:

To configure the digital input function for pin 1:

```
DIG:PIN1:FUNC DINP
```

To configure the pin polarity to positive for each pin:

```
DIG:PIN1:POL POS
```

To read the data on the digital input pins:

```
DIG:INP:DATA?
```

Fault Output

Pins 1 and 2 can be configured as a fault-output pair. The Fault Out function lets a fault condition on any output generate a fault signal on the digital port. The following conditions will generate a fault event: over-voltage, over-current, over-temperature, inhibit signal, power-fail condition, or on some models, a power-limit condition.

When this function is selected, both pins 1 and 2 are dedicated to this function. Pin 1 is the Fault output; pin 2 is common for pin 1. This provides for an optically-isolated signal. Pin 2 should be connected to the ground of your external circuit. Pin 2's selected function is ignored. The Fault output signal will remain latched until the fault condition is removed and the protection circuit is cleared (see chapter 3, “Configuring Protection Functions”).

From the front panel:

To configure the digital input function, press the **Menu** key, scroll down and select the **Utilities** item, then select **Digital I/O**. Then press **Enter**. The Digital I/O window will appear as previously shown under “Bi-directional Digital I/O”.

Select pin 1 from the **Pin** dropdown list.

Select the Fault Out function for the pin the from the **Function** dropdown list.

Configure the polarity for the pin by selecting the **Polarity** dropdown menu. Select either Positive or Negative.

From the remote interface:

To configure the Fault Out function for pin 1:

```
DIG:PIN1:FUNC FAUL
```

To configure the pin polarity to positive for pin 1:

```
DIG:PIN1:POL POS
```

Inhibit Input

Pin 3 can be configured as a remote inhibit input. The Inhibit In function lets an external input signal control the output state of all of the outputs in the mainframe. The input is level-triggered. The signal latency is 5 microseconds. Pin 8 is common for pin 3.

When an Inhibit signal turns off the outputs, the front panel **INH** indicator comes on and the INH bit is set in the Questionable Status Event register. To re-enable the outputs if the inhibit signal was latched, you must clear the protection function as explained in chapter 3.

Outputs can only be controlled by the inhibit signal if they have previously been turned on by the front panel **On** key or a remote command. If an output is turned on while the Inhibit input is true, the output will remain off.

From the front panel:

To configure the digital input function, press the **Menu** key, scroll down and select the **Utilities** item, then select **Digital I/O**. Then press **Enter**. The Digital I/O window will appear as previously shown under “Bi-directional Digital I/O”.

Select pin 3 from the **Pin** dropdown list.

Select the Inhibit In function for the pin the from the **Function** dropdown list.

Configure the polarity for the pin by selecting the **Polarity** dropdown menu. Select either Positive or Negative.

From the remote interface:

To configure the Inhibit In function for pin 3:

```
DIG:PIN3:FUNC INH
```

To configure the pin polarity to positive for pin 3:

```
DIG:PIN3:POL POS
```

Fault/Inhibit Operating Mode

After you have configured pin 3 as the remote inhibit input, you must also configure the operating mode of the inhibit signal.

From the front panel:

Press the **Settings** key to access the Source Settings window. Navigate to and select **Protection**, then **Advanced**. Then press **Enter**.

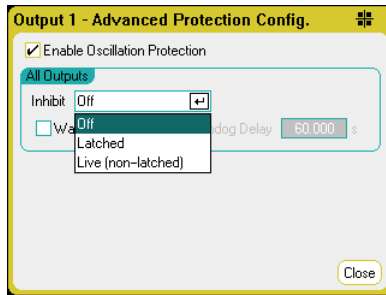

Select the **Inhibit** dropdown list. The inhibit signal can be live, latched, or off. The Inhibit mode is stored in non-volatile memory.

Inhibit Mode	Description
Live	Allows the enabled outputs to follow the state of the Inhibit input. When the Inhibit input is true, the outputs are disabled. When the Inhibit input is false, the outputs are re-enabled.
Latched	Causes a logic-true transition on the Inhibit input to disable all outputs, which will remain disabled.
Off	The Inhibit input is ignored.

From the remote interface:

To latch the Inhibit signal, send:

```
OUTP:INH:MODE LATC
```

To set the Inhibit signal live, send:

```
OUTP:INH:MODE LIVE
```

To disable the Inhibit signal, send:

```
OUTP:INH:MODE OFF
```

Fault/Inhibit System Protection

As shown in the following figure, when the Fault outputs and Inhibit inputs of several mainframes are daisy-chained, an internal fault condition in one of the mainframes will disable all of them without intervention by either the controller or external circuitry. Note that when using the Fault/Inhibit signals in this manner, both signals must be set to the same polarity.

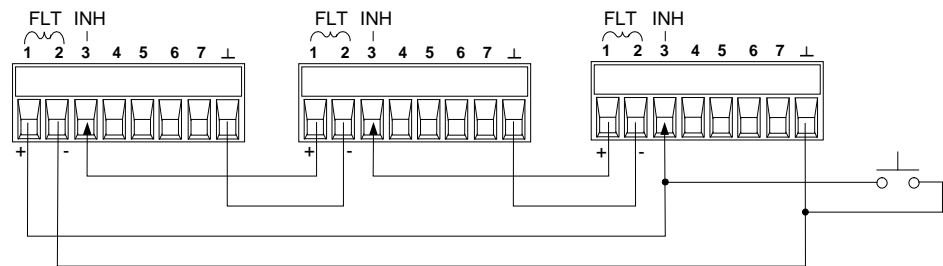

As shown in the figure above, you can also connect the Inhibit input to a manual switch or external control signal that will short the Inhibit pin to common whenever it is necessary to disable all output channels in the mainframe. Negative polarity must be programmed for all pins in this case. You can also use the Fault output to drive an external relay circuit or signal other devices whenever a user-definable fault occurs.

Clearing a System Protection Fault

To restore all instruments to a normal operating condition when a fault condition occurs in a daisy-chained system protection configuration, two fault conditions must be removed:

1. The initial protection fault or external Inhibit signal.
2. The subsequent daisy-chained fault signal (sourced by the Inhibit signal), as previously explained under "Inhibit Input".

NOTE

Even when the initial fault condition or external signal is removed, the Inhibit fault signal is still active and will continue to shut down all mainframe outputs.

To clear the daisy-chained fault signal if the operating mode of the Inhibit input is Live, simply clear the output protection on any ONE mainframe as explained in chapter 3. If the operating mode of the Inhibit input is Latched, turn off the Inhibit input on ALL mainframes individually. To re-enable the chain, re-program the Inhibit input on each mainframe to Latched mode.

Trigger Input

Any of the Digital Control pins can be programmed to function as a trigger input. All pins are referenced to the Signal Common pin.

To input an external trigger signal, you can apply either a negative-going or a positive-going pulse to the designated trigger input pin. The trigger latency is 5 microseconds. The minimum pulse width is 2 microseconds. The pin's polarity setting determines which edge generates a trigger-in event. Positive means a rising edge and Negative means a falling edge.

You can configure the scope, the data logger, and the arbitrary waveform generator to be triggered by external trigger signals. Simply select **BNC Trigger In** as the trigger source when configuring the scope, data logger, or arbitrary waveform generator (see chapters 3 and 4). This will enable input trigger signals on the configured digital pins as well as on the BNC trigger input connector. A trigger is generated when an external signal that meets the signal criteria is applied to *any* configured trigger input pin or to the BNC connector.

From the front panel:

To configure the trigger input function, press the **Menu** key, scroll down and select the **Utilities** item, then select **Digital I/O**. Then press **Enter**. The Digital I/O window will appear as previously shown under "Bi-directional Digital I/O".

Select the pin you wish to configure from the **Pin** dropdown list.

Select the Trigger In function for the pin the from the **Function** dropdown list.

Configure the polarity for the pin by selecting the **Polarity** dropdown menu. Select either Positive or Negative.

From the remote interface:

To configure the Trigger In function for the selected pin:

```
DIG:PIN<1-7>:FUNC TINP
```

To configure the pin polarity to positive for the selected pin:

```
DIG:PIN<1-7>:POL POS
```

Trigger Output

Any of the Digital Control pins can be programmed to function as a trigger output. All pins are referenced to the Signal Common pin.

When configured as a trigger output, the designated trigger pin will generate a 10-microsecond trigger pulse in response to a trigger event. The polarity setting can be either positive-going (rising edge) or negative-going (falling edge) when referenced to common.

Trigger out signals can be generated when configuring User-defined voltage or current arbitrary waveforms. If you check the **Trigger** box when configuring the User-defined arbitrary waveform (see chapter 3), an output trigger signal will be generated on the configured digital pin as well as on the BNC trigger output connector at the start of the voltage or current step.

From the front panel:

To configure the trigger input function, press the **Menu** key, scroll down and select the **Utilities** item, then select **Digital I/O**. Then press **Enter**. The Digital I/O window will appear as previously shown under “Bi-directional Digital I/O”.

Select the pin you wish to configure from the **Pin** dropdown list.

Select the Trigger Out function for the pin the from the **Function** dropdown list.

Configure the polarity for the pin by selecting the **Polarity** dropdown menu. Select either Positive or Negative.

From the remote interface:

To configure the Trigger Out function for the selected pin:

```
DIG:PIN<1-7>:FUNC TOUT
```

To configure the pin polarity to positive for the selected pin:

```
DIG:PIN<1-7>:POL POS
```

Output Couple Controls

This function lets you connect multiple Agilent N6705 mainframes together and synchronize the output on/off sequence across mainframes. Each mainframe that will be synchronized must have at least one coupled output.

1. Configure the outputs on each mainframe as described in chapter 3. Set the output coupling Mode to Manual.
2. Set the delay offset of each individual mainframe to match the *longest* delay offset of the mainframe group.
3. Connect and configure the digital connector pins of the synchronized mainframes as described in this section.

NOTE

All synchronized N6705 mainframes must have the *same* firmware revision. Only pins 4 through 7 can be configured as synchronization pins. You cannot configure more than one On Couple and one Off Couple pin per mainframe. The polarity of the pins is not programmable; it is set to Negative.

The digital connector pins of the synchronized mainframes that contain coupled outputs must be connected together as shown in the following figure. In this example, pin 6 will be configured as the output On control. Pin 7 will be configured as the output Off control. The ground or Common pins also need to be connected together.

Only *two* of the digital connector pins on each mainframe can be configured as “On Couple” and “Off Couple” on each synchronized mainframe. The designated pins will function as both an input and an output, with a negative transition on one pin providing the synchronization signal to the other pins.

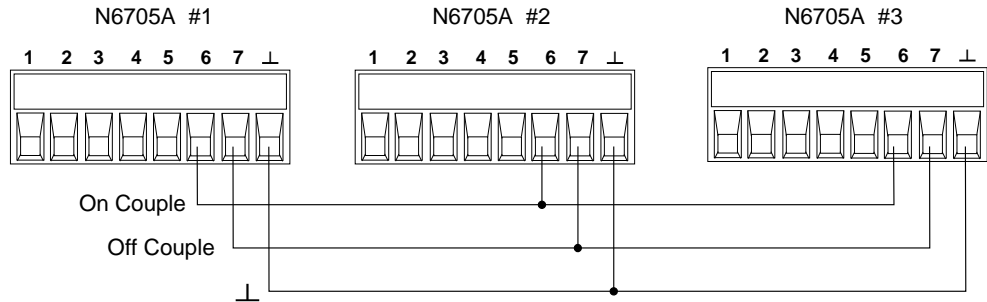

From the front panel:

To configure the digital connector pins, press the **Menu** key, scroll down and select the **Utilities** item, then select **Digital I/O**. Then press **Enter**.

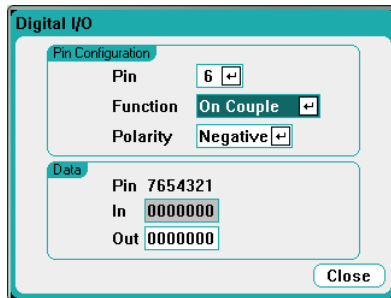

Select pin 6 from the **Pin** dropdown list. Then select the On Couple function for the pin the from the **Function** dropdown list.

Select pin 7 from the **Pin** dropdown list. Then select the Off Couple function for the pin the from the **Function** dropdown list.

Repeat these steps for mainframes #2 and #3.

From the remote interface:

To configure the On Couple function for pin 6 and the Off Couple function for pin 7:

```
DIG:PIN6:FUNC ONC
DIG:PIN7:FUNC OFFC
```

Repeat these commands for mainframes #2 and #3.:

Operation

Once configured and enabled, turning the output on or off on *any* coupled output will cause *all* coupled outputs on all configured mainframes to turn on or off according to their user-programmed delays. This applies to the front panel **On** and **Off** keys, the Web server, and to SCPI commands.

Turning the outputs on or off using the front panel **All Outputs On** and **Off** keys will cause all coupled outputs as well as non-coupled outputs *on that mainframe* to turn on or off.

Index

----- 19, 162

A

administrator password 147
 airflow 28, 32, 182
 Arb Run/Stop 100
 arbitrary waveform 75
 constant-dwell 81, 97
 exponential 95
 parameters 88
 pulse 76, 93
 ramp 90
 sequence 84, 98
 sine 81, 92
 staircase 91
 step 89
 trapezoid 94
 trigger 100
 trigger source 99
 user-defined 78, 96
 autoranging 155
 auxiliary input 46, 108
 average measurement 174

B

bandwidth 71, 161, 173
 bench location 32

C

calibration 147
 capacitor, external 42
 CC 18, 154
 delay 155
 channel groups 157
 CL- 18
 CL+ 18
 cleaning 28
 clock 146
 conformity, declaration of 2
 connections
 auxiliary DVM 17
 auxiliary input 30, 46
 digital port 45
 external trigger 17, 44
 guard 36
 high current 31

interface 47
 local sensing 37
 multiple load 37
 negative voltage 43
 parallel 40
 positive voltage 43
 power module 29
 remote sensing 37
 series 41
 constant-dwell properties 97
 continuous sampling 133
 control socket 55
 copy 142
 CP- 18, 72, 156
 CP+ 18, 72, 156
 current priority 159
 current sinking 155
 current slew 70
 CV 18, 154

D

damage 27
 data logger 119
 configure trigger 129
 filename 131
 marker view 125
 markers 131
 preset 132
 properties 127
 ranges 128
 sampling 133, 134
 standard view 123
 view 20
 data socket 55
 DCL 55
 delete 141
 DHCP server 52
 digital I/O 198
 digital input 200
 digital port 17, 198
 digitized measurements 162
 Hanning window 164
 initiate 166
 pre-trigger data 164
 returning data 167
 sample interval 163
 trigger source 165

license, software	150
live	202
load.....	139
connections	33
wire length	34, 35
wire size.....	34
lockout, front panel	146

M

mainframe, characteristics	180
measurement	
bandwidth.....	173
histogram	175
ranges	105
seamless autoranging.....	117, 128, 163, 169, 176
meter view	18, 104
model	
differences	14, 15
N673xB	14
N674xB	14
N675xA	14
N676xA	14
N677xA	14
N678xA	15
numbers.....	26
multiple load connections	37

N

N6781A	
aux connections.....	46
aux measurements	108
histogram	175
N678xA.....	196
1-quadrant.....	64
2-quadrant.....	64
4-quadrant.....	63
battery emulator/charger.....	65
CC/CV load	66
current measure.....	106
digitizing speed	113, 163
voltage measure.....	106
new folder	143
non-volatile RAM reset	148
non-volatile settings	193
normal sampling	134
notice	
legal.....	2
safety.....	3

O

OC.....	18, 72
Off	18
operating modes	154
options	26
installing	150
Osc.....	18, 72
oscillation protection	74
OT	18, 72
outline diagram	28, 182
output	
bandwidth.....	161
capacitance	161
couple.....	67, 205
groups.....	157
impedance	71
noise	39
quadrant.....	158
ranges.....	62
ratings	59
select	60
sequence	67
OV	18, 72
OV-.....	18, 72
over-current	
delay	72
protection	72
over-voltage	
local	39
negative.....	72
protection	39, 72

P

parallel outputs	157
password	147
changing	151
front panel	146
PF18, 72	
power cord	
connecting.....	33
emergency disconnect	33
power factor 400 Hz	181
power limit	70, 156
power module	
location	28
power module installation	29
power receptacle	3
power-on	

Index

settings	194
state	143
print date	2
priority mode	158
Prot.....	18, 72
protection, clear.....	72, 203
pulse properties	93

R

rack mounting	32
ramp properties.....	90
ratings.....	59
rear panel	
connectors	17
description	17
recall	143
remote interface	
securing	148
removing modules.....	29
rename.....	142
reset	143
reverse polarity	62

S

safety	3
class	28
warning.....	28
sample interval.....	163, 170
save	138
scope	109
configure trigger.....	117
horizontal.....	118
marker view	114
markers	118
preset	118
properties	116
range	117
standard view	112
waveform display knobs	115
scope view	19
SCPI	
common commands.....	193
subsystem commands	184
screen capture	140
sense	
4-wire	37, 70
local	70
open.....	39

remote	70
sensitive loads.....	43
sequencer properties	98
sine properties.....	81, 92
sockets.....	55
specifications	
characteristics	179
spreadsheet	144
SRQ.....	55
staircase properties.....	91
step properties	89
subnet mask	52
support information.....	4
switching transients.....	43
system protection	
clearing.....	72, 203

T

TCP keepalive	53
telnet	55
trademarks	2
trapezoid properties.....	94
trigger	
input.....	44, 203
output.....	44, 204
turn-on	58
delay	67
preference.....	62

U

ungroup.....	157
Unr	18
USB interface	47
user-defined	96

V

VL-	18
VL+	18
voltage priority.....	158
voltage slew.....	70

W

watchdog protection	74
Web server	
connection.....	54
Web URL's	4
WEEE directive.....	2
wire sizes	34