

Distributed by:



www.Jameco.com ♦ 1-800-831-4242

The content and copyrights of the attached material are the property of its owner.

FLUKE®

Models 175, 177, 179

True RMS Multimeters

Users Manual

October 2000 (English), Rev.2, 5/02
© 2000-2002 Fluke Corporation. All rights reserved. Printed in USA.

Lifetime Limited Warranty

Each Fluke 20, 70, 80, 170 and 180 Series DMM will be free from defects in material and workmanship for its lifetime. As used herein, "lifetime" is defined as seven years after Fluke discontinues manufacturing the product, but the warranty period shall be at least ten years from the date of purchase. This warranty does not cover fuses, disposable batteries, damage from neglect, misuse, contamination, alteration, accident or abnormal conditions of operation or handling, including failures caused by use outside of the product's specifications, or normal wear and tear of mechanical components. This warranty covers the original purchaser only and is not transferable.

For ten years from the date of purchase, this warranty also covers the LCD. Thereafter, for the lifetime of the DMM, Fluke will replace the LCD for a fee based on then current component acquisition costs.

To establish original ownership and prove date of purchase, please complete and return the registration card accompanying the product, or register your product on <http://www.fluke.com>. Fluke will, at its option, repair at no charge, replace or refund the purchase price of a defective product purchased through a Fluke authorized sales outlet and at the applicable international price. Fluke reserves the right to charge for importation costs of repair/replacement parts if the product purchased in one country is sent for repair elsewhere.

If the product is defective, contact your nearest Fluke authorized service center to obtain return authorization information, then send the product to that service center, with a description of the difficulty, postage and insurance prepaid (FOB Destination). Fluke assumes no risk for damage in transit. Fluke will pay return transportation for product repaired or replaced in-warranty. Before making any non-warranty repair, Fluke will estimate cost and obtain authorization, then invoice you for repair and return transportation.

THIS WARRANTY IS YOUR ONLY REMEDY. NO OTHER WARRANTIES, SUCH AS FITNESS FOR A PARTICULAR PURPOSE, ARE EXPRESSED OR IMPLIED. FLUKE SHALL NOT BE LIABLE FOR ANY SPECIAL, INDIRECT, INCIDENTAL OR CONSEQUENTIAL DAMAGES OR LOSSES, INCLUDING LOSS OF DATA, ARISING FROM ANY CAUSE OR THEORY. AUTHORIZED RESELLERS ARE NOT AUTHORIZED TO EXTEND ANY DIFFERENT WARRANTY ON FLUKE'S BEHALF. Since some states do not allow the exclusion or limitation of an implied warranty or of incidental or consequential damages, this limitation of liability may not apply to you. If any provision of this warranty is held invalid or unenforceable by a court or other decision-maker of competent jurisdiction, such holding will not affect the validity or enforceability of any other provision.

Fluke Corporation
P.O. Box 9090
Everett, WA 98206-9090
U.S.A.

Fluke Europe B.V.
P.O. Box 1186
5602 BD Eindhoven
The Netherlands

Visit the Fluke website at: www.fluke.com

Register your Meter at: register.fluke.com

Table of Contents















| Title | Page |
|--|------|
| Warning. Read before using the Meter:..... | ii |
| Contacting Fluke | 1 |
| "Warning" and "Caution" Statements | 1 |
| Unsafe Voltage | 1 |
| Test Lead Alert..... | 1 |
| Battery Saver ("Sleep Mode") | 2 |
| Terminals | 2 |
| Rotary Switch Positions | 2 |
| Display | 3 |
| MIN MAX AVG Recording Mode | 4 |
| Display HOLD and AutoHOLD Modes..... | 4 |
| YELLOW Button..... | 4 |
| Display Backlight (Model 177 and 179 Only)..... | 4 |
| Manual Ranging and Autoranging..... | 5 |
| Power-Up Options..... | 5 |
| Making Basic Measurements | 6 |
| Measuring AC and DC Voltage | 6 |
| Measuring Resistance..... | 6 |
| Measuring Capacitance | 6 |
| Testing for Continuity | 7 |
| Measuring Temperature (Model 179 Only)..... | 7 |
| Testing Diodes | 7 |
| Measuring AC or DC Current | 8 |
| Understanding AC Zero Input Behavior of True RMS Meters..... | 8 |
| Measuring Frequency | 9 |
| Using the Bar Graph | 9 |
| Cleaning..... | 10 |
| Testing the Fuses..... | 10 |
| Replacing the Battery and Fuses | 10 |
| Specifications..... | 11 |

⚠ Warning. Read before using the Meter:

To avoid possible electrical shock or personal injury, follow these guidelines:

- ⇒ Use the Meter only as specified in this manual or the protection provided by the Meter might be impaired.
- ⇒ Do not use the Meter or test leads if they appear damaged, or if the Meter is not operating properly. If in doubt, have the Meter serviced.
- ⇒ Always use the proper terminals, switch position, and range for measurements.
- ⇒ Verify the Meter's operation by measuring a known voltage.
- ⇒ Do not apply more than the rated voltage, as marked on the Meter, between the terminals or between any terminal and earth ground.
- ⇒ Use caution with voltages above 30 V ac rms, 42 V ac peak, or 60 V dc. These voltages pose a shock hazard.
- ⇒ Replace the battery as soon as the low battery indicator () appears to avoid false readings that can lead to electric shock and injury.
- ⇒ Disconnect circuit power and discharge all high-voltage capacitors before testing resistance, continuity, diodes, or capacitance.
- ⇒ Do not use the Meter around explosive gas or vapor.
- ⇒ When using the test leads, keep your fingers behind the finger guards.
- ⇒ Remove test leads from the Meter before opening the Meter case or battery door.

Symbols

| | | | |
|---|--|---|---|
|  | AC (Alternating Current) |  | Fuse |
|  | DC (Direct Current) |  | Conforms to European Union directives |
|  | DC/AC |  | Canadian Standards Association |
|  | Earth ground |  | Double insulated |
|  | Important Information; see manual |  | Underwriters Laboratories, Inc. Meter in accordance with IEC 61010-1. 54CJ |
|  | Battery (Low battery when shown on display.) |  | Conforms to relevant Australian standards |
|  | Inspected and licensed by TÜV (Technischer Überwachungs Verein) Product Services |  | VDE (Verband Deutscher Electroniker) |

Models 175, 177 & 179

True RMS Multimeters

The Fluke **Model 175**, **Model 177**, and **Model 179** are battery-powered, true-RMS multimeters (hereafter "the Meter") with a 6000-count, 3 3/4-digit display and a bar graph. This manual applies to all three models. All figures show the Model 179.

These meters meet CAT III and CAT IV IEC 61010 standards. The IEC 61010 safety standard defines four overvoltage categories (CAT I to IV) based on the magnitude of danger from transient impulses. CAT III meters are designed to protect against transients in fixed-equipment installations at the distribution level; CAT IV meters are designed to protect against transients from the primary supply level (overhead or underground utility service).

The Meter measures or tests the following:

- ◆ AC / DC voltage & current
- ◆ Resistance
- ◆ Voltage & frequency
- ◆ Temperature (Model 179 only)
- ◆ Diodes
- ◆ Continuity
- ◆ Capacitance

Contacting Fluke

To contact Fluke, call:

1-888-993-5853 in USA
1-800-363-5853 in Canada
+31 402-678-200 in Europe
+81-3-3434-0181 in Japan
+65-738-5655 in Singapore
+1-425-446-5500 from anywhere in the world

Visit Fluke's web site at: www.fluke.com

Register your Meter at: register.fluke.com

"Warning" and "Caution" Statements

A "**⚠Warning**" identifies hazardous conditions and actions that could cause bodily harm or death.

A "**⚠Caution**" identifies conditions and actions that could damage the Meter, the equipment under test, or cause permanent loss of data.

Unsafe Voltage

To alert you to the presence of a potentially hazardous voltage, when the Meter detects a voltage ≥ 30 V or a voltage overload (**OL**), the ⚡ symbol is displayed.

Test Lead Alert

To remind you to check that the test leads are in the correct terminals, ⚡ is momentarily displayed when you move the rotary switch to or from the **mA** or **A** position.

⚠ Warning

Attempting to make a measurement with a test lead in an incorrect terminal might blow a fuse, damage the Meter, and cause serious personal injury.

Battery Saver ("Sleep Mode")

The Meter enters the "Sleep mode" and blanks the display if there is no function change or button press for 20 minutes. To disable the Sleep mode, hold down the **YELLOW** button while turning the Meter on. The Sleep mode is always disabled in the MIN MAX AVG mode and the AutoHOLD mode.

Terminals

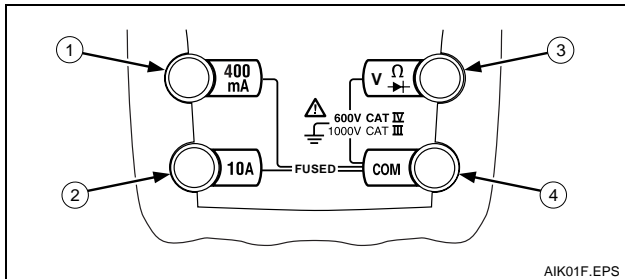

| Item | Description |
|------|---|
| 1 | Input terminal for AC and DC milliamp measurements to 400 mA (600 mA for 18 hrs) and frequency measurements. |
| 2 | Input terminal for AC and DC current measurements to 10 A (20 A for up to 30 seconds) and frequency measurements. |
| 3 | Input terminal for voltage, continuity, resistance, diode, capacitance, frequency, and temperature (Model 179 only) measurements. |
| 4 | Common (return) terminal for all measurements. |

Rotary Switch Positions

| Switch Position | Measurement Function |
|-----------------|--|
| \tilde{V} | AC voltage from 0.1 mV to 1000 V. |
| Hz | Frequency from 2 Hz to 99.99 kHz. |
| \bar{V} | DC voltage 1 mV to 1000 V. |
| Hz | Frequency from 2 Hz to 99.99 kHz. |
| $m\bar{V}$ | DC mV 0.1 mV to 600 mV dc. |
| ⌚ | Temperature - 40 °C to + 400 °C - 40 °F to + 752 °F |
| Ω | Ohms from 0.1 Ω to 50 M Ω . |
| ⌚ | Farads from 1 nF to 9999 μ F. |
| $\text{ })$ | 2-kHz beeper turns on at <25 Ω and turns off at >250 Ω . |
| ⤴ | Diode test. Displays OL above ~2.4 V. |
| $\tilde{m}A$ | AC or DC mA from 0.01 mA to 600 mA. |
| Hz | Frequency of AC mA 2 Hz to 99.99 kHz. |
| \tilde{A} | AC or DC A from 0.01 A to 10 A (20 A for 30 seconds). >10.00 display flashes. |
| Hz | >20 A, OL is displayed. Frequency of AC A to 99.99 kHz. |

Note: AC voltage and current AC-coupled, true RMS, up to 1 kHz.

Display

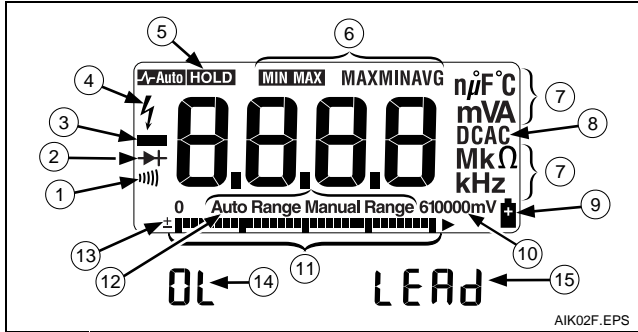

AIK02F.EPS

| No. | Symbol | Meaning |
|-----|---|---|
| 1 |) | Continuity test. |
| 2 | ▶ + | Diode test. |
| 3 | — | Negative readings. |
| 4 | ⚡ | Unsafe voltage. Voltage ≥ 30 V, or voltage overload (OL) |
| 5 | HOLD Auto HOLD | Display HOLD is enabled. Display freezes present reading. In MIN MAX AVG mode, MIN MAX AVG recording is interrupted. AutoHOLD is enabled. Display holds present reading until it detects new stable input. Then the Meter beeps and displays new reading. |
| 6 | MIN MAX MAX , MIN, AVG | MIN MAX AVG enabled. Maximum, minimum, or average reading. |

| No. | Symbol | Meaning |
|-----|--|---|
| 7 | nµ F, °F, °C mVA, MkΩ, kHz | Measurement units. |
| 8 | DC, AC | Direct current, alternating current. |
| 9 | 🔋 | Low battery. Battery voltage < 6 V \pm 0.2 V. |
| 10 | 610000mV | All possible ranges. |
| 11 | Bar graph | Analog display. |
| 12 | Auto Range Manual Range | The Meter selects the range with the best resolution. The user selects the range. |
| 13 | \pm | Bar graph polarity. |
| 14 | OL | The input out of range. |
| 15 | LEAD | ⚠ Test lead alert. Displayed when the rotary switch is moved <u>to</u> or <u>from</u> the mA or A position. |

| Error Messages | |
|-----------------|---|
| diSC | Displayed while the capacitor discharges. In Capacitance function only. |
| EEPr | Cannot read data from EEPROM. Turn power off, then on. If message remains, service Meter. |
| EEPr Err | Invalid EEPROM data. Have Meter serviced. |
| CAL Err | Invalid calibration data. Calibrate Meter. |

MIN MAX AVG Recording Mode

The MIN MAX AVG recording mode captures the minimum and maximum input values, and calculates a running average of all readings. When a new high or low is detected, the Meter beeps.

Note

For DC functions, accuracy is the specified accuracy of the measurement function ± 12 counts for changes longer than 275 ms in duration.

For AC functions, accuracy is the specified accuracy of the measurement function ± 40 counts for changes longer than 1.2 s in duration.

To use MIN MAX AVG recording:

- ⇒ Make sure that the Meter is in the desired measurement function and range. (Autoranging is disabled in the MIN MAX AVG mode.)
- ⇒ Press **MIN MAX** to activate MIN MAX AVG mode. **MIN MAX** and **MAX** light, and the highest reading detected since entering MIN MAX AVG is displayed.
- ⇒ Press **MIN MAX** to step through the low (**MIN**), average (**AVG**), and present readings.
- ⇒ To pause MIN MAX AVG recording without erasing stored values, press **HOLD**. **HOLD** is displayed.
To resume MIN MAX AVG recording, press **HOLD** again. **HOLD** turns off.
- ⇒ To exit and erase stored readings, press MIN MAX for 1 second or turn the rotary switch.

Display HOLD and AutoHOLD Modes

⚠ Warning

To avoid electric shock, do not use the Display HOLD or AutoHOLD mode to determine if a circuit is live. Unstable or noisy readings will not be captured.

In the Display HOLD mode, the Meter holds the reading on the display.

In the AutoHOLD mode, the Meter holds the reading on the display until it detects a new stable reading. Then the Meter beeps and displays the new reading.

- ⇒ Press **HOLD** to activate Display HOLD. **HOLD** lights.
- ⇒ Press **HOLD** again to activate AutoHOLD. **Auto HOLD** lights.
- ⇒ Press **HOLD** again to resume normal operation.

To resume normal operation at any time, press **HOLD** for 1 second or turn the rotary switch.

YELLOW Button

Press the **YELLOW** button to select alternate measurement functions on a rotary switch setting, e.g., to select DC mA, DC A, Hz, temperature (Model 179 only), capacitance, diode test.

Display Backlight (Model 177 and 179 Only)

Press **☉** to toggle the backlight on and off. The backlight automatically turns off after 2 minutes.

Manual Ranging and Autoranging

The Meter has both Manual range and Autorange modes.

- ⇒ In the Autorange mode, the Meter selects the range with the best resolution.
- ⇒ In the Manual Range mode, you override Autorange and select the range yourself.

When you turn the Meter on, it defaults to Autorange and **Auto Range** is displayed.

1. To enter the Manual Range mode, press **RANGE**. **Manual Range** is displayed.
2. In the Manual Range mode, press **RANGE** to increment the range. After the highest range, the Meter wraps to the lowest range.

Note

You cannot manually change the range in the MIN MAX AVG, Display HOLD, or AutoHOLD modes.





*If you press **RANGE** while in MIN MAX AVG, Display HOLD, or AutoHOLD, the Meter beeps, indicating an invalid operation, and the range does not change.*

3. To exit Manual Range, press **RANGE** for 1 second or turn the rotary switch.
The Meter returns to Autorange and **Auto Range** is displayed.

Power-Up Options

To select a Power-Up Option, hold down the button indicated while turning the Meter from OFF to any switch position.

Power-Up Options are cancelled when the Meter is turned OFF.

| Button | Power-Up Options |
|---|---|
| AutoHOLD  | Turns on all display segments. Release HOLD to turn off display; the software version number is displayed and the Meter resumes normal operation. |
|  | Disables beeper. |
|  | Enables "Smoothing" mode. Dampens display fluctuations of rapidly changing inputs by digital filtering. |
|  (YELLOW) | Disables automatic power-down ("Sleep mode"). Sleep mode is also disabled while the Meter is in a MIN MAX AVG Recording mode, or the AutoHOLD mode. |
|  | Disables automatic 2-minute backlight timeout. (Model 177 and 179 Only) |

Making Basic Measurements

The figures on the following pages show how to make basic measurements.

When connecting the test leads to the circuit or device, connect the common (**COM**) test lead before connecting the live lead; when removing the test leads, remove the live lead before removing the common test lead.

⚠ Warning

To avoid electric shock, injury, or damage to the Meter, disconnect circuit power and discharge all high-voltage capacitors before testing resistance, continuity, diodes, or capacitance.

Measuring AC and DC Voltage

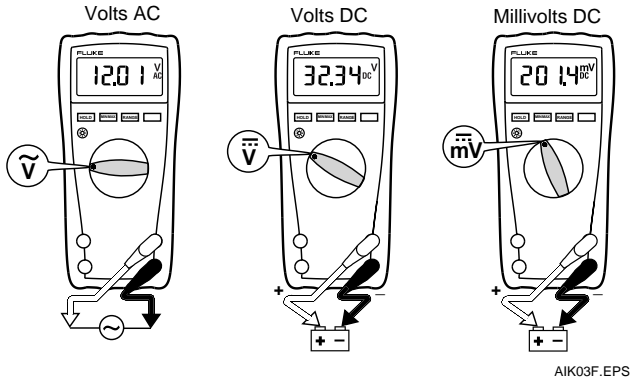

Measuring Resistance

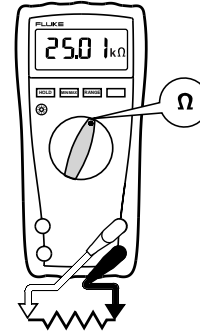

AIK04F.EPS

Measuring Capacitance

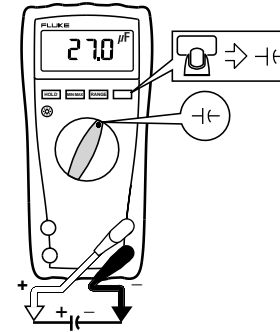

AIK05F.EPS

Testing for Continuity

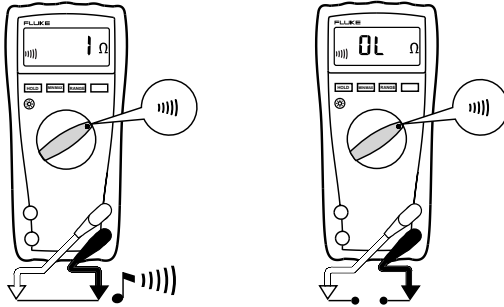

AIK06F.EPS

Measuring Temperature (Model 179 Only)

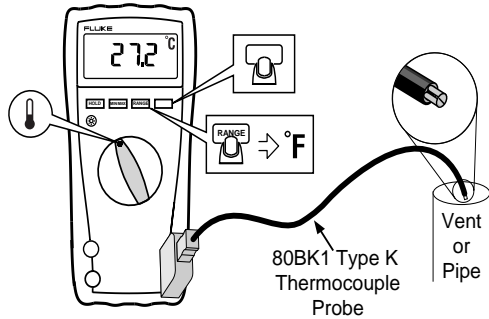

80BK1 Type K Thermocouple Probe

AIK10F.EPS

⚠ Warning: Do not connect 80BK1 to live circuits.

Testing Diodes

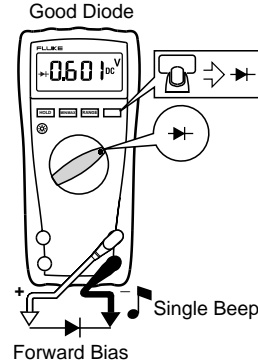

Forward Bias

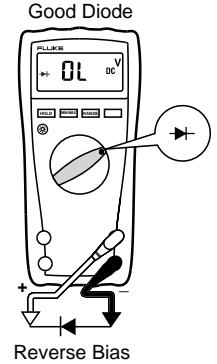

Reverse Bias

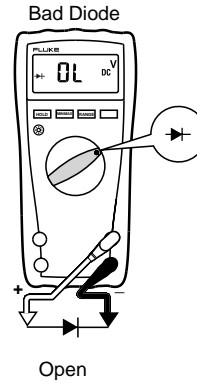

Open

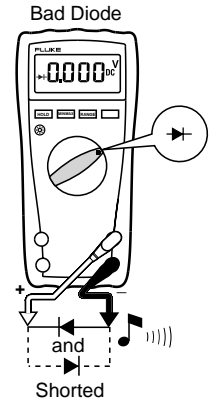

Shorted

AIK07F.EPS

Measuring AC or DC Current

⚠ Warning

To avoid personal injury or damage to the Meter:

- Never attempt to make an in-circuit current measurement when the open-circuit potential to earth is > 1000 V.
- Check the Meter's fuses before testing. (See "Testing the Fuses".)
- Use the proper terminals, switch position, and range for your measurement.
- Never place the probes in parallel with a circuit or component when the leads are plugged into the current terminals.

Turn power OFF, break circuit, insert Meter in series, turn power on.

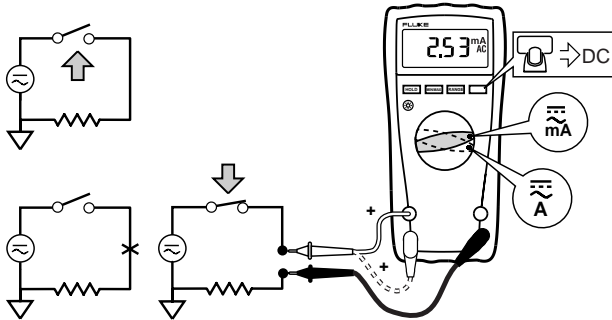

AIK08F.EPS

Understanding AC Zero Input Behavior of True RMS Meters

Unlike averaging meters, which can accurately measure only pure sinewaves, True RMS meters accurately measure distorted waveforms. Calculating True RMS converters require a certain level of input voltage to make a measurement. This is why AC voltage and current ranges are specified from 5% of range to 100% of range. Non-zero digits that are displayed on a True RMS meter when the test leads are open or are shorted are normal. They do not affect the specified AC accuracy above 5% of range.

The input levels that are unspecified are:

- AC voltage: below 5% of 600 mV AC, or 30 mV AC
- AC current: below 5% of 60 mA AC, or 3 mA AC

Measuring Frequency

⚠ Warning

To avoid electrical shock, disregard the bar graph for frequencies > 1 kHz. If the frequency of the measured signal is > 1 kHz, the bar graph is unspecified.

The Meter measures the frequency of a signal. The trigger level is 0 V, 0 A for all ranges.

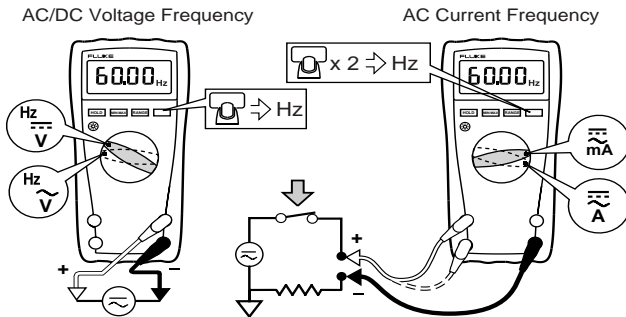

AIK09F.EPS

- ⇒ To exit frequency, press **YELLOW** button or turn the rotary switch.
- ⇒ In frequency, the bar graph shows the AC/DC voltage or AC current accurately up to 1 kHz.
- ⇒ If the Meter is in manual range mode and is not measuring frequency, try switching to the autorange mode.

Using the Bar Graph

The bar graph is like the needle on an analog Meter. It has an overload indicator (▶) to the right and a polarity indicator (±) to the left.

Because the bar graph updates about 40 times per second, which is 10 times faster than the digital display, the bar graph is useful for making peak and null adjustments and for observing rapidly changing inputs.

The bar graph is disabled when measuring capacitance or temperature. In frequency, the bar graph accurately indicates the voltage or current up to 1 kHz.

The number of lit segments indicates the measured value and is relative to the full-scale value of the selected range.

In the 60 V range, for example (see below), the major divisions on the scale represent 0, 15, 30, and 60 V. An input of -30 V lights the negative sign and the segments up to the middle of the scale.



AIK11F.EPS

Cleaning

Wipe the case with a damp cloth and mild detergent. Do not use abrasives or solvents. Dirt or moisture in the terminals can affect readings.

Testing the Fuses

⚠ Warning

To avoid electrical shock or injury, remove the test leads and any input signals before replacing the fuse.

Test fuses as shown below.

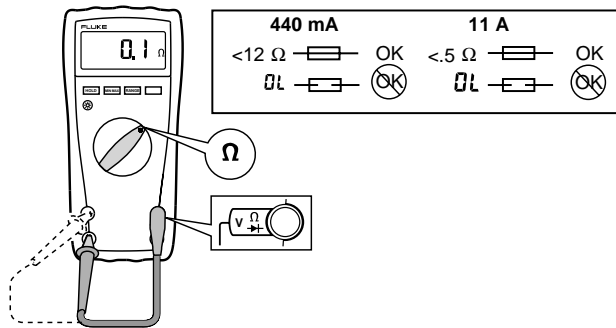

AIK12F.EPS

Replacing the Battery and Fuses

⚠ Warning

To avoid shock, injury, or damage to the Meter:

- Use **ONLY** fuses with the amperage, interrupt, voltage, and speed ratings specified.
- Replace the battery as soon as the low battery indicator () appears to avoid false readings.

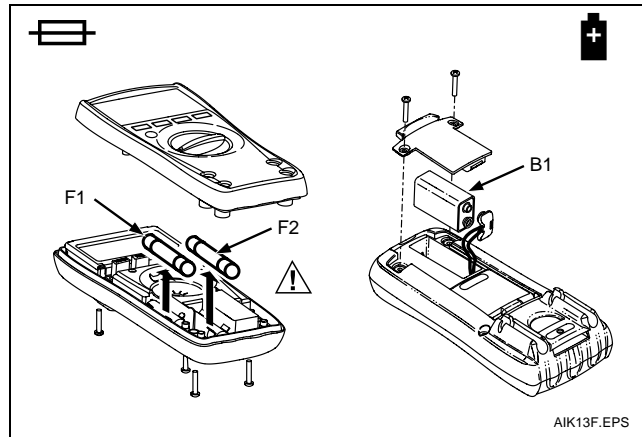

AIK13F.EPS

| | |
|---|-----------------|
| F1 Fuse, 440 mA, 1000 V, FAST | Fluke PN 943121 |
| F2 Fuse, 11 A, 1000 V, FAST | Fluke PN 803293 |
| B1 Battery, 9 V Alkaline, NEDA 1604 / 1604A | Fluke PN 614487 |

Specifications

Accuracy is specified for 1 yr after calibration, at operating temperatures of 18 °C to 28 °C, with relative humidity at 0 % to 75 %. Accuracy specifications take the form of:

$$\pm ([\% \text{ of Reading }] + [\text{ Counts }])$$

Maximum voltage between any terminal and earth ground:

1000 V DC or AC RMS

Surge Protection:

8 kV peak per IEC 61010

⚠ Fuse for mA inputs:

440 mA, 1000 V FAST Fuse

⚠ Fuse for A input:

11 A, 1000 V FAST Fuse

Display:

Digital: 6000 counts, updates 4/sec

Bar Graph: 33 segments;

Updates 40/sec

Frequency: 10,000 counts

Capacitance: 1,000 counts

Altitude:

Operating: 2000 m; Storage: 12,000 m

Temperature:

Operating: -10 °C to +50 °C;

Storage: -30 °C to +60 °C

Temperature coefficient:

0.1 X (specified accuracy / °C

(< 18 °C or > 28 °C)

Electromagnetic

Compatibility

(EN 61326-1:1997):

In an RF field of 3 V/M, accuracy = specified accuracy except in temperature: specified accuracy \pm 5 °C (9 °F)

Relative Humidity:

0 % to 90 % @ 0 °C to 35 °C;

0 % to 70 % @ 36 °C to 50 °C

Relative Humidity in

50 M Ω Range:

0 % to 80 % @ 0°C to 35°C;

0 % to 70 % @ 36 °C to 50 °C

Battery Life:

Alkaline: ~200 hrs typical

Size (H x W x L):

4.3 cm x 9 cm x 18.5 cm

Weight:

420 g

Safety Compliances:

ANSI/ISA S82.02.01, CSA C22.2-1010.1, IEC 61010 to 1000 V Overvoltage Category III, 600 V Overvoltage

Category IV

Certifications:

CSA, TÜV (EN61010), UL, CE, , VDE

Models 175, 177 & 179

Users Manual

| Function | Range ¹ | Resolution | Accuracy ± ([% of Reading] + [Counts]) | | |
|--|--|---|--|--|--|
| | | | Model 175 | Model 177 | Model 179 |
| AC Volts ^{2,3} | 600.0 mV 6.000 V 60.00 V 600.0 V 1000 V | 0.1 mV 0.001 V 0.01 V 0.1 V 1 V | 1.0 % + 3 (45 Hz to 500 Hz) 2.0 % + 3 (500 Hz to 1 kHz) | 1.0 % + 3 (45 Hz to 500 Hz) 2.0 % + 3 (500 Hz to 1 kHz) | 1.0 % + 3 (45 Hz to 500 Hz) 2.0 % + 3 (500 Hz to 1 kHz) |
| DC mV | 600.0 mV | 0.1 mV | 0.15 % + 2 | 0.09 % + 2 | 0.09 % + 2 |
| DC Volts | 6.000 V 60.00 V 600.0 V | 0.001 V 0.01 V 0.1 V | 0.15 % + 2 | 0.09 % + 2 | 0.09 % + 2 |
| | 1000 V | 1 V | | | |
| Continuity | 600 Ω | 1 Ω | Meter beeps at < 25 Ω, beeper turns off at > 250 Ω; detects opens or shorts of 250 μs or longer. | | |
| Ohms | 600.0 Ω | 0.1 Ω | 0.9 % + 2 | 0.9 % + 2 | 0.9 % + 2 |
| | 6.000 kΩ | 0.001 kΩ | 0.9 % + 1 | 0.9 % + 1 | 0.9 % + 1 |
| | 60.00 kΩ | 0.01 kΩ | 0.9 % + 1 | 0.9 % + 1 | 0.9 % + 1 |
| | 600.0 kΩ | 0.1 kΩ | 0.9 % + 1 | 0.9 % + 1 | 0.9 % + 1 |
| | 6.000 MΩ | 0.001 MΩ | 0.9 % + 1 | 0.9 % + 1 | 0.9 % + 1 |
| | 50.00 MΩ | 0.01 MΩ | 1.5 % + 3 | 1.5 % + 3 | 1.5 % + 3 |
| Diode test | 2.400 V | 0.001 V | 1 % + 2 | | |
| Capacitance | 1000 nF | 1 nF | 1.2 % + 2 | 1.2 % + 2 | 1.2 % + 2 |
| | 10.00 μF | 0.01 μF | 1.2 % + 2 | 1.2 % + 2 | 1.2 % + 2 |
| | 100.0 μF | 0.1 μF | 1.2 % + 2 | 1.2 % + 2 | 1.2 % + 2 |
| | 9999 μF ⁴ | 1 μF | 10 % typical | 10 % typical | 10 % typical |
| AC Amps ⁵ (True RMS) (45 Hz to 1 kHz) | 60.00 mA 400.0 mA (600 mA for 18 hrs) 6.000 A 10.00 A (20 A for 30 s) | 0.01 mA 0.1 mA 0.001 A 0.01 A | 1.5 % + 3 | 1.5 % + 3 | 1.5 % + 3 |

1. All AC voltage and AC current ranges are specified from 5 % of range to 100 % of range.
2. Crest factor of ≤ 3 at full scale up to 500 V, decreasing linearly to crest factor ≤ 1.5 at 1000 V.
3. For non-sinusoidal waveforms, add -(2% reading + 2% full scale) typical, for crest factors up to 3.
4. In the 9999 μF range for measurements to 1000 μF, the measurement accuracy is 1.2 % + 2 for all models.
5. Amps input burden voltage (typical): 400 mA input 2 mV/mA, 10 A input 37 mV/A.

| Function | Range ¹ | Resolution | Accuracy ± ([% of Reading] + [Counts]) | | |
|---|---|--|--|-----------|----------------------|
| | | | Model 175 | Model 177 | Model 179 |
| DC Amps ⁵ | 60.00 mA 400.0 mA (600 mA for 18 hrs) 6.000 A 10.00 A (20 A for 30 s) | 0.01 mA 0.1 mA 0.001 A 0.01 A | 1.0 % + 3 | 1.0 % + 3 | 1.0 % + 3 |
| Hz (AC- or DC- coupled, V or A ^{2,3,4} input) | 99.99 Hz 999.9 Hz 9.999 kHz 99.99 kHz | 0.01 Hz 0.1 Hz 0.001 kHz 0.01 kHz | 0.1 % + 1 | 0.1 % + 1 | 0.1 % + 1 |
| Temperature | -40 °C to +400 °C -40 °F to +752 °F | 0.1 °C 0.1 °F | NA | NA | 1 % + 10 1 % + 18 |
| MIN MAX AVG | For DC functions, accuracy is the specified accuracy of the measurement function ± 12 counts for changes longer than 275 ms in duration. For AC functions, accuracy is the specified accuracy of the measurement function ± 40 counts for changes longer than 1.2 s in duration. | | | | |
| <ol style="list-style-type: none"> All AC voltage and AC current ranges are specified from 5 % of range to 100 % of range. Frequency is specified from 2 Hz to 99.99 kHz in Volts and from 2 Hz to 30 kHz in Amps. Frequencies < 10 kHz are not specified in 600 mV AC, 60 mA AC, and 6 A AC ranges. Below 2 Hz, the display shows zero Hz. Amps input burden voltage (typical): 400 mA input 2 mV/A, 10 A input 37 mV/A. | | | | | |

| Function | Overload Protection ¹ | Input Impedance (Nominal) | Common Mode Rejection Ratio (1 kΩ Unbalanced) | | Normal Mode Rejection |
|----------------------------------|----------------------------------|--------------------------------------|---|------------|------------------------------|
| Volts AC | 1000 V RMS or DC | > 10 MΩ < 100 pF | > 60 dB @ DC, 50 or 60 Hz | | |
| Volts DC | 1000 V RMS or DC | > 10 MΩ < 100 pF | > 120 dB @ DC, 50 or 60 Hz | | > 60 dB @ 50 Hz or 60 Hz |
| | | Open Circuit Test Voltage | Full Scale Voltage To: 6.0 MΩ 50 MΩ | | Short Circuit Current |
| Ohms | 1000V RMS or DC | < 1.5 V DC | < 600 mV DC | < 1.5 V DC | < 500 μA |
| Diode test | 1000V RMS or DC | 2.4 to 3.0 V DC | 2.4 V DC | | < 1.2 mA typical |
| 1. 10 ⁷ V-Hz maximum. | | | | | |

| Frequency Counter Sensitivity | | | | | | |
|--------------------------------------|--------|--|------------------------|-------------------------|-------------------------|--------------------------|
| Input Range ^{1,2} | | Typical Sensitivity (RMS Sine Wave) | | | | |
| | | 2 Hz to 45 Hz | 45 Hz to 10 kHz | 10 kHz to 20 kHz | 20 kHz to 50 kHz | 50 kHz to 100 kHz |
| Volts AC | 600 mV | Unspecified ³ | 80 mV | 150 mV | 400 mV | Unspecified ³ |
| | 6 V | 0.5 V | 0.6 V | 1.0 V | 2.8 V | Unspecified ³ |
| | 60 V | 5 V | 3.8 V | 4.1 V | 5.6 V | 9.6 V |
| | 600 V | 50 V | 36 V | 39 V | 45 V | 58 V |
| | 1000 V | 500 V | 300 V | 320 V | 380 V | NA |
| Volts DC | 6 V | 0.5 V | 0.75 V | 1.4 V | 4.0 V | Unspecified ³ |
| | 60 V | 4 V | 3.8 V | 4.3 V | 6.6 V | 13 V |
| | 600 V | 40 V | 36 V | 39 V | 45 V | 58 V |
| | 1000 V | 500 V | 300 V | 320 V | 380 V | NA |
| AC/DC Amps | mA | 5 mA | 4 mA | 4 mA | 4 mA ⁴ | NA |
| | A | 0.5 A | 0.4 A | 0.4 A | 0.4 A ⁴ | NA |

1. Maximum input for specified accuracy = 10X Range or 1000 V.
 2. Noise at low frequency and amplitude may exceed the frequency accuracy specification.
 3. Unspecified but usable depending on quality and amplitude of signal.
 4. In mA and A ranges, frequency measurement is specified to 30 kHz.