

Anritsu Advancing beyond

Site Master™

Handheld Cable & Antenna Analyzer and Spectrum Analyzer

MS2085A

5 kHz to 4 GHz or 6 GHz
Cable and Antenna Analyzer

MS2089A

5 kHz to 4 GHz or 6 GHz
Cable and Antenna Analyzer

9 kHz to 4 GHz or 6 GHz
Spectrum Analyzer



Introduction

Anritsu is proud to introduce the next line in handheld cable and antenna analyzer and spectrum analyzer with real-time spectrum analysis. With frequency coverage up to 6 GHz, the new Site Master™ MS2085A/89A completely redefines the standards for portable handheld analyzers, setting another new industry benchmark for performance and accuracy. The new site master is the culmination of over 60 years of microwave test and measurement equipment development, using the very latest technologies to deliver accuracy and precision in measurements previously reserved only for benchtop instruments.

Cable and Antenna Analyzer Performance and Functional Highlights

- Reflection Measurements: Return Loss, Cable Loss, VSWR, Smith Chart, 1-Port Phase, TDR (Ohm/Linear), DTF Return Loss, DTF VSWR
- Transmission Measurements: Transmission (USB Sensor), 2-Port Transmission
- Calibration Methods: OSL, OSL +Trans (USB Sen), OSL + Trans (2-Port), Trans (USB Sen), Trans (2-Port), iOSL, iOSL+Trans (USB Sen), iOSL+Trans (2-Port)
- Calibration Type: Factory default 1-Port ReadyCal, OSL, InstaCal™ and FlexCal™
- Display: Single or Horizontal Split Measurement Touchscreen
- Sweep Speed: 350 μs^a /data point, fast sweep rate, typical
- Certified Line Sweeping Training
- Built-in PDF/HTML Report Generator
- Battery Life: Up to 9 hours¹
- Anritsu Remote and Report Tools (ARRT)

a.Normal dynamic range, RF immunity low. 700 μs /data point normal sweep rate, typical.

Spectrum Analyzer Performance and Functional Highlights

- Modulation Bandwidth: 20 MHz standard, 40 MHz with Option 102
- Dynamic Range: >105 dB in 1 Hz RBW
- DANL: -167 dBm, typical with preamp On
- Sweep Speed: 45 GHz/s (Option 102)
- Residual Spurious: <-120 dBm, preamp on
- 5G NR FDD/TDD FR1 Analyzer
- Real-Time Spectrum Analyzer
- LTE FDD and TDD Analyzer
- Channel Scanner
- Spectrogram
- Gated Sweep
- AM/FM Audio Demodulation
- Field Strength
- EIRP
- Occupied Bandwidth
- Channel Power
- Adjacent Channel Power
- Resolution Bandwidth (RBW): 1 Hz up to 5 MHz
- RTSA with 2.5 μs POI
- Built in Preamp Included as Standard
- Battery Life: Up to 6 hours¹
- Level Accuracy: ± 1 dB
- Signal Strength and RSSI
- Carrier Aggregation
- Coverage Mapping in SPA, 5G NR, and LTE
- Carrier-to-Interference
- WCDMA FDD Analyzer
- Trace Recording/Playback
- High Accuracy Power Measurements (external USB sensor, sold separately)
- Interference Finder
- Multi-language Support
- Built-in PDF/HTML Report Generator
- IQ Waveform Capture/Streaming
- Spectral Emissions Mask

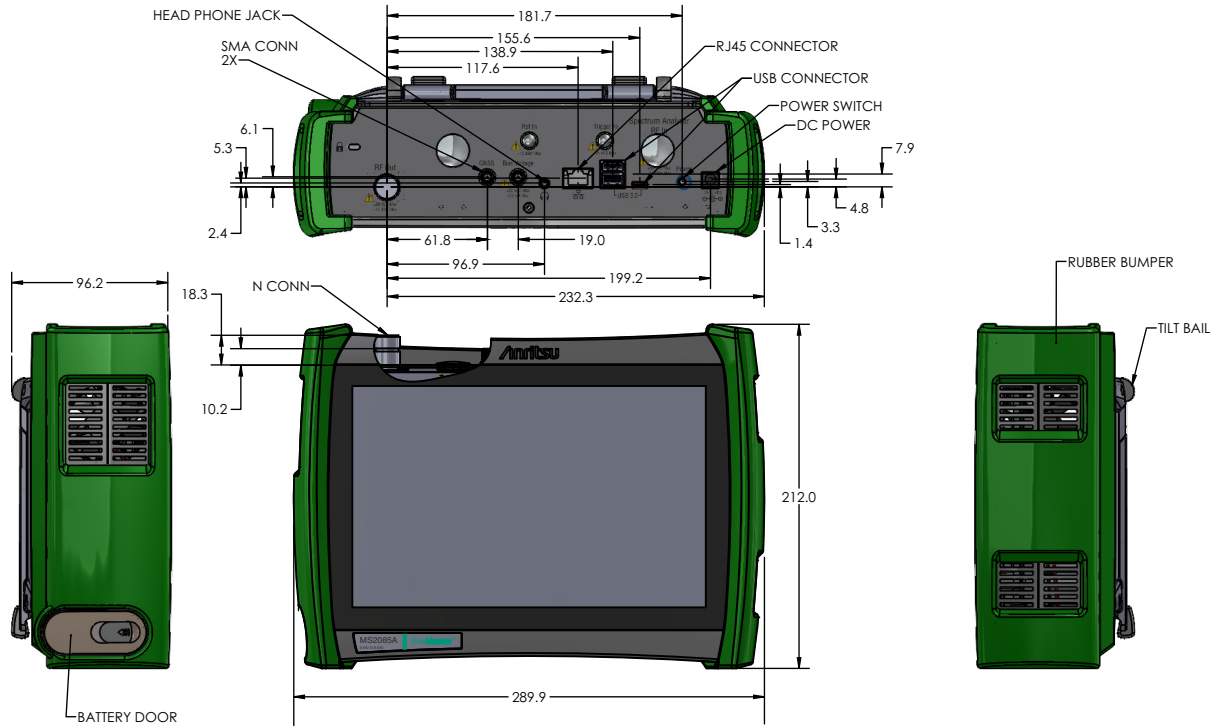

MS2085A/89A

All dimensions in mm

Table of Contents

Introduction 2

Cable and Antenna Analyzer 5

Time Domain Reflectometry (TDR) Measurement (Option 3) 6

Secure Communication (Option 17) 7

2-Port Transmission Measurement (Option 21) 7

Spectrum Analyzer Features 7

Spectrum Analyzer Performance 8

High Accuracy Power Meter (Option 19) 10

Interference Finder and AM/FM Audio Demodulation (Option 24) 10

Channel Scanner (Option 27) 11

GNSS Receiver (Option 31) 11

Gated Sweep (Option 90) 11

IQ Waveform Capture (Option 126) 12

IQ Waveform Streaming (Option 127) 12

Real-Time Spectrum Analyzer Features (Option 199) 13

Coverage Mapping (Option 431) 14

Electromagnetic Field (EMF) Measurement (Option 444) 15

AM/FM Modulation Measurement (Option 509) 15

WCDMA FDD Signal Analyzer (Option 871) 16

LTE FDD/TDD Signal Analyzer (Option 883) 17

5GNR FDD/TDD Signal Analyzer (Option 888) 19

General Specifications 20

Programmable Remote Control 21

Anritsu Remote and Report Tools (ARRT) 22

Ordering Information – MS2085A Instrument Options 23

Ordering Information – MS2089A Instrument Options 24

Standard Accessories 25

Related Manuals 25

USB Power Sensors 26

Optional Accessories 27

Definitions

Specifications	All spectrum analyzer specifications and characteristics apply under the following conditions, unless stated otherwise: <ul style="list-style-type: none"> • After 10 minutes of warm-up time, where the instrument is left in the ON state • When using the internal 10 MHz reference signal
Typical Performance	Typical specifications are not tested and are not warranted. They are generally representative of characteristic performance.
Nominal Performance	Nominal specifications are design parameters; they are not tested and are not warranted.
Calibration Cycle	Calibration is within the recommended 12 month period Note that the specifications are subject to change without notice. For the most current data sheet, please visit the Anritsu website: www.anritsu.com .

Cable and Antenna Analyzer

Smart Measurements

Return Loss	Measures the reflected power in dB
VSWR	Measures the ratio of voltage peaks to voltage valleys caused by reflections
Cable Loss	Measures the signal attenuation level of a cable
DTF Return Loss/DTF VSWR	Measures distance of the cable to facilitate precise fault location of components in a transmission line
1-Port Phase	Displays the phase of the reflection measurements at the RF port
Smith Chart	Converts the measured reflection coefficient data into complex impedance data
2-Port Transmission	Measures the power loss through a cable or device
Transmission (USB Sensor)	Measures the loss (or gain) in dB of a device or device
TDR (Ohm/Linear)	Measures the impedance against distance

Setup Parameters

Frequency/Distance	Start Frequency, Stop Frequency
Distance and DTF Setup	Start Distance, Stop Distance, Units (m/ft), Start Frequency, Stop Frequency, Point Count, Cable List, Cable Loss, Propagation Velocity
Windowing	Rectangular, Normal Side Lobe, Low Side Lobe, Minimum Side Lobe
Amplitude	Top, Bottom, Auto Scale, Full Scale
Measure	Count (1/2), Select (Trace 1/Trace 2), Display Layout (Single, Horizontal Split) with independent markers
Point Count	Flex Cal: 2 to 10,049, user defined Standard Cal: Snaps to nearest calibration point OSL Calibration: 10,049, 5025, 2513, 1257, 629, 315, 158, 65, 33, 17, 9, 5, 3 and 2 OSL + Trans (USB Sen)/Trans (USB Sen) Calibration: 1251, 626, 251, 126, 51, 26, 11, 6, 3 and 2
Sweep	Point Count, Run/Hold, Sweep Type (Single/Continuous), Sweep Rate (Normal/Fast), Sweep Once Averaging State (on/off), Sweep Averaging, Restart Averaging, RF Immunity (High/Low), Output Power (High/Low), RF In Hold (on/off), Dynamic Range (High/Normal)
Marker	Markers 1 to 8 (On/Off), Delta Markers 2 to 8 (Ref M1), Track Marker (On/Off), Marker Search (Peak/Valley), Marker Table (On/Off), Independent Markers for Frequency and Distance Measurements, To Memory (On/Off), Mode (Reference), Frequency
Limit	Upper Limit, Lower Limit, Limit Test (On/Off), Mode (Single/Segmented), Upper Level, Lower Level, Edit Segments (42 upper and 42 lower segments maximum), Alarm, Pass/Fail On/Off, Segment, Limit Table, Add Segment, Delete Segment, Clear All, X1, Y2, Segment Type (upper/lower), Y Offset
Calibration	Start/Cancel Calibration, Cal Setup, Cal Info, User Cal (On/Off), Power Sensor Method: OSL, OSL + Trans (USB Sen), OSL + Trans (Port 2), Trans (USB sen), Trans (Port 2), InstaCal ICN51A: iOSL, iOSL + Trans (USB Sen), iOSL + Trans (Port 2) Type ¹ : Standard, FlexCal™
Trace	Copy To Memory, Memory Display (Trace, Memory, Both) Math: None, Trace - Memory, Trace + Memory, (Trace + Memory)/2, Smoothing (0 to 20%)
File	Quick Save, Save As, Recall, Browse Files, PDF Report: Report Setup, Template, Report Name, Generate Report, Preview Last Report

Frequency

MS2085A/89A-0804	5 kHz to 4 GHz (Option 804)
MS2085A/89A-0806	5 kHz to 6 GHz (Option 806)
Frequency Accuracy	≤ ± 2.5 ppm (-10 °C to 55 °C) plus aging, typical Aging: ± 1.0 x 10 ⁻⁶ per year
Frequency Resolution	1 Hz

Output Power

High	0 dBm, typical
Low	-40 dBm, typical

Measurement Accuracy

Corrected Directivity	> 44 dB, typical, OSL Calibration > 40 dB, typical, InstaCal™ Calibration
-----------------------	--

Measurement Sweep Speed²

Return Loss	< 350 μs/data point, RF immunity low, typical
Distance-to-Fault	< 350 μs/data point, RF immunity low, typical

1. Factory default 1-Port ReadyCal (automatically applied to all measurements), User calibration (User Cal) overrides ReadyCal.

2. Low dynamic range and fast sweep rate. 700 μs/data point normal sweep rate, typical.

Return Loss		
Measurement Range	0 dB to 60 dB	
Resolution	0.01 dB	
VSWR		
Measurement Range	1:1 to 65:1	
Resolution	0.01	
Cable Loss		
Measurement Range	0 dB to 30 dB	
Resolution	0.01 dB	
Distance-to-Fault		
Vertical Range Return Loss	0 dB to 60 dB	
Vertical Range VSWR	1:1 to 65:1	
Fault Resolution (meters)	$(1.5 \times 10^8 \times vp) / \Delta F$ (vp = velocity propagation constant, ΔF is F2-F1 in Hz)	
Horizontal Range (meters)	0 to (Data Points-1) x Fault Resolution, to a maximum of 5000 meters (16404 ft)	
1-Port Phase		
Measurement Range	-450° to +450°	
Resolution	0.01°	
Smith Chart		
Marker Resolution	0.01 Ω , 50/75 Ω selectable	

Measurement Uncertainty

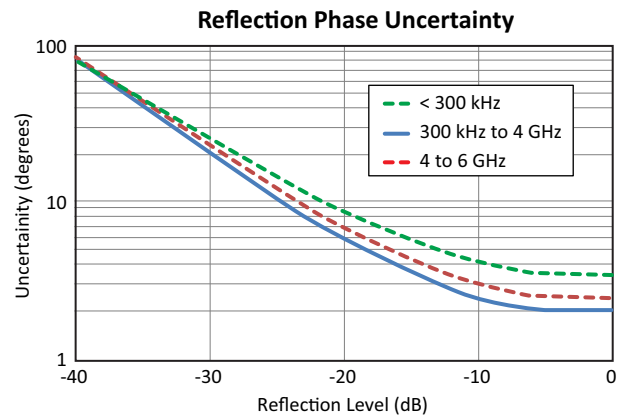
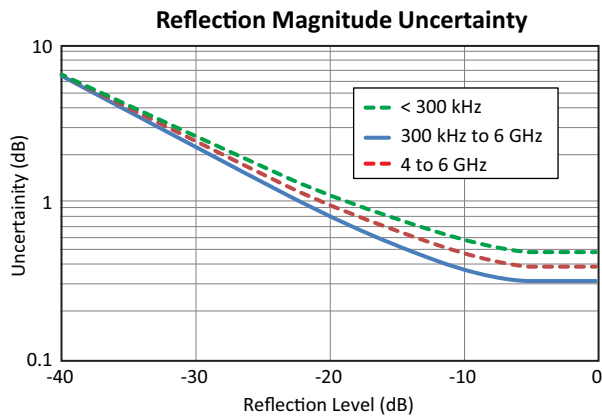

Time Domain Reflectometry (TDR) Measurement (Option 3) (Requires Option 331)

The TDR option complements the Distance-to-Fault (DTF) measurement by providing additional information about reflections in a transmission line. The resistive, capacitive and inductive component of individual reflections can be identified which provides an additional insight about the nature of the reflection. This information can be used in the identification and repair of faults in a transmission line.

Measurements

Display Layout	Single screen or split screen display including TDR/DTF, TDR/Return Loss	
Distance	5000 Meters	
Distance Units	Meters, Feet	
TDR Ohm Measurement Range	0 Ω to 5000 Ω	
Resolution	0.01 Ω	
TDR Linear Measurement Range	0 U to 500 U	
Resolution	0.01 U	

Secure Communication (Option 17)

When connecting the instrument to a network, Option 17 creates a secure tunnel. Ports will be closed, and data encrypted as shown in the table below. Security certificates can be loaded onto the instrument to establish a secure connection. Remote access to the MS2085A/89A ports can be password protected. The USBTMC connection interface does not work with instruments installed with secure communication Option 17.

PORT	SERVICE	DEFAULT STATE	WITH OPTION 17
21 (tcp)	ftp	Open	Closed
80 (tcp)	http	Open	Closed
111 (tcp)	rpcbind	Open	Open
443 (tcp)	https	Open	Open
8001 (tcp)	vcom-tunnel	Open	Closed
8002 (tcp)	vcom-tunnel	Closed	Open (encrypted)
9001 (tcp)	tor-orport	Open	Closed
9002 (tcp)	dynamid	Open	Closed
9003 (tcp)	tor-orport	Closed	Open (encrypted)
9004 (tcp)	dynamid	Closed	Open (encrypted)
24001 (tcp)	med-fsp-rx	Open	Closed
24002 (tcp)	med-fsp-rx	Closed	Open (encrypted)
111 (udp)	rpcbind	Open	Open
123 (udp)	ntp	Open	Open
5353 (udp)	Zeroconf	Open/Filtered	Open

2-Port Transmission Measurement (Option 21)

Frequency		Frequency Range	5 kHz to 4 GHz (Option 804), 5 kHz to 6 GHz (Option 806)
		Frequency Resolution	1 Hz
Output Power		High	0 dBm, typical
		Low	-40 dBm, typical
High Dynamic Range (On)		50 kHz to 3 GHz	90 dB, 105 dB typical
		3 GHz to 4 GHz	80 dB, 95 dB typical
		4 GHz to 6 GHz	70 dB, 85 dB typical

Spectrum Analyzer Features

Smart Measurements		Field Strength	Measures field strength (dBm/m ² , dBW/m ² , dBV/m, dBmV/m, dBμV/m, V/m, W/m ² , W/cm ² , A/m) with antenna gain vs. frequency plot
		Channel Power	Measures the total power and power spectral density within a specified bandwidth
		Occupied Bandwidth	Measures the 99 % to 1 % power channel of a signal
		Adjacent Channel Power	Measures the channel power of the adjacent channel
		Spectral Emission Mask	Standards based limits for wireless emissions
		Carrier-to-Interference (C/I)	Measures the ratio of power (dB) in an RF carrier to the interference power in the channel
		Burst Power Average	Measures average power between two time markers in zero span
Setup Parameters		Frequency	Center/Start/Stop Frequency, Frequency Step, Frequency Offset, Gestures
		Span	Span (Manual/Increment 1, 2, 5) Full Span, Last Span, Zero Span
		Amplitude	Reference Level (Manual/Auto and Offset), Scale/Division, Y-Axis Unit (dBm, dBW, dBV, dBmV, dBμV, dBA, V, W, A), Preamp (On/Off), Attenuation (Auto/Manual), Attenuation Level, Impedance (50 Ω, 75 Ω, other), Custom IMP Loss, Field Strength, Gestures
		Bandwidth	RBW/VBW (Auto/Manual), VBW Type (Linear/Logarithmic), RBW:VBW Ratio, SPAN:RBW Ratio
		Sweep	Continuous on/off, Restart, Sweep Once, Sweep to N, Auto/Manual Time, Points Gated Sweep (see "Gated Sweep (Option 90)" on page 11)

Spectrogram

Number of Lines	142
Trace Time/Position Cursor	Up to Six Cursors (display historical trace data by trace position or time)
Cursor State	Active, Hold/View, Blank
Color Setup	Color Scale Top/Bottom Range, Reference Hue

Trace Functions

Traces	Up to Six Traces
Trace Type	Clear/Write, Average (2 to 1000), Max Hold, Min Hold, Rolling Average, Rolling Max Hold, Rolling Min Hold
Trace Math	T1-T2, T2-T1 (when T5 and T6 are selected)
Trace Mode	Active, Hold/View, Blank
Detector Type per Trace	Peak, RMS/Avg, Negative, Sample, Normal
Trace Normalize	On/Off (defines a 0 dB reference trace)
Trace Record	Record live samples with manual tagging to internal or external storage
Trace Playback	Play recorded samples from internal or external storage; set playback interval
CSV Logging	Record live or playback traces in CSV format for post processing

Trigger Functions

Trigger Input Sources (zero span only)	Free Run, Video, External
Settings	Timestamps (on/off), Level, Time Interval, Delay, Holdoff, Periodic, Slope (Rising/Falling), Hysteresis Refer to "IQ Waveform Capture (Option 126)" on page 12 for IQ Trigger Functions

Marker Functions

Markers	Up to 12 Markers
Marker Measurements	Amplitude, Frequency (swept spectrum display) Amplitude, Time (Zero Span)
Marker Mode	Normal, Delta, Fixed
Delta Marker	Relative to any Normal or Fixed Marker
Marker Function	None, Noise, Frequency Counter (1 Hz, 100 mHz, 10 mHz, 1 mHz resolutions), Quasi-Peak (per CISPR 16-1-1)
Marker Trace	Assign Marker to any Trace
Peak Search	Peak Search, Next Peak, Next Peak Left, Next Peak Right, Next Point Left, Next Point Right
Peak Search Setup	Peak Threshold, Peak Excursion
Marker	Mkr → Center, Mkr → Ref Level
Marker Table	Up to 12 Markers Showing Marker, Mode, Function, Trace, Frequency, Amplitude, Delta Frequency & Offset

Limit Line Functions

Limit Setup	Upper/Lower, Limit On/Off, Limit Alarm On/Off, Set Default Limit Line, Frequency Mode (Absolute/Relative) Amplitude Mode (Absolute/Relative)
Limit Line Edit	Frequency, Relative Frequency, Amplitude, Relative Amplitude, Add Point, Add Vertical, Add Gap, Delete Point, Next Point Left/Right
Limit Line Move	Center, X-Offset (Hz), Left, Right, Y-Offset, Up, Down, To Marker 1, Marker 1 Offset (dB)
Limit Line Envelope	Select Envelope (Upper/Lower), Set Envelope, Envelope Points (2-41), Amplitude Offset, Shape (Square/Slope)

Spectrum Analyzer Performance

Frequency (usable to 0 Hz)

MS2089A-0704	9 kHz to 4 GHz (Option 704)
MS2089A-0706	9 kHz to 6 GHz (Option 706)
Tuning Resolution	1 Hz
Span	10 Hz to max frequency, Zero Span
Frequency Reference	Internal, GNSS, External
Internal Frequency Reference	Standard TCXO: Aging: $\pm 1.0 \times 10^{-6}$ per year Accuracy: $\pm 2.8 \times 10^{-7}$ (-10°C $\pm 55^\circ\text{C}$) plus aging (see "GNSS Receiver (Option 31)" on page 11 for improved accuracy)
External Frequency Reference	10 MHz, -10 dBm to +10 dBm

Bandwidth

Analysis Bandwidth	20 MHz (standard), 40 MHz (Option 102)
RTSA Bandwidth	20 MHz (standard), 40 MHz (Option 102)
Resolution Bandwidth (RBW)	1 Hz to 5 MHz, 1 Hz to 10 MHz in zero span (standard), 1 Hz to 20 MHz in zero span (Option 102)
RBW Selectivity	4:1 nominal (-60 dB / -3 dB)
Video Bandwidth (VBW)	0.1 Hz to 5 MHz, 1 Hz to 10 MHz in zero span (standard), 1 Hz to 20 MHz in zero span (Option 102)
CISPR Bandwidth	Resolution bandwidth when using Quasi-Peak marker function: 200 Hz, 9 kHz, and 120 kHz
VBW/Average Type	Linear/Log

Sweep

Manual Sweep	Maximum sweep time is 3600 s (1 hour)
Sweep Points	10 to 10,001 (1001 in zero span)
Sweep Rate (non-zero span)	32 GHz/s (standard), 45 GHz/s (Option 102)

Zero Span

Sweep Time	60 ns to 3600 s in zero span
Sweep Time Accuracy	±2 % in zero span

Spectral Purity – SSB Phase Noise

Offset from 1 GHz RF Input	Maximum	Typical
10 kHz	-93 dBc/Hz	-94 dBc/Hz
100 kHz	-95 dBc/Hz	-97 dBc/Hz
1 MHz	-120 dBc/Hz	-123 dBc/Hz

Spurs

Residual Spurious	< -120 dBm (RF input terminated, 0 dB input attenuation, > 20 MHz, preamp On) < -105 dBm (RF input terminated, 0 dB input attenuation, > 20 MHz preamp Off)
Input-Related Spurious	< -70 dBc (0 dB attenuation, -30 dBm input)
Exceptions, typical	< -68 dBc @ 700 MHz to 3300 MHz with 2086 MHz Input < -65 dBc @ 2*(F1 -1484) MHz, where 3140 MHz < F1 < 3580 MHz < -68 dBc @ F1 - 2086 MHz where 2100 MHz < F1 < 4970 MHz
Local-Oscillator Related Spurious	< -60 dBc nominal for offsets > 1 MHz

Amplitude Ranges

Dynamic Range	105 dB typical at 1 GHz, 2/3 (TOI-DANL) in 1 Hz RBW
Measurement Range	DANL to +30 dBm
Display Range	1 to 15 dB/div in 1 dB steps, ten divisions displayed
Reference Level Range	-150 dBm to +30 dBm
Attenuator Resolution	0 to 50 dB, 5 dB steps
Reference Level Offset	99.9 dB external loss to 99.9 dB external gain
Maximum Continuous Input	+30 dBm CW, ±50 VDC (≥ 10 dB attenuation) +23 dBm CW, ±50 VDC (< 10 dB attenuation) +10 dBm CW, ±50 VDC (preamp ON)
Damage Level	5 W (+37 dBm) to 6 GHz

Amplitude Accuracy (≥10 dB attenuation, -50 dBm ≤ input signal ≤ -10 dBm, 1 kHz RBW, auto-coupled, excluding effects of VSWR, noise, and spurs. Values below 100 kHz are with preamp off)

	20°C to 30°C (after 30 minute warm-up)		-10°C to 55°C (after 60 minute warm-up)	
Frequency Range	Maximum	Typical	Maximum	Typical
9 kHz to 6 GHz	±1.0 dB	±0.5 dB	±2.0 dB	±0.5 dB

Displayed Average Noise Level (DANL) (RMS detection, VBW/Avg type = Log, reference level = -20 dBm for preamp Off and -50 dBm for preamp On, auto attenuation On, normalized to 1 Hz RBW)

	Preamp On		Preamp Off	
Frequency Range	Maximum	Typical	Maximum	Typical
10 MHz to 2 GHz	-161 dBm	-167 dBm	-142 dBm	-150 dBm
> 2 GHz to 4 GHz	-160 dBm	-165 dBm	-140 dBm	-146 dBm
> 4 GHz to 5 GHz	-157 dBm	-162 dBm	-137 dBm	-144 dBm
> 5 GHz to 6 GHz	-152 dBm	-160 dBm	-133 dBm	-142 dBm

Third-Order Intercept (TOI) (-20 dBm tones 100 kHz apart, 0 dB input attenuation, preamp Off, reference level -20 dBm)

1 GHz	+7 dBm, Typical
2 GHz	+11 dBm, Typical
3 GHz	+14 dBm, Typical
4 GHz	+13 dBm, Typical
5 GHz	+15 dBm, Typical
6 GHz	+17 dBm, Typical

Second Harmonic Distortion (0 dB input attenuation, -30 dBm input, preamp Off)

50 MHz	-65 dBc maximum
> 50 MHz to 3 GHz	-70 dBc, typical

VSWR (≥ 10 dB input attenuation)

9 kHz to 2.0 GHz	1.5:1 typical
2 GHz to 6.0 GHz	1.8:1 typical

High Accuracy Power Meter (Option 19) (requires external USB power sensor, sold separately)

Amplitude Setup	Maximum Display, Minimum Display, External Gain, External Loss, Relative Power On/Off, Units (dBm, W) # of Running Averages, Max Hold, Measuring Mode (Continuous/Single), Run/Hold, Single, Aperture, Sensor Info			
Zero/Cal Limits	Zero, Cal Frequency, Signal Standard Limit On/Off, Upper/Lower Limit, Alarm On/Off			
Power Sensor Model	MA24106A	MA24108A/18A/26A	MA24208A/18A	MA24330A/40A/50A
Description	High Accuracy RF Power Sensor	Microwave USB Power Sensor	Microwave Universal USB Power Sensor	Microwave CW USB Power Sensor
Frequency Range	50 MHz to 6 GHz	10 MHz to 8/18/26 GHz	10 MHz to 8/18 GHz	10 MHz to 33/40/50 GHz
Connector	Type N(m), 50 Ω	Type N(m), 50 Ω (8/18 GHz) Type K(m), 50 Ω (26 GHz)	Type N(m), 50 Ω	Type K(m), 50 Ω (33/40 GHz) Type V(m), 50 Ω (50 GHz)
Dynamic Range	-40 dBm to +23 dBm (0.1 μW to 200 mW)	-40 dBm to +20 dBm (0.1 μW to 100 mW)	-60 dBm to +20 dBm (1 nW to 100 mW)	-70 dBm to +20 dBm (0.1 nW to 100 mW)
Measurand	True-RMS	True-RMS, Slot Power, Burst Average Power	True-RMS, Slot Power, Burst Average Power	Average Power
Measurement Uncertainty	± 0.16 dB ^a	± 0.18 dB ^b	± 0.17 dB ^c	± 0.17 dB ^d
Data sheet (for complete specifications)	11410-00424	11410-00504	11410-00841	11410-00906
Notes:	<p>a. Total RSS measurement uncertainty (0 °C to 50 °C) for power measurements of a CW signal greater than -20 dBm with zero mismatch errors.</p> <p>b. Expanded uncertainty with K=2 for power measurements of a CW signal greater than -20 dBm with zero mismatch errors.</p> <p>c. Power uncertainty expressed with two sigma confidence level for CW measurement after zero operation. Includes calibration factor and linearity over temperature uncertainties, but not the effects of mismatch, zero set and drift, or noise.</p> <p>d. Includes linearity over temperature uncertainties, but not the effects of calibration factor, mismatch, zero set and drift, and noise.</p>			

Interference Finder and AM/FM Audio Demodulation (Option 24) (Spectrum Analyzer, RTSA, requires GNSS Receiver (Option 31))

Supported Measurements

- Interference Finding Audio Tone
- AM/FM Audio Demodulation
- Interference Triangulation Mapping (Requires MA2700A)
- Interference Polar Plot (Requires MA2700A)

Interference Finder Audio Tone (for use with directional antennas, sold separately)

- Setup Integration Bandwidth, Power Limit, MAX/MIN Level, Mute on/off, Volume
- Audio Tone 20 Hz to 207 kHz (Tone pitch and volume changes with detected signal strength)

AM/FM Audio Demodulation

- Demod Frequency Full range of instrument
- Audio Demodulation AM, USB, LSB, Wideband FM, Narrowband FM (6.25, 12.5, 25 kHz)
- Demod Marker On/Off
- Markers Selectable demodulation marker (1 to 12)
- Audio Toggle On/Off
- Volume Set 0% to 100%
- Record Audio Record audio up to 100,000 s (dependent on instrument memory)
- Squelch Level -120 dBm to +30 dBm (set RF level threshold to break audio silence, supports log and linear units)

Interference Map Triangulation (for use with InterferenceHunter handle and directional antenna, sold separately)

- Triangulation Triangulates on source of interference location using eCompass and digital maps displayed on screen
- Manual Setup Manual entry of compass bearing values for signals above 6 GHz

Interference Polar Plot (for use with InterferenceHunter handle and directional antenna, sold separately)

- Signal Strength Radar Plot 360° radar plot of single frequency signal strength centered on current GNSS location

Channel Scanner (Option 27)

Number of Channels	1 to 60
Frequency Range	9 kHz to 4/6 GHz (MS2089A)
Frequency Accuracy	$\pm 2.8 \times 10^{-7}$
Measurement Range	-160 dBm to +30 dBm
Amplitude	Reference Level (Manual/Auto and Offset), Scale/Division, Preamp (On/Off), Attenuation (Auto/Manual), Y-Axis Unit (dBm, dBW, dBV, dBmV, dBμV, dBA, V, W, A), Attenuation Level, Impedance (50 Ω, 75 Ω, other), Custom IMP Loss, Field Strength
Scan	Continuous (on/off), Scan Once
Measure	View: Channel Power in Bar Chart or Strip Chart format
Setup Parameters	Add Channels Signal Standard: Start Channel, Channel Step Size, Channel Span, Channel Count, Index, Dwell Time, Upper Limit, Lower Limit Frequency Range: Channel Name, Start Frequency, Channel Spacing, Channel Span, Channel Count, Index, Dwell Time, Upper Limit, Lower Limit Custom: Channel Name, Center Frequency, Channel Span, Index, Dwell Time, Upper Limit, Lower Limit

GNSS Receiver (Option 31) (Requires GNSS antenna, sold separately)

Supported Satellite Systems	GNSS (includes combinations of GPS, GLONASS, Galileo, BeiDou)
Setup	On/Off, Antenna Voltage 3.3 V/5.0 V, GPS/GNSS Info
GNSS Time/Location Indicator	UTC Time, Latitude, Longitude, and Altitude on display (UTC Time and Altitude on GNSS Info display)
High Frequency Accuracy	$< \pm 2.5 \times 10^{-8}$ with GNSS On, 3 minutes after satellite lock in selected mode (GNSS antenna connected)
Connector	SMA, female

Gated Sweep (Option 90)

Gate Source	GNSS (GPS), External
Trigger Slope	Rising/Falling
Frame Time	1 s, 20 ms, 10 ms
Gate Delay	Up to 200 ms
Gate Length	1 μs up to 200 ms
Power vs. Time, Display Length	100 μs to 200 ms

IQ Waveform Capture (Option 126)

(Option 126 is non-export controlled and limits bit depth to 8 or 10 bits when bandwidth is 40 MHz)

IQ Capture

Mode	Spectrum Analyzer, RTSA
Capture Mode	Single, Continuous, Streaming
Capture Settings	Capture Length, Time Stamps (on/off), Save to File (Automatic/Normal), Save Capture, File Name Prefix Capture Signing (on/off), Storage Device (Internal/USB)
Trigger Source	Free Run, External, Video
Trigger Settings	Time Stamps (on/off), Level, Delay (negative in RTSA mode only), Time Interval, Slope (Rising/Falling), Hysteresis
Maximum Sample Rate ^a	50 MHz
Maximum Signal Bandwidth ^a	40 MHz
Bit Resolution	8, 10, 16, or 32-bit
Total Capture Memory	2 GB

IQ Capture Time Typical Maximum

Signal Bandwidth (MHz)	IQ Sample Rate (MSPS)	IQ Bit Resolution				Mode ^a	
		32 bit	16 bit	10 bit	8 bit	SPA	RTSA
40	50	5.37 s	10.74 s	17.18 s	21.47 s	x	x
36	46.08	5.83 s	11.65 s	18.64 s	23.3 s	x	
25	30.72	8.74 s	17.48 s	27.96 s	34.95 s	x	
20	25	10.74 s	21.47 s	34.36 s	42.95 s	x	x
18	23.04	11.65 s	23.30 s	37.28 s	46.6 s	x	
12	15.36	17.48 s	34.95 s	55.92 s	1.17 min	x	
10	12.5	21.47 s	42.95 s	1.15 min	1.43 min	x	x
6	7.68	34.95 s	1.17 min	1.86 min	2.33 min	x	
5	6.25	42.95 s	1.43 min	2.29 min	2.86 min	x	x
3	3.84	1.17 min	2.33 min	3.73 min	4.66 min	x	
2.5	3.125	1.43 min	2.86 min	4.58 min	5.73 min	x	x
1.5	1.92	2.33 min	4.66 min	7.46 min	9.32 min	x	
1.25	1.5625	2.86 min	5.73 min	9.16 min	11.45 min	x	x
0.28	0.36	12.43 min	24.86 min	39.77 min	49.71 min	x	
0.036	0.045	99.42 min	198.84 min	318.15 min	397.68 min	x	

a. Option Dependent: Standard Analysis Bandwidth up to 20 MHz, Option 102 up to 40 MHz.

IQ Waveform Streaming (Option 127) (requires Option 126; Option 127 is non-export controlled and limits streams to 40 MHz BW or less.)

Bit Resolution	8, 10, 16, or 32-bit
Ethernet Port	Maximum gapless bandwidth depends on network transfer speed
USB Port	Requires USB 3.0 solid state drive. Device formatted as external file system (ext4). Maximum gapless streaming bandwidth: 8 bit: 40 MHz BW, 50 MSPS sample rate 10 bit: 40 MHz BW, 50 MSPS sample rate 16 bit: 40 MHz BW, 50 MSPS sample rate 32 bit: 25 MHz BW, 30.72 MSPS sample rate Device formatted as extensible file allocation table system (exFAT) with 32 MB allocation unit size. Maximum gapless streaming bandwidth: 8 bit: 40 MHz BW, 50 MSPS sample rate 10 bit: 40 MHz BW, 50 MSPS sample rate 16 bit: 40 MHz BW, 50 MSPS sample rate 32 bit: 25 MHz BW, 30.72 MSPS sample rate

Real-Time Spectrum Analyzer Features (Option 199)

Setup Parameters

Frequency	Center/Start/Stop, Frequency Step, Frequency Offset Gestures (Drag Center Frequency (on/off), Pinch Span (on/off))				
Span	Span, Full Span (max span: 20 MHz standard, 40 MHz with Option 102)				
Amplitude	Reference Level (Manual/Auto and Offset), Scale/Division, Y-Axis Unit (dBm, dBW, dBV, dBmV, dBμV, dBA), Preamp (on/off), Attenuation (Auto/Manual), Gestures (Drag Ref Level (on/off))				
Bandwidth	RBW (span dependent), Auto RBW, Span/RBW Ratio (1-100000)				
Probability of Intercept	Analysis Bandwidth	Density Resolution	Span	RBW	POI
	20 MHz (Standard)	Normal High	20 MHz 20 MHz	3 MHz 3 MHz	3.036 μs 4.929 μs
	40 MHz (Option 102)	Normal	40 MHz	5 MHz	2.464 μs
		High	40 MHz	5 MHz	4.357 μs
Density Color	Set Color Top/Bottom Range, Auto Scale				
Persistence	Infinite or Variable from 0 to 10 s				
Acquisition Time	50 ms to 5 s				
FFT Rate	527,000 FFT/s (normal resolution), 263,000 FFT/s (high resolution)				
Minimum Detectable Signal	9 ns				

Sweep Functions

Sweep	Continuous (on/off), Sweep Once
-------	---------------------------------

Trace Functions

Traces	Up to Six Traces
Trace Type	Clear/Write, Average (2 to 1000), Max Hold, Min Hold, Rolling Average, Rolling Max Hold, Rolling Min Hold
Trace Mode	Active, Hold/View, Blank
Detector Type per Trace	Peak, Sample, Negative, Normal
Trace Record	Record live samples with manual tagging to internal or external storage (only applies to trace and not for spectral density graphic)
Trace Playback	Play recorded samples from internal or external storage; set playback interval (only applies to trace and not for spectral density graphic)
CSV Logging	Record live or playback traces in CSV format for post processing

Spectrogram

Number of Lines	142
Trace Time/Position Cursor	Up to Six Cursors (display historical trace data by trace position or time)
Cursor State	Active, Hold/View, Blank
Color Setup	Set Color Top/Bottom Range, Set Color Reference Hue

Marker Functions

Markers	Up to 12 Markers
Marker Measurements	Power, Frequency, Time (Spectrogram)
Marker Mode	Normal, Delta, Fixed
Delta Reference Marker	Relative to any Normal or Fixed Marker
Marker Function	None, Noise
Marker Trace	Assign Marker to any Trace
Peak Search	Peak Search, Next Peak, Next Peak Left, Next Peak Right, Next Point Left, Next Point Right
Peak Search Setup	Peak Threshold, Peak Excursion
Marker →	Mkr → Center, Mkr → Ref Level
Marker Table	On/Off, up to 12 Markers Showing Marker Mode, Function, Trace, Frequency, Amplitude, Delta Frequency & Offset

Limit Line Functions

Limit Setup	Upper/Lower, Limit On/Off, Limit Alarm On/Off, Set Default Limit Line, Frequency Mode (Absolute/Relative), Amplitude Mode (Absolute/Relative)
Limit Line Edit	Frequency, Amplitude, Add Point, Add Vertical, Add Gap, Delete Point, Next Point Left/Right
Limit Line Move	Center, X-Offset, Left, Right, Y-offset, Up, Down, Marker Offset, To Marker 1
Limit Line Envelope	Select Envelope (Upper/Lower), Envelope Points (41 max), Amplitude Offset, Shape (Square/Slope) Set Envelope

Trigger Functions

Trigger Input Sources (zero span only)	Free Run, Video, External 1/2
Settings	Timestamps (on/off), Level, Time Interval, Delay, Holdoff, Periodic, Slope (Rising/Falling), Hysteresis Refer to "IQ Waveform Capture (Option 126)" on page 12 for IQ Trigger Functions

Coverage Mapping (Option 431) (Spectrum Analyzer, 5GNR, LTE measurements) (Requires Option 31)

Spectrum Analyzer Measurements

Channel Power	Plots channel power in dBm, dBW, dBV, dBmV, dBμV, dBA, V, W, A
Spectral Density	Plots spectral density in dBm/Hz, dBW/Hz, dBV/Hz, dBmV/Hz, dBμV/Hz, dBA/Hz, V/Hz, W/Hz, A/Hz
RSSI	Plots received signal strength indicator in dBm, dBW, dBV, dBmV, dBμV, dBA, V, W, A
Field Strength	Plots field strength in dBm/m ² , dBW/m ² , dBV/m, dBmV/m, dBμV/m, dBA/m, V/m, W/m ² , W/cm ² , A/m ²
Power Flux Density	Plots power flux density in dBm/m ² /Hz, dBW/m ² /Hz, dBV/m/Hz, dBmV/m/Hz, dBμV/m/Hz, dBA/m/Hz, V/m/Hz, W/m ² /Hz, W/cm ² /Hz, A/m/Hz

Spectrum Analyzer Measurement Setup

Map Type	Indoor: PNG or JPEG Outdoor: OpenStreetMap® (downloaded direct from Internet to instrument or using external PC software)
Frequency (Excluding RSSI)	Center/Start/Stop, Frequency Step, Frequency Offset
Span (Excluding RSSI)	Span (Manual/Increment 1, 2, 5), Full Span, Last Span, Zero Span
Amplitude	Reference Level (Manual/Auto and Offset), Scale/Division, Y-Axis Unit, Preamp (on/off), Attenuation (Auto/Manual), Field Strength, Impedance (50 Ω, 75 Ω, other), Custom IMP Loss
Bandwidth	RBW/VBW (Auto/Manual), VBW Type (Linear/Logarithmic), RBW:VBW Ratio, SPAN:RBW Ratio
Mapping Colors	Customizable Amplitude Range Thresholds for Each Color Blue (Excellent), Green (Very Good), Yellow (Good), Orange (Fair), Pink (Poor)
Point Distance or Time Setup	Repeat Type: Time (1 s to 60 s) or Distance (1 m to 10,000 m), Distance Units: Meters or Feet
Save	Indoor: Setup, Measurement File (fmspa), PNG Outdoor: Setup, KML Points, PNG, Tab Delimited
Recall	Setup, KML Points File, Measurement File (fmspa)

LTE Measurements (Option 883 is required (see [“LTE FDD/TDD Signal Analyzer \(Option 883\)” on page 17](#)))

Channel Power	Plots channel power in dBm, dBW, dBV, dBmV, dBμV, dBA
Spectral Density	Plots spectral density in dBm/Hz, dBW/Hz, dBV/Hz, dBmV/Hz, dBμV/Hz, dBA/Hz
RSRP	Plots received signal strength indicator in dBm, dBW, dBV, dBmV, dBμV, dBA
RSRQ	Plots received signal strength indicator in dB
SINR	Plots received signal strength indicator in dB

LTE Measurement Setup

Map Type	Indoor: PNG or JPEG Outdoor: OpenStreetMap® (downloaded direct from Internet to instrument or using external PC software)
Frequency	Center Frequency, Channel Bandwidth, EARFCN, Signal Standard
Amplitude	Auto Range (On/Off), Reference Level (Manual/Auto and Offset), Scale/Division, Y-Axis Unit, Preamp (on/off), Attenuation (Auto/Manual)
Bandwidth	RBW/VBW (Auto/Manual), VBW Type (Linear/Logarithmic), RBW:VBW Ratio, SPAN:RBW Ratio
Mapping Colors	Customizable Amplitude Range Thresholds for Each Color Channel Power and Spectral Density: Blue (Excellent), Green (Very Good), Yellow (Good), Orange (Fair), Pink (Poor) RSRP, RSRQ, SINR: Blue (Excellent), Green (Good), Yellow (Poor), Pink (Bad), Gray (No Sync)
Point Distance or Time Setup	Repeat Type: Time (1 s to 60 s) or Distance (1 m to 10,000 m), Distance Units: Meters or Feet
Map Source	Any PCI, Defined PCI, Available PCI Filter, Manual PCI Filter
Save	Indoor: Setup, Measurement File (fmlte), PNG Outdoor: Setup, KML Points, CSV, PNG,
Recall	Setup, KML Points File

5GNR Measurement (Option 888 is required (see [“5GNR FDD/TDD Signal Analyzer \(Option 888\)” on page 19](#)))

Channel Power	Plots channel power in dBm, dBW, dBV, dBmV, dBμV, dBA
Spectral Density	Plots spectral density in dBm/Hz, dBW/Hz, dBV/Hz, dBmV/Hz, dBμV/Hz, dBA/Hz
SS-RSRP	Plots received signal strength indicator in dBm, dBW, dBV, dBmV, dBμV, dBA
SS-RSRQ	Plots received signal strength indicator in dB
SS-SINR	Plots received signal strength indicator in dB

5GNR Measurement Setup

Map Type	Indoor: PNG or JPEG Outdoor: OpenStreetMap® (downloaded direct from Internet to instrument or using external PC software)
Frequency	Center Frequency, Channel Bandwidth, SSB Frequency, SSB Offset, Auto Detect SSB, Subcarrier Spacing, Mapping Pattern (P1, P2, Auto), Band Config: Band (Manual, Global All), ARFCN, Channel BW, GSCN
Amplitude	Auto Range (On/Off), Reference Level (Manual/Auto and Offset), Scale/Division, Y-Axis Unit, Preamp (on/off), Attenuation (Auto/Manual)
Bandwidth	RBW/VBW (Auto/Manual), VBW Type (Linear/Logarithmic), RBW:VBW Ratio, SPAN:RBW Ratio
Mapping Colors	Customizable Amplitude Range Thresholds for Each Color Channel Power and Spectral Density: Blue (Excellent), Green (Very Good), Yellow (Good), Orange (Fair), Pink (Poor) SS-RSRP, SS-RSRQ, SS-SINR: Blue (Excellent), Green (Good), Yellow (Poor), Pink (Bad), Gray (No Sync)
Point Distance or Time Setup	Repeat Type: Time (1 s to 60 s) or Distance (1 m to 10,000 m), Distance Units: Meters or Feet
Map Source	Any PCI, Defined PCI, Available PCI Filter, Manual PCI Filter
Save	Indoor: Setup, Measurement File (fm5gnr), PNG Outdoor: Setup, KML Points, PNG, CSV
Recall	Setup, KML Points File

Electromagnetic Field (EMF) Measurement (Option 444) (requires an isotropic antenna, sold separately)

The Spectrum Analyzer mode provides electromagnetic field strength measurements in three axis (X, Y, Z) with trace displays for each measurement and tabular results.

Measurements/Settings

Setup	Limit lines, Axis Dwell Time, Measurement Time, Measurement Count, Measurement Units, Data Logging with storage location
Units	dBm/m^2 , dBW/m^2 , dBV/m , dBmV/m , $\text{dB}\mu\text{V/m}$, V/m , W/m^2 , W/cm^2 , A/m
Results	Maximum, Minimum, and Average of all measurements conducted
Displayed Information	Measurement progress, number of measurements taken, Pass/fail indicators

Frequency Range

Supported Antenna	
2000-1800-R	9 kHz to 300 MHz
2000-1792-R	30 MHz to 3 GHz
2000-1791-R	700 MHz to 6 GHz

AM/FM Modulation Measurement (Option 509) (Spectrum Analyzer, RTSA, IA Spectrum and IA RTSA measurements)

AM Measurements

AM Depth	0% to 100%, $\pm 2\%$ accuracy, typical
AM Bandwidth	20 kHz
AM Standards	Standard AM, Upper/Lower Sideband suppressed carrier
SINAD	0 to 60 dB, nominal based on 1 kHz modulating tone
THD	-60 dB, using up to 10 harmonics of 1 kHz modulating tone
Demodulated AM Spectrum	Frequency Scale, 0 to 24 kHz
Audio Time Domain	5 s or auto zoomed
Graphs	Audio Spectrum (Log AM depth percentage vs frequency), RF Spectrum Audio Time Domain (Linear AM depth percentage vs time), Audio Results
Audio Results	Signal Power (dBm), Carrier Frequency, RMS Depth, (Peak-to-peak)/2 Depth, Peak Positive/Peak Negative Depth, SINAD (dB), Upper/Lower AM Depth, THD (dB)
Setup	Demodulation Frequency, Demodulation Marker (on/off), Marker Tracked (1 to 12), Zoomed Time Graph (on/off), Modulation (AM, USB, LSB), Audio (on/off), Volume (on/off), Record Duration (1 to 100000 S), Record, Squelch Level (-120 to 30 dBm)

FM Measurements

FM Bandwidth	96 kHz (wide)
FM Deviation	Up to 75 kHz with 2% accuracy, ± 1 kHz typical
SINAD	0 to 60 dB, nominal based on 1 kHz modulating tone
THD	-75 to 0 dB, using up to 10 harmonics of 1 kHz modulating tone
Demodulated FM Spectrum	Wideband: 96 kHz full span, 20 kHz zoomed Narrowband: 25 kHz, 24 kHz (audio spectrum) 12.5 kHz, 14 kHz (audio spectrum) 6.25 kHz, 6 kHz (audio spectrum)
Audio Time Domain	5 s or auto zoomed
Graphs	Audio Spectrum (Log FM deviation vs frequency), RF Spectrum Audio Time Domain (Linear FM deviation vs time), Audio Results
Audio Results	Signal Power (Hz), Carrier Frequency, Upper/Lower Deviation, RMS FM deviation, (Peak-to-peak)/2 Deviation, SINAD, Total Harmonic Distortion (THD), Left/Right RDS deviation, Pilot Deviation
Setup	Demodulation Frequency, Demodulation Marker (on/off), Marker Tracked (1 to 12), Zoomed Audio Graph (on/off), Zoomed Time Graph (on/off), Modulation (FM Narrowband (6.25, 12.5, 25 kHz), FM Wideband), Audio (on/off), Volume (on/off), Record Duration (1 to 100000 S), Record, Squelch Level (-120 to 30 dBm)

WCDMA FDD Signal Analyzer (Option 871) (Requires Option 31)

General	
Frequency Range	10 MHz to 6 GHz (option dependent)
Channel Bandwidth (MHz)	5
Amplitude	Auto Range on/off, Reference Level (Manual/Auto), Scale/Division, Y Axis Unit, Attenuation Level (Auto/Manual), Reference Level Offset, Preamp on/off
Input Signal Range	-80 dBm to +10 dBm
Sweep	Sweep Once/Continuous, Hold (On/Off), Restart Averaging, Gated Sweep (Channel Power and OBW)
WCDMA	
Demod Summary View	Sync: Primary Scrambling Code, Code Group, Frequency Error, Time Offset, Status Frequency Error: Count, Average, STD Deviation, Minimum, Maximum
Summary Table View	Carrier Frequency, Frequency error/Average frequency error, Channel Power, Occupied BW, Scrambling Code
WCDMA Adjacent Channel Power	
Upper/Lower Measurements	Channel (Main, Adjacent, Alternate) Absolute, Relative, Limit (dBm)
Setup Parameters	Channel Spacing, Main/Adjacent/Alternate Integration Bandwidth, Limit Type (Absolute/Relative), Limits (On/Off), Main/Adjacent/Alternate Channel Limit
WCDMA Channel Power	
Measurements	Total Channel Power, Total Power Spectral Density (PSD), Limit Test (CH Power and PSD)
Setup Parameters	Integration Bandwidth, PSD Units (Hz/MHz), Power Limit (dBm), PSD Limit (dBm/Hz)
WCDMA Spectral Emission Mask (SEM)	
Measurements	Segment, RBW, Peak Power, Peak Frequency, Mask Name, Reference Channel Power and Channel BW
Setup Parameters	Select Mask, Import Mask, Export Mask, Reference Channel Bandwidth, Auto Max Power (on/off), Manual Max Power
WCDMA Occupied Bandwidth	
Measurements	Occupied BW, Total Power, Value, Limit, OBW Center Frequency, Left Edge and Right Edge
Setup Parameters	% OBW Power, X DB, OBW Limit (on/off), Method (percent/X dB)

LTE FDD/TDD Signal Analyzer (Option 883) (Requires Option 31)

General	
Frequency Range	10 MHz to 6 GHz (option dependent)
Channel Bandwidth (MHz)	1.4, 3, 5, 10, 15, 20
Amplitude	Auto Range, Reference Level (Manual/Auto), Scale/Division, Y Axis Unit, Attenuation Level (Auto/Manual), Reference Level Offset, Pre Amp
Input Signal Range	-76 dBm to +10 dBm (≤ 20 GHz) -72 dBm to +10 dBm (> 20 GHz)
Sweep	Continuous (on/off), Sweep Once, Restart Averaging (Demod Summary only), Hold (on/off)
MIMO Antenna Setup	Auto, Antenna 0, 1, 2, or 3
LTE Demodulation Summary	
PCI Summary Measurements	Physical Cell ID, Sector ID, Cell Group, Frequency Error, Time Offset, Cyclic Prefix, Status of Primary Synchronization Signal (PSS), MIMO Time Alignment Error, Resource Block Power
Signal Power Measurements (dBm)	Physical Broadcast Channel Power (PBCH), Sync Signal (SS), Reference Signal (RS), OFDM Symbol Transmit Power (OSTP)
Error Vector Magnitude Measurements (%)	Physical Broadcast Channel (QPSK), Physical Downlink Shared Channel (QPSK), PDSCH (16-QAM/64-QAM/256-QAM)
Demod Summary View	PCI, Sector ID, Cell Group, Frequency Error, Time Offset, Cyclic Prefix, Sync Status, Power (PBCH, SS, RS), EVM (PBCH(QPSK), PDSCH (QPSK, 16-QAM, 64-QAM, 256-QAM), Average EVM, Peak EVM
Time Alignment Error (TAE) View	PCI, Sector ID, Cell Group, Frequency Error, Time Offset, Cyclic Prefix, Sync Status, TAE between each antenna pair, Power (RS, SS), EVM (RMS, PEAK)
Resource Block (RB) Power View	PCI, Sector ID, Cell Group, Frequency Error, Time Offset, Cyclic Prefix, Sync Status, RB (number of active RBs, Utilization, OSTP), EVM (QPSK, 16-QAM, 64-QAM, 256-QAM)
Summary Table View	Carrier Frequency, Frequency error, Channel Power, RS Power, Occupied BW and Physical Cell ID
Setup Parameters	Integration Bandwidth (Summary Table view only), Antenna (Auto/1/2/3/4), Cyclic Prefix (Auto/Normal/Extended), Duplex Type (FDD/TDD), UL/DL Config (TDD only), CFI (Auto/CF1/CF2/CF3), DSS Detect (on/off), SSB Offset, Frequency Error Type (Summary Table view only): Current, Average, Auto Detect SSB
RS Power Accuracy	± 1.0 dB typical (RF input -50 dBm to +10 dBm)
Frequency Error	± 10 Hz + time base error (99 % confidence level)
Residual EVM (rms)	2.0 % typical (E-UTRA Test Model 3.1, RF Input -50 dBm to +10 dBm)
LTE DSS Detection	
Setup Parameters	DSS Detect (On/Off), Status, PCI, Beam, SS-RSRP
LTE Multi PCI	
Measurements	Multiple Physical Cell IDs, Secondary Sync Signal Power (S-SS), Reference Signal Received Power (RSRP), Reference Signal Received Quality (RSRQ), Signal to Interference and Noise Ratio (SINR), Average Error Vector Magnitude (EVM), Peak EVM, Frequency Error (Hz and PPM), Dominance (dB)
Graph Displays	PCI, SINR, RSRP, RSRQ, SS Power
Setup Parameters	Cyclic Prefix (Auto/Normal/Extended), Duplex Type (FDD/TDD), UL/DL Config (TDD only), CFI (Auto/CF1/CF2/CF3), DSS Detect On/Off (Status, PCI, Beam, SS-RSRP), SSB Offset, Auto Detect SSB
LTE Channel Power	
Measurements	Total Channel Power, Total Power Spectral Density (PSD), Limit Test (Power and PSD)
Setup Parameters	Integration Bandwidth, PSD Units (Hz/MHz), Power Limit (dBm), PSD Limit (dBm/Hz)
RF Channel Power Accuracy	± 1 dB typical (-50 dBm to +10 dBm)
LTE Channel Spectrum	
Measurements	Occupied Bandwidth (OBW), Total Power, Reference Signal (RS) Power, Frequency Error, Limit Test (OBW)
Setup Parameters	% OBW Power (%/dB), XdB, OBW Limit (on/off) (Hz), Method (percent (%), x dB)
LTE Carrier Aggregation	
Measurements	Carrier, Physical-layer Cell ID (PCI), RSRP, RSRQ, SINR, EVM (% RMS), Frequency Error (Hz), Bandwidth (BW), Center Frequency, Antennas
Setup Parameters	Carrier, Carrier Count (up to eight), Antenna (Auto/0/1/2/3), Cyclic Prefix (Auto/Normal/Extended), Duplex Type (FDD/TDD)
LTE Adjacent Channel Power	
Upper/Lower Measurements	Channel (Main, Adjacent, Alternate) Absolute, Relative, Limit (dBm)
Setup Parameters	Channel Spacing, Main/Adjacent/Alternate Integration Bandwidth, Limit Type (Absolute/Relative), Limits (On/Off), Main/Adjacent/Alternate Channel Limit
LTE Spectral Emission Mask (SEM)	
Measurements	Segment, RBW, Peak Power, Peak Frequency, Mask Name, Reference Channel Power and Channel BW
Setup Parameters	Select Mask, Import Mask, Export Mask, Reference Channel Bandwidth, Auto Max Power (on/off), Manual Max Power

LTE Control Channel

PCI Summary Measurements	Physical Cell ID, Sector ID, Cell Group, Frequency Error, Time Offset, Cyclic Prefix, Status of Primary Synchronization Signal (PSS)
Power Measurements	Reference Signal (RS), P-Primary Synchronization Signal (P-SS), Secondary Synchronization Signal (S-SS), Physical Broadcast Channel (PBCH), Physical Control Format Indicator Channel (PCFICH), Physical Hybrid Automatic Repeat Request Indicator Channel (PHICH), Physical Downlink Control Channel (PDCCH), Total Power per Resource Element and Power (dBm/watts), EVM (%)
Setup Parameters	Antenna (Auto/0/1/2/3), Cyclic Prefix (Auto/Normal/Extended), Duplex Type (FDD/TDD), UL/DL Config (TDD only), NG (1/6, 1/2, 1, 2), CFI (Auto/CFI1/CFI2/CFI3)

LTE Constellation

Measurements	Physical Cell ID, Sector ID, Cell Group, Frequency Error, Time Offset, Cyclic Prefix, Status of Primary Synchronization Signal (PSS), Constellation Display of PBCH or PDSCH
Power Measurements	Reference Signal (RS) Power, P-Primary Synchronization Signal (P-SS) Power, Secondary Synchronization Signal (S-SS) power, RMS EVM (%), Peak RMS, Physical Downlink Shared Channel (PDSCH), QPSK, 16-QAM, 64-QAM, 256-QAM
Setup Parameters	Antenna (Auto/0/1/2/3), Cyclic Prefix (Auto/Normal/Extended), Duplex Type (FDD/TDD), UL/DL Config (TDD only), CFI (Auto/CFI1/CFI2/CFI3), Data Select (PBCH/PDSCH), Modulation (All/QPSK/16-QAM/64-QAM/256-QAM), Ref Points

LTE UL/DL Interference

Measurements	Physical Cell ID, Sector ID, Cell Group, Frequency Error, Time Offset, Cyclic Prefix, Status of Primary Synchronization Signal (PSS)
Sub-Frame Power Measurements	Sub-Frame, Slot (0 and 1), Total Frame Power, Uplink and Downlink Pilot Time Slots (DwPTS and UpPTS), and Transmit Off Power
Setup Parameters	Analysis (Frame/Subframe/Slot), SSF Config (Auto/0-9/Invalid), Sub-Frame (0-9), Slot (0/1) Antenna (Auto/0/1/2/3), Gated Spec Type (Uplink, Downlink, Guard Period, All, None), Gated Duration (Frame, Coupled), Frame Start Time (Auto, Sync Once, UTC, Custom), Frame Time Offset, Cyclic Prefix (Auto/Normal/Extended), Duplex Type (FDD/TDD), UL/DL Config (TDD only), NG (1/6, 1/2, 1, 2)

5G NR FDD/TDD Signal Analyzer (Option 888) (Requires Option 31)

General	
Frequency Range	10 MHz to 6 GHz (option dependent)
Band Configuration	Manual, Global All or selectable Band #, Absolute Radio Frequency Channel Number (ARFCN), Global Synchronization Raster Channel (GSCN), Channel Bandwidth (5 MHz to 100 MHz in steps of 5 MHz), SSB Offset, Subcarrier Spacing (15, 30, 120, 240 kHz), Mapping Pattern (Auto, P1, P2), Auto SSB Detect
Auto SSB Detect	Searches 3GPP defined GSCN raster
Amplitude	Auto Range, Reference Level, Scale/Division, Y Axis Unit, Reference Level Offset, Attenuation Level (Auto/Manual), Preamp
Input Signal Range	-76 dBm to +10 dBm (≤ 20 GHz) -72 dBm to +10 dBm (> 20 GHz)
Sweep	Continuous (on/off), Sweep Once, Restart Averaging (5G NR Summary only), Hold (on/off)
5G NR Summary	
Multi-Beam Measurements	Physical-layer Cell ID, Beam Index, Sector ID, Cell Group, Frequency Error, Time Offset (μ s), Status, SS-RSRP (dBm), SS-RSRQ (dB), SS-SINR (dB), SS-RSSI (dB), Sync and Demod Status Indicators
Single-Beam Measurements	Physical Cell ID, Sector ID, Cell Group, Frequency Error, Time Offset, Status, Count, Average, Standard Deviation, Minimum, Maximum, SS-RSRP (dBm), SS-RSRQ (dB), SS-SINR (dB), SS-RSSI, Sync and Demod Status Indicators, Block Measurements (PSS, SSS, PBCH, PBCH-DMRS), Average EVM, Peak EVM (@ subcarrier/symbol), Beam Power (dBm)
Summary Table View	Carrier Frequency, Frequency Error, Channel Power, SS-RSRP, Occupied BW, Physical Cell ID, Sync and Demod Status Indicators
Views	Multi Beam (up to 64), Single Beam, Summary Table
Setup Parameters	Integration Bandwidth (Summary Table view only), SINR Threshold (dB), Duplex Type (FDD/TDD), GMC Offset (μ s), Distance to Antenna (m), Distance Unit (m/ft), Frequency Error Type (Summary Table view only): Current, Average
RSRP Accuracy	± 1.0 dB typical
Residual EVM (rms)	2.0 % typical
Frequency Error	$< \pm 4.0E-9$ + time base error, typical (FR1, Channel BW ≤ 50 MHz) $< \pm 5.0E-9$ + time base error, typical (FR1, Channel BW > 50 MHz) $< \pm 1.0E-8$ + time base error, typical (FR2)
5G NR OTA (Multi PCI)	
Measurements	Multiple Physical-layer Cell (PCI) IDs, Beam Index, SS-RSRP (dBm), SS-RSRQ (dB), SS-SINR (dB), SS-RSSI (dB) SS-EVM (%), Time Offset (μ s)
Views	Multi PCI Beam Scanner (up to 64 beams), Table, Time Offset Table
Setup Parameters	SINR Threshold (dB), Duplex Type (FDD/TDD)
5G NR RF EIRP	
Measurements	EIRP (Active, Horizontal/Vertical, Sum), Upper/Lower Limit Test
Views	Normal (RF spectrum), Quick View (summary)
Setup Parameters	Save (Horizontal/Vertical), Reset Sum, RX Antenna Gain, Distance to Antenna, Distance Unit (Meters/Feet), Upper/Lower Limit Test, RX Cable Loss (dB)
5G NR RF Occupied Bandwidth	
Measurements	Occupied Bandwidth, Total Power, Limit Test
Setup Parameters	Method (% or X dB), % OBW Power, OBW Limit (On/Off), X dB
5G NR RF Channel Power	
Measurements	Total Channel Power, Total PSD, Limit Test
Setup Parameters	Integration Bandwidth, PSD Units (Hz and MHz), Power Limit (On/Off), PSD Limit (On/Off)
RF Channel Power Accuracy	± 1 dB typical (-76 dBm to +10 dBm)
5G NR Carrier Aggregation	
Component Carriers	Up to Eight Component Carriers
PCI Measurements	Carrier, Sync status (PSS), Physical-layer Cell ID (PCI), Center Frequency, Bandwidth (BW), RSRP Max, EVM (RMS), Frequency Error (Hz), Time Offset
Setup Parameters	Carrier, Carrier Count (up to 8), Duplex Type (FDD/TDD)
5G NR Constellation	
Measurements	Beam, PBCH-DMRS Power, PSS Power, SSS Power, RMS EVM, Peak EVM
PCI Measurements	Physical Cell ID, Sector ID, Cell Group, Frequency Error, Time Offset, Status
Setup Parameters	Modulation (QPSK), Data Select (PBCH), Beam Select, Reference Points (on/off)
5G NR Spectral Emission Mask (supported in normal spectrum analyzer mode)	
Measurements	Segment, RBW, Peak PWR, Peak Freq
Setup Parameters	Select Mask, Import Mask, Export Mask, REF CH BW, Auto Max PWR, Manual Max PWR

5GNR Adjacent Channel Power (supported in normal spectrum analyzer mode)

Measurements	Channel, Absolute, Relative, Limit
Setup Parameters	Channel Spacing, Main Integ BW, ADJ Integ BW, ALT Integ BW, Limit Type, Limits, Main CH Limit, ADJ CH Limit, ALT CH Limit

5GNR UL/DL Interference

Measurements	Physical Cell ID, Sector ID, Cell Group, Frequency Error, Time Offset, Status of Primary Synchronization Signal (PSS), Total Frame Power
Sub-Frame Power Measurements	Sub-Frame, Slot (0 and 1)
Setup Parameters	Analysis (Frame/Subframe/Slot), Sub-Frame (0-9), Slot (0 to 15), Gated Spec Type (Uplink, Downlink, Flexible, All, None), Gated Duration (Frame, Coupled), Frame Start Time (Auto, Sync Once, UTC, UTC+3 ms, UTC-2 ms, Custom), Frame Time offset, Frame Structure (A/B1/B2/Custom), Special Slot Type (Type 1/2) Frame Setup (Uplink Slots Pattern 1/2, Downlink Slots Pattern 1/2, Uplink Symbols Pattern 1/2, Downlink Symbols Pattern 1/2, Trans Periodicity Pattern 1/2), Cyclic Prefix (Normal), Duplex Type (FDD/TDD)

General Specifications**Setup Parameters**

Display	Brightness adjustment, Auto screen dimming shutoff timer (on/off), Color schemes (Default, Light, Black on White, Night Vision), Shortcuts (Hide Shortcuts On/Off)
Sound	System Volume (Mute All On/Off), Defaults
Date and Time	Date and Time settings (Automatic, Manual), Time Zone settings, Time synced to Internet/GNSS
Language	English, Spanish, Chinese-simplified, Japanese, French, Korean
Screenshot	Capture Region (Graphs Only, Entire Application), Color (Printable, Standard), Annotations (Header, Footer) File naming (Automatic Timestamp, Manual), Directory
Options	Installed Options, Available Options, Install Options from web, Enable options using file (USB)), Save Config
GNSS (GPS)	See "GNSS Receiver (Option 31)" on page 11
Ethernet	Ethernet (IP4 & IP6 formats), Type (DHCP, Static IP)
WLAN (Wi-Fi)	2x2 MIMO, 802.11 a/b/g/n/ac, On/Off, Auto detect wireless networks
Port Setup	Bias Voltage (On/Off), Voltage, Info
Maps	Tile Usage
Advanced	RF Safe Mode on/off, SCPI Errors on/off, Share Center Frequency on/off, Remote Lock on/off, Set Remote Password, Add Custom Certificate, Save Public Key and Certificate Information
Instrument Memory	8 GB of which nominally 1.5 GB is allocated to the operating system. Available memory to users is nominally 6.5 GB. Available memory is accessed by user saving of: screen images, trace files, setup files, digital maps, IQ captures, audio files and report files.

File Menu

Save/Recall File Management	Measurement Setup, Screenshot Image (.PNG), Export Measurement data (Text, CSV), Location Save, Copy, Paste, Delete, Create New Folder, Set File Name and File Type, Rename
-----------------------------	---

Diagnostics Menu

Battery Information, Event Log (Export File), Self Test, Service (Enable Service Mode)

Tools Menu

Web, IQ Streaming, Map Tool, PDF Reports

Report Generator

PDF Reports	Creates detailed measurement reports on the instrument
Report Contents	Free form text fields to identify and locate the site of measurements, company logo image, Cable and Antenna analyzer trace files, instrument screen captures and site photographs
Report Format	PDF and HTML

Connectors

Spectrum Analyzer RF In	Type N(f), 50 Ω (MS2089A only)
Port 2 RF In	Type N(f), 50 Ω (MS2089A and MS2085A with Option 21)
Port 1 RF Out/Reflection In	Type N(f), 50 Ω (MS2085A and MS2089A)
GNSS	SMA(f)
External Power	5.5 mm barrel connector, 14 to 16 VDC, 5.0 A max
Ethernet Interface	RJ45 connector for Ethernet 10/100/1000 Mbps (connect to PC or LAN for remote access)
USB Interface	Two USB 3 Type A (supports file transfer) One USB 3 Type C (USBTMC)
Headset Jack	3.5 mm headset jack
External Reference In	SMA(f), 50 Ω
External Trigger In	SMA(f), 50 Ω, TTL-compatible levels
DC Bias Voltage	SMA(f), Setup: On/Off, Voltage, Trip Reset Voltage Range: +1 V to +34 V, Resolution: 0.1 V Max Current: 1 A, Max Power: 15 W

Display and Keyboard

Display	10.1-inches capacitive touchscreen, 1280 x 800 resolution
Shortcuts	Maximum of five user-configured measurement setup shortcuts
Screen Strength	IK08 (protected against a five joule impact)
Keyboard	Common alphanumeric/symbolic keys and customizable EZ keyboard
Touch Gestures	Pinch to zoom x (span), Drag in x (center frequency, markers, limit line points)
Titlebar	System menu, application menu, camera icon, USB eject icon, software update icon, local host icon, lock status (touchscreen), notification icon, Wi-Fi icon, Theme Icon, GNSS icon, battery percentage icon, time and date

Battery

Type	Li-ion
Battery Life	9 hours operation, typical (mode dependent ¹)
Charging Temperature Limit	0 °C to +45 °C, relative humidity ≤ 80 %
Nominal Capacity	8400 mAh
Nominal Energy	94 Wh

Regulatory Compliance

European Union	EMC 2014/30/EU, EN 61326-1:2013 CISPR 11/EN 55011, IEC/EN 61000-4-2/3/4/5/6/8/11 Low Voltage Directive 2014/35/EU Safety EN 61010-1:2010 RoHS Directive 2011/65/EU & 2015/863
United Kingdom	EMC SI 2016/1091; BS EN 55011 & BS 61000-4-2/3/4/5/6/8/11 Consumer Protection (Safety) SI 2016/1101; BS EN 61010-1:2010 Environmental Protection SI 2012/3032;2011/65/EU & 2015/863
Australia and New Zealand	RCM AS/NZS 4417:2012
South Korea	KCC-R-R-A2J-1002
Canada	ICES-3(A)/NMB-3(A)
United States	FCC ID: SQG-60SIPT

Environmental

	MIL-PRF-28800F Class 2
Operating Temperature Range	-10°C to 55°C
Storage Temperature Range	-51°C to 71°C
Maximum Relative Humidity	95 % RH at 30°C, non-condensing
Vibration, Sinusoidal	5 Hz to 55 Hz
Vibration, Random	10 Hz to 500 Hz
Half Sine Shock	30 g _n
Altitude	4600 meters, operating and non-operating
Explosive Atmosphere	MIL-PRF-28800F Section 4.5.6.3 MIL-STD-810G, Method 511.5, Procedure 1
Ingress Protection Rating	Complies with IP52 when installed in soft carrying case

Warranty

Duration	Standard three-year warranty One-year warranty on battery
----------	--

Size and Weight

Size	290 mm x 212 mm x 96 mm (11.4 in x 8.3 in x 3.7 in)
Weight	MS2085A-0804, 0806: 3.1 kg (6.83 lb), without Option 21 MS2085A-0804, 0806: 3.8 kg (8.39 lb) with Option 21 MS2089A-0704, 0804, 0706, 0806: 3.8 kg (8.39 lb) with Option 21

Programmable Remote Control

Functionality	Full instrument programming control (except power On/Off) via Ethernet and Wi-Fi, and USBTMC. See the Programming Manual for details.
Programming Language	Standard Commands for Programmable Instruments (SCPI)
Interfaces	Ethernet, WLAN, USBTMC (USB C port)

1. 633-79 (94 Wh): CAA with internal battery - 5 hours operation, typical, CAA with an accessory battery - 9 hours operation, typical, SPA with internal battery - 3 hours operation, typical, SPA with an accessory battery - 6 hours operation, typical.

633-75 (84 Wh): CAA with internal battery - 4 hours operation, typical, CAA with an accessory battery - 8 hours operation, typical SPA with internal battery - 2.5 hours operation, typical, SPA with an accessory battery - 5.5 hours operation, typical.

Anritsu Remote and Report Tools (ARRT) (for your PC)

Anritsu Report Tool

Supported Measurements	Return Loss, 1-Port Phase, VSWR, DTF Return Loss, DTF VSWR, Cable Loss, Smith Chart, TDR Ohm, TDR Linear, 2-Port Transmission, Transmission (USB Sensor)
Markers	8 regular Markers, 7 Delta markers Marker Functions: Distance/Frequency, Mode (Reference, Delta, Normal) Marker Search: Peak, Valley, Marker between
Limits	Limit File: Load, Save Limit Functions: Mode (Single, Segmented), Upper Limit, Lower Limit, Upper Level, Lower Level, Segmented Limit Functions: Segment (42 segmented limits are supported), Segment Type (Upper/Lower), Add Segment, Delete Segment, Clear All, X1, X2, Y1, Y2 and Y Offset
Save	.limcaa,.smcaa files
Report Generator	Config: Load Template, Save Template, Clear Template, Report Folder, Report Name, Black & White Graphs, Title, Site Information, Site Location, Company Logo, Logo Alignment, Work Order Number, Technician ID, Prepared By, Approved By Setup: Measurement traces per page (1 to 4) Preview: Open PDF preview in browser
Cable List Tool	Cable List: Allows selection of predefined cables User Cable List: Allows creation of custom cable list
Trace Selection	Enables selection of a specific trace from the list in title bar
Trace Pop-out	Enables opening of a trace in a new window
Theme	Dark, Light
Settings	Report Config, Instrument, Help, About
Connections	Connect to instrument using Ethernet or Wi-Fi
Download	Use Anritsu Remote Tool to download measurements, live traces and limit files to PC for storage and analysis using Anritsu Report Tool
Upload	Upload measurements from PC to instrument

Anritsu Remote Tool

Functionality	Free MS2085A/89A ARRT software download from www.anritsu.com Full instrument graphical user interface control from a PC with simulated hardware support for on-screen measurement analysis ARRT software compatible with Windows® 10 and 11; 32 or 64 bit operating systems
Interfaces	Ethernet, WLAN

Ordering Information – MS2085A Instrument Options



Part Number Description

MS2085A Site Master (Requires Option 804 or 806)

Options

MS2085A-0804 Cable and Antenna Analyzer, 4 GHz

MS2085A-0806 Cable and Antenna Analyzer, 6 GHz

MS2085A-0003* Time Domain Reflectometry (TDR) Measurement

MS2085A-0017 Secure Communication

MS2085A-0019* High Accuracy Power Meter (Requires USB sensor, sold separately)

MS2085A-0021 2-port Transmission Measurement

MS2085A-0031* GNSS receiver (Requires GNSS antenna, sold separately)

MS2085A-08xx-0097 Accredited Calibration to ISO17025 and ANSI/NCSL Z540-1 (xxxx is the frequency option number)

MS2085A-xxxx-0098 Standard Calibration to ISO17025 and ANSI/NCSL Z540-1 (xxxx is the frequency option number)

MS2085A-xxxx-0099 Premium Calibration to ISO17025 and ANSI/NCSL Z540-1 plus test data (xxxx is the frequency option number)

*** Timed-Limited Options** Options marked with an asterisk are offered as a 90-day time limited option by ordering as a -9xxx series option. For example, MS2085A-9003 is the 90-day time limited option for Time Domain Reflection Measurements. The option start time begins when the user first activates the option.

Supported PC Software

ARRT Anritsu Remote and Report Tools

Ordering Information – MS2089A Instrument Options



Part Number Description

- MS2089A Site Master, 4 GHz (Requires Option 704 and 804)
- MS2089A Site Master, 6 GHz (Requires Option 706 and 806)
- MS2089A Site Master requires both a CAA and SPA option, which must be of the same frequency

Options

- MS2089A-0804 Cable and Antenna Analyzer, 4 GHz
- MS2089A-0806 Cable and Antenna Analyzer, 6 GHz
- MS2089A-0704 Spectrum Analyzer, 4 GHz
- MS2089A-0706 Spectrum Analyzer, 6 GHz
- MS2089A-0003* Time Domain Reflectometry (TDR) Measurement
- MS2089A-0017 Secure Communication
- MS2089A-0019* High Accuracy Power Meter (Requires USB sensor, sold separately)
- MS2089A-0021* 2-port Transmission Measurement
- MS2089A-0024* Interference Finder (Option 31 and directional antenna recommended, sold separately)
- MS2089A-0027* Channel Scanner
- MS2089A-0031* GNSS receiver (Requires GNSS antenna, sold separately)
- MS2089A-0090* Gated Sweep
- MS2089A-0102* 40 MHz Analysis Bandwidth
- MS2089A-0126* IQ Waveform Capture (Includes MX280005A IQ Signal Master base feature set)
- MS2089A-0127* IQ Waveform Streaming (Includes MX280005A IQ Signal Master base feature set) (Requires Option 126)
- MS2089A-0128* Enable Vector Signal Analysis (Requires Option 126)
- MS2089A-0199* Real-Time Spectrum Analysis (RTSA)
- MS2089A-0400* Enable Vision Monitor
- MS2089A-0407* Enable Vision High-Speed Port Scanner
- MS2089A-0431* Coverage Mapping (Requires Option 31)
- MS2089A-0444* EMF Measurement (requires Anritsu isotropic antenna, sold separately)
- MS2089A-0509* AM/FM Modulation Measurements
- MS2089A-0871* WCDMA FDD Measurements (requires Option 31)
- MS2089A-0883* LTE FDD/TDD Measurements (requires Option 31)
- MS2089A-0888* 5G NR Downlink Measurements (requires Option 31)
- MS2089A-xxxx-0097 Accredited Calibration to ISO17025 and ANSI/NCSL Z540-1 (xxxx is the frequency option number)
- MS2089A-xxxx-0098 Standard Calibration to ISO17025 and ANSI/NCSL Z540-1 (xxxx is the frequency option number)
- MS2089A-xxxx-0099 Premium Calibration to ISO17025 and ANSI/NCSL Z540-1plus test data (xxxx is the frequency option number)

*** Timed-Limited Options** Options marked with an asterisk are offered as a 90-day time limited option by ordering as a -9xxx series option. For example, MS2089A-9888 is the 90-day time limited option for 5G NR FDD/TDD Measurements. The option start time begins when the user first activates the option.

Supported PC Software

- MX280001A Vision™ Monitor
- MX280005A IQ Signal Master™ Vector Modulation Analysis
- MX280007A Mobile InterferenceHunter™
- ARRT Anritsu Remote and Report Tools

Standard Accessories (included with instrument)







Accessory	Description
	2000-2071-R MS2085A/89A Soft Case
	Certificate of Calibration and Conformance
	633-79 Li-ion Battery, 94Wh
	2000-2156-R SMA(m) to BNC(f) Adapter (qty 3)
	40-204-R AC/DC Power Adapter





Accessory	Description
	2000-1371-R Ethernet Cable, 2 m
	2000-1859-R USB Cable, USB 3.0 Type-A to Type-C, 1 m
	806-442-R SMA(m) to BNC(m) cable, 1 m
	633-75 Li-ion Battery, 84Wh

Related Manuals (available at www.anritsu.com)

Part Number	Description
10100-00069	Product Information, Compliance, and Safety
10580-00499	Site Master User Guide
10580-00502	Site Master Programming Manual
10580-00447	Spectrum Analyzer Measurement Guide Interference Finder (Option 24, requires Option 31) Gated Sweep (Option 90) Coverage Mapping (Option 431) AM/FM Modulation Measurement (Option 509)
10580-00448	RTSA Measurement Guide (Option 199) Interference Finder (Option 24, requires Option 31)
10580-00449	5GNR Measurement Guide (Option 888) Gated Sweep (Option 90) Coverage Mapping (Option 431, requires Option 31)
10580-00450	LTE Measurement Guide (Option 883) Gated Sweep (Option 90) Coverage Mapping (Option 431)
10580-00492	High Accuracy Power Meter Measurement Guide (Option 19)
10580-00493	Cable and Antenna Analyzer Measurement Guide
10580-00501	WCDMA Measurement Guide (Option 871)
10580-00504	Channel Scanner Measurement Guide (Option 27)

USB Power Sensors (for complete ordering information, see the respective data sheets of each sensor)



Accessory	Description
	MA24330A Microwave CW USB Power Sensor, 10 MHz to 33 GHz, +20 dBm
	MA24340A Microwave CW USB Power Sensor, 10 MHz to 40 GHz, +20 dBm
	MA24350A Microwave CW USB Power Sensor, 10 MHz to 50 GHz, +20 dBm
	MA24208A Microwave Universal USB Power Sensor, 10 MHz to 8 GHz, +20 dBm to -60 dBm
	MA24218A Microwave Universal USB Power Sensor, 10 MHz to 18 GHz, +20 dBm to -60 dBm
	MA24106A High Accuracy RF Power Sensor, 50 MHz to 6 GHz, +23 dBm to -40 dBm



Accessory	Description
	MA24108A Microwave USB Power Sensor, 10 MHz to 8 GHz, +20 dBm to -40 dBm
	MA24118A Microwave USB Power Sensor, 10 MHz to 18 GHz, +20 dBm to -40 dBm
	MA24126A Microwave USB Power Sensor, 10 MHz to 26 GHz, +20 dBm to -40 dBm
	MA25100A RF Power Indicator

Optional Accessories

Miscellaneous Accessories		Accessory	Description
Accessory	Description		
	67135 Anritsu Backpack (for Handheld Instrument and PC)		760-243-R Large Transit Case with Wheels and Handle 56 cm x 45.5 cm x 26.5 cm (22.07" x 17.92" x 10.42")
	760-271-R Transit Case (For Portable Directional Antennas and Port Extender P/N 2000-1777-R, 2000-1778-R, 2000-1779-R and 2000-1798-R) (Case can contain three loop antennas at once)		2000-1374-R External Dual Charger for Li-Ion Batteries
	2000-2048-R Screen Protector		2000-2074-R Extended Power Pack with Cable
	2000-2146-R Bias tee, 2.5 MHz to 6 GHz		2000-2053-R Shoulder Harness
	2000-2149-R EMI Near-Field Probe Kit, 100 kHz to 1 GHz Requires 1092-172-R Type N to BNC Adapter and 1 m BNC to BNC Cable (sold separately) (For full specifications, refer to the Near-Field Probe Set User Guide 10580-00347)		2000-1884-R PIM Hunter™ Test Probe (For full specifications, refer to the 2000-1884-R Technical Data Sheet 11410-00999)
	12N50-75B Matching Pad, DC to 3 GHz, 50 Ω to 75 Ω		

USB Extender Kit (for use with external 2-port cable loss/transmission sensors; requires Cat 5e extension cable, sold separately)

Accessory	Description
	2000-1900-R USB 2.0 Active 100 meter Extender (with Type A power cord for USA, Japan, North America, Central America and Caribbean)
	2000-1901-R USB 2.0 Active 100 meter Extender (with Type C power cord for use in Europe, India, South Korea, and many countries in Middle East and Africa)
	2000-1902-R USB 2.0 Active 100 meter Extender (with Type I power cord for use in Australia, New Zealand, Argentina, and the South Pacific)
	2000-1903-R USB 2.0 Active 100 meter Extender (with Type G power cord for use in the UK, and several other countries in Asia, the Middle East, and Africa)



Accessory	Description
	2000-1717-R USB 1.1 Passive 40 m Extender (Not compatible with sensors MA24208A, MA24218A, MA24330A, MA24340A, MA24350A; must use active extenders with these sensors).
	2100-28-R Cat 5e extension cable for use with USB Extender (22.5 m)



Coaxial Calibration Components, 50 Ω

Accessory	Description
	ICN51A InstaCal™ Calibration Module, 40 dB typical 9 kHz to 6 GHz, N(m), 50 Ω
	OSLNF50A-8 High Performance Type N (f), DC to 8 GHz, 50 Ω
	2000-1915-R Precision Open/Short/Load, 4.3-10(m), DC to 6 GHz, 50 Ω
	2000-1619-R Precision Open/Short/Load, 7/16 DIN(f), DC to 6 GHz, 50 Ω
	22NF50 Open/Short, N(f), DC to 18 GHz, 50 Ω
	SM/PLNF-1 Precision Load, N(f), 42 dB, 6 GHz, 50 Ω

Accessory	Description
	OSLN50A-8 High Performance Type N(m), DC to 8 GHz, 50 Ω
	2000-1914-R Precision Open/Short/Load, 4.3-10(f), DC to 6 GHz, 50 Ω
	2000-1618-R Precision Open/Short/Load, 7/16 DIN(m), DC to 6 GHz, 50 Ω
	22N50 Open/Short, N(m), DC to 18 GHz, 50 Ω
	SM/PL-1 Precision Load, N(m), 42 dB, 6 GHz, 50 Ω

Coaxial Calibration Components, 75 Ω

Accessory	Description
	22N75 Open/Short, N(m), DC to 3 GHz, 75 Ω
	26N75A Precision Termination, N(m), DC to 3 GHz, 75 Ω

Accessory	Description
	22NF75 Open/Short, N(f), DC to 3 GHz, 75 Ω
	26NF75A Precision Termination, N(f), DC to 3 GHz, 75 Ω

Adapters

Accessory	Description
	1091-26-R SMA(m) to N(m), DC to 18 GHz, 50 Ω
	1091-27-R SMA(f) to N(m), DC to 18 GHz, 50 Ω
	1091-80-R SMA(m) to N(f), DC to 18 GHz, 50 Ω
	1091-81-R SMA(f) to N(f), DC to 18 GHz, 50 Ω
	1091-172-R BNC(f) to N(m), DC to 1.3 GHz, 50 Ω
	1091-465-R Low PIM Adapter, DC to 6 GHz, 4.3-10(f) to N(f), 50 Ω
	1091-467-R Low PIM Adapter, DC to 6 GHz, 4.3-10(m) to N(f), 50 Ω
	1091-434-R Low PIM Adapter, DC to 3.0 GHz, 4.1 to 9.5(m) to 7/16 DIN(f), 50 Ω

Accessory	Description
	510-102-R N(m) to N(m), DC to 11 GHz, 50 Ω, 90 degrees 50 Ω
	510-90-R 7/16 DIN(f) to N(m), DC to 7.5 GHz, 50 Ω
	510-91-R 7/16 DIN(f) to N(f), DC to 7.5 GHz, 50 Ω
	510-92-R 7/16 DIN(m) to N(m), DC to 7.5 GHz, 50 Ω
	510-93-R 7/16 DIN(m) to N(f), DC to 7.5 GHz, 50 Ω
	510-96-R 7/16 DIN(m) to 7/16 DIN (m), DC to 7.5 GHz, 50 Ω
	510-97-R 7/16 DIN(f) to 7/16 DIN (f), DC to 7.5 GHz, 50 Ω
	1091-433-R Low PIM Adapter, 4.1/9.5(f) to 7/16 DIN(f), DC to 3.0 GHz, 50 Ω

Precision Adapters

Accessory	Description
	34NN50A N(m) to N(m), DC to 18 GHz, 50 Ω

Accessory	Description
	34N50A N(f) to N(f), DC to 18 GHz, 50 Ω

Attenuators

Accessory	Description
	1010-121-R 40 dB, 100 W, DC to 18 GHz, N(m) to N(f), Uni-directional

Accessory	Description
	42N50-20 20 dB, 5 W, DC to 18 GHz, N(m) to N(f)

	3-1010-122 20 dB, 5 W, DC to 12.4 GHz, N(m) to N(f)
---	--

	42N50A-30 30 dB, 50 W, DC to 18 GHz, N(m) to N(f)
---	--





	3-1010-123 30 dB, 50 W, DC to 8.5 GHz, N(m) to N(f)
---	--



	1010-127-R 30 dB, 150 W, DC to 3 GHz, N(m) to N(f)
---	---

	3-1010-124 40 dB, 100 W, DC to 8.5 GHz, N(m) to N(f), Uni-directional
--	---



	1010-128-R 40 dB, 150 W, DC to 3 GHz, N(m) to N(f)
--	---

Phase-Stable Test Port Cables, Armored w/Reinforced Grip (recommended for cable & antenna line sweep applications)

Accessory	Description
	15RDN50-1.5-R 1.5 m, DC to 6 GHz, N(m) to 7/16 DIN(m), 50 Ω
	15RDFN50-1.5-R 1.5 m, DC to 6 GHz, N(m) to 7/16 DIN(f), 50 Ω
	15RDN50-3.0-R 3.0 m, DC to 6 GHz, N(m) to 7/16 DIN(m), 50 Ω
	15RDFN50-3.0-R 3.0 m, DC to 6 GHz, N(m) to 7/16 DIN(f), 50 Ω

Accessory	Description
	15RNFN50-1.5-R 1.5 m, DC to 6 GHz, N(m) to N(f), 50 Ω
	15RNFN50-3.0-R 3.0 m, DC to 6 GHz, N(m) to N(f), 50 Ω

Interchangeable Adapter, Phase Stable Test Port Cables, Armored w/Reinforced Grip (recommended for cable and antenna line sweep applications. It uses the same ruggedized grip as the Reinforced grip series cables. Now you can also change the adapter interface on the grip to four different connector types.)



Accessory	Description
	15RCN50-1.5-R 1.5 m, DC to 6 GHz, N(m), N(f), 7/16 DIN(m), 7/16 DIN(f), 50 Ω
	15RCN50-3.0-R 3.0 m, DC to 6 GHz, N(m), N(f), 7/16 DIN(m), 7/16 DIN(f), 50 Ω

Phase-Stable Test Port Cables, Armored (recommended for use with tightly spaced connectors and other general purpose applications)





Accessory	Description
	15NNF50-1.5C 1.5 m, DC to 6 GHz, N(m) to N(f), 50 Ω
	15NN50-1.5C 1.5 m, DC to 6 GHz, N(m) to N(m), 50 Ω
	15NNF50-3.0C 3.0 m, DC to 6 GHz, N(m) to N(f), 50 Ω
	15NN50-3.0C 3.0 m, DC to 6 GHz, N(m) to N(m), 50 Ω
	15NNF50-5.0C 5.0 m, DC to 6 GHz, N(m) to N(f), 50 Ω
	15NN50-5.0C 5.0 m, DC to 6 GHz, N(m) to N(m), 50 Ω

Accessory	Description
	15NDF50-1.5C 1.5 m, DC to 6 GHz, N(m) to 7/16 DIN(f), 50 Ω
	15ND50-1.5-R 1.5 m, DC to 6 GHz, N(m) to 7/16 DIN(m), 50 Ω
	15N43M50-1.5C Test Port Extension Cable, Armored, 1.5 m, DC to 6 GHz, N(m) to 4.3-10(m)
	15N43F50-1.5C Test Port Extension Cable, Armored, 1.5 m, DC to 6 GHz, N(m) to 4.3-10(f)
	15N43M50-3.0C Test Port Extension Cable, Armored, 3 m, DC to 6 GHz, N(m) to 4.3-10(m)
	15N43F50-3.0C Test Port Extension Cable, Armored, 3 m, DC to 6 GHz, N(m) to 4.3-10(f)

GPS Antennas

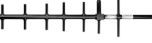

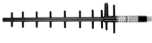
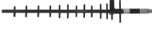
Accessory	Description
	2000-1528-R Magnet Mount, SMA(m) with 5 m (16.4 ft) cable, requires 5 VDC
	2000-1652-R Magnet Mount, SMA(m) with 0.3 m (1 ft) cable, requires 3.3 VDC or 5 VDC

Accessory	Description
	2000-1760-R Miniature Antenna, SMA(m), requires 2.5 VDC to 3.7 VDC

Directional Antennas	
Accessory	Description
	2000-1411-R 824 MHz to 896 MHz, N(f), 12.3 dBi, Yagi
	2000-1412-R 885 MHz to 975 MHz, N(f), 12.6 dBi, Yagi
	2000-1413-R 1710 MHz to 1880 MHz, N(f), 12.3 dBi, Yagi
	2000-1414-R 1850 MHz to 1990 MHz, N(f), 11.4 dBi, Yagi
	2000-1415-R 2400 MHz to 2500 MHz, N(f), 14.1 dBi, Yagi
	2000-1416-R 1920 MHz to 2170 MHz, N(f), 14.3 dBi, Yagi
	2000-1659-R 698 MHz to 787 MHz, N(f), 10.1 dBi, Yagi
	2000-1660-R 1425 MHz to 1535 MHz, N(f), 14.3 dBi, Yagi

Accessory	Description
	2000-1726-R 2500 MHz to 2700 MHz, N(f), 14.1 dBi, Yagi
	2000-2107-R Log Periodic, 20 MHz to 8.5 GHz
	2000-1748-R Log Periodic, 1 GHz to 18 GHz, N(f), 6 dBi, typical
	2000-1777-R 9 kHz to 20 MHz, N(f)
	2000-1778-R 20 MHz to 200 MHz, N(f)
	2000-1779-R 200 MHz to 500 MHz, N(f)
	2000-1812-R Portable Yagi Antenna, 450 MHz to 512 MHz, N(f), 7.1 dBi
	2000-1825-R Portable Yagi Antenna, 380 MHz to 430 MHz, N(f), 7.1 dBi

InterferenceHunter™ and Accessories

Accessory	Description
	MA2700A Handheld Interference Hunter (For full specifications, refer to the MA2700A Technical Data Sheet 11410-00692)
	2000-1735-R 776 MHz to 788 MHz, N(m) and N(f), 50 Ω
	2000-1736-R 815 MHz to 850 MHz, N(m) and N(f), 50 Ω
	2000-1737-R 1711 MHz to 1756 MHz, N(m) and N(f), 50 Ω
	2000-1738-R 1850 MHz to 1910 MHz, N(m) and N(f), 50 Ω
	2000-1739-R 880 MHz to 915 MHz, N(m) and N(f), 50 Ω
	2000-1740-R 1710 MHz to 1785 MHz, N(m) and N(f), 50 Ω

Accessory	Description
	2000-1734-R 699 MHz to 715 MHz, N(m) and N(f), 50 Ω
	2000-1741-R 1920 MHz to 1980 MHz, N(m) and N(f), 50 Ω
	2000-1742-R 832 MHz to 862 MHz, N(m) and N(f), 50 Ω
	2000-1743-R 2500 MHz to 2570 MHz, N(m) and N(f), 50 Ω
	2000-1798-R Port Extender, DC to 6 GHz
	2000-1799-R 2305 MHz to 2320 MHz, N(m) and N(f), 50 Ω
	2000-2147-R 3700 MHz to 3980 MHz, N(m) to N(f), 50 Ω

Portable Antennas (requires 1091-27-R SMA(f) to N(m) or 1091-172-R BNC(f) to N(m) adapter)

Accessory	Description
	2000-1200-R 806 MHz to 866 MHz, SMA(m), 50 Ω
	2000-1473-R 870 MHz to 960 MHz, SMA(m), 50 Ω
	2000-1035-R 896 MHz to 941 MHz, SMA(m), 50 Ω (1/2 wave)
	2000-1030-R 1710 MHz to 1880 MHz, SMA(m), 50 Ω (1/2 wave)
	2000-1474-R 1710 MHz to 1880 MHz with knuckle elbow (1/2 wave)
	2000-1031-R 1850 MHz to 1990 MHz, SMA(m), 50 Ω (1/2 wave)



Accessory	Description
	2000-1475-R 1920 MHz to 1980 MHz and 2110 MHz to 2170 MHz, SMA(m), 50 Ω
	2000-1032-R 2400 MHz to 2500 MHz, SMA(m), 50 Ω (1/2 wave)
	2000-1751-R 698 MHz to 960 MHz, 1710 MHz to 2100 MHz, 2500 MHz to 2700 MHz, SMA(m), 2 dB, typical, 50 Ω
	2000-1361-R 2400 MHz to 2500 MHz, 5000 MHz to 6000 MHz, SMA(m), 50 Ω
	2000-1636-R Antenna Kit (Consists of: 2000-1030-R, 2000-1031-R, 2000-1032-R, 2000-1200-R, 2000-1035-R, 2000-1361-R, and carrying pouch)



Magnet Mount and Broadband Antennas

Accessory	Description
	2000-2141-R 20 MHz to 21000 MHz, N(f), 50 Ω
	2000-1646-R 750 MHz to 1250 MHz, 3 dBi peak gain, 1650 MHz to 2000 MHz, 5 dBi peak gain, 2100 MHz to 2700 MHz, 5 dBi peak gain, N(m), 50 Ω, 10 ft
	2000-1648-R 1700 MHz to 6000 MHz, 3 dBi peak gain, N(m), 50 Ω, 10 ft

Accessory	Description
	2000-1645-R 694 MHz to 894 MHz, 3 dBi peak gain 1700 MHz to 2700 MHz, 3 dBi peak gain, N(m), 50 Ω, 10 ft
	2000-1647-R Cable 1: 698 MHz to 1200 MHz, 2 dBi peak gain, 1700 MHz to 2700 MHz, 5 dBi peak gain, N(m), 50 Ω, 10 ft Cable 2: 3000 MHz to 6000 MHz, 5 dBi peak gain, N(m), 50 Ω, 10 ft Cable 3: GPS 26 dB gain, SMA(m), 50 Ω, 10 ft
	2000-1946-R Cable 1: 617 MHz to 960 MHz, 3 dBi peak gain, 1710 MHz to 3700 MHz, 4 dBi peak gain, N(m), 50 Ω, 10 ft Cable 2: 3000 MHz to 6000 MHz, 5 dBi peak gain, N(m), 50 Ω, 10 ft Cable 3: GPS 26 dB gain, SMA(m), 50 Ω, 10 ft

EMF Antennas/Probes

Accessory	Description
	2000-1800-R Isotropic Antenna, H-Field, 9 kHz to 300 MHz
	2000-1792-R Isotropic Antenna, E-Field, 30 MHz to 3 GHz

Accessory	Description
	2000-1791-R Isotropic Antenna, E-Field, 0.7 GHz to 6 GHz
	2000-1985-R EMF Probe, 20 MHz to 40 GHz

Bandpass Filters		Accessory	
Accessory	Description	Accessory	Description
	1030-114-R 806 MHz to 869 MHz, N(m) to SMA(f), 50 Ω		2000-1734-R 699 MHz to 715 MHz, N(m) and N(f), 50 Ω
	1030-109-R 824 MHz to 849 MHz, N(m) to SMA(f), 50 Ω		2000-1735-R 776 MHz to 788 MHz, N(m) and N(f), 50 Ω
	1030-110-R 880 MHz to 915 MHz, N(m) to SMA(f), 50 Ω		2000-1736-R 815 MHz to 850 MHz, N(m) and N(f), 50 Ω
	1030-111-R 1850 MHz to 1910 MHz, N(m) to SMA(f), 50 Ω		2000-1737-R 1711 MHz to 1756 MHz, N(m) and N(f), 50 Ω
	1030-112-R 2400 MHz to 2484 MHz, N(m) to SMA(f), 50 Ω		2000-1738-R 1850 MHz to 1910 MHz, N(m) and N(f), 50 Ω
	1030-105-R 890 MHz to 915 MHz, N(m) to N(f), 50 Ω		2000-1739-R 880 MHz to 915 MHz, N(m) and N(f), 50 Ω
	1030-106-R 1710 MHz to 1790 MHz, N(m) to N(f), 50 Ω		2000-1740-R 1710 MHz to 1785 MHz, N(m) and N(f), 50 Ω
	1030-107-R 1910 MHz to 1990 MHz, N(m) to N(f), 50 Ω		2000-1741-R 1920 MHz to 1980 MHz, N(m) and N(f), 50 Ω
	1030-149-R High Pass, 150 MHz, N(m) to N(f), 50 Ω		2000-1742-R 832 MHz to 862 MHz, N(m) and N(f), 50 Ω
	1030-150-R High Pass, 400 MHz, N(m) to N(f), 50 Ω		2000-1743-R 2500 MHz to 2570 MHz, N(m) and N(f), 50 Ω
	1030-151-R High Pass, 700 MHz, N(m) to N(f), 50 Ω		2000-1799-R 2305 MHz to 2320 MHz, N(m) and N(f), 50 Ω
	1030-152-R Low Pass, 200 MHz, N(m) to N(f), 50 Ω		2000-1911-R 703 MHz to 748 MHz, N(m) and N(f), 50 Ω
	1030-153-R Low Pass, 550 MHz, N(m) to N(f), 50 Ω		2000-1912-R 788 MHz to 798 MHz, N(m) and N(f), 50 Ω
	1030-155-R 2500 MHz to 2700 MHz, N(m) to N(f), 50 Ω		2000-1925-R 663 MHz to 698 MHz, N(m) and N(f), 50 Ω
	1030-178-R 1920 MHz to 1980 MHz, N(m) to N(f), 50 Ω		2000-1926-R 776 MHz to 806 MHz, N(m) and N(f), 50 Ω
	1030-179-R 777 MHz to 798 MHz, N(m) to N(f), 50 Ω		2000-1684-R 791 MHz to 821 MHz, N(m) to N(f), 50 Ω
	1030-180-R 2500 MHz to 2570 MHz, N(m) to N(f), 50 Ω		

Training at Anritsu

Anritsu has designed courses to help you stay up to date with technologies important to your job. For available training courses, visit: www.anritsu.com and search for training and education.



• United States

Anritsu Americas Sales Company

490 Jarvis Drive, Morgan Hill, CA 95037-2809, U.S.A.
Phone: +1-800-Anritsu (1-800-267-4878)

• Canada

Anritsu Electronics Ltd.

Americas Sales and Support

490 Jarvis Drive, Morgan Hill, CA 95037-2809, U.S.A.
Phone: +1-800-Anritsu (1-800-267-4878)

• Brazil

Anritsu Elettronica Ltda.

Praça Amadeu Amaral, 27 - 1 Andar
01327-010 - Bela Vista - Sao Paulo - SP, Brazil
Phone: +55-11-3283-2511
Fax: +55-11-3288-6940

• Mexico

Anritsu Company, S.A. de C.V.

Blvd Miguel de Cervantes Saavedra #169 Piso 1,
Col. Granada, Mexico, Ciudad de Mexico,
11520, MEXICO
Phone: +52-55-4169-7104

• United Kingdom

Anritsu EMEA Ltd.

200 Capability Green,
Luton, Bedfordshire, LU1 3LU, U.K.
Phone: +44-1582-433200
Fax: +44-1582-731303

• France

Anritsu S.A.

12 avenue du Québec, Immeuble Goyave,
91140 VILLEBON SUR YVETTE, France
Phone: +33-1-60-92-15-50

• Germany

Anritsu GmbH

Nemetschek Haus, Konrad-Zuse-Platz 1,
81829 München, Germany
Phone: +49-89-442308-0
Fax: +49-89-442308-55

• Italy

Anritsu S.r.l.

Spaces Eur Arte, Viale dell'Arte 25, 00144 Roma, Italy
Phone: +39-6-509-9711

• Sweden

Anritsu AB

Kistagången 20 B, 2 tr, 164 40 Kista, Sweden
Phone: +46-8-534-707-00

• Finland

Anritsu AB

Technopolis Aviapolis, Teknobulevardi 3-5 (D208.5),
FI-01530 Vantaa, Finland
Phone: +358-20-741-8100

• Denmark

Anritsu A/S

c/o Regus Winghouse, Ørestads Boulevard 73, 4th floor,
2300 Copenhagen S, Denmark
Phone: +45-7211-2200

• Spain

Anritsu EMEA Ltd.

Representation Office in Spain

Paseo de la Castellana, 141.
Planta 5, Edificio Cuzco IV
28046, Madrid, Spain
Phone: +34-91-572-6761

• Austria

Anritsu EMEA GmbH

Am Belvedere 10, A-1100 Vienna, Austria
Phone: +43-(0)1-717-28-710

• United Arab Emirates

Anritsu EMEA Ltd.

Anritsu A/S

Office No. 164, Building 17, Dubai Internet City
P. O. Box - 501901, Dubai, United Arab Emirates
Phone: +971-4-3758479

• India

Anritsu India Private Limited

6th Floor, Indiqube ETA, No.38/4, Adjacent to EMC2,
Doddanekundi, Outer Ring Road,
Bengaluru - 560048, India
Phone: +91-80-6728-1300
Fax: +91-80-6728-1301

• Singapore

Anritsu Pte. Ltd.

1 Jalan Kilang Timor, #07-04/06 Pacific Tech Centre
Singapore 159303
Phone: +65-6282-2400
Fax: +65-6282-2533

• Vietnam

Anritsu Company Limited

16th Floor, Peakview Tower, 36 Hoang Cau Street,
O Cho Dua Ward, Dong Da District, Hanoi, Vietnam
Phone: +84-24-3201-2730

• P.R. China (Shanghai)

Anritsu (China) Co., Ltd.

Room 2701-2705, Tower A, New Caohejing
International Business Center No. 391 Gui Ping Road
Shanghai, 200233, P.R. China
Phone: +86-21-6237-0898
Fax: +86-21-6237-0899

• P.R. China (Hong Kong)

Anritsu Company Ltd.

Unit 1006-7, 10/F., Greenfield Tower, Concordia Plaza,
No. 1 Science Museum Road, Tsim Sha Tsui East,
Kowloon, Hong Kong, P.R. China
Phone: +852-2301-4980
Fax: +852-2301-3545

• Japan

Anritsu Corporation

8-5, Tamura-cho, Atsugi-shi, Kanagawa, 243-0016 Japan
Phone: +81-46-296-6509
Fax: +81-46-225-8352

• South Korea

Anritsu Corporation, Ltd.

8F, A TOWER, 20, Gwacheondaero 7-gil, Gwacheon-si,
Gyeonggi-do, 13840, Republic of Korea
Phone: +82-2-6259-7300
Fax: +82-2-6259-7301

• Australia

Anritsu Pty. Ltd.

Unit 20, 21-35 Ricketts Road,
Mount Waverley, Victoria 3149, Australia
Phone: +61-3-9558-8177
Fax: +61-3-9558-8255

• Taiwan

Anritsu Company Inc.

7F, No. 316, Sec. 1, NeiHu Rd., Taipei 114, Taiwan
Phone: +886-2-8751-1816
Fax: +886-2-8751-1817

List Revision Date: 20240416