

ONT-50

Optical Network Tester



February 2006 Edition

Key features

- Combines **digital and optical** test capabilities
- SONET/SDH from 52 Mb/s to 10.7 Gb/s with electrical and optical interfaces
- Complete testing solution for **OTU1 and OTU2**
- **High-accurate Jitter/Wander** test 10/10.7G according to new ITU-T O.172 Appendix VII + VIII
- First EoS **interworking tester** up to 10 Gb/s
- Electrical and optical **Ethernet** testing
- **Single and dual port DSn/PDH** modules
- Unique dual port **OSAs** ready for 40/43 Gb/s signal analysis with channel drop up to 10.7 Gb/s
- **Multiuser remote** use through innovative web browser interface
- Supports **multiple applications** simultaneously

Testing design and conformance of Next Generation Transport Networks

Next Generation SONET/SDH equipment plays a key role in today's networks. It allows for efficient handling of data, voice and video traffic (triple play). This is addressing the needs of service providers to transport services like "bandwidth optimized" Ethernet over the widely deployed SONET/SDH networks.

New installations of broadband links today are frequently done with OTN technology. With its' Forward Error Correction (FEC) it increases the fault acceptance capability of a high speed link, thus providing a higher transmission quality or possible longer links.

DWDM is still another great enabler of increased bandwidth by optical multiplexing of multiple high speed links.

As a result, companies are increasingly require advanced testing solutions that are able to combine all necessary test applications and enable quick time to market of their products.

The ONT-50 is a flexible, four slot, mainframe test solution with broadest range of digital and optical application modules. Modules to test are OTN, SONET, SDH, PDH, NewGen, Ethernet, Jitter as well as a variety of Optical Spectrum Analyzers.

The ONT-50 allows a free combination of all available testing modules which can be shared among multiple users simultaneously. Drivers and test libraries support Tcl/Tk and LabWindows to minimize efforts to use ONT-50 in an automated environment

Design and conformance testing of NextGeneration transport networks
Multi-application and multi-port configuration

DSn/PDH modules

- Unframed, framed and muxed DSn and PDH signals
- Single and dual port



EoS interworking

NewGen solution 2.5/10G

- Ethernet over SONET/SDH (EoS)
- Ethernet MAC
- LCAS, GFP, differential delay
- GFP-T (optional, 2.5G only)
- SONET/SDH (PoS optional)

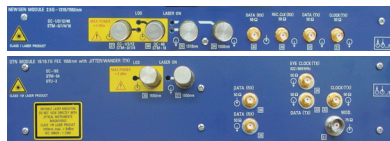

Ethernet modules

- Optical and electrical interfaces
- Ethernet MAC
- Ethernet link



Modules 2.5G/10G/10G-B

- SONET/SDH (PoS optional)
- Jitter/wander for version -B (optional)

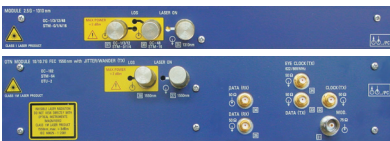

OTN modules 10/10.7G (-B)

- OTN
- SONET/SDH (PoS optional)
- Jitter/wander for version -B (optional)



Jitter module 10G-B, 10/10.7G-B

- High-accuracy jitter evaluated with O.172 Appendix VII + VIII
- Adds jitter to 10G modules
- Adds jitter to OTN module 10/10.7G
- Wander (optional)

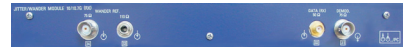

OTN module 2.5/2.7G

- OTN
- SONET/SDH (PoS optional)



DWDM analyzer

- Optical spectrum analysis
- EDFA test
- DFB, FP, LED tests
- Drop option up to 10.7 Gb/s

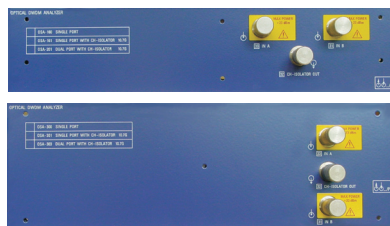

ONT-50

- 4 slots to take any combination of modules
- 12" TFT display



Optical amplifier module

- Amplifier C/L band



3

Configuration guide

ONT-50 mainframe, 4 slots, 12" TFT display		BN 3070/01	
Modules and options	Slots required		Page
DSn/PDH application			
DSn/PDH module single port	1	BN 3070/90.61	5
DSn/PDH module dual port	1	BN 3070/90.62	5
SONET/SDH/PoS applications			
Module 2.5G, 1310 & 1550 nm/electrical	1	BN 3070/90.18	7
Module 2.5G, 1310 nm	1	BN 3070/90.80	7
Module 10G, 1310 nm	1	BN 3070/90.15	8
Module 10G, 1550 nm	1	BN 3070/90.16	8
Module 10G-B, 1310 nm/electrical	2	BN 3070/90.21	8
Module 10G-B, 1550 nm/electrical	2	BN 3070/90.19	8
PoS processing	–	BN 3070/93.03	11
Data over SONET/SDH applications			
NewGen solution 2.5 G, 1310 & 1550 nm/electrical	1	BN 3070/90.41	12
NewGen EoS interworking (NewGen solution 2.5G + Mixed Ethernet module)	2	BN 3070/90.42	12
NewGen solution 10G, 1550 nm/electrical	2	BN 3070/90.45	12
GFP-T processing	–	BN 3070/93.08	17
Ethernet 10/100/1000 M – 4 ports twisted pair	1	BN 3070/90.71	20
Mixed Ethernet module – 2 ports 10/100/1000, 2 ports 1G	1	BN 3070/90.72	21
Ethernet module 1G – 4 ports 1G	1	BN 3070/90.73	21
OTN/SONET/SDH/PoS applications			
OTN module 2.5/2.7 G – 1310/1550 nm/electrical	1	BN 3070/90.17	23
OTN module 10/10.7G – 1550 nm	2	BN 3070/90.30	23
OTN module 10/10.7G-B – 1550 nm/electrical	2	BN 3070/90.32	23
OTN module 10/10.7G-B – 1310 nm/electrical	2	BN 3070/90.33	23
Jitter/Wander applications			
Jitter module 10G-B	1	BN 3070/90.95	26
Jitter module 10/10.7G-B	1	BN 3070/90.93	26
Wander 10/10.7G	–	BN 3070/93.91	27
Optical applications			
Optical amplifier module OAM-200 (C-band)	1	BN 3070/92.20	29
Optical amplifier module OAM-201 (C/L-band)	1	BN 3070/92.21	29
DWDM analyzer OSA-160, single port	2	BN 3070/91.01	29
DWDM analyzer OSA-161, single port & drop	2	BN 3070/91.12	30
DWDM analyzer OSA-201, dual port & drop	2	BN 3070/91.14	30
High performance DWDM OSA-300, single port	3	BN 3070/91.31	31
High performance DWDM OSA-301, single port & drop	3	BN 3070/91.32	31
High performance DWDM OSA-303, dual port & drop	3	BN 3070/91.34	31
PMD test kit	1	BN 3070/91.11	32

ONT-50 mainframe

The ONT-50 is a four-slot mainframe test solution with field upgradable modules. It can be equipped with digital test modules for SONET/SDH/OTN/PoS and NewGen and Ethernet analysis. Optical test modules for optical spectral analysis (OSA) and optical amplifier modules (OAM) are also available thus allowing for simultaneous multi-application and multi-port measurements.

Calibration interval	24 months
----------------------	-----------

General specifications

Power supply (nominal range of use)	
AC line voltage	100 to 240 V
AC line frequency	50/60 Hz
Power consumption	max. 400 VA
Safety class to IEC 61010-1	class I

Ambient temperature

Nominal range of use	+5 to +40 °C/41 to 104 °F
Storage and transport range	-20 to +60 °C/-4 to 140 °F
Dimensions (w/h/d)	approx. 13.8/12.7/8.3 in approx. 350/323/211 mm
Weight (includes protective cover without modules)	approx. 22 lb/10 kg

Clock and synchronization of digital test modules

Internal master clock accuracy (meets T1.101 stratum 3/3E accuracy)	4.6 ppm
---	---------

External synchronization

- * 50/75 Ω, unbalanced, BNC jack:
 - Reference clock: 1 MHz, 1.544 MHz, 2.048 MHz, 5 MHz, 10 MHz
 - Reference clock accuracy: ± 50 ppm
- * 100/120Ω, balanced, Bantam jack
 - E1 (HDB3) 2.048 Mb/s, DS1 (B8ZS/AMI scrambled) 1.544 Mb/s
 - Offset acceptance ± 50 ppm
- * Receive signal

Clock outputs

50 Ω, unbalanced, BNC jack, TTL level

- 1.544 MHz clock
- 2.048 MHz clock

Instrument operation

Interfaces

Parallel port, serial port, PCMCIA port, floppy disk drive, Ethernet (RJ-45), VGA connector

Save, load, export and import

Current instrument settings and measurement results can be saved on internal HD, and re-loaded at a later date. Alternatively, the settings/results can be exported to floppy disk or remote LAN for further processing (report documentation and printouts) and imported onto the same or another ONT-50.

Screen copy print

Printing of screen picture via the ONT-50 parallel port and USB.

Supported printers:

HP Desk Jet Series	600, 690, 895C, 900
Postscript	Printer level 1

Further printouts are available in the corresponding application books.

Touchscreen display

Color TFT screen	12.1", 65536 colors
Resolution	800 × 600 pixels (SVGA standard)

The touchscreen allows for simple point and shoot operation.

Multi-user remote via LAN (remote operation)

In LAN environments, the ONT-50 can be operated interactively via TCP/IP and a standard browser. The ONT-50's multiuser capability offers flexible use of the instrument, allowing several users to access the modules of a single unit. The user interface can be displayed simultaneously on local terminals and in parallel on the ONT. Multiple ONTs can also be operated simultaneously from a single PC.

Remote control for test automation

The ONT-50 is controlled remotely via SCPI commands sent by the customer's program using an Ethernet TCP/IP connection. Modules are addressed independently and in parallel and may be shared among multiple users. Universal driver libraries facilitate automation with specific support for individual applications. Scripting support via Tcl/Tk libraries and LabWindows drivers.

The interactive GUI also works in parallel to remote control, thus enabling the development of automated scripts easily.



5

Digital test modules

JDSU offers a complete line of optical test adapters for all optical interfaces. All optical interface options include the required number of selectable test adapters.

DSn/PDH applications

Highlights DSn/PDH

- Two independent ports
- Multiplex chains DS1/DS, E1/E4 and mixed mux DS1/E1 in DS3

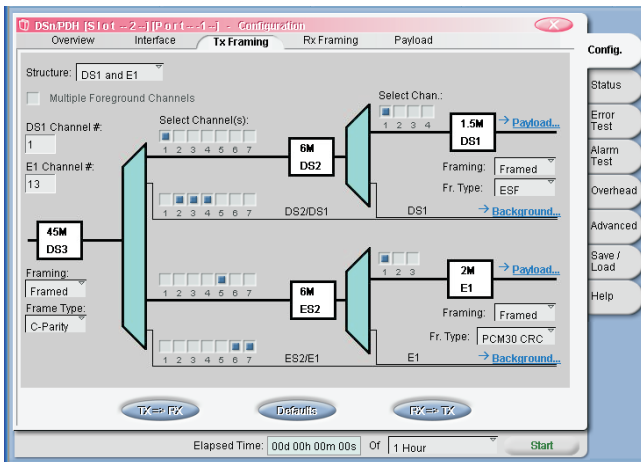

DSn/PDH Modules single port and dual port

Hardware option BN 3070/90.61, BN 3070/90.62 – 1 slot each

The module supports all DSn/PDH rates on each port independently. It provides unframed, framed and structured signals with overhead access and error and alarm insertion and analysis

Clocking all rates

Clock sources	internal, recovered from RX
Internal clock accuracy	as per mainframe clock
Internal clock pulling range	± 500 ppm
Pulling step	0.1 ppm

Interface measurements

Frequency measurement	± 500 ppm
Level measurement	mVpp
Alarms	LOS, Overload, Frequency out of range TX LTI (TX Loss of timing information)
Alarm insertion	LOS
Triggering	continuous, burst once, burst continuous
Burst	M bits/msecs alarm on, N bits/msecs alarm off
M, N	1 to 16.777.215 bits

DS1 Interface

Recommendations	T1.102-1993, G.703
Line rate, codes	1.544 kb/s, B8ZS, AMI
Connectors, balanced	Bantam/100 Ω, RJ-48c/120 Ω
Connectors, unbalanced	BNC/75 Ω

Transmitter DS1

Output level balanced	0 dBdsx/6 Vpp
Output level unbalanced	4.74 Vpp
Output waveform	pre-equalized 0.6, 1.2, 1.8, 2.4, 3.0 dBdsx ft: 0 to 133, 133 to 266, 266 to 399, 399 to 533, 533 to 655

Receiver DS1

Modes	Terminate, Monitor, Bridge
Sensitivity Terminate	≤ 6 dB cable
Sensitivity Monitor	-30 dB/0dB cable, -26 and -23 dB/≤ 6 dB cable
Sensitivity Bridge balanced input (> 1 kΩ)	≤ 6 dB cable
Offset acceptance	± 180 ppm

E1 Interface

Recommendation	G.703
Line rate, codes	2.048 kb/s, HDB3, AMI
Connectors, balanced	RJ-48c/120 Ω, Bantam/100 Ω
Connectors, unbalanced	BNC/75 Ω

Transmitter E1

Output level balanced	6 Vpp
Output level unbalanced	4.74 Vpp

Receiver E1

Modes	Terminate, Monitor, Bridge
Sensitivity Terminate	≤ 6 dB cable
Sensitivity Monitor	-30 dB/0 dB cable, -26 and -23 dB/≤ 6 dB cable
Sensitivity Bridge balanced input (> 1 kΩ)	≤ 6 dB cable
Offset acceptance	± 80 ppm

E3 Interface

Recommendation	G.703
Line rate, codes	34.368 kb/s, HDB3, AMI (TX only)
Connector, unbalanced	BNC/75 Ω

Transmitter E3

Output level	2 Vpp
--------------	-------

Receiver E3

Modes	Terminate, Monitor
Sensitivity Terminate	≤ 12 dB cable
Sensitivity Monitor	-20 dB/≤ 12 dB cable, -26 dB/≤ 6 dB cable
Offset acceptance	± 100 ppm

DS3 Interface

Recommendations	T1.102-1993, G.703
Line rate, codes	44.736 kb/s, B3ZS, AMI (TX only)
Connector, unbalanced	BNC/75 Ω

Transmitter DS3

Output level HIGH	0 ft cable/2.0 Vpp
Output level DSX	450 ft cable/1.0 Vpp
Output level LOW	900 ft cable/0.5 Vpp

6

Receiver DS3

Modes	Terminate, Monitor
Sensitivity Terminate	≤ 12dB cable
Monitor	-20 dB/≤ 12dB cable, -26 dB/≤ 6 dB cable
Offset acceptance	± 100 ppm

E4 Interface

Recommendations	G.703
Line rate, code	139.264 kb/s, CMI
Connector, unbalanced	BNC/75 Ω

Transmitter E4

Output level	1 Vpp
--------------	-------

Receiver E4

Modes	Terminate, Monitor
Sensitivity Terminate	≤ 12 dB cable
Monitor	-20 dB/≤ 6 dB cable, -26 dB/0 dB cable
Offset acceptance	± 100 ppm

DSn/PDH testing

Standard test pattern

Pattern	PRBS 15, 20, 23, 31 (normal and inverted) 16 bit user selectable, all 0s, all 1s bit pattern with programmable length 3 to 32 bit
---------	---

E1, E3, E4 (PDH) unframed

Pattern	Standard test pattern
Alarms	LOS, AIS
Alarms E1 only	Excessive zeros
Errors	Bit error
Errors E1& E3 only	Code

DS1, DS3 unframed

Pattern	Standard test pattern
Special pattern DS1 only	QRSS20, 1 in 8, 2 in 8, 3 in 24
Alarms	LOS
Alarms DS1 only	AIS, Excessive zeros
Errors	BPV, Bit error

E1, E3, E4 (PDH) framed

Frame types E1 (E1 is not channelized)	PCM30, PCM30 CRC PCM31, PCM31 CRC
Frame types E3, E4	G.751
Pattern	Standard test pattern
Alarms	LOS, AIS, LOF, RDI
Alarms E1 only	Excessive zeros
Errors	FAS word/bit, Bit error
Errors E1 only	CRC, REBE
Errors E1& E3 only	Code

Overhead bits E1

Si, Sa4 to Sa8	programmable and displayed online
CAS TS16 (PCM30 only)	programmable 16 byte sequence
SSM (PCM30/31 CRC only)	clear text edit and display

Overhead bits E3, E4

E3 Bit12	programmable and displayed online
E4 Bit14 to 16	programmable and displayed online

DS1, DS3 framed

Frame types DS1	SF, ESF
Frame types DS3	C-Parity, M13
Pattern	Standard test pattern
Special pattern DS1	QRSS20, 1 in 8, 2 in 8, 3 in 24
Special pattern DS3	100
Alarms	LOS, AIS, Frame loss, RAI, Idle
Alarms DS1 only	Excessive zeros
Alarms DS3 only	FTM (Frame Type Mismatch)
Errors	BPV, Frame errors, Bit error
Errors DS1 only	CRC
Errors DS3 only	P-bit, CP-bit, FEBE

Data link DS1 ESF

Format	16bits programmable and displayed online includes synchronization message
--------	--

Overhead bits DS3

X1, X2, C11-/ AIC-bit	displayed online
-----------------------	------------------

Multiplex Chains

E-carrier mux

E3 structured	E1 in E3 via E2
E4 structured	E1 in E4 via E2/E3

E1 is unframed or framed, not channelized. One selected channel is generated and one is measured. Background channels are fully structured

T-carrier mux

DS3 structured	DS1 in DS3 via DS2
DS3 structured	E1 in DS3 via ES2

DS1 is unframed or framed, not channelized. One selected channel is generated and one is measured. Background channels are fully structured

Mixed mux

DS3 mixed	DS1 via DS2 and E1 via ES2
-----------	----------------------------

DS1 and E1 are unframed or framed, not channelized. One selected channel DS1 and one E1 are generated and one of each is measured (dual channel measurement). Background channels are fully structured

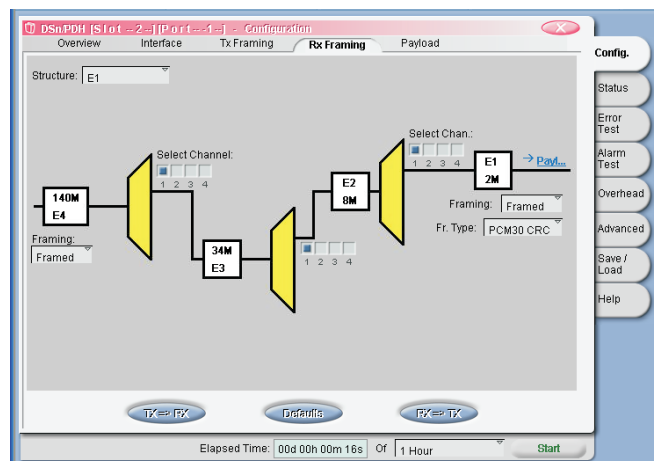

ES2 framing testing

Frame type	E1 in DS3 comply G.747
Alarms	AIS, LOF, RDI
Errors	FAS word/bit
OH Reserved bit S	programmable and displayed online

Bit rate offsets

Measurement	offsets of all mux levels
-------------	---------------------------

DSn/PDH error/alarm insertion and measurement

Simultaneous generation of errors and alarms is supported

Alarm insertion	alarms see correspondent signal
Triggering	continuous, burst once, burst continuous
Burst	M bits/msecs alarm on, N bits/msecs alarm off
M, N	depend on signal type

Error insertion	errors see correspondent signal
Triggering	single, rate, burst once, burst continuous
	rate burst once, rate burst continuous

Rates	9.9E-3 to 1.0E-10
Burst	M errored frames followed by N error free frames
M,N	in frames/ μ s

Alarm detection	alarms see correspondent signals
All alarms are measured with duration	

Error detection	errors see correspondent signals
All errors are measured with count, ratio and duration	

SONET/SDH applications

Highlights SONET/SDH

- **Dynamic error/alarm** insertion including pulse bursts
- **Best-in-class service disruption** test with high level of details and user-accessible settings – no blind spots



Hardware modules

- Module 2.5G, 1310nm
- Module 2.5G, 1310/1550nm
- NewGen Solution 2.5G, 1310/1550nm
- OTN Module 2.5/2.7G, 1310/1550nm

Hardware options – 1 slot each

Module 2.5G, 1310nm	BN 3070/90.80
Module 2.5G, 1310/1550nm, electrical interfaces	BN 3070/90.18
NewGen Solution 2.5, 1310/1550nm, electrical interfaces	BN 3070/90.41
OTN Module 2.5/2.7G, 1310/1550nm, electrical interfaces	BN 3070/90.17

Tests supported

- SONET/SDH from 52 Mb/s to 2.5 Gb/s (page 8)
- EoS (NewGen solution only, page 12)
- OTU-1 testing (OTN module only, page 24)
- PoS (optional, page 11)

General

Line rates	2.488 Gb/s, 622/155/52 Mb/s
	2.666 Gb/s (OTN module only)
Line code	scrambled NRZ

Clock generator

Clock accuracy and synchronization from external signal: see clock specifications of ONT-50 mainframe

Selectable clock offset	± 50 ppm
Step size	0.1 ppm

Optical Interface

The interface meets the specification of ITU-T G.957 / GR.253

Generator

Wavelengths	1310 & 1550 nm
Output level	-2 to +3 dBm

Receiver

Wavelength range	1260 to 1360 nm, 1430 to 1580 nm
Rx offset acceptance	± 100 ppm

Sensitivity

all rates	-8 to -28 dBm
additionally at 155M, 52M	-8 to -34 dBm
Maximum input power (destructive)	+3 dBm
Optical power measurement	-8 to -34 dBm

Electrical interfaces (except BN 3070/90.18)

Impedance	50 Ω , AC coupled
Connector type	SMA

Generator data signal

Bit rates	52 Mb/s to 2.488 Gb/s, 2.666 Gb/s (OTN module only)
Code	scrambled NRZ
Output level	>200 mVpp

8

Generator clock signal

Bit rates	52 Mb/s to 2.488 GHz, 2.666 GHz (OTN module only)
Eye clock	$f_{clock}/4$
Output level	>200 mVpp

Receiver data signal

Bit rates	52 Mb/s to 2.488 Gb/s, 2.666 Gb/s (OTN module only)
Input level, code	200 to 1000 mVpp, scrambled NRZ

Receiver clock signal

Recovered clock	$f_{clock}/4$
Input level	>200 mVpp

- Module 10G (-B), 1310nm
- Module 10G (-B), 1550nm
- NewGen Solution 10G, 1550nm

Hardware options 90.15 and 90.16 – 1 slot each
 Hardware options others – 2slot each

Module 10G, 1310 nm	BN 3070/90.15
Module 10G-B, 1310nm/electrical interfaces	BN 3070/90.21
Module 10G, 1550 nm	BN 3070/90.16
Module 10G-B, 1550nm/electrical interfaces	BN 3070/90.19
NewGen Solution 10G, 1550nm/electrical interfaces	BN 3070/90.45

Tests supported

- SONET/SDH 10Gb/s (page 8)
- EoS (NewGen solution only, page 12)
- PoS (optional, page 11)
- Jitter/wander for versions –B (optional)

General

Line rate, code	9.953 Gb/s, scrambled NRZ
-----------------	---------------------------

Clock generator

Clock accuracy and synchronization from external signal: see clock specifications of ONT-50 mainframe

Selectable clock offset	± 50 ppm
Step size	0.1 ppm

Optical interfaces

The interface meets the requirements of ITU-T G.691/GR.253

Generator

Wavelength	1550 nm
Output level 1550 nm	-3 to +2 dBm
Wavelength	1310 nm
Output level 1310 nm	-4 to 0 dBm

Receiver 1550 nm

Wavelength range	1530 to 1565 nm
Sensitivity	-3 to -14 dBm
Max. input power (destructive power)	+2 dBm
Measuring optical input power	0 to -14 dBm

Receiver 1310 nm

Wavelength range m	1290 to 1330 nm
Sensitivity	-3 to -12 dBm
Max. input power (destructive power)	0 dBm
Measuring optical input power	-14 to 0 dBm

Generator eye clock signal

Bit rate	622 MHz
Output level	sinusoidal >200 mVpp

Electrical interfaces (except BN 3070/90.15, /90.16)

Impedance	AC coupled 50 Ω
Connector type	SMA

Generator data signal

Bit rate, code	9.951 Gb/s, scrambled NRZ
Output level	>200 mVpp

Generator clock signal

Bit rate	9.951 GHz
Output level	>200 mVpp

Receiver data signal

Bit rate, code	9.951 Gb/s, scrambled NRZ
Input level	100 to 600 mVpp

SONET/SDH testing

Signal Structure

SONET mappings	VT 1.5/ 2/ 6, STS-1/ 3c/ 12c/ 48c
For module 10G only	STS-192c
SDH mappings	AU-4: VC-12, VC-11, VC-2, VC-3, VC-4, VC-4-4c/16c
For module 10G only	AU-3: VC-12, VC-11, VC-2, VC-3 VC-4-64c

Payload

- * Test pattern without stuffing bits (Bulk O.181)
- * Unframed DS_n/PDH test pattern
- * Framed and muxed DS_n/PDH signals (refer to page 6)

Test pattern

- * $2^{15}-1/2^{23}-1/2^{31}-1$ (ITU and inverted),
- * 16 bit user selectable word
- * “Traffic” mode: the content of the containers is ignored thus allowing analysis of live traffic.

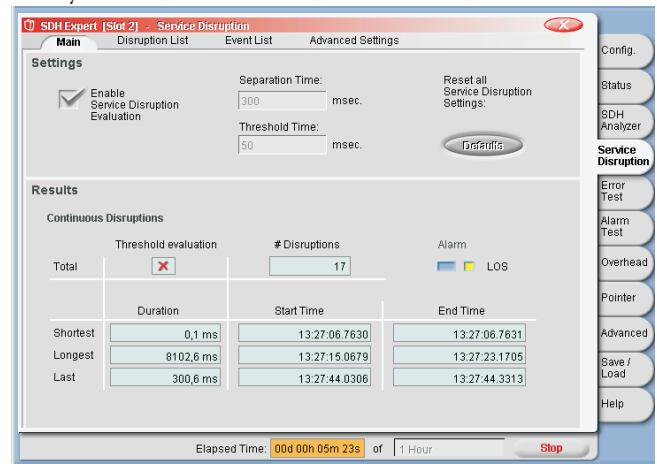

Background channels

Identically structured

Fill pattern independent from test pattern

* $2^{15}-1/2^{23}-1/2^{31}-1$ (ITU and inverted),

* 16 bit user selectable word

Measurements

Error measurement SONET/SDH

Bit errors, FAS, B1, B2, MS-REI/REI-L, B3, HP-REI/REI-P, LP-BIP/BIP-V, LP-REI/REI-V

All errors, count, ratio, seconds

Alarm detection SONET/SDH

SONET: LOS, SEF, LOF, AIS-L, RDI-L, LOP-P, AIS-P, RDI-P, UNEQ-P, LOM, AIS-V, RDI-V, RFI, LOP-V, UNEQ-V, PDI-V, Pattern loss

SDH: LOS, OOF, LOF, MS-AIS, MS-RDI, AU-LOP, AU-AIS, HP-RDI, HP-UNEQ, TU-LOM, TU-AIS, LP-RDI, LP-RFI, TU-LOP, LP-UNEQ, Pattern loss

Resolution 100 ms

Event measurement DSn/PDH

Please refer to page 6, DSn/PDH testing.

Result display of errors and alarms

Numerical display

Count, ratio and seconds are displayed for each error, seconds are displayed for each alarm.

Tabular display

Display of all results with time stamps: start, stop, duration/count

Graphical display

Events are displayed as bar graphs versus time. Cursors allow for easy identification and zooming-in on the results. Filters enable event selection. Time axis second, minute, hour

Measurement interval

The application can be started and stopped manually or automatically with the use of a timer.

Measurement stop intervals are 1 min, 15 min, 1 h, 24 h, 72 h, 96 h or user definable.

Service disruption test

The ONT-50 provides one of the most comprehensive Service Disruption Tests available.

In synchronous networks, Automatic Protection Switching (APS) is used to switch traffic to backup links if faults occur. During the switch event the service will be disrupted. Limits are defined and need to be checked for this Service Disruption Time.

To analyze service disruption times, the ONT-50 generates a high-speed event list as a result of all detected events.

Criteria to trigger service disruption test, selectable

SONET

Alarms SEF, LOF, AIS-L, RDI-L, AIS-P, RDI-P, LOP-P,
Errors FAS, B1, B2, REI-L, B3, REI-P, payload errors

SDH

Alarms OOF, LOF, MS-AIS, MS-RDI, AU-AIS, HP-RDI, AU-LOP, ,
Errors FAS, B1, B2, MS-REI, B3, HP-REI, payload errors

Event resolution frame based 125 μ s

For troubleshooting, two independent sets of criteria may be defined to trigger and store two events.

Separation time 1 ms to 60000 ms

Separation time starts at the end of the last event. Separation time is used to determine if the following event is a continuation of the same disruption (event occurs within separation time) or the start of the next disruption (event occurs after separation time has elapsed).

Service disruption results are stored in a list with start/stop times and duration.

The shortest, longest, and last disruptions are displayed as summary results.

The threshold to identify a violation of allowed service disruption time is 1 ms to 60000 ms

In addition to the Service Disruption List, all base data events are stored in a high-speed event list with time stamps. This allows for the tracking of individual events caused by Service Disruptions.

Pointer analysis

- STS/AU and VT/TU pointer
- New value
- Count of increments, decrements, NDF

Message evaluation (TIM, PLM)

- J0, J1, J2:
programmable 16 and 64 byte ASCII sequence
TIM evaluation: expectation value editable as criterion for TIM
- C2, V5:
signal label clear text selection PLM
evaluation: expectation value editable as criterion for PLM
- J0, J1, J2, C2, V5:
clear text display

TOH/SOH and POH evaluation

- Manipulation and analysis of all accessible TOH/SOH and POH overhead bytes (including K1/K2, C2, V5, J0/J1/J2)
- TOH/SOH and POH display
- K1, K2 and S1 are shown and may be set using clear text messages

Byte capture SOH/TOH

To analyze the SOH/TOH functions, it is necessary to capture individual bytes vs. time, allowing detection of errors or short term changes with frame level resolution. The capture function is started by a selectable trigger.

10

Values for one/two selected bytes are stored and can be accessed subsequently in a table of values.

Particularly in capturing the APS sequences, bytes K1 and K2 are displayed in clear text.

Selectable bytes for SOH/TOH	all bytes
Captured parameters	byte value, number of frames and correspondent time

Storage depth of one byte or K1/K2 combination

post trigger	up to 256 value changes
pre trigger	up to 256 value changes
Trigger conditions	pre, post, center
Trigger events	user defined byte value, bit mask (compare, not compare, don't care)

Performance monitoring

For SONET:

Evaluation of ES, EFS, SES, UAS and SEFS (GR 253, T1.231) ESA, ESB

For SDH:

Performance monitoring G.826

EB, BBE, ES, EFS, SES, and UAS are evaluated. PASS/FAIL assessments based on line length allocation of 0.1 to 100%.

The SES and UAS thresholds are user-programmable. In-Service Measurement (ISM) of the near end and the far end of a selected path, as well as out-of-service (OOS) measurements, are supported.

Performance monitoring G.828 and G.829

The G.828 defines error performance parameters for international synchronous paths.

EB, BBE, ES, EFS, SES, and UAS are evaluated. PASS/FAIL assessments are based on a line length allocation of 0.1 to 100%. The SES and UAS thresholds are user-programmable. The SEP can be switched off for assessment. G.829 defines error performance events and block structures for SDH multiplex and regenerator sections.

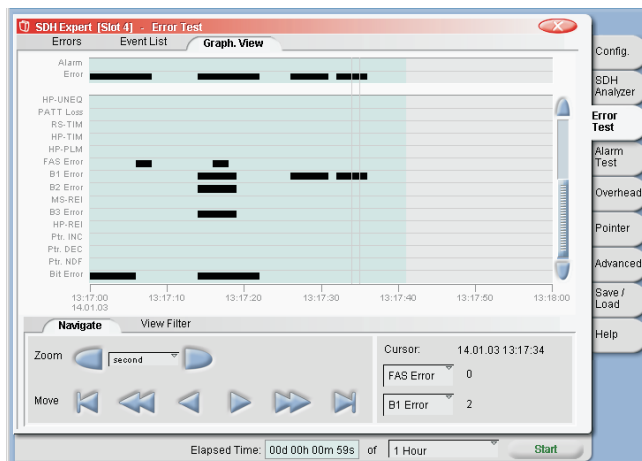

Event generation

Event generation DSn/PDH

Please refer to page 6, DSn/PDH testing.

Error insertion

Error types	bit errors, random errors (after scrambling), FAS, B1, B2, MS-REI/REI-L, B3, HP-REI/REI-P, LP-BIP/BIP-V, LP-REI/REI-V
-------------	---

Triggering

Once	all errors
------	------------

Error rate for

FAS	1×10^{-2} to 1×10^{-10}
bit errors	1×10^{-3} to 1×10^{-10}
random	1×10^{-4} to 1×10^{-10}
all others minimum values	1×10^{-10}

The maximum value ensures that all parity bits in all frames are affected.

Step size for mantissa	0, 1
------------------------	------

Burst error	once and continuous
	M errored frames followed by N error-free frames
	All errors except random and bit error

Section and high order path	M, N = 1 to 65535 or 125 μ s to 8 s
Low order path	M, N = 1 to 65535 or 500 μ s to 32 s

Rate burst error

Defined error rate with additional burst time window

All errors except random and bit error

Parameters see under "error rate" and "burst".

Alarm insertion

SONET: LOS, LOF, TIM-S, AIS-L, RDI-L, LOP-P, AIS-P, UNEQ-P, PLP-P, TIM-P, PDI-P, LOM-V, AIS-V, UNEQ-V, PLM-V, TIM-V, RDI-V, RFI-V

SDH: LOS, LOF, RS-TIM, MS-AIS, MS-RDI, AU-LOP, AU-AIS, HP-UNEQ, HP-PLM, HP-TIM, HP-RDI, TU-LOM, TU-LOP, TU-AIS, LP-UNEQ, LP-PLM, LP-TIM, LP-RDI, LP-RFI

Triggering

LOS	on/off
-----	--------

All others	on/off or bursts
------------	------------------

Burst	once and continuous
-------	---------------------

M frames with alarm ON, N frames with alarm OFF

Section and high order path	M, N = 1 to 65535 or 125 μ s to 8 s
-----------------------------	---

Low order path	M, N = 1 to 65535 or 500 μ s to 32 s
----------------	--

Pointer generation

- STS/AU and VT/TU pointer: Increment, decrement, new value
- Pointer sequences G.783 with programmable spacing
- Set new value and correspondent container offset
- Trigger: inc/dec single, periodical, alternating

Through mode

The received signal is looped through the module and re-transmitted. The receiver signal may be monitored (as per 'Measurements') and events may be included in the transmitted signal.

Event injection

Errors B1, B2, FAS, REI-L/MS-REI, Random
 Triggering: ones, rate, burst, rate burst as per error insertion in termination mode
 Alarms LOS, LOF, AIS-L/MS-AIS, RDI-L/MS-RDI, AIS-P/AU-AIS, LOP-P/AU-LOP
 Triggering: on/off, burst as per alarm insertion in termination mode.

PoS processing

Software option BN 3070/93.03.

The combined IP/PoSSDH and IP/PoSNET book allows the user to check the physical layer (SONET/SDH) as well as traffic in IP networks with HDLC/PPP framing.

Signal Structure

SONET mappings with PoS

STS-1/3c/12c/48c/ (192c – 10G modules)

SDH mappings with PoS

AU-4: VC-4, VC-4-4c/16c/ (64c – 10G modules)

AU-3: VC-3

Fill patterns

- HDLC/PPP like framing (RFC 1662)
- CISCO HDLC

PoS measurements

- Traffic parameters on transmit side
- Frame size, frame rate
- Sustained bandwidth
- Utilization

Traffic analysis on receive side

Frame rate, total frames received, analyzed test frames
 Link bandwidth, link utilization
 Average delay, delay variation

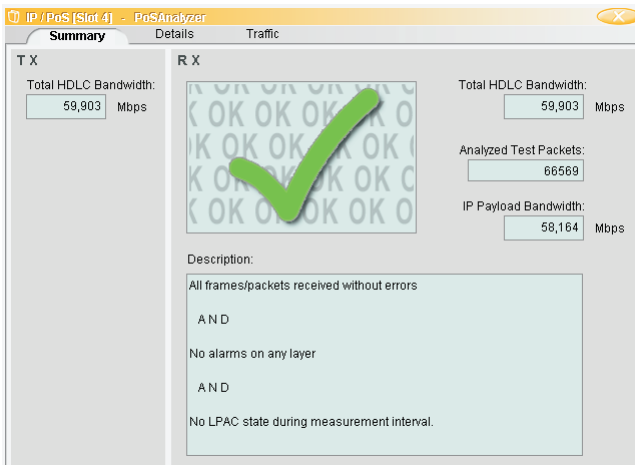

Error insertion

Error types FCS error, invalid frame, lost packets
 Triggering single

Error measurement

All errors count, ratio, duration

Alarm detection

Red, Yellow, LPAC duration

Resolution 100 ms

Results

Results are displayed in count and ratio and the summary result provides clear GO/NOGO indication.

Data over SONET/SDH applications

Highlights EoS

- **High and Low order** virtual concatenation up to 1 Gb/s service
- **VCG search** for easy configuration of the receiver
- **Enhanced Differential Delay** generation
- Worldwide first tester with **full LCAS emulation**
- **LCAS protocol tracer** for trouble finding
- **GFP framing** and manipulation of GFP header
- **MAC framing** of different types, Ethernet link layer and MAC layer analysis
- Complete interworking test solution NewSONET/SDH with Ethernet **in one unit**

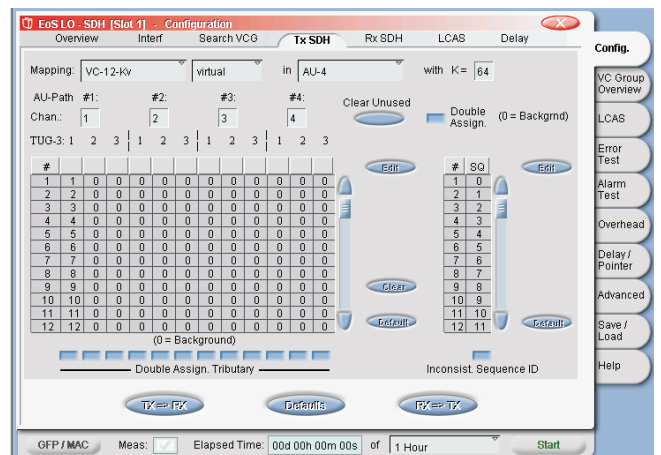

Hardware modules

NewGen solution 2.5G
 NewGen solution 10G

NewGen solution 2.5G, BN 3070/90.41 – 1 slot
NewGen solution 10G, BN 3070/90.45 – 2 slots

Tests supported

- Ethernet over SONET/SDH (page 12)
- Ethernet MAC (page 16)
- SONET/SDH (page 8)
- GFP-T processing (NewGen solution 2.5G only, page 17)
- PoS processing (software option, page 11)

General/interfaces

Please refer to hardware modules 2.5G and 10G (pages 7 and 8).

NewGen EoS interworking

BN 3070/90.42 – 2 slots

One of the key application for system verification is **interworking** of NewSONET/SDH with Ethernet interfaces. Only with this combination in one test equipment it is possible to evaluate all dependencies between the transport and service interfaces.

The NewGen EoS interworking option consist of the NewGen solution 2.5G (BN 3070/90.41) plus the Mixed Ethernet modules (BN 3070/90.72, page 18).

It supports all available functions for SONET/SDH, NewSONET/SDH up to 2.5 Gb/s (including Ethernet traffic) as well as electrical and optical Ethernet interfaces up to 1 Gb/s.

PoS is optionally available.

EoS (SONET/SDH) testing

Ethernet over SONET/SDH testing up to 2.5G is supported by
NewGen solution 2.5G *BN 3070/90.41*
and NewGen EoS interworking *BN 3070/90.42.*

EoS at 10G is supported by NewGen solution 10G, *BN 3070/90.45.*
 EoS testing includes all the associated topics addressed by the New SONET/SDH technology including virtual concatenation (VCat), link capacity adjustment scheme (LCAS), generic frame procedure (GFP), and the generation and analysis of Ethernet frames.

VCat – Virtual Concatenation

Virtual concatenation implementation is in accordance with ITU-T G.707, G.783, and ANSI T1.105-2001. One virtual concatenation group (VCG) is supported, and the selectable mappings and group sizes are as follows:

High order VCat

VC-4-7v, VC-3-21v (AU-3), VC-4, VC-3 (AU-3)
 STS-3c-7v, STS-1-21v, STS-3c, STS-1

All members can be distributed in all channels of the SONET/SDH signal.

Low order VCat

VC-11-64v, VC-12-64v, VC-3-12v (AU-4), VC-3 (AU-4), VC-12, VC-11
 VT-1.5-64v, VT-2-64v, VT-1.5, VT-2

All members can be distributed in up to 4x VC-4/STS-3c or up to 12x VC-3/STS-1 of the SONET/SDH signal.

Group size is selectable from 1 to the maximum.

All path layer parameters including SQ number, overhead, errors, and alarms are supported for every member of the VCG individually.

In the case of a group with one member standard VC and VCat can be mixed for RX and TX.

VCG search utility

For the low order mappings, a search VCG utility lets you scan the selected physical signal structure to find a dedicated virtual concatenated group. Filters help to determine the right group. The detected group can be used for setting either the Rx, or the Rx & Tx signal structure, for further testing.

VCG search 10GVC is under study.

Sequence numbers generation

User programmable, per member, with LCAS disabled.

Sequence numbers are automatically assigned with LCAS enabled.

Sequence numbers evaluation

LCAS disabled

Expected sequence numbers are user programmable, per member. If expected (ExSQ) and accepted (AcSQ) SQ numbers are not equal, a mismatch alarm is generated.

Sequence number mismatch defect	SQM
---------------------------------	-----

LCAS enabled

Sequence number acceptance is in accordance with LCAS protocol rules

Error insertion

Error types	Random, FAS, B1, B2, REI-L/MS-REI
-------------	-----------------------------------

Triggering

Once	all errors
------	------------

Error rate for	
FAS	1×10^{-2} to 1×10^{-10}
bit errors	1×10^{-3} to 1×10^{-10}
random	1×10^{-4} to 1×10^{-10}
all others minimum values	1×10^{-10}

The maximum value ensures that all parity bits in all frames are affected.

Step size for mantissa	0, 1
------------------------	------

Burst error	once and continuous
-------------	---------------------

M errored frames followed by N error-free frames

All errors except random and bit error M, N = 1 to 65535 or 125 μs to 8 s

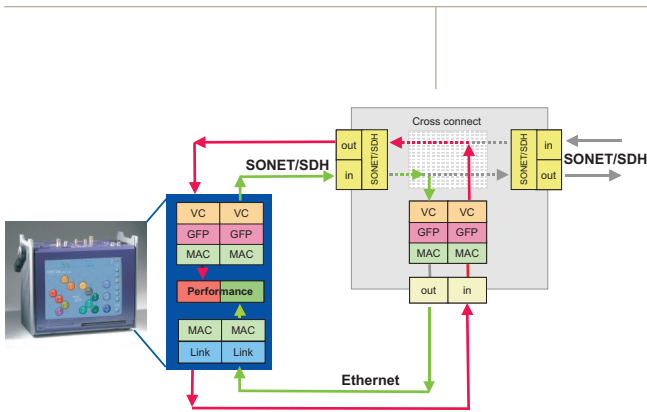

Ethernet over SONET/SDH interworking

Error insertion path

Error types	B3, REI-P/HP-REI, BIP-V/LP-BIP, REI-V/LP-REI
Insertion	single or multiple member
Minimum values	1×10^{-10}
The maximum value ensures that all parity bits in all frames are affected.	
Step size for mantissa	0, 1
Burst error	once and continuous
	M errored frames followed by N error-free frames
High order path	M, N = 1 to 65535 or 125 μ s to 8 s
Low order path	M, N = 1 to 65535 or 500 μ s to 32 s

Error analysis

All errors count, ratio and seconds

Errors are analyzed for all members and are shown both independently and as group errors (e.g. GP-B3).

Alarm insertion

Alarm types	LOS, LOF, AIS-L/MS-AIS, RDI-L/MS-RDI
<i>Triggering</i>	
LOS	on/off
All others	on/off or bursts
Burst	once and continuous
	M frames with alarm ON, N frames with alarm OFF
	M, N = 1 to 65535 or 125 μ s to 8 s

Alarm insertion path

SONET:	AIS-P, RDI-P, LOP-P, UNEQ-P, OOM2, OOM1, AIS-V, RDI-V, LOP-V, UNEQ-V, PLM-P
SDH:	AU-AIS, HP-RDI, AU-LOP, HP-UNEQ, OOM2, OOM1, TU-AIS, LP-RDI, TU-LOP, LP-UNEQ, LP-PLM
Insertion	single or multiple members
<i>Triggering</i>	
All	on/off or bursts
Burst	once and continuous
	M frames with alarm ON, N frames with alarm OFF
High order path	M, N = 1 to 65535 or 125 μ s to 8 s
Low order path	M, N = 1 to 65535 or 500 μ s to 32 s

Alarm analysis

All alarms are shown in seconds

Alarms are analyzed for all members and are shown independently and as group alarms (e.g. GP-OOM1)

Alarms as inserted above

Additional detected alarms SEF (SONET), OOF (SDH), Loss of alignment (LOA), Loss of multi frame (per member) (LOM), Out of multi frame (per member) (OOM1), (OOM2)

TOH/SOH and POH

Manipulation and analysis is provided for:

- All accessible TOH/SOH bytes
- POH bytes of all members independent
- Traces J0, J1, J2 in clear text J1, J2 of all members independently
- Sync status (S1) in clear text
- The signal label (C2, V5) and the extended signal label (K4, Z7) of all members are independently in clear text.

Background channels

All background channels have the same pattern.

Fill patterns

$2^{23}-1, 2^{31}-1$, 16 bit user selectable word

Enhanced differential delay generation

Delay value, of every member, can be set independently

High order VCat

Range, programmable	0 to 100 ms
Granularity	$N \times 125 \mu$ s (MFI) + $M \times 0.16 \mu$ s (Ptr)
Pointer rate	8 to 2000 1/s

Low order VCat

VC-3	0 to 100 ms
Granularity	$N \times 125 \mu$ s (MFI) + $M \times 0.16 \mu$ s (Ptr)
Pointer rate (VC-3)	8 to 2000 1/s
VC-11/-12, VT-1.5 /-2	0 to 256 ms
Granularity	$N \times 500 \mu$ s + $M \times 4.8 \mu$ s (Ptr)
Pointer rate	2 to 500 1/s

Three modes are available to set the delays.

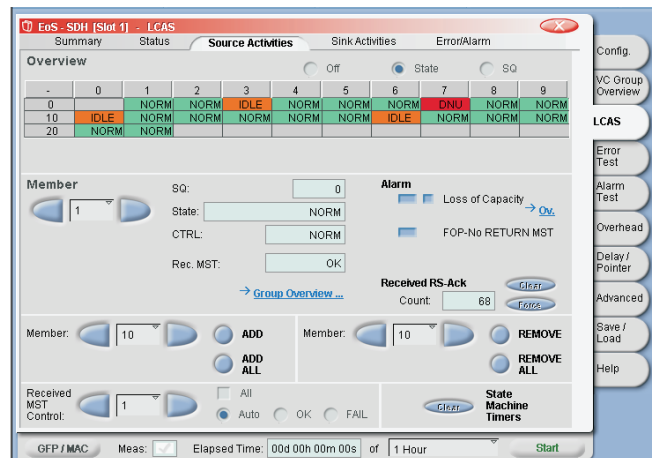

Direct mode

Delay values are set manually on a per member basis. At the click of a button, delays are applied instantly for all group members in parallel. Service is disrupted temporarily.

This mode is useful to simulate the effect of APS actions.

Pointer mode

Delay values are set manually on a per member basis. At the click of a button, instrument starts to perform pointer movements until programmed delay is set for each group member. Pointer movements for all group members are executed in parallel. Pointer rate is user programmable. No service disruption occurs.

This mode is useful to simulate the effects of delay wander.

Stress mode

This is an automatic stress test mode. In an endless loop, sets of automatically generated delay values are generated and auto-applied using pointer mode. A programmable waiting time is inserted between sets of delay values. Pointer rate is user programmable. Delay value sets are generated by a random number generator. User programmable random number generator speed allows true random, as well as reproducible pseudo random operation. This mode requires no user interaction.

This mode is useful for automatic reassembler test.

Differential delay analysis

Parallel measurement, of differential delay, provided for each group member. Calculation of differential delay provided for entire group.

Results provided for all members and groups, differential delay in ms

Measurement range (HO- and LO-VCat)	256 ms
Reassembly range (HO-VCat and VC-3-Nv (AU-4))	128 ms
Reassembly range (LO-VCat)	256 ms

Pointer analysis

- STS/AU pointer values of all members
- Counts of increment, decrement and NDFs
- VT/TU pointer analysis functionality is to be determined

Link capacity adjustment scheme (LCAS)

LCAS implementation is in accordance with ITU-T G.7042, G.707, and ANSIT1.105.02-2001

The functionality encompasses:

- Emulation of state machines for source and sink
- Monitoring of LCAS control packets (H4, K4/Z7)
- Generation and evaluation of control packets
- Generation and evaluation of member status information
- Source reacts automatically to received member status
- Full manual control of state machines supported
- Full trace of all changes in the protocol communication

LCAS protocol emulation

An LCAS source state machine is implemented for every member of the Tx VCG. An LCAS sink state machine is implemented for every member of the Rx VCG. The ONT-506/-512 provides state machine control as well as state machine monitoring capabilities. LCAS protocol emulation can be disabled. With LCAS disabled, FIXED control packets are generated (all H4/K4/Z7 byte information is zero except sequence number and multiframe indicators).

Source state machine control (per member)

Direct command	ADD, REMOVE, ADD ALL, REMOVE ALL
Overwrite received member status	OK, FAIL, AUTO
Force re-sequence acknowledge	Rx RS-Ack
MSU timer supported	

Sink state machine control (per member)

Direct command	ADD, REMOVE, ADD ALL, REMOVE ALL
Overwrite generated member status	FAIL, AUTO
Force re-sequence acknowledge	Tx RS-Ack
Force member status alarm	MSU

Source state machine monitoring (per member)

Transmitted sequence number	
Received re-sequence acknowledge	Count
Following commands are shown in clear text:	
Machine state	IDLE, ADD, NORM, DNU, REMOVE
Transmitted control word	ADD, NORM, EOS, IDLE, DNU
Received member status	OK, FAIL

Sink state machine monitoring (per member)

Sink monitoring information is analyzed after differential delay compensation.

Received sequence number	
Transmitted re-sequence acknowledge	Count
Following commands are shown in clear text:	
Machine state	IDLE, FAIL, OK
Received control word	ADD, NORM, EOS, IDLE, DNU, FIXED
Received alarms	LOC, MSU, FOP CRC, NON LCAS



LCAS defects and alarms

Source

Loss of transport capacity	TxLOC
Loss of partial transport capacity	TxLOPC
Loss of total transport capacity	TxLOTC

Sink

Loss of transport capacity	RxLOC
Loss of partial transport capacity	RxLOPC
Loss of total transport capacity	RxLOTC
Failure of protocol excessive CRC errors	FOP_CRC

LCAS state tracer

In the emulation mode and in the monitoring mode the LCAS State Tracer traces each change in the LCAS control packet for all members independent if sent or received. This allows e.g. to verify the response time to an add command.

The trace can be started manually.

All changes are displayed separate for source or sink in a dedicated view.

All changes are traced with event and accurate timestamp

Event accuracy 1 ms and frame based

GFP-F – Generic Frame Procedure (framed)

The GFP functionality provides Ethernet MAC encapsulation and mapping/de-mapping of GFP to SONET/SDH virtual concatenation. Implementation is in accordance with ITU-T G.7041, G.707, and ANSI T1.105.02-2001 GFP-F (frame mapped Ethernet).

The functionality encompasses:

- Generation and analysis of GFP frame types
- GFP traffic generation and analysis
- Core header processing
- Payload type header processing
- Frame based Ethernet MAC frame encapsulation
- Error and alarm processing

GFP traffic generation

Traffic profile

Frame size	72 to 65539 bytes
Bandwidth dependent on VCat	0 to max. 1 Gb/s
Details see chapter Ethernet MAC layer.	

Payload type header settings

PTI	Client data or client management frame
PFI	FCS off/on
EXI	Null extension header or linear frame or ring frame
UPI (client data)	clear text selection acc. to ITU-T G.7041
UPI (client management)	loss of client signal (LOCS) and loss of client character synchronization (LOCCS)

Linear extension header settings

CID and Spare editable	00 to FF
------------------------	----------

Error insertion

Core header	single and multiple bit error
Payload type header	single and multiple bit error
Linear frame header	single and multiple bit error
Payload FCS	single bit error

Alarm insertion

Loss of frame delineation	LFD
Client signal fail type (LOCS, LOCCS) selectable with PTI/UIPI	CSF
CSF frame period	500 ms

Receiver GFP frame filter

On Rx, filtering based on type header fields, is performed.

The filter criteria are reference values and bit masks. Only error free frames, matching the reference value and bit masks, are forwarded to MAC layer processing.

Core, payload, and extension header error detection as well as error correction are supported.

Reference values of parameters payload type and extension header settings are programmable.

Error detection

Error types	Core header single, Payload type header single & multiple, Linear frame single & multiple and payload FCS
Evaluation	count, ratio, duration

Alarm detection

Alarm types	LFD, CSF
Evaluation	duration

GFP frame detection

Frame types	Idle, client data with/without linear frame, client data with/without FCS, CSF
Evaluation	count, ratio

Online view of payload type and extension header values.

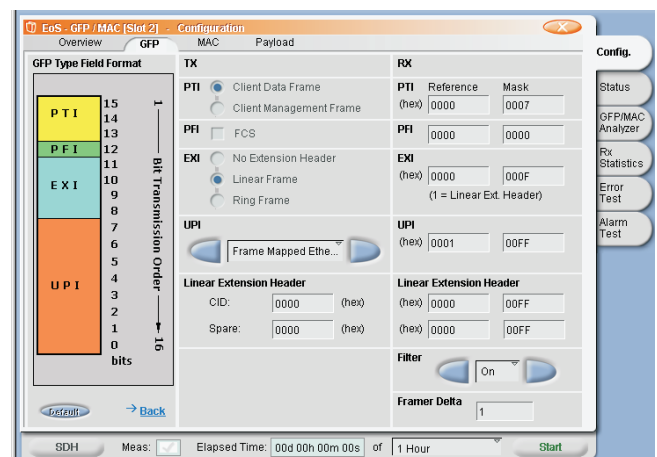

GFP traffic analysis

Tx total bandwidth dependent on VCat	0 Mb/s to max. 1 Gb/s
Tx total utilization	0 to 100%
Rx total bandwidth dependent on VCat	0 Mb/s to max. 1 Gb/s
Rx total utilization	0 to 100%

Ethernet MAC layer testing

The EoS and Ethernet book support the following Ethernet frame formats:

- Ethernet II frames (ISO/IEC 8802-3)
- IEEE 802.3 frames
- IEEE 802.2 (LLC) frames
- SNAP frames
- VLAN tagged frames
- Double tagged VLAN frames.

Measurement overview

- Throughput/lost packets
- Transfer delay/latency
- Connectivity
- Flow control
- Traffic analysis/utilization
- Error and alarm analysis

MAC traffic generation

Traffic profiles	constant, burst
Generator modes	once, continuous
Frame size	64 to 1518/1522 bytes
Oversized (jumbo)	max. 65 kB
Bandwidth	0 to max. 1 Gb/s
Inter packet gap (IPG) minimum	editable from 3 to 12
Back-to-back frames	on/off
enables maximum bandwidth by forcing the traffic to minimum IPG	

<i>Constant mode</i>	
Bandwidth	0.1 Mb/s to max. 1 Gb/s

<i>Burst mode</i>	
Peak bandwidth	0.1 Mb/s to max. 1 Gb/s
Sustained bandwidth	0.1 to 100%
Burst size	1 to 65 k frames
Frames per shot (once)	1 to 65 k

Note: Actual maximum bandwidth can be below the stated value depending on port type, mapping, and group size. The ONT-506/-512 is capable of generating 100% load for every combination of port type, mapping, and group size.

MAC frame settings

MAC frame parameters can be set to specific values depending on the selected Ethernet frame type

Header types	Value
VLAN types	Tag protocol identifier (TPI), Tag control information priority, TCI-VLAN identifier
LLC header	Destination service access point DSAP, Source service access point SSAP
LLC/SNAP header	Protocol type, Organizational unique identifier,

Error insertion

Error type	Oversized, Runt, Jabber, FCS, Alignment (for 1 G optical Ethernet: Alignment only valid, Runt not valid)
Triggering	Once, continuous, burst once, burst cont., rate, rate burst once, rate burst cont.
Rate	1E-4 to 1E-8
Bursts	N for units ON, M for units OFF
N and M	1 frame up to 262143 frames

Receiver MAC frame filter

Filtering, based on source and destination address information, is performed.

The filter criteria are reference values and bit masks. Only error free frames matching the reference value and bit masks are forwarded to network performance evaluation. Reference values for parameters as per “MAC frame settings” are programmable.

Error detection

Error type	In range, runt, Oversized, FCS, jabber, Errored, lost packets
Evaluation	count, ratio, duration

MAC payload modes

- JDSU test frame. The content is necessary for evaluation of lost packets and transfer delay
- BER with 2^{23-1} , 2^{31-1} , 32 bit user selectable word
- Live traffic for Rx, suppressing evaluation of the MAC payload content.

Payload error insertion

Error type	lost frame or bit error
Trigger	once

Network performance

Error type	Lost packets or bit error
Evaluation	count, ratio, duration
Alarm type	LPAC (Loss of Performance Assessment Capability) (active if higher layer alarm or no valid traffic for 10 s)
Evaluation	duration
Transfer delay integrated, current	0 to 42.9 s
Transfer delay variation integrated, current	0 to 42.9 s

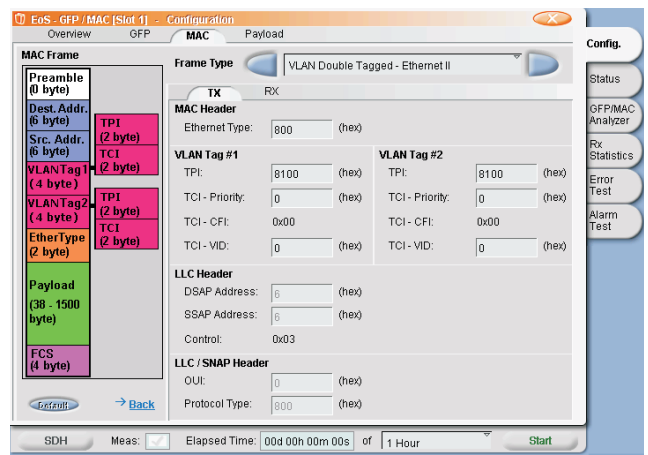

MAC frame statistics

Total MAC traffic

Total, good, broadcast, multicast, VLAN tagged, VLAN double tagged, paused

Analysis	count, rate
----------	-------------

Filtered MAC traffic

MAC bandwidth	Mb/s
Frame rate	kb/s
Frames	count

MAC layer flow control (PAUSE)

Instrument responses to received PAUSE frames as specified by IEEE 802.3 (2002).

Supported duplex mode	full duplex
-----------------------	-------------

Receiver

PAUSE frame evaluation	count, rate, current PAUSE quanta
------------------------	-----------------------------------

Generator

Generator reaction to received

PAUSE frames	switch on/off
Generated Alarm	PAUSED
In case of Ethernet over SONET/SDH the quanta time value is selected related to these values	10 Mb/s, 100 Mb/s, 1000 Mb/s

GFP-T processing

Highlights GFP-T processing

- Extensive CRC-16 error insertion capability
- Capture of superblock
- Programmable service sequences

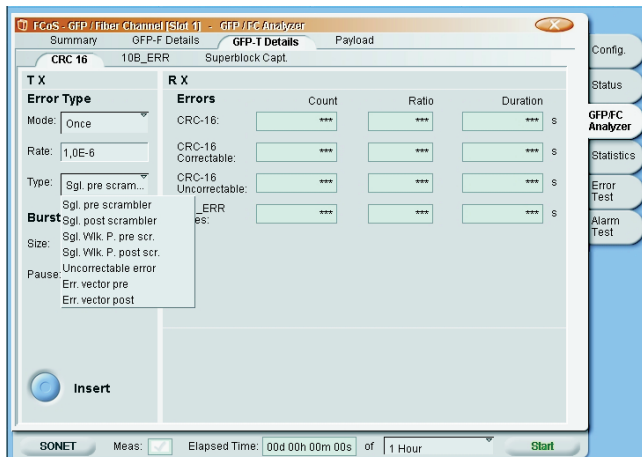

Software option GFP-T processing BN 3070/93.08

FCoS testing is supported by the NewGen solution 2.5G, BN 3070/90.41 and NewGen EOS interworking, BN 3070/90.42.

FCoS testing contains all topics related to test Fibre Channel services over SONET/SDH. The following technologies are addressed: Virtual concatenation (VCAT), generic framing procedure (GFP), GFP-T and the handling of the PRBS and Fibre Channel (FC) service simulation.

VCat – Virtual Concatenation

Virtual concatenation implementation is in accordance with ITU-T G.707, G.783, and ANSI T1.105-2001. One virtual concatenation group (VCG) is supported, and the selectable mappings and group sizes are as follows:

High order VCat

VC-4-7v, VC-3-21v (AU-3)
STS-3c-7v, STS-1-21v

Group size is selectable from 1 to the maximum.

All path layer parameters including SQ number, overhead, errors, and alarms are supported for every member of the VCG individually.

Sequence numbers generation

User programmable, per member.

Sequence numbers evaluation

Expected sequence numbers are user programmable, per member. If expected (ExSQ) and accepted (AcSQ) SQ numbers are not equal, a mismatch alarm is generated.

Sequence number mismatch defect	SQM
---------------------------------	-----

Error insertion

Error types	Random, FAS, B1, B2, REI-L/MS-REI
-------------	-----------------------------------

Triggering

Once	all errors
Error rate for	
FAS	1×10^{-2} to 1×10^{-10}
bit errors	1×10^{-3} to 1×10^{-10}
random	1×10^{-4} to 1×10^{-10}
all others minimum values	1×10^{-10}

The maximum value ensures that all parity bits in all frames are affected.

Step size for mantissa	0, 1
------------------------	------

Burst error once and continuous M errored frames followed by N error-free frames

All errors except random and bit error M, N = 1 to 65535 or 125 μs to 8 s

Error insertion path

Error types	B3, REI-P/HP-REI, BIP-V/LP-BIP, REI-V/LP-REI
Insertion	single member or multiple members
Triggering all errors	single

Error analysis

All errors count, ratio and seconds

Errors are analyzed for all members and are shown both independently and as group errors (e.g. GP-B3)

Alarm insertion

Alarm types	LOS, LOF, AIS-L/MS-AIS, RDI-L/MS-RDI
Triggering	on/off

Alarm insertion path

SONET:	AIS-P, RDI-P, LOP-P, UNEQ-P, OOM2, OOM1, AIS-V, RDI-V, LOP-V, UNEQ-V, PLM-P
SDH:	AU-AIS, HP-RDI, AU-LOP, HP-UNEQ, OOM2, OOM1, TU-AIS, LP-RDI, TU-LOP, LP-UNEQ, LP-PLM
Insertion	single member or multiple members
Triggering	on/off

Alarm analysis

All alarms are shown in seconds

Alarms are analyzed for all members and are shown independently and as group alarms (e.g. GP-OOM1)

Alarms	as inserted above
Additional detected alarms	SEF (SONET), OOF (SDH), LOA
Loss of alignment	LOA
Loss of multi frame (per member)	LOM
Out of multi frame 1 (per member)	OOM1
Out of multi frame 2 (per member)	OOM2

TOH/SOH and POH

Manipulation and analysis is provided for:

- All accessible TOH/SOH bytes
- POH bytes of all members independent
- Traces J0, J1, J2 in clear text
J1, J2 of all members independently
- Sync status (S1) in clear text
- The signal label (C2) of all members is independently in clear text.

Background channels

All background channels have the same pattern.

Fill patterns

$2^{23}-1, 2^{31}-1$, 16 bit user selectable word

Enhanced differential delay generation

Delay value, of every member, can be set independently

High order VCat

Range, programmable	0 to 100 ms
Granularity	$N \times 125 \mu s$ (MFI) + $M \times 0.16 \mu s$ (Ptr)
Pointer rate	8 to 2000 1/s

Three modes are available to set the delays.

Direct mode

Delay values are set manually on a per member basis. At the click of a button, delays are applied instantly for all group members in parallel. Service is disrupted temporarily.

This mode is useful to simulate the effect of APS actions.

Pointer mode

Delay values are set manually on a per member basis. At the click of a button, instrument starts to perform pointer movements until programmed delay is set for each group member. Pointer movements for all group members are executed in parallel. Pointer rate is user programmable. No service disruption occurs.

This mode is useful to simulate the effects of delay wander.

Stress mode

This is an automatic stress test mode. In an endless loop, sets of automatically generated delay values are generated and auto-applied using pointer mode. A programmable waiting time is inserted between sets of delay values. Pointer rate is user programmable. Delay value sets are generated by a random number generator. User programmable random number generator speed allows true random, as well as reproducible pseudo random operation. This mode requires no user interaction.

This mode is useful for automatic reassembler test.

Differential delay analysis

Parallel measurement, of differential delay, provided for each group member. Calculation of differential delay provided for entire group.

Results provided for all members and groups, diff. delay in ms

Measurement range	256 ms
Reassembly range	128 ms

Pointer analysis

- STS/AU pointer values of all members
- Counts of increment, decrement and NDFs

GFP-T Generic Framing Procedure

GFP-T is used to transport time sensitive services over the SONET/SDH network. The main service is Fibre Channel. The option provides the GFP-T mapper and demapper as well as the encapsulation of PRBS pattern and Fibre Channel service simulation. The implementation is according G.7041-Y.1303.

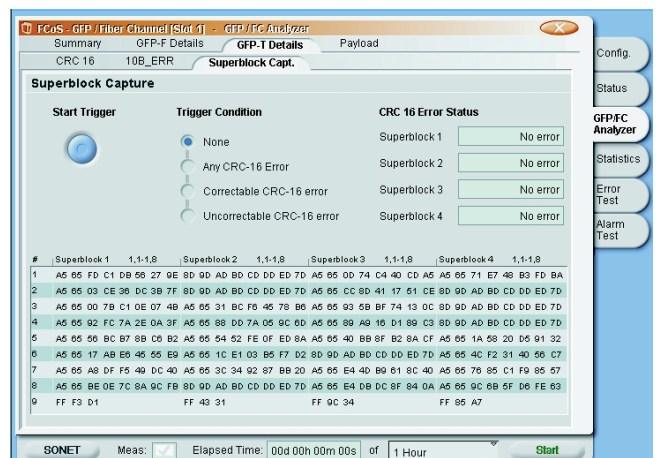

- Error detection and correction of single and double errors
- Service jitter
- Adjustable service offset
- Superblock programming with adaptation to the service bandwidth
- Insertion of client management frames
- Mapping/demapping of PRBS payload
- Mapping/demapping of some service structures

GFP traffic generation

Traffic profile with a bandwidth from 200 Baud up to 1062 Baud.

Payload type header settings

PTI	Client data or client management frame
PFI FCS	off/on
EXI	Null extension header or linear frame or ring frame
UPI (client data)	clear text selection acc. to ITU-T G.7041
UPI (client management)	loss of client signal (LOCS) and loss of client character synchronization (LOCCS)

Linear extension header settings

CID and Spare editable 00 to FF

Error insertion

Core header	single and multiple bit error
Payload type header	single and multiple bit error
Linear frame header	single and multiple bit error
FCS	single-bit error

Alarm insertion

Loss of Frame Delineation LFD

Client signal fail	CSF type (LOCS, LOCCS) selectable with PTI/UIPI
CSF	frame period 500 ms

Transparent specific

Superblock generation

Programmable amount of superblocks per Frame	up to 977
Transmitted superblock	count

CRC16 generation

Generation of CRC-16 error

Insertion point	pre and post scrambler
Insertion mode	Single fixed, walking pattern, uncorrectable and error vector
Repetition rate	Once, rate, continuously, burst once, burst consciously

Service rate

Generation of service bit rate	FC full pipe, FC full speed, FC half speed, FC quarter speed, ESCON and DVB-ASI
Generation service offset	± 250 ppm
Transmitted spare bandwidth	absolute (Mb/s), relative(ppm)
Transmitted count	all codes, D-codes and K-codes

10B_ERR generation

Insertion rate once, rate, continuous, burst once, burst continuous

PRBS service generation (D & K-pattern)

D-pattern

PRBS pattern	2 ³¹ -1, 2 ²³ -1, digital word
Error insertion	single

K-pattern

Transmission	enable/disable
Pattern mode	repeated code, user-defined sequence, quasi random, quasi fibre channel frame structure

Receiver GFP frame filter

On Rx, filtering based on type header fields is performed. The filter criteria are reference values and bit masks. Core, payload, and extension header error detection as well as error correction are supported. Frame delta is programmable.

Reference values of parameters payload type and extension header settings are programmable.

Error detection

Error types	core header single, payload type header single & multiple, linear frame single & multiple, Payload FCS
Evaluation	count, ratio, duration

Alarm detection

Alarm types	LFD, CSF
Evaluation	duration

GFP frame detection

Frame types	idle, client data with/without linear frame, client data with/without FCS, CSF
Evaluation	count, ratio

Online view of payload type and extension header values.

Superblock analysis

Selfadapting and verification superblocks per frame

Measure number of superblock per frame	count
Total superblock received	count, ratio
Good superblock received	count, ratio, rate
Bad superblock received	count, ratio, rate
Superblock capture	4 blocks
Trigger condition	any, any CRC-16-error, correctable CRC-16, uncorrectable CRC-16
Display	in hexadecimal

CRC16 analysis

Error correction	enable, disable
Correction mode	auto mode, single, double error with 43 spacing
Evaluation of correctable, uncorrectable, total errors	count, ratio

Service bandwidth measurement

Client bandwidth	absolute and relative
Spare bandwidth	absolute and relative
Total codes received	count, ratio
D-codes received	count, ratio
K-codes received	count, ratio
65B_Pad codes received	count, ratio
10B_ERR codes received	count, ratio
K28.5 codes received	count, ratio

10B_ERR evaluation

Evaluation	count, rate
------------	-------------

PRBS service evaluation (D & K-pattern)

D-codes
PRBS evaluation 2³¹-1, 2²³-1, digital word

Error detection
Bit error count, ratio,duration

Alarm detection
Loss of D-code synch. evaluation duration

K-codes
Evaluation of the transmitted sequence

Alarm detection
Loss of K-code synch. evaluation duration

SONET/SDH/PoS testing

These tests are also running on the NewGen modules. Please refer to this section on pages 8 and 11.

Ethernet applications

Highlights Ethernet

- Ethernet interfaces for 1 Gb/s **optical** and 10/100/1000 Mb/s **twisted pair**
- **Flexible error insertion** on physical and MAC layer
- **TDR** for the copper interfaces
- **Programmable auto-negotiation**
- Complete **interworking** test solution NewSONET/SDH with Ethernet in one unit

Hardware modules

Ethernet module 10/100/1000M

BN3070/90.71 – 1 slot

Together with the NewGen Solution 2.5G, the Ethernet Module 10/100/1000M provides efficient interworking test of NewSONET/SDH network elements. The Ethernet Module 10/100/1000M provides independent traffic load at 4 twisted pair ports up to 1 Gb/s. In addition, the module can be used for end to end testing for connectivity and Ethernet transparency.

Interface specifications

Compliant	IEEE 802.3 (2002)
Number of ports	4
Interfaces – independently settable per port	10BASE-T, 100BASE-TX, 1000BASE-T
Duplex modes 1000BASE-T	full duplex
10BASE-T, 100BASE-TX	full duplex, half duplex
Auto polarity correction	all pairs, all interface types
Data rates	10, 100, 1000 Mb/s
Connectors	RJ-45

Port wiring

Manual setting	MDI, MDIX
Auto	Auto-MDIX, all interface types

Clocks

Clock accuracy and synchronization from external signal: See clock specifications of ONT-50 mainframe

Tx offset	± 120 ppm
Tx offset resolution	0.1 ppm
1000BASE-T Slave mode	Tx is locked to Rx, no Tx offset possible.
Rx offset acceptance	± 200 ppm

Tx reference clock output

Nominal frequencies

10BASE-T	2.5 MHz
100BASE-TX	25 MHz
1000BASE-T	125 MHz
Pulling range	± 120 ppm
Signal level	≥ 300 mVpp
Impedance	AC coupled 50 Ω
Connector type	SMA

Rx recovered clock output

Nominal frequency

10BASE-T	2,5 MHz
100BASE-TX	25 MHz
1000BASE-T	125 MHz
Pulling range	± 200 ppm
Signal level	≥ 300 mVpp
Impedance	AC coupled 50 Ω
Connector type	SMA

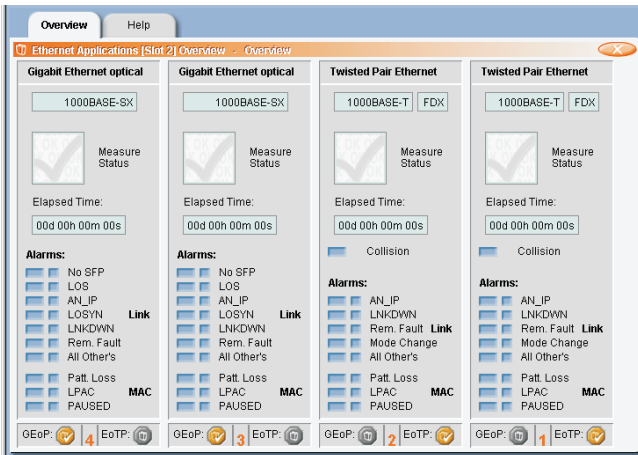

Cable status/test

The status of the connected cable is shown in service.

Estimated cable length	for 1000 only
Port wiring, polarity, skew	all rates

Time Domain Reflectometer

It is an accurate cable length measurement for fault location to determine where it runs out of service.

For Link and MAC measurement details see Ethernet testing section (page 19).

Mixed Ethernet module

BN3070/90.72 – 1 slot

The Mixed Ethernet Module provides two optical ports for 1G and two electrical ports for 10/100/1000M. For detailed specifications please refer to the “Ethernet Module 1G” and “Ethernet Module 10/100/1000M” sections.

Ethernet module 1G

BN3070/90.73 – 1 slot

Together with the NewGen Solution 2.5G, the Ethernet Module 1G provides efficient interworking test of NewSONET/SDH network elements. The Ethernet Module 1G provides independent traffic load at 4 ports, up to 1 Gb/s. In addition, the module can be used for end to end testing for connectivity and Ethernet transparency.

Interface specifications

Compliant	IEEE 802.3 (2002)
Number of ports	4
Interfaces – can be mixed	1000BASE-SX (850 nm) 1000BASE-LX (1310 nm) other interfaces on request

Duplex mode	full duplex
Data rate	1000 Mb/s
Coding scheme	8B/10B
Pluggables	SFPs

Module accepts SFPs compliant to the “Small Form Factor Pluggable Transceiver Multi-Source Agreement (SFP)” – Sept. 14th, 2000

Operating Modes Terminate and Through (two operating modes)

Minimal intrusive through mode is useful for monitoring. Data is looped through at the 8B/10B code word level. Tx clock is locked to Rx.

Optical SFP transceiver plug-in modules

The Ethernet interface uses SFP plug-in modules. Therefore, optical parameters and connector types depend on the SFPs. JDSU supplied SFPs have LC connectors. Optical parameters given in the ONT-50 data-sheet are valid for JDSU supplied SFPs only.

Generator

Wavelength SX	850 nm
Output level	-9.5 to -4.0 dBm
Fiber SX	multi mode 50/62.5 μm
Wavelength LX	1310 nm
Output level	-9 to -3 dBm
Fiber LX	single mode

Receiver

Wavelength range SX	770 to 860 nm
Sensitivity	-3 to -17 dBm
Wavelength range LX	1100 to 1600 nm
Sensitivity	-3 to -20 dBm

Optical power measurement

The optical power measurement is supported for SFPs compliant to SFF-8472 Rev. 9.3 “Specification for Diagnostics Monitoring Interface for Optical Xcvrs”, August, 1 2002. The measurement range and accuracy depends on the SFP used.

Clocks

Clock accuracy and synchronization from external signal: See clock specifications of ONT-50 mainframe

Tx clock mode	internal, recovered
Tx offset	± 120 ppm
Tx offset resolution	0.1 ppm
Rx offset acceptance and measurement	± 200 ppm
Rx offset measurement resolution	1 ppm

Tx reference clock output

Nominal frequency	125 MHz
Pulling range	± 120 ppm
Signal level	≥ 300 mVpp
Impedance	AC coupled 50 Ω
Connector type	SMA

Rx recovered clock output

Nominal frequency	62,5 MHz
Pulling range	± 200 ppm
Signal level	≥ 300 mVpp
Impedance	AC coupled 50 Ω
Connector type	SMA

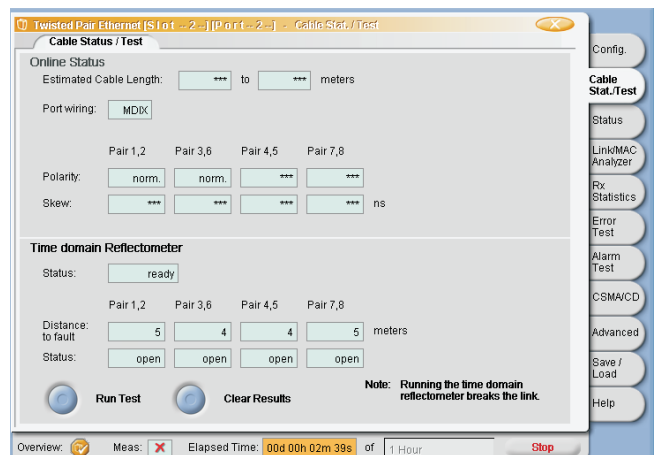

Ethernet testing

Ethernet Module 1G	BN 3070/90.73,
Ethernet Module 10/100/1000M	BN 3070/90.71,
Mixed Ethernet Module	BN 3070/90.72

Link layer testing (physical)

Auto-negotiation and link control

The instrument supports auto-negotiation for all types of Ethernet interfaces. Implementation is conforming to IEEE 802.3 (2002).

Link control:

Tx ignore link status (forces transmitter to ignore link status).	on/off
Auto-negotiation control:	on/off
Manual restart (forces re-negotiation)	

Auto-negotiation advertised capabilities (1000BASE-X)

Advertised capabilities are user settable

Flow control	None, asymmetric, symmetric, both
Remote fault encoding	no error, offline, link failure, auto-negotiation error

Auto-negotiation advertised capabilities (twisted pair interface)

Advertised capabilities are user settable:

Speed and duplex mode	1000BASE-T FDX, 100BASE-TX FDX, 100BASE-TX HDX, 10BASE-T FDX, 10BASE-T HDX
Flow control	none, asymmetric, symmetric, both
Remote fault	no error, error

Auto-negotiation status

Status	auto-negotiation in progress, auto-negotiation fail,
Evaluation	duration
State machine status	current state

Auto-negotiation link partner advertised capabilities (1000BASE-X)

The following link partner advertised capabilities are indicated:

Flow control	none, asymmetric, symmetric, both
Remote fault encoding	no error, offline, link failure, auto-negotiation error
Duplex mode	full-duplex, half-duplex
Next page capability	yes/no

Auto-negotiation link partner advertised capabilities (twisted pair interface)

The following link partner advertised capabilities are indicated:

Speed and duplex mode	1000BASE-T FDX, 100BASE-TX FDX, 100BASE-TX HDX, 10BASE-T FDX, 10BASE-T HDX
Flow control	none, asymmetric, symmetric, both
Remote fault	no error, error

Link error and alarm generation (1000BASE-X)

Error types	invalid code group, running disparity, bit errors line errored frame, false carrier
Triggering	once, rate, continuous, random, burst once, burst continuous, rate burst once, rate burst continuous (running disparity only single)
Rates	1E-3 to 1E-10
Bursts	N for units ON, M for units OFF N and M depending on error bits or frames lower limit and upper limit depending on error
Alarm types	loss of signal, loss of synchronization

Link error monitoring (1000BASE-X)

Error types	invalid code group, running disparity error, error propagation (V/), Link down, line error frame, loss of synchronization event False carrier
Evaluation	count, ratio, duration

Link alarm generation (1000BASE-X)

Alarm types	loss of signal, loss of synchronization
Triggering	continuous, burst once, burst continuous
Bursts	N for ON in time, M for OFF in time, N and M: 1 to 10000 ms

Link status monitoring (1000BASE-X)

Alarm types	loss of signal, loss of synchronization, link down, Rx clock out of range
Evaluation	duration
Transceiver related alarms	no SFP, Tx fault, Tx loss of timing information

Link error generation (twisted pair interface)

Error types	dribble, line errored frame
Trigger	once, rate, continuous, burst once, burst continuous, rate burst once, rate burst continuous
Rate	1E-4 to 1E-8
Burst	N for ON, M for OFF in frames, N and M: 1 to 262143

Link error monitoring (twisted pair interface)

Error types	Rx line error, link down event, false carrier, line errored frames, dribble frames
Evaluation	count, rate, duration (link down event no ratio), false carrier rate

Link alarm generation (twisted pair)

Alarm type	link down
Trigger	continuous, burst once, burst continuous
Burst	N for ON, M for OFF, N and M: 10 to 10000 ms

Link status monitoring

Alarm type	link down, remote fault, local Rx bad, remote Rx bad, mode change
Evaluation	duration

Link bandwidth and utilization measurement

Rx total link bandwidth	0 to maximum
Rx total link utilization	0 to 100%
Tx total link bandwidth	0 to maximum
Tx total link utilization	0 to 100%

MAC layer testing

For Ethernet MAC layer generation and analysis see the Ethernet MAC layer chapter in the EoS testing section (page 19).

OTN applications

Highlights OTN

- Advanced FEC generation
- FEC stress testing
- Support of all 6 TCM layers
- Error stress testing with **BIP masks** and editable BEI values
- **OH byte sequencer and recorder**

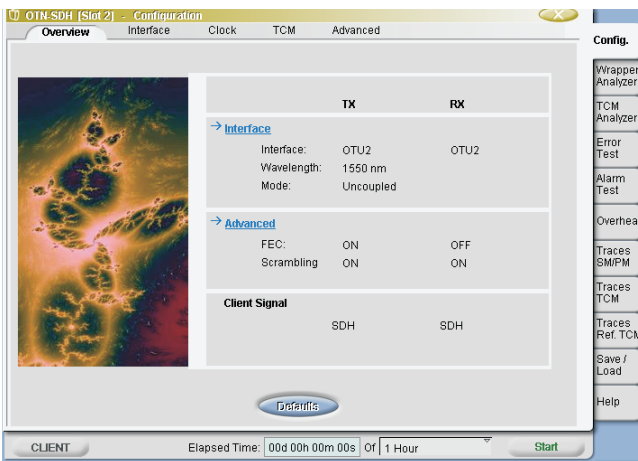

Hardware modules

OTN module 2.5/2.7G

Hardware option BN 3070/90.17 – 1 slot

Tests supported

- SONET/SDH 52 Mb/s to 2.5 Gb/s (page 8)
- OTU-1 (page 24)
- PoS (optional, page 11)

General interfaces

Please refer to hardware modules 2.5/2.7G (page 7)

OTN module 10/10.7G – 1550 nm
 OTN module 10/10.7G-B – 1550 nm
 OTN module 10/10.7G-B – 1310 nm

Hardware option

BN 3070/90.30, BN 3070/90.32, BN 3070/90.33 – 2 slots each

Tests supported

- SONET/SDH 10 Gb/s (page 8)
- OTU-2 (page 24)
- PoS (optional, page 11)
- Jitter/wander for versions -B (optional)

General

Line rate 10.709 Gb/s, 9.953 Gb/s
 Line code scrambled NRZ

Clock generator

Clock accuracy and synchronization from external signal: see clock specifications of ONT-50 mainframe

Selectable clock offset ± 50 ppm
 Step size 0.1 ppm

Optical interfaces

The interface meets the requirements of ITU-T G.691/GR.253

Generator

Wavelength (BN 3070/90.30, BN 3070/90.32) 1550 nm
 Wavelength (BN 3070/90.33) 1310 nm
 Output level –3 to +2 dBm

Receiver

Wavelength range 1260 to 1620 nm
 Broadband sensitivity –3 to –14 dBm
 Max. input power (destructive power) +2 dBm
 Measuring optical input power –14 to 0 dBm

Generator eye clock signal

Bit rates 622 MHz, 669 MHz
 Output level sinusoidal 200 mVpp

Electrical interfaces (only version B)

for BN 3070/90.32, BN 3070/90.33

Impedance AC coupled 50 Ω
 Connector type SMA

Generator data signal

Bit rates, code 9.953 Gb/s, 10.709 Gb/s, scrambled NRZ
 Output level >200 mVpp

Generator clock signal

Bit rates 9.953 GHz, 10.709 GHz
 Output level >200 mVpp

Receiver data signal

Bit rates, code 9.953 Gb/s, 10.709 Gb/s, scrambled NRZ
 Input level 100 to 600 mVpp

OTN testing

The OTN application runs on the OTN modules 2.5/2.7G (OTU1) and 10/10.7G (OTU-2) and allows generation and analysis of OTN signals. Detailed parameters can be manipulated and evaluated in different OTN levels. Its payload supports both framed SONET/SDH and unframed clients. The test set provides signal analysis and manipulation (alarm, error, overhead), Forward Error Correction (FEC) generation and analysis as well as in depth FEC error testing. In addition to this, the full analysis capabilities of SDH and SONET are available for OTN client analysis.

OTU1 and OTU2 generation

Content of overhead bytes (frame alignment/OTU/ODU/OPU)

- All bytes statically programmable except MFAS, SM BIP-8, PM BIP-8, TCM1...6 BIP-8
- Additional possibilities for SM TTI, PM TTI, TCM1...6 TTI (Trail Trace Identifier):
 - Sequence consisting of the SAPI (16 bytes),
 - DAPI (16 bytes) and the operator specific field (32 bytes).
- User designed Payload Structure Identifier (PSI) and payload type identifier clear text
- One OH byte can be selected for a freely defined sequence of 16/32/64/128/256 bytes
- FTFL free definable forward/backward (FW/BW) fault indication and operator identifier

OPU client signals

- OTU-1: OC-48/STM-16 signal internally generated
Generation see chapter SDH and SONET testing.
- OTU-2: OC-192/STM-64 signal internally generated
Generation see chapter SDH and SONET testing.
- PRBS 2³¹⁻¹ inv./non-inv., PRBS 2²³⁻¹ inv./non-inv.
- Digital word 16 bit free programmable
- Null client

Client offset – stuffing

The asynchronous SONET and SDH client offset can be adjusted within the ± 65 ppm range and the stuffing rate of the client can thus be manipulated.

The OTUFEC field

This field contains the FEC values calculated according to the Reed-Solomon (255,239) algorithm.

Error insertion

Error types

Random, FAS, MFAS, FEC
SM BIP-8, SM BEI, PM BIP-8, PM BEI
FECuncorr., FEC corr., FECstress, FECadv.
TCMi BIP-8, TCMi BEI (i = 1 to 6)

Triggering

Single	all errors except FEC
Ratio	random 1E-3 to 1E-10
Burst once	all errors except random, FECstress
Burst continuous	all errors except random
Burst error	M frames errors, N frames non-errored, M and N = 0 to 2E9

BIP masks

The position and number of bit errors in the bytes can be selected. Valid for SM BIP8, PM BIP8, TCMi BIP8 (i = 1 to 6)

BEI value

To stress the BEI evaluation of the DUT receiver the BEIs can be set to values 0 to 15. Valid for SM BEI, PM BEI, TCMi BEI (i = 1 to 6)

FEC error insertion modes

- FECcorrectable, FECuncorrectable
- FECstress:
 - This extremely helpful function allows maximum stress tests within short time frames. The maximum possible number of errors that the device under test (DUT) should still be able to correct is inserted into the OTU frame.

All bit positions of a frame are affected within 2 seconds.

FECadvanced

FECadvanced allows the user to define a detailed position for error insertion in the OTU frame. Correction capability testing below and above the correction limit can be performed.

Selectable parameters: row, subrow, errored bytes per subrow, start position in subrow, byte error mask

Alarm generation

LOS, LOF, LOM, OOF, OOM, OTU-AIS, ODU-AIS, ODU-OCI, ODU-LCK, SM BDI, SM IAE, SM BIAE, PM-BDI, FW-SD, FW-SF, BW-SD, BW-SF, TCMi-BDI, TCMi-BIAE (i = 1 to 6)

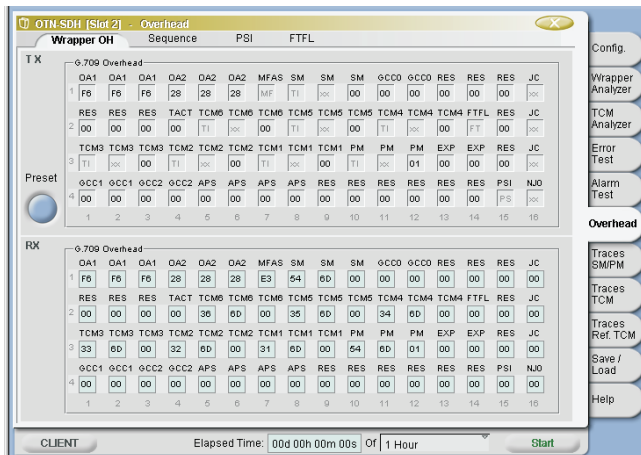

Triggering

Continuously	all alarms
Burst once and	all errors except LOS, LOF,
Burst continuous	OOE, OOM, SD, SF
Burst alarms	M frames with alarm, N frames no alarm, M and N = 0 to 2E9

Through mode

The received signal is looped through the ONT-50 and retransmitted without termination of alarms and errors. All alarms, errors and traces of the received signal can be monitored on the client signal and on the wrapper level.

OTU1 and OTU2 analyzer

Overhead evaluation (frame alignment/OTU/ODU/OPU)

- Display of the complete overhead
- SM TTI, PM TTI, TCM16 TTI display of the 64 byte ASCII sequence of SAPI, DAPI and Operator field
- One sequence up to 256 bytes can be captured and displayed for a selectable OH byte
- Display Payload Structure Identifier (PSI) bytes and Payload Type identifier (PT) clear text
- Editable PT expectation value as mismatch criterion
- FTFL forward/backward (FW/BW) fault indication and operator identifier fields

Trace references

- Set of SAPI and DAPI expectation values in traces SM TTI, PM TTI, TCM16 TTI
- Select evaluation type of the received signal: SAPI or DAPI or SAPI/DAPI

OPU clients signals

- OTU-1: OC-48/STM-16 signal internally generated
Analysis see chapter SONET/SDH testing.
- OTU-2: OC-192/STM-64 signal internally generated
Analysis see chapter SONET/SDH testing.
- Validation for payload bit error measurement at:
 - PRBS $2^{31}-1$ inv./non-inv., PRBS $2^{23}-1$ inv./non-inv.
 - Digital word 16 bit free programmable
 - Null client

The OTUFEC

The FEC procedure can be switched on and off. Using the OTU FEC field, FEC according to the Reed-Solomon (255,239) algorithm is performed on the received frame. With data blocks consisting of 239 data bytes and 16 FEC field bytes, up to 16 byte errors can be detected and 8 byte errors be corrected.

Error measurement

Validation of data for error measurement occurs after frame alignment, descrambling, and FEC computation and correction.

Error types

FAS, MFAS, SM BIP-8, SM BEI, PM BIP-8, PM BEI
FECcorr., FECuncorr. TCMi BIP-8, TCMi BEI (i = 1 to 6)

Alarm detection

From each alarm the duration will be displayed.
LOS, LOF, OOE, LOM, OOM
OTU-AIS, ODU-AIS, ODU-OCI, ODU-LCK, SM BDI, SM IAE, SM BIAE, SM TIM
PM-BDI, PM TIM
FW-SD, FW-SF, BW-SD, BW-SF
TCMi-BDI, TCMi-IAE, TCMi-TIM (i = 1 to 6)
CL-LOSS (Client signal Loss of synchronization)
PT-MISM

Result display of errors and alarms

Numerical display

Count, ratio and duration are displayed for each error.

Tabular display

Display of all results with time stamps

Criteria start, stop, duration, count

Graphical display

Display of all events as bar graphs versus time. Cursors allow easy identification and zooming (in and out) on results. Filters enable event selection.

Time axis second, minute, hour

Stuffing of the payload

Display of payload offset ppm

Stuffing counts

Positive, negative, sum count, duration

SONET/SDH/POS testing

The applications are also running on the OTN modules. Please refer to this section on pages 8 and 11.

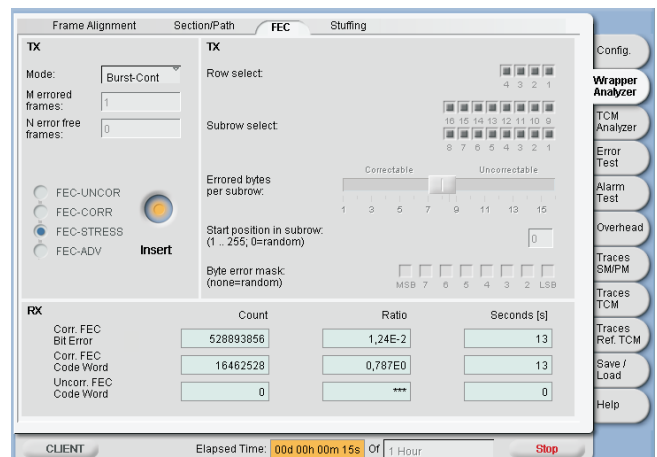

Jitter/Wander applications

Highlights Jitter

- Optical and electrical jitter testing at 10 Gb/s and 10.7 Gb/s
- Receiver-only jitter accuracy of 15 mUIpp
- Verification and characterization using ITU-T Rec. O.172 Appendices VII + VIII
- OTN mapping jitter

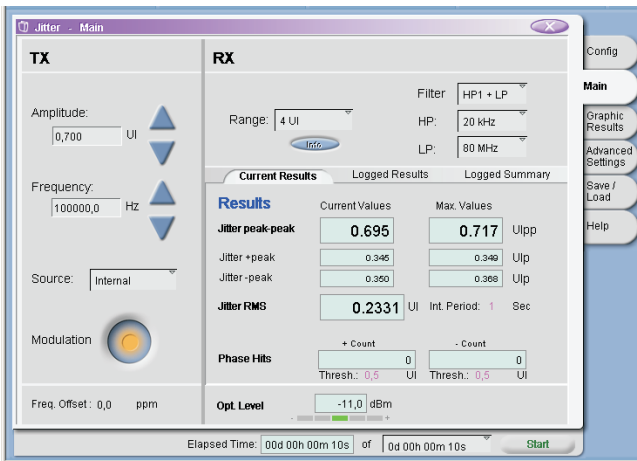

Jitter module 10G-B

Jitter module 10/10.7G-B

Jitter module 10G-B, BN 3070/90.95

Together with modules 10G-B (BN 3070/90.19, BN 3070/90.21) the jitter module provides jitter functions at 10 Gb/s.

Jitter module 10/10.7G-B, BN 3070/90.93

Together with modules 10/10.7G-B (BN 3070/90.32, BN 3070/90.33) the jitter module provides jitter functions at 10 and 10.7 Gb/s.

Wander option BN 3070/93.91 supports wander generation and analysis on both jitter options.

Standards

Jitter and wander are generated and analyzed in accordance with the following standards:

- ITU-T Recommendation O.172 including new appendices VII + VIII
- ITU-T Recommendation O.173
- ITU-T Recommendations G.825, G.8251
- Telcordia GR-253 (September 2000)
- ANSI standards T1.101, T1.105, T1.105.03

Jitter generator

Meets or exceeds the requirements of ITU-T Recommendations O.172/O.173.

Bit rate	9.953 and 10.709 Gb/s
Offset	± 50 ppm
Modulation	internal or external
Jitter modulation signal	sine wave

Built-in modulation generator

Jitter amplitude	up to 3200 UIpp
Step width	0.001 UI

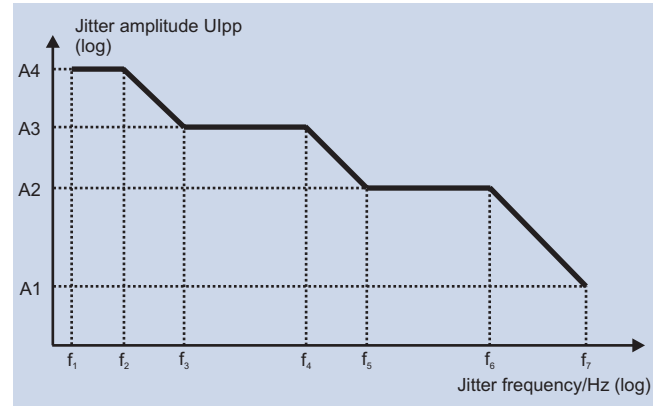

Amplitude in [UIpp]				Frequency in [Hz]						
A ₁	A ₂	A ₃	A ₄	f ₁	f ₂	f ₃	f ₄	f ₅	f ₆	f ₇
0.5	6	20	3200	10	12.5	2 k	10 k	33.3 k	6.67 k	80 M

Generation accuracy conforming to ITU-T O.172/O.173

External modulation input

BNC, 75 Ω	
Modulation frequency	0.1 to 80 MHz
Input voltage range	0 to 2 Vpp

Jitter analyzer

Meets or exceeds the requirements of ITU-T O.172/O.173.

Bit rate	9.953 and 10.709 Gb/s
Offset permitted	± 20 ppm
Electrical data input	SMA, 50 Ω,
Input level	100 to 600 mVpp

Measuring ranges/resolution

Peak-Peak I	0 to 0.4 UIpp/1 mUIpp
Peak-Peak II	0.2 to 4 UIpp/1 mUIpp
Peak-Peak III	2 to 40 UIpp/10 mUIpp
Peak-Peak IV	20 to 3200 UIpp/1 UIpp
RMS I	0 to 0.2 UI/0.1 mUI
RMS II	0.1 to 2 UI/0.1 mUI
RMS III	1 to 20 UI/1 mUI
RMS IV	10 to 1600 UI/100 mUI

Measurement accuracy

High-accurate jitter receiver verified by methods described in ITU-T O.172 Appendix VII and VIII.

Peak-Peak I fixed error 15 mUpp*
 * Optical input power level -10 dBm to -12 dBm, mapping SDH VC-4/SONET STS-1, payload pattern PRBS31, environmental temperature +20 °C to +30 °C.

Built-in filters

High-pass filters 10k, 12k, 20k, 50k, 4 MHz
 Low-pass filter range 80 MHz

Demodulator output

BNC, 75 Ω

Jitter testing

Supports all manual and automatic measurements for jitter evaluations.

Jitter measuring modes

Current values (continuous measurement): Peak-Peak, positive peak, negative peak, RMS

Maximum values (gated measurement):

Peak-Peak, positive peak, negative peak

Logged values (repetitive measurements): Peak-Peak, positive peak, negative peak

Phase hits

The instrument detects when the programmable threshold for positive and negative jitter values is exceeded and the result indicates how often the threshold was exceeded.

Jitter versus time

This function is used to record variations of jitter with time and allows the positive and negative peak values, peak-to-peak values, and RMS values to be displayed versus time. Duration is up to 99 days.

Automatic jitter measurements

Selective jitter transfer function (JTF)

The JTF shows the ratio of the jitter amplitude at the output of the device under test (DUT) and at the input at various frequencies. Standard tolerance masks are available and can be edited.

Maximum tolerable jitter (MTJ)

The jitter module automatically determines the maximum jitter amplitude tolerated by the DUT at selected jitter frequencies. The maximum permissible jitter amplitude can be precisely determined using a successive method. The module determines the exact limit value. Several error sources are selectable. Standard tolerance masks are available and can be edited.

Fast maximum tolerable jitter (FAST-MTJ)

This extremely fast measurement tests the device under test for conformance to the standard tolerance mask limits for maximum tolerable

jitter. The editable frequency/amplitude values are set sequentially and the test pattern is monitored for the permitted threshold by the receiver. The result of each measurement is shown in a table as a status message.

Wander testing

Highlights Wander

- Optical and electrical wander testing at 10 Gb/s and 10.7 Gb/s
- Graphical TIE, MTIE/TDEV (online)
- Four sample rates for long-term up to transients
- Separate reference clock input for clock and data

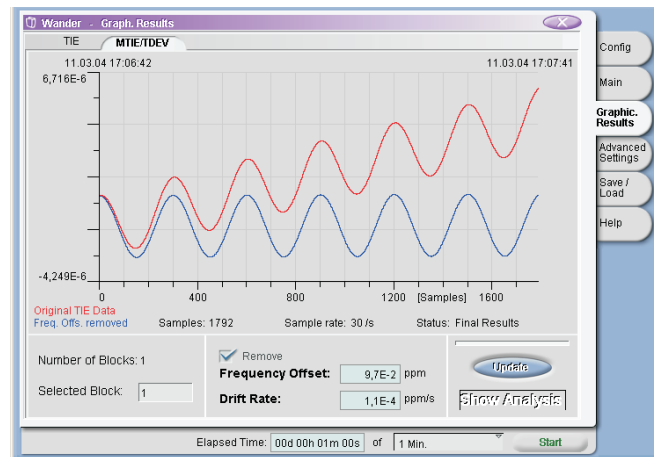

Software option BN 3070/93.91

This software option is only available in conjunction with jitter modules 10G-B and 10/10.7G-B, and enables wander generation and analysis.

Fully complies with or exceeds the requirements of ITU-T O.172.

Wander generator 10/10.7 Gb/s

Modulation signal	sine wave
Amplitude range	0.1 to 320 000 UI
Amplitude step width	0.1 UI
Frequency range	10 μHz to 10 Hz
Frequency step width	1 μHz
Generator accuracy	conforms to ITU-T O.172

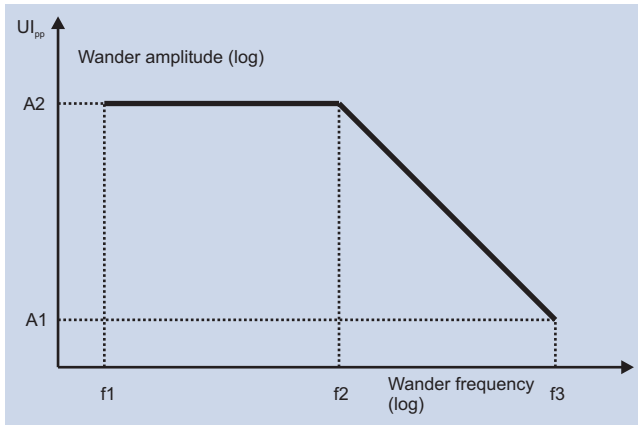

The measurement point is then marked as “Pass” (no alarms or errors detected) or “Fail” (alarms or errors detected).

Clock offset	A1 in UI	A2 in UI	f1 in μ Hz	f2 in Hz	f3 in Hz
0 ppm	16 000	320 000	10	0.5	10
50 ppm	1600	320 000	10	0.05	10

Wander analyzer 10/10.7 Gb/s

Four different sampling rates are available for detailed analysis versus time:

Sampling rate – Low-pass filter

1/s – 0.1 Hz, 30/s – 10 Hz (O.172), 60/s – 20 Hz, 1000/s – 100 Hz (O.172)

Measurement accuracy conforming to ITU-T O.172

Wander reference signal input

Balanced	Bantam/110 Ω
Clock signals	1.544, 2.048 MHz
Data signals	1.544, 2.048 Mb/s
Unbalanced	BNC/75 Ω
Clock signals	1.544, 2.048, 5, 10 MHz
Data signals	1.544, 2.048 Mb/s

Wander measuring modes

Time interval error (TIE) numerical and graphical, peak-peak wander numerical.

TIE values are recorded and available for MTIE/TDEV evaluations and frequency offset and drift rate measurements with graphs and built-in masks that comply with Telcordia GR-253, GR-1244, ANSI T1.101, ETSI ETS 300 462, EN 302 084, ITU-T O.172, and G.810 to G.813 recommendations.

Automatic wander measurements

Maximum tolerable wander (MTW)

ITU-T G.823, G.825

This application tests the DUT for conformance to the standard tolerance mask limits for wander tolerance and is available in connection with the wander generator.

The device under test is subjected to wander at several amplitudes and frequencies and the output signal is monitored for different error sources.

Optical applications

Optical amplifier modules OAM-200/201

Hardware option BN 3070/92.20, BN 3070/92.21 – 1 slot each

The OAM-200/201 Optical Amplifier Modules are economical, compact modules that provide pure C-band and C + L-band amplification, delivering signal gain up to 26 dB and saturated output up to +15 dBm.

Application

For system verification testing and troubleshooting particularly in DWDM systems, it is occasionally necessary to isolate specific channels out of the entire wavelength spectrum in order to verify the signal performance on the digital layer. With the OAM-200/201, the power level of the channel can be adjusted to the receiver power range of the following BER tester or Q-factor meter.

Specifications

OAM-200: C-band amplifier

Laser safety

Class 1M Laser product according to 21 CFR 1040 and IEC 60825-1

Display

Input power, output power, gain

Parameters settings

Pump control 0 to 100%

Optical ports (physical contact interfaces)

Input / output ports 2 × SM
Interface Universal adapter system

General specifications

Wavelength range ¹⁾ C-band:	1529 to 1562 nm
Saturated output power ²⁾	typ +15 dBm
Noise figure	typ 6 dB
Polarization depth gain	0.3 dB
Optical return loss	typ 30 dB
Small signal gain ³⁾	typ 24 dB
¹⁾ 3 dB limits	
²⁾ at -5 dBm input power	
³⁾ Input power of -20 dBm	

Power meter

Wavelength range 1250 to 1650 nm

OAM-201: C+L-band amplifier

Laser safety

Class 1M Laser product according to 21 CFR 1040 and IEC 60825-1

Display

Input power, output power, gain

Parameters settings

Pump control 0 to 100%

Optical ports (physical contact interfaces)

Input / output ports 2 × SM
Interface Universal adapter system

General specifications

Wavelength range ¹⁾	
C-band:	1529 to 1562 nm
L-band:	1569 to 1605 nm
Saturated output power ²⁾	
C-band:	typ +15 dBm
L-band:	typ +13 dBm
Noise figure	typ 6 dB
Polarization depth gain	0.3 dB
Optical return loss	typ 30 dB
Small signal gain ³⁾	
C-band:	typ 24 dB
L-band:	typ 26 dB

¹⁾ 3 dB limits

²⁾ at -5 dBm input power

³⁾ Input power of -20 dBm

Power meter

Wavelength range 1250 to 1650 nm

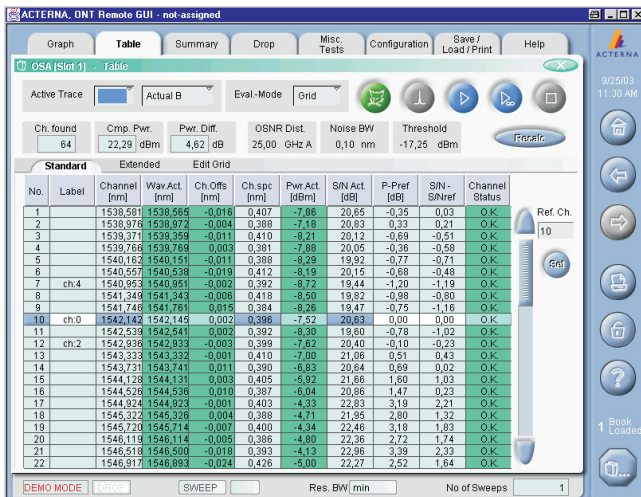

Full-band DWDM analyzer OSA-160/161/201

Hardware option

BN 3070/91.01, BN 3070/91.12,
BN 3070/91.14 – 2 slots each

The OSA modules are based on a new JDSU opto-mechanical design offering superior optical performance at high measurement speed and unsurpassed ruggedness for field applications.

All instruments are equipped with an internal wavelength reference which guarantees highest wavelength accuracy over the instrument's life-

time without recalibration (JDSU patent pending).

Graphical and tabular display formats can be selected for use during installation of multi-channel DWDM systems in the wavelength range of 1250 to 1650 nm.

Built-in test functions allow automatic pass /fail evaluation based on customer predefined limits.

Test applications for EDFA, laser source and LEDs facilitate network component verification.

40/43G ready

With the new signal analysis all JDSU OSAs are prepared for high precision channel power measurements in systems with data rates up to 40/43G.

The **OSA-160** is the single port spectrum analyzer for measurements during the installation, maintenance and upgrade of DWDM and CWDM networks.

The **OSA-161** is the first field-portable unit combining a spectrum analyzer with a tunable filter for data rates up to 10.7 Gb/s. This channel drop function can be used for maintenance and troubleshooting to drop single DWDM channels out of the spectrum for further qualification using a Q-factor meter or a BER tester.

The **OSA-201** offers a dual-port measurement capability in addition to the channel drop function, enabling simultaneous measurement of two independent DWDM signals. This can be used, for example, to qualify optical amplifiers by simultaneously analyzing the input signal and the output signal.

Operating modes

Graph: WDM spectral mode

Full-spectrum graphical display

Functions	zoom/move, marker/cursor channel-grid, multitrace, summary
FOX	one-button auto mode for evaluation of DWDM signals with pass/fail indication
Sweep modes	real time, continuous, averaging and min/max hold
Graph mode display of up to 4 traces	with trace comparison
Table mode	up to 22 simultaneously visible channels
Display parameters	channel no., wavelength, power, OSNR, statistics (min, max) label, channel status, history, pass/fail

Summary: WDM system evaluation mode

Evaluation of DWDM signals against customers' predefined parameter with indication of pass/fail result

Network component test applications

Display parameters

EDFA test	input/output noise (ASE) Noise figure, gain per channel
DFB-Laser test	peak wavelength, power, bandwidth, SMSR, mode offset
FP-Laser test	center wavelength, total power, FWHM/RMS bandwidth
LED test	center/mean wavelength, total power, FWHM/RMS bandwidth

Channel drop option (OSA-161/201)

Using the channel drop function, you can drop channels for further signal analysis with a BERT or a Q-factor meter.

Wavelength range	1250 to 1650 nm
Data rates	up to 10.7 Gb/s
Spectral filter bandwidth	typ. 220 pm
Insertion loss	typ. <10 dB
Tracking mode	auto wavelength control

Dual port option (OSA-201) for drifting wavelengths

Simultaneous measurement of two fibers for monitoring or component test applications.

Technical specifications

Spectral measurement ranges

Wavelength range	1250 to 1650 nm
No. of optical channels	512
Wavelength calibration ¹⁾	internal, online
Wavelength accuracy ²⁾	typ ± 20 pm
Readout resolution	0.001 nm
Resolution bandwidth (FWHM) ⁴⁾	typ. 75 pm
Wavelength linearity (over 10 nm)	± 10 pm

Power measurement ranges

Dynamic range ³⁾	-75 to +23 dBm
Noise floor RMS (with averaging) ⁴⁾	-75 dBm
Absolute accuracy ^{4),6)}	± 0.4 dB
Linearity ⁵⁾	± 0.05 dB
Readout resolution	0.01 dB
Scanning time (1250 to 1650 nm) ⁸⁾	< 1.5 s



Optical rejection ratio ⁽⁴⁾ at ± 25 GHz (± 0.2 nm) at ± 50 GHz (± 0.4 nm)	typ 35 dBc typ 45 dBc
PDL ⁽⁴⁾	±0.1 dB
Flatness ⁽⁴⁾	± 0.2 dB
Level reproducibility ⁽⁷⁾	± 0.05 dB

Optical ports (physical contact interfaces)

Input ports

OSA-160/161	1 × SM
OSA-201	2 × SM

Output port (drop port)

OSA-161/201	1 × SM
Interface	Universal
Optical return loss	> 35 dB
Total safe power	+23 dBm
Weight (module)	1.9 kg/4.4 lb

- ⁽¹⁾ built in, physical constant wavelength calibrator, needs no recalibration.
- ⁽²⁾ 1520 to 1565 nm at 23°C
- ⁽³⁾ max. power per channel +15dBm
max. total power + 23 dBm
- ⁽⁴⁾ 1520 nm to 1565 nm at 18°C to 28°C
- ⁽⁵⁾ -45dBm to +10dBm, at 23°C
- ⁽⁶⁾ at -10dBm
- ⁽⁷⁾ 1 min, stable signal, const temperature
- ⁽⁸⁾ full span 400nm, 40000 measured samples
incl. WDM-table analysis

High performance DWDM analyzers OSA-300/301/303

Hardware option BN 3070/91.31,
BN 3070/91.32, BN 3070/91.34
3 slots each

The JDSU OSA-300, OSA-301, and OSA-303 are high performance optical spectrum analyzers which offer a 10 dB improvement of OSNR range compared to OSA-160/161/201, enabling accurate measurements in DWDM networks with high channel counts and tight channel spacing.

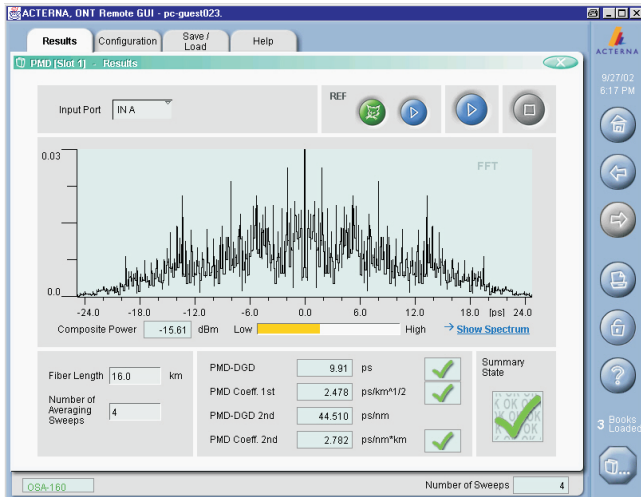

All OSA modules provide high test speed plus internal wavelength reference which guarantees highest wavelength accuracy over instrument lifetime without recalibration.

Graphical and tabular display formats can be selected for use during the installation of multi channel DWDM systems in the wavelength range of 1250 to 1650 nm.

Built-in test functions allow automatic pass/fail evaluation based on customer predefined limits.

Test applications for EDFA, laser source and LEDs facilitate network component verification.

40/43G ready

With the new signal analysis all JDSU OSAs are prepared for high precision channel power measurements in systems with data rates up to 40/43G.

The OSA-300 is the single port spectrum analyzer for advanced qualification of optical networks during the installation, maintenance and upgrade of ultra-dense WDM applications as well as for system verification testing.

The OSA-301 is the first field-portable unit combining an ultra high resolution spectrum analyzer with a tunable filter for data rates up to 10.7 Gb/s. The channel drop function can be used for maintenance and troubleshooting to drop single DWDM channels out of the spectrum for further qualification using a Q-factor meter or a BER tester.

The OSA-303 offers a dual-port measurement capability in addition to the channel drop function, enabling simultaneous measurement of two independent DWDM signals. This can be used for example to qualify optical amplifiers by simultaneously analyzing the input signal and the output signal.

Operating modes

Graph: WDM spectral mode

Full-spectrum graphical display

Functions	zoom/move, marker/cursor, channel-grid, multitrace, summary
FOX	one-button auto mode for evaluation of DWDM signals with pass/fail indication
Sweep modes	real time, continuous, averaging
Graph mode	display of up to 4 traces with trace comparison and min/max hold
Table mode	simultaneously visible channels up to 22 channels
Display parameters	channel no., wavelength, power, OSNR, statistics (min, max) label, channel status, history, pass/fail

Specifications

Summary: WDM system evaluation mode

Evaluation of DWDM signals against customers' predefined parameter with indication of pass/fail result

Network component test applications

Display parameters

EDFA test	input/output noise (ASE) Noise figure, gain per channel
DFB-Laser test	peak wavelength, power, bandwidth, SMSR, mode offset
FP-Laser test	center wavelength, total power, FWHM/RMS bandwidth
LED test	center/mean wavelength, total power, FWHM/RMS bandwidth

Channel drop option (OSA-301/303)

Using the channel drop function, you can drop channels for further signal analysis with a BERT or a Q-factor meter.

Wavelength range	1250 to 1650 nm
Data rates	up to 10.7 Gb/s
Spectral filter bandwidth	typ. 175 pm
Insertion loss	typ. <10 dB
Tracking mode	auto wavelength control

Dual port option (OSA-303)

Simultaneous measurement of two fibers e.g. for monitoring or component test applications.

Technical specifications

Spectral measurement ranges

Wavelength range	1250 to 1650 nm
No. of optical channels	512
Wavelength calibration ¹⁾	internal, online.
Wavelength accuracy ²⁾	typ ± 10 pm
Readout resolution	0.001 nm
Resolution bandwidth (FWHM) ⁴⁾	typ. 60 pm
Wavelength linearity (over 10 nm)	± 10 pm

Power measurement ranges

Dynamic range ³⁾	-75 to +23 dBm
noise floor RMS (with averaging) ⁴⁾	-75 dBm
Absolute accuracy ^{4), 6)}	± 0.4 dB
Linearity ⁵⁾	± 0.05 dB
Readout resolution	0.01 dB
Scanning time (1250 to 1650 nm) ⁸⁾	1.5 s
Optical rejection ratio ⁴⁾	
at ± 25 GHz (± 0.2 nm)	typ 45 dBc
at ± 50 GHz (± 0.4 nm)	typ 48 dBc
PDL ⁴⁾	± 0.1 dB
Flatness ⁴⁾	± 0.2 dB
Level reproducibility ⁷⁾	± 0.05 dB

Optical ports (physical contact interfaces)

Input ports

OSA-300/301	1 × SM
OSA-303	2 × SM

Output port (drop port)

OSA-301/303	1 × SM
Interface	Universal
Optical return loss	> 35 dB
Total safe power	+23 dBm
Weight (module)	2.5 kg/5.7 lb

- ¹⁾ built in, physical constant wavelength calibrator, needs no recalibration.
- ²⁾ 1520 to 1565 nm at 23°C
- ³⁾ max. power per channel +15dBm max. total power + 23 dBm
- ⁴⁾ 1520 nm to 1565nm at 18°C to 28°C
- ⁵⁾ -45dBm to +10dBm, at 23°C
- ⁶⁾ at -10dBm
- ⁷⁾ 1 min, stable signal, const temperature
- ⁸⁾ full span 400nm, 40000 measured samples incl. WDM-table analysis

PMD Test Kit for OSA-xxx

Hardware and software option BN 3070/91.11

Applications

The OSA can be used in the qualification of legacy and new fibers for high speed transmission.

Fibers deployed for telecommunication purposes may have significant Polarization Mode Dispersion (PMD) values. If certain limits of PMD are exceeded, the bit error ratio rapidly increases. The maximum PMD values permitted for various bit rates are shown in table 1.

Bit rate Gb/s	Max. PMD (ps)	PMD coeff. of fiber for 4090 km length (ps/ km)
2.5	40	<2.0
10	10	<0.5
40	2.5	<0.125

Table 1: Maximum allowed PMD values for digital signal transmission

Specifications

The JDSU PMD solution – developed specifically for portable field applications – is based on the Fixed Analyzer Method (FOTP-113) which is equivalent to the Interferometric Method (ANSI/TIA/EIA FOTP-124) and provides comparable results. The PMD solution test kit consists of a polarized light source (OBS-15), a polarizer (OVP-15) and evaluation software that can be run on the ONT mainframe.

Existing ONT-50s equipped with OSA modules can be upgraded to include the PMD evaluation software.

Specifications

PMD Test Kit

BN3070/91.11

Main specifications

Measurement range	0.1 to 50 ps
Dynamic range	up to 35 dB (optional up to >40 dB with OAM-200 light source, on request)
Fiber length to be measured	up to 140 km (up to >160 km with OAM-200 light source, on request)
Selectable settings for mode coupling	strong (for ordinary fibers) weak (for polarization maintaining fibers and most PMD standards)
Measurement time	approx. 4 seconds

PMD test for extended distances

Use OAM-200 plus additional polarizer instead of OBS-15.
Please contact JDSU for more detailed ordering information.

OBS-15A (broadband handheld light source)

BN2267/02

Main specifications

Output level (for back reflection <4%)	>0 dBm
Spectral power density between $\lambda_1 = 1520$ nm and $\lambda_2 = 1620$ nm	>-42 dBm/0.1 nm
Applicable fiber	SMF 9/125 μ m (PC)
Optical connector	FC, SC, DIN, etc.
(Interchangeable adapter system)	

Power supply

Battery operation	NiMH, type AA
Operating time AC operation	approx. 3.5 h

Adapter/Charger

Nominal range of use	100 to 240 V, 50/60 Hz
----------------------	------------------------

Ambient temperature conditions

Nominal range of use	-10 to +40 °C/14 to 104 °F
Storage and transport	-25 to +45 °C/-12 to 114 °F
Dimensions (w x h x d)	approx. 3.7 x 1.8 x 7.7 in approx. 95 x 49 x 185 mm

OVP-15 (Polarizer)

BN2271/01

Applicable fiber	SMF 9/125 μ m (PC)
Optical connector	2 x FC, SC, DIN, etc.
(Interchangeable adapter system)	
Max. allowable input power	+23 dBm

Ambient temperature conditions

Nominal range of use	-5 to +45 °C/23 to 114 °F
Storage and transport	-20 to +45 °C/-4 to 114 °F
Dimensions (w x h x d)	approx. 3.7 x 1.9 x 7.7 in approx. 95 x 49 x 185 mm



Ordering Information

JDSU offers a wide range of optical power meters, sources and attenuators. Contact your local sales representative for details.



BN 3070/01 ONT-50 Optical Network Tester

Mainframe with 4 slots and color TFT display touchscreen.

A minimum of one module must be ordered. ONT-50 allows any combination of modules.

BN 3070/92	Carrying case
BN 3070/92.46	Soft carrying case
BN 3070/94.01	Calibration Report

Modules and Options

DSn/PDH applications

BN 3070/90.61	DSn/PDH module single port DS1, DS3, E1, E3, E4 1 slot
BN 3070/90.62	DSn/PDH module dual port 2 x DS1, DS3, E1, E3, E4 1 slot

SONET/SDH applications

BN 3070/90.80	Module 2.5G – 1310 nm OC-1/3/12/48, STM-0/1/4/16 1 slot
BN 3070/90.18	Module 2.5G 1310/1550 nm, electrical interfaces OC-1/3/12/48, STM-0/1/4/16 1 slot
BN 3070/90.15	Module 10G – 1310 nm OC-192, STM-64 1 slot
BN 3070/90.21	Module 10G-B – 1310 nm Electrical interfaces OC-192, STM-64 prepared for jitter 2 slots
BN 3070/90.16	Module 10G – 1550 nm OC-192, STM-64 1 slot
BN 3070/90.19	Module 10G-B – 1550 nm Electrical interfaces OC-192, STM-64 prepared for jitter 2 slots

Data over SONET/SDH application

BN 3070/90.41	NewGen Solution 2.5G 1310/1550 nm, electrical interfaces SONET/SDH/EoS: OC-3/12/48, STM-1/4/16 SONET/SDH only: OC-1/STM-0 VCat LO&HO, Differential Delay, GFP, LCAS, MAC 1 slot
BN 3070/90.42	NewGen EoS interworking Consists of NewGen solution BN 3070/90.41 and Mixed Ethernet module BN 3070/90.72 2 slots
BN 3070/90.45	NewGen Solution 10G 1550 nm, electrical interfaces OC-192/STM-64 SONET/SDH/EoS VCat, LO&HO, Differential Delay, GFP, LCAS, MAC 2 slots

Ordering Information

BN 3070/93.03	IP/PoS processing Software option runs on all SONET/SDH capable modules
BN 3070/93.08	GFP-T processing Software option runs on BN 3070/90.41 and BN 3070/90.42
BN 3070/90.71	Ethernet Module 10/100/1000M 4 ports 10/100/1000 BASE-T 1 slot
BN 3070/90.72	Mixed Ethernet Module 2 ports 1000Base-SX/LX and 2 ports 10/100/1000Base-T Please select number of SFPs (2 free of charge) BN 3070/90.78 SFP 1000Base-SX BN 3070/90.79 SFP 1000Base-LX 1 slot
BN 3070/90.73	Ethernet Module 1G 4 ports 1000BASE-SX/LX Please select number of SFPs (4 free of charge): BN 3070/90.78 SFP 1000BASE-SX BN 3070/90.79 SFP 1000BASE-LX 1 slot

OTN applications

BN 3070/90.17	OTN Module 2.5/2.7G 1310/1550 nm, electrical interfaces OC-1/3/12/48, STM-0/1/4/16, OTU-1 1 slot
BN 3070/90.30	OTN Module 10/10.7G 1550 nm, OC-192, STM-64, OTU- 2 2 slots
BN 3070/90.32	OTN Module 10/10.7G-B 1550 nm, electrical interfaces OC-192, STM-64, OTU-2 prepared for jitter 2 slots
BN 3070/90.33	OTN Module 10/10.7G-B 1310 nm, electrical interfaces OC-192, STM-64, OTU-2 prepared for jitter 2 slots

Jitter/Wander application

BN 3070/90.95	Jitter Module 10G-B High-accurate jitter 10G Evaluated with O.172 Appendix VII + VIII Requires BN 3070/90.19, BN 3070/90.21 1 slot
BN 3070/90.93	Jitter Module 10/10.7G-B High-accurate jitter 10G, 10.7G Evaluated with O.172 Appendix VII + VIII Requires BN 3070/90.32, BN 3070/90.33 1 slot
BN 3070/93.91	Wander 10/10.7G Software option, TIE, MTIE, TDEV Requires BN 3070/90.93, BN 3070/90.95

Optical Modules

Full-band DWDM analyzers

BN 3070/91.01	OSA-160 Single port 2 slots
BN 3070/91.12	OSA-161 Single port with drop 10.7 2 slots
BN 3070/91.14	OSA-201 Dual port with drop 10.7 2 slots

High performance DWDM analyzers

BN 3070/91.31	OSA-300 Single port 3 slots
BN 3070/91.32	OSA-301 Single port with drop 10.7 3 slots
BN 3070/91.34	OSA-303 Dual-port with drop 10.7 3 slots

Optical amplifier

BN 3070/92.20	OAM-200 (C-band) 1 slot
BN 3070/92.21	OAM-201 (C+L-band) 1 slot
BN 3070/91.11	PMD test kit

Optical connectors

One type of optical connector must be selected from BN 2060/00.xy for every digital module except Ethernet as listed below.

Measuring adapter

BN 2060/00.51	FC, FC-PC, FC-APC
BN 2060/00.58	SC, SC-PC, SC-APC
BN 2060/00.32	ST type (AT&T)
BN 2060/00.50	DIN 47256
N 2060/00.53	E 2000 (Diamond)
BN 2060/00.59	LC, F-3000 (PC-APC)

Optical attenuators

BN 2239/90.30	10 dB, FC-PC, 1310/1550 nm
BN 2239/90.38	10 dB, SC, 1310/1550 nm

Related products



ONT-506 Optical Network Tester

Desktop solution for testing of design and conformance of Next Generation transport networks. SDH, SONET, Multi-channel, OTN, Jitter, NewGen, Ethernet. Multiple users can run multiple applications simultaneously and independently. Linux operating system. High resolution 15" colored touchscreen, 6 slots.



ONT-512 Optical Network Tester

Rack-mount solution for testing of design and conformance of Next Generation transport networks. Same applications as ONT-506. Easy integration into automated environments with Linux operating system and Tcl/Tk and LabWindows libraries. Built-in controller, 12 slots.



OLC-65 Optical Level Controller

The OLC-65 contains both attenuator and power meter function making test set-up simple and eliminating the need to connect several instruments, cables and couplers. See OLC-65 data sheet for details.



GPIB-RS232 Converter GPIB-232CV-A

It is recommended that the National Instruments GPIB/RS-232 Converter be used for controlling the ONT-50 via GPIB. Ordering is country-specific.

Go to www.ni.com for further details.



Handheld Fiber Inspection Microscope OIM-400

Many light transmission problems occur as a result of improper fiber connectors. The Fiber Microscope reflects details of scratches and any contamination of connector end surfaces. The light weight microscope is equipped with universal push-pull adapter.

Magnification	400×
Power supply	3 "AAA" batteries
OIM-400	BN WO-FM-C400

All statements, technical information and recommendations related to the products herein are based upon information believed to be reliable or accurate. However, the accuracy or completeness thereof is not guaranteed, and no responsibility is assumed for any inaccuracies. The user assumes all risks and liability whatsoever in connection with the use of a product or its applications. JDSU reserves the right to change at any time without notice the design, specifications, function, fit or form of its products described herein, including withdrawal at any time of a product offered for sale herein. JDSU makes no representations that the products herein are free from any intellectual property claims of others. Please contact JDSU for more information. JDSU and the JDSU logo are trademarks of JDS Uniphase Corporation. Other trademarks are the property of their respective holders. © 2006 JDS Uniphase Corporation. All rights reserved. 30137173 501 0707 ONT-50.DS.OPT.TM.AE

Test & Measurement Regional Sales

NORTH AMERICA TEL: 866 228 3762 FAX: 301 353 9216	LATIN AMERICA TEL: +55 11 5503 3800 FAX: +55 11 5505 1598	ASIA PACIFIC TEL: +852 2892 0990 FAX: +852 2892 0770	EMEA TEL: +49 7121 86 2222 FAX: +49 7121 86 1222	WEBSITE: www.jdsu.com
--	--	---	---	--