

Keysight Technologies
N9923A FieldFox RF
Vector Network Analyzer
4/6 GHz

Data Sheet



Table of Contents

Definitions	2
FieldFox RF Vector Network Analyzer	3
Measurement Throughput	5
Corrected Measurement Uncertainty for N9923A	6
Time Domain (Option 010)	10
Mixed-Mode S-Parameters (Option 212)	11
Vector Voltmeter (Option 308)	11
Cable and Antenna Analyzer (Option 305)	11
External USB Power Sensor Support (Option 302)	11
USB Power Sensor Measurements versus Frequency (Option 208)	12
Pulse Measurement (Option 330)	12
Remote Control Capability (Option 030)	13
General Information	14
Calibration Kits	17
FieldFox Data Link Software	17

Definitions

Specification (spec.)

Warranted performance. Specifications include guardbands to account for the expected statistical performance distribution, measurement uncertainties, and changes in performance due to environmental conditions. The following conditions must be met:

- FieldFox has been turned on for 10 minutes.
- FieldFox is within its calibration cycle.
- FieldFox remains at a stable surrounding environment temperature (between -10 to 55 °C) for 90 minutes prior to turn-on and during operation.

Typical (typ.)

Expected performance of an average unit at a stable temperature between 20 °C to 30 °C for 90 minutes prior to turn-on and during operation; does not include guardbands. It is not covered by the product warranty. The FieldFox must be within its calibration cycle.

Nominal (nom.)

A general, descriptive term or design parameter. It is not tested, and not covered by the product warranty.

Calibration

The process of measuring known standards to characterize an instrument’s systematic (repeatable) errors.

Corrected (residual)

Indicates performance after error correction (calibration). It is determined by the quality of calibration standards and how well “known” they are, plus system repeatability, stability, and noise.

FieldFox RF Vector Network Analyzer

Description	Specification	Supplemental Information
Frequency range		
	2 MHz to 4 GHz	Option 104
	2 MHz to 6 GHz	Option 106
Frequency reference		
Accuracy	±2 ppm	
Aging rate	±1 ppm/yr	
Temperature stability	±1 ppm over -10 to 55 °C	
Frequency resolution	1 Hz < 3.2 GHz 1.2 Hz > 3.2 GHz	
Data points	101, 201, 401, 601, 801, 1001, 1601, 4001, 10,001 (custom number of points can be set using SCPI)	
Measurements	S11, S21 magnitude and phase S22, S12 magnitude and phase (Option 122)	
Formats	Log magnitude, linear magnitude, VSWR, phase, Smith chart, polar, group delay, unwrapped phase, real, imaginary	
Directivity		
Corrected, with full two-port calibration, N9910X-800 calibration kit (Option 122)	42 dB	
Corrected with QuickCal (Option 112)		38 dB (typical)
System impedance	50Ω (nominal)	75Ω with appropriate adapter and calibration kit
System dynamic range ¹ (IF bandwidth = 300 Hz)		
2 MHz to 6 GHz	90 dB	100 dB (typical)
Receiver dynamic range ² (IF bandwidth = 300 Hz)		
2 MHz to 6 GHz		104 dB (typical)
Receiver compression level at 0.1 dB compression		+10 dBm (typical)
Test port output power		
High		+5 dBm (nominal)
Low		-40 dBm (nominal)
Manual		Power settable in 1 dB steps
Test port 1 or 2 damage level		
2 MHz to 6 GHz	+23 dBm	
Trace noise (high output power, IF bandwidth = 300 Hz)		
Magnitude		< 3 GHz, 0.008 dB rms (typical) > 3 GHz, 0.01 dB rms (typical)
Temperature stability		
Stability magnitude		0.01 dB/°C at 23 °C ±5 °C (typical)
IF bandwidths		300 Hz, 1 kHz, 3 kHz, 10 kHz, 30 kHz

1. System dynamic range = source maximum output power - receiver noise floor
2. Receiver dynamic range = receiver maximum input level - receiver noise floor

FieldFox RF Vector Network Analyzer (continued)

Description	Information
Display range	
Log magnitude S11 or S22	-1000 to 1000 dB
Log magnitude S21 or S12	-1000 to 1000 dB
Log magnitude resolution	0.01 dB
Phase	-180 to +180 degrees
Phase resolution	0.01 degrees
VSWR	1.01 to 1000
VSWR resolution	0.01
Averaging	2 to 999 Two methods: sweep and point averaging
Number of traces	Four traces available. Tr1, Tr2, Tr3, Tr4
Data markers	Each trace has six independent markers that can be displayed simultaneously. Delta markers are available for each marker.
Marker formats	Default marker format is the trace format. In Smith chart or polar format, [Real +Imag] or [Mag and Phase] formats are also available.
Marker functions	Peak, Next Peak, Peak Left, Peak Right, Mkr→ Center, Min Search, Peak Excursion, Peak Threshold, Target, Bandwidth, Tracking
Sweep type	Linear
Sweep time	Set sweep time in seconds
Sweep trigger	Continuous, single
Display formats	Single-trace Dual-trace overlay (both traces on one graticule) Dual-trace split (each trace on separate graticules) Three-trace split (each trace on separate graticules) Quad-trace split (each trace on separate graticules)
Display data	Display data, memory, data and memory, or data math
Trace math	Vector division or subtraction of current linear measurement values and memory data.
Scale	Autoscale, scale, reference level, reference position Autoscale: Automatically selects scale resolution and reference value to center the trace. Autoscale all scales all visible traces.
Title	Add custom titles to the display.
Limit lines	Define test limit lines that appear on the display for go/no go testing. Lines may be any combination of horizontal, sloping lines, or discrete data points. Each trace can have its own limit line. Limit lines can be fixed or relative, and can be built from existing traces.
Calibration Types	
CalReady	Each FieldFox is calibrated at the test port.
Frequency response	Simultaneous magnitude and phase correction of frequency response errors for either reflection or transmission measurements.
Enhanced response	Corrects for frequency response and source match for transmission measurements, and corrects for reflection frequency response, directivity and source match errors for reflection measurements.
1-port calibration	Corrects for directivity, frequency response, and source match errors.

FieldFox RF Vector Network Analyzer (continued)

Description	Information
2-port calibration (with Option 122)	Full 12-term error correction. Corrects for directivity, source match, reflection frequency response, load match, and transmission frequency response for an N9923A with Option 122, full two-port S-parameters. Unknown thru and QSOLT are both available.
1-port QuickCal (with Option 112)	Corrects for directivity, frequency response, and source match errors, using internal and external standards. QuickCal is most accurate for DUTs with 7/16 and Type-N connectors and measurement uncertainties are provided for frequencies ≤ 6 GHz. Reduced accuracy for DUTs with 3.5 mm (m), SMA (m), or other male coaxial connectors; performance is unspecified. QuickCal is not recommended for DUTs with 3.5 mm (f), SMA (f), or other similar female connectors. QuickCal is not applicable to waveguide.
2-port QuickCal (with Option 112 and 122)	Full 12-term error correction. Corrects for directivity, source match, reflection frequency response, load match, and transmission frequency response. QuickCal is most accurate for DUTs with 7/16 and Type-N connectors and measurement uncertainties are provided for frequencies ≤ 6 GHz. Reduced accuracy for DUTs with 3.5 mm (m), SMA (m), or other male coaxial connectors; performance is unspecified. QuickCal is not recommended for DUTs with 3.5 mm (f), SMA (f), or other similar female connectors. QuickCal is not applicable to waveguide.
Guided calibration wizard	FieldFox's calibration wizard recommends a calibration type and calibration kit based on selected parameters and connector types. Alternatively, users can select their own calibration type and calibration kit.
Interpolated error correction	With any type of accuracy enhancement applied, interpolated mode recalculates the error coefficients when the test frequencies are changed. The number of points can be increased or decreased and the start/stop frequencies can be changed, but the resulting frequency span must be a subset of the original calibration frequency span.

Measurement Throughput

Cycle time data, 1001 points, CalRdy, typical information.

Measurement speed

S11:1.75-3.85 GHz¹ 0.36 ms/point
 S21:1.78-2.06 GHz¹ 0.36 ms/point

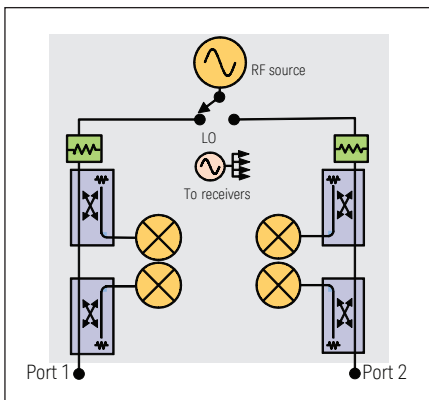

Figure 1: N9923A with Option 122

1. 1.4 ms/pt; applicable for N9923A with serial number prefix < than MY5607/SG5607/US5607 and N9923A not upgraded with Option N9910HU-500.

Corrected Measurement Uncertainty for N9923A

Corrected measurement uncertainty, 2-port or enhanced response cal, high port power (default power)

Applies to N9923A, N9910X-800 Type-N (m) calibration kit, full 2-port or enhanced response calibration, IF bandwidth = 300 Hz, no averaging, data based on high port power of +5 dBm, 2-port cal available only with Option 122.

	Corrected performance 2 MHz to 4 GHz	Corrected performance >4 GHz to 6 GHz
Directivity	42 dB	42 dB
Source match	36 dB	36 dB
Load match	40 dB	38 dB
Transmission tracking	±0.02 dB	±0.06 dB
Reflection tracking	±0.06 dB	±0.06 dB

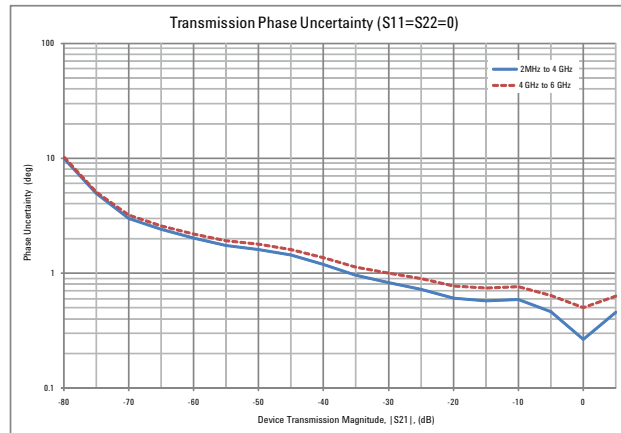
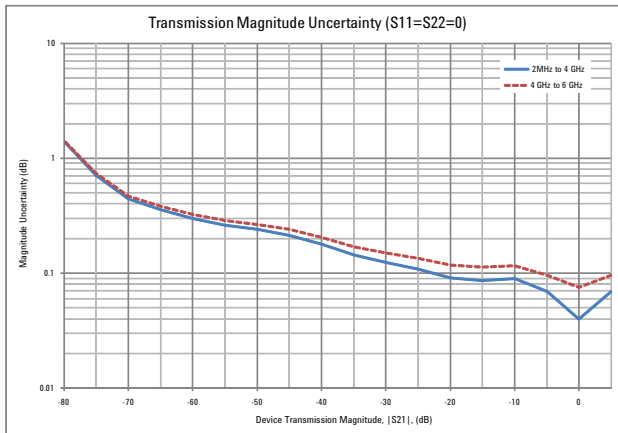

Figure 2: Transmission uncertainty (specification)

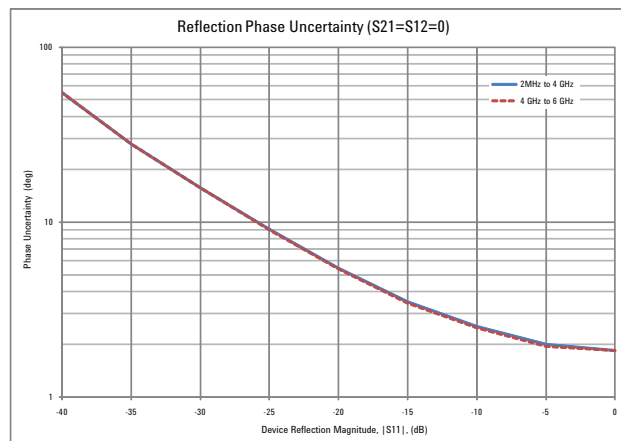
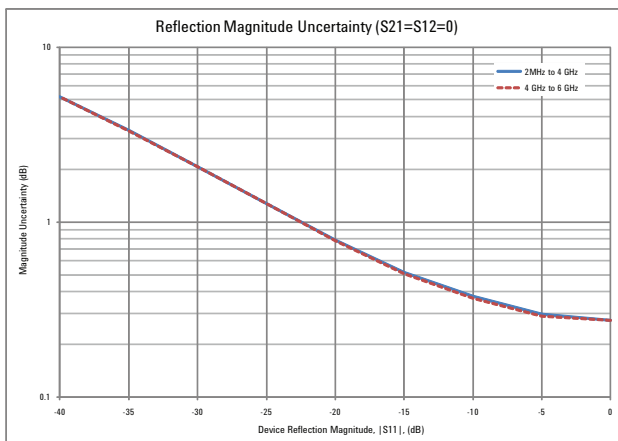

Figure 3: Reflection uncertainty (specification)

Corrected Measurement Uncertainty for N9923A (continued)

Corrected measurement uncertainty, 2-port or enhanced response cal, low port power

Applies to N9923A, N9910X-800 Type-N (m) calibration kit, full 2-port or enhanced response calibration, IF bandwidth = 300 Hz, no averaging, data based on low port power of -40 dBm, 2-port cal available only with Option 122.

	Corrected performance 2 MHz to 4 GHz	Corrected performance >4 GHz to 6 GHz
Directivity	42 dB	42 dB
Source match	36 dB	36 dB
Load match	40 dB	38 dB
Transmission tracking	±0.02 dB	±0.06 dB
Reflection tracking	±0.06 dB	±0.06 dB

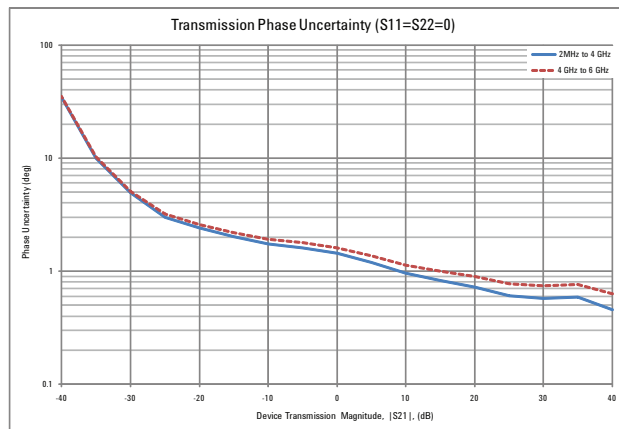
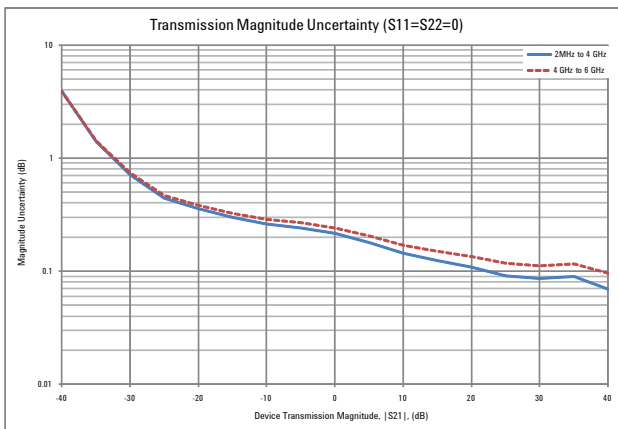

Figure 4: Transmission uncertainty (specification)

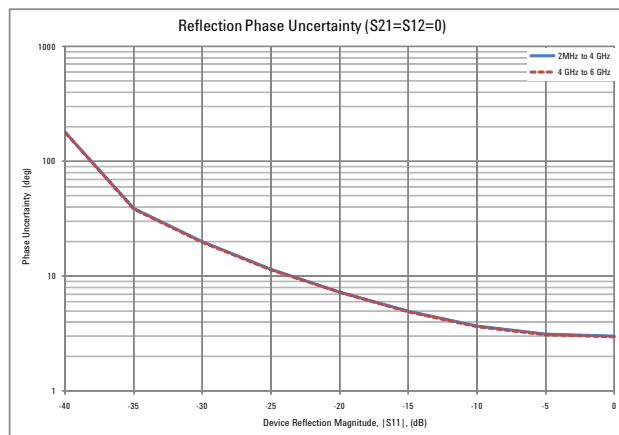
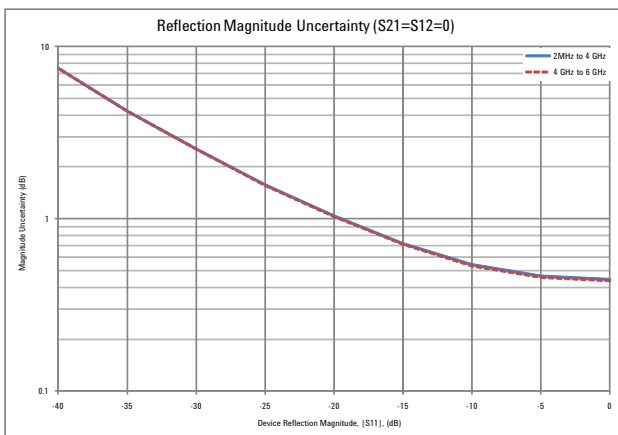

Figure 5: Reflection uncertainty (specification)

Corrected Measurement Uncertainty for N9923A (continued)

Corrected measurement uncertainty, 1- or 2-port QuickCal, high port power (default power)

Applies to N9923A with Option 112, QuickCal with load, IF bandwidth = 300 Hz, no averaging, 1-port female DUT, or 2-port female-female DUT, data based on high port power of +5 dBm , 2-port QuickCal requires Option 122, typical performance.

	Corrected performance 2 MHz to 4 GHz	Corrected performance >4 GHz to 6 GHz
Directivity	38 dB	38 dB
Source match	33 dB	23 dB
Load match	37 dB	35 dB
Transmission tracking	±0.04 dB	±0.09 dB
Reflection tracking	±0.06 dB	±0.06 dB

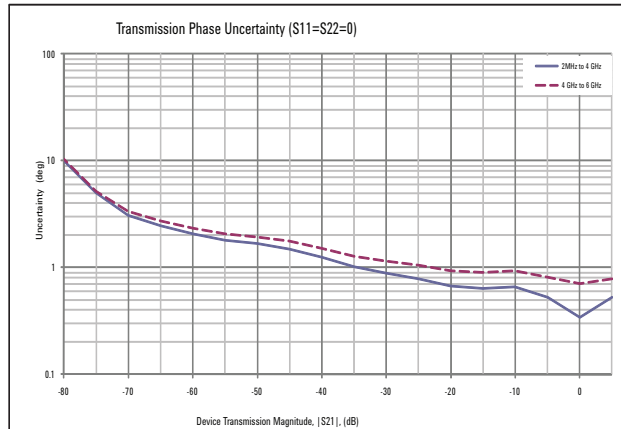
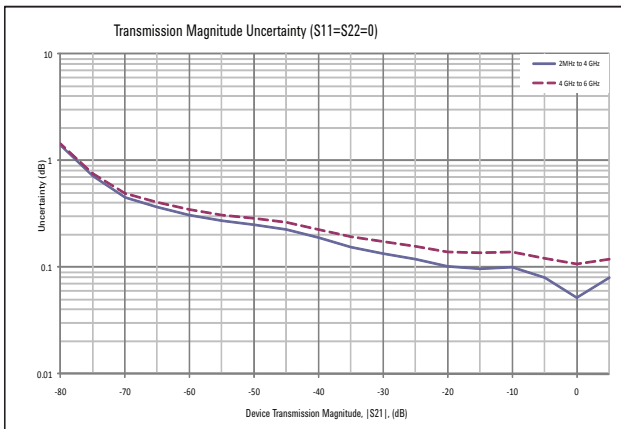

Figure 6: Transmission uncertainty

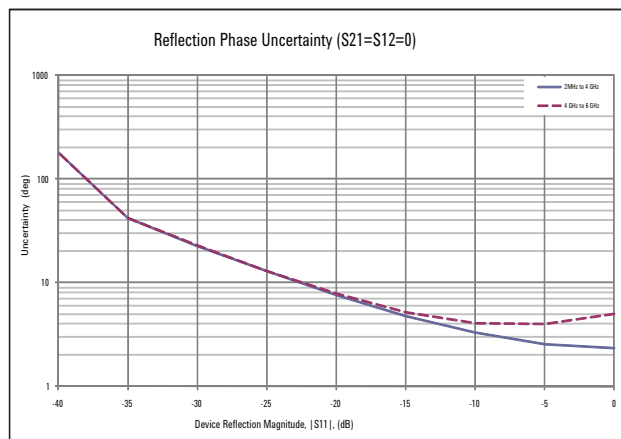
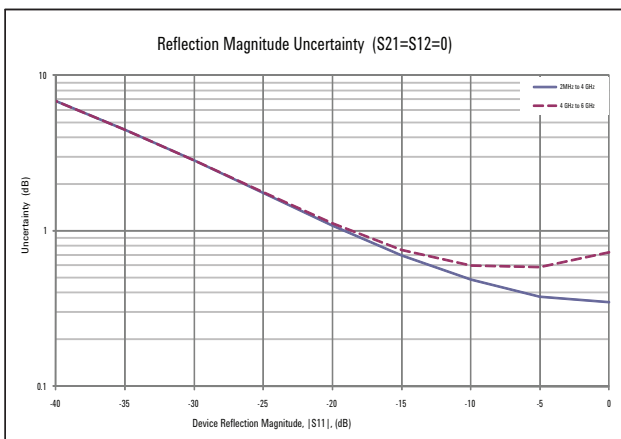

Figure 7: Reflection uncertainty

Corrected Measurement Uncertainty for N9923A (continued)

Corrected measurement uncertainty, 1- or 2-port QuickCal, low port power

Applies to N9923A with Option 112, QuickCal with load, IF bandwidth = 300 Hz, no averaging, 1-port female DUT, or 2-port female-female DUT, data based on low port power of -40 dBm , 2-port QuickCal requires Option 122, typical performance.

	Corrected performance 2 MHz to 4 GHz	Corrected performance >4 GHz to 6 GHz
Directivity	38 dB	38 dB
Source match	33 dB	23 dB
Load match	37 dB	35 dB
Transmission tracking	±0.04 dB	±0.09 dB
Reflection tracking	±0.06 dB	±0.06 dB

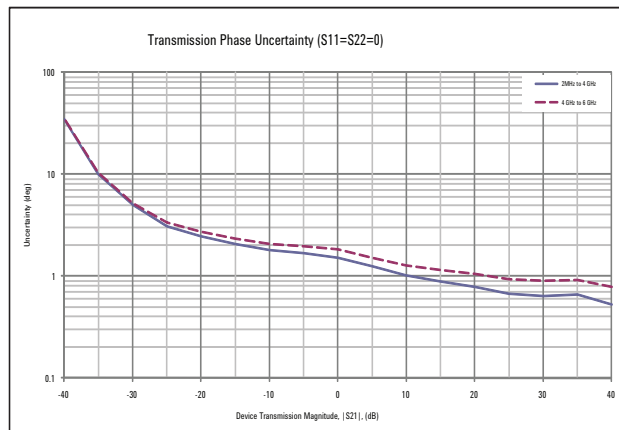
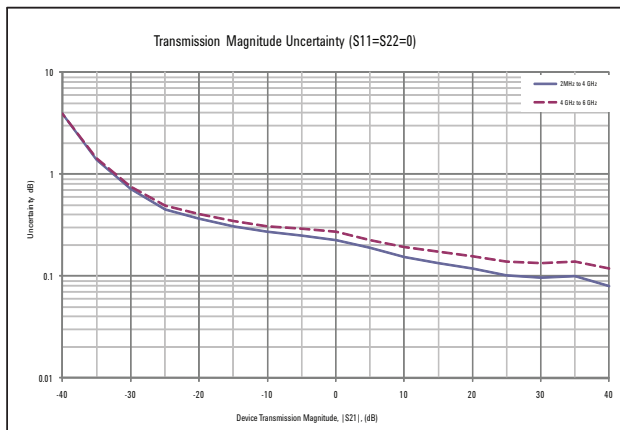

Figure 8: Transmission uncertainty

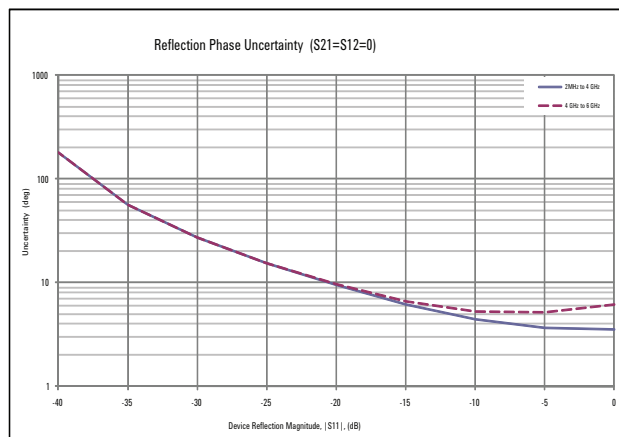
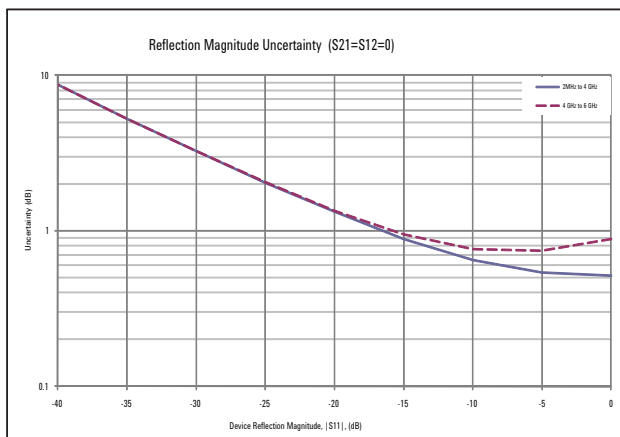

Figure 9: Reflection uncertainty

Time Domain (Option 010)

Using time domain, data from transmission or reflection measurements in the frequency domain are converted to the time domain. The time-domain response shows the measured parameter value versus time.

Time stimulus modes

- Low-pass step
This stimulus, similar to a traditional time domain reflectometer (TDR) stimulus waveform, is used to measure low-pass devices. The frequency-domain data should extend from DC (extrapolated value) to a higher value.
- Low-pass impulse
This stimulus is also used to measure low-pass devices.
- Bandpass impulse
The bandpass impulse stimulates a pulsed RF signal and is used to measure the time-domain response of band-limited devices.

Windows

The windowing function can be used to filter the frequency-domain data and thereby reduce overshoot and ringing in the time-domain response.

Gating

The gating function can be used to selectively remove reflection or transmission time-domain responses. In converting back to the frequency domain the effects of the responses outside the gate are removed.

Mixed-Mode S-Parameters (Option 212)

Mixed-mode S-parameters are also known as balanced measurements.

Measurements	
Scc11	Common mode reflection
Sdd11	Differential mode reflection
Scd11	Differential mode stimulus, common mode response
Sdc11	Common mode stimulus, differential mode response

FieldFox's mixed-mode S-parameter measurements require the use of the default factory calibration or a user 2-port calibration. So the FieldFox analyzer must be equipped with 2-port measurement functionality to measure mixed-mode S-parameters. Mixed-mode S-parameters are an extension of the VNA capabilities.

Vector Voltmeter (Option 308)

With vector voltmeter mode, you can characterize the difference between two measurements easily. The zeroing function allows you to create a reference signal, and characterize the difference between two device measurements.

- 1-port cable trimming - reflection or S11 measurement, magnitude and phase
- 2-port transmission - transmission or S21 measurement, magnitude and phase
- A/B and B/A - ratio of two receivers or channels, magnitude and phase -Need an external signal generator for the A/B or B/A measurement (must order Option 122).

The results are shown on a large display in digital format. Refer to the network analyzer section for magnitude and phase accuracy information.

Cable and Antenna Analyzer (Option 305)

The following CAT mode performance parameters are in addition to the VNA mode performance parameters specified above.

Table1: Cable and antenna analyzer specifications

Description	Specification	Supplemental Information
Cable loss		
Display range	0 to 100 dB	
Resolution	0.01 dB	
Distance-to-Fault		
Horizontal range	Range = [(number of points - 1) / frequency span * 2] * velocity factor * speed of light	Number of points auto coupled according to start and stop distance entered
Horizontal Resolution	Resolution = Range / (number of points - 1)	Number of points settable by user
Bandpass mode Window types		Maximum, medium, and minimum windows

External USB Power Sensor Support (Option 302)

The external USB power sensor option supports the Keysight Technologies, Inc. USB Power Sensors. List of supported sensors available from: <http://www.keysight.com/find/usbsensorsforfieldfox>.

USB Power Sensor Measurements versus Frequency (Option 208)

This feature allows FieldFox's source frequency to be set independently from the power sensor (receiver) frequency. With frequency-offset using power sensor (FOPS), the frequency of both the source and receiver are swept, and the two track each other. The offset frequency can be negative, zero, or positive.

FOPS can be used to characterize the scalar transmission response of devices such as mixers and converters. This frequency-offset capability is necessary for conversion loss/gain measurements on frequency-translating devices, since by definition, the input and output frequencies of the DUT are different. The FieldFox source stimulates the DUT and the power sensor is used as the measurement receiver.

Since power sensors are inherently broadband devices (not frequency-selective), the user should ensure that only the signal of interest is present at the power sensor input and that all other signals are filtered appropriately.

Setup Parameters	
Source frequency	Center/span or start/stop
Receiver frequency	Range determined by power sensor range
Frequency offset	Positive offset or negative offset
Frequency step size	30 kHz minimum
Number of points	2 to 1601

Source frequency span must be equal to receiver frequency span.

Receiver sweep direction: forward (default setting) or reverse.

For some DUTs, the output frequency may sweep in a reverse direction, as compared to the source frequency. The basic relationships between the source, receiver and offset frequencies are shown in the table below. The FieldFox analyzer includes an offset calculator that ensures a fast measurement setup.

Src Sweep Direction	Rx Sweep Direction	Frequency Calculations
Forward $f_{2src} > f_{1src}$	Forward $f_{2rx} > f_{1rx}$	Receiver frequency = Source frequency \pm Offset
Forward $f_{2src} > f_{1src}$	Reverse $f_{2rx} > f_{1rx}$	Receiver frequency = Offset - Source Frequency Offset $>$ Source frequency

	Description
Measurements	Source power, gain/loss and receiver (Rx) power Gain = Rx power / source power (memory). Source power (memory) is measured during setup
Output power	Refer to the test port output power typical data on page 3
Dynamic range	The dynamic range with FOPS is dependent on FieldFox's output power and the power sensor's dynamic range. Supported USB power sensors: www.keysight.com/find/fieldfoxsupport

Pulse Measurements (Option 330)

FieldFox's pulse measurement option can be used to characterize RF pulses such as those used in radar and electronic warfare systems. Measurements are made using FieldFox and Keysight's USB peak power sensors.

Performance specifications such as frequency, dynamic range and minimum pulse width depend on the peak power sensor. Supported peak power sensors: <http://www.keysight.com/find/fieldfoxsupport>

	Description
Setup parameters	Frequency, time (center), time/division, gating, triggering, video bandwidth, averaging
Functions	Average power, peak power, and peak to average ratio Analog gauge display and digital display, dBm and watts Relative/absolute measurements, offset, dB or %, minimum and maximum limits Trace graph for pulse profiling with gating Rise time, fall time, pulse width, pulse period, pulse repetition frequency

Remote Control Capability (Option 030)

Option 030 adds remote control capability to the FieldFox analyzers that allows FieldFox to be controlled via an iOS device. The FieldFox app, running on the iOS device, combined with Option 030 on the FieldFox analyzer provides full control of the instrument from a remote location. The app emulates the front panel of the unit, so users can press any FieldFox key right from their iOS device, including hardkeys or softkeys.

iOS device requirements

- iPad, iPhone, or iPod Touch
- iOS of 5.1 or higher
- A WiFi or 3G/4G connection

The FieldFox app communicates with FieldFox via a network connection, both the iOS device and FieldFox need to be on a network where both devices can reach the other. For example, a company intranet or a site installation using a wireless router. FieldFox can be directly connected to a LAN cable, or if wired LAN is not available, a user supplied wireless router can be configured to work with FieldFox. A wireless router is not included with FieldFox.

FieldFox app without Option 030

The FieldFox app can be installed on an iOS device independent of the presence of Option 030 on the analyzer. Without Option 030, users can view the live display screen of their FieldFox remotely, but cannot control the instrument. FieldFox with Option 030 installed allows users to both view and control their FieldFox. Control refers to the ability to press hardkeys, softkeys, make or change measurements, etc.

Option 030 does not include an iOS device, users must supply their own. Option 030 is a license on the FieldFox analyzer.

Option 030 and the FieldFox app are not applicable to Android, BlackBerry, or Windows phone/tablet devices.

General Information

Description	Specification	Supplemental Information
Calibration cycle		
	1 year	
Environmental		
	Keysight Technologies outdoor equipment class ¹ MIL-PRF-28800F class 2	
Altitude – operating	9,144 m (30,000 ft)	Under battery operation [AC to DC adapter rated at 3,000 m (9,840 ft)]
Altitude – non–operating	15,240 m (50,000 ft)	
Humidity	5 to 95% relative humidity	Non-condensing up to 31°C and decreasing linearly to 50% relative humidity at 40°C
Intrusion protection	IP 30 IEC/EN 60529	
Temperature range		
Operating		
AC power	-10 to 55 °C	
Battery	-10 to 50 °C	-10 to 55 °C (typical)
Storage	-51 to 71 °C	With the battery pack removed. The battery packs should be stored in an environment with low humidity. Extended exposure to temperature above 45 °C could degrade battery performance and life.
EMC		
Complies with European EMC Directive 2004/108/EC	EC/EN 61326-1 CISPR Pub 11 Group 1, class A AS/NZS CISPR 11 ICES/NMB-001	
ESD		
	IEC/EN 61000-4-2	
Safety		
Complies with European Low Voltage Directive 2006/95/EC	EC/EN 61010-1 2 nd Edition Canada: CSA C22.2 No. 61010-1-04 USA: UL 61010-1 2 nd Edition	
Power		
Power supply		
External DC input	15 to 19 VDC	40 W maximum when battery charging
External AC power adapter		Efficiency Level IV, 115 VAC
Input	100 to 250 VAC, 50 to 60 Hz 1.25 – 0.56 A	
Output	15 VDC, 4 A	
Power consumption		On: 14 W (typical)

1. Samples of this product have been type tested in accordance with the Keysight Environmental Test Manual (ETM) for outdoor equipment (OE) and verified to be robust against the environmental stresses of storage, transportation and end use; those stresses include but are not limited to temperature, humidity, shock, vibration, altitude and power line conditions

General Information (continued)

Description	Specification	Supplemental Information
Battery		
	10.8 V, 4.6 A-h	Lithium ion
Operating time		3.5 hours (typical)
Charge time	A fully discharged battery takes about 1.5 hours to recharge to 80%, 4 hours to 100%	
Discharge temperature limits ¹	-10 to 60 °C, ≤ 85% RH	
Charge temperature limits ¹	0 to 45 °C, ≤ 85% RH	
Storage temperature limits	-20 to 50 °C ¹ , ≤ 85% RH	The battery packs should be stored in an environment with low humidity. Extended exposure to temperature above 45 °C could degrade battery performance and life
Data storage		
Internal	Minimum 4 GB	Up to 1000 instrument states and trace
External		Supports USB 2.0 compatible memory devices; Supports microSD and microSDHC memory cards
Display	6.5" transfective color VGA LED-backlit 640 x 480 with anti-glare coating	
Weight	2.7 kg (6.0 lbs) including battery	
Dimensions (H x W x D)	292 x 188 x 72 mm (11.5" x 7.4" x 2.8")	
Test ports		
RF Port 1 or Port 2		
Connector	Type-N, female	
Impedance	50 Ω (nominal)	
Damage level	> +23 dBm, > ±50 VDC	
Headphone Jack Connector	3.5 mm (1/8 inch) miniature audio jack	
USB		
USB-A (2 ports)	Hi-speed USB 2.0	
Mini USB (1 port) ²	Hi-speed USB 2.0	Used for SCPI programming
LAN	100Base-T ONLY 10Base-T is NOT supported	
External	RJ-45 connector	
Programming	The built-in LAN interface and firmware, support data transfer and control via direct connection to a LAN network.	

- Charge and discharge temperatures are internal temperatures of the battery as measured by a sensor embedded in the battery. The Battery screen displays temperature information. To access the screen, select **System**, **Service Diagnostics**, and **Battery**.
- SCPI over USB is only available for N9923A with serial number prefix starting with MY5607/SG5607/US5607 and N9923A upgraded with Option N9910HU-500.

General Information (continued)

Description	Specification	Supplemental Information
External Reference /Trigger Input		
Connector	BNC female	
External reference		
Input frequency	10 MHz	
Input amplitude range		-5 dBm to +10 dBm (nominal)
Impedance		50 Ω (nominal)
Lock Range		± 10 ppm of external reference frequency (nominal)
Trigger Input		
Impedance		10 K Ω (nominal)
Level Range		
Rising Edge		1.7 V (nominal)
Falling Edge		1 V (nominal)

Calibration Kits

The following is a list of the calibration kits that are loaded in a standard FieldFox. Users can add additional calibration kits to their unit using FieldFox Data Link Software. Note regarding QuickCal: The basic QuickCal, either 1 or 2-port does not require any standards. For higher accuracy, users can perform QuickCal with a load.

N9910X-800	T-calibration kit, DC-6 GHz, Type-N(m)
N9910X-801	T-calibration kit, DC-6 GHz, Type-N(f)
N9910X-802	T-calibration kit, DC-6 GHz, 7/16 DIN(m)
N9910X-803	T-calibration kit, DC-6 GHz, 7/16 DIN(f)
85031B	Economy calibration kit, DC to 6 GHz, 7 mm
85032E	Economy calibration kit, DC to 6 GHz, Type-N, 50-ohm
85032F	Standard calibration kit, DC to 9 GHz, Type-N, 50-ohm
85033E	Standard calibration kit, DC to 9 GHz, 3.5 mm
85036B	Standard calibration kit, DC to 3 GHz, Type-N 75-ohm
85036E	Economy calibration kit, DC to 3 GHz, Type-N 75-ohm
85038A	Standard calibration kit, DC to 7.5 GHz, 7-16
85039B	Economy calibration kit, DC to 3 GHz, Type-F, 75-ohm
85052D	Economy calibration kit, DC to 26.5 GHz, 3.5 mm
85054B	Standard calibration kit, DC to 18 GHz, Type-N, 50-ohm
85054D	Economy calibration kit, DC to 18 GHz, Type-N, 50-ohm

FieldFox Data Link Software

FieldFox Data Link software, installed on a PC, provides the following capabilities:

- Capture of current trace and setting
- Opening of data files (s1p, s2p, csv, sta, and png) residing on the instrument
- Editing cal kit and cable files on the instrument, or creating new cal kits and cables
- Transferring files to/from the instrument
- Annotating plots for documentation purposes
- Marker, limit line, and format changes on the PC
- Report generation
- Printing function

FieldFox Data Link Software is available from Keysight FieldFox Customer Support

<http://www.keysight.com/find/fieldfoxsupport>

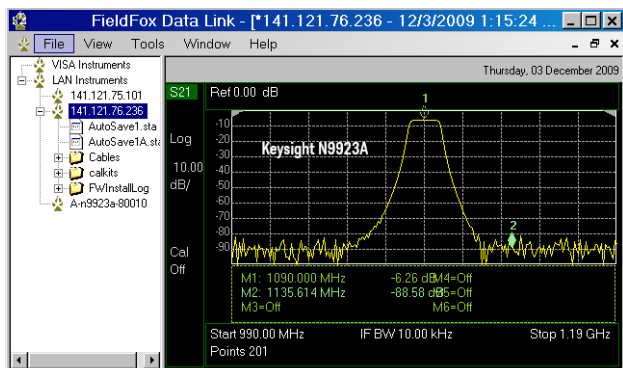

Figure 11: FieldFox Data Link Software

Evolving Since 1939

Our unique combination of hardware, software, services, and people can help you reach your next breakthrough. We are unlocking the future of technology.

From Hewlett-Packard to Agilent to Keysight.



For more information on Keysight Technologies' products, applications or services, please contact your local Keysight office. The complete list is available at: www.keysight.com/find/contactus

Americas

Canada	(877) 894 4414
Brazil	55 11 3351 7010
Mexico	001 800 254 2440
United States	(800) 829 4444

Asia Pacific

Australia	1 800 629 485
China	800 810 0189
Hong Kong	800 938 693
India	1 800 11 2626
Japan	0120 (421) 345
Korea	080 769 0800
Malaysia	1 800 888 848
Singapore	1 800 375 8100
Taiwan	0800 047 866
Other AP Countries	(65) 6375 8100

Europe & Middle East

Austria	0800 001122
Belgium	0800 58580
Finland	0800 523252
France	0805 980333
Germany	0800 6270999
Ireland	1800 832700
Israel	1 809 343051
Italy	800 599100
Luxembourg	+32 800 58580
Netherlands	0800 0233200
Russia	8800 5009286
Spain	800 000154
Sweden	0200 882255
Switzerland	0800 805353
	Opt. 1 (DE)
	Opt. 2 (FR)
	Opt. 3 (IT)
United Kingdom	0800 0260637

For other unlisted countries:

www.keysight.com/find/contactus
(BP-9-7-17)

DEKRA Certified
ISO 9001 Quality Management System

www.keysight.com/go/quality

Keysight Technologies, Inc.
DEKRA Certified ISO 9001:2015
Quality Management System

This information is subject to change without notice.
© Keysight Technologies, 2009 - 2018
Published in USA, April 27, 2018
5990-5363EN
www.keysight.com

myKeysight

myKeysight

www.keysight.com/find/mykeysight

A personalized view into the information most relevant to you.

http://www.keysight.com/find/emt_product_registration

Register your products to get up-to-date product information and find warranty information.

KEYSIGHT SERVICES
Accelerate Technology Adoption.
Lower costs.

Keysight Services

www.keysight.com/find/service

Keysight Services can help from acquisition to renewal across your instrument's lifecycle. Our comprehensive service offerings—one-stop calibration, repair, asset management, technology refresh, consulting, training and more—helps you improve product quality and lower costs.

Keysight Assurance Plans

www.keysight.com/find/AssurancePlans

Up to ten years of protection and no budgetary surprises to ensure your instruments are operating to specification, so you can rely on accurate measurements.

Keysight Channel Partners

www.keysight.com/find/channelpartners

Get the best of both worlds: Keysight's measurement expertise and product breadth, combined with channel partner convenience.

www.keysight.com/find/fieldfox

