

M9484C VXG

Vector Signal Generator

Introduction

This data sheet provides key features and specifications for the M9484C VXG vector signal generator.



Table of Contents

About the M9484C VXG Vector Signal Generator	3
Definitions and Conditions	4
Frequency	5
Frequency Reference	5
Power	7
Spectral Purity	10
Pulse Modulation (Option PMR or PME)	14
Vector Modulation (Options Bxx, Rxx).....	15
Internal Baseband Generator (Options Bxx, Rxx).....	16
Error Vector Magnitude (EVM).....	18
Distortion Performance (Adjacent Channel Power Ratio)	20
Remote Programming.....	21
General Specifications.....	21
Related Literature	23

About the M9484C VXG Vector Signal Generator

You're designing the next RF breakthrough and ensuring that your design delivers maximum throughput, robust links, and data handling capabilities. This introduces a new set of design and test challenges, including more bandwidths, frequency bands, and system complexity.

Keysight has created the ultimate VXG signal generator to take your designs to the widest bandwidths, highest frequencies, and multichannel applications. With this fully integrated, calibrated, and synchronized solution, you don't need to worry about the errors caused by additional connections and instruments. Through integration with PathWave Signal Generation software, create performance-optimized reference signals and reduce the time you spend on signal simulation.

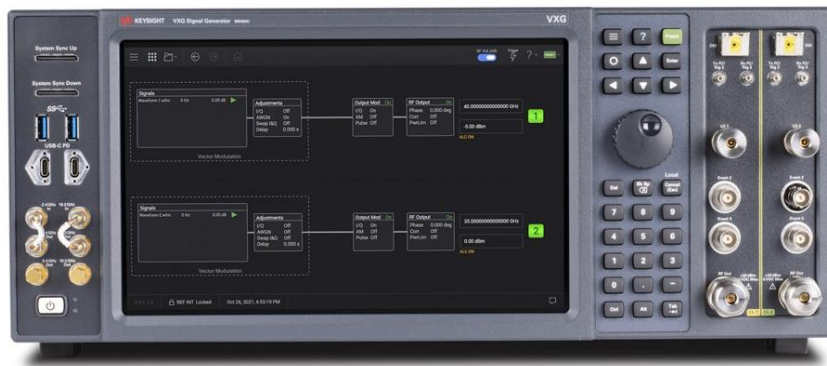

Figure 1. M9484C VXG signal generator with two 54 GHz channels.

Definitions and Conditions

Specification

Specifications represent warranted performance of a calibrated instrument that has been stored for a minimum of 2 hours within the operating temperature of 0 to 50 °C, unless otherwise stated, and after a 45-minute warm-up period. The specifications include measurement uncertainty. Data represented in this document are specifications unless otherwise noted.

Typical

Typical (typ) describes additional product performance information that is not covered by the product warranty. It is performance beyond specifications that 80 percent of the units exhibit with a 90 percent confidence level at room temperature (approximately 25 °C). Typical performance does not include measurement uncertainty.

Nominal

Nominal (nom) values indicate the expected mean or average performance, or an attribute whose performance is by design, such as the 50-ohm connector. This data is not warranted and is measured at room temperature (approximately 25 °C).

Measured

Measured (meas) describes an attribute measured during the design phase for purposes of communicating expected performance, such as amplitude drift vs. time. This data is not warranted and is measured at room temperature (approximately 25 °C).

All of the above apply when using the instrument in its default settings unless otherwise stated.

Frequency

Frequency options

Option	CW frequency range	RF output connector
M9484C-506	9 kHz to 6 GHz	Type-N (f)
M9484C-508	9 kHz to 8.5 GHz	Type-N (f)
M9484C-514	9 kHz to 14 GHz	3.5 mm (m)
M9484C-520	9 kHz to 20 GHz	3.5 mm (m)
M9484C-532	9 kHz to 31.8 GHz	1.85 mm (m)
M9484C-544	9 kHz to 44 GHz	1.85 mm (m)
M9484C-554	9 kHz to 54 GHz	1.85 mm (m)

Frequency resolution

CW	0.00001 Hz
----	------------

Phase adjustments

Phase offset range	$\pm 180^\circ$
Phase offset resolution	0.001°

Relative phase adjustments (option PCH)¹

Relative phase offset range	$\pm 180^\circ$
Relative phase offset resolution	0.001°
Relative phase repeatability	0.0001° (nom) ²

Frequency switching speed³

10 MHz to 54 GHz	3.0 ms (meas)
------------------	---------------

Frequency Reference

Frequency accuracy

Calculation		\pm (time since last adjustment x aging rate)
		\pm temperature effects
		\pm calibration accuracy
Aging rate ⁴	First year	0.05 ppm/year, after 72-hour warm-up
	Second year	0.03 ppm/year, after 72-hour warm-up
Temperature effects (nom)	20 to 30 °C	$< \pm 10$ ppb
	Full temperature range	$< \pm 50$ ppb
Initial achievable calibration accuracy ⁵		$\pm 5 \times 10^{-8}$

Warm up (nom)

5 minutes over +20 to +30 °C, with respect to 1 hour	$< \pm 0.1$ ppm
15 minutes over +20 to +30 °C, with respect to 1 hour	$< \pm 0.01$ ppm

1 Channel 1 relative to channel 2, for example.

2 When tuning from f1 to f2 and back to f1.

3 Time from receipt of SCPI command to frequency within 0.1 ppm of final frequency or within 100 Hz, whichever is greater, and amplitude within 1 dB of final amplitude.

4 Not verified by Keysight N7800A TME Calibration and Adjustment Software. Daily aging rate may be verified as a supplementary chargeable service, on request.

5 At time of shipment.

External reference input

Standard	10 MHz, 100 MHz
Option 1ER	1 MHz to 110 MHz flexible reference
Input frequency setting resolution (1ER)	0.1 Hz
Wide locking range	± 1.0 ppm (nom), optimized for best phase stability
Narrow locking range	± 0.6 ppm (nom), optimized for best close-in phase noise
Amplitude	-3 dBm to +20 dBm (nom)
Connector	BNC female
Impedance	50 Ω (nom)

External reference input PLL synchronization bandwidths

External reference frequency	Synchronization loop bandwidth	
	Narrow	Wide
10 MHz	0.015 Hz	70 Hz
100 MHz	0.015 Hz	70 Hz
Flexible Reference (1ER) 1 – 110 MHz	0.015 Hz	70 Hz

Reference outputs

10 MHz out	
Amplitude ⁶	≥ 5 dBm, 7 dBm (typ), square wave
Connector	BNC female
Impedance	50 Ω (nom)
19.2 GHz out	
Amplitude ⁶	+7.3 dBm (nom) sine wave
Connector	SMA female
Impedance	50 Ω (nom)
2.4 GHz out ⁷	
Amplitude ⁶	+7.3 dBm (nom) sine wave
Connector	SMA female
Impedance	50 Ω (nom)

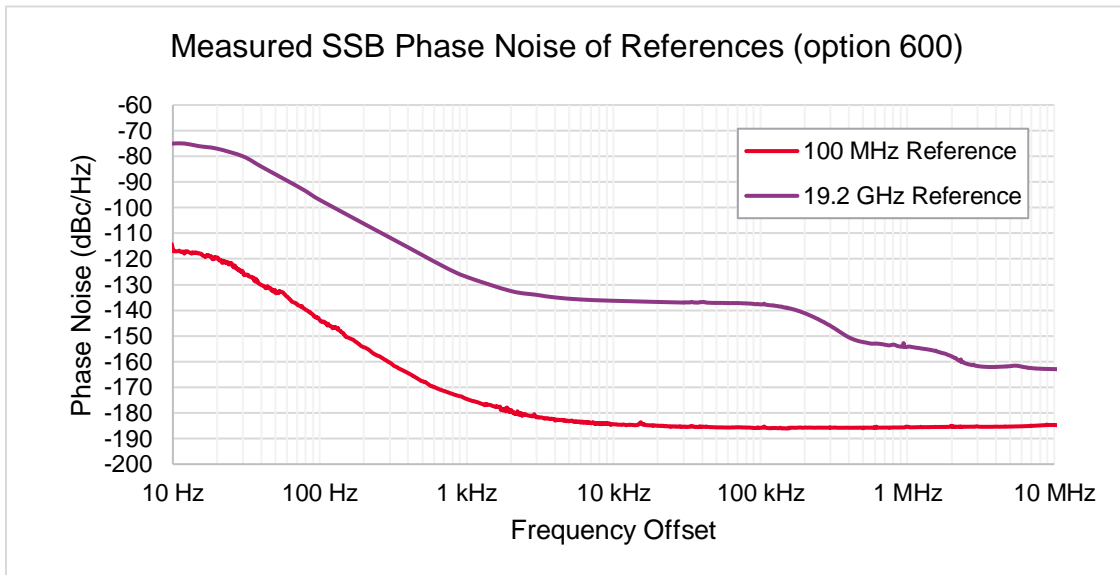

⁶ Does not include a guard band for performance distribution, measurement uncertainty, or environmental variables.

⁷ Available on instruments with options 514, 520, 532, 544, or 554.

Power

Output parameters

Settable range	Standard	-135 dBm to +20 dBm
	Options 1EA, 1EB, or 1EC	-135 dBm to +30 dBm
Resolution		0.01 dB
Output impedance		50 Ω (nom)
Maximum reverse power		+30 dBm, 0 VDC (nom)
Attenuator type		Electronic

Maximum output power, temperature range 22 to 28 °C, () = typical

Options 506 and 508			
Frequency range	Standard	Option 1EA	
9 kHz to 1 MHz	(+12 dBm)	(+12 dBm)	
> 1 MHz to 10 MHz	+10 dBm	+10 dBm (+12 dBm)	
> 10 MHz to 4 GHz	+18 dBm	+20 dBm (+24 dBm)	
> 4 GHz to 8.5 GHz	+18 dBm	+20 dBm (+23 dBm)	
Options 514 and 520			
Frequency range	Standard	Option 1EB	Harmonic filters enabled (selectable with option 1EH) ⁸
9 kHz to 1 MHz	(0 dBm)	(0 dBm)	(0 dBm)
> 1 MHz to 10 MHz	+10 dBm	+10 dBm (+12 dBm)	+10 dBm (+12 dBm)
> 10 MHz to 4 GHz	+18 dBm	+20 dBm (+24 dBm)	+12 dBm (+13 dBm)
> 4 GHz to 8.5 GHz	+18 dBm	+20 dBm (+23 dBm)	+7 dBm (+9 dBm)
> 8.5 GHz to 14.7 GHz	+18 dBm	+20 dBm (+23 dBm)	+8.5 dBm (+10 dBm)
> 14.7 GHz to 19 GHz	+18 dBm	+19 dBm (+22 dBm)	-
> 19 GHz to 21.6 GHz	+17 dBm	+17 dBm (+22 dBm)	-
Options 532, 544, and 554			
Frequency range	Standard	Option 1EC	Harmonic filters enabled (selectable with option 1EH) ⁸
9 kHz to 1 MHz	(0 dBm)	(0 dBm)	(0 dBm)
> 1 MHz to 10 MHz	+10 dBm	+10 dBm (+12 dBm)	+10 dBm (+12 dBm)
> 10 MHz to 4 GHz	+18 dBm	+20 dBm (+21 dBm)	+10 dBm (+12 dBm)
> 4 GHz to 8.5 GHz	+18 dBm	+20 dBm (+21 dBm)	+5 dBm (+8 dBm)
> 8.5 GHz to 14.7 GHz	+18 dBm	+20 dBm (+21 dBm)	+8.5 dBm (+10 dBm)
> 14.7 GHz to 19 GHz	+18 dBm	+19 dBm (+20 dBm)	-
> 19 GHz to 21.6 GHz	+17 dBm	+17 dBm (+18 dBm)	-
> 21.6 GHz to 22.5 GHz	+18 dBm	+18 dBm (+20 dBm)	-
> 22.5 GHz to 32 GHz	+18 dBm	+22 dBm (+23 dBm)	-
> 32 GHz to 43 GHz	+15 dBm	+19 dBm (+21 dBm)	-
> 43 GHz to 50 GHz	+11 dBm	+17 dBm (+19 dBm)	-
> 50 GHz to 54 GHz	+10 dBm	+12 dBm (+14 dBm)	-

⁸ Refer to standard, 1EB, or 1EC column for frequencies above 14.5 GHz.

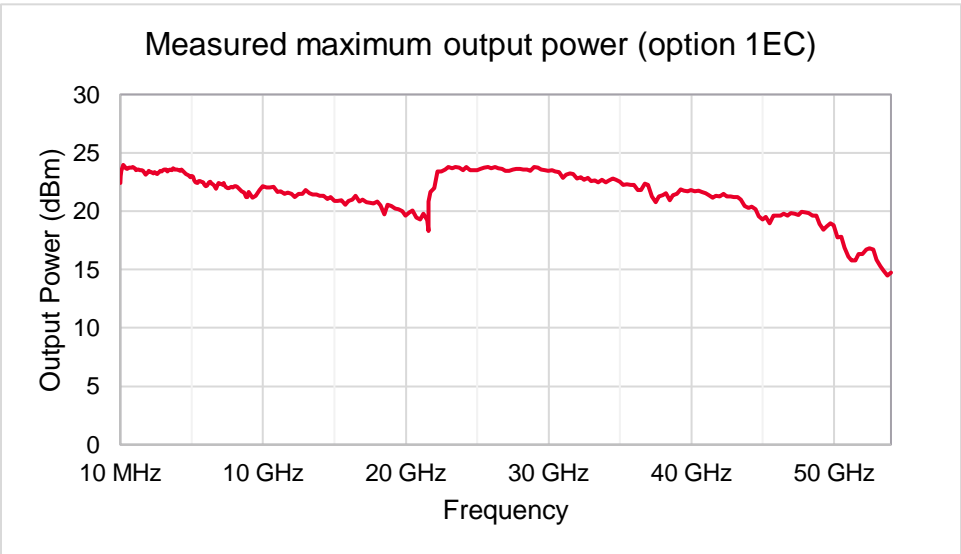
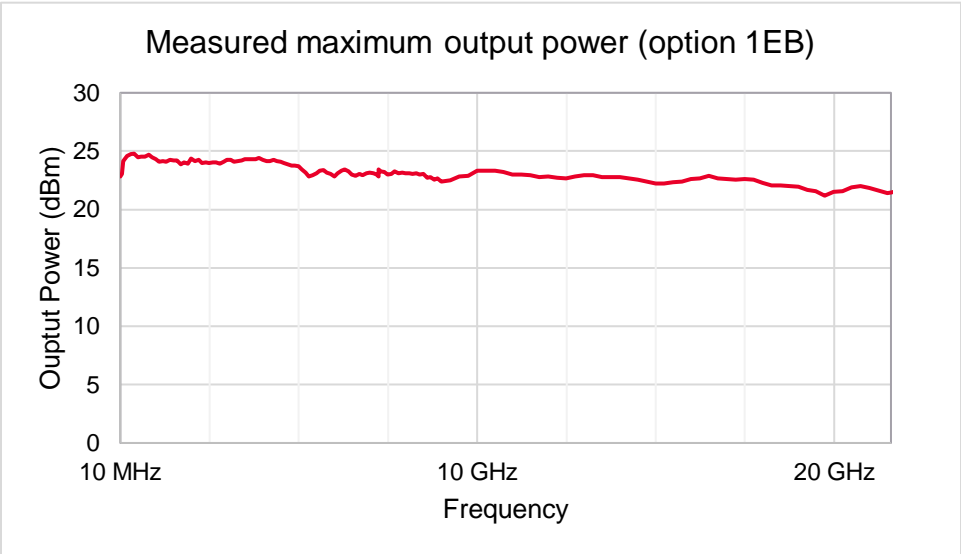
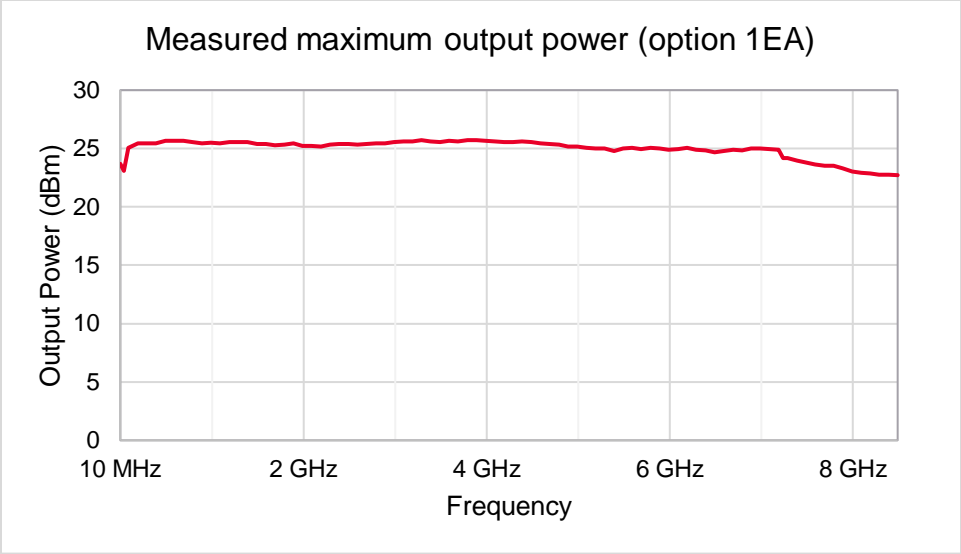

Absolute level accuracy⁹ (CW), temperature range from +22° to +28° C, ALC on, () = typical

Frequency range	+15 dBm or maximum specified power to -60 dBm	< -60 dBm to -90 dBm	< -90 dBm to -110 dBm
> 12 MHz to 6 GHz	< ±1.6 dB (±0.3 dB)	< ±1.4 dB (< ±0.3 dB)	< ±1.8 dB (< ±0.5 dB)
> 6 GHz to 8.5 GHz	< ±1.1 dB (±0.3 dB)	< ±1.6 dB (< ±0.5 dB)	< ±2.5 dB (< ±1 dB)
> 8.5 GHz to 17 GHz	< ±1.2 dB (±0.3 dB)	< ±2.1 dB (< ±0.8 dB)	< ±2.6 dB (< ±1 dB)
> 17 GHz to 20 GHz	< ±1.7 dB (< ±0.5 dB)	< ±2.7 dB (< ±1 dB)	< ±2.6 dB (< ±1 dB)
> 20 GHz to 37 GHz	< ±1.3 dB (±0.3 dB)	< ±1.8 dB (< ±0.5 dB)	< ±2.6 dB (< ±0.7 dB)
> 37 GHz to 44 GHz	< ±1.3 dB (±0.3 dB)	(< ±1.5 dB)	(< ±1.5 dB)
> 44 GHz to 50 GHz	< ±2.1 dB (< ±0.7 dB)	(< ±1.5 dB)	(< ±1.5 dB)
> 50 GHz to 54 GHz	< ±2.2 dB (< ±0.7 dB)	n/a	n/a

Absolute level accuracy⁹ (CW), temperature range from +22° to +28° C, ALC off, () = typical

Frequency range	+10 dBm or maximum specified power to -60 dBm	< -60 dBm to -90 dBm	< -90 dBm to -110 dBm
> 1 MHz to 12 MHz	< ±1.5 dB (< ±0.5 dB)	n/a	n/a
> 12 MHz to 6 GHz	< ±1.6 dB (< ±0.3 dB)	< ±1.7 dB (< ±0.4 dB)	< ±1.8 dB (< ±0.4 dB)
> 6 GHz to 8.5 GHz	< ±1.5 dB (< ±0.5 dB)	< ±1.6 dB (< ±0.5 dB)	< ±2.5 dB (< ±1 dB)
> 8.5 GHz to 17 GHz	< ±1.7 dB (< ±0.5 dB)	< ±2.7 dB (< ±1.1 dB)	< ±2.6 dB (< ±1.1 dB)
> 17 GHz to 20 GHz	< ±2.5 dB (< ±1 dB)	< ±2.7 dB (< ±1.1 dB)	< ±2.6 dB (< ±1.1 dB)
> 20 GHz to 37 GHz	< ±1.6 dB (< ±0.5 dB)	< ±1.8 dB (< ±0.6 dB)	< ±3.1 dB (< ±0.8 dB)
> 37 GHz to 44 GHz	< ±1.6 dB (< ±0.5 dB)	(< ±2 dB)	(< ±2 dB)
> 44 GHz to 50 GHz	< ±2.6 dB (< ±0.8 dB)	(< ±2 dB)	(< ±2 dB)
> 50 GHz to 54 GHz	< ±2.7 dB (< ±0.8 dB)	n/a	n/a

Absolute level accuracy (modulated), temperature range from +22° to +28° C, ALC auto, +10 to -20 dBm

Frequency range	3GPP W-CDMA Test model 1 with 64 DPCH, 4 carrier	5G NR 8cc x 100 MHz (800 MHz), 256QAM, 120 kHz SCS, NRB = 66
12 MHz to 8.5 GHz	±0.4 dB (nom)	±0.8 dB (nom)
> 8.5 GHz to 20 GHz	±0.5 dB (nom)	±1 dB (nom)
> 20 GHz to 54 GHz	±1 dB (nom)	±1.5 dB (nom)

VSWR (meas)¹⁰

Options 506, 508			
Frequency	High power path	Bypass path	Thru path
240 MHz to 6 GHz	1.8 (level ≥ +7 dBm)	2.0 (+7 dBm > level > 0 dBm)	1.9 (level ≤ 0 dBm)
6 GHz to 8.5 GHz	1.9 (level ≥ +1 dBm)	1.6 (+1 dBm > level > -6 dBm)	1.5 (level ≤ -6 dBm)
Options 514, 520			
Frequency	High power path	Bypass path	Thru path
240 MHz to 6 GHz	1.6 (all power levels)		
6 GHz to 8.5 GHz	1.7 (level ≥ +1 dBm)	1.4 (level < +1 dBm)	
8.5 GHz to 17 GHz	1.8 (level ≥ +3 dBm)	1.7 (+3 dBm > level > -4 dBm)	1.6 (level ≤ 4 dBm)
17 GHz to 21.6 GHz	1.9 (level ≥ -2 dBm)	1.8 (-2 dBm > level > -11 dBm)	1.7 (level ≤ -11 dBm)

Amplitude switching speed¹¹

-110 dBm to +15 dBm	2.8 ms (meas)
---------------------	---------------

Phase linearity vs power (with vector modulation on)

Frequency	Power range	Phase linearity vs power
10 MHz to 10 GHz	+20 dBm to -80 dBm	1° RMS (nom)
> 10 GHz to 20 GHz	+20 dBm to -80 dBm	2° RMS (nom)
> 20 GHz to 54 GHz	+15 dBm to -18 dBm	3° RMS (nom)

⁹ When harmonic filters are enabled (selectable with option 1EH), specification ≤ 7 GHz is ±2.0 dB at all power levels. For frequencies <35 MHz specifications <- 70 dBm do not apply.

¹⁰ Harmonic filters not enabled (selectable with option 1EH). For CW operation; level range not valid when vector modulation is on.

¹¹ Time from receipt of SCPI command to amplitude within 1 dB of final amplitude. For frequencies ≥ 10 MHz.

Leveling modes¹²

ALC on	Power leveling with internal temperature stabilized detector feedback loop
ALC off	Temperature compensated power control
Auto	Automatic selection of ALC on or off depending on instrument settings

Spectral Purity

Harmonics¹³, measured using vector CW signal, temperature range from +22° to +28° C

Frequency	Standard (+10 dBm)	Option 1EH ¹⁴ (+5 dBm)
10 MHz to < 3.75 GHz	-30 dBc	-55 dBc
3.75 GHz to < 5.5 GHz	-30 dBc	-52 dBc
5.5 GHz to < 7.25 GHz	-30 dBc	-55 dBc
7.25 GHz to < 15 GHz	-30 dBc ¹⁵	-53 dBc
15 GHz to < 21.6 GHz	-55 dBc	-55 dBc
21.6 GHz to 27 GHz	-55 dBc ¹⁵	-55 dBc ¹⁵

Non-harmonics, +10 dBm or maximum specified power, whichever is lower, temperature range from +22° to +28° C

Frequency	> 300 Hz offset	Line-related (≤ 300 Hz offset)
10 MHz to < 7.25 GHz	-60 dBc	-57 dBc (typ)
7.25 GHz to < 21.6 GHz	-50 dBc ¹⁶	-48 dBc (typ)
21.6 GHz to < 42.5 GHz	-50 dBc	-40 dBc (typ)
42.5 GHz to < 50 GHz	-45 dBc	-38 dBc (typ)
50 GHz to 54 GHz	-40 dBc	-35 dBc (typ)

Fixed spurs with harmonic filters enabled (selectable with option 1EH), unless otherwise stated

Frequency	Level (constant over set power level)
DC – 1 MHz	-70 dBm (typ), present in all modes of operation
2.4 GHz	-70 dBm (typ)
3.6 GHz	-75 dBm (typ)
4.8 GHz	-75 dBm (typ)
8.4 GHz	-75 dBm (typ)
19.2 GHz	-100 dBm (typ)

Subharmonics

None

¹² Power alignment is a routine that offsets initial ALC off factory calibration to be in line with local ambient temperature and provides sufficient range for ALC on leveling. It should be run at regular intervals or whenever the operating temperature changes more than ± 5 °C from the previous alignment temperature.

¹³ Performance is unspecified for harmonics beyond the specified frequency range. CW signal enabled with vector modulation. Specifications may degrade when vector modulation is not used.

¹⁴ Option 1EH cannot be combined with frequency options 506 or 508.

¹⁵ Standard harmonic specification applies ≤ +5 dBm between 7.25 GHz and 15 GHz. Standard harmonic specification applies ≤ 0 dBm between 21.6 GHz and 27 GHz. 1EH harmonic specification applies ≤ 0 dBm between 21.6 GHz and 27 GHz.

¹⁶ Performance may degrade in enhanced SNR mode. With harmonic filters enabled (selectable with option 1EH), specification applies at a maximum power of +5 dBm.

Absolute SSB phase noise (CW in enhanced SNR mode at +10 dBm) (dBc/Hz) (options ST6, 600), temperature range 22 to 28°C, () = typical

Frequency	Offset								
	1 Hz	10 Hz	100 Hz	1 kHz	10 kHz	100 kHz	1 MHz	10 MHz	100 MHz
100 MHz	-82 (-91)	-110 (-117)	-125 (-130)	-145 (-150)	-153 (-158)	-153 (-158)	-152 (-158)	-153 (-158)	-
1 GHz	-62 (-72)	-90 (-97)	-105 (-110)	-135 (-139)	-144 (-148)	-151 (-155)	-153 (-159)	-154 (-159)	-154 (-159)
2 GHz	-56 (-65)	-84 (-91)	-99 (-104)	-129 (-133)	-138 (-143)	-146 (-150)	-152 (-158)	-154 (-159)	-155 (-160)
3 GHz	-52 (-62)	-80 (-87)	-95 (-101)	-126 (-130)	-135 (-140)	-143 (-147)	-150 (-156)	-154 (-159)	-155 (-160)
6 GHz	-46 (-56)	-75 (-81)	-89 (-95)	-123 (-127)	-132 (-137)	-140 (-143)	-148 (-154)	-152 (-157)	-152 (-157)
10 GHz	-42 (-51)	-71 (-77)	-84 (-90)	-118 (-121)	-129 (-132)	-133 (-136)	-139 (-144)	-143 (-149)	-142 (-148)
20 GHz	-39 (-48)	-65 (-71)	-80 (-85)	-114 (-118)	-124 (-129)	-131 (-134)	-140 (-145)	-145 (-150)	-146 (-152)
30 GHz	-36 (-46)	-59 (-67)	-72 (-79)	-112 (-117)	-123 (-128)	-130 (-133)	-137 (-145)	-143 (-149)	-138 (-145)
40 GHz	-35 (-44)	-59 (-65)	-70 (-77)	-110 (-115)	-122 (-127)	-126 (-130)	-137 (-145)	-143 (-148)	-138 (-145)
50 GHz	-34 (-41)	-57 (-63)	-67 (-75)	-108 (-112)	-120 (-123)	-122 (-125)	-133 (-140)	-143 (-148)	-138 (-145)
54 GHz	-33 (-40)	-54 (-62)	-63 (-73)	-106 (-111)	-120 (-123)	-122 (-125)	-133 (-140)	-142 (-148)	-135 (-142)

Absolute SSB phase noise (CW in enhanced SNR mode at +10 dBm) (dBc/Hz) (options ST5, 500), temperature range 22 to 28°C, () = typical

Frequency	Offset								
	1 Hz	10 Hz	100 Hz	1 kHz	10 kHz	100 kHz	1 MHz	10 MHz	100 MHz
100 MHz	-80 (-83)	-99 (-101)	-119 (-122)	-140 (-144)	-150 (-155)	-153 (-158)	-152 (-158)	-153 (-158)	-
1 GHz	-60 (-63)	-78 (-81)	-99 (-102)	-124 (-127)	-137 (-140)	-142 (-144)	-152 (-157)	-154 (-159)	-153 (-159)
2 GHz	-54 (-57)	-73 (-76)	-93 (-96)	-119 (-121)	-131 (-134)	-136 (-138)	-149 (-153)	-154 (-159)	-153 (-158)
3 GHz	-51 (-54)	-69 (-72)	-90 (-92)	-115 (-117)	-128 (-130)	-132 (-134)	-146 (-150)	-153 (-158)	-153 (-159)
6 GHz	-44 (-48)	-62 (-66)	-83 (-86)	-109 (-111)	-121 (-124)	-125 (-127)	-140 (-144)	-152 (-156)	-152 (-157)
10 GHz	-40 (-43)	-58 (-61)	-79 (-82)	-105 (-107)	-118 (-120)	-122 (-124)	-134 (-139)	-142 (-147)	-140 (-147)
20 GHz	-34 (-37)	-52 (-55)	-73 (-76)	-99 (-101)	-112 (-114)	-116 (-118)	-130 (-135)	-143 (-148)	-143 (-150)
30 GHz	-29 (-33)	-48 (-51)	-69 (-72)	-95 (-97)	-108 (-111)	-113 (-115)	-127 (-132)	-139 (-145)	-136 (-143)
40 GHz	-27 (-31)	-46 (-49)	-67 (-70)	-93 (-95)	-106 (-108)	-110 (-112)	-125 (-129)	-140 (-145)	-137 (-144)
50 GHz	-26 (-29)	-43 (-47)	-65 (-68)	-91 (-93)	-104 (-107)	-108 (-111)	-123 (-127)	-139 (-144)	-138 (-144)
54 GHz	-26 (-29)	-43 (-46)	-63 (-68)	-89 (-92)	-102 (-105)	-106 (-109)	-121 (-126)	-138 (-143)	-135 (-141)

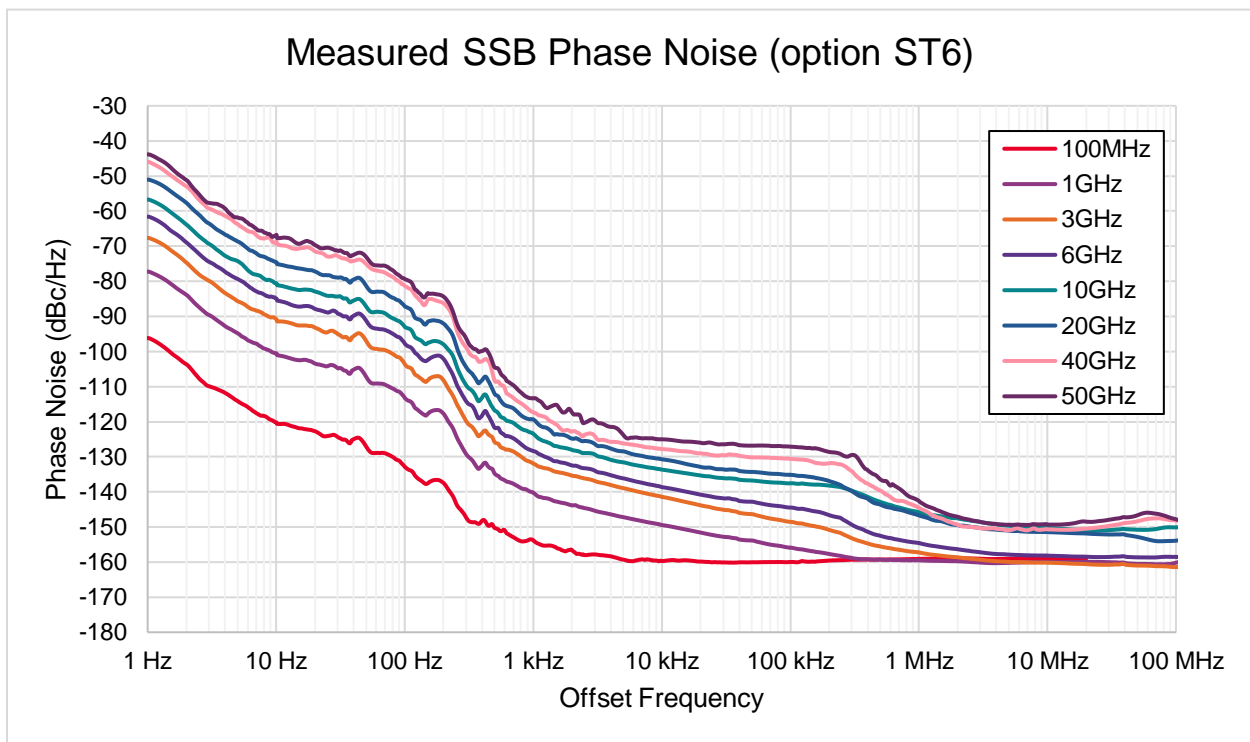

Measured SSB Phase Noise (option ST5)

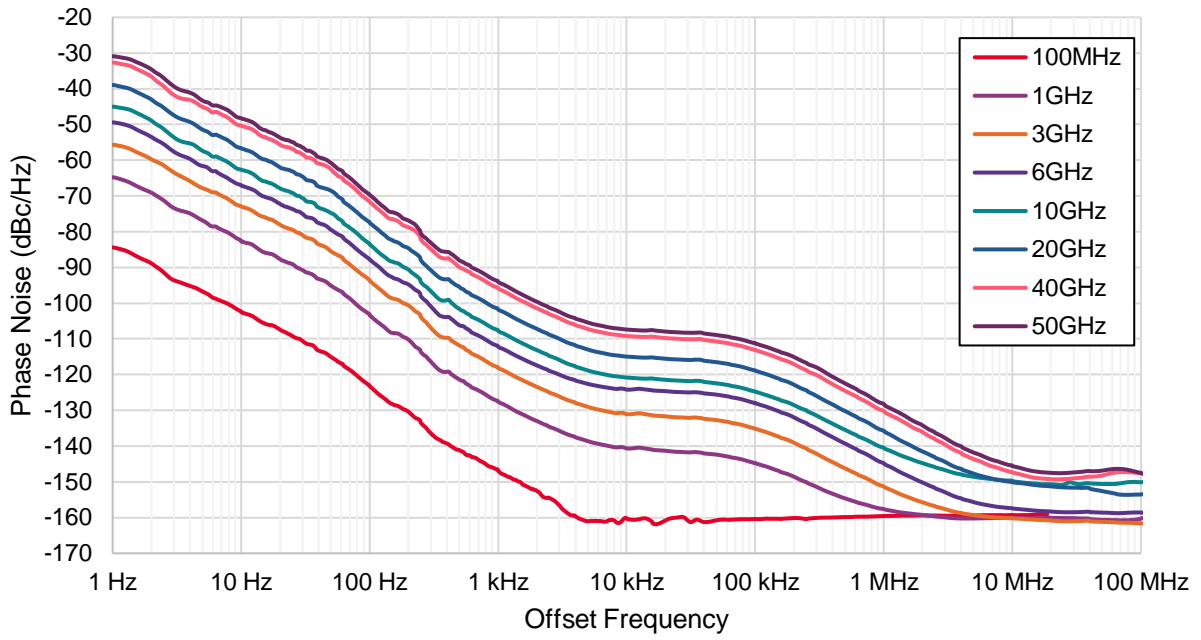

Measured SSB Phase Noise with Modulation (option ST6)

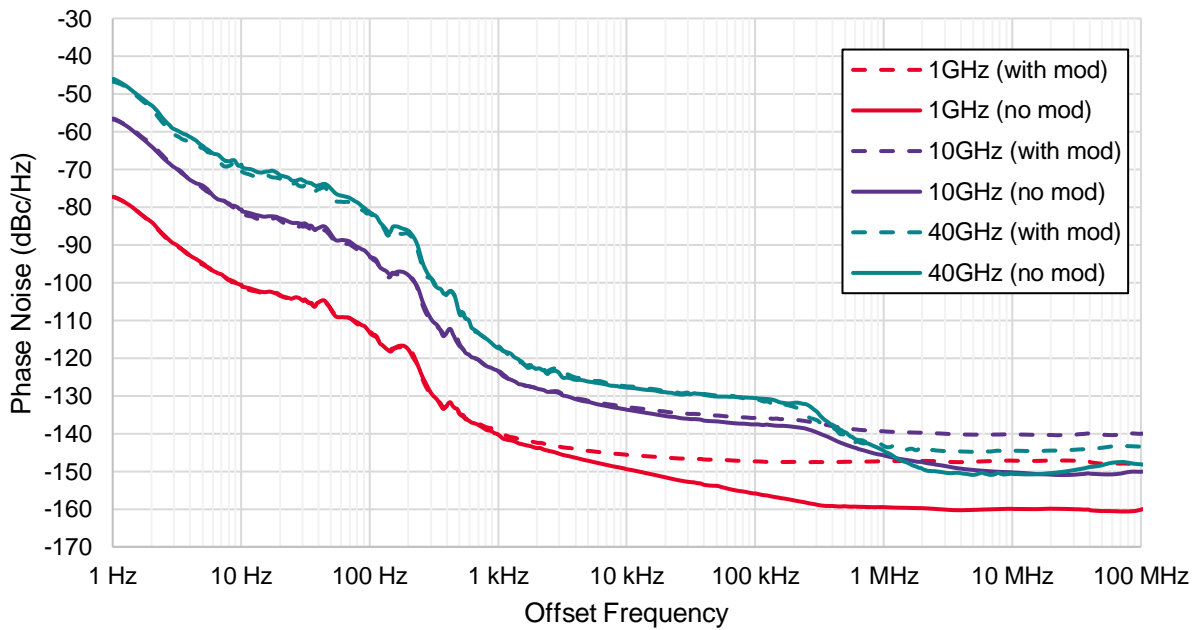

Measured Option ST5 vs. ST6 SSB Phase Noise at 10 GHz

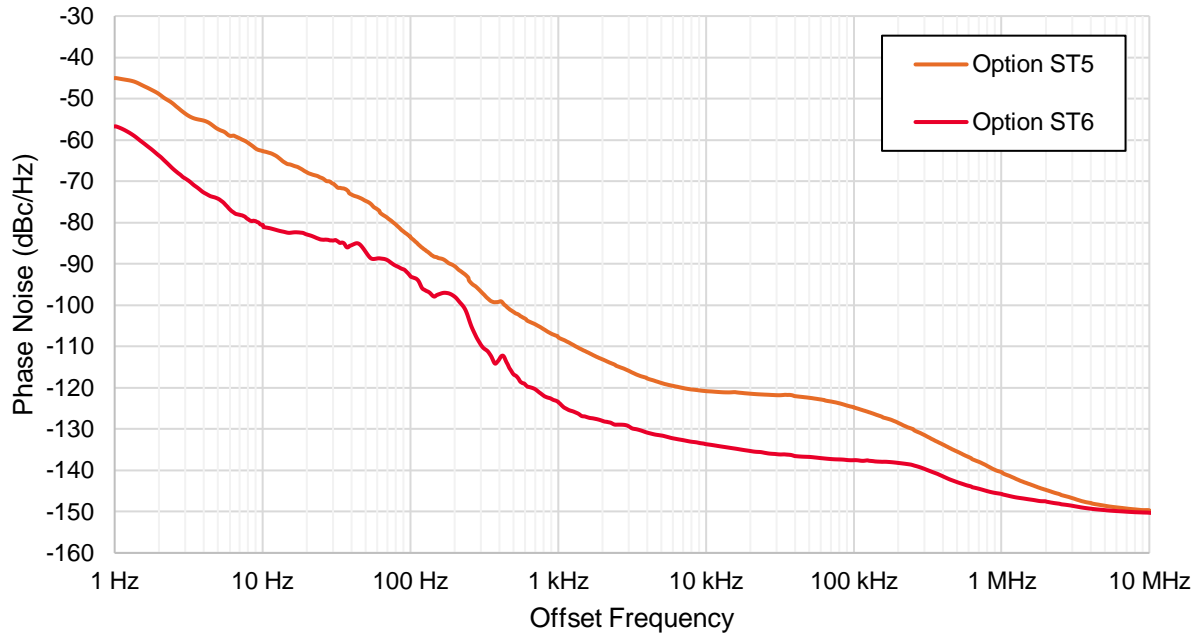

Pulse Modulation (Option PMR or PME)

Pulse modulation¹⁷, temperature range 22 to 28 °C, () = typ

Pulse paths		Internal pulse generator	
Minimum pulse width (T_w) with duty cycle $\leq 50\%$, ALC on or off	Option PMR	20 ns	
	Option PME	30 ns	
On/off ratio ¹⁸		80 dB	
Rise/fall times (T_r and T_f), ALC on or off		10 ns (6 ns)	
	ALC state	ALC on	ALC off
Level accuracy relative to CW	100 MHz to 20 GHz	± 0.6 dB	± 0.5 dB
	> 20 GHz to 45 GHz	± 1 dB	± 0.7 dB
	> 45 GHz to 54 GHz	± 1.5 dB	± 1 dB
Width compression	100 MHz to 45 GHz	± 2 ns	
	> 45 GHz to 54 GHz	± 3 ns	
Video feed-through (V_f)	100 MHz to < 1 GHz	< 50 mV p-p (< 25 mV p-p)	
	≥ 1 GHz to 54 GHz	< 25 mV p-p (< 12 mV p-p)	
Pulse overshoot	100 MHz to 45 GHz	< 10%	
	> 45 GHz to 54 GHz	< 20%	
External pulse input		No analog pulse inputs allowed	

- T_d video delay (variable)
- T_w video pulse width (variable)
- T_p Pulse period (variable)
- T_m RF delay
- T_{rf} RF pulse width
- T_f RF pulse fall time
- T_r RF pulse rise time
- V_{or} pulse overshoot
- V_f video feedthrough

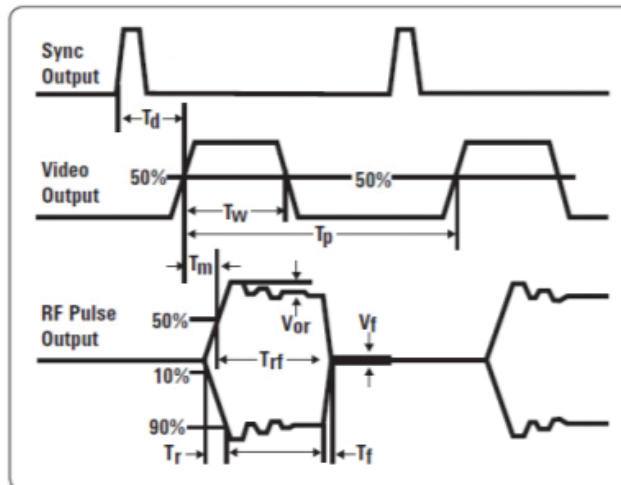

Internal pulse generator

Modes	Square, adjustable doublet	
Triggering	Free run, triggered	
Square wave rate	(50 MHz)/k from 0.1 Hz to 25 MHz where k is an integer (nom)	
Signal routing	Pulse trigger input	Trig 1- 3, Trig A-C, Trig D-O via aux connector
	Pulse sync output	Event 1
	Pulse video output	Event 2
Pulse period (PRI) (T_p)	60 ns to 41.99 s	
Pulse width (T_w)	30 ns to 41.99 s	
Video delay (T_d)	Free run	0 to 42s
	Triggered modes	0 to 42s
Sync output	30 ns to 3.99 s	
Pulse doublets	Delay 1	0 to 42s
	Pulse width 1	30 ns to 41.99 s
	Delay 2	0 to 42s – 50 ns
	Pulse width 2	30 ns to 41.99s

¹⁷ Specifications apply for center frequencies > 100 MHz. Cannot be used in combination with vector modulation.

¹⁸ On/off ratio excludes spurs.

Vector Modulation (Options Bxx, Rxx)

Internal I/Q baseband generator adjustments

Internal I and Q offset	± 20% (0.1% resolution)
Internal I/Q quadrature angle	± 20° (0.001° resolution)
Internal I/Q gain balance	± 10 dB (0.001 dB resolution)
Internal I/Q time skew	± 33.33 ns (100 fs resolution)
I/Q common delay range	0 to 16.667 ns
I/Q common delay resolution	100 fs

I/Q baseband output (Option AN1 and DIQ)

Type	Single ended (AN1), differential (DIQ)	
Output impedance	Single ended	50 Ω (nom)
	Differential	100 Ω (nom)
Frequency range	DC to 1.2 GHz (nom) for each output (2.4 GHz composite IQ)	
Common mode I/Q offset	± 1.5 V (50 μV resolution) (meas)	
Differential mode I or Q offset	± 1.5 V (50 μV resolution) (meas)	
Differential mode amplitude	DC to 200 MHz	4 Vp-p (meas) into 100 Ω
	DC to 1.2 GHz	2 Vp-p (meas) into 100 Ω

Internal real-time complex digital I/Q filters

Factory channel corrections – corrects the linear phase and amplitude response of the RF outputs of the signal generator using factory calibration arrays.

Frequency response over available modulation bandwidth¹⁹

Center frequency	Amplitude	Phase
400 MHz to 21.6 GHz	±0.25 dB (meas)	±5°(meas)
> 21.6 GHz to 35 GHz	±0.25 dB (meas)	±5°(meas)
> 35 GHz to 54 GHz	±0.5 dB (meas)	±10°(meas)

User defined automatic channel response correction and S-parameter de-embedding (N7653APPC)

Methods for fixture error removal

Scatter parameters de-embedding/embedding files generated by a network analyzer or simulation
 Automatic channel response correction using a power sensor or spectrum analyzer (amplitude and phase correction)
 Scaler user flatness (absolute power correction)

Scatter parameters

File format	.s2p, .csv
Number of cascadeable calibration sets	4

Automated channel response correction (512 taps)²⁰

Recommended maximum amplitude for error correction	± 5 dB across modulation bandwidth
--	------------------------------------

User flatness

File format	.uflat, .csv
Entry modes	USB or LAN direct power meter control

Instrument nonlinear correction (N7653APPC)

Improve the characteristics of the generated signal by digitally predistorting the waveform to reduce distortion components.

¹⁹ See **RF (I+Q) bandwidth** table for available modulation bandwidth.

²⁰ Automated routine uses power sensor to correct for linear phase and amplitude response of DUT (equalizer). See User Documentation for more details.

Internal Baseband Generator (Options Bxx, Rxx)

Definitions

Channel or port	The number of physical RF outputs
Signal ²¹	By default, each channel can generate one signal (ex: one waveform file). When option 8SG is included, each channel can generate up to 8 signals, which are summed and played out of the single RF output.
Group	A group can contain 1 to 8 signals assigned to a channel

Internal baseband generator (Options Bxx, Rxx)

Channels	In phase (I), quadrature (Q)
DAC resolution	16 bits
Waveform granularity	1 sample
Frequency offset	± half of maximum baseband bandwidth
Signal attenuation	0 to -100 dB
Sample rate resolution	10 µHz
Interpolated DAC rate	Fixed 3 GHz

RF (I + Q) bandwidth²² and sample rate

Option	RF (I + Q) bandwidth (nom)	Sample Rate (nom)
Option B1X	160 MHz	200 MSa/s
Option B2X	250 MHz	300 MSa/s
Option B5X	500 MHz	600 MSa/s
Option R10	1 GHz	1.2 GS/s
Option R25	2.5 GHz	3 GS/s

RF (I + Q) bandwidth²² and sample rate, limited options

Option	Option R1E		Option R2E	
	RF (I + Q) bandwidth (nom)	Sample rate (nom)	RF (I + Q) bandwidth (nom)	Sample rate (nom)
10 MHz to < 5.75 GHz	1 GHz	1.2 GS/s	2.5 GHz	3 GS/s
5.75 GHz to < 31.25 GHz	1 GHz	1.2 GS/s	2.2 GHz	3 GS/s
31.25 GHz to < 31.85 GHz	1 GHz	1.2 GS/s	1 GHz	3 GS/s
31.85 GHz to 36.96 GHz	550 MHz	1.2 GS/s	550 MHz	3 GS/s
> 36.95 GHz to 37.55 GHz	1 GHz	1.2 GS/s	1 GHz	3 GS/s
> 37.55 GHz to < 54 GHz	1 GHz	1.2 GS/s	2.2 GHz	3 GS/s

Arbitrary waveform memory

Maximum arbitrary waveform playback memory	Standard	256 MSa
	Option M05	512 MSa
	Option M10	1024 MSa
	Option M20	2048 MSa
	Option M40	4096 MSa
Maximum storage capacity including other user data	32 GB shared with operating systems (nom)	

Waveform segments

Segment length	512 samples ²³ to maximum arbitrary waveform playback memory
Memory allocation blocking factor	256 samples

Waveform sequences

Maximum number of segments per sequence ²⁴	65,280
Maximum number of repetitions	2 ³² -1

²¹ When AWGN or CW Interferer are enabled, option 8SG provides 7 signals.

²² Lower edge of modulated signal is not recommended to extend below 10 MHz. Upper edge of modulated signal is not recommended to extend above 8.5 GHz (option 508), 21 GHz (option 520), or 54 GHz (option 554).

²³ Waveforms with fewer samples will be repeated or extended as selected.

²⁴ Sequence memory is shared with all signals on a channel. The consumption is non-uniform based on size of waveforms, trigger type, and nested sequences.

Triggers

Trigger types	Continuous, single	
Trigger sources	Trigger key, external, bus (LAN, GPIB), global trigger (option PCH)	
Trigger modes	Continuous	Free run, trigger & run, reset & run
	Single	Buffered trigger, no retrigger, restart on trigger
Trigger features	External trigger playback synchronization	
Trigger delay range	0 to 41 s	
Trigger delay resolution	333 ps	
I/Q delay range	See Internal I/Q baseband adjustment generator section	
I/Q delay resolution	See Internal I/Q baseband adjustment generator section	
Trigger jitter	± 1.67 ns (1/300 MHz clock rate)	
Trigger latency	Reset & run, single restart on trigger	7.945 μ s to stop, 41.9533 μ s to start of playback for sample rates > 1.7 MSa/s ²⁵
	All other trigger modes	7.945 μ s
Trigger RF electrical latency	Variable depending on attenuator path and cabling	

Multi-channel baseband synchronization primary/secondary (Option PCH)

Global trigger coarse delay range	0 to 41 s
Global trigger coarse delay resolution	10 ns
Global trigger jitter	± 10 ns (nom) relative to asynchronous external system trigger event
Channel-to-channel relative trigger repeatability	< ± 5 ps (nom)

Markers

Markers are defined in a segment during the waveform generation process. Markers can be routed to the external outputs. See User's Documentation for more information.

Marker polarity	Positive
Number of markers	4
Marker routing	Event 1-3, Trig 1- 3, Trig A-C, Trig D-O via aux connector
Marker to waveform jitter (event outputs)	< 52 ps (nom) (sample rate is a submultiple of 3 GHz)
	< 333 ps (nom) (sample rate is not a submultiple of 3 GHz)
Marker to waveform jitter (trigger outputs)	< 1.67 ns (nom)
Marker edge update rate	1.67 ns
Marker combining (option 8SG)	Multiple markers can be combined on one output connector via an OR operation

AWGN (Option 403)

Type	Real-time	
Modes of operation ²⁶	Standalone signal or digitally added to signals	
Bandwidth	1.6 Hz to maximum baseband bandwidth, 0.8 Hz resolution	
Crest factor	Standalone signal	21.8 dB (nom)
	Digitally added to signals	18.5 dB (nom)
Randomness	Standalone signal	6 hours
	Digitally added to signals	194 years at 2.5 GHz bandwidth
Carrier-to-noise ratio	± 100 dB when added to signal	
Carrier-to-noise ratio formats	C/N, Eb/No	

CW interferer (Option 403)

Type	Real-time
Modes of operation ²⁷	Standalone signal or digitally added to signals
Power control	Absolute, relative to signal power
Frequency offset	\pm half of maximum baseband bandwidth ²⁸

²⁵ Contact Keysight for sample rates ≤ 1.7 MSa/s

²⁶ When AWGN is enabled, option 8SG provides 7 signals.

²⁷ When CW interferer is enabled, option 8SG provides 7 signals.

Eight virtual signal generators (Option 8SG)

Combined signal sample rate	≤ 3 GSa/s
Combined signal bandwidth	≤ maximum baseband bandwidth ²⁸
Individual signal sample rate	≤ maximum sample rate ²⁸
Individual signal frequency offset	± half of maximum baseband bandwidth ²⁸
Individual signal attenuation	0 to -50 dB

Error Vector Magnitude (EVM)

EVM for 5G NR FR1 bands, -10 dBm to +5 dBm, option ST6

Frequency	100 MHz, 256QAM, 60 kHz SCS, NRB = 135
2 GHz	0.17% (meas)
4.5 GHz	0.21% (meas)

EVM for 5G NR FR2 bands and IFs, -10 dBm to +5 dBm, option ST6

Frequency	100 MHz, 64QAM, 60 kHz SCS	400 MHz, 256QAM, 120 kHz SCS, NRB = 264
10 GHz	0.35% (meas)	0.63% (meas)
12 GHz	0.35% (meas)	0.63% (meas)
24 GHz	0.35% (meas)	0.63% (meas)
28 GHz	0.35% (meas)	0.63% (meas)
39 GHz	0.40% (meas)	0.71% (meas)
42 GHz	0.58% (meas)	0.79% (meas)

EVM for WLAN, -10 dBm to 0 dBm, option ST6

Frequency	802.11be, 320 MHz, MCS13, 300 μs, Ch Estimation Seq Only
7 GHz	-50 dB (meas)

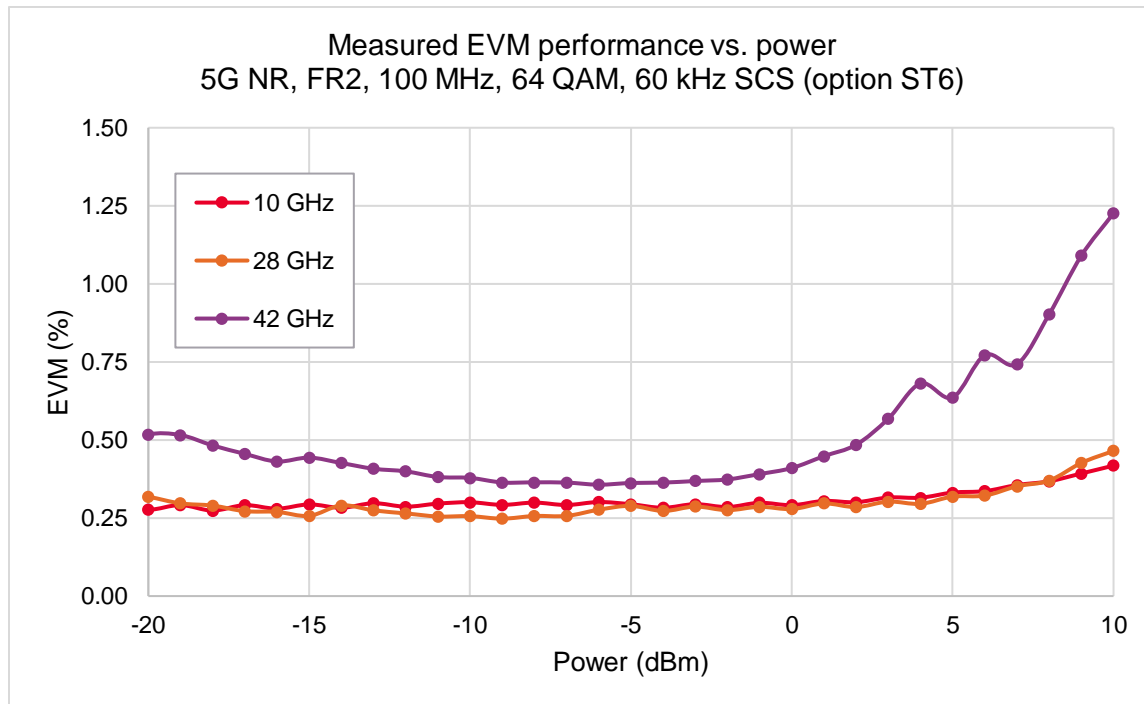

²⁸ For maximum baseband bandwidth and sample rate, see [RF \(I+Q\) bandwidth and sample rate](#).

Measured EVM performance vs. frequency
5G NR, FR2, 100 MHz, 64 QAM, 60 kHz SCS (option ST6)

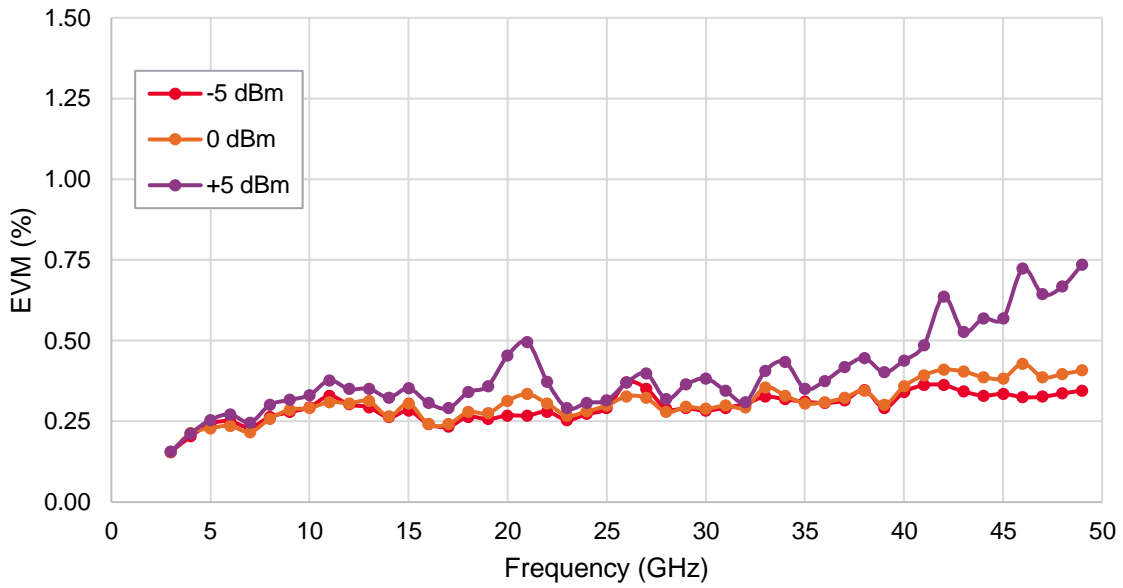

Measured EVM performance vs power
WLAN 802.11be, 320 MHz, MCS13, 300 μ s,
Ch Estimation Seq Only

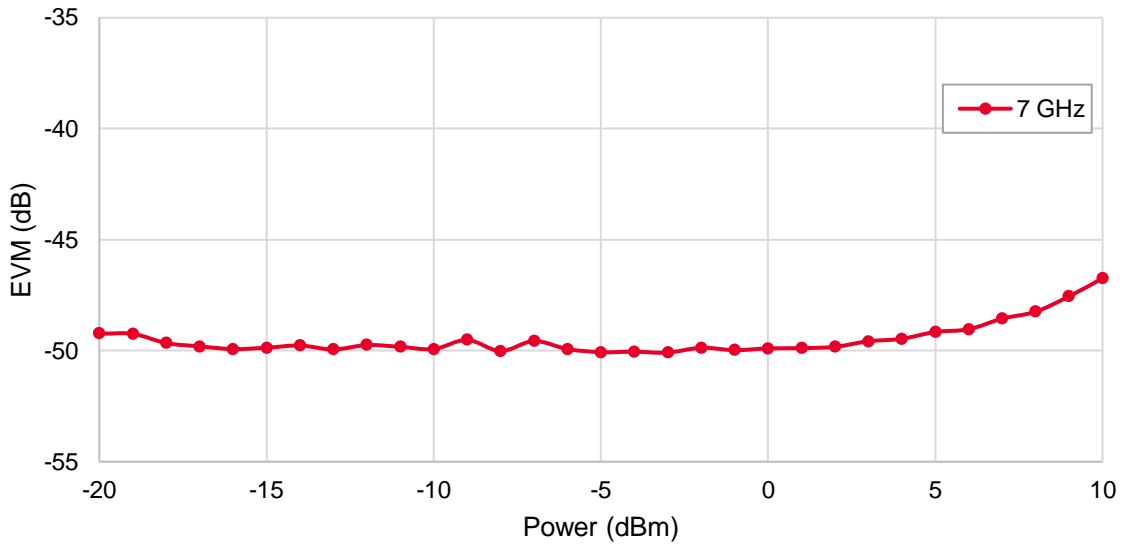

Distortion Performance (Adjacent Channel Power Ratio)

3GPP LTE-FDD distortion performance, -10 dBm to +5 dBm²⁹, () = typ

10 MHz E-TM 1.1 QPSK			
Frequency	Offset ³⁰	Options 506, 508	Options 514, 520, 532, 544, 554
1800 to 2200 MHz	Adjacent (10 MHz)	-64 dBc (-68 dBc)	-63 dBc (-67 dBc)
	Alternate (20 MHz)	-65 dBc (-68 dBc)	-63 dBc (-67 dBc)

5G NR FR1 bands distortion performance, -10 dBm to +5 dBm, options 506, 508, 514, 520

Frequency	100 MHz, 256QAM, 120 kHz SCS, NRB = 135
3.4 GHz	-56 dBc (meas)

5G NR FR2 bands and IFs distortion performance, -10 dBm to +5 dBm, options 514, 520

Frequency	100 MHz, 256QAM, 120 kHz SCS, NRB = 66	400 MHz, 256QAM, 120 kHz SCS, NRB = 264	8cc x 100 MHz (800 MHz), 256QAM, 120 kHz SCS, NRB = 66	14cc x 100 MHz (1.4 GHz), 256QAM, 60 kHz SCS, NRB = 66
9 GHz to 14 GHz	-53 dBc (meas)	-48 dBc (meas)	-47 dBc (meas)	-43 dBc (meas)

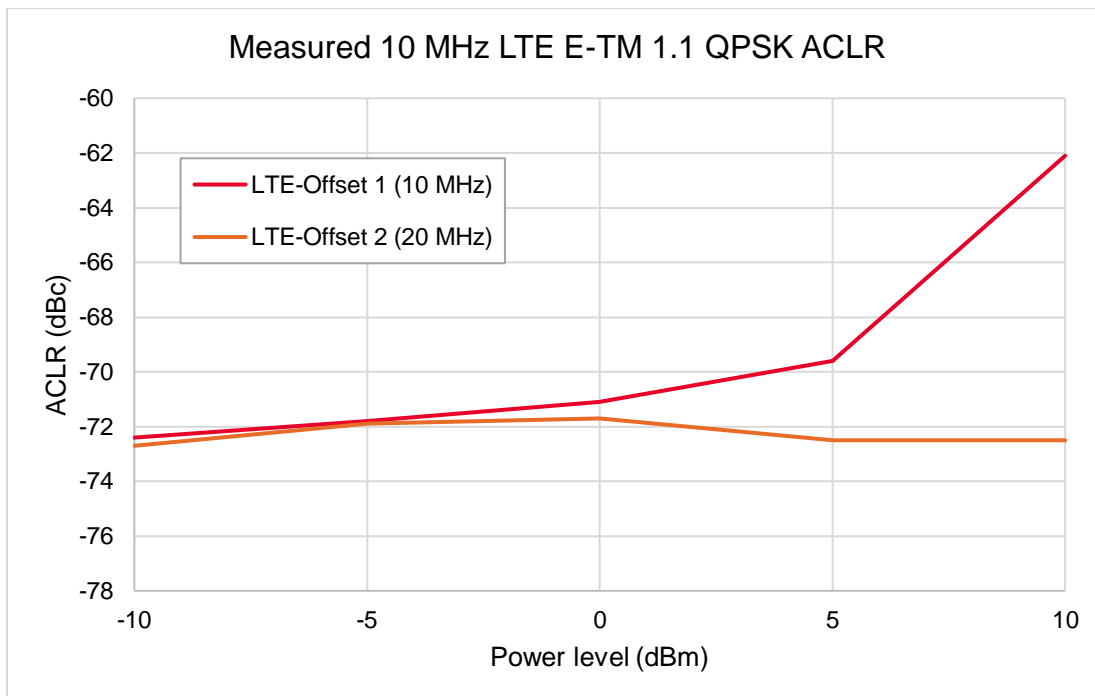

²⁹ This is rms power. Convert from rms to peak envelope power with the following equation: PEP = rms power + crest factor (for example, 3GPP test model 1 with 64 DPCH has a crest factor 11.5 dB, therefore at +5 dBm rms, the PEP = 5 dBm + 11.5 dB = +16.5 dBm PEP).

³⁰ ACPR measurement configuration: reference channel integration BW: 9.015 MHz, offset channel integration bandwidth: 9.015 MHz.

Remote Programming

Remote programming

Interfaces	GPIB (IEEE-488.2,1987) with listen and talk, and 1000BaseT LAN interface
Control languages	SCPI version 1999.0
IEEE-488 functions	SH1, AH1, T6, TE0, L4, LE0, SR1, RL1, PP0, DC1, DT0, C0, E2
Keysight IO libraries	Keysight's IO Library Suite helps you quickly establish an error-free connection between your PC and instruments – regardless of the vendor. It provides robust instrument control and works with the software development environment you choose.

General Specifications

Environmental specifications and regulatory compliance (nom)

Temperature	Operating	0 to 50 °C
	Storage	-40 to +70 °C
Type tested maximum relative humidity		95% RH up to 40°C, decreases linearly to 57% RH at 50°C ³¹
Altitude	Operating	3,000 m (Up to 10,000 feet approx.)
	Storage	4,572 m (Up to 15,000 feet)
EMC		<p>Complies with European EMC Directive</p> <ul style="list-style-type: none"> – IEC/EN 61326-1 – CISPR Pub 11 Group 1, class A – AS/NZS CISPR 11 – ICES/NMB-001 <p>This ISM device complies with Canadian ICES-001. Cet appareil ISM est conforme a la norme NMB-001 du Canada.</p>
Environmental testing		Samples of this product have been type tested in accordance with the Keysight Environmental Test Manual and verified to be robust against the environmental stresses of storage, transportation and end-use. Those stresses include but are not limited to temperature, humidity, shock, vibration, altitude and power-line conditions. Test methods are aligned with IEC 60068-2 and levels are similar to MIL-PRF-28800F Class 3.

Power requirements (nom)

Number of channels	Maximum frequency	Power requirements
1 (opt. 001)	6 GHz or 8.5 GHz (opt. 506 or 508)	100/120 VAC, 50/60/400 Hz, 1350 W Max, 220/240 VAC 50/60 Hz, 2000W Max.
	14 GHz or 20 GHz (opt. 514 or 520)	100/120 VAC, 50/60/400 Hz, 1350 W Max, 220/240 VAC 50/60 Hz, 2000W Max.
	31.8 GHz, 44 GHz, or 54 GHz (opt. 532, 544, or 554)	100/120 VAC, 50/60/400 Hz, 1350 W Max, 220/240 VAC 50/60 Hz, 2000W Max.
2 (opt. 001 and 002)	6 GHz or 8.5 GHz (opt. 506 or 508)	100/120 VAC, 50/60/400 Hz, 1350 W Max, 220/240 VAC 50/60 Hz, 2000W Max.
	14 GHz or 20 GHz (opt. 514 or 520)	100/120 VAC, 50/60/400 Hz, 1350 W Max, 220/240 VAC 50/60 Hz, 2000W Max.
	31.8 GHz, 44 GHz, or 54 GHz (opt. 532, 544, or 554)	100/120 VAC, 50/60/400 Hz, 1350 W Max, 220/240 VAC 50/60 Hz, 2000W Max.
4 (opt. 001, 002, 003, and 004)	6 GHz or 8.5 GHz (opt. 506 or 508)	100/120 VAC, 50/60/400 Hz, 1350 W Max, 220/240 VAC 50/60 Hz, 2000W Max.
	14 GHz or 20 GHz (opt. 514 or 520)	200/220/240 VAC, 50/60 Hz, 2000W Max.

³¹ From 40 °C to 50 °C, the maximum % relative humidity follows the line of constant dew point.

M9484C physical specifications (nom)

	Configuration	One channel (001)	Two channels (002)	Four channels (004)
Weight	Options 506, 508	61.4 lbs.	66.0 lbs.	76.2 lbs.
	Options 514, 520	63.0 lbs.	67.6 lbs.	77.8 lbs.
	Options 532, 544, 554	64.5 lbs.	73.2 lbs.	-
Dimensions	Height	194.6 mm		
	Width with strap handles	461.5 mm		
	Width without strap handles	444.3 mm		
	Length including connectors and jumper cables	635.0 mm		

Display (nom)

Resolution	1280 x 768 pixels
Size	10.6 in (26.9 cm) diagonal

Data storage (nom)

Internal	Removable solid-state drive (256 GB)
External	Supports USB 3.0/2.0 compatible memory devices

Related Literature

Publication title	Publication number
M9484C VXG Configuration Guide	3121-1509EN
M9484C VXG Signal Generator Startup Guide	M9484-90001

For more information on Keysight Technologies' products, applications, or services, please visit: www.keysight.com



This information is subject to change without notice. © Keysight Technologies, 2022. Published in USA, December 19, 2022, 3122-1445.EN