

Nokia ONT

XS-2426G-A Product Guide

3FE-49348-AAAA-TCZZA

Issue 1

December 2020

Legal notice

Nokia is committed to diversity and inclusion. We are continuously reviewing our customer documentation and consulting with standards bodies to ensure that terminology is inclusive and aligned with the industry. Our future customer documentation will be updated accordingly.

Nokia is a registered trademark of Nokia Corporation. Other products and company names mentioned herein may be trademarks or tradenames of their respective owners.

The information presented is subject to change without notice. No responsibility is assumed for inaccuracies contained herein.

© 2020 Nokia.

Contains proprietary/trade secret information which is the property of Nokia and must not be made available to, or copied or used by anyone outside Nokia without its written authorization.

Not to be used or disclosed except in accordance with applicable agreements.

Contents

About this document	12
1 What's new	17
1.1 Overview	17
1.2 What's new in BBD Release 20.04, Issue 1	17
2 ETSI ONT safety guidelines	19
2.1 Safety instructions	19
2.2 Safety standards compliance	21
2.3 Electrical safety guidelines	21
2.4 ESD safety guidelines	22
2.5 Laser safety guidelines	22
2.6 Environmental requirements	26
3 ETSI environmental and CRoHS guidelines	27
3.1 Environmental labels	27
3.2 Hazardous Substances Table (HST)	29
3.3 Other environmental requirements	29
4 ANSI ONT safety guidelines	31
4.1 Safety instructions	31
4.2 Safety standards compliance	33
4.3 Laser safety guidelines	35
4.4 Electrical safety guidelines	38
4.5 ESD safety guidelines	39
4.6 Environmental requirements	39
5 XS-2426G-A unit data sheet	41
5.1 Overview	41
5.2 XS-2426G-A part numbers and identification	41
5.3 XS-2426G-A general description	42
5.4 XS-2426G-A software and installation feature support	47
5.5 XS-2426G-A interfaces and interface capacity	48
5.6 XS-2426G-A LEDs	50
5.7 XS-2426G-A detailed specifications	52
5.8 XS-2426G-A GEM ports and T-CONTs	53
5.9 XS-2426G-A performance monitoring statistics	54

5.10	XS-2426G-A functional blocks	55
5.11	XS-2426G-A standards compliance	56
5.12	XS-2426G-A special considerations.....	58
6	Install a XS-2426G-A indoor ONT	61
6.1	Overview	61
6.2	Purpose	61
6.3	General	61
6.4	Prerequisites	61
6.5	Recommended tools	61
6.6	Safety information	62
6.7	Procedure.....	62
7	Replace a XS-2426G-A indoor ONT	67
7.1	Overview	67
7.2	Purpose	67
7.3	General	67
7.4	Prerequisites	67
7.5	Recommended tools	67
7.6	Safety information	68
7.7	Procedure.....	68
8	Configure a XS-2426G-A indoor ONT	73
8.1	Overview	73
	GUI configuration.....	76
8.2	General configuration.....	76
8.3	HGU mode GUI configuration	76
8.4	Log in to web-based GUI	76
	Viewing device information and connection status	78
8.5	Overview	78
8.6	Viewing device information.....	78
8.7	Viewing LAN status	80
8.8	Viewing WAN status.....	81
8.9	Viewing WAN IPv6 status.....	83
8.10	Viewing STA information	85
8.11	Viewing Neighboring Access Points	87
8.12	Viewing home networking information.....	88
8.13	Viewing optics module status.....	90
8.14	Viewing statistics.....	91

8.15	Viewing voice information.....	94
	Network configuration	97
8.16	Overview	97
8.17	Configuring LAN.....	97
8.18	Configuring LAN IPv6.....	99
8.19	Configuring WAN.....	101
8.20	Configuring WAN DHCP	103
8.21	Configuring Wireless 2.4GHz.....	104
8.22	Configuring Wireless 5GHz.....	107
8.23	Configuring wireless scheduling.....	110
8.24	Configuring IP routing.....	111
8.25	Configuring DNS	113
8.26	Configuring TR-069	114
8.27	Configuring GRE tunnel	115
8.28	Configuring Upstream (US) Classifier	117
8.29	Configuring QoS.....	121
	Security configuration	125
8.30	Overview	125
8.31	Configuring the firewall.....	125
8.32	Configuring the MAC filter	126
8.33	Configuring the IP filter.....	128
8.34	Configuring the URL filter	129
8.35	Configuring parental control	131
8.36	Configuring DMZ and ALG	133
8.37	Configuring access control.....	135
	Configuring the Application	137
8.38	Overview	137
8.39	Configuring port forwarding.....	137
8.40	Configuring port triggering.....	139
8.41	Configuring DDNS.....	140
8.42	Configuring NTP.....	142
8.43	Configuring USB	143
8.44	Configuring UPnP and DLNA.....	144
8.45	Configuring voice	145
	Maintenance	148
8.46	Overview	148
8.47	Configuring the password	148

8.48	Configuring LOID	150
8.49	Configuring SLID	150
8.50	Managing the device	152
8.51	Backing up the configuration	153
8.52	Restoring the configuration	153
8.53	Upgrading firmware	154
8.54	Rebooting the device	155
8.55	Resetting to factory defaults	156
8.56	Diagnosing WAN connections	157
8.57	Viewing log files	159
	RG Troubleshooting Counters	161
8.58	Overview	161
8.59	Viewing Residential Gateway (RG) troubleshooting counters	161
9	ONT configuration file over OMCI	165
9.1	Overview	165
9.2	Purpose	165
9.3	Supported configuration file types	165
9.4	ONT configuration file over OMCI	167

List of tables

Table 2-1	Safety labels.....	20
Table 4-1	Safety labels.....	32
Table 5-1	Identification of XS-2426G-A indoor ONTs.....	41
Table 5-2	XS-2426G-A power supply ordering information.....	42
Table 5-3	XS-2426G-A indoor ONT interface connection capacity.....	48
Table 5-4	XS-2426G-A indoor ONT physical connections.....	49
Table 5-5	XS-2426G-A indoor ONT LED descriptions.....	51
Table 5-6	XS-2426G-A indoor ONT physical specifications.....	52
Table 5-7	XS-2426G-A dimension data specifications.....	52
Table 5-8	XS-2426G-A indoor ONT power consumption specifications.....	53
Table 5-9	XS-2426G-A indoor ONT environmental specifications.....	53
Table 5-10	XS-2426G-A indoor ONT capacity for GEM ports and T-CONTs.....	53
Table 5-11	Package S ONTs ONTENET performance monitoring statistics.....	54
Table 5-12	Package S ONTs ONTL2UNI performance monitoring statistics.....	54
Table 5-13	Package S ONTs PONONTTC, PONONTMCTC, PONONTTCHSI, PONONTTCCES, PONONTTCFLOW, PONONTTCVOIP performance monitoring statistics.....	55
Table 5-14	Package S ONTs PONONTTC aggregate performance monitoring statistics.....	55
Table 5-15	XS-2426G-A ONT considerations and limitations.....	59
Table 8-1	Device Information parameters.....	79
Table 8-2	LAN Status parameters.....	81
Table 8-3	WAN Status parameters.....	82
Table 8-4	WAN Status IPv6 parameters.....	84
Table 8-5	STA information parameters.....	86
Table 8-6	Neighboring AP parameters.....	87
Table 8-7	Home Networking parameters.....	89
Table 8-8	Optics Module Status parameters.....	91
Table 8-9	Voice Information parameters.....	95
Table 8-10	LAN parameters.....	99
Table 8-11	LAN IPv6 parameters.....	100
Table 8-12	WAN parameters.....	102
Table 8-13	WAN DHCP parameters.....	104
Table 8-14	Wireless (2.4GHz) parameters.....	106

Table 8-15	Wireless (5GHz) parameters.....	108
Table 8-16	IP Routing parameters	112
Table 8-17	DNS parameters.....	113
Table 8-18	TR-069 parameters	115
Table 8-19	GRE Tunnel parameters.....	116
Table 8-20	US Classifier Policy parameters.....	118
Table 8-21	US Classifier parameters	119
Table 8-22	US Classifier Rules parameters	121
Table 8-23	QoS Config parameters	124
Table 8-24	Firewall parameters.....	126
Table 8-25	MAC Filter parameters	127
Table 8-26	IP Filter parameters.....	129
Table 8-27	URL Filter parameters.....	130
Table 8-28	Parental control parameters.....	132
Table 8-29	ALG parameters.....	134
Table 8-30	DMZ parameters	134
Table 8-31	Access Control parameters.....	136
Table 8-32	Trusted Network parameters.....	136
Table 8-33	Port Forwarding parameters	138
Table 8-34	Port Triggering parameters	139
Table 8-35	DDNS parameters.....	141
Table 8-36	NTP parameters.....	142
Table 8-37	USB parameters.....	144
Table 8-38	Voice Setting parameters	146
Table 8-39	Password parameters	149
Table 8-40	LOID Configuration parameters	150
Table 8-41	SLID Configuration parameters.....	151
Table 8-42	Device Management parameters	152
Table 8-43	RG Troubleshooting Counters parameters	162
Table 9-1	Supported configuration files.....	166
Table 9-2	Download configuration files	167

List of figures

Figure 2-1	PSE certification	20
Figure 2-2	Laser product label	23
Figure 2-3	Laser classification label.....	24
Figure 2-4	Laser warning labels.....	25
Figure 3-1	Products below MCV value label.....	28
Figure 3-2	Products above MCV value label	28
Figure 3-3	Recycling/take back/disposal of product symbol	30
Figure 4-1	Sample safety label on the ONT equipment.....	33
Figure 4-2	Sample laser product label showing CDRH 21 CFR compliance.....	35
Figure 4-3	Laser product label	36
Figure 4-4	Laser classification label.....	36
Figure 4-5	Laser warning labels.....	37
Figure 4-6	Sample laser product safety label on the ONT equipment	38
Figure 5-1	XS-2426G-A ONT	43
Figure 5-2	XS-2426G-A indoor ONT physical connections (back).....	48
Figure 5-3	XS-2426G-A indoor ONT with fiber optic connector	49
Figure 5-4	XS-2426G-A indoor ONT LEDs	50
Figure 5-5	XS-2426G-A ONT functional block	56
Figure 6-1	XS-2426G-A ONT connections.....	63
Figure 7-1	XS-2426G-A indoor ONT connections.....	69
Figure 8-1	Web login page.....	77
Figure 8-2	Device Information page.....	79
Figure 8-3	LAN Status page	80
Figure 8-4	WAN Status page	82
Figure 8-5	WAN Status IPv6 page	84
Figure 8-6	STA Information page	86
Figure 8-7	Neighboring AP page.....	87
Figure 8-8	Home Networking page	89
Figure 8-9	Optics Module Status page	90
Figure 8-10	LAN Statistics page	92
Figure 8-11	WAN Statistics page	93

Figure 8-12	WLAN Statistics page	94
Figure 8-13	Voice Information page	95
Figure 8-14	LAN page	98
Figure 8-15	LAN IPv6 page	100
Figure 8-16	WAN page	102
Figure 8-17	WAN DHCP page	103
Figure 8-18	Wireless (2.4GHz) page	105
Figure 8-19	Wireless (5GHz) page	108
Figure 8-20	Wireless Schedule page	110
Figure 8-21	IP Routing page	112
Figure 8-22	DNS page	113
Figure 8-23	TR-069 page	114
Figure 8-24	GRE Tunnel page	116
Figure 8-25	US Classifier Policy page	117
Figure 8-26	US Classifier page	119
Figure 8-27	US Classifier Rules page	120
Figure 8-28	QoS Config page (L2 packet sizes)	122
Figure 8-29	QoS Config page (L3 packet sizes)	123
Figure 8-30	Firewall page	126
Figure 8-31	MAC Filter page	127
Figure 8-32	IP Filter page	128
Figure 8-33	URL Filter page	130
Figure 8-34	Parental Control page	131
Figure 8-35	Create new group page	132
Figure 8-36	DMZ and ALG page	134
Figure 8-37	Access Control page	135
Figure 8-38	Port Forwarding page	138
Figure 8-39	Port Triggering page	139
Figure 8-40	DDNS page	141
Figure 8-41	NTP page	142
Figure 8-42	USB page	143
Figure 8-43	UPnP and DLNA page	145
Figure 8-44	Voice Setting page	146

Figure 8-45	Password page	149
Figure 8-46	LOID Config page	150
Figure 8-47	SLID Configuration page	151
Figure 8-48	Device Management page	152
Figure 8-49	Backup and Restore page	153
Figure 8-50	Backup and Restore page	154
Figure 8-51	Firmware Upgrade page	155
Figure 8-52	Reboot Device page	156
Figure 8-53	Factory Default page	157
Figure 8-54	Diagnostics page	158
Figure 8-55	Log page	159
Figure 8-56	RG Troubleshooting Counters page	162

About this document

Purpose

This documentation set provides information about safety, features and functionality, ordering, hardware installation and maintenance, and software installation procedures of this ONT for the current release.

Intended audience

This documentation set is intended for planners, administrators, operators, and maintenance personnel involved in installing, upgrading, or maintaining the ONTs.

The reader must be familiar with general telecommunications principles.

Safety information

For your safety, this document contains safety statements. Safety statements are given at points where risks of damage to personnel, equipment, and operation may exist. Failure to follow the directions in a safety statement may result in serious consequences.

Safety Information Examples



DANGER

Hazard

Danger indicates that the described activity or situation may result in serious personal injury or death; for example, high voltage or electric shock hazards.



WARNING

Equipment Damage

Warning indicates that the described activity or situation may, or will, cause equipment damage or serious performance problems.



CAUTION

Service Disruption

Caution indicates that the described activity or situation may, or will, cause service interruption.

Note: A note provides information that is, or may be, of special interest.

Acronyms and initialisms

The expansions and optional descriptions of most acronyms and initialisms appear in the glossary

Nokia quality processes

Nokia's ONT manufacturing, testing, and inspecting practices are in compliance with TL 9000 requirements. These requirements are documented in the Fixed Networks Quality Manual 3FQ-30146-6000-QRZZA.

The quality practices adequately ensure that technical requirements and customer end-point requirements are met. The customer or its representatives may be allowed to perform on-site quality surveillance audits, as agreed upon during contract negotiations.

Documents

Documents are available using ALED or OLCS.

To download a ZIP file package of the customer documentation

- 1 _____
Navigate to <http://customer.nokia.com/s/> and enter your user name and password. If you are a new user and require access to this service, please contact your Nokia sales representative.
- 2 _____
Select **Products**.
- 3 _____
Type your product name in the **Find and select a product** field and click the search icon.
Select a product.
- 4 _____
Click **Downloads: ALED** to go to the Electronic Delivery: Downloads page.
- 5 _____
Select **Documentation** from the list.
- 6 _____
Select a release from the list.
- 7 _____
Follow the on-screen directions to download the file.

END OF STEPS _____

To access individual documents

Individual PDFs of customer documents are also accessible through the Nokia Support Portal website.

-
- 1 _____
Navigate to <http://customer.nokia.com/s/> and enter your user name and password. If you are a new user and require access to this service, please contact your Nokia sales representative.
 - 2 _____
Select **Products**.
 - 3 _____
Type your product name in the **Find and select a product** field and click the search icon.
Select a product.
 - 4 _____
Click **Documentation: Doc Center** to go to the product page in the Doc Center.
 - 5 _____
Select a release from the **Release** list and click **SEARCH**.
 - 6 _____
Click on the PDF icon to open or save the file.

END OF STEPS _____

Procedures with options or substeps

When there are options in a procedure, they are identified by letters. When there are required substeps in a procedure, they are identified by roman numerals.

Example of options in a procedure

At [Step 1](#), you can choose option a or b. At [Step 2](#), you must do what the step indicates.

- 1 _____
This step offers two options. You must choose one of the following:
 - a. This is one option.
 - b. This is another option.
- 2 _____
You must perform this step.

END OF STEPS _____

Example of required substeps in a procedure

At [Step 1](#), you must perform a series of substeps within a step. At [Step 2](#), you must do what the step indicates.

1

This step has a series of substeps that you must perform to complete the step. You must perform the following substeps:

- a. This is the first substep.
- b. This is the second substep.
- c. This is the third substep.

2

You must perform this step.

END OF STEPS

Multiple PDF document search

You can use Adobe Reader Release 6.0 and later to search multiple PDF files for a common term. Adobe Reader displays the results in a single display panel. The results are grouped by PDF file, and you can expand the entry for each file.

Note:The PDF files in which you search must be in the same folder.

To search multiple PDF files for a common term

1

Open Adobe Acrobat Reader.

2

Choose **Edit**→**Search** from the Acrobat Reader main menu. The Search PDF panel displays.

3

Enter the search criteria.

4

Select **All PDF Documents In**.

5

Select the folder in which to search using the drop-down menu.

6

Click **Search**.

Acrobat Reader displays the search results. You can expand the entries for each document by clicking on the + symbol.

END OF STEPS

Technical support

For details, refer to the [Nokia Support portal \(https://customer.nokia.com/support/s/\)](https://customer.nokia.com/support/s/).

For ordering information, contact your Nokia sales representative.

How to comment

Note to reviewers: The following "How to comment" text will appear in the final document when it is published. However, the feedback method described below is for use only on final documents. Please send your review comments to the author using the process you were given when you received this draft document.

To comment on this document, go to the [Online Comment Form \(https://documentation.nokia.com/comments/\)](https://documentation.nokia.com/comments/) or e-mail your comments to the [Comments Hotline \(mailto:comments@nokia.com\)](mailto:comments@nokia.com).

1 What's new

1.1 Overview

1.1.1 Purpose

1.1.2 Contents

1.1 Overview	17
1.2 What's new in BBD Release 20.04, Issue 1	17

1.2 What's new in BBD Release 20.04, Issue 1

The Product guide is a new guide in BBD Release 20.04. In future releases, this chapter will provide tables of the feature and document changes applicable to this guide.

2 ETSI ONT safety guidelines

This chapter provides information about the mandatory regulations that govern the installation and operation of the optical network terminals (ONTs).

2.1 Safety instructions

This section describes the safety instructions that are provided in the ONT customer documentation and on the equipment.

2.1.1 Safety instruction boxes

The safety instruction boxes are provided in the ONT customer documentation. Observe the instructions to meet safety requirements.

The following is an example of the Danger box.



DANGER

Hazard

Possibility of personal injury.

The Danger box indicates that the described activity or situation may pose a threat to personal safety. It calls attention to a situation or procedure which, if not correctly performed or adhered to, may result in death or serious physical harm.

Do not proceed beyond a Danger box until the indicated conditions are fully understood and met.

The following is an example of the Warning box.



WARNING

Equipment Damage

Possibility of equipment damage.

Possibility of data loss.

The Warning box indicates that the described activity or situation may, or will, cause equipment damage, loss of data, or serious performance problems. It identifies a possible equipment-damaging situation or provides essential information to avoid the degradation of system operations or data.

Do not proceed beyond a warning until the indicated conditions are fully understood and met.

The following is an example of the Caution box.

**CAUTION****Service Disruption**

Possibility of service interruption.

Service interruption.

The Caution box indicates that the described activity or situation may, or will, cause service interruption.

Do not proceed beyond a caution until the indicated conditions are fully understood and met.

The following is an example of the Note box.



Note: Information of special interest.

The Note box provides information that assists the personnel working with ONTs. It does not provide safety-related instructions.

2.1.2 Safety-related labels

The ONT equipment is labeled with the specific safety instructions and compliance information that is related to a variant of the ONT. Observe the instructions on the safety labels.

Table 2-1, “Safety labels” (p. 19) provides sample safety labels on the ONT equipment.

Table 2-1 Safety labels

Description	Label text
ESD warning	Caution: This assembly contains an electrostatic sensitive device.
Laser classification	Class 1 laser product
PSE marking	These power supplies are Japan PSE certified and compliant with Japan VCCI emissions standards.

Figure 2-1, “PSE certification” (p. 20) shows the PSE certification.

Figure 2-1 PSE certification

 Warning	This is a Class B product based on the standard of the Voluntary Control Council for Interference from Information Technology Equipment (VCCI). If this is used near a radio or television receiver in a domestic environment, it may cause radio interference. Install and use the equipment according to the instruction manual.
 警告	VCCI準拠クラスB機器（日本） この機器は、Information Technology EquipmentのVoluntary Control Council for Interference (VCCI)の規格に準拠したクラスB製品です。この機器をラジオやテレビ受信機の近くで使用した場合、混信が発生する恐れがあります。本機器の設置および使用に際しては、取扱説明書に従ってください。

19841

2.2 Safety standards compliance

This section describes the ONT compliance with the European safety standards.

2.2.1 EMC, EMI, and ESD compliance

The ONT equipment complies with the following EMC, EMI, and ESD requirements:

- EN 300-328 v1.9.1 wide band data transmission standards for 2.4GHz bands
- EN 300-386 V1.5.1: Electromagnetic Compatibility and Radio Spectrum Matters (ERM): Telecommunications Network Equipment; Electromagnetic Compatibility (EMC) requirements; Electrostatic Discharge (ESD) requirements
- EN 55022 (2006): Class B, Information Technology Equipment, Radio Disturbance Characteristics, limits and methods of measurement
- EN 55024 (2010): Information Technology Equipment, Immunity Characteristics, limits and methods of measurement
- European Council Directive 2004/108/EC
- EN 300-386 V1.4.1: 2008
- EN 55022:2006 Class B (ONTs)

2.2.2 Equipment safety standard compliance

The ONT equipment complies with the requirements of **EN 62368-1**, Safety of Information Technology Equipment for use in a restricted location (per R-269).

2.2.3 Environmental standard compliance

The ONT equipment complies with the EN 300 019 European environmental standards.

2.2.4 Laser product standard compliance

For most ONTs, the ONT equipment complies with EN 60825-1 and IEC 60825-2 for laser products. If there is an exception to this compliance regulation, you can find this information in the standards compliance section of the unit data sheet in this Product Guide.

2.2.5 Resistibility requirements compliance

The ONT equipment complies with the requirements of ITU Recommendation K.21 for resistibility of telecommunication equipment installed in customer premises to over voltage and over currents.

2.2.6 Acoustic noise emission standard compliance

The ONT equipment complies with EN 300 753 acoustic noise emission limit and test methods.

2.3 Electrical safety guidelines

This section provides the electrical safety guidelines for the ONT equipment.

i **Note:** The ONTs comply with the U.S. National Electrical Code. However, local electrical authorities have jurisdiction when there are differences between the local and U.S. standards.

The ONTs comply with BS EN 61140.

2.3.1 Power supplies

The use of any non-Nokia approved power supplies or power adapters is not supported or endorsed by Nokia. Such use will void any warranty or support contract with Nokia. Such use greatly increases the danger of damage to equipment or property.

2.3.2 Cabling

The following are the guidelines regarding cables used for the ONT equipment:

- All cables must be approved by the relevant national electrical code.
- The cables for outdoor installation of ONTs must be suitable for outdoor use.
- POTS wiring run outside the subscriber premises must comply with the requirements of local electrical codes. In some markets, the maximum allowed length of the outside run is 140 feet (43 m). If the outside run is longer, NEC requires primary protection at both the exit and entry points for the wire.

2.3.3 Protective earth

Earthing and bonding of the ONTs must comply with the requirements of local electrical codes.

2.4 ESD safety guidelines

The ONT equipment is sensitive to ESD. Operations personnel must observe the following ESD instructions when they handle the ONT equipment.



CAUTION

Service Disruption

This equipment is ESD sensitive. Proper ESD protections should be used when you enter the TELCO Access portion of the ONT.

During installation and maintenance, service personnel must wear wrist straps to prevent damage caused by ESD.

2.5 Laser safety guidelines

Observe the following instructions when you perform installation, operations, and maintenance tasks on the ONT equipment.

Only qualified service personnel who are extremely familiar with laser radiation hazards should install or remove the fiber optic cables and units in this system.



DANGER

Hazard

There may be invisible laser radiation at the fiber optic cable when the cable is removed from the connector. Avoid direct exposure to the laser beam.

Observe the following danger for laser hazard. Eyes can be damaged when they are exposed to a laser beam. Take necessary precautions before you plug in the optical modules.



DANGER

Hazard

Possibility of equipment damage. Risk of eye damage by laser radiation.

2.5.1 Laser classification

The ONT is classified as a Class 1 laser product based on its transmit optical output.

Laser warning labels

The following figures show the labels related to laser product, classification and warning.

[Figure 2-2, "Laser product label" \(p. 22\)](#) shows a laser product label.

Figure 2-2 Laser product label

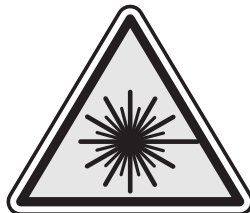

18455

[Figure 2-3, "Laser classification label" \(p. 24\)](#) shows a laser classification label. Laser classification labels may be provided in other languages.

Figure 2-3 Laser classification label

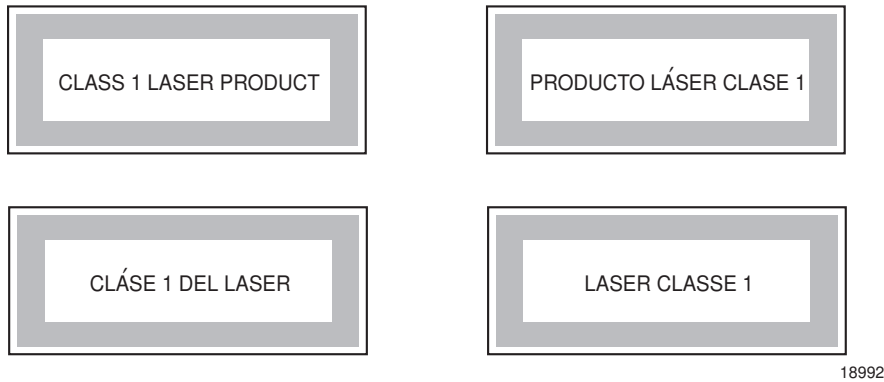
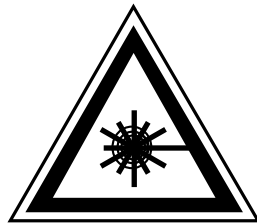

Figure 2-4, “Laser warning labels” (p. 25) shows a laser warning label and an explanatory label for laser products. Labels and warning may be provided in other languages. The explanatory label provides the following information:

- a warning that calls attention to the invisible laser radiation
- an instruction against staring into the beam or viewing directly with optical instruments
- wavelength
- normal output power
- maximum output power

Figure 2-4 Laser warning labels



Laser Warning Label

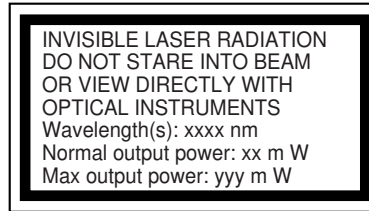

Laser Warning Label

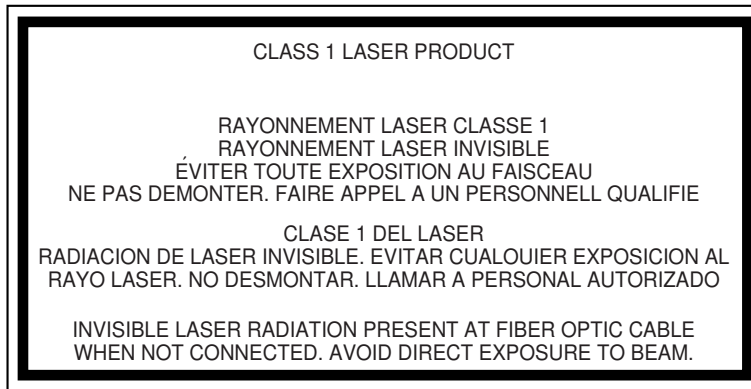

Laser Warning Label

18993

2.5.2 Transmit optical output

The maximum transmit optical output of an ONT is +5 dBm.

2.5.3 Normal laser operation

In normal operation, fiber cable laser radiation is always off until it receives signal from the line terminal card.

Eyes can be damaged when they exposed to a laser beam. Operating personnel must observe the instructions on the laser explanatory label before plugging in the optical module.



DANGER

Hazard

Risk of eye damage by laser radiation.

2.5.4 Location class

Use cable supports and guides to protect the receptacles from strain.

2.6 Environmental requirements

See the ONT technical specification documentation for more information about temperature ranges.

During operation in the supported temperature range, condensation inside the ONT caused by humidity is not an issue. To avoid condensation caused by rapid changes in temperature and humidity, Nokia recommends:

- The door of the ONT not be opened until temperature inside and outside the enclosure has stabilized.
- If the door of the ONT must be opened after a rapid change in temperature or humidity, use a dry cloth to wipe down the metal interior to prevent the risk of condensation.
- When high humidity is present, installation of a cover or tent over the ONT helps prevent condensation when the door is opened.

3 ETSI environmental and CRoHS guidelines

This chapter provides information about the ETSI environmental China Restriction of Hazardous Substances (CRoHS) regulations that govern the installation and operation of the optical line termination (OLT) and optical network termination (ONT) systems. This chapter also includes environmental operation parameters of general interest.

3.1 Environmental labels

This section describes the environmental instructions that are provided with the customer documentation, equipment, and location where the equipment resides.

3.1.1 Overview

CRoHS is applicable to Electronic Information Products (EIP) manufactured or sold and imported in the territory of the mainland of the People's Republic of China. EIP refers to products and their accessories manufactured by using electronic information technology, including electronic communications products and such subcomponents as batteries and cables.

3.1.2 Environmental related labels

Environmental labels are located on appropriate equipment. The following are sample labels.

Products below Maximum Concentration Value (MCV) label

[Figure 3-1, "Products below MCV value label" \(p. 28\)](#) shows the label that indicates a product is below the maximum concentration value, as defined by standard SJ/T11363-2006 (Requirements for Concentration Limits for Certain Hazardous Substances in Electronic Information Products). Products with this label are recyclable. The label may be found in this documentation or on the product.

Figure 3-1 Products below MCV value label



18986

Products containing hazardous substances above Maximum Concentration Value (MCV) label

Figure 3-2, “Products above MCV value label” (p. 28) shows the label that indicates a product is above the maximum concentration value, as defined by standard SJ/T11363-2006 (Requirements for Concentration Limits for Certain Hazardous Substances in Electronic Information Products). The number contained inside the label indicates the Environment-Friendly User Period (EFUP) value. The label may be found in this documentation or on the product.

Figure 3-2 Products above MCV value label



Together with major international telecommunications equipment companies, Nokia has determined it is appropriate to use an EFUP of 50 years for network infrastructure equipment and an EFUP of 20 years for handsets and accessories. These values are based on manufacturers' extensive practical experience of the design, manufacturing, maintenance, usage conditions, operating

environments, and physical condition of infrastructure and handsets after years of service. The values reflect minimum values and refer to products operated according to the intended use conditions. See 3.2 “Hazardous Substances Table (HST)” (p. 28) for more information.

3.2 Hazardous Substances Table (HST)

This section describes the compliance of the OLT and ONT equipment to the CRoHS standard when the product and sub assemblies contain hazardous substances beyond the MCV value. This information is found in this user documentation where part numbers for the product and sub assemblies are listed. It may be referenced in other OLT and ONT documentation.

In accordance with the People’s Republic of China Electronic Industry Standard Marking for the Control of Pollution Caused by Electronic Information Products (SJ/T11364-2006), customers may access the Nokia Hazardous Substance Table, in Chinese, from the following location:

- <http://www.alcatel-sbell.com.cn/wwwroot/images/upload/private/1/media/ChinaRoHS.pdf>
(<http://www.alcatel-sbell.com.cn/wwwroot/images/upload/private/1/media/ChinaRoHS.pdf>)

3.3 Other environmental requirements

Observe the following environmental requirements when handling the P-OLT or ONT equipment.

3.3.1 ONT environmental requirements

See the ONT technical specification documentation for more information about temperature ranges.

3.3.2 Storage

According to ETS 300-019-1-1 - Class 1.1, storage of ONT equipment must be in Class 1.1, weather-protected, temperature-controlled locations.

3.3.3 Transportation

According to EN 300-019-1-2 - Class 2.3, transportation of the ONT equipment must be in packed, public transportation with no rain on packing allowed.

3.3.4 Stationary use

According to EN 300-019-1-3 - Class 3.1/3.2/3.E, stationary use of ONT equipment must be in a temperature-controlled location, with no rain allowed, and with no condensation allowed.

3.3.5 Material content compliance

European Union (EU) Directive 2002/95/EC, “Restriction of the use of certain Hazardous Substances” (RoHS), restricts the use of lead, mercury, cadmium, hexavalent chromium, and certain flame retardants in electrical and electronic equipment. This Directive applies to electrical and electronic products placed on the EU market after 1 July 2006, with various exemptions, including an exemption for lead solder in network infrastructure equipment. Nokia products shipped to the EU after 1 July 2006 comply with the EU RoHS Directive.

Nokia has implemented a material/substance content management process. The process is described in: Nokia process for ensuring RoHS Compliance (1AA002660031ASZZA). This ensures

compliance with the European Union Directive 2011/65/EU on the Restriction of the Use of Certain Hazardous Substances in Electrical and Electronic Equipment (RoHS2). With the process equipment is assessed in accordance with the Harmonised Standard EN50581:2012 (CENELEC) on Technical documentation for the assessment of electrical and electronic products with respect to the restriction of hazardous substances.

3.3.6 End-of-life collection and treatment

Electronic products bearing or referencing the symbol shown in [Figure 3-3, “Recycling/take back/disposal of product symbol”](#) (p. 29), when put on the market within the European Union (EU), shall be collected and treated at the end of their useful life, in compliance with applicable EU and local legislation. They shall not be disposed of as part of unsorted municipal waste. Due to materials that may be contained in the product, such as heavy metals or batteries, the environment and human health may be negatively impacted as a result of inappropriate disposal.

i **Note:** In the European Union, a solid bar under the symbol for a crossed-out wheeled bin indicates that the product was put on the market after 13 August 2005.

Figure 3-3 Recycling/take back/disposal of product symbol



At the end of their life, the OLT and ONT products are subject to the applicable local legislations that implement the European Directive 2012/19EU on waste electrical and electronic equipment (WEEE).

There can be different requirements for collection and treatment in different member states of the European Union.

In compliance with legal requirements and contractual agreements, where applicable, Nokia will offer to provide for the collection and treatment of Nokia products bearing the logo shown in [Figure 3-3, “Recycling/take back/disposal of product symbol”](#) (p. 30) at the end of their useful life, or products displaced by Nokia equipment offers. For information regarding take-back of equipment by Nokia, or for more information regarding the requirements for recycling/disposal of product, contact your Nokia account manager or Nokia take back support at sustainability.global@nokia.com.

4 ANSI ONT safety guidelines

This chapter provides information about the mandatory regulations that govern the installation and operation of the optical network terminals or units (ONTs or ONUs) in the North American or ANSI market.

4.1 Safety instructions

This section describes the safety instructions that are provided in the ONT customer documentation and on the equipment.

4.1.1 Safety instruction boxes in customer documentation

The safety instruction boxes are provided in the ONT customer documentation. Observe the instructions to meet safety requirements.

The following is an example of the Danger box.



Hazard

Possibility of personal injury.

The Danger box indicates that the described activity or situation may pose a threat to personal safety. It calls attention to a situation or procedure which, if not correctly performed or adhered to, may result in death or serious physical harm.

Do not proceed beyond a Danger box until the indicated conditions are fully understood and met.

The following is an example of the Warning box.

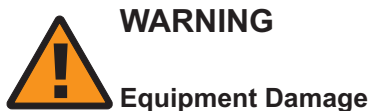

Equipment Damage

Possibility of equipment damage.

Possibility of data loss.

The Warning box indicates that the described activity or situation may, or will, cause equipment damage, loss of data, or serious performance problems. It identifies a possible equipment-damaging situation or provides essential information to avoid the degradation of system operations or data.

Do not proceed beyond a warning until the indicated conditions are fully understood and met.

The following is an example of the Caution box.

**CAUTION****Service Disruption**

Possibility of service interruption.

Service interruption.

The Caution box indicates that the described activity or situation may, or will, cause service interruption.

Do not proceed beyond a caution until the indicated conditions are fully understood and met.

The following is an example of the Note box.



Note: Information of special interest.

The Note box provides information that assists the personnel working with ONTs. It does not provide safety-related instructions.

4.1.2 Safety-related labels

The ONT equipment is labeled with specific safety compliance information and instructions that are related to a variant of the ONT. Observe the instructions on the safety labels.

[Table 4-1, "Safety labels" \(p. 31\)](#) provides examples of the text in the various ONT safety labels.

Table 4-1 Safety labels

Description	Label text
UL compliance	Communication service equipment US listed. Type 3R enclosure - Rainproof.
TUV compliance	Type 3R enclosure - Rainproof.
ESD warning	Caution: This assembly contains electrostatic sensitive device.
Laser classification	Class 1 laser product
Laser product compliance	This laser product conforms to all applicable standards of 21 CFR 1040.10 at date of manufacture.
FCC standards compliance	Tested to comply with FCC standards for home or office use.
CDRH compliance	Complies with 21 CFR 1040.10 and 1040.11 except for deviations pursuant to Laser Notice No. 50, dated June 24, 2007
Operation conditions	This device complies with Part 15 of the FCC Rules. Operation is subject to the following two conditions: (1) this device may not cause harmful interference, and (2) this device must accept any interference received, including interference that may cause undesired operation.
Canadian standard compliance (modular ONT)	This Class A digital apparatus complies with Canadian ICES-003.
Canadian standard compliance (outdoor ONT)	This Class B digital apparatus complies with Canadian ICES-003.
CE marking	There are various CE symbols for CE compliance.

Figure 4-1, “Sample safety label on the ONT equipment” (p. 32) shows a sample safety label on the ONT equipment.

Figure 4-1 Sample safety label on the ONT equipment

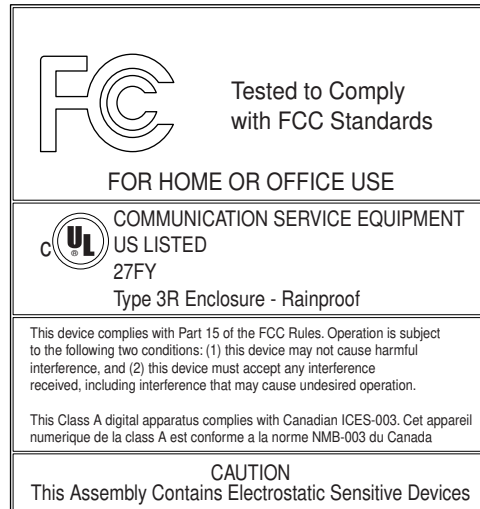

18533

4.2 Safety standards compliance

This section describes the ONT compliance with North American safety standards.



WARNING

Equipment Damage

Changes or modifications to this unit not expressly approved by the party responsible for compliance could void the user's authority to operate the equipment.

4.2.1 EMC, EMI, and ESD standards compliance

The ONT equipment complies with the following requirements:

- Federal Communications Commission (FCC) CFR 47, Part 15, Subpart B, Class A requirements for OLT equipment
- GR-1089-CORE requirements, including:
 - Section 3 Electromagnetic Interference, Emissions Radiated and Conducted
 - Section 3 Immunity, Radiated and Conducted
 - Section 2 ESD Discharge Immunity: System Level Electrostatic Discharge and EFT Immunity: Electrically Fast Transients

This equipment has been tested and found to comply with the limits for a Class B digital device, pursuant to Part 15 of the FCC Rules. These limits are designed to provide reasonable protection against harmful interference in a residential installation. This equipment generates, uses and can radiate radio frequency energy and, if not installed and used in accordance with the instructions, may cause harmful interference to radio communications.

However, there is no guarantee that interference will not occur in a particular installation. If this equipment does cause harmful interference to radio or television reception, which can be determined by turning the equipment off and on, the user is encouraged to try to correct the interference by one or more of the following measures:

- Reorient or relocate the receiving antenna.
- Increase the separation between the equipment and receiver.
- Connect the equipment into an outlet on a circuit different from that to which the receiver is needed.
- Consult the dealer or an experienced radio/TV technician for help.

4.2.2 Equipment safety standard compliance

The ONT equipment complies with the requirements of UL60950-1, Outdoor ONTs to “Communication Service Equipment” (CSE) and Indoor ONTs to Information Technology Equipment (ITE).

4.2.3 Environmental standards compliance

The ONT equipment complies with the following standards:

- GR-63-CORE (NEBS): requirements related to operating, storage, humidity, altitude, earthquake, office vibration, transportation and handling, fire resistance and spread, airborne contaminants, illumination, and acoustic noise
- GR-487-CORE: requirements related to rain, chemical, sand, and dust
- GR-487 R3-82: requirements related to condensation
- GR-3108: Requirements for Network Equipment in the Outside Plant (OSP)
- TP76200: Common Systems Equipment Interconnections Standards

4.2.4 Laser product standards compliance

The ONT equipment complies with 21 CFR 1040.10 and CFR 1040.11, except for deviations pursuant to Laser Notice No. 50, dated June 24, 2007” or to 21 CFR 1040.10 U.S. Center for Devices and Radiological Health (CDRH) of the Food and Drug Administration (FDA) Laser Notice 42 for ONTs containing Class 1 Laser modules certified by original manufactures.

Per CDRH 21 CFR 10.40.10 (h) (1) (iv) distributors of Class 1 laser products, such as Nokia ONTs shall leave the following Laser Safety cautions with the end user.

a) “Class 1 Laser Product”

b) “Caution – Use of controls or adjustments or performance of procedures other than those specified herein may result in hazardous radiation exposure.”

[Figure 4-2, “Sample laser product label showing CDRH 21 CFR compliance” \(p. 35\)](#) shows a laser product label.

Figure 4-2 Sample laser product label showing CDRH 21 CFR compliance

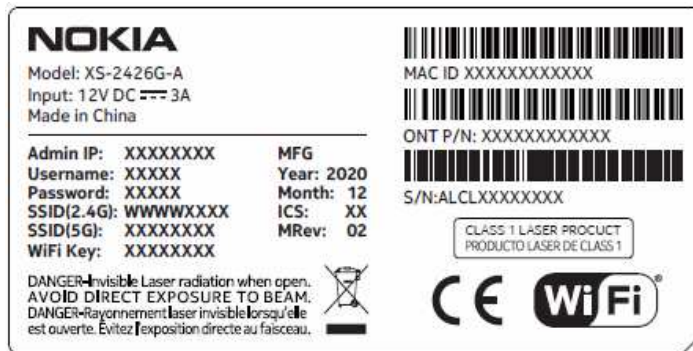

4.2.5 Resistibility requirements compliance

The ONT equipment complies with the requirements of ITU Recommendation K.21 for resistibility of telecommunication equipment installed in customer premises to over voltage and over currents.

4.3 Laser safety guidelines

Only qualified service personnel who are extremely familiar with laser radiation hazards should install or remove the fiber optic cables and units in this system.

Observe the following warnings when you perform installation, operations, and maintenance tasks on the ONT equipment.



There may be invisible laser radiation at the fiber optic cable when the cable is removed from the connector. Avoid direct exposure to beam.

Observe the following danger for a laser hazard. Eyes can be damaged when they are exposed to a laser beam. Take necessary precautions before you plug in the optical modules.



Possibility of equipment damage. Risk of eye damage by laser radiation.

Per CDRH 21 CFR 10.40.10 (h) (1) (iv) distributors of Class 1 laser products, such as Nokia ONTs shall leave the following Laser Safety cautions with the end user.

- a) "Class 1 Laser Product"

b) “Caution – Use of controls or adjustments or performance of procedures other than those specified herein may result in hazardous radiation exposure.”

4.3.1 Laser warning labels

The following figures show sample labels related to laser product, classification and warning.

Figure 4-3, “Laser product label” (p. 35) shows a laser product label.

Figure 4-3 Laser product label



18455

Figure 4-4, “Laser classification label” (p. 36) shows a laser classification label. Laser classification labels may be provided in other languages.

Figure 4-4 Laser classification label

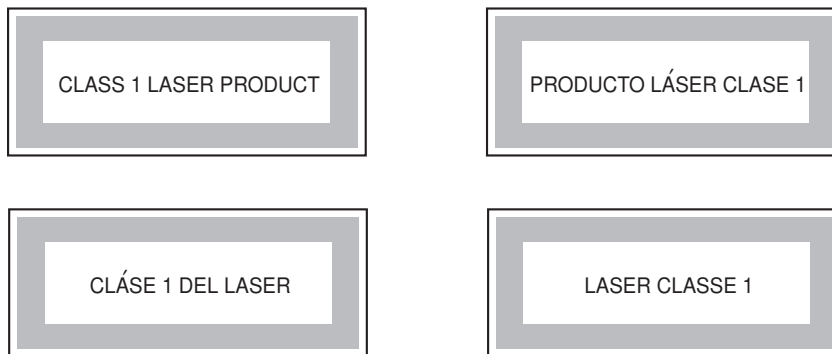

18992

Figure 4-5, “Laser warning labels” (p. 37) shows a laser warning label and an explanatory label for laser products. Explanatory labels may be provided in other languages. The explanatory label provides the following information:

- a warning that calls attention to the invisible laser radiation
- an instruction against staring into the beam or viewing directly with optical instruments
- wavelength
- normal output power
- maximum output power

Figure 4-5 Laser warning labels



18993

4.3.2 Laser classification

The ONT is classified as a Class 1 laser product based on its transmit optical output.

For Class 1 laser products, lasers are safe under reasonably foreseeable conditions of operation, including the use of optical instruments for intrabeam viewing.

Figure 4-6, "Sample laser product safety label on the ONT equipment" (p. 38) shows a sample laser product safety label on the ONT equipment.

Figure 4-6 Sample laser product safety label on the ONT equipment



18532

4.3.3 Transmit optical output

The maximum transmit optical output of an ONT is +5 dBm.

4.3.4 Normal laser operation

In normal operation, fiber cable laser radiation is always off until it receives signal from the line terminal card.

Operating personnel must observe the instructions on the laser explanatory label before plugging in the optical module.



DANGER

Hazard

Risk of eye damage by laser radiation.

4.3.5 Location class

Use cable supports and guides to protect the receptacles from strain.

4.4 Electrical safety guidelines

This section provides the electrical safety guidelines for the ONT equipment.



Note: The ONTs comply with the U.S. National Electrical Code. However, local electrical authorities have jurisdiction when there are differences between the local and U.S. standards.

4.4.1 Power supplies

The use of any non-Nokia approved power supplies or power adapters is not supported or endorsed by Nokia. Such use will void any warranty or support contract with Nokia. Such use greatly increases the danger of damage to equipment or property.

4.4.2 Cabling

The following are the guidelines regarding cables used for the ONT equipment:

- Use only cables approved by the relevant national electrical code.
- Use cables suitable for outdoor use for outdoor installation of ONTs.
- The ONTs have been evaluated for use with external POTS wiring without primary protection that may not exceed 140 ft (43 m) in reach. However, the power cable must not exceed 100 ft (31 m).

4.4.3 Protective earth

Earthing and bonding of the ONTs must comply with the requirements of NEC article 250 or local electrical codes.

4.5 ESD safety guidelines

The ONT equipment is sensitive to ESD. Operations personnel must observe the following ESD instructions when they handle the ONT equipment.



CAUTION

Service Disruption

This equipment is ESD sensitive. Proper ESD protections should be used when entering the TELCO Access portion of the ONT.

During installation and maintenance, service personnel must wear wrist straps to prevent damage caused by ESD.

Nokia recommends that you prepare the site before you install the ONT equipment. In addition, you must control relative humidity, use static dissipating material for furniture or flooring, and restrict the use of air conditioning.

4.6 Environmental requirements

See the ONT technical specification documentation for temperature ranges for ONTs.

During operation in the supported temperature range, condensation inside the ONT caused by humidity is not an issue. To avoid condensation caused by rapid changes in temperature and humidity, Nokia recommends:

- The door of the ONT not be opened until temperature inside and outside the enclosure has stabilized.
- If the door of the ONT must be opened after a rapid change in temperature or humidity, use a dry cloth to wipe down the metal interior to prevent the risk of condensation.

-
- When high humidity is present, installation of a cover or tent over the ONT helps prevent condensation when the door is opened.

5 XS-2426G-A unit data sheet

5.1 Overview

5.1.1 Purpose

5.1.2 Contents

5.1 Overview	41
5.2 XS-2426G-A part numbers and identification	41
5.3 XS-2426G-A general description	42
5.4 XS-2426G-A software and installation feature support	47
5.5 XS-2426G-A interfaces and interface capacity	48
5.6 XS-2426G-A LEDs	50
5.7 XS-2426G-A detailed specifications	52
5.8 XS-2426G-A GEM ports and T-CONTs	53
5.9 XS-2426G-A performance monitoring statistics	54
5.10 XS-2426G-A functional blocks	55
5.11 XS-2426G-A standards compliance	56
5.12 XS-2426G-A special considerations	58

5.2 XS-2426G-A part numbers and identification

Table 5-1, "Identification of XS-2426G-A indoor ONTs" (p. 41) provides part numbers and identification information for the XS-2426G-A indoor ONT.

Table 5-1 Identification of XS-2426G-A indoor ONTs

Ordering kit part number	Provisioning number	Description	CLEI Code	CPR	ECI/ Bar code
3FE 49351 AA	3FE 49348 AA	XS-2426G-A, XGS-PON ONT supports 2 POTS ports, 4xGE UNI, 2x2 11n + 2x2 11ax. Includes one USB 3.0 Type A ports and a 12V 3A wall mounted AC/DC power adapter with 2-pin US input plug	—	—	—
3FE 49351 BA	3FE 49348 AA	XS-2426G-A, XGS-PON ONT supports 2 POTS ports, 4xGE UNI, 2x2 11n + 2x2 11ax. Includes one USB 3.0 Type A ports and a 12V 3A wall mounted AC/DC power adapter with 2-pin EU input plug	—	—	—

Table 5-1 Identification of XS-2426G-A indoor ONTs (continued)

Ordering kit part number	Provisioning number	Description	CLEI Code	CPR	ECI/ Bar code
3FE 49351 CA	3FE 49348 AA	XS-2426G-A, XGS-PON ONT supports 2 POTS ports, 4xGE UNI, 2x2 11n + 2x2 11ax. Includes one USB 3.0 Type A ports and a 12V 3A wall mounted AC/DC power adapter with 3-pin UK input plug	—	—	—

Table 5-2, “XS-2426G-A power supply ordering information” (p. 42) provides the power supply information for the XS-2426G-A ONT. For more information on power supplies, see the **Nokia ONT Power Supply and UPS Guide**.

Table 5-2 XS-2426G-A power supply ordering information

ONT part numbers	Power information (Model No./Manufacture Part Number)	Power information	Customer category or country compliance tested for	Notes
Kit: 3FE 49351 AA EMA: 3FE 49348 AA	FUHUA: UES36WU-120300SPA/ UE200723GWZF2RI SOY: SOY-1200300US-050/BC120300- UA6A-LL0C	12V 3A wall mounted AC/DC power adapter with 2-pin US input plug	ANSI municipality US, Canada UL/ETL IEC62368-1	2-pin US input plug
Kit: 3FE 49351 BA EMA: 3FE 49348 AA	FUHUA: UES36WV-120300SPA/ UE200723GWZF1RI SOY: SOY-1200300EU/BC120300-EA6A- LLAB	12V 3A wall mounted AC/DC power adapter with 2-pin EU input plug	Europe CE EN62368-1	2-pin EU input plug
Kit: 3FE 49351 CA EMA: 3FE 49348 AA	FUHUA: UES36WB-120300SPA/ UE200723GWZF3RI SOY: SOY-1200300GB/BC120300-YB6A- LL09	12V wall mounted AC/DC power adapter with 3-pin UK input plug	Europe CE EN62368-1	3-pin UK input plug

5.3 XS-2426G-A general description

XS-2426G-A indoor ONTs provide the subscriber interface for the network by terminating the PON interface and converting it to user interfaces that directly connect to subscriber devices.

The XS-2426G-A has built-in Wi-Fi 802.11 b/g/n/ac/ax networking with triple play capability and can provide triple play services with voice, video and data.

The ONT is compatible with all existing subscriber equipment, including analog phones with both tone and rotary dial capabilities, cordless phones, modems, fax machines, and caller ID boxes (Type I, Type II, and Type III).

The ONT can be placed on a flat surface, such as a desk or shelf.

Figure 5-1 XS-2426G-A ONT

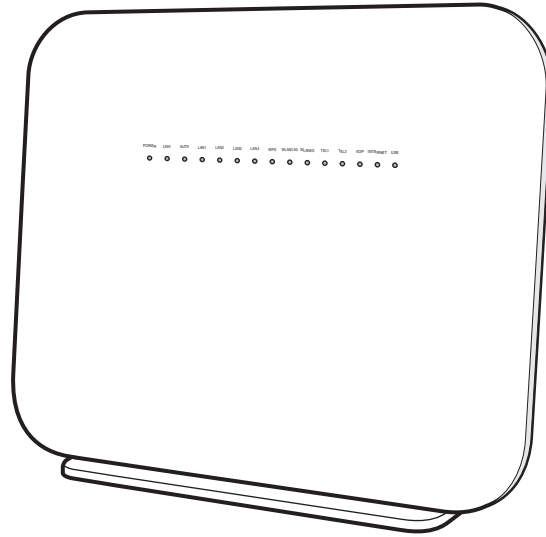

36550

XS-2426G-A indoor ONTs provide the following functions:

- Dual-band concurrent 2x2 802.11b/g/n/ax 2.4 GHz and 2x2 802.11ac/ax MU-MIMO 5 GHz
- Supports 802.11b/g/n/ax 2x2 Wireless 2.4 GHz MIMO; Channel bandwidth 20, 40 MHz, auto
- Supports 802.11a/n/ac/ax 2x2 Wireless 5 GHz Mu-MIMO; Channel bandwidth 20, 40, 80 MHz, auto
- Four Gigabit standard RJ-45 10/100/1000 Mbps, auto negotiating Ethernet ports and MDI/MDIX auto sensing
- Two POTS ports with R-J11 connectors
- One USB 3.0 Type A ports
- XGS-PON Uplink, G.9807.1, G.988 series standard compliant
- 256MB NAND Flash with bad block management, 512MB DDR3 RAM, pin2pin compatible design for possible upgrade of RAM/Flash
- Four RJ-45 10/100/1000 Ethernet ports with auto negotiation and MDI/MDIX auto sensing
- WLAN on/off push button
- WPS on/off push button
- LEDs on/off push button
- Reset button
- Triple-Play services, including voice, video and high speed Internet access
- Support for fax services
- Built-in layer 2 switch; Line Rate L2 traffic
- IP video distribution

-
- Wavelength: 1577 nm downstream; 1270 nm upstream
 - Supports WBF filter. The GPON ONTs can co-exist with XGSPON ONTs in the same PON.
 - Line rate: 9.953 Gb/s downstream and upstream
 - 2 inner antennas for 2.4G, 2 inner antennas for 5G
 - Optics that support received signal strength indication (RSSI)
 - Wireless 2.4 GHz 802.11b/g/n/ax 2x2 MIMO
 - Wireless 5 GHz 802.11a/n/ac/ax 2x2 MU-MIMO
 - 64/128 WEP encryption
 - WPA, WPA-PSK/TKIP
 - WPA2, WPA2-PSK/AES
 - WPA3, WPA3-SAE
 - VLAN tagging/detagging and marking/remarking of IEEE 802.1p per Ethernet port.
 - Dying gasp support
 - Voice Services via Session Initiation Protocol (SIP)
 - Multiple voice Code
 - DTMF dialing
 - Echo cancellation (G.168)
 - Fax mode configuration (T.30/T.38)
 - Caller ID, call waiting, call hold, 3-way calling, call transfer, message waiting
 - Forward Error Correction (FEC)
 - support for multiple SSIDs (private and public instances); contact your Nokia representative for further details.
 - Conductive power: 250mW/24dBm (2.4GHz); 500mW/27dBm (5GHz)
 - Maximum effective isotropic radiated power (EIRP): 500mW/27 dBm (2.4 GHz); 1000 mW/30 dBm (5GHz)
 - Bridged mode or routed mode per LAN port
 - Ethernet-based Point-to-Point (PPPoE)
 - DHCP client/server
 - DNS server/client
 - DDNS
 - Port forwarding
 - Network Address Translation (NAT)
 - Network Address Port Translation (NAPT)
 - UPnP IGD2.0 support
 - ALG
 - IGMP snooping and proxy (v2/v3)
 - Traffic classification and QoS capability

- OMCI/TR-069 Web GUI configuration
- Performance monitoring and alarm reporting
- Remote software image downloading and activation
- IP/MAC/URL filter
- Multi-level firewall and ACL

5.3.1 TR-069 parameter support

The XS-2426G-A ONT supports the following TR-069 features:

- Host object
- Port forwarding
- Optical parameters
- Object support for WiFi parameters
- Statistics and troubleshooting
- Diagnostic parameters

Host object support

The ONT provides host object support for: InternetGatewayDeviceLANDevice.Hosts.Host.

Port forwarding support

The ONT supports the port forwarding of objects via TR-069:

- Application Name
- WAN Port
- LAN Port
- Internal Client
- Protocol
- Enable Mapping
- WAN Connection List

These are the same port forwarding parameters supported in the GUI. For more information, see [Table 8-33, “Port Forwarding parameters” \(p. 138\)](#) in [Chapter 8, “Configure a XS-2426G-A indoor ONT”](#).

Optical parameters support

The ONT supports the reading of optical parameters via TR-069:

- laser bias current
- voltage
- temperature
- received signal levels
- lower thresholds

These are the same optical parameters supported in the GUI. For more information, see [Table 8-8, “Optics Module Status parameters”](#) (p. 91) in [Chapter 8, “Configure a XS-2426G-A indoor ONT”](#).

Object support for WiFi parameters

The ONT supports the status retrieval and configuration of the following Wi-Fi parameters via TR-069:

- channel
- SSID
- password for WPA and WEP
- Tx power (transmission rate in percentage of maximum transmit power)
- WPS

These are the same TR-069 object parameters that are supported in the GUI. For more information, see [Table 8-14, “Wireless \(2.4GHz\) parameters”](#) (p. 106) and [Table 8-15, “Wireless \(5GHz\) parameters”](#) (p. 108) in [Chapter 8, “Configure a XS-2426G-A indoor ONT”](#).

Statistics and troubleshooting support

The ONT supports TR-069 statistics and troubleshooting for LAN, WAN, and WiFi.

For more information, see the Procedure [8.59 “Viewing Residential Gateway \(RG\) troubleshooting counters”](#) (p. 161) in [Chapter 8, “Configure a XS-2426G-A indoor ONT”](#).

Diagnostic parameter support

The ONT supports the following TR-069 diagnostic parameters:

- TR-143
- IP ping
- traceroute

These are the same diagnostic parameters supported in the GUI. For more information, see the Procedure [8.56 “Diagnosing WAN connections”](#) (p. 157) in [Chapter 8, “Configure a XS-2426G-A indoor ONT”](#).

5.3.2 TR69 authentication using TLS and CA certificates

XS-2426G-A ONTs support TLS, as well as ACS authentication using SHA-256 pre-installed certificates.

If the URL is set to the `https://...` format, by default, the connection will use TLS without authentication mode. The ONT can also authenticate the ACS using a pre-installed CA certificate.

The XS-2426G-A ONTs support TLSv1.3 for TR069. The ONT supports download certification from ACS.

5.3.3 TR-104 parameter extension support for voice service

A vendor specific attribute has been added to the TR-104 Voice Service object structure to enable the ACS to configure the name of the embedded GSIP XML file to be selected.

The TR-104 Voice Service Object is:
InternetGatewayDevice.Services.VoiceService.{i}.Capabilities.SIP.

The vendor specific attribute is: X_ALU-COM_XML_File_Name_Path.

5.3.4 TR-104 voice-related alarms

The XS-2426G-A ONT supports the following four TR-104 voice-related alarms on a per FXS port basis.

These alarms all represent SIP registration failures with an alarm level of MAJOR.

- SIPREGDNS: domain name could not be resolved
- SIPREGAUTH: authentication failed
- SIPREGTO: re-transmissions timed out
- SIPREGERR: error response from the registration server

5.3.5 TR-104 parameters for FX line testing

New attributes have been added to the TR-104 Voice Service object structure to enable the ACS to perform line tests. The ONT supports the following electrical line tests:

- hazardous potential
- foreign electrical motive force
- resistive faults
- receiver off-hook test
- ringers test

5.3.6 TR-111 support

The XS-2426G-A ONT supports TR-111, which extends the WAN Management Protocol defined in TR-069 to enhance the ability to remotely manage LAN devices.

The device-gateway association enables an ACS to identify the associated gateway through which a device is connected.

A connect request via the NAT gateway enables an ACS to initiate a TR-069 session with a device that is operating behind a NAT gateway.

5.4 XS-2426G-A software and installation feature support

For information on installing or replacing the XS-2426G-A see:

- [Chapter 6, "Install a XS-2426G-A indoor ONT"](#)
- [Chapter 7, "Replace a XS-2426G-A indoor ONT"](#)

For information on the following topics, see the **Nokia ONT Product Overview Guide**:

- ONT and MDU general descriptions of features and functions
- Ethernet interface specifications
- POTS interface specifications
- RSSI specifications

- Wi-Fi specifications
- ONT optical budget
- SLID entry via Ethernet port
- ONT management using an ONT interface

5.5 XS-2426G-A interfaces and interface capacity

Table 5-3, “XS-2426G-A indoor ONT interface connection capacity” (p. 47) describes the supported interfaces and interface capacity for XS-2426G-A indoor ONTs.

Table 5-3 XS-2426G-A indoor ONT interface connection capacity

ONT type and model	Maximum capacity								
	POTS	10/ 100 BASE-T	10/ 100/ 1000 BASE-T	RF video (CATV)	MoCA	VDSL2	E1/T1	Local craft	XGSPON SC/APC
XS-2426G-A ¹	2	—	4	—	—	—	—	—	1

Notes:

1. The XS-2426G-A ONTs provide Wi-Fi service that is enabled and disabled using a Wi-Fi on/off switch.

5.5.1 XS-2426G-A connections and components

Figure 5-2, “XS-2426G-A indoor ONT physical connections (back)” (p. 48) shows the physical connections for XS-2426G-A indoor ONTs.

Figure 5-2 XS-2426G-A indoor ONT physical connections (back)

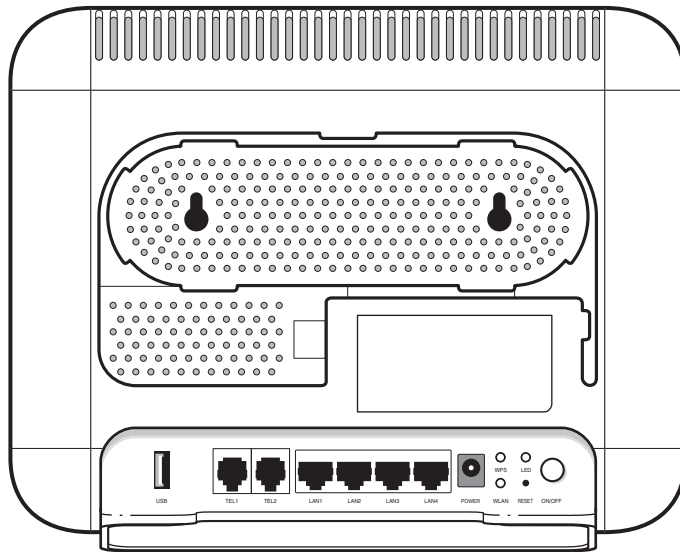

36551

Figure 5-3, “XS-2426G-A indoor ONT with fiber optic connector” (p. 48) shows the XS-2426G-A indoor ONT with a fiber optic connector.

Figure 5-3 XS-2426G-A indoor ONT with fiber optic connector

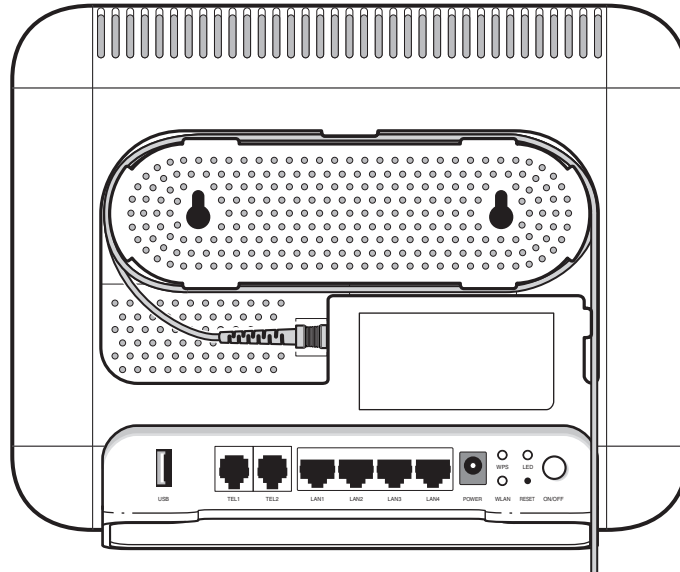

36552

Table 5-4, “XS-2426G-A indoor ONT physical connections” (p. 49) describes the physical connections for XS-2426G-A indoor ONTs.

Table 5-4 XS-2426G-A indoor ONT physical connections

Connection ¹	Print Letters	Description
POTS port	TEL1 and TEL2	This connection is provided through an RJ-11 port. One POTS connection is supported. The POTS port supports voice services.
Ethernet ports	LAN1 to LAN4	This connection is provided through Ethernet RJ-45 connectors. Up to four 10/100/1000 Base-T Ethernet interfaces are supported. The Ethernet ports can support both data and in-band video services on all four interfaces.
Power input	POWER	This connection is provided through the power connector. A power cable fitted with a barrel connector is used to make the connection.
Reset button	RESET	Pressing the Reset button for less than 10 seconds reboots the ONT; pressing the Reset button for 10 seconds resets the ONT to the factory defaults, except for the LOID and SLID.
WLAN button	WLAN	Wi-Fi service is compliant with IEEE 802.11 standards and is enabled and disabled using the WLAN button.
WPS button	WPS	The Wi-Fi Protected Setup (WPS) button enables and disables the WPS.
LED button	LED	The LED button turns the LED indicators on or off.

Table 5-4 XS-2426G-A indoor ONT physical connections (continued)

Connection ¹	Print Letters	Description
On/Off button	ON/OFF	This button turns the ONT on or off.
USB port	USB	This connection is provided through 1 USB port on the side of the ONT. The ONT supports external USB hard drives that can be made accessible to all LAN devices.
Fiber optic port		The SC/APC fiber optic port is located at the back of the ONT and provides the connection for the fiber optic cable.

Notes:

1. The primary path for the earth ground for these ONTs is provided by the 12V Return signal in the power connector.

5.6 XS-2426G-A LEDs

Figure 5-4, “XS-2426G-A indoor ONT LEDs” (p. 50) shows the XS-2426G-A indoor ONT LEDs.

Figure 5-4 XS-2426G-A indoor ONT LEDs

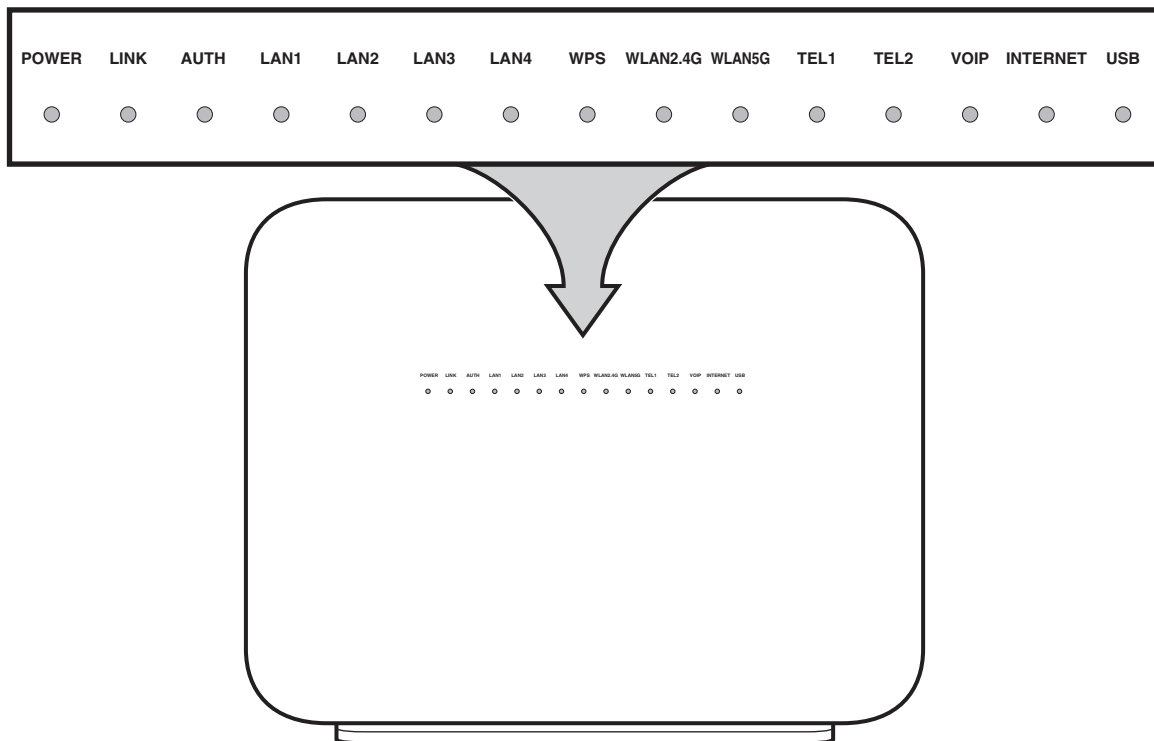

35958

Table 5-5, “XS-2426G-A indoor ONT LED descriptions” (p. 51) provides LED descriptions for XS-2426G-A indoor ONTs.

Table 5-5 XS-2426G-A indoor ONT LED descriptions

Indicator	LED color and behavior	LED behavior description
Power	Green solid Red solid Off	Power on Light failed on startup (for example corrupt flash), or self test failed on startup, or self test failed during regular operation or when executed over OMCI Power off
Link	Green solid Off	GPON link between ONT and OLT is operating normally GPON link is down or no link is connected
Auth	Off Green solid Green flashing	Fiber is not connected or no power is received to the ONT ONT is configured on the OLT and is in service (UP) ONT is in the process of ranging or synchronizing over the OLT ONT is ranged but not configured on the OLT ONT is configured on OLT but admin is down and the ONT is out of service ONT is in service and subsequently un-configured on the OLT ONT is in service while other services are being configured ONT is in service but admin is down and the ONT is out of service
LAN 1 to 4	Green solid Green flashing Off	ONT is connected to the associated LAN port (includes devices with wake-on-LAN capability where a slight voltage is supplied to an Ethernet connection) LAN activity is present (traffic in either direction) ONT power is off or Ethernet is not connected
TEL 1 to 2	Green solid Green flashing Off	Phone is off hook. Phone is in 'call in' or 'talking' condition All phones are on hook
VOIP	Green solid Off	VoIP service is built up and can provide service VoIP service is not built up or out of service
WPS	Green solid Green flashing Red solid Off	WiFi protected setup link is up (negotiation and auto-configuration successful) WiFi protected setup link activity (negotiation and auto-configuration ongoing) WiFi protected setup processing exception or multiple peers using WPS simultaneously WiFi protected setup link down or no link connected (negotiation has not started or has failed)
WLAN 2.4 GHz	Green solid Green flashing Off	WLAN link is enabled in 2.4 GHz Traffic is passing through the WLAN link WLAN link is disabled or no link is connected
WLAN 5 GHz	Green solid Green flashing Off	WLAN link is enabled in 5 GHz Traffic is passing through the WLAN link WLAN link is disabled or no link is connected
USB	Green solid Green flashing Off	At least one device is connected to the USB port There is traffic activity on at least one device connected to the USB port No device is connected to the USB port

Table 5-5 XS-2426G-A indoor ONT LED descriptions (continued)

Indicator	LED color and behavior	LED behavior description
INTERNET	Green solid Green flashing Off	<p>HSI WAN is connected: a) the device has an IP address assigned from IPCP, DHCP, or static, and no traffic has been detected; b) the session is dropped due to idle timeout but the PON link is still present.</p> <p>PPPoE or DHCP connection is in progress.</p> <p>HSI WAN is not connected: a) there is no physical interface connection; b) the device is in bridged mode without an assigned IP address; c) the session has been dropped for reasons other than idle timeout.</p>

5.7 XS-2426G-A detailed specifications

Table 5-6, “XS-2426G-A indoor ONT physical specifications” (p. 52) lists the physical specifications for XS-2426G-A indoor ONTs.

Table 5-6 XS-2426G-A indoor ONT physical specifications

Description	Specification
Depth	1.46 in. (37 mm)
Width	9.65 in. (245 mm)
Height (including antenna)	7.7 in. (195 mm)
Weight [within ± 0.5 lb (0.23 kg)] (net weight of ONT)	1.4 lbs (650g)

Table 5-7, “XS-2426G-A dimension data specifications” (p. 52) lists the dimension data specifications for XS-2426G-A ONT

Table 5-7 XS-2426G-A dimension data specifications

Dimension	Specification
Packet size supported	2000 jumbo frames
number of IP addresses supported (or ranges)	<p>In LAN network, the supported range is:</p> <ul style="list-style-type: none"> IPv4: 192.168.0.2 ~ 192.168.0.254 IPv6: no limitation
number of supported Wi-Fi clients (per radio, per device, per mesh)	32 per radio, 64 per device, no mesh supported
number of supported beacons /APs in a mesh	3 (including device itself)
number of supported WAN interfaces	<p>Supports eight WAN connection:</p> <p>WAN - Router:</p> <ul style="list-style-type: none"> Connection Type: IPoE; Service: INTERNET WAN IP Mode: DHCP

Table 5-7 XS-2426G-A dimension data specifications (continued)

Dimension	Specification
number of supported VLANs	Supports 4094 VLANs. Supports only untagged packets in upstream.
number of priority queues, and overall buffer size	128 priority queues. Max 16MB for WAN and 4MB for LAN
number of multicast groups (DACL entries)	1024

Table 5-8, “XS-2426G-A indoor ONT power consumption specifications” (p. 53) lists the power consumption specifications for XS-2426G-A indoor ONT.

Table 5-8 XS-2426G-A indoor ONT power consumption specifications

Mnemonic	Maximum power (Not to exceed)	Condition	Minimum power	Condition
XS-2426G-A	36 W	2 POTS 5REN, 4 10/100/1000 Base-T Ethernet, Wi-Fi operational, USB operational	7.2 W	Wi-Fi beacon, other interface/service not provisioned

Table 5-9, “XS-2426G-A indoor ONT environmental specifications” (p. 53) lists the environmental specifications for XS-2426G-A indoor ONT.

Table 5-9 XS-2426G-A indoor ONT environmental specifications

Mounting method	Temperature range and humidity	Altitude
On desk or shelf	Operating: 23°F to 113°F (-5°C to 45°C) ambient temperature 5% to 95% relative humidity, non-condensing	Contact your Nokia technical support representative for more information
	Storage: -4°F to 158°F (-20°C to 70°C)	

5.8 XS-2426G-A GEM ports and T-CONTs

Table 5-10, “XS-2426G-A indoor ONT capacity for GEM ports and T-CONTs” (p. 53) lists the maximum number of supported T-CONTs and GEM ports. See the appropriate release Customer Release Notes for the most accurate list of supported devices.

Table 5-10 XS-2426G-A indoor ONT capacity for GEM ports and T-CONTs

ONT or MDU	Maximum	Notes
Package P ONTs		
GEM ports per indoor or outdoor ONT	256	256 are present; 254 are available, and 2 are reserved for multicast and debugging
T-CONTs per indoor or outdoor ONT	32	32 are present; 31 are available, and 1 is reserved for OMCI

5.9 XS-2426G-A performance monitoring statistics

The following section identifies the supported performance monitoring statistics for XS-2426G-A ONTs. A check mark indicates the statistic is supported on that ONT. An empty cell indicates the statistic is not supported. The following tables are categorized by supported alarm types:

- [Table 5-11, “Package S ONTs ONTENET performance monitoring statistics” \(p. 53\)](#) provides statistics for ONTENET type counters
- [Table 5-12, “Package S ONTs ONTL2UNI performance monitoring statistics” \(p. 54\)](#) provides statistics for ONTL2UNI type counters
- [Table 5-13, “Package S ONTs PONONTTC, PONONTMCTC, PONONTTCHSI, PONONTTCCES, PONONTTCFLOW, PONONTTCVOIP performance monitoring statistics” \(p. 55\)](#) provides statistics for PONONTTC, PONONTMCTC, PONONTTCHSI, PONONTTCCES, PONONTTCFLOW, and PONONTTCVOIP type counters
- [Table 5-14, “Package S ONTs PONONTTC aggregate performance monitoring statistics” \(p. 55\)](#) provides statistics for PONONTTC aggregate type counters

i **Note:** If you have trouble accessing XS-2426G-A ONTs performance monitoring statistics using TL1, please contact your Nokia support representative for more information about how to access and retrieve performance monitoring type counters.

Table 5-11 Package S ONTs ONTENET performance monitoring statistics

ONT	ONTENET statistics													
	FCSE	EC	LC	RBO	SCF	MCF	DT	IMTE	CSE	AE	IMRE	FTL	TBO	SQE
XS-2426G-A ¹	✓	✓	✓	✓	✓	✓	✓	✓	✓	✓	—	✓ ²	✓	—

Notes:

1. A 5 second polling window limitation exists on the ONT, therefore the margin of error for each 15-min window is 5 seconds
2. Only packets larger than 9 kB will be counted.

Table 5-12 Package S ONTs ONTL2UNI performance monitoring statistics

ONT	ONTL2UNI statistics										
	FRAMES	BYTES	MCFRAMES	DSDRPFRRMS	USDRPFRRMS	USFRAMES	DSFRAMES	USBYTES	DSBYTES	USMCFRAMES	DSMCFRAMES
XS-2426G-A ¹	✓	✓	✓	✓	✓	✓	✓	✓	✓	✓	✓

Notes:

1. A 5 second polling window limitation exists on the ONT, therefore the margin of error for each 15-min window is 5 seconds

Table 5-13 Package S ONTs PONONTTC, PONONTMCTC, PONONTTCHSI, PONONTTCES, PONONTTCFLOW, PONONTTCVOIP performance monitoring statistics

ONT	PONONTTC, PONONTMCTC, PONONTTCHSI, PONONTTCES, PONONTTCFLOW, PONONTTCVOIP statistics					
	TXBLOCKS	TXFRAGS	RXBLOCKS	RXFRAGS	LOSTFRAGS	BADGEMHDRS
XS-2426G-A ¹	✓	✓	✓	✓	✓	—

Notes:

1. A 5 second polling window limitation exists on the ONT, therefore the margin of error for each 15-min window is 5 seconds

Table 5-14 Package S ONTs PONONTTC aggregate performance monitoring statistics

ONT	PONONTTC (aggregate) statistics					
	TXBLOCKS	TXFRAGS	RXBLOCKS	RXFRAGS	LOSTFRAGS	BADGEMHDRS
XS-2426G-A ¹	✓	✓	✓	✓	✓	—

Notes:

1. A 5 second polling window limitation exists on the ONT, therefore the margin of error for each 15-min window is 5 seconds

5.10 XS-2426G-A functional blocks

XS-2426G-A indoor ONTs are single-residence ONTs that support Wireless (Wi-Fi) service. Wi-Fi service on these ONTs is compliant with the IEEE 802.11 standard and enabled or disabled using a WLAN button. In addition to the Wi-Fi service, these ONTs transmit Ethernet packets to four RJ-45 Ethernet ports and voice traffic to twp RJ-11 POTS port. These ONTs also feature fiber optic, USB, and power connectors.

[Figure 5-5, “XS-2426G-A ONT functional block” \(p. 56\)](#) shows the functional blocks for XS-2426G-A indoor ONT.

Figure 5-5 XS-2426G-A ONT functional block

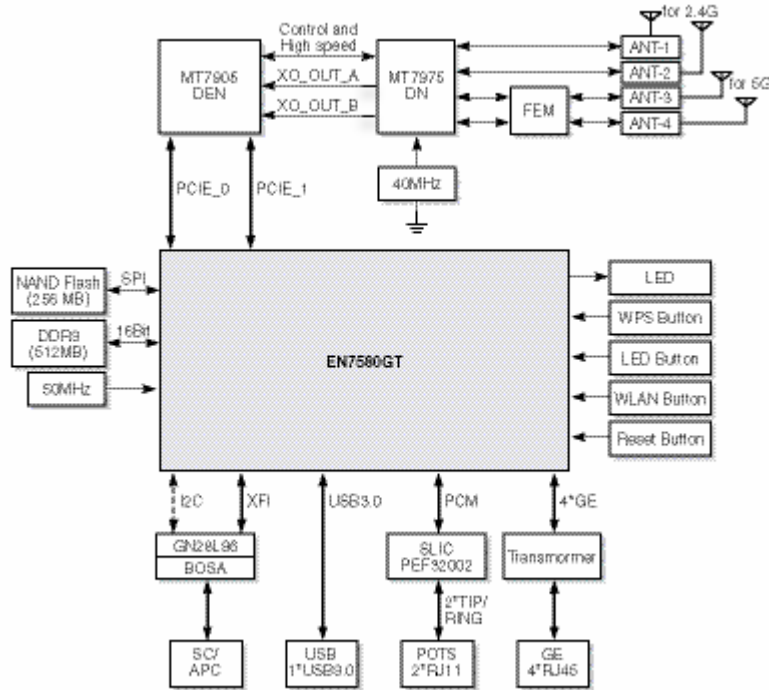

38554

5.11 XS-2426G-A standards compliance

XS-2426G-A indoor ONTs are compliant with the following standards:

- CE marking for European standards for health, safety, and environmental protection
- EN 300-328 v1.9.1 wide band data transmission standards for 2.4GHz bands
- G.984 support GPON interface (framing)
- G.984.2 (Amd1, class B+) for GPON
- G.984.3 support for activation and password functions
- G.984.3 support for AES with operator enable/disable on per port-ID level
- G.984.3 support for dynamic bandwidth reporting
- G.984.3 support for FEC in both upstream and downstream directions
- G.984.3 support for multicast using a single GEM Port-ID for all video traffic
- G.984.4 and G.983.2 support for ONT management and provisioning
- IEEE 802.1p for traffic prioritization
- IEEE 802.1q for VLANs
- IEEE 802.3 (2012)
- IEEE 802.11b/g/b/ac/ax for WIFI

- ITU-T G.711, G.722, G.723, G.726, G.729
- SIP RFC 3261

5.11.1 Energy-related products standby and off modes compliance

Hereby, Nokia declares that the XS-2426G-A ONTs are in compliance with the essential requirements and other relevant provisions of Directive 2009/125/EC together with Commission Regulation (EC) No 1275/2008 and Commission Regulation (EC) No 801/2013.

The XS-2426G-A ONTS qualify as equipment with high network availability (HiNA) functionality. Since the main purpose of XS-2426G-A ONTs is to provide network functionality with HiNA 7 days /24 hours, the modes Off/Standby, Power Management, and Networked Standby are inappropriate.

For information about the type and number of network ports, see [5.5 “XS-2426G-A interfaces and interface capacity” \(p. 48\)](#) in this chapter.

For information about power consumption, see [5.7 “XS-2426G-A detailed specifications” \(p. 52\)](#) in this chapter.

5.11.2 FCC statement

This equipment has been tested and found to comply with the limits for a Class B digital device, pursuant to part 15 of the FCC Rules. These limits are designed to provide reasonable protection against harmful interference in a residential installation. This equipment generates, uses and can radiate radio frequency energy and, if not installed and used in accordance with the instructions, may cause harmful interference to radio communications. However, there is no guarantee that interference will not occur in a particular installation. If this equipment does cause harmful interference to radio or television reception, which can be determined by turning the equipment off and on, the user is encouraged to try to correct the interference by one or more of the following measures:

- Reorient or relocate the receiving antenna.
- Increase the separation between the equipment and receiver.
- Connect the equipment into an outlet on a circuit different from that to which the receiver is connected.
- Consult the dealer or an experienced radio/TV technician for help.

5.11.3 FCC Radiation Exposure Statement

This device complies with FCC radiation exposure limits set forth for an uncontrolled environment and it also complies with Part 15 of the FCC RF Rules. This equipment must be installed and operated in accordance with provided instructions and the antenna(s) used for this transmitter must be installed to provide a separation distance of at least 20 cm from all persons and must not be co-located or operating in conjunction with any other antenna or transmitter. End-users and installers must be provided with antenna installation instructions and consider removing the no-collocation statement.

This device complies with Part 15 of the FCC Rules. Operation is subject to the following two conditions:

1. this device may not cause harmful interference, and

2. this device must accept any interference received, including interference that may cause undesired operation.

**CAUTION****Service Disruption**

Any changes or modifications not expressly approved by the party responsible for compliance could void the user's authority to operate the equipment.

5.12 XS-2426G-A special considerations

XS-2426G-A is a package P ONT.

5.12.1 Wi-Fi service

XS-2426G-A indoor ONTs feature Wi-Fi service as well as voice and data services. Wi-Fi is a wireless networking technology that uses radio waves to provide wireless HSI and network connections. This ONT complies with the IEEE 802.11 standards, which the Wi-Fi Alliance defines as the basis for Wi-Fi technology.

Wi-Fi physical features

XS-2426G-A indoor ONTs have the following physical features that assist in providing Wi-Fi service:

- 1 WLAN button for enabling and disabling Wi-Fi service
- 1 Wi-Fi Protected Setup (WPS) push button for adding WPS-enabled wireless devices
- 4 internal antennas: 2x2 for 2.4G and 2x2 for 5G

Wi-Fi standards and certifications

The Wi-Fi service on XS-2426G-A indoor ONTs supports the following IEEE standards and Wi-Fi Alliance certifications:

- Certified for IEEE 802.11ac/b/g/n/standards
- WPA support including WPA-PSK
- Certified for WPA2-Personal
- Certified for WPA2-enterprise

Wi-Fi GUI features

XS-2426G-A indoor ONTs have HTML-based Wi-Fi configuration GUIs.

5.12.2 XS-2426G-A ONT considerations and limitations

[Table 5-15, "XS-2426G-A ONT considerations and limitations" \(p. 59\)](#) lists the considerations and limitations for Package P XS-2426G-A ONTs.

Table 5-15 XS-2426G-A ONT considerations and limitations

Considerations and limitations
Call History Data collection (ONTCALLHST) is supported, except for the following parameters: RTP packets (discarded), far-end RTCP and RTCP-XR participation, RTCP average and peak round trip delay, MOS, average jitter, number of jitter-buffer over-runs and under runs.
Some voice features are configurable on a per ONT basis, including Call Waiting, Call Hold, 3-Way Calling, and Call Transfer.
The following voice features / GSIP parameters are configurable on a per-Client/ per-ONT basis (not per-Subscriber): <ul style="list-style-type: none">• Enable Caller ID and Enable Caller Name ID• Digitmap and the associated Interdigit and Critical timers and Enter key parameters• Warmline timer is enabled per subscriber, but the warmline timer value is configured per ONT and must have a lower value than the Permanent time• Miscellaneous timers: Permanent, Timed-release, Reanswer, Error-tone, and CW-alert timers• Features / functions: Message waiting mode, WMWI refresh interval, DTMF volume level• Service Codes for the following features: CW, Call Hold and Warmline
The maximum value of the ringing AC voltage is 60Vrms, and the ring DC offset voltage suggest to be 0V.

6 Install a XS-2426G-A indoor ONT

6.1 Overview

6.1.1 Purpose

6.1.2 Contents

6.1 Overview	61
6.2 Purpose	61
6.3 General	61
6.4 Prerequisites	61
6.5 Recommended tools	61
6.6 Safety information	62
6.7 Procedure	62

6.2 Purpose

This chapter provides the steps to install a XS-2426G-A indoor ONT.

6.3 General

The steps listed in this chapter describe mounting and cabling for a XS-2426G-A indoor ONT.

6.4 Prerequisites

You need the following items before beginning the installation:

- all required cables

6.5 Recommended tools

You need the following tools for the installation:

- #2 Phillips screwdriver
- 1/4 in. (6 mm) flat blade screwdriver
- wire strippers
- fiber optic splicing tools
- RJ-45 cable plug crimp tool
- voltmeter or multimeter
- optical power meter

- drill and drill bits
- paper clip

6.6 Safety information

Read the following safety information before installing the unit.



DANGER

Hazard

Hazardous electrical voltages and currents can cause serious physical harm or death. Always use insulated tools and follow proper safety precautions when connecting or disconnecting power circuits.

Make sure all sources of power are turned off and have no live voltages present on feed lines or terminals. Use a voltmeter to measure for voltage before proceeding.

Always contact the local utility company before connecting the enclosure to the utilities.



WARNING

Equipment Damage

This equipment is ESD sensitive. Proper ESD protections should be used when removing the fiber access cover of the indoor ONT.



CAUTION

Service Disruption

Keep indoor ONTs out of direct sunlight. Prolonged exposure to direct sunlight can damage the unit.



Note: Observe the local and national laws and regulations that may be applicable to this installation.

Observe the following:

- The indoor ONT should be installed in accordance with the applicable requirements of the NEC or CEC. Local authorities and practices take precedent when there is conflict between the local standard and the NEC or CEC.
- The indoor ONT must be installed by qualified service personnel.
- Indoor ONTs must be installed with cables that are suitably rated and listed for indoor use.
- See the detailed specifications in the [Chapter 5, "XS-2426G-A unit data sheet"](#) for the temperature ranges of these ONTs.

6.7 Procedure

Use this procedure to install a XS-2426G-A indoor ONT.

1

Place the indoor ONT unit on a flat surface, such as a desk or shelf.



Note: The XS-2426G-A cannot be stacked with another ONT or with other equipment. The ONT mounting requirements are:

- allow a minimum 100 mm clearance above the top cover
- allow a minimum 50 mm clearance from the side vents
- do not place any heat source directly above the top cover or below the bottom cover

2

Review the connection locations, as shown in [Figure 6-1, “XS-2426G-A ONT connections”](#) (p. 62).

Figure 6-1 XS-2426G-A ONT connections

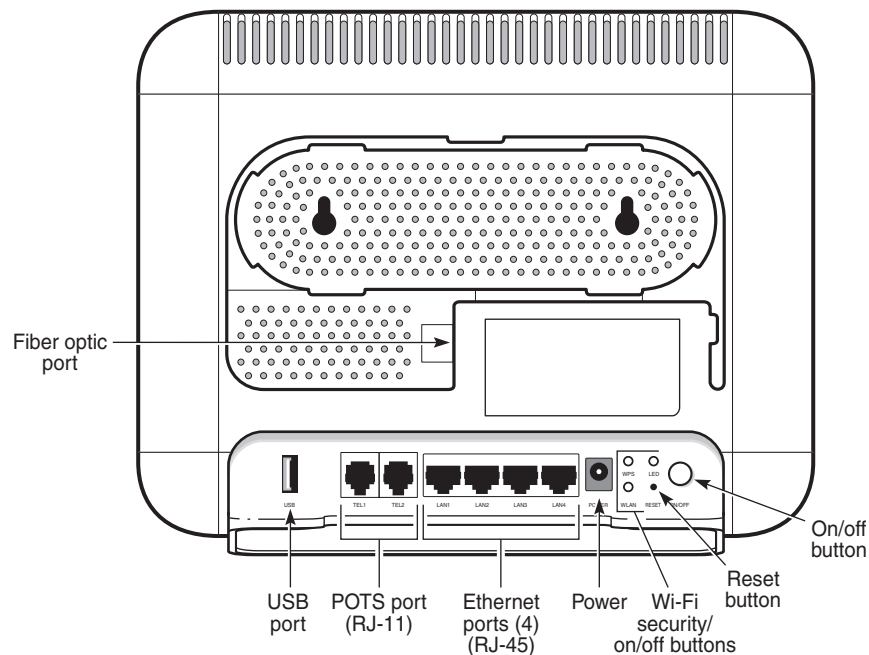

3

Connect the Ethernet cables to the RJ-45 ports.

4

Route the POTS cable directly to the RJ-11 port as per local practices.

5

**DANGER****Hazard**

Fiber cables transmit invisible laser light. To avoid eye damage or blindness, never look directly into fibers, connectors, or adapters.

**WARNING****Equipment Damage**

Be careful to maintain a bend radius of no less than 1.5 in. (3.8 cm) when connecting the fiber optic cable. Too small of a bend radius in the cable can result in damage to the optic fiber.

Connect the fiber optic cable with SC/APC adapter to the SC/APC connector on the bottom of the ONT.



Note: Fiber cable preparation varies depending on the type and size of the inside or outside plant fiber cable being spliced to the SC/APC fiber optic pigtail cable.

6

Connect the power cable to the power connector.

7

Power up the ONT unit by using the power switch.

8

If used, enable the Wi-Fi service.

- a. Locate the WLAN button on the ONT; see [Figure 6-1, "XS-2426G-A ONT connections" \(p. 63\)](#) for location of the WLAN button.
- b. Press the WLAN button to change the status of the Wi-Fi service.

9

Verify the ONT LEDs, voltage status, and optical signal levels; see the **Nokia ONT Hardware and Cabling Installation Guide**.

10

Activate and test the services; see the **Nokia ONT Hardware and Cabling Installation Guide**.

11

If necessary, reset the ONT.

- a. Locate the Reset button on a XS-2426G-A indoor ONT as shown in [Figure 6-1, "XS-2426G-A ONT connections" \(p. 63\)](#).

-
- b. Insert the end of a straightened paper clip or other narrow object into the hole in the Reset button to reset the ONT.

END OF STEPS

7 Replace a XS-2426G-A indoor ONT

7.1 Overview

7.1.1 Purpose

7.1.2 Contents

7.1 Overview	67
7.2 Purpose	67
7.3 General	67
7.4 Prerequisites	67
7.5 Recommended tools	67
7.6 Safety information	68
7.7 Procedure	68

7.2 Purpose

This chapter provides the steps to replace a XS-2426G-A indoor ONT.

7.3 General

The steps listed in this chapter describe mounting and cabling for a XS-2426G-A indoor ONT.

7.4 Prerequisites

You need the following items before beginning the installation:

- all required cables

7.5 Recommended tools

You need the following tools for replacing the ONT:

- #2 Phillips screwdriver
- 1/4 in. (6 mm) flat blade screwdriver
- wire strippers
- fiber optic splicing tools
- RJ-45 cable plug crimp tool
- voltmeter or multimeter
- optical power meter

- drill and drill bits

7.6 Safety information

Read the following safety information before replacing the unit.



DANGER

Hazard

Hazardous electrical voltages and currents can cause serious physical harm or death. Always use insulated tools and follow proper safety precautions when connecting or disconnecting power circuits.

Make sure all sources of power are turned off and have no live voltages present on feed lines or terminals. Use a voltmeter to measure for voltage before proceeding.

Always contact the local utility company before connecting the enclosure to the utilities.



WARNING

Equipment Damage

This equipment is ESD sensitive. Proper ESD protections should be used when removing the fiber access cover of the indoor ONT.



CAUTION

Service Disruption

Keep indoor ONTs out of direct sunlight. Prolonged exposure to direct sunlight can damage the unit.



Note: Observe the local and national laws and regulations that may be applicable to this installation.

Observe the following:

- The indoor ONT should be installed in accordance with the applicable requirements of the NEC or CEC. Local authorities and practices take precedent when there is conflict between the local standard and the NEC or CEC.
- The indoor ONT must be installed by qualified service personnel.
- Indoor ONTs must be installed with cables that are suitably rated and listed for indoor use.
- See the detailed specifications in the [Chapter 5, “XS-2426G-A unit data sheet”](#) for the temperature ranges of these ONTs.

7.7 Procedure

Use this procedure to replace a XS-2426G-A indoor ONT.

1

Deactivate the ONT services at the P-OLT.

If you are using the SLID feature, this step is not required. The ONT and the services can remain in service (IS).

- a. Use the RTRV-ONT command to verify the ONT status and th associated services. Record the serial number or the SLID of the ONT displayed in the command output.

Example:

```
RTRV-ONT::ONT-1-1-1-1-1;
```

- b. If the ONT is in service, place the ONT in OOS state.

Example:

```
ED-ONT::ONT-1-1-1-1-1;
```

2

If used, disable the Wi-Fi service by pressing the WLAN button; see [Figure 7-1, “XS-2426G-A indoor ONT connections”](#) (p. 68) for the location of the WLAN button.

Figure 7-1 XS-2426G-A indoor ONT connections

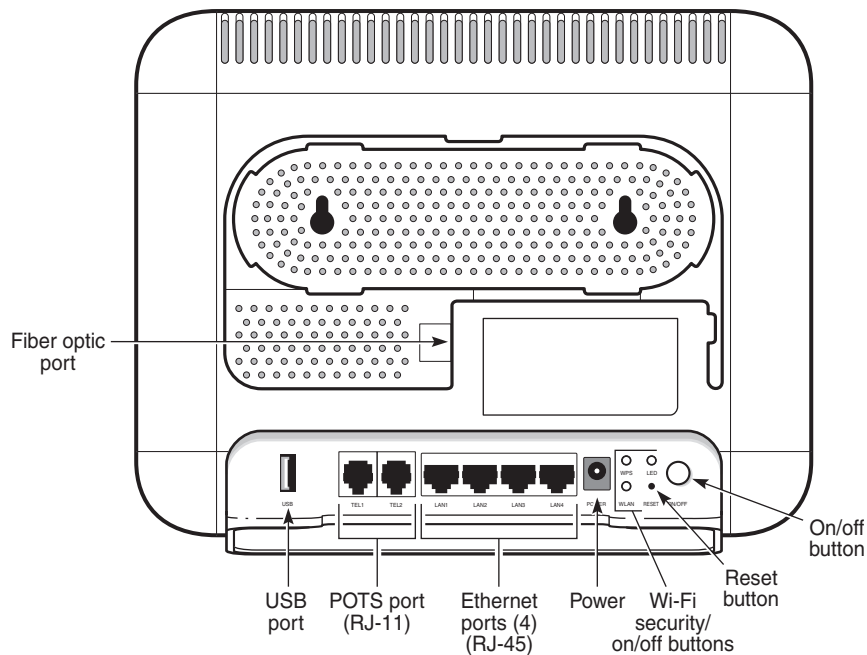

36553

3

Power down the unit by using the on/off power switch.

4

Disconnect the POTS, Ethernet, and power cables from the ONT; see [Figure 7-1, “XS-2426G-A indoor ONT connections” \(p. 69\)](#) for the connector locations on the XS-2426G-A indoor ONT.

5

**DANGER****Hazard**

Fiber cables transmit invisible laser light. To avoid eye damage or blindness, never look directly into fibers, connectors, or adapters.

Disconnect the fiber optic cables.

- a. Unplug the fiber optic cable with SC/APC connector from the bottom of the ONT.
- b. Attach a fiber dust cover to the end of the SC/APC connector.

6

Replace the old ONT with a new ONT on a flat surface, such as a desk or shelf.

7

Connect the Ethernet cables directly to the RJ-45 ports; see [Figure 7-1, “XS-2426G-A indoor ONT connections” \(p. 69\)](#) for the location of the RJ-45 ports.

8

Connect the POTS cable directly to the RJ-11 port as per local practices; see [Figure 7-1, “XS-2426G-A indoor ONT connections” \(p. 69\)](#) for the location of the RJ-11 ports.

9

**DANGER****Hazard**

Fiber optic cables transmit invisible laser light. To avoid eye damage or blindness, never look directly into fibers, connectors, or adapters.

If required, have approved service personnel who are trained to work with optic fiber clean the fiber optic connection. See the **Nokia ONT Configuration, Management, and Troubleshooting Guide** for more information about fiber optic handling, inspection, and cleaning.

10



Fiber cables transmit invisible laser light. To avoid eye damage or blindness, never look directly into fibers, connectors, or adapters.



Be careful to maintain a bend radius of no less than 1.5 in. (3.8 cm) when connecting the fiber optic cable. Too small of a bend radius in the cable can result in damage to the optic fiber.

Connect the fiber optic cable with SC/APC adapter into the SC/APC connector on the bottom of the ONT.

 **Note:** Fiber cable preparation varies depending on the type and size of the inside or outside plant fiber cable being spliced to the SC/APC fiber optic pigtail cable.

11

Connect the power cable to the power connector.

12

Power up the unit by using the power switch.

13

If used, enable the Wi-Fi service by pressing the WLAN button; see [Figure 7-1, “XS-2426G-A indoor ONT connections” \(p. 69\)](#) for the location of the WLAN button.

14

If used, configure the SLID; see the **Nokia ONT Configuration, Management, and Troubleshooting Guide** for more information.

 **Note:** A new SLID or the old SLID may be used with the replacement ONT.
If a new SLID is used, the new SLID must also be programmed at the P-OLT using TL1 or a network manager.
If the old SLID is used, no changes need to be made at the P-OLT; see the operations and maintenance documentation for the OLT for more details.

15

Verify the ONT LEDs, voltage status, and optical signal levels; see the **Nokia ONT Hardware and Cabling Installation Guide**.

16 _____
Activate and test the services; see the **Nokia ONT Hardware and Cabling Installation Guide**.

17 _____
If necessary, reset the ONT.

- a. Locate the Reset button on a XS-2426G-A indoor ONT as shown in [Figure 7-1, “XS-2426G-A indoor ONT connections”](#) (p. 69).
- b. Insert the end of a straightened paper clip or other narrow object into the hole in the Reset button to reset the ONT.

END OF STEPS _____

8 Configure a XS-2426G-A indoor ONT

8.1 Overview

8.1.1 Purpose

8.1.2 Contents

8.1 Overview	73
GUI configuration	76
8.2 General configuration	76
8.3 HGU mode GUI configuration	76
8.4 Log in to web-based GUI	76
Viewing device information and connection status	78
8.5 Overview	78
8.6 Viewing device information	78
8.7 Viewing LAN status	80
8.8 Viewing WAN status	81
8.9 Viewing WAN IPv6 status	83
8.10 Viewing STA information	85
8.11 Viewing Neighboring Access Points	87
8.12 Viewing home networking information	88
8.13 Viewing optics module status	90
8.14 Viewing statistics	91
8.15 Viewing voice information	94
Network configuration	97
8.16 Overview	97
8.17 Configuring LAN	97
8.18 Configuring LAN IPv6	99
8.19 Configuring WAN	101
8.20 Configuring WAN DHCP	103
8.21 Configuring Wireless 2.4GHz	104

8.22	Configuring Wireless 5GHz	107
8.23	Configuring wireless scheduling	110
8.24	Configuring IP routing	111
8.25	Configuring DNS	113
8.26	Configuring TR-069	114
8.27	Configuring GRE tunnel	115
8.28	Configuring Upstream (US) Classifier	117
8.29	Configuring QoS	121
	Security configuration	125
8.30	Overview	125
8.31	Configuring the firewall	125
8.32	Configuring the MAC filter	126
8.33	Configuring the IP filter	128
8.34	Configuring the URL filter	129
8.35	Configuring parental control	131
8.36	Configuring DMZ and ALG	133
8.37	Configuring access control	135
	Configuring the Application	137
8.38	Overview	137
8.39	Configuring port forwarding	137
8.40	Configuring port triggering	139
8.41	Configuring DDNS	140
8.42	Configuring NTP	142
8.43	Configuring USB	143
8.44	Configuring UPnP and DLNA	144
8.45	Configuring voice	145
	Maintenance	148
8.46	Overview	148
8.47	Configuring the password	148
8.48	Configuring LOID	150
8.49	Configuring SLID	150

8.50 Managing the device	152
8.51 Backing up the configuration	153
8.52 Restoring the configuration	153
8.53 Upgrading firmware	154
8.54 Rebooting the device	155
8.55 Resetting to factory defaults	156
8.56 Diagnosing WAN connections	157
8.57 Viewing log files	159
RG Troubleshooting Counters	161
8.58 Overview	161
8.59 Viewing Residential Gateway (RG) troubleshooting counters	161

GUI configuration

8.2 General configuration

Refer to the configuration information provided with your OLT for the software configuration procedure for a XS-2426G-A ONT.

For HTTP configuration procedures, refer to the **Nokia ONT Configuration, Management, and Troubleshooting Guide**.

8.3 HGU mode GUI configuration

Use the procedures below to use the web-based GUI for the XS-2426G-A in HGU mode. This mode is preset at delivery.

A home gateway unit (HGU) is a home networking device, used as a gateway to connect devices in the home through fiber to the Internet. An HGU provides a variety of features for the home network including routing and firewall capability. By using the HGU, users can connect all smart equipment in their home, including personal computers, set-top boxes, mobile phones, and other consumer electronics devices, to the Internet.

The XS-2426G-A ONTs support TLSv1.2 for WEBGUI (HTTPS).

8.4 Log in to web-based GUI

1

Open a web browser and enter the IP address of the ONT in the address bar.

The login page displays.

The default gateway IP address must be same as the one printed on the device label. You can connect to this IP address using your web browser after connecting your PC to one of Ethernet ports of the ONT. The static IP address of your PC must be in the same default gateway subnet as the ONT.

2



CAUTION

Service Disruption

*Pressing the **Reset** button for less than 10 seconds reboots the ONT; pressing the **Reset** button for 10 seconds resets the ONT to the factory defaults, except for the LOID and SLID.*

Enter your username and password in the Login page, as shown in [Figure 8-1, “Web login page”](#) (p. 77).

The default end-user account name and the default password for this account are printed on the device label. The superadmin account is meant for the Operator and is unique per device. Contact your Nokia representative to obtain the superadmin password based on the serial number on the device.

Figure 8-1 Web login page

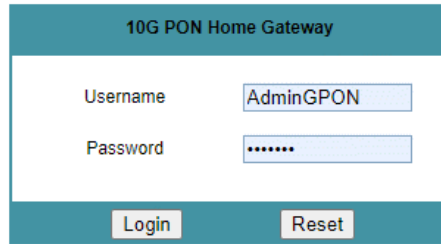

i **Note:** If you forget the current username and password, press the reset button for 5 seconds and the default values for the username and password will be recovered at startup.

3

Click **Login**. The Device Information page displays.

i **Note:** To help protect the security of your Internet connection, the application displays a pop-up reminder to change both the Wi-Fi password and the ONT password. To increase password security, use a minimum of 10 characters, consisting of a mix of numbers and upper and lower case letters.

END OF STEPS

Viewing device information and connection status

8.5 Overview

8.5.1 Purpose

This chapter describes procedures to view device information and connection status on the XS-2426G-A.

8.5.2 Contents

8.5 Overview	78
8.6 Viewing device information	78
8.7 Viewing LAN status	80
8.8 Viewing WAN status	81
8.9 Viewing WAN IPv6 status	83
8.10 Viewing STA information	85
8.11 Viewing Neighboring Access Points	87
8.12 Viewing home networking information	88
8.13 Viewing optics module status	90
8.14 Viewing statistics	91
8.15 Viewing voice information	94

8.6 Viewing device information

1

Click **Status**→**Device Information** from the left pane in the 10G PON Home Gateway page. The Device Information page displays the following information about the device.

Figure 8-2 Device Information page

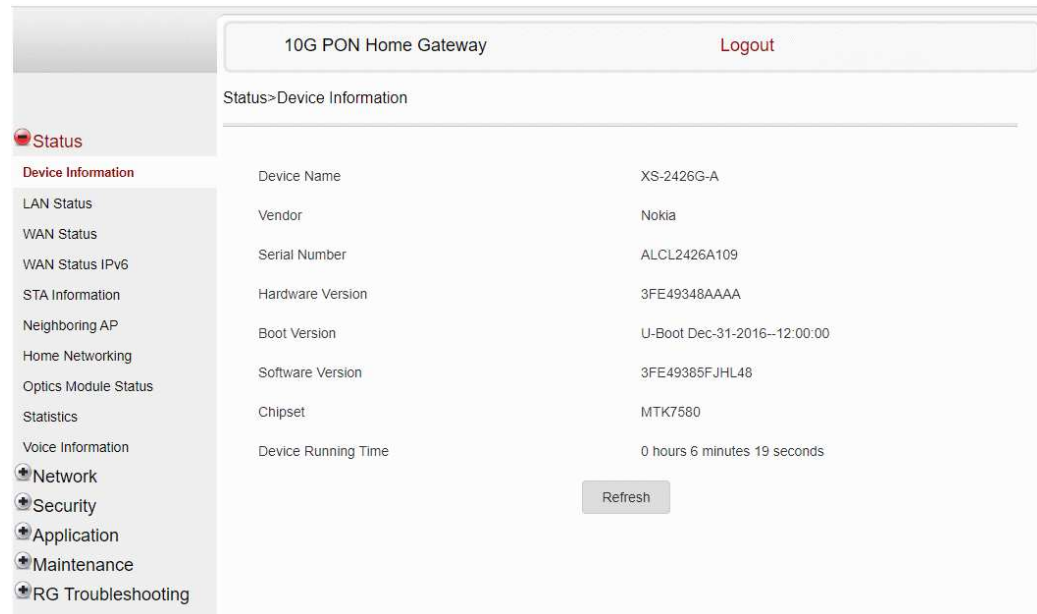

i **Note:** Upon login, the 10G PON Home Gateway page displays the WAN status block on the bottom left part of each page. This block shows the WAN connection ID, the WAN status, and any WAN errors. This block is accurate upon login, but it is static.

Table 8-1 Device Information parameters

Field	Description
Device Name	Name on the ONT
Vendor	Name of the vendor
Serial Number	Serial number of the ONT
Hardware version	Hardware version of the ONT
Boot version	Boot version of the ONT
Software version	Software version of the ONT
Chipset	Chipset of the ONT
Device Running Time	Amount of time the device has run since last reset in hours, minutes, and seconds

You can click **Refresh** to display up-to-date information.

END OF STEPS

8.7 Viewing LAN status

1

Click **Status**→**LAN Status** from the left pane in the 10G PON Home Gateway page. The LAN Status page displays the following information.

Figure 8-3 LAN Status page

The screenshot shows the LAN Status page for a 10G PON Home Gateway. The page is titled "10G PON Home Gateway" and includes a "Logout" button. The left navigation pane shows "Status" selected, with "LAN Status" highlighted. The main content area is divided into two sections: "Wireless Information" and "Ethernet Information".

Wireless Information

Wireless Status	on
Wireless Channel	4
SSID1 Name	ALHN-A109
Wireless Encryption Status	WPA/WPA2-PSK
Wireless Rx Packets	0
Wireless Tx Packets	0
Wireless Rx Bytes	0
Wireless Tx Bytes	0
Power Transmission(mW)	0

Ethernet Information

Ethernet Status	Up
Ethernet IP Address	192.168.1.254
Ethernet Subnet Mask	255.255.255.0
Ethernet MAC Address	00:11:20:20:10:09
Ethernet Rx Packets	1594
Ethernet Tx Packets	1402
Ethernet Rx Bytes	173537
Ethernet Tx Bytes	275016

LAN Port Information

Information	LAN1	LAN2	LAN3	LAN4
Status	Up	Down	Up	Up
Duplex Mode	Full-duplex	Half-duplex	Full-duplex	Full-duplex
Max Bit Rate	1000	Auto	1000	1000
Errors Received	0	0	0	0
Errors Sent	0	0	0	0
Packets Received	1594	0	0	0

Table 8-2 LAN Status parameters

Field	Description
Wireless Information	
Wireless Status	Indicates whether the wireless is on or off
Wireless Channel	Wireless channel number
SSID Name	Name of each SSID
Wireless Encryption Status	Encryption type used on the wireless connection
Wireless Rx Packets	Number of packets received on the wireless connection
Wireless Tx Packets	Number of packets transmitted on the wireless connection
Wireless Rx Bytes	Number of bytes received on the wireless connection
Wireless Tx Bytes	Number of bytes transmitted on the wireless connection
Power Transmission (mW)	Power of the wireless transmission, in mW
Ethernet Information	
Ethernet Status	Indicates whether the Ethernet connection is on or off
Ethernet IP Address	IP address of the Ethernet connection
Ethernet Subnet Mask	Subnet Mask of the Ethernet connection
Ethernet MAC Address	MAC address of the Ethernet connection
Ethernet Rx Packets	Number of packets received on the Ethernet connection
Ethernet Tx Packets	Number of packets transmitted on the Ethernet connection
Ethernet Rx Bytes	Number of bytes received on the Ethernet connection
Ethernet Tx Bytes	Number of bytes transmitted on the Ethernet connection

You can click **Refresh** to display up-to-date information.

END OF STEPS

8.8 Viewing WAN status

1

Click **Status**→**WAN Status** from the left pane in the 10G PON Home Gateway page. The WAN Status page displays the following information.

Figure 8-4 WAN Status page

Table 8-3 WAN Status parameters

Field	Description
WAN Connection List	Drop-down menu listing all WAN connections. The connection shown is the connection for which WAN status will be shown.
Access Type	Indicated the access type
Connection Mode	Connection mode of the WAN connection
Enable/Disable	Select this checkbox to enable or disable the WAN connection
VLAN	VLAN ID
WAN Link Status	Indicates whether the WAN link is up or down
IPv4 Address	IP Address of the ONT
Netmask	Network mask
Gateway	Gateway address

Table 8-3 WAN Status parameters (continued)

Field	Description
Primary DNS	Primary Domain Name Server
Second DNS	Secondary Domain Name Server
Manual DNS	Manual Domain Name Server
PON Link Status	Whether the PON link is up or down
Tx Packets	Number of packets transmitted on the WAN connection
Rx Packets	Number of packets received on the WAN connection
Tx Dropped	Number of packets dropped on the transmit WAN connection
Rx Dropped	Number of packets dropped on the receive WAN connection
Err Packets	Number of errored packets on the WAN connection

You can click **Refresh** to display up-to-date information.

END OF STEPS

8.9 Viewing WAN IPv6 status

1

Click **Status**→**WAN Status IPv6** from the left pane in the 10G PON Home Gateway page. The WAN Status IPv6 page displays the following information.

Figure 8-5 WAN Status IPv6 page

Table 8-4 WAN Status IPv6 parameters

Field	Description
WAN Connection List	Drop-down menu listing all WAN connections. The connection shown is the connection for which WAN status will be shown.
Enable/Disable	Select this checkbox to enable the WAN connection
VLAN	VLAN ID
WAN Link Status	Whether the WAN link is up or down
IPv6 Address	IPv6 address that identifies the device and its location
IPv6 Prefix	IPv6 prefix
IPv6 Gateway	IPv6 gateway address
Primary DNS	Primary Domain Name Server
Second DNS	Secondary Domain Name Server

Table 8-4 WAN Status IPv6 parameters (continued)

Field	Description
PON Link Status	Whether the PON link is up or down
Tx Packets	Number of packets transmitted on the WAN connection
Rx Packets	Number of packets received on the WAN connection
Tx Dropped	Number of packets dropped on the transmit WAN connection
Rx Dropped	Number of packets dropped on the receive WAN connection
Err Packets	Number of errored packets on the WAN connection

You can click **Refresh** to display up-to-date information.

END OF STEPS

8.10 Viewing STA information

1

Click **Status**→**STA Information** from the left pane in the 10G PON Home Gateway page. The STA Information page displays the following information.

Figure 8-6 STA Information page

10G PON Home Gateway Logout

Status > STA Information

Client Device Refresh

MAC ADDRESS	SSID NAME	CHANNEL	CONNECTION DURATION	REAL-TIME SENDING RATE (MBITS/S)	REAL-TIME RECEIVING RATE (MBITS/S)	WI-FI MODE	RSSI (DBM)

Table 8-5 STA information parameters

Field	Description
MAC ADDRESS	MAC address of the Ethernet connection
SSID NAME	Name of each SSID
CHANNEL	Indicates the channel number
CONNECTION DURATION	Indicates the connection duration
REAL-TIME SENDING RATE (MBITS/S)	Indicates the real time sending rate of packets
REAL-TIME RECEIVING RATE (MBITS/S)	Indicates the real time receiving rate of packets
WI-FI MODE	Indicates the Wi-Fi mode
RSSI (DBM)	Indicates the received signal strength

You can click **Refresh** to display up-to-date information.

END OF STEPS

8.11 Viewing Neighboring Access Points

1

Click **Status**→**Neighboring AP** from the left pane in the 10G PON Home Gateway page. The Neighboring Access Points page displays the following information.

Figure 8-7 Neighboring AP page

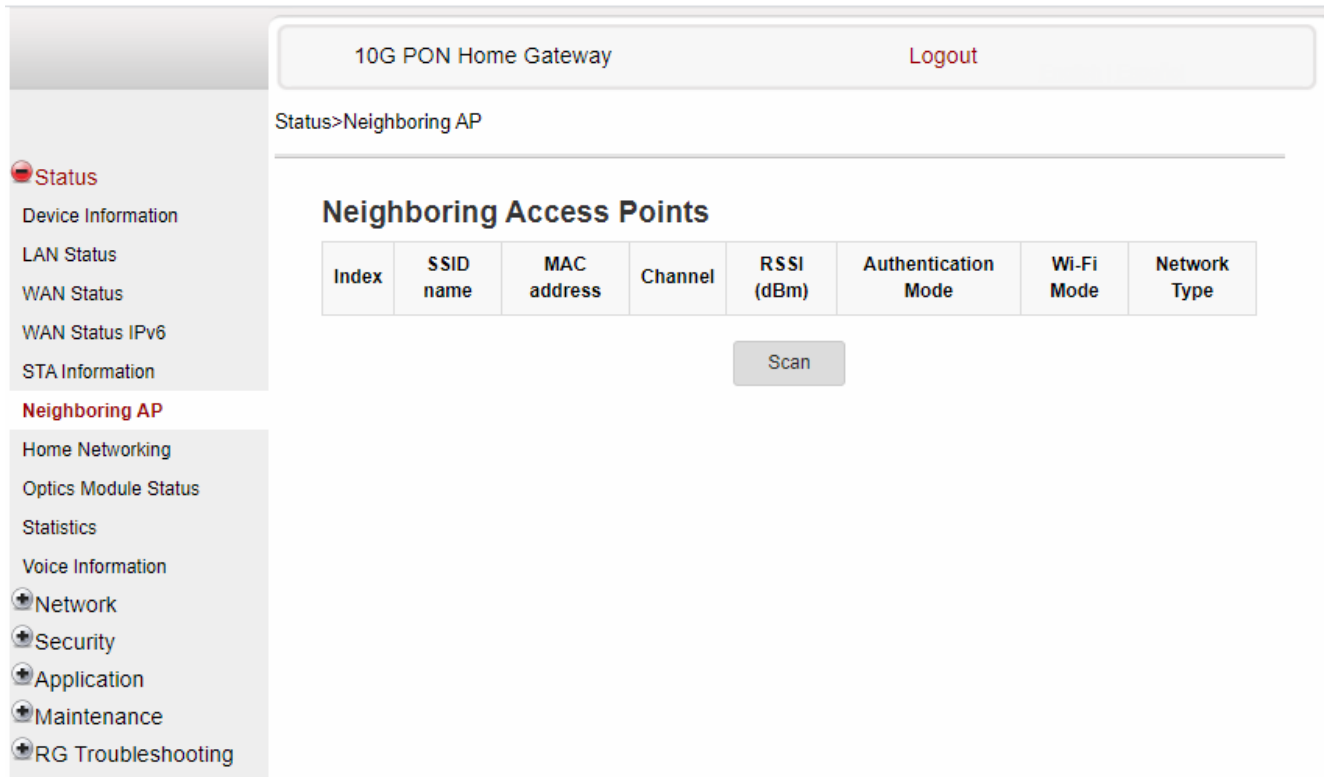

Table 8-6 Neighboring AP parameters

Field	Description
Index	Name of the index
SSID name	Name of each SSID
MAC address	MAC address of the Ethernet connection
Channel	Indicates the channel number
RSSI (DBM)	Indicates the received signal strength
Authentication Mode	Indicates the authentication mode

Table 8-6 Neighboring AP parameters (continued)

Field	Description
Wi-Fi Mode	Indicates the Wi-Fi mode
Network Type	Indicates the network type

2

Click **Scan**.

END OF STEPS

8.12 Viewing home networking information

1

Click **Status**→**Home Networking** from the left pane in the 10G PON Home Gateway page.
The Home Networking page displays the following information.

Figure 8-8 Home Networking page

10G PON Home Gateway
Logout

Status>Home Networking

Status

- Device Information
- LAN Status
- WAN Status
- WAN Status IPv6
- STA Information
- Neighboring AP
- Home Networking**
- Optics Module Status
- Statistics
- Voice Information
- Network**
- Security**
- Application**
- Maintenance**
- RG Troubleshooting**

Local Interface

Connection Type	Connected Devices	Setting
Ethernet	1	
Wireless (2.4GHz)	0	Setting
Wireless (5GHz)	0	Setting

Wireless Settings (2.4GHz)

Network Name	ALHN-A109	ALHN-A109-2	ALHN-A109-3	ALHN-A109-4
Access Point	00:11:20:20:10:12	02:11:20:10:10:12	02:11:20:20:10:12	02:11:20:30:10:12

Wireless Settings (5GHz)

Network Name	ALHN-A109-5	ALHN-A109-6	ALHN-A109-7	ALHN-A109-8
Access Point	00:11:20:20:10:16	02:11:20:10:10:16	02:11:20:20:10:16	02:11:20:30:10:16

Local Devices

Status	Connection Type	Device Name	IPv4 Address	Hardware Address	IP Address Allocation	Lease Remaining
Active	Ethernet	mxy-PC	192.168.1.64	2c:53:4a:02:59:11	DHCP	23 hours 50 min 37 sec

Routing Domain Details

Domain Name	WAN Name	No of IP	IP Range	LAN List	Delete
Refresh					

Table 8-7 Home Networking parameters

Field	Description
Local Interface	
Ethernet	Table displays the number of Ethernet connections and their settings

Table 8-7 Home Networking parameters (continued)

Field	Description
Wireless	Table displays the number of wireless connections and their settings (2.4GHz and 5GHz)
Wireless Settings (2.4GHz and 5GHz)	
Network Name	Name of the wireless network
Access Point	Hexadecimal address of the wireless access point
Local Devices	
Table entry	Each entry indicates the status (active or inactive), connection type, device name, IP address, hardware address, IP address allocation, lease remaining, and last active time of each connected local device.

You can:

- Click **Delete** to delete a particular local device connection.
- Click **Refresh** to display up-to-date information.

END OF STEPS

8.13 Viewing optics module status

1

Click **Status**→**Optics Module Status** from the left pane in the 10G PON Home Gateway page. The Optics Module Status page displays the following information.

Figure 8-9 Optics Module Status page

The screenshot shows the '10G PON Home Gateway' interface with a 'Logout' button. The left navigation pane includes 'Status' (selected), 'Device Information', 'LAN Status', 'WAN Status', 'WAN Status IPv6', 'STA Information', 'Neighboring AP', 'Home Networking', 'Optics Module Status', 'Statistics', 'Voice Information', 'Network', 'Security', 'Application', 'Maintenance', and 'RG Troubleshooting'. The main content area displays 'Status>Optics Module Status' with the following data:

Serial Number	ALCL2426A109
Laser Bias Current (ONT ANI-ONT-Side Optical Measurements):	33450 uA
Optics Module Voltage (ONT ANI-ONT-Side Optical Measurements):	3311000 uV
Optics Module Temperature (ONT ANI-ONT-Side Optical Measurements):	48.40 °C
Rx Optics Signal Level at 1577 nm (ONT ANI-ONT-Side Optical Measurements):	-17.36 dBm
Tx Optics Signal Level at 1270 nm (ONT ANI-ONT-Side Optical Measurements):	6.02 dBm
Lower (ONT ANI-ONT-Side Optical Measurements-Optical Threshold):	-27.95 dBm
Upper (ONT ANI-ONT-Side Optical Measurements-Optical Threshold):	-7.00 dBm

A 'Refresh' button is located at the bottom of the data table.

Table 8-8 Optics Module Status parameters

Field	Description
Serial Number	Serial number of the ONT
Laser Bias Current (ONT ANI-ONT-Side Optical Measurements)	Laser bias current, measured in uA
Optics Module Voltage (ONT ANI-ONT-Side Optical Measurements)	Optics module voltage, measured in V
Optics Module Temperature (ONT ANI-ONT-Side Optical Measurements)	Optics module temperature, measured in C
Rx Optics Signal Level at 1577 nm (ONT ANI-ONT-Side Optical Measurements)	Received optics signal level at 1577 nm, measured in dBm
Tx Optics Signal Level at 1270nm (ONT ANI-ONT-Side Optical Measurements)	Transmitted optics signal level at 1270 nm, measured in dBm
Lower (ONT ANI-ONT-Side Optical Measurements-Optical Threshold)	Lower optical threshold, measured in dBm
Upper (ONT ANI-ONT-Side Optical Measurements-Optical Threshold)	Upper optical threshold, measured in dBm

You can click **Refresh** to display up-to-date information.

END OF STEPS

8.14 Viewing statistics

1

Click **Status**→**Statistics** from the left pane in the 10G PON Home Gateway page.
Select the **LAN** tab, **WAN** tab or **WLAN** tab to view the respective ports.

Figure 8-10 LAN Statistics page

10G PON Home Gateway Logout

Status>Statistics

LAN **WAN** WLAN

Refresh

COUNTERS	LAN1	LAN2	LAN3	LAN4
Bytes Sent	376629	0	57368	57168
Bytes Received	244020	0	0	0
Packets Sent	916	0	492	489
Packets Received	2177	0	0	0
Errors Sent	0	0	0	0
Unicast Packets Sent	887	0	0	0
Unicast Packets Received	1248	0	0	0
Discard Packets Sent	0	0	0	0
Discard Packets Received	0	0	0	0
Multicast Packets Sent	24	0	283	281
Multicast Packets Received	617	0	0	0
Broadcast Packets Sent	5	0	209	208
Broadcast Packets Received	312	0	0	0
Unknown Proto Packets Received	0	0	0	0
CRC Error Received	0	0	0	0

Figure 8-11 WAN Statistics page

10G PON Home Gateway Logout

Status>Statistics

Status

- Device Information
- LAN Status
- WAN Status
- WAN Status IPv6
- STA Information
- Neighboring AP
- Home Networking
- Optics Module Status
- Statistics**
- Voice Information
- Network
- Security
- Application
- Maintenance
- RG Troubleshooting

COUNTERS	1_VOIP_TR069_INTERNET_R_VID_881	2_INTERNET_R_VID_1081	3_OTHER_R_VID
Bytes Sent	169350	43822	47254
Bytes Received	23874	0	0
Packets Sent	2004	145	156
Packets Received	413	0	0
Errors Sent	0	0	0
Errors Received	0	0	0
Unicast Packets Sent	2004	145	156
Unicast Packets Received	413	0	0
Discard Packets Sent	0	0	0
Discard Packets Received	0	0	0
Broadcast Packets Sent	0	0	0
Broadcast Packets Received	0	0	0

Figure 8-12 WLAN Statistics page

10G PON Home Gateway Logout

Status > Statistics

LAN WAN WLAN Refresh

COUNTERS	2.4GHZ ALHN-A109	5GHZ ALHN-A109-5
Bytes Sent	0	0
Bytes Received	0	0
Packets Sent	0	0
Packets Received	0	0
Errors Sent	0	0
Discard Packets Sent	0	0
Discard Packets Received	0	0
Rx Drops	0	0
Tx Drops	0	0

You can click **Refresh** to display up-to-date information.

END OF STEPS

8.15 Viewing voice information

1

Click **Status**→**Voice Information** from the left pane in the 10G PON Home Gateway page. The Voice Information page displays the following information:

Figure 8-13 Voice Information page

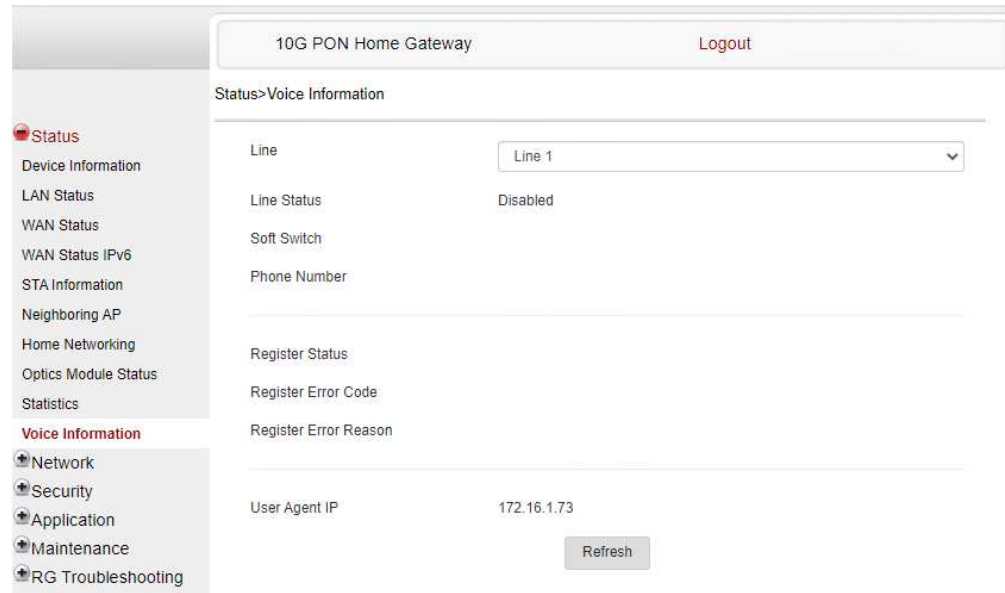

Table 8-9 Voice Information parameters

Field	Description
Line	Select a line from the list. The default is Line 1.
Line Status	Depending on the line chosen, the line options are: <ul style="list-style-type: none"> • Up • Initializing • Registering • Unregistering • Error • Testing • Quiescent • Disabled The default is Disabled
Soft Switch	Proxy IP address; blank if the line is not registered
Phone number	Phone number configured for a telephone line 1; +13290611266
Register Status	The default is Registered Blank if no voice service is provisioned
Register Error Code	SIP standard error code for the register status; for example, 401, 403, 503 This field is blank if the register is set to OK

Table 8-9 Voice Information parameters (continued)

Field	Description
Register Error Reason	SIP standard error reason for the register status This field is blank if the register is set to OK
User Agent IP	IP address of the user agent ExternalIPAddress in WANIPConnection or WANPPPConnection

You can click **Refresh** to display up-to-date information.

END OF STEPS

Network configuration

8.16 Overview

8.16.1 Purpose

This chapter describes the network configuration tasks supported by XS-2426G-A ONTs.

8.16.2 Contents

8.16 Overview	97
8.17 Configuring LAN	97
8.18 Configuring LAN IPv6	99
8.19 Configuring WAN	101
8.20 Configuring WAN DHCP	103
8.21 Configuring Wireless 2.4GHz	104
8.22 Configuring Wireless 5GHz	107
8.23 Configuring wireless scheduling	110
8.24 Configuring IP routing	111
8.25 Configuring DNS	113
8.26 Configuring TR-069	114
8.27 Configuring GRE tunnel	115
8.28 Configuring Upstream (US) Classifier	117
8.29 Configuring QoS	121

8.17 Configuring LAN

1

Click **Network**→**LAN** from the left pane in the 10G PON Home Gateway page. The LAN page displays.

Figure 8-14 LAN page

10G PON Home Gateway
Logout

Network>LAN

- Status
- Network
- LAN**
- LAN_IPv6
- WAN
- WAN DHCP
- Wireless (2.4GHz)
- Wireless (5GHz)
- Wireless Schedule
- IP Routing
- DNS
- TR-069
- GRE Tunnel
- US Classifier
- QoS Config
- Security
- Application
- Maintenance
- RG Troubleshooting

Port Mode

All Ports to Bridge Mode

Port1	Route Mode
Port2	Route Mode
Port3	Route Mode
Port4	Route Mode

IPv4 Address:

Subnet Mask:

DHCP Enable

DHCP Start IP Address:

DHCP End IP Address:

DHCP Lease Time:
(2~129600 mins, or 0 means 1 day)mins.

Primary DNS:

Secondary DNS:

Static DHCP Entry

MAC Address:

IPv4 Address:

MAC Address	IPv4 Address	Delete

2

Configure the following LAN parameters:

Table 8-10 LAN parameters

Field	Description
Port Mode	
All Ports to Bridge Mode	Select this checkbox to set all ports to Bridge mode.
Port 1 - 4	Select the port mode for each port and click Save . <ul style="list-style-type: none"> • Route Mode • Bridge Mode
IPv4 Address	Enter the IPv4 address of the ONT.
Subnet Mask	Enter the subnet mask of the ONT.
DHCP enable	Select this checkbox to enable DHCP.
DHCP Start IP Address	Enter the starting DHCP IP address.
DHCP End IP Address	Enter the ending DHCP IP address.
DHCP Lease Time	Enter the DHCP lease time (in min).
Primary DNS	Enter the primary DNS identifier.
Secondary DNS	Enter the secondary DNS identifier.
Static DHCP Entry	
MAC Address	Enter the MAC address of the static DHCP
IPv4 Address	Enter the IPv4 address for the static DHCP

3 _____
 Click **Save**.

4 _____
 Configure the Static DHCP parameters.

5 _____
 Click **Add**.
 You can click **Delete** to delete a Static DHCP MAC address or IPv4 address.

END OF STEPS _____

8.18 Configuring LAN IPv6

1 _____
 Click **Network**→**LAN_IPv6** from the left pane in the 10G PON Home Gateway page. The LAN_IPv6 page displays.

Figure 8-15 LAN IPv6 page

2

Configure the following parameters:

Table 8-11 LAN IPv6 parameters

Field	Description
IPv6 LAN Host Configuration	
DNS Server	Select a DNS server from the list.
Prefix Config	Select a prefix config option from the list: <ul style="list-style-type: none"> • WANConnection (prefix will be obtained from the WAN), or • Static (enables you to enter the prefix)
Interface	This field displays if you select the WanConnection option from the Prefix Config field. Select a WAN connection interface from the list.

Table 8-11 LAN IPv6 parameters (continued)

Field	Description
DHCPv6 Server Pool	
DHCP Start IP Address	Enter the starting DHCP IP address.
DHCP End IP Address	Enter the ending DHCP IP address.
Whether the address info through DCHP	Select this checkbox to enable address information retrieval through DHCP.
Whether other info obtained through DHCP	Select this checkbox to enable retrieval of other information through DHCP.
Maximum interval for periodic RA messages	Enter the maximum interval (in seconds) for periodic Router Advertisement messages. The interval range is from 4 to 1800.
Minimum interval for periodic RA messages	Enter the minimum interval (in seconds) for periodic Router Advertisement messages. The interval range is from 4 to 1800.

3

Click **Save/Apply**.

END OF STEPS

8.19 Configuring WAN

1

Click **Network**→**WAN** from the left pane in the 10G PON Home Gateway page. The WAN page displays.

Figure 8-16 WAN page

10G PON Home Gateway Logout

Network>WAN

WAN Connection List: 1_VOIP_TR069_INTERNET_R_VID_881

Connection Type: IPoE PPPoE

IP mode: IPv4

Enable/Disable:

NAT:

Service: VOIP TR-069 INTERNET IPTV

Enable VLAN:

VLAN ID: 881

VLAN PRI: 0

WAN IP Mode: DHCP

Manual DNS:

Save Delete

2

Configure the following parameters:

Table 8-12 WAN parameters

Field	Description
WAN Connection List	Select a WAN connection from the list to set the connection parameters.
Connection Type	Select a connection type: IPoE or PPPoE.
IP mode	Select an IP mode from the list: IPv4 or IPv6.
Enable/Disable	Select this checkbox to enable the WAN connection.
NAT	Select this checkbox to enable NAT.
Service	Select the checkboxes to enable the following service types for this connection. <ul style="list-style-type: none"> • VOIP • TR-069 • INTERNET • IPTV
Enable VLAN	Select this checkbox to enable VLAN.
VLAN ID	Enter the VLAN ID.

Table 8-12 WAN parameters (continued)

Field	Description
VLAN PRI	Enter the VLAN PRI.
WAN IP Mode	Select an IP mode from the list.
Manual DNS	Enter the manual Domain Name Server.

3

Click **Save**.

END OF STEPS

8.20 Configuring WAN DHCP

1

Click **Network**→**WAN DHCP** from the left pane in the 10G PON Home Gateway page. The WAN DHCP page displays.

Figure 8-17 WAN DHCP page

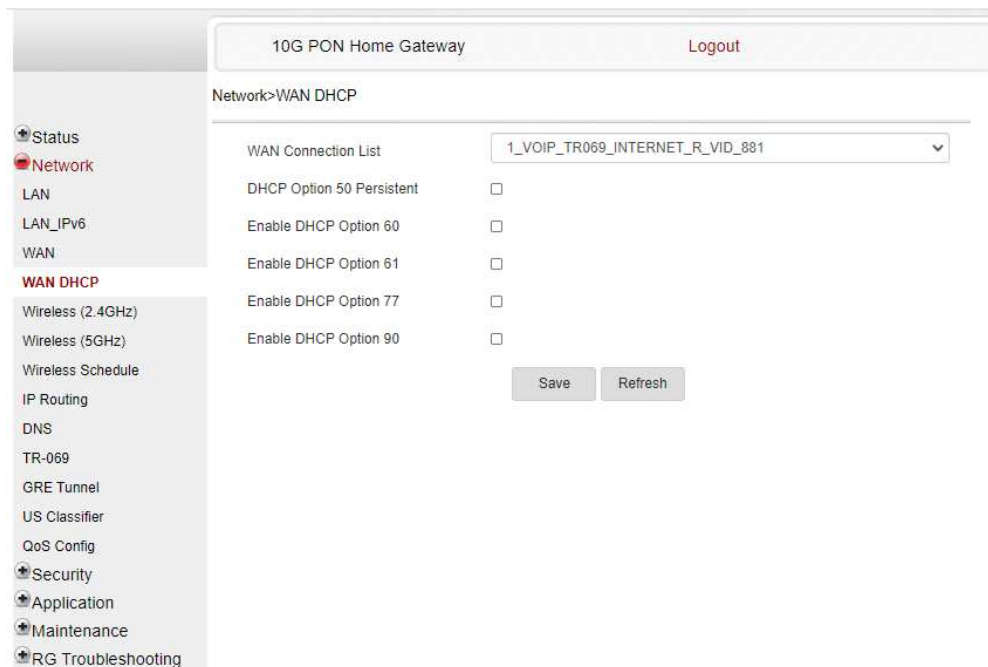

2

Configure the following parameters:

Table 8-13 WAN DHCP parameters

Field	Description
WAN Connection List	Select a WAN connection from the list.
DHCP Option 50 Persistent	Select this checkbox to enable DHCP Option 50 persistent.
Enable DHCP Option 60	Select this checkbox to enable DHCP Option 60 (vendor class identifier).
Enable DHCP Option 61	Select this checkbox to enable DHCP Option 61 (client identifier).
Enable DHCP Option 77	Select this checkbox to enable DHCP Option 77 (user class information).
Enable DHCP Option 90	Select this checkbox to enable DHCP Option 90 (authentication information).

3

Click **Save**.You can click **Refresh** to update displayed information.

END OF STEPS

8.21 Configuring Wireless 2.4GHz

1

Click **Network**→**Wireless (2.4GHz)** from the left pane in the 10G PON Home Gateway page. The Wireless (2.4GHz) page displays.

Figure 8-18 Wireless (2.4GHz) page

10G PON Home Gateway Logout

Network>Wireless (2.4GHz)

Enable

Mode: b/g/n

Bandwidth: 20MHz

Channel: Auto

Transmitting Power: 100%

WMM: Enable

Enable MU-MIMO: Disable

Total MAX Users: 64

SSID Configuration

SSID Select: SSID1

SSID Name: ALHN-A109

Enable SSID: Enable

SSID Broadcast: Enable

Port Mode: Route

Isolation: Disable

MAX Users: 64

Encryption Mode: WPA/WPA2 Personal

WPA Version: WPA/WPA2

WPA Encryption Mode: TKIP/AES

WPA Key:

Show password

Enable WPS: Disable

Domain Grouping: Enable

Save Refresh

2

Configure the following parameters:

Table 8-14 Wireless (2.4GHz) parameters

Field	Description
Enable	Select this checkbox to enable Wi-Fi.
Mode	Select a Wi-Fi mode from the list: <ul style="list-style-type: none"> • auto (b/g/n/ax) • b • g • b/g • n/g • ax/g
Bandwidth	Select the bandwidth range from the list: <ul style="list-style-type: none"> • 20 MHz • 40 MHz • 20/40 MHz
Channel	Select a channel from the list or select Auto to have the channel automatically assigned.
Transmitting Power	Select a percentage for the transmitting power from the list: <ul style="list-style-type: none"> • Low (25%) • Medium (50%) • High (75%) • Maximum (100%)
WMM	Select Enable or Disable from the list to enable or disable WiFi multimedia.
Enable MU-MIMO	Select Enable or Disable from the list to enable or disable MU-MIMO.
Total MAX Users	Enter the number of total MAX users.
SSID Configuration	
SSID Select	Select the SSID from the list.
SSID Name	Enter the SSID name.
Enable SSID	Select Enable or Disable from this list.
SSID Broadcast	Select Enable or Disable from this list.
Port Mode	Select a port mode from the list. The default value is Route..
Isolation	Select Enable or Disable from this list.
MAX Users	Enter the number of MAX users.

Table 8-14 Wireless (2.4GHz) parameters (continued)

Field	Description
Encryption Mode	Select an encryption mode from the list: <ul style="list-style-type: none">• OPEN• WEP• WPA/WPA2 Personal• WPA/WPA2 Enterprise• WPA2/WPA3 Personal• WPA2/WPA3 Personal
WPA Version	Select a WPA version from the list: <ul style="list-style-type: none">• WPA2/WPA3• WPA2• WPA/WPA2
WPA Encryption Mode	Select a WPA encryption mode from the list: <ul style="list-style-type: none">• TKIP• AES• TKIP/AES
WPA Key	Enter the WPA key.
Enable WPS	Select Enable or Disable from this list.
Domain Grouping	Select this checkbox to enable domain grouping

3

Click **Save**.

You can click **Refresh** to update displayed information.

END OF STEPS

8.22 Configuring Wireless 5GHz

1

Click **Network**→**Wireless (5GHz)** from the left pane in the 10G PON Home Gateway page. The Wireless (5GHz) page displays.

Figure 8-19 Wireless (5GHz) page

10G PON Home Gateway
Logout

Network > Wireless (5GHz)

- Status
- Network
- LAN
- LAN_IPv6
- WAN
- WAN DHCP
- Wireless (2.4GHz)
- Wireless (5GHz)
- Wireless Schedule
- IP Routing
- DNS
- TR-069
- GRE Tunnel
- US Classifier
- QoS Config
- Security
- Application
- Maintenance
- RG Troubleshooting

Enable

Bandwidth

Channel

Transmitting Power

WMM

Enable MU-MIMO

Total MAX Users

SSID Configuration

SSID Select

SSID Name

Enable SSID

SSID Broadcast

Port Mode

Isolation

MAX Users

Encryption Mode

WPA Key

Show password

Enable WPS

Domain Grouping Enable

2

Configure the following parameters:

Table 8-15 Wireless (5GHz) parameters

Field	Description
Enable	Select this checkbox to enable Wi-Fi.

Table 8-15 Wireless (5GHz) parameters (continued)

Field	Description
Bandwidth	Select the bandwidth range from the list: <ul style="list-style-type: none"> • 20 MHz • 40 MHz • 80 MHz
Channel	Select a channel from the list or select Auto to have the channel automatically assigned.
Transmitting Power	Select a percentage for the transmitting power from the list: <ul style="list-style-type: none"> • Low (25%) • Medium (50%) • High (75%) • Maximum (100%)
WMM	Select Enable or Disable from the list to enable or disable WiFi multimedia.
Enable MU-MIMO	Select Enable or Disable from the list to enable or disable MU-MIMO.
Enable MU-MIMO	Select Enable or Disable from the list to enable or disable MU-MIMO.
Enable MU-MIMO	Select Enable or Disable from the list to enable or disable MU-MIMO.
Total MAX Users	Enter the total number of MAX users.
SSID Configuration	
SSID Select	Select the SSID from the list.
SSID Name	Enter the SSID name
Enable SSID	Select Enable or Disable from this list.
SSID Broadcast	Select Enable or Disable SSID broadcast from this list.
Port Mode	Select a port mode from the list. The default value is Route.
MAX Users	Enter the number of MAX users.
Encryption Mode	Select an encryption mode from the list: <ul style="list-style-type: none"> • None • OPEN • WPA2-AES • WPA2+WPA • WPA3-AES • WPA2+WPA3-AES • WPA • WPA2-Enterprise
WPA Key	Enter the WPA key.
Enable WPS	Select Enable or Disable from this list.
Domain Grouping	Select this checkbox to enable domain grouping

3

Click **Save**.

You can click **Refresh** to update displayed information.

END OF STEPS

8.23 Configuring wireless scheduling

1

Click **Network**→**Wireless Schedule** from the left pane in the 10G PON Home Gateway page. The Wireless Schedule page displays.

Figure 8-20 Wireless Schedule page

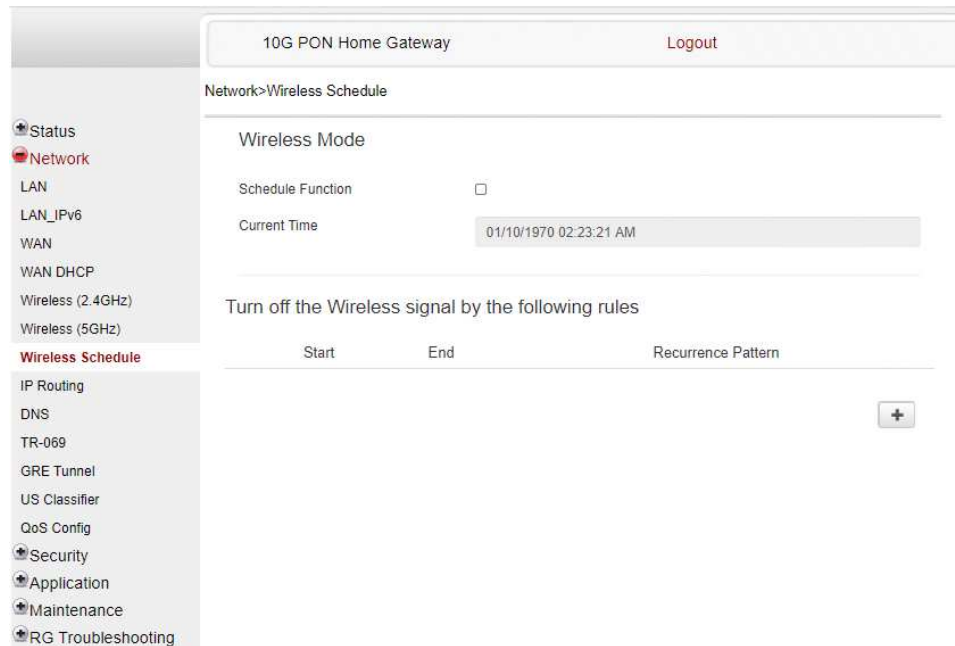

2

Select the **Schedule Function** checkbox to turn the wireless signal off for the configured period.

3

Click the plus sign (+) to add a scheduling rule.

A separate panel displays for configuring wireless schedule rules.

4 _____
Enter a start time and end time for the period in which you want the wireless signal off.

5 _____
Select **Everyday** or **Individual Days** from the list.

6 _____
If you select **Individual Days**, select the checkboxes for the desired days.
The Recurrence Pattern shows the rules created to date.

7 _____
If desired, click the plus sign (+) to add more rules.

8 _____
Click **Save Changes**.

END OF STEPS _____

8.24 Configuring IP routing

1 _____
Click **Network**→**IP Routing** from the left pane in the 10G PON Home Gateway page. The IP Routing page displays.

Figure 8-21 IP Routing page

10G PON Home Gateway Logout

Network>IP Routing

Enable Routing

Destination IP Address

Destination Netmask

Gateway

IPv4 Interface

Forwarding Policy Help

rotocol xclude	Source Port	Source Max	SExclude	Dest Port	Dest Max	DExclude	Source IP	Source IP Mask	SExclude	Dest IP	Dest IP Mask	DExclude	Interface	Forward Policy
Add														

IP Routing Table

Destination IP Address	Destination Netmask	Gateway	Interface	Forwarding Policy	Enable	Delete
192.168.30.0	255.255.255.0	100.1.1.1	1_VOIP_TR069_INTERNET_R_VID_881	-1	TRUE	Delete

Refresh

2

Configure the following parameters:

Table 8-16 IP Routing parameters

Field	Description
Enable Routing	Select this checkbox to enable routing.
Destination IP Address	Enter the destination IP address.
Destination Netmask	Enter the destination network mask.
Gateway	Enter the gateway address.
IPv4 Interface	Select a WAN connection previously created in the WAN network page from the list.
Forwarding Policy	Select a forwarding policy from the list.

3

Click **Add**.

You can click **Delete** to delete a particular IP routing entry.

You can click **Refresh** to update the displayed information.

END OF STEPS

8.25 Configuring DNS

1

Click **Network**→**DNS** from the left pane in the 10G PON Home Gateway page. The DNS page displays.

Figure 8-22 DNS page

2

Configure the following parameters:

Table 8-17 DNS parameters

Field	Description
DNS Proxy	Select the Enabled checkbox to enable DNS proxy and click Save .
Domain Name	Enter the domain name.
IPv4 Address	Enter the domain IP address and click Add .

Table 8-17 DNS parameters (continued)

Field	Description
Origin Domain	Enter the origin domain name.
New Domain	Associate an origin domain with a new domain and click Add .

You can click **Delete** to delete a particular Domain Name.

You can click **Refresh** to update the displayed information.

END OF STEPS

8.26 Configuring TR-069

1

Click **Network**→**TR-069** from the left pane in the 10G PON Home Gateway page. The TR-069 page displays.

Figure 8-23 TR-069 page

The screenshot shows the configuration page for TR-069 in the 10G PON Home Gateway interface. The page title is "10G PON Home Gateway" with a "Logout" link. The left navigation pane includes sections for Status, Network, Security, Application, Maintenance, and RG Troubleshooting. The main content area is titled "Network>TR-069" and contains the following configuration fields:

- Periodic Inform Enable:
- Periodic Inform Interval(s):
- URL:
- Username:
- Password:
- Connect Request Username:
- Connect Request Password:

At the bottom of the configuration area, there are two buttons: "Save" and "Refresh".

2

Configure the following parameters:

Table 8-18 TR-069 parameters

Field	Description
Periodic Inform Enable	Select this checkbox to enable periodic inform updates.
Periodic Inform Interval(s)	Enter the time between periodic inform updates, in seconds.
URL	Enter the URL of the auto-configuration server.
Username	Enter the username used to log in to the auto-configuration server.
Password	Enter the password used to log in to the auto-configuration server.
Connect Request Username	Enter the username used to log in to the ONT.
Connect Request Password	Enter the password used to log in to the ONT.

3

Click **Save**.

You can click **Refresh** to update the displayed information.

END OF STEPS

8.27 Configuring GRE tunnel

i **Note:** This feature is available to admin users (super users) only.

1

Click **Network**→**GRE Tunnel** from the left pane in the 10G PON Home Gateway page. The GRE Tunnel page displays.

Figure 8-24 GRE Tunnel page

10G PON Home Gateway Logout

Network>GRE Tunnel

Tunnel Name: Create new GRE Tunnel

WAN Interface: 1_VOIP_TR069_INTERNET_R_VID_881

Primary Remote End: []

Secondary Remote End: []

Connected Remote End: []

Connectivity Check:

Traffic timeout to start pings: 10 (2 ~ 1024)seconds

No. of retries before unreachable: 3 (0 ~ 100)times

Save Delete

2

Configure the following parameters:

Table 8-19 GRE Tunnel parameters

Field	Description
Tunnel Name	Select Create new GRE Tunnel or select an existing tunnel from the list. The tunnel name is automatically assigned by the system. Up to 4 GRE tunnels are supported.
WAN Interface	Select a WAN interface from the list. GRE tunnels can only be created on HSI-enabled WAN interfaces.
Primary Remote End Secondary Remote End (optional)	Enter an IP address or FQDN that is unique in the system. If the primary remote endpoint is down or unreachable, the secondary remote endpoint becomes active, if configured. The secondary remote endpoint remains active until it becomes unreachable, in which case the primary remote endpoint becomes active again. Revertive mode is not supported. If both endpoints are unreachable, the GRE tunnel is declared down.
Connected Remote End	This field displays the current data traffic path for the GRE tunnel.
Connectivity check	This feature is automatically selected by the system.
Traffic timeout to start pings	Enter the traffic timeout in seconds (2 to 1024).
No. of retries before unreachable	Enter the number of retries before the tunnel is declared down (0 to 100).

3

Click **Save**.

You can click **Delete** to delete the entries.

END OF STEPS

8.28 Configuring Upstream (US) Classifier

The US Classifier feature is used to create policies, classifiers, and classifier rules for upstream traffic handling. This feature is available to admin users (super users) only.

A policy defines an action to be performed on a set of LAN or WAN packets. A policy can be created at any time and then subsequently assigned to one or more classifiers.

A classifier is used to select key fields for which the classifier rules will be written. A classifier can be created at any time and then subsequently assigned to one or more classifier rules.

A classifier rule is used to assign actions to a group of packets based on a set of parameters. A classification rule must be created against a pre-defined classifier.

Up to 16 policies can be created, with up to 8 classifiers and 32 classifier rules.

1

Click **Network**→**US Classifier** from the left pane in the 10G PON Home Gateway page, and select the **Policy** tab.

All classifier policies are displayed in the policy table in the page.

Figure 8-25 US Classifier Policy page

The screenshot shows the '10G PON Home Gateway' configuration page with the 'US Classifier' section selected. The 'Policy' tab is active, displaying configuration fields for a GRE tunnel. The fields include Tunnel Type (GRE), Tunnel Interface (No Tunnel), VLAN Id (0-4093), VLAN Tag (8100, hex), and VLAN Priority (0-7). The IP TOS / DSCP is set to 0 (0-63). There is a checkbox for 'Drop' which is currently unchecked. Below the fields are 'Save' and 'Reset' buttons. A table at the bottom shows the list of policies with columns: Name, Tunnel Type, Tunnel Interface, VLAN Id, VLAN Tag, VLAN Priority, IP TOS/DSCP, Drop, No. of Rules, and Delete. Below the table is a 'Refresh' button. The left sidebar contains navigation options: Status, Network (selected), LAN, LAN_IPv6, WAN, WAN DHCP, Wireless (2.4GHz), Wireless (5GHz), Wireless Schedule, IP Routing, DNS, TR-069, GRE Tunnel, US Classifier (selected), QoS Config, Security, Application, Maintenance, and RG Troubleshooting.

2

Configure the following parameters:

Table 8-20 US Classifier Policy parameters

Field	Description
Tunnel Type	The tunnel type is set to GRE and cannot be modified.
Tunnel Interface	Select a tunnel interface from the list: No Tunnel, GRE Tunnel, or LAN traffic.
VLAN ID	Enter a VLAN ID (0-4094).
VLAN Tag	This field is not configurable. The VLAN tag is set to 8100 (hexadecimal). Determines the VLAN tag used inside the GRE tunnel.
VLAN Priority	Enter a VLAN priority level (0 to 7). A lower number indicates a higher priority.
IP TOS/DSCP	This field is not configurable. All tunnel packets are generated with a default DSCP value (usually 0).
Drop	Select this checkbox to drop the packets.

3

Click **Save**.

You can click **Reset** to reset the configured values.

4

To delete a policy, click **Delete** for the applicable policy in the policy table.

A policy can only be deleted if it is not associated with any classifier rules.

You can click **Refresh** to update the displayed information.

5

Click **Network**→**US Classifier** from the left pane in the 10G PON Home Gateway page, and select the **Classifier** tab.

All classifiers are displayed in the classifier table in the page.

Figure 8-26 US Classifier page

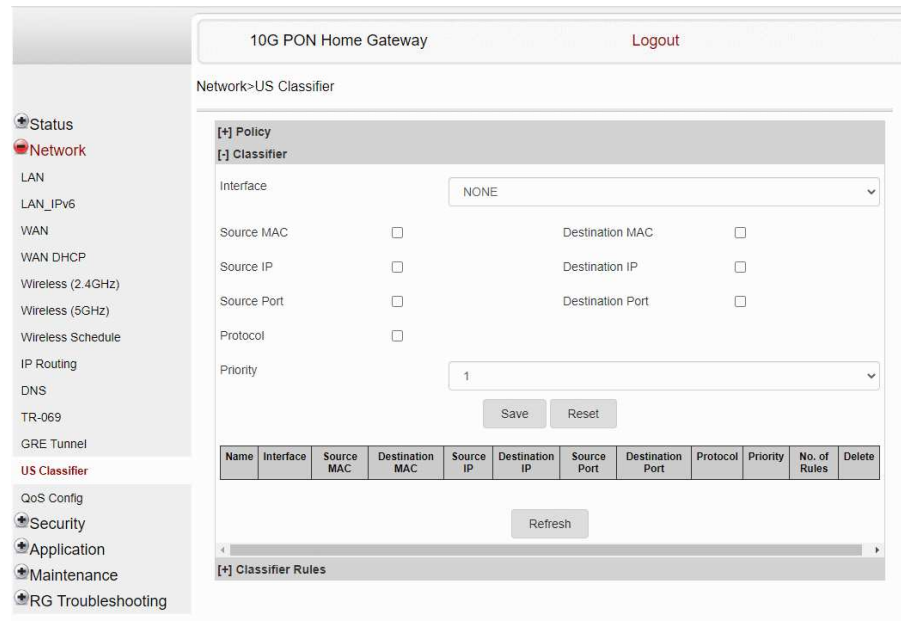

6

Configure the following parameters:

At least one field must be selected to create a classifier. A maximum of four fields may be selected to create a classifier; this includes the interface field.

Table 8-21 US Classifier parameters

Field	Description
Interface	Select an interface from the list; for example, None, LAN, 2.4G SSID, or 5G SSID. The option None indicates that all interfaces are selected.
Source MAC	Click to enter a source MAC address.
Destination MAC	Click to enter a destination MAC address.
Source IP	Click to enter a source IP address.
Destination IP	Click to enter a destination IP address.
Source Port	Click to enter a source port.
Destination Port	Click to enter a destination port.
Protocol	Click to enter a protocol.
Priority	Select a priority level from 1 to 8. The lower the number, the higher the priority. No more than 1 classifier can be created with the same priority.

7

Click **Save**.

You can click **Reset** to reset the configured values.

8

To delete a classifier, click **Delete** for the applicable classifier in the classifier table.

A classifier can only be deleted if it is not associated with any classifier rules.

You can click **Refresh** to update the displayed information.

9

Select the **Classifier Rules** tab.

All classifier rules are displayed in the classifier rules table in the page.

Figure 8-27 US Classifier Rules page

10G PON Home Gateway Logout

Network>US Classifier

[+] Policy
[+] Classifier
[-] Classifier Rules

Policy Classifier

Interface

Source MAC Destination MAC

Source IP Destination IP

Source Port Destination Port

IP Protocol Type
(0 - 254)

Name	Interface	Source MAC	Destination MAC	Source IP	Destination IP	Source Port	Destination Port	IP Protocol	Policy	Classifier	Delete
<input type="button" value="Refresh"/>											

10

Configure the following parameters:

Table 8-22 US Classifier Rules parameters

Field	Description
Policy	Select a policy from the list.
Classifier	Select a classifier from the list.
Interface	Select an interface from the list; for example, None, LAN, 2.4G SSID, 5G SSID.
Source MAC	Enter a source MAC address.
Destination MAC	Enter a destination MAC address.
Source IP	Enter a source IP address.
Destination IP	Enter a destination IP address.
Source Port	Enter a source port.
Destination Port	Enter a destination port.
IP Protocol Type	Enter a value between 0 and 254.

11

Click **Save**.

You can click **Reset** to reset the configured values.

12

To delete a classifier rule, click **Delete** for the applicable classifier rule in the classifier rules table.

You can click **Refresh** to update the displayed information.

END OF STEPS

8.29 Configuring QoS

1

Click **Network**→**QoS Config** from the left pane in the 10G PON Home Gateway page. The QoS Config page displays.

Figure 8-28 QoS Config page (L2 packet sizes)

10G PON Home Gateway
Logout

Network>QoS Config

- Status
- Network
- LAN
- LAN_IPv6
- WAN
- WAN DHCP
- Wireless (2.4GHz)
- Wireless (5GHz)
- Wireless Schedule
- IP Routing
- DNS
- TR-069
- GRE Tunnel
- US Classifier
- QoS Config
- Security
- Application
- Maintenance
- RG Troubleshooting

QoS Setting

ID	Source MAC	Source MAC Exclude	Protocol	Protocol Exclude	Source Port	Source Max	SExclude	Dest Port	Dest Max	DExclude
<div style="display: flex; justify-content: space-between; align-items: center;"> <div style="margin-right: 20px;"> <p>Type: L2 Criteria</p> <p>Classification Criteria</p> <p>Source MAC: <input style="width: 100px;" type="text"/> Exclude <input type="checkbox"/></p> <p>Interface: select an option</p> </div> <div> <p>Classification Result</p> <p>DSCP Remark: <input style="width: 100px;" type="text"/> 802.1p Remark: <input style="width: 100px;" type="text"/></p> <p style="font-size: small;">(Range:0~63) (Range:0~7)</p> <p>Forwarding Policy: <input style="width: 100px;" type="text"/></p> <p style="font-size: small;">(Range:1~7)</p> </div> </div> <div style="text-align: right; margin-top: 10px;"> <input type="button" value="Add"/> </div>										

Figure 8-29 QoS Config page (L3 packet sizes)

10G PON Home Gateway
Logout

Network > QoS Config

- Status
- Network
- LAN
- LAN_IPv6
- WAN
- WAN DHCP
- Wireless (2.4GHz)
- Wireless (5GHz)
- Wireless Schedule
- IP Routing
- DNS
- TR-069
- GRE Tunnel
- US Classifier
- QoS Config
- Security
- Application
- Maintenance
- RG Troubleshooting

QoS Setting

ID	Source MAC	Source MAC Exclude	Protocol	Protocol Exclude	Source Port	Source Max	SExclude	Dest Port	Dest Max	DExclude
<div style="display: flex; justify-content: space-between; align-items: center;"> Type L3 Criteria </div> <p>Classification Criteria</p> <div style="display: flex; justify-content: space-between;"> <div> <p>Protocol: None <input type="checkbox"/> Exclude</p> <p>Application: Customer setting</p> <p>Source Ip: <input type="text"/> Source Ip Mask: <input type="text"/> <input type="checkbox"/> Exclude</p> <p>Dest Ip: <input type="text"/> Dest Ip Mask: <input type="text"/> <input type="checkbox"/> Exclude</p> <p>Source Port: <input type="text"/> Source Port Max: <input type="text"/> <input type="checkbox"/> Exclude</p> <p>Dest Port: <input type="text"/> Dest Port Max: <input type="text"/> <input type="checkbox"/> Exclude</p> <p>802.1p: <input type="text"/> (Range: 0~7)</p> <p>Interface: select an option</p> </div> <div> <p>Classification Result</p> <p>DSCP Remark: <input type="text"/> (Range: 0~63)</p> <p>802.1p Remark: <input type="text"/> (Range: 0~7)</p> <p>Forwarding Policy: <input type="text"/> (Range: 1~7)</p> </div> </div> <div style="text-align: right; margin-top: 5px;"> <input type="button" value="Add"/> </div>										

2

Configure the following parameters:

Table 8-23 QoS Config parameters

Field	Description
QoS Setting	
Type	Select a QoS service layer type from the list L2 Criteria or L3 Criteria .
Classification Criteria	
Source MAC	Enter the source MAC address. Select the Exclude checkbox to exclude the source MAC address.
Interface	Select an interface from the list.
Classification Result	
DSCP Remark	Enter the value for the DSCP mark (range: 0-63); valid only for L3 Criteria.
802.1p Remark	Enter the value for the 802.1p (range: 0-7).
Forwarding Policy	Enter the number for the forwarding policy (range: 1-7).
Additional fields for L3 Criteria	
Protocol	Select a protocol from the list, or select the Exclude checkbox.
Application	Select an application from the list.
Source IP and Source IP Mask	Enter the values for the source IP and IP mask, or select the Exclude checkbox.
Destination IP and Destination IP Mask	Enter the values for the destination IP and IP mask, or select the Exclude checkbox.
Source Port and Source Port Max	Enter the values for the source port and port max (highest port number) or select the Exclude checkbox.
Destination Port and Destination Port Max	Enter the values for the destination port and port max (highest port number), or select the Exclude checkbox.

3

Click **Add** to add a QoS policy.**END OF STEPS**

Security configuration

8.30 Overview

8.30.1 Purpose

This chapter describes the security configuration tasks supported by XS-2426G-A ONTs

8.30.2 Contents

8.30 Overview	125
8.31 Configuring the firewall	125
8.32 Configuring the MAC filter	126
8.33 Configuring the IP filter	128
8.34 Configuring the URL filter	129
8.35 Configuring parental control	131
8.36 Configuring DMZ and ALG	133
8.37 Configuring access control	135

8.31 Configuring the firewall

1

Click **Security**→**Firewall** from the left pane in the 10G PON Home Gateway page. The Firewall page displays.

Figure 8-30 Firewall page

10G PON Home Gateway Logout

Security>Firewall

Security Level: Off

Attack Protection: Enable

High: Traffic Denied Inbound and Minimally Permit Common Services Outbound.
Low: All Outbound traffic and pinhole-defined Inbound traffic is allowed.
Off: All Inbound and Outbound traffic is allowed

Save Refresh

2

Configure the following parameters.

Table 8-24 Firewall parameters

Field	Description
Security level	Select the security level from the list: High: Traffic denied inbound and minimally permit common services outbound Low: All outbound traffic and pinhole-defined inbound traffic is allowed Off: All inbound and outbound traffic is allowed
Attack Protection	Select Enable or Disable from the list. The default is Enable .

3

Click **Save**.

You can click **Refresh** to update the displayed information.

END OF STEPS

8.32 Configuring the MAC filter

1

Click **Security**→**MAC Filter** from the left pane in the 10G PON Home Gateway page. The MAC Filter page displays.

Figure 8-31 MAC Filter page

2

Configure the following parameters:

Table 8-25 MAC Filter parameters

Field	Description
Ethernet Interface	
MAC Filter Mode	Select the MAC filter mode from the list: Blocked or Allowed.
LAN Port	Select either one of the checkboxes. LAN1, LAN2, LAN3, LAN4
MAC Address	Select the MAC address from the list or enter the address in the text field.
Wi-Fi SSID	

Table 8-25 MAC Filter parameters (continued)

Field	Description
MAC Filter Mode	Select the MAC filter mode from the list: Blocked or Allowed.
SSID Select	Select the SSID from the list.
Enable	Select this checkbox to enable the MAC filter.
MAC Address	Select a MAC address from the list or enter the address in the text field.
MAC Address Description	Enter the MAC address description.

3

Click **Save**.

You can also use this panel to **Delete** a MAC address.

You can click **Refresh** to update the displayed information.

END OF STEPS

8.33 Configuring the IP filter

1

Click **Security**→**IP Filter** from the left pane in the 10G PON Home Gateway page. The IP Filter page displays.

Figure 8-32 IP Filter page

10G PON Home Gateway Logout

Security>IP Filter

Enable IP Filter

Mode ▼
Drop for upstream

Internal Client ▼
Custom settings

Local IP Address

Local Subnet Mask

Remote IP Address

Remote Subnet Mask

Protocol ▼
ALL

Mode	Internal Client	Protocol	Local IP Address	Local Subnet Mask	Remote IP Address	Remote Subnet Mask	Wan Port Range	Lan Port Range	Delete

2

Configure the following parameters:

Table 8-26 IP Filter parameters

Field	Description
Enable IP Filter	Select this checkbox to enable an IP filter.
Mode	Select an IP filter mode from the list: <ul style="list-style-type: none">• Drop for upstream• Drop for downstream
Internal Client	Select an internal client from the list: <ul style="list-style-type: none">• Custom settings: uses the IP address input below• IP: uses the connecting devices' IP to the ONT
Local IP Address	Enter the local IP address.
Local Subnet Mask	Enter the local subnet mask.
Remote IP Address	Enter the remote IP address.
Remote Subnet Mask	Enter the remote subnet mask.
Protocol	Select an application protocol or ALL from the list.

3

Click **Save**.

You can click **Delete** to delete a Mode, Internal Client, Protocol, Local IP Address, Local Subnet Mask, Remote IP Address, Remote Subnet Mask, WAN Port Range and LAN Port Range.

You can click **Refresh** to update the displayed information.

END OF STEPS

8.34 Configuring the URL filter

1

Click **Security**→**URL Filter** from the left pane in the 10G PON Home Gateway page. The URL Filter page displays.

Figure 8-33 URL Filter page

10G PON Home Gateway Logout

Security > URL Filter

URL Filter-- please select the type of filter and then configure the URL. Support up to 100 URL filters.

Enable URL filter

URL filter type: Block Allow

URL List

URL Address	Port Number	Delete
<input type="text"/>	<input type="text"/>	<input type="text"/>

URL Address

Port - default to 80

i **Note:** You cannot use URL filtering for HTTPS. The URL is encrypted when using HTTPS.

2

Configure the following parameters:

Table 8-27 URL Filter parameters

Field	Description
Enable URL filter	Select the checkbox to enable the URL filter.
URL filter type	Select the option to block the URL or allow the URL.
URL List	
URL Address	Enter the URL address.
Port - default to 80	Enter the port number; the default is 80.

3

Click **Add Filter**.

END OF STEPS

8.35 Configuring parental control

1

Click **Security**→**Parent Control** from the left pane in the 10G PON Home Gateway page. The Parental Control page displays.

Figure 8-34 Parental Control page

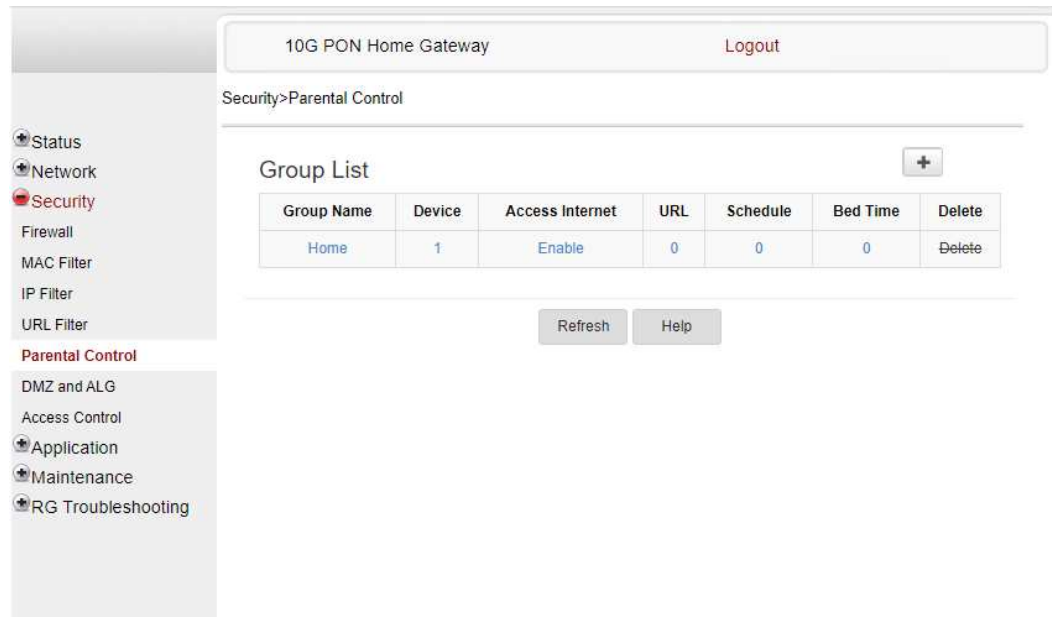

You can click **Delete** to delete the group.

2

Click on the plus sign (+) to create a group. The create new group page displays

Figure 8-35 Create new group page

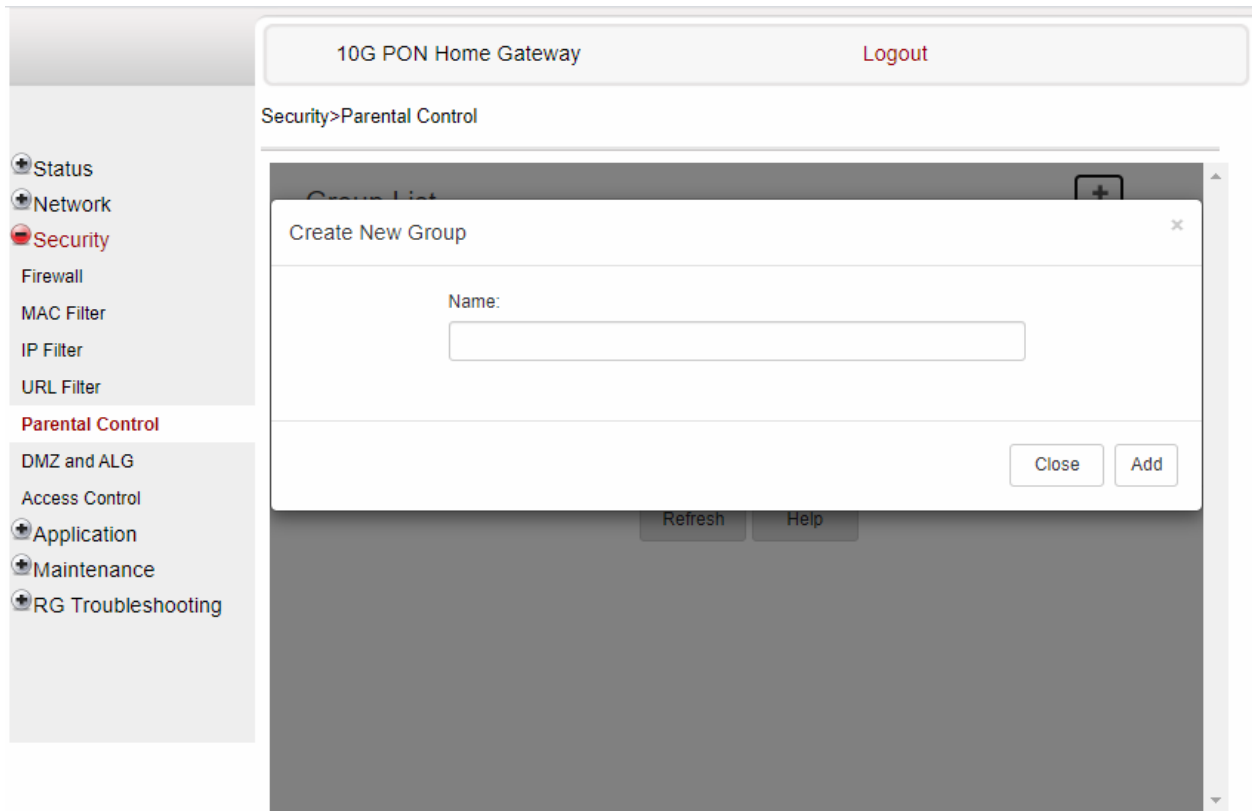

- 3 _____
Click **Add**.
- 4 _____
You can click on each field such as **Device**, **Access Internet**, **URL**, **Schedule**, and **Bed Time** to configure the related parameters.
- 5 _____
Configure the following parameters:

Table 8-28 Parental control parameters

Field	Description
Access Internet	
Access Internet	Select this checkbox to enable internet

Table 8-28 Parental control parameters (continued)

Field	Description
Group Name	Displays the selected group name
Device	
Device MAC Address	Enter the MAC address and click Add Device .
URL	
Enable URL Filter	Select this checkbox to enable URL filter
Blocked URL Address	Enter the URL address to be blocked and click Add
Schedule	
Schedule Name	Enter the schedule name
Enable Schedule	Select this checkbox to enable schedule You can choose Every Day, or Individual Days and select the checkboxes for the days of the week for which the schedule applies
From	Enter the time for the schedule to be in effect and click Add
To	
Bed Time	
Bed Time Name	Enter the bed time name
Enable Bed Time	Select this checkbox to enable bed time When bed time is enabled, the internet is paused. You can choose Every Day, or Individual Days and select the checkboxes for the days of the week for which the bed time applies
From	Enter the time for the bed time to be in effect and click Add
To	

6

Click **Activate base parental control**, to go back to default parental control window.
 You can click **Refresh** to update the displayed information.
 You can click **Help** for more information.

END OF STEPS

8.36 Configuring DMZ and ALG

1

Click **Security**→**DMZ and ALG** from the left pane in the 10G PON Home Gateway page. The DMZ and ALG page displays.

Figure 8-36 DMZ and ALG page

2

Configure the following parameters:

Table 8-29 ALG parameters

Field	Description
ALG Config	Select the checkboxes to enable the protocols to be supported by the ALG: FTP, TFTP, SIP, H323, RTSP, L2TP, IPSEC, PPTP.

3

Click **Save ALG**.

4

Configure the following parameters:

Table 8-30 DMZ parameters

Field	Description
WAN Connection List	Select a WAN connection from the list.
Enable DMZ	Select this checkbox to enable DMZ on the selected WAN connection.
DMZ IP Address	Select Custom Settings and enter the DMZ IP address or select the IP address of a connected device from the list.

5

Click **Save DMZ**.

END OF STEPS

8.37 Configuring access control

This procedure describes how to configure the access control level (ACL).

i **Note:** ACL takes precedence over the firewall policy.

The trusted network object will be shared for all WAN connections; it is not applied individually to a WAN connection.

1

Click **Security**→**Access Control** from the left pane in the 10G PON Home Gateway page. The Access Control page displays.

Figure 8-37 Access Control page

	WAN	LAN
ICMP	Allow	Allow
Telnet	Deny	Deny
SSH	Deny	Allow
HTTP	Deny	Allow
TR-069	Allow	Deny
HTTPS	Deny	Allow
SFTP	Deny	Deny

SFTP access can be set in Application -> USB

Save Refresh

Trusted Network

Source IP Start:

Source IP End:

Add

Source IP Start	Source IP End	Delete
-----------------	---------------	--------

2

Configure the following parameters:

Table 8-31 Access Control parameters

Field	Description
WAN	Select a connection from the list.
Trusted Network Enable	Click to enable or disable trusted network.
ICMP, Telnet, SSH, HTTP, TR-069, HTTPS, SFTP	Select an access control level for each protocol: WAN side: Allow, Deny, or Trusted Network Only LAN side: Allow or Deny

3

Click **Save**.

You can click **Refresh** to update the displayed information.

4

Optionally, add one or more subnet trusted networks.

The maximum number of entries is 32.

You can also use the Source IP fields to delete a previously created entry for a subnet trusted network.

Table 8-32 Trusted Network parameters

Field	Description
Trusted Network	
Source IP Start	Enter a start IP address for the new subnet trusted network.
Source IP End	Enter an end IP address for the new subnet trusted network.

5

Click **Add**.

END OF STEPS

Configuring the Application

8.38 Overview

8.38.1 Purpose

This chapter describes the application configuration tasks supported by the XS-2426G-A ONTs.

8.38.2 Contents

8.38 Overview	137
8.39 Configuring port forwarding	137
8.40 Configuring port triggering	139
8.41 Configuring DDNS	140
8.42 Configuring NTP	142
8.43 Configuring USB	143
8.44 Configuring UPnP and DLNA	144
8.45 Configuring voice	145

8.39 Configuring port forwarding

1

Click **Application**→**Port Forwarding** from the left pane in the 10G PON Home Gateway page. The Port Forwarding page displays.

Figure 8-38 Port Forwarding page

10G PON Home Gateway Logout

Application > Port Forwarding

Application Name: Custom settings

WAN Port: [] ~ []

LAN Port: [] ~ []

Internal Client: Custom settings []

Protocol: TCP

Enable Mapping:

WAN Connection List: 1_VOIP_TR069_INTERNET_R_VID_881

Description: []

Application Name	WAN Connection	WAN Port	LAN Port	Device Name	Internal Client	Protocol	Status	Delete
------------------	----------------	----------	----------	-------------	-----------------	----------	--------	--------

2

Configure the following parameters:

Table 8-33 Port Forwarding parameters

Field	Description
Application Name	Select an application name from the list. The default is Custom settings .
WAN Port	Enter the WAN port range.
LAN Port	Enter the LAN port range.
Internal Client	Select a connected device from the list and enter the associated IP address.
Protocol	Select the port forwarding protocol from the list: <ul style="list-style-type: none"> • TCP • UDP • TCP/UDP
Enable Mapping	Select this checkbox to enable mapping.
WAN Connection List	Select a WAN connection from the list. Note: Only active devices are shown on this list.

3 _____
 Click **Add**.

END OF STEPS _____

8.40 Configuring port triggering

1 _____
 Click **Application**→**Port Triggering** from the left pane in the 10G PON Home Gateway page.
 The Port Triggering page displays.

Figure 8-39 Port Triggering page

Application Name	WAN Connection	Open Port	Triggering Port	Expire Time	Open Protocol	Trigger Protocol	Status	Delete
------------------	----------------	-----------	-----------------	-------------	---------------	------------------	--------	--------

2 _____
 Configure the following parameters:

Table 8-34 Port Triggering parameters

Field	Description
Application Name	Select an application name from the list. The default is Custom settings .
Open Port	Enter the open port range.

Table 8-34 Port Triggering parameters (continued)

Field	Description
Triggering Port	Enter the triggering port range.
Expire Time	Enter the expiration time in seconds.
Open Protocol	Select the open port protocol from the list: <ul style="list-style-type: none"> • TCP • UDP • TCP/UDP
Trigger Protocol	Select the triggering port protocol from the list: <ul style="list-style-type: none"> • TCP • UDP • TCP/UDP
Enable Triggering	Select this checkbox to enable port triggering.
WAN Connection List	Select a WAN connection from the list. Note: Only active devices are shown on this list.

3

Click **Add**.

END OF STEPS

8.41 Configuring DDNS

1

Click **Application**→**DDNS** from the left pane in the 10G PON Home Gateway page. The DDNS page displays.

Figure 8-40 DDNS page

2

Configure the following parameters:

Table 8-35 DDNS parameters

Field	Description
WAN Connection List	Select a WAN connection from the list.
Enable DDNS	Select this checkbox to enable DDNS on the selected WAN connection.
ISP	Select an ISP from the list.
Domain Name	Enter the domain name.
Username	Enter the username.
Password	Enter the password.
DDNS Status	Displays the status of the DDNS: Synchronized, Synchronization failed, or blank if no update message has been received from the ISP.

3

Click **Save**.

You can click **Refresh** to update the displayed information.

END OF STEPS

8.42 Configuring NTP

1

Click **Application**→**NTP** from the left pane in the 10G PON Home Gateway page. The NTP page displays.

Figure 8-41 NTP page

The screenshot shows the NTP configuration page in the 10G PON Home Gateway interface. The page title is "10G PON Home Gateway" with a "Logout" button. The navigation sidebar on the left includes: Status, Network, Security, Application (highlighted), Port Forwarding, Port Triggering, DDNS, NTP (highlighted), USB, UPNP and DLNA, Voice Setting, Maintenance, and RG Troubleshooting. The main configuration area is titled "Application>NTP" and contains the following settings:

- Enable NTP Service:
- Current Time: 01/10/1970 02:34:47 AM
- Primary Time Server: Custom settings
- Secondary Time Server: None
- Tertiary Time Server: None
- Interval Time: 0 (0,15-259200)seconds
- Time Zone: (GMT-00:00) Casablanca, Monrovia

Buttons for "Save" and "Refresh" are located at the bottom of the configuration area.

2

Configure the following parameters:

Table 8-36 NTP parameters

Field	Description
Enable NTP Service	Select this checkbox to enable the NTP service.
Current Time	Enter the current local date and time.
Primary Time Server	Select a time server from the list or select Custom settings and enter the address of the time server.
Secondary Time Server	Select a time server from the list or select Custom settings and enter the address of the time server.
Third Time Server	Select a time server from the list or select Custom settings and enter the address of the time server.
Interval Time	Enter the interval at which to get the time from the time server, in seconds.
Time Zone	Select the local time zone from the list.

3

Click **Save**.

You can click **Refresh** to update the displayed information.

END OF STEPS

8.43 Configuring USB

You can connect USB storage devices and USB printers to the USB ports of the device. The USB menu enables you to configure FTP and SFTP for your USB storage devices.

The USB connected devices are shown in overview table on the bottom of the USB page.

1

Click **Application**→**USB** from the left pane in the 10G PON Home Gateway page. The USB page displays.

Figure 8-42 USB page

10G PON Home Gateway [Logout](#)

Application>USB

Enable FTP Server

Username: ftpadmin

Password: *****

Re-enter Password: *****

Enable SFTP Server

Enable SFTP for Remote Access

Username: sftpadmin

Password:

Re-enter Password:

Enable Printer Sharing

Username: myprinter

Password:

Re-enter Password:

Connected USB Devices Table

Host Number	Device Name	Format	Total Space	Free Space
-------------	-------------	--------	-------------	------------

[Save](#) [Refresh](#)

2

Configure the following parameters:

Table 8-37 USB parameters

Field	Description
Enable FTP server	Select this checkbox to enable using an FTP server.
Username	Enter the username for the FTP server.
Password	Enter the password for the FTP server.
Re-enter Password	Re-enter the password for the FTP server.
Enable SFTP server	Select this checkbox to enable using an SFTP server.
Enable SFTP for Remote Access	Select this checkbox to enable SFTP for remote access.
Username	Enter the username for the SFTP server.
Password	Enter the password for the SFTP server.
Re-enter Password	Re-enter the password for the SFTP server.
Enable Printer Sharing	Select this checkbox to enable printer sharing. Printer sharing is disabled by default.
Username	Enter the username for the SFTP server.
Password	Enter the password for the SFTP server.
Re-enter Password	Re-enter the password for the SFTP server.
Connected USB Devices Table	For each printer that is connected to the ONT, the following fields are displayed: <ul style="list-style-type: none"> • Host Number for example: Printer1, Printer2 • Device Name: name or identification for the USB device • Format: displays the storage format (applies only to a USB storage device) • Total space (applies only to a USB storage device) • Free space (applies only to a USB storage device)

3Click **Save**.You can click **Refresh** to update the displayed information.

END OF STEPS

8.44 Configuring UPnP and DLNA

1Click **Application**→**UPnP and DLNA** from the left pane in the 10G PON Home Gateway page.
The UPnP and DLNA page displays.

Figure 8-43 UPnP and DLNA page

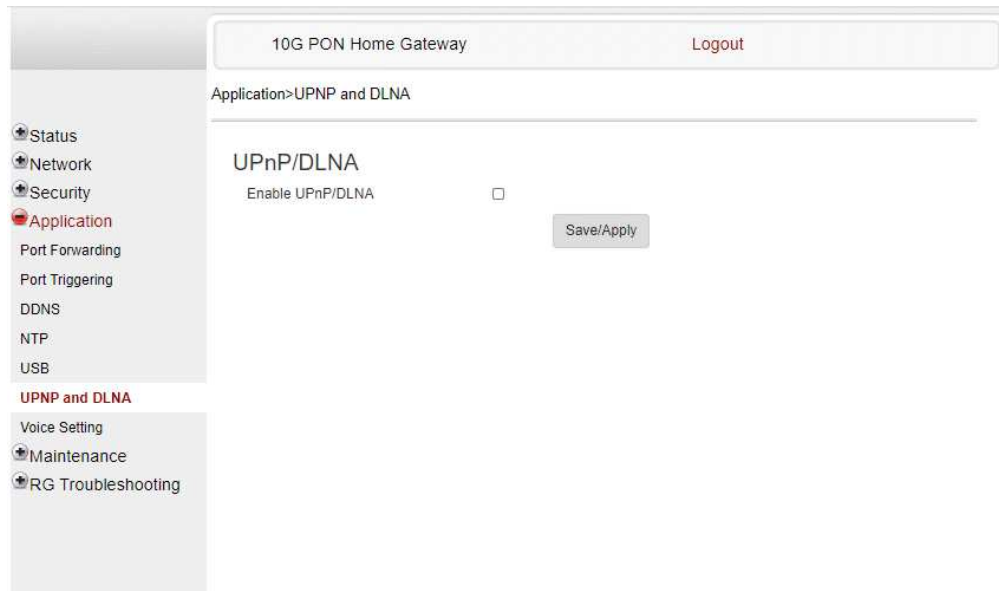

2 _____
Select the **Enable UPnP/DLNA** checkbox to enable UPnP/DLNA.

3 _____
Click **Save/Apply**.

END OF STEPS _____

8.45 Configuring voice

1 _____
Click **Application**→**Voice Setting** from the left pane in the 10G PON Home Gateway page.
The Voice Setting page displays.

Figure 8-44 Voice Setting page

2

Configure the following parameters:

Table 8-38 Voice Setting parameters

Field	Description
Voice Setting	
Outbound Proxy	Enter the SIP outbound proxy.
Outbound Proxy Port	Enter the outbound proxy port.

Table 8-38 Voice Setting parameters (continued)

Field	Description
Proxy Server	Enter the proxy server.
Proxy Server Port	Enter the proxy server port.
Registrar Server	Enter the registrar server.
Registrar Server Port	Enter the registrar server port.
UserAgentDomain	Enter the user agent domain.
UserAgentPort	Enter the user agent port.
DigitMap	A string of characters with a length limit of 1024 bytes. A dial plan can consist of several dial plan tokens. Each token is a component of the overall dial plan.
DTMF Mode	Select InBand , or RFC2833 from the list.
FaxT38	Select False or True from the list.
Line Setting	
POTS line	Select a POTS line from the list.
Enable	Select Enabled or Disabled from the list.
Directory Number	Enter a directory number.
AuthUserName	Enter an authorized user name.
AuthPassword	Enter a password for the user.
URI	Enter the Uniform Resource Identifier of the SIP URL.

3

Click **Save**.

END OF STEPS

Maintenance

8.46 Overview

8.46.1 Purpose

This chapter describes the maintenance tasks supported by XS-2426G-A ONTs.

8.46.2 Contents

8.46 Overview	148
8.47 Configuring the password	148
8.48 Configuring LOID	150
8.49 Configuring SLID	150
8.50 Managing the device	152
8.51 Backing up the configuration	153
8.52 Restoring the configuration	153
8.53 Upgrading firmware	154
8.54 Rebooting the device	155
8.55 Resetting to factory defaults	156
8.56 Diagnosing WAN connections	157
8.57 Viewing log files	159

8.47 Configuring the password

A password must adhere to the password rules, which are as follows:

- the password may consist of uppercase letters, lowercase letters, digital numbers, and the following special characters ! # + , - / @ _ : =]
- the password length must be from 8 to 24 characters
- the first character must be a digital number or a letter
- the password must contain at least two types of characters: numbers, letters, or special characters
- the same character must not appear more than 8 times in a row

When the password meets the password rules, the application displays the message “Your password has been changed successfully”.

When the password does not meet the password rules, the application displays a message to indicate which password rule has not been followed, for example:

- the password is too short
- the password is too long

- the first character cannot be a special character
- there are not enough character classes

1

Click **Maintenance**→**Password** from the left pane in the 10G PON Home Gateway page. The Password page displays.

Figure 8-45 Password page

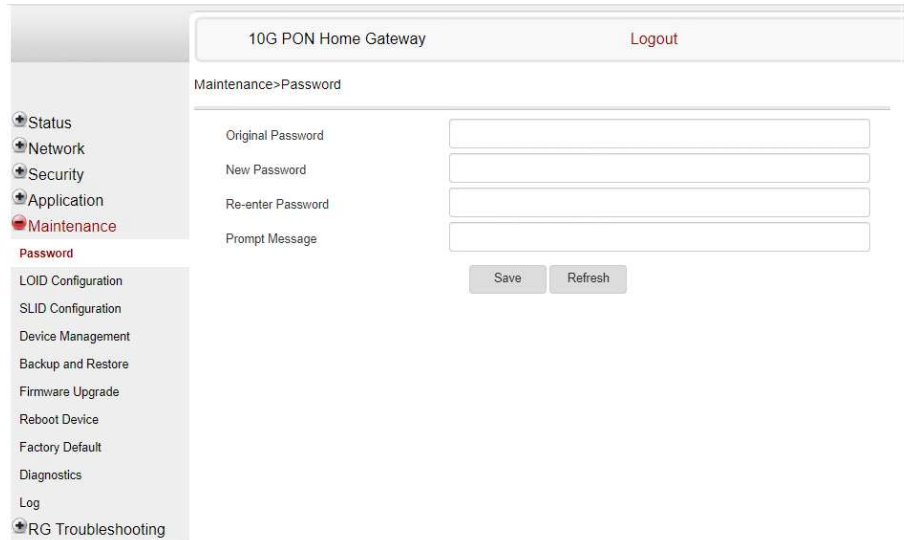

2

Configure the following parameters:

Table 8-39 Password parameters

Field	Description
Original Password	Enter the current password.
New Password	Enter the new password (must adhere to the password rules).
Re-enter password	Re-enter the new password (must match the new password entered above exactly).
Prompt message	Enter the password prompt message.

3

Click **Save**.

You can click **Refresh** to update the displayed information.

END OF STEPS

8.48 Configuring LOID

1

Click **Maintenance** → **LOID Config** from the left pane in the 10G PON Home Gateway page. The LOID Config page displays.

Figure 8-46 LOID Config page

2

Configure the following parameters:

Table 8-40 LOID Configuration parameters

Field	Description
LOID	Enter the LOID; the maximum number of characters is 24 If the password is null, this field may be left blank.
Password	Enter the password; the maximum number of characters is 12.

3

Click **Save/Apply**.

END OF STEPS

8.49 Configuring SLID

1

Click **Maintenance**→**SLID Configuration** from the left pane in the 10G PON Home Gateway page. The SLID Configuration page displays.

Figure 8-47 SLID Configuration page

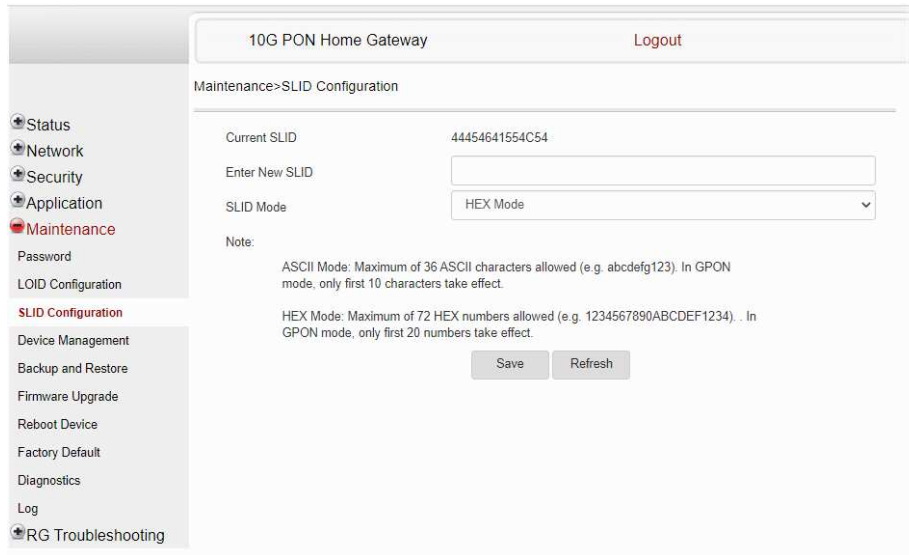

2

Configure the following parameters:

Table 8-41 SLID Configuration parameters

Field	Description
Current SLID	Displays the current SLID.
Enter New SLID	Enter the new SLID.
SLID Mode	Select a SLID mode from the list. The default is HEX Mode.

3

Click **Save**.

You can click **Refresh** to update the displayed information.

END OF STEPS

8.50 Managing the device

1

Click **Maintenance**→**Device Management** from the left pane in the 10G PON Home Gateway page. The Device Management page displays.

Figure 8-48 Device Management page

10G PON Home Gateway Logout

Maintenance > Device Management

Host Name: MXY-PC

Host Alias:

Add

Host Name	Host Alias	Delete

Refresh

Navigation menu:

- Status
- Network
- Security
- Application
- Maintenance**
- Password
- LOID Configuration
- SLID Configuration
- Device Management
- Backup and Restore
- Firmware Upgrade
- Reboot Device
- Factory Default
- Diagnostics
- Log
- RG Troubleshooting

2

Configure the following parameters:

Table 8-42 Device Management parameters

Field	Description
Host Name	Select a hostname from the list.
Host Alias	Enter an alias for the selected host.

3

Click **Add**.

You can click **Refresh** to update the displayed information.

END OF STEPS

8.51 Backing up the configuration

1

Click **Maintenance**→**Backup and Restore** from the left pane in the 10G PON Home Gateway page. The Backup and Restore page displays.

Figure 8-49 Backup and Restore page

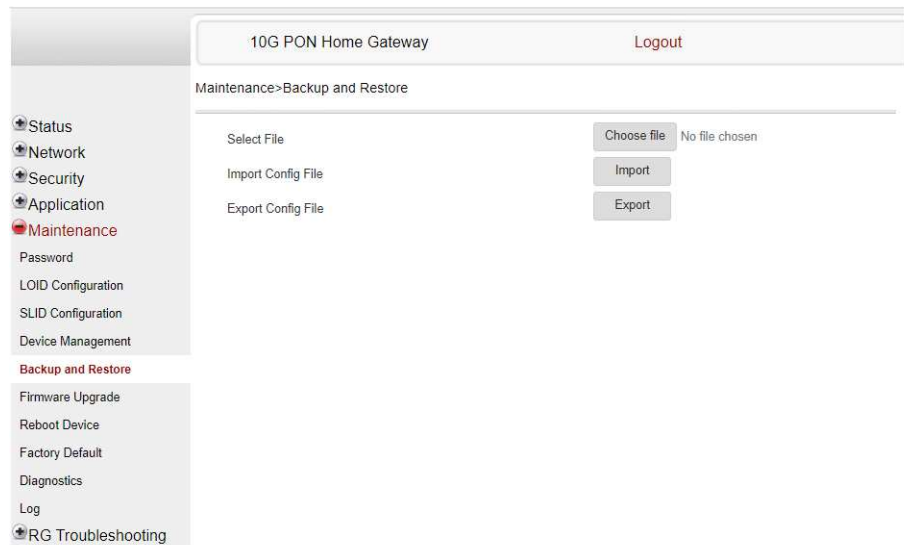

2

Click **Export** to export the current ONT configuration to a backup file.

END OF STEPS

8.52 Restoring the configuration

1

Click **Maintenance**→**Backup and Restore** from the left pane in the 10G PON Home Gateway page. The Backup and Restore page displays.

Figure 8-50 Backup and Restore page

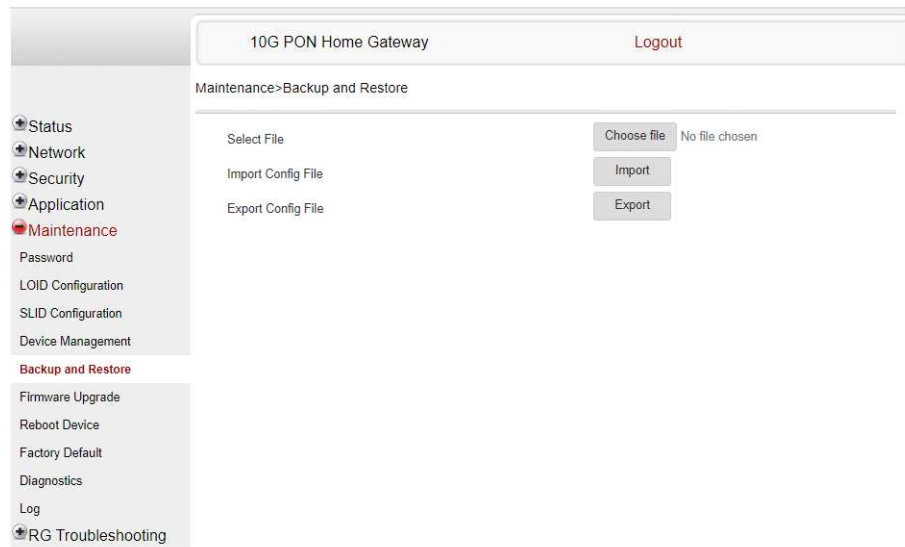

2

Click **Choose file** and select the backup file.

3

Click **Import** to restore the ONT to the saved backup.

END OF STEPS

8.53 Upgrading firmware

1

Click **Maintenance**→**Firmware Upgrade** from the left pane in the 10G PON Home Gateway page. The Firmware Upgrade page displays.

Figure 8-51 Firmware Upgrade page

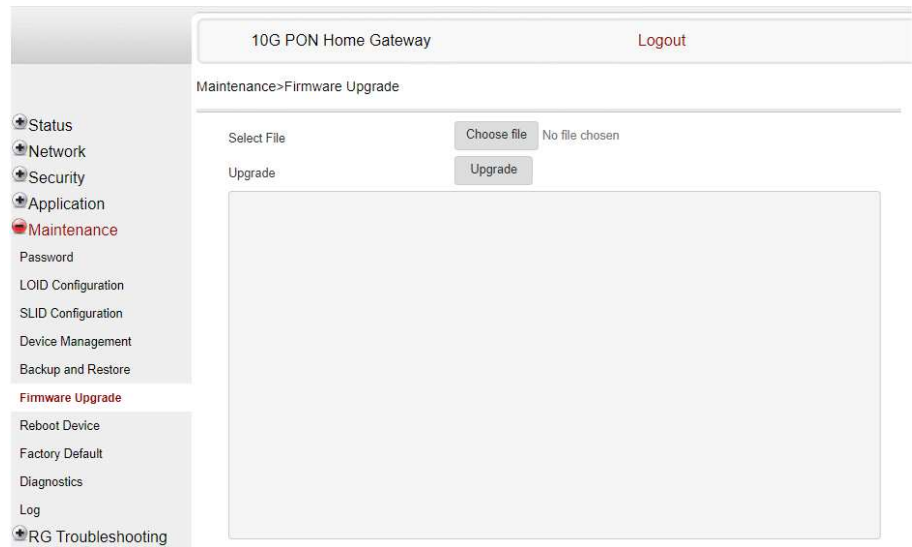

2 _____
Click **Choose file** and select the firmware file.

3 _____
Click **Upgrade** to upgrade the firmware.

END OF STEPS _____

8.54 Rebooting the device

1 _____
Click **Maintenance**→**Reboot Device** from the left pane in the 10G PON Home Gateway page. The Reboot Device page displays.

Figure 8-52 Reboot Device page

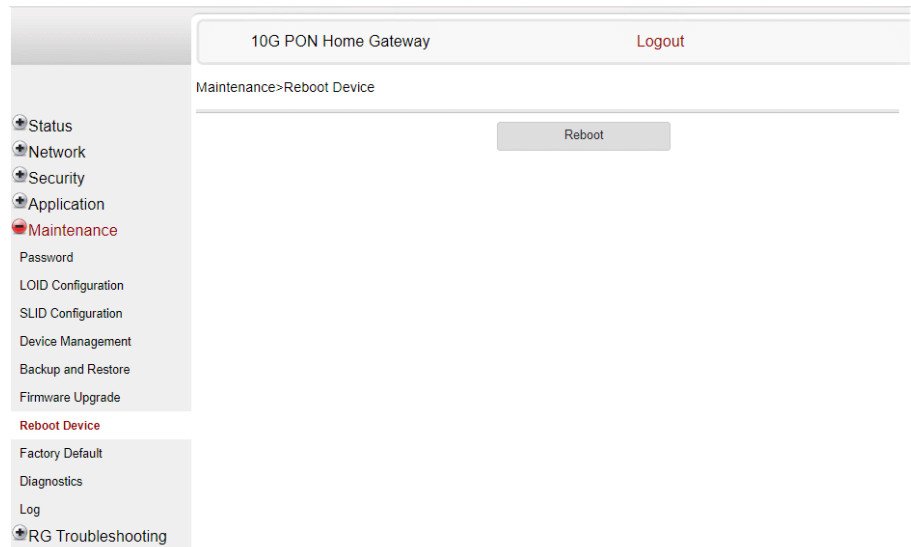

2

Click **Reboot** to reboot the ONT.

END OF STEPS

8.55 Resetting to factory defaults

1

Click **Maintenance**→**Factory Default** from the left pane in the 10G PON Home Gateway page. The Factory Default page displays.

Figure 8-53 Factory Default page

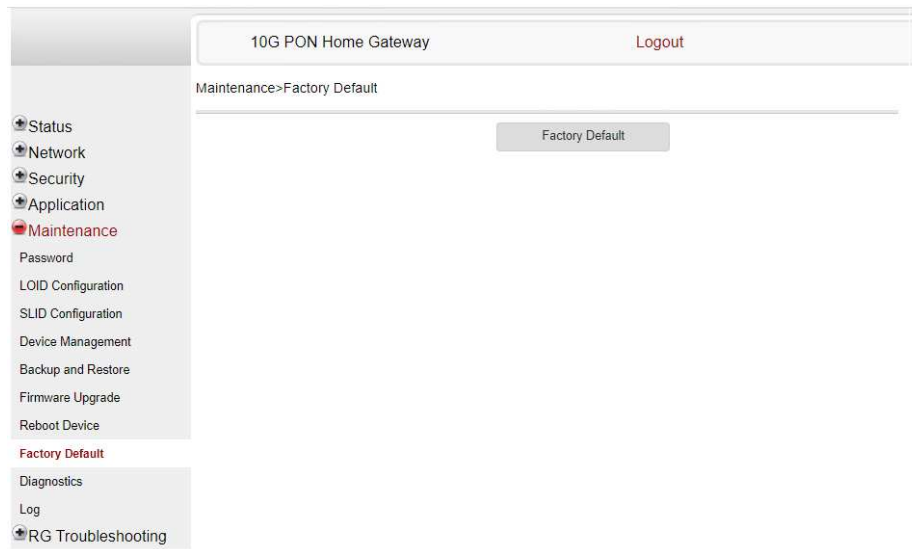

2

Click **Factory Default** to reset the ONT to its factory default settings.

END OF STEPS

8.56 Diagnosing WAN connections

1

Click **Maintenance**→**Diagnostics** from the left pane in the 10G PON Home Gateway page. The Diagnostics page displays.

Figure 8-54 Diagnostics page

- 2 _____
Select a WAN connection to diagnose from the list.
- 3 _____
Enter the IP address or domain name.
- 4 _____
Select the test type: ping, traceroute, or both.
- 5 _____
Enter the number of ping attempts to perform (1 - 1000); the default is 4.
- 6 _____
Enter a ping packet length (64-1024); the default is 64.
- 7 _____
Enter the maximum number of trace hops (1-255); the default is 30.

8

Click **Start Test**. The results will be displayed at the bottom of the page.

9

Click **Cancel** to cancel the test.

END OF STEPS

8.57 Viewing log files

1

Click **Maintenance**→**Log** from the left pane in the 10G PON Home Gateway page. The Log page displays.

Figure 8-55 Log page

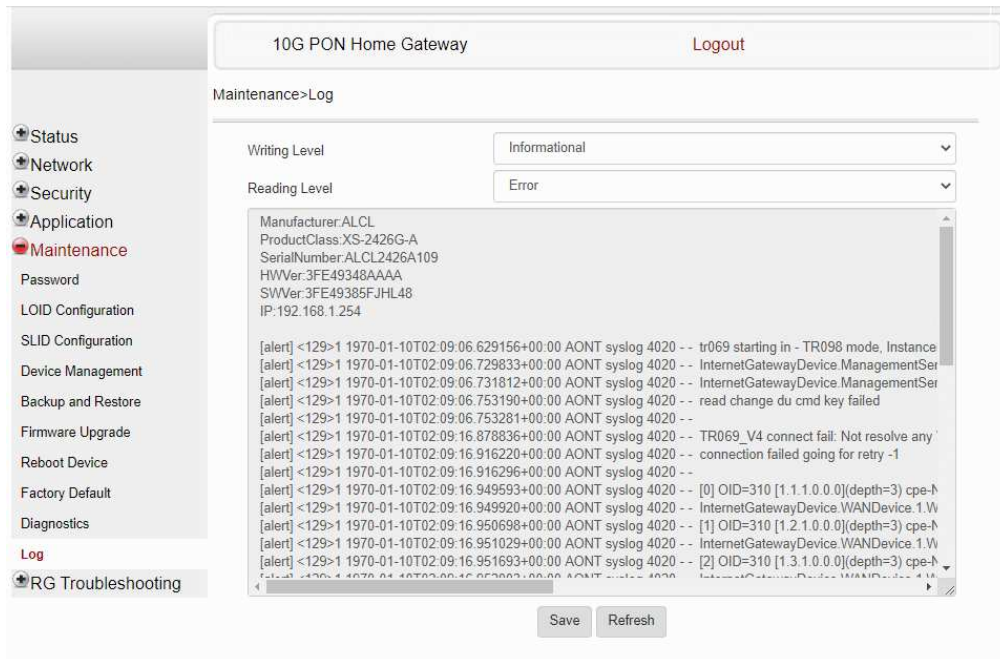

2

Select a write level from the list to determine which types of events are recorded in the log file:

- Emergency
- Alert
- Critical
- Error

-
- Warning
 - Notice
 - Informational
 - Debug

3

Select a reading level from the list to determine which types of events to display from the log file:

- Emergency
- Alert
- Critical
- Error
- Warning
- Notice
- Informational
- Debug

The log file is displayed at the bottom of the page.

4

Click **Save** to save the log file.

You can click **Refresh** to update the displayed information.

END OF STEPS

RG Troubleshooting Counters

8.58 Overview

8.58.1 Purpose

This section describes the RG troubleshooting counters GUI procedures.

8.58.2 Contents

8.58 Overview	161
8.59 Viewing Residential Gateway (RG) troubleshooting counters	161

8.59 Viewing Residential Gateway (RG) troubleshooting counters

The Troubleshooting Counters feature enables service providers and end users to monitor the performance of their broadband connection.

Tests are run to retrieve upstream and downstream throughput, latency, and DNS response time. The Troubleshooting Counters page also displays upstream and downstream packet loss and Internet status.

1

Click **RG Troubleshooting**→**RG Troubleshoot Counters** from the left menu in the 10G PON Home Gateway page. The RG Troubleshoot Counters page displays.

Figure 8-56 RG Troubleshooting Counters page

2

Configure the following parameters:

Table 8-43 RG Troubleshooting Counters parameters

Field	Description
WAN Connection List	Select a WAN connection from the list.
US Throughput	This test is used to determine the upstream throughput/speed. Click US Speed Test to specify the time for the upstream test. The default is weekly, performed at idle to a public server.
DS Throughput	This test is used to determine the downstream throughput/speed. Click DS Speed Test to specify the time for the downstream test. The default is weekly, performed at idle to a public server.
US Packet Loss	Displays the number of upstream packages lost.
DS Packet Loss	Displays the number of downstream packages lost.

Table 8-43 RG Troubleshooting Counters parameters (continued)

Field	Description
Internet Status	Indicates whether the broadband connections is active (UP) or not (DOWN).
Latency	This test is used to determine the lowest round-trip time in milliseconds by pinging the target server multiple times. Click Latency Test to specify the time for the test. The default is weekly, performed at idle to a public server.
DNS Response Time	This test is used to determine the lowest round-trip time in milliseconds by sending a request to the target DNS server. Click DNS Response Test to specify the time for the test. The default is weekly, performed at idle to a public server.

3

Click **Refresh** to display up-to-date information.

END OF STEPS

9 ONT configuration file over OMCI

9.1 Overview

9.1.1 Purpose

9.1.2 Contents

9.1 Overview	165
9.2 Purpose	165
9.3 Supported configuration file types	165
9.4 ONT configuration file over OMCI	167

9.2 Purpose

This procedure describes how to use configuration files over OMCI to configure ONTs. Some advantages include:

- flexibility to change the ONT default behavior by downloading configuration file
- flexibility to update a deployed ONT by downloading updated parameters
- ability to securely download any configuration file to an ONT
- ability to avoid using embedded configuration files in ONT software

i **Note:** This feature is supported for use with the 7360 ISAM FX and the 7342 ISAM FTTU.

9.3 Supported configuration file types

[Table 9-1, “Supported configuration files” \(p. 166\)](#) describes the configuration file types that are supported from Nokia ONT R05.02.00 and later.

Table 9-1 Supported configuration files

File Index	Description	Details	Supported ONTs/DPU
PRE	ONT pre-configuration file	<p>The XML-based PRECONFIG file controls the working mechanics of the ONT for various services. The default behavior of different ONTs may vary based on the factory settings.</p> <p>The pre-configuration file includes the factory default value for the residential gateway.</p> <p>Note: the pre-configuration file does not work with SFU ONTs; therefore, this feature applies only to Residential Gateway ONTs.</p> <p>The pre-configuration file can be used as is, but Nokia provides its customers with the flexibility to customize the pre-configuration file.</p> <p>This pre-configuration file enables operators to change the default behavior by downloading a customized pre-configuration based on customer inputs.</p> <p>This PRE XML file includes a custom OPERID.</p> <p>The Nokia defined index for the PRECONFIG file is: "PRE"</p>	All Nokia GPON and 10 GPON ONT.
CFG	ONT configuration delta file	<p>The XML-based CFG file updates the configurable parameters (the PRE settings) in the existing PRE file of a deployed ONT, where required.</p> <p>This configuration file enables operators to change the deployed behavior by downloading customized updates in the CFG file.</p> <p>This file is used only to modify the parameters in the PRE file; it is not used for service provisioning.</p> <p>No OPERID is required, because the update is based on the OPERID used for the PRE file.</p> <p>The Nokia defined index for the PRECONFIG DELTA file is: "CFG"</p>	All Nokia GPON and 10GPON ONT.
XML	Voice XML file	<p>The Voice XML file provides an alternate method for securely downloading voice parameters from the OLT, rather than using FTP (OMCIv1/OMCIv2) or HTTPS (TR-069). Downloading this file makes the applicable changes in the voice parameters.</p> <p>This file enables operators to change the voice behavior by downloading the updated voice XML file.</p> <p>Nokia recommends using this procedure, rather than embedded voice XML files.</p> <p>The Nokia defined index for the Voice XML file is: "XML"</p>	All Nokia GPON and 10 GPON ONT.

Table 9-1 Supported configuration files (continued)

File Index	Description	Details	Supported ONTs/DPU
GFT	G.fast-related configuration file	<p>This text-based json script file controls the default behavior of the G.Fast ONT.</p> <p>This file includes the provisioning parameters of the G.fast transports layer; it does not include VLAN or QoS provisioning.</p> <p>While the ONT functions well with the default values; they can optionally be customized.</p> <p>While default values can work in VDSL mode, a download file is required for the device to function as a G.fast ONT.</p> <p>The Nokia defined index for the G.fast file is: "GFT"</p>	Nokia G.fast.

9.3.1 Filename conventions

Nokia provides the raw configuration files, which must be saved by the operator in a TAR file to be uploaded. TAR file names must be unique.

The filenames of the raw configuration files may not adhere to the naming conventions outlined below. In this case, the files must be renamed to adhere to the naming conventions before the operator generates the TAR file. Filenames are not case-sensitive.

9.3.2 Download configuration file

The following table provides the supported download options for ONT pre-configuration file and configuration file.

Table 9-2 Download configuration files

ONT type	Legacy method download		Zero management download	
	PRE file	CFG file	PRE file	CFG file
Broadlight(eg.I240WA-3FE54869AFGA80)	—	✓	—	✓
Broadcom(eg.G240WB-3FE56773BFGA07)	—	✓	✓	✓
MTK(eg.G240WF)	—	✓	✓	✓

9.4 ONT configuration file over OMCI



WARNING

Equipment Damage

Executing the following procedure will trigger the ONT to reboot, which will impact ongoing services.

Use this procedures to configure ONTs using configuration files via legacy method and OMCI.

9.4.1 Configuring an ONT using a configuration file via legacy method

1

Upload the ABCXXXVER TAR file to the /ONT/ directory in the OLT.
A maximum of 250 files can be kept in the OLT file system.

2

Using OLT commands, download the TAR file to the ONT.

For OLT commands, refer to the , or the **7342 ISAM FTTU Operation and Maintenance Using TL1 and CLI**.

Please note:

- **pri-cfgfile-pland/dnload** or **sec-cfgfile-pland/dnload** can be 1 to 14 characters.
- **pri-cfgfile-pland** and **pri-cfgfile-dnload** should be the same name.

Examples

Note: X can be 1 or 2 unless specified:

- If **pland-cfgfileX= Disabled** and **dnload-cfgfileX= Disabled** ,
no file will be downloaded to the ONT.
- If **pland-cfgfileX=FILENAME1** and **dnload-cfgfileX= Disabled** ,
FILENAME1 will be downloaded and FILENAME1 will be made active. An ONT reboot is required.
- If **pland-cfgfileX=Disabled** and **dnload-cfgfileX= FILENAME2**
FILENAME2 will be downloaded and FILENAME2 will be made passive. An ONT reboot is not required.
- If **pland-cfgfileX=FILENAME3** and **dnload-cfgfileX= FILENAME 4**, the OLT reports an error because the filenames are not the same.
- Configure equipment interface **pland-cfgfile1=XMLXXXXX1** and **dnload-cfgfile1 XMLXXXXX1**
Configure equipment interface **pland-cfgfile2=XMLXXXXX2** and **dnload-cfgfile2 XMLXXXXX2**
Although the OLT permits the above two steps without reporting an error, Nokia does not recommend executing them, because the ONT may exhibit unexpected behavior.
- If **pland-cfgfileX=Auto** and **dnload-cfgfileX= Auto**
The OLT will download the XML file from "sw-ctr-list" (**configure equipment ont sw-ctrl**)

END OF STEPS

The ONT will distribute the configuration files to the different services based on the active indication from the OLT and on the Nokia defined index.

The ONT automatically reboots to apply the configuration files. After the ONT reboots and reports the active version, the OLT completes the file download procedure.

Operators must check the committed file from the OLT to verify whether the corresponding file has been applied. If an error occurs, contact Nokia for support.

9.4.2 Configuring an ONT using a configuration file via OMCI

1

Generate the TAR file to be uploaded to the OLT.

Using the raw configuration file(s) provided by Nokia, generate the TAR file as follows:

a. On a Linux platform, rename the raw configuration file to adhere to the naming convention, as described in section 9.3 “Supported configuration file types” (p. 165).

b. Tar the **ABCXXXXVER** raw configuration file:

```
tar -cf ABCXXXXVER.tar ABCXXXXVER
```

Where

ABCXXXXVER

Is the name of the file created in step i.

This creates two files: **ABCXXXXVER** and **ABCXXXXVER.tar**.

c. Rename **ABCXXXXVER** to **ABCXXXXVER.org**

d. Remove the “.tar” extension from **ABCXXXXVER.tar** file.

2

Upload the ABCXXXXVER TAR file to the /ONT/ directory in the OLT.

A maximum of 250 files can be kept in the OLT file system.

3

Using OLT commands, download the TAR file to the ONT.

For OLT commands, refer to the , or the **7342 ISAM FTU Operation and Maintenance Using TL1 and CLI**.

Please note:

- **pri-cfgfile-pland/dnload** or **sec-cfgfile-pland/dnload** can be 1 to 14 characters.
- **pri-cfgfile-pland** and **pri-cfgfile-dnload** should be the same name.

Examples

Note: X can be 1 or 2 unless specified:

a. If **pland-cfgfileX= Disabled** and **dnload-cfgfileX= Disabled** ,
no file will be downloaded to the ONT.

b. If **pland-cfgfileX=FILENAME1** and **dnload-cfgfileX= Disabled** ,

FILENAME1 will be downloaded and FILENAME1 will be made active. An ONT reboot is required.

c. If **pland-cfgfileX=Disabled** and **dnload-cfgfileX= FILENAME2**

FILENAME2 will be downloaded and FILENAME2 will be made passive. An ONT reboot is not required.

d. If **pland-cfgfileX=FILENAME3** and **dnload-cfgfileX= FILENAME 4**, the OLT reports an error because the filenames are not the same.

e. Configure equipment interface **pland-cfgfile1=XMLXXXXXX1** and **dnload-cfgfile1 XMLXXXXXX1**

Configure equipment interface **pland-cfgfile2=XMLXXXXXX2** and **dnload-cfgfile2 XMLXXXXXX2**

Although the OLT permits the above two steps without reporting an error, Nokia does not recommend executing them, because the ONT may exhibit unexpected behavior.

f. If **pland-cfgfileX=Auto** and **dnload-cfgfileX= Auto**

The OLT will download the XML file from "sw-ctr-list" (**configure equipment ont sw-ctrl**)

END OF STEPS

The ONT will distribute the configuration files to the different services based on the active indication from the OLT and on the Nokia defined index.

The ONT automatically reboots to apply the configuration files. After the ONT reboots and reports the active version, the OLT completes the file download procedure.

Operators must check the committed file from the OLT to verify whether the corresponding file has been applied. If an error occurs, contact Nokia for support.