

THE ONTARIO CURRICULUM

GRADES 1–8

Mathematics

2020

The Ontario Public Service endeavours to demonstrate leadership with respect to accessibility in Ontario. Our goal is to ensure that Ontario government services, products, and facilities are accessible to all our employees and to all members of the public we serve. This document, or the information that it contains, is available, on request, in alternative formats. Please forward all requests for alternative formats to ServiceOntario at 1-800-668-9938 (TTY: 1-800-268-7095).

© Queen's Printer for Ontario, 2020

PDF versions of a curriculum include the following information from the [Curriculum and Resources website](#):

- the Program Planning and Assessment and Evaluation sections of the Curriculum and Resources website that apply to all Ontario curriculum, Grades 1–12;
- the Curriculum Context that is specific to a discipline;
- the strands of the curriculum; and
- glossaries and appendices as applicable.

The Ontario Curriculum Grades 1–8: Mathematics, 2020

Last issued: August 2020

This curriculum policy replaces [The Ontario Curriculum, Grades 1–8: Mathematics, 2005](#). Beginning in September 2020, all mathematics programs for Grades 1 to 8 will be based on the expectations outlined in this curriculum policy.

Version History:

Version Date	Description
June 23, 2020	Revised curriculum issued
August 21, 2020	Glossary and key concepts added
January 18, 2021	Minor edits and corrections throughout

Program Planning and Assessment and Evaluation Content

Last updated: June 2020

This content is part of official issued curriculum providing the most up-to-date information (i.e., front matter). This content is applicable to all curriculum documents, Grades 1 to 12. Educators must consider this information to guide the implementation of curriculum and in creating the environment in which it is taught.

Contents

Considerations for program planning.....	6
Introduction	6
Student Well-Being and Mental Health	6
Instructional Approaches	8
Planning for Students with Special Education Needs.....	10
Planning for English Language Learners	13
Healthy Relationships.....	17
Human Rights, Equity, and Inclusive Education	18
The Role of the School Library	20
The Role of Information and Communications Technology.....	21
Education and Career/Life Planning.....	22
Experiential Learning.....	23
Pathways to a Specialist High Skills Major (SHSM).....	24
Health and Safety.....	24
Ethics.....	26
Cross-curricular and integrated learning.....	27
Introduction	27
Integrated Learning.....	28
Financial Literacy.....	29
STEM Education	29
Indigenous Education.....	30
Literacy.....	31
Critical Thinking and Critical Literacy	32
Mathematical Literacy.....	34
Environmental Education.....	35
Social-Emotional Learning Skills	36
Transferable skills	38
Introduction	38
Critical Thinking and Problem Solving.....	39
Innovation, Creativity, and Entrepreneurship.....	40
Self-Directed Learning.....	40
Collaboration.....	41
Communication.....	42
Global Citizenship and Sustainability	42

Digital Literacy	43
Assessment and Evaluation	45
Introduction	45
Fundamental Principles	45
Learning Skills and Work Habits	46
Content Standards and Performance Standards	46
Assessment "for Learning" and "as Learning"	47
Evaluation	48
Reporting Student Achievement	49
Categories of Knowledge and Skills	50
Criteria and Descriptors	50
Levels of Achievement	51
Sample Achievement Charts	52
Curriculum context	62
Preface	62
Vision and Goals	62
The Importance and Beauty of Mathematics	63
Principles Underlying the Ontario Mathematics Curriculum	65
Roles and Responsibilities in Mathematics Education	67
The Program in Mathematics	71
The Mathematical Processes	73
The Strands in the Mathematics Curriculum	78
Some Considerations for Program Planning in Mathematics	90
Cross-Curricular and Integrated Learning in Mathematics	100
Assessment and Evaluation of Student Achievement	104
Mathematics, Grade 1	110
Mathematics, Grade 2	141
Mathematics, Grade 3	176
Mathematics, Grade 4	221
Mathematics, Grade 5	268
Mathematics, Grade 6	325
Mathematics, Grade 7	384
Mathematics, Grade 8	443
Glossary	500

Une publication équivalente est disponible en français sous le titre suivant : *Le curriculum de l'Ontario de la 1re à la 8e année – Mathématiques, 2020.*

Considerations for program planning

Introduction

Ontario elementary and secondary schools strive to support high-quality learning and student well-being. Schools give individual students the opportunity to learn in ways that are best suited to their individual strengths and needs. At the secondary level, students' ability to thrive academically and personally is also supported by their ability to choose courses and programs that best suit their skills, interests, and preferred postsecondary destinations.

Educators plan teaching and learning in every subject and discipline so that the various needs of all students are addressed and so that students can see themselves reflected in classroom resources and activities. This section highlights the key strategies and policies that educators and school leaders consider as they plan effective and inclusive programs for all students.

Student Well-Being and Mental Health

Promoting the healthy development of all students, as well as enabling all students to reach their full potential, is a priority for educators across Ontario. Students' health and well-being contribute to their ability to learn in all disciplines, and that learning in turn contributes to their overall well-being. A well-rounded educational experience prioritizes well-being and academic success for all students by promoting physical and mental health, social-emotional learning, and inclusion. Parents, community partners, and educators all play critical roles in creating this educational experience.

Educators support the well-being of children and youth by creating, fostering, and sustaining a learning environment that is healthy, caring, safe, inclusive, and accepting. A learning environment of this kind supports not only students' cognitive, emotional, social, and physical development but also their sense of self and/or spirit, their mental health, their resilience, and their overall state of well-being. All this will help them achieve their full potential in school and in life.

A variety of factors, known as "determinants of health", have been shown to affect a person's overall state of well-being. Some of these are income, education and literacy, gender and culture, physical and social environment, personal health practices and coping skills, and availability of health services. Together, these factors influence not only whether individuals are physically healthy but also the extent to which they will have the physical, social, and personal

resources needed to cope and to identify and achieve personal aspirations. These factors also have an impact on student learning, and it is important to be aware of them as factors contributing to a student’s performance and well-being.

An educator’s awareness of and responsiveness to students’ cognitive, emotional, social, and physical development, and to their sense of self and/or spirit, is critical to their success in school. A number of research-based frameworks, including those described in *Early Learning for Every Child Today: A Framework for Ontario Early Childhood Settings, 2007*, *On My Way: A Guide to Support Middle Years Childhood Development, 2017*, and *Stepping Stones: A Resource on Youth Development, 2012*, identify developmental stages that are common to the majority of students from Kindergarten to Grade 12. At the same time, these frameworks recognize that individual differences, as well as differences in life experiences and exposure to opportunities, can affect development, and that developmental events are not specifically age dependent.

The framework described in *Stepping Stones* is based on a model that illustrates the complexity of human development. Its components – the cognitive, emotional, physical, and social domains – are interrelated and interdependent, and all are subject to the influence of a person’s environment or context. At the centre is an “enduring (yet changing) core” – a sense of self, and/or spirit – that connects the different aspects of development and experience (p. 17).



Source: *Stepping Stones: A Resource on Youth Development*, p. 17

Educators who have an awareness of a student’s development are taking all of the components into account. They focus on the following elements of each component:

- **cognitive development** – brain development, processing and reasoning skills, use of strategies for learning
- **emotional development** – emotional regulation, empathy, motivation
- **social development** – self-development (self-concept, self-efficacy, self-esteem); identity formation (gender identity, social group identity, spiritual identity); relationships (peer, family, romantic)
- **physical development** – physical activity, sleep patterns, changes that come with puberty, body image, nutritional requirements

The Role of Mental Health and Well-Being

Mental health and well-being touch all components of development. Mental health is much more than the absence of mental illness. Well-being depends not only on the absence of problems and risks but also on the presence of factors that contribute to healthy growth and development. By nurturing and supporting students' strengths and assets, educators help promote positive mental health and well-being in the classroom. At the same time, they can identify students who need additional support and connect them with the appropriate supports and services.

What happens at school can have a significant influence on a student's overall well-being. With a broader awareness of mental health, educators can plan instructional strategies that contribute to a supportive classroom climate for learning in all subject areas, build awareness of mental health, and reduce stigma associated with mental illness. Taking students' well-being, including their mental health, into account when planning instructional approaches helps establish a strong foundation for learning and sets students up for success.

Instructional Approaches

Effective instruction is key to student success. To provide effective instruction, teachers need to consider what they want students to learn, how they will know whether students have learned it, how they will design instruction to promote the learning, and how they will respond to students who are not making progress.

When planning what students will learn, teachers identify the main concepts and skills described in the curriculum expectations, consider the contexts in which students will apply the learning, and determine students' learning goals.

Instructional approaches should be informed by evidence from current research about in-structional practices that are effective in the classroom. For example, research has provided compelling evidence about the benefits of explicitly teaching strategies that can help students

develop a deeper understanding of concepts. Strategies such as “compare and contrast” (e.g., through Venn diagrams and comparison matrices) and the use of analogy enable students to examine concepts in ways that help them see what the concepts *are* and what they *are not*. Although such strategies are simple to use, teaching them explicitly is important in order to ensure that all students use them effectively.

A well-planned instructional program should always be at the student’s level, but it should also push the student towards their optimal level of challenge for learning, while providing support and anticipating and directly teaching skills that are required for success.

A Differentiated Approach to Teaching and Learning

A differentiated approach to teaching and learning is an important part of a framework for effective classroom practice. It involves adapting instruction and assessment to suit individual students’ interests, learning preferences, and readiness in order to promote learning.

An understanding of students’ strengths and needs, as well as of their backgrounds, life experiences, and possible emotional vulnerabilities, can help teachers identify and address the diverse strengths and needs of their students. Teachers continually build their awareness of students’ learning strengths and needs by observing and assessing their readiness to learn, their interests, and their learning styles and preferences. As teachers develop and deepen their understanding of individual students, they can respond more effectively to each student’s needs by differentiating instructional approaches – for example, by adjusting the method or pace of instruction, using different types of resources, allowing a wider choice of topics, or even adjusting the learning environment, if appropriate, to suit the way the student learns and how the student is best able to demonstrate learning. Differentiation is planned as part of the overall learning design, but it also includes making adaptations during the teaching and learning process based on “assessment for learning”. Common classroom strategies that support differentiated instruction include cooperative learning, project-based approaches, problem-based approaches, and explicit instruction. Unless students have an Individual Education Plan with modified expectations, *what* they learn continues to be guided by the curriculum expectations and is the same for all students.

Lesson Design

Effective lesson design involves several important elements. Teachers engage students in a lesson by activating their prior learning and experiences, clarifying the purpose for learning, and making connections to contexts that will help them see the relevance and usefulness of what they are learning. Teachers select instructional strategies to effectively introduce concepts, and consider how they will scaffold instruction in ways that will best meet the needs of their students. At the same time, they consider when and how to check students’ understanding and

to assess their progress towards achieving their learning goals. Teachers provide multiple opportunities for students to apply their knowledge and skills and to consolidate and reflect on their learning. A three-part lesson design (e.g., “Minds On, Action, and Consolidation”) is often used to structure these elements. Effective lesson design also incorporates culturally responsive and relevant pedagogy (CRRP), which recognizes that all students learn in ways that are connected to background, language, family structure, and social or cultural identity. CRRP is discussed more fully in the section [Equity and Inclusive Education](#).

Planning for Students with Special Education Needs

Classroom teachers are the key educators of students with special education needs. They have a responsibility to help *all* students learn, and they work collaboratively with special education teachers and educational assistants, where appropriate, to achieve this goal. Classroom teachers commit to assisting every student to prepare for living with the highest degree of independence possible.

Learning for All: A Guide to Effective Assessment and Instruction for All Students, Kindergarten to Grade 12, 2013 describes a set of beliefs, based in research, that should guide program planning for students with special education needs. Teachers planning programs or courses in all disciplines need to pay particular attention to these beliefs, which are as follows:

- All students can succeed.
- Each student has their own unique patterns of learning.
- Successful instructional practices are founded on evidence-based research, tempered by experience.
- Universal design¹ and differentiated instruction² are effective and interconnected means of meeting the learning or productivity needs of any group of students.
- Classroom teachers are the key educators for a student’s literacy and numeracy development.
- Classroom teachers need the support of the larger community to create a learning environment that supports students with special education needs.

¹ The goal of Universal Design for Learning (UDL) is to create a learning environment that is open and accessible to all students, regardless of age, skills, or situation. Instruction based on principles of universal design is flexible and supportive, can be adjusted to meet different student needs, and enables all students to access the curriculum as fully as possible.

² Differentiated instruction is effective instruction that shapes each student’s learning experience in response to the student’s particular learning preferences, interests, and readiness to learn. See the section [Instructional Approaches](#) for more information.

- Fairness is not sameness.

In any given classroom, students may demonstrate a wide range of strengths and needs. Teachers plan programs that are attuned to this diversity and use an integrated process of assessment and instruction that responds to the unique strengths and needs of each student. An approach that combines principles of universal design and differentiated instruction enables educators to provide personalized, precise teaching and learning experiences for all students.

In planning programs or courses for students with special education needs, teachers should begin by examining both the curriculum expectations in the grade or course appropriate for the individual student and the student’s particular strengths and learning needs to determine which of the following options is appropriate for the student:

- no accommodations³ or modified expectations; or
- accommodations only; or
- modified expectations, with the possibility of accommodations; or
- alternative expectations, which are not derived from the curriculum expectations for the grade or course and which constitute alternative programs and/or courses.

If the student requires either accommodations or modified expectations, or both, the relevant information, as described in the following paragraphs, must be recorded in their Individual Education Plan (IEP). More detailed information about planning programs for students with special education needs, including students who require alternative programs⁴ and/or courses, can be found in *Special Education in Ontario, Kindergarten to Grade 12: Policy and Resource Guide, 2017 (Draft)* (referred to hereafter as *Special Education in Ontario, 2017*). For a detailed discussion of the ministry’s requirements for IEPs, see Part E of *Special Education in Ontario*.

Students Requiring Accommodations Only

Some students with special education needs are able, with certain “accommodations”, to participate in the regular grade or course curriculum and to demonstrate learning independently. Accommodations allow the student with special education needs to access the curriculum without changes to the regular expectations. Any accommodations that are required to facilitate the student’s learning must be identified in the student’s IEP (*Special Education in*

³ “Accommodations” refers to individualized teaching and assessment strategies, human supports, and/or individualized equipment (see *Growing Success: Assessment, Evaluation, and Reporting in Ontario Schools, First Edition, Covering Grades 1 to 12, 2010*, p. 72).

⁴ Alternative programs are identified on the IEP by the term “alternative (ALT)”.

Ontario, 2017, p. E38). A student's IEP is likely to reflect the same required accommodations for many, or all, subjects or courses.

Providing accommodations to students with special education needs should be the first option considered in program planning. Instruction based on principles of universal design and differentiated instruction focuses on providing accommodations to meet the diverse needs of learners.

There are three types of accommodations:

- *Instructional accommodations* are changes in teaching strategies, including styles of presentation, methods of organization, or use of technology and multimedia. Some examples include the use of graphic organizers, photocopied notes, adaptive equipment, or assistive software.
- *Environmental accommodations* are changes that the student may require in the classroom and/or school environment, such as preferential seating or special lighting.
- *Assessment accommodations* are changes in assessment procedures that enable the student to demonstrate their learning, such as allowing additional time to complete tests or assignments or permitting oral responses to test questions.

(For more examples, see page E39 of *Special Education in Ontario, 2017*.)

If a student requires “accommodations only”, assessment and evaluation of their achievement will be based on the regular grade or course curriculum expectations and the achievement levels outlined for the particular curriculum. The IEP box on the student's Provincial Report Card will not be checked, and no information on the provision of accommodations will be included.

Students Requiring Modified Expectations

Modified expectations for most students with special education needs will be based on the regular grade or course expectations, with changes in the number and/or complexity of the expectations. Modified expectations must represent specific, realistic, observable, and measurable goals, and must describe specific knowledge and/or skills that the student can demonstrate independently, given the appropriate assessment accommodations.

It is important to monitor, and to reflect clearly in the student's IEP, the extent to which expectations have been modified. At the secondary level, the principal will determine whether achievement of the modified expectations constitutes successful completion of the course, and will decide whether the student is eligible to receive a credit for the course. This decision must be communicated to the parents and the student.

Modified expectations must indicate the knowledge and/or skills that the student is expected to demonstrate and that will be assessed in each reporting period (*Special Education in Ontario, 2017*, p. E27). Modified expectations should be expressed in such a way that the student and parents can understand not only exactly what the student is expected to know or be able to demonstrate independently, but also the basis on which the student's performance will be evaluated, resulting in a grade or mark that is recorded on the Provincial Report Card. The student's learning expectations must be reviewed in relation to the student's progress at least once every reporting period, and must be updated as necessary (*Special Education in Ontario, 2017*, p. E28).

If a student requires modified expectations, assessment and evaluation of their achievement will be based on the learning expectations identified in the IEP and on the achievement levels outlined under [Levels of Achievement](#) in the "Assessment and Evaluation" section.

Elementary: The IEP box on the Elementary Progress Report Card and the Elementary Provincial Report Card must be checked for any subject in which the student requires modified expectations, and, on the Elementary Provincial Report Card, the appropriate statement from *Growing Success: Assessment, Evaluation, and Reporting in Ontario Schools, First Edition, Covering Grades 1 to 12, 2010*, page 61, must be inserted.

Secondary: If some of the student's learning expectations for a course are modified but the student is working towards a credit for the course, it is sufficient simply to check the IEP box on the Provincial Report Card, Grades 9–12. If, however, the student's learning expectations are modified to such an extent that the principal deems that a credit will not be granted for the course, the IEP box must be checked and the appropriate statement from *Growing Success: Assessment, Evaluation, and Reporting in Ontario Schools, First Edition, Covering Grades 1 to 12, 2010*, pages 62–63, must be inserted.

In both the elementary and secondary panels, the teacher's comments should include relevant information on the student's demonstrated learning of the modified expectations, as well as next steps for the student's learning in the subject or course.

Planning for English Language Learners

English Language Learners in Ontario Schools

Ontario schools have some of the most multilingual student populations in the world. The first language of approximately 28 per cent of the students in Ontario's English-language schools is a language other than English. In addition, some students use varieties of English – sometimes referred to as dialects – that differ significantly from the English required for success in Ontario

schools. Many English language learners were born in Canada and have been raised in families and communities in which languages other than English, or varieties of English that differ from the language used in the classroom, are spoken. Other English language learners arrive in Ontario as newcomers from other countries; they may have experience of highly sophisticated educational systems, or they may have come from regions where access to formal schooling was limited.

When they start school in Ontario, many of these students are entering a new linguistic and cultural environment. All teachers share in the responsibility for these students' English-language development.

As students who are learning English as a second or additional language in English-language schools, English language learners bring a rich diversity of background knowledge and experience to the classroom. These students' linguistic and cultural backgrounds not only support their learning in their new environment but also become a cultural asset in the classroom community. Effective teachers find positive ways to incorporate this diversity into their instructional programs and into the classroom environment.

Most English language learners in Ontario schools have age-appropriate proficiency in their first language, as well as age-appropriate literacy skills. Although they need frequent opportunities to use English at school, they also derive important educational and social benefits from continuing to develop their first language while they are learning English. Teachers should encourage parents to continue to use their own language at home, both to preserve the language as part of their children's heritage and identity and to provide a foundation for their language and literacy development in English. It is also important for teachers to find opportunities to bring students' languages into the classroom, using parents and community members as a resource.

English as a Second Language and English Literacy Development Programs

During their first few years in Ontario schools, English language learners may receive support through one of two distinct programs designed to meet their language-learning needs:

English as a Second Language (ESL) programs are for students born in Canada or newcomers whose first language is a language other than English, or is a variety of English significantly different from that used for instruction in Ontario schools. Students in these programs have had educational opportunities to develop age-appropriate first-language literacy skills.

English Literacy Development (ELD) programs are primarily for newcomers whose first language is a language other than English, or is a variety of English significantly different from that used for instruction in Ontario schools, and who arrive with significant gaps in their education. These students generally come from countries where access to education is limited or where there

are limited opportunities to develop language and literacy skills in any language. Schooling in their countries of origin may have been inconsistent, disrupted, or even completely unavailable throughout the years that these children would otherwise have been in school.

Supportive Learning Environments

In planning programs for students with linguistic backgrounds other than English, teachers need to recognize the importance of the orientation process, understanding that every learner needs to adjust to the new social environment and language in a unique way and at an individual pace. For example, students who are in an early stage of English-language acquisition may go through a “silent period” during which they closely observe the interactions and physical surroundings of their new learning environment. They may use body language rather than speech or they may use their first language until they have gained enough proficiency in English to feel confident of their interpretations and responses. Students thrive in a safe, supportive, and welcoming environment that nurtures their self-confidence while they are receiving focused literacy instruction. When they are ready to participate, in paired, small-group, or whole-class activities, some students will begin by using a single word or phrase to communicate a thought, while others will speak quite fluently.

In a supportive learning environment, most students will develop oral language proficiency quite quickly. Teachers can sometimes be misled by the high degree of oral proficiency demonstrated by many English language learners in their use of everyday English and may mistakenly conclude that these students are equally proficient in their use of academic English. Most English language learners who have developed oral proficiency in everyday English will still require instructional scaffolding to meet curriculum expectations. Research has shown that it takes five to seven years for most English language learners to catch up to their English-speaking peers in their ability to use English for academic purposes.

Program Adaptations

Responsibility for students’ English-language development is shared by all teachers, including the ESL/ELD teacher (where available), and other school staff. Volunteers and peers may also be helpful in supporting English language learners in the classroom. By adapting the instructional program, teachers facilitate these students’ learning. Appropriate adaptations include modifications and accommodations, as follows:

- modification of some or all of the grade or course expectations so that they are challenging but attainable for the learners at their current level of English proficiency, with the necessary support from the teacher;

- use of a variety of instructional strategies;⁵
- use of a variety of learning resources;⁶
- use of assessment accommodations that support students in demonstrating the full range of their learning.⁷

Teachers need to adapt the program for English language learners as they acquire English proficiency. For English language learners at the early stages of English language acquisition, teachers are required to modify curriculum expectations as needed. Most English language learners require accommodations for an extended period, long after they have achieved proficiency in everyday English.

Assessment and Evaluation

When curriculum expectations are modified in order to meet the language-learning needs of English language learners, assessment and evaluation will be based on the documented modified expectations. Teachers will check the ESL/ELD box on the Provincial Report Card only when modifications have been made to curriculum expectations to address the language needs of English language learners (the box should *not* be checked to indicate simply that they are participating in ESL/ELD programs or if they are only receiving accommodations). There is no requirement for a statement to be added to the “Comments” section of the report cards when the ESL/ELD box is checked.

Although the degree of program adaptation required will decrease over time, students who are no longer receiving ESL or ELD support may still need some program adaptations to be successful.

⁵ Examples include: small-group instruction; extensive use of visual cues, images, diagrams; visual representations of key ideas; graphic organizers; scaffolding; previewing of text; modelling; use of music, movement, and gestures; open-ended activities; pre-teaching of key vocabulary; peer tutoring; strategic use of students’ first languages.

⁶ Examples include: visual material; simplified text; bilingual dictionaries; subject-specific glossaries; resources available in languages that students speak at home; concrete materials; learning materials and activities – displays, music, dances, games, and so on – that reflect cultural diversity.

⁷ Examples include: provision of additional time; provision of options for students to choose how they will demonstrate their learning, such as portfolios, oral interviews, presentations, oral or visual representations, demonstrations and models, dramatic activities, and songs and chants; use of tasks requiring completion of graphic organizers or cloze sentences instead of essay questions or other assessment tasks that depend heavily on proficiency in English.

Related Policy and Resource Documents

For further information on supporting English language learners, refer to the following documents:

- [*Growing Success: Assessment, Evaluation, and Reporting in Ontario Schools, First Edition, Covering Grades 1 to 12, 2010*](#)
- [*The Ontario Curriculum, Grades 9–12: English as a Second Language and English Literacy Development, 2007*](#)
- [*English Language Learners – ESL and ELD Programs and Services: Policies and Procedures for Ontario Elementary and Secondary Schools, Kindergarten to Grade 12, 2007*](#)
- [*Supporting English Language Learners with Limited Prior Schooling: A Practical Guide for Ontario Educators, Grades 3 to 12, 2008*](#)
- [*Supporting English Language Learners: A Practical Guide for Ontario Educators, Grades 1 to 8, 2008*](#)
- [*Many Roots, Many Voices: Supporting English Language Learners in Every Classroom, 2005.*](#)

Healthy Relationships

Every student is entitled to learn in a safe, caring environment, free from discrimination, violence, and harassment. Research has shown that students learn and achieve better in such environments. A safe and supportive social environment in a school is founded on healthy relationships – the relationships between students, between students and adults, and between adults. Healthy relationships are based on respect, caring, empathy, trust, and dignity, and thrive in an environment in which diversity is honoured and accepted. Healthy relationships do not tolerate abusive, controlling, violent, bullying/harassing, or other inappropriate behaviours. To experience themselves as valued and connected members of an inclusive social environment, students need to be involved in healthy relationships with their peers, educators, and other members of the school community.

Several provincial policies, programs, and initiatives, including [Foundations for a Healthy School](#), the [Equity and Inclusive Education Strategy](#), and [Safe Schools](#), are designed to foster caring and safe learning environments in the context of healthy and inclusive schools. These policies and initiatives promote positive learning and teaching environments that support the development of healthy relationships, encourage academic achievement, and help all students reach their full potential.

In its 2008 report, [Shaping a Culture of Respect in Our Schools: Promoting Safe and Healthy Relationships](#), the Safe Schools Action Team confirmed “that the most effective way to enable

all students to learn about healthy and respectful relationships is through the school curriculum” (p. 11). Educators can promote this learning in a variety of ways. For example, by giving students opportunities to apply critical thinking and problem-solving strategies and to address issues through group discussions, role play, case study analysis, and other means, they can help them develop and practise the skills they need for building healthy relationships. Co-curricular activities such as clubs and intramural and interschool sports provide additional opportunities for the kind of interaction that helps students build healthy relationships. Educators can also have a positive influence on students by modelling the behaviours, values, and skills that are needed to develop and sustain healthy relationships, and by taking advantage of “teachable moments” to address immediate relationship issues that may arise among students.

Human Rights, Equity, and Inclusive Education

A positive, inclusive, equitable, and non-discriminatory elementary and secondary school experience is vitally important to a student’s personal, social, and academic development, to their future economic security, and to a realization of their full potential. Human rights principles recognize the importance of creating a climate of understanding and mutual respect for the dignity and worth of each person, so that each person can contribute fully to the development and well-being of their community. Indeed, human rights law guarantees a person’s right to equal treatment in education. It requires educators and school leaders to prevent and respond appropriately to discrimination and harassment, to create an inclusive environment, to remove barriers that limit the ability of students, and to provide accommodations, where necessary.

Ontario’s education system, at all levels, must respect diversity, promote inclusive education, and work towards identifying and eliminating barriers to equal treatment in education that limit the ability of students to learn, grow, and contribute to society. Discriminatory biases, harassment, non-inclusive environments, lack of accommodation, systemic barriers, power dynamics, societal poverty, and racism make it difficult for students to acquire the skills they need to be successful, competitive, and productive members of society. Ontario schools aim to improve the academic outcomes and experiences of students who have traditionally not benefited from the promise of public education.

In an environment based on the principles of inclusive education, all students, parents, caregivers, and other members of the school community – regardless of ancestry, culture, ethnicity, sex, disability, race, colour, religion, age, marital or family status, creed, gender identity/expression, gender, sexual orientation, socio-economic status, or other factors – are welcomed, included, treated fairly, and respected. Diversity is valued when all members of the

school community feel safe, welcomed, and accepted. Every student is supported and inspired to succeed in a culture of high expectations for learning.

Research has shown that students who do not see themselves reflected in what they are learning, in their classrooms, and in their schools become disengaged and do not experience as great a sense of well-being or as high a level of academic achievement as those who do.

Culturally Responsive and Relevant Pedagogy (CRRP)

In an inclusive education system, students must see themselves reflected in the curriculum, their physical surroundings, and the broader environment, so that they can feel engaged in and empowered by their learning experiences. Students need to experience teaching and learning that reflect their needs and who they are. To ensure that this happens, educators in Ontario schools embrace *culturally responsive and relevant pedagogy (CRRP)*, which recognizes that all students learn in ways that are connected to background, language, family structure, and social or cultural identity.

CRRP provides a framework for building positive environments, improving student responsibility and success, encouraging parent-school relationships, and building strong community connections. It also emphasizes that it is important for educators and school leaders to examine their own biases and to analyse how their own identities and experiences affect how they view, understand, and interact with all students. This can help to prevent discrimination, harassment, and the creation of poisoned environments. Educators are responsible for meaningful teaching and learning that recognizes and responds to *who is in the classroom and the school*.

By knowing “who our students are”, educators and leaders can tailor policies, programs, and practices to better meet the needs of their diverse student populations, to provide accommodation of the needs specified by human rights law, and to ensure that every student has the opportunity to succeed. CRRP involves recognizing that “culture” encompasses various aspects of social and personal identity. It also means acknowledging students’ multiple social and personal identities and the social issues that arise where identities intersect. The CRRP approach is designed to spark conversation and support educators and school leaders as they seek to implement effective equity strategies and policies. Educators are encouraged to engage in meaningful inquiry, in collaboration with colleagues, to address equity issues and the particular needs of the students they serve.

Implementing Principles of Inclusive Education

The implementation of inclusive education principles in education influences all aspects of school life. It promotes a school climate that encourages all students to work to high levels of

achievement, affirms the worth of all students, and helps students strengthen their sense of identity and develop a positive self-image. It encourages staff and students alike to value and show respect for diversity in the school and the broader society. Inclusive education promotes equity, healthy relationships, and active, responsible citizenship. The absence of inclusive approaches to education can create discriminatory environments, in which certain individuals or groups cannot expect to receive fair treatment or an equitable experience based on aspects of their identity.

Teachers can give students a variety of opportunities to learn about diversity and diverse perspectives. By drawing attention to the contributions and perspectives of historically marginalized groups, and by creating opportunities for their experiences to be affirmed and valued, teachers can enable students from a wide range of backgrounds to see themselves reflected in the curriculum. It is essential that learning activities and materials used to support the curriculum reflect the diversity of Ontario society. In addition, teachers should differentiate instruction and assessment strategies to take into account the background and experiences, as well as the interests, aptitudes, and learning needs, of all students.

Interactions between the school and the community should reflect the diversity of both the local community and the broader society. A variety of strategies can be used to communicate with and engage parents and members of diverse communities, and to encourage their participation in and support for school activities, programs, and events. Family and community members should be invited to take part in teacher interviews, the school council, and the parent involvement committee, and to attend and support activities such as plays, concerts, co-curricular activities and events, and various special events at the school. Schools need to be prepared and ready to welcome families and community members. Schools may consider offering assistance with child care or making alternative scheduling arrangements in order to help caregivers participate. Special outreach strategies and encouragement may be needed to draw in the parents of English language learners and First Nations, Métis, or Inuit students, and to make them feel more welcomed in their interactions with the school.

The Role of the School Library

The school library program can help build and transform students' knowledge in order to support lifelong learning in our information- and knowledge-based society. The school library program supports student success across the curriculum by encouraging students to read widely, teaching them to examine and read many forms of text for understanding and enjoyment, and helping them improve their research skills and effectively use information gathered through research.

The school library program enables students to:

- develop a love of reading for learning and for pleasure;
- develop literacy skills using fiction and non-fiction materials;
- develop the skills to become independent, thoughtful, and critical researchers;
- obtain access to programs, resources, and integrated technologies that support all curriculum areas;
- understand and value the role of public library systems as a resource for lifelong learning.

The school library program plays a key role in the development of information literacy and research skills. Teacher-librarians, where available, collaborate with classroom or content-area teachers to design, teach, and provide students with authentic information and research tasks that foster learning, including the ability to:

- access, select, gather, process, critically evaluate, create, and communicate information;
- use the information obtained to explore and investigate issues, solve problems, make decisions, build knowledge, create personal meaning, and enrich their lives;
- communicate their findings to different audiences, using a variety of formats and technologies;
- use information and research with understanding, responsibility, and imagination.

In addition, teacher-librarians can work with content-area teachers to help students:

- develop digital literacy in using non-print forms, such as the Internet, social media, and blogs, and knowing the best ways to access relevant and reliable information;
- design inquiry questions for research projects;
- create and produce single-medium or multimedia presentations.

Teachers need to discuss with students the concept of ownership of work and the importance of copyright in all forms of media.

The Role of Information and Communications Technology

The variety and range of information and communications technology (ICT) tools available to educators today enables them to significantly extend and enrich their instructional approaches and to create opportunities for students to learn in ways that best suit their interests and strengths. Technology has also enhanced the ability to connect with communities outside the school, making it possible to engage a diversity of community partners in student learning.

Rich opportunities can be tapped to support students in developing [digital literacy](#), an essential transferable skill.

Education and Career/Life Planning

The goals of the Kindergarten to Grade 12 education and career/life planning program are to:

- ensure that all students develop the knowledge and skills they need to make informed education and career/life choices;
- provide classroom and school-wide opportunities for this learning; and
- engage parents and the broader community in the development, implementation, and evaluation of the program, to support students in their learning.

The framework of the program is a four-step inquiry process based on four questions linked to four areas of learning: (1) Knowing Yourself – Who am I?; (2) Exploring Opportunities – What are my opportunities?; (3) Making Decisions and Setting Goals – Who do I want to become?; and (4) Achieving Goals and Making Transitions – What is my plan for achieving my goals?

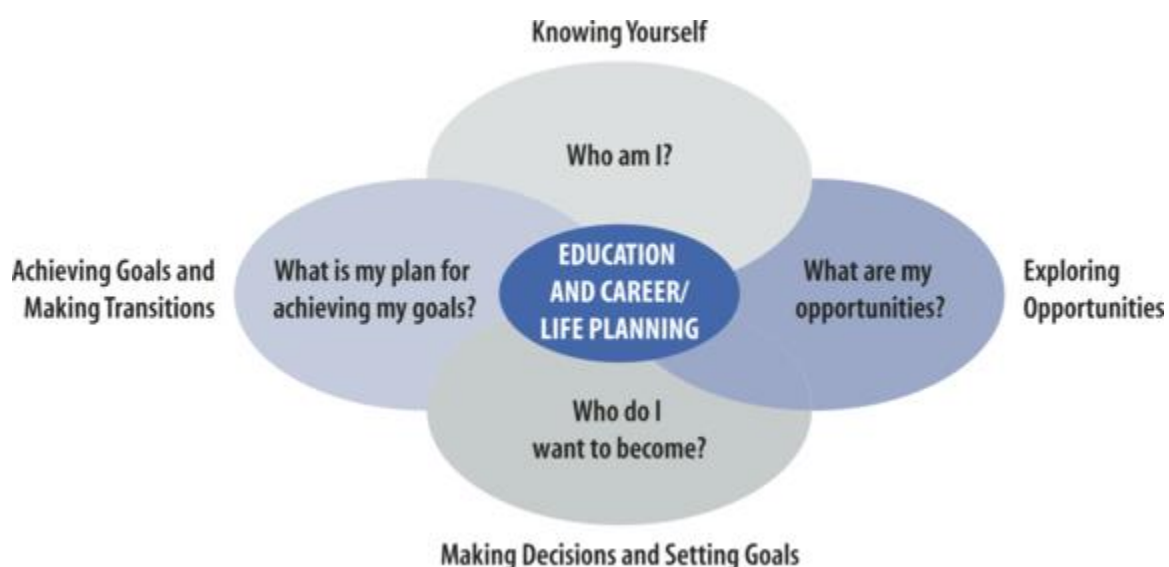

The curriculum expectations in most subjects and disciplines of the Ontario curriculum provide opportunities to relate classroom learning to the education and career/life planning program as outlined in *Creating Pathways to Success: An Education and Career/Life Planning Program for Ontario Schools – Policy and Program Requirements, Kindergarten to Grade 12, 2013*. All classroom teachers support students in education and career/life planning by providing them with learning opportunities, filtered through the lens of the four inquiry questions, that allow them to reflect on and apply subject-specific knowledge and skills; explore subject-related education and career/life options; and become competent, self-directed planners who will be prepared for success in school, life, and work. Education and career/life planning will support students in their transition from secondary school to their initial postsecondary destination, whether it be in apprenticeship training, college, community living, university, or the workplace.

For more information on postsecondary pathway choices, see the Ministry of Education web page [Planning for Independence: Community Living Skills](#), and the [Education and Training and Skilled Trades](#) pages on the Ontario government website.

Experiential Learning

Experiential learning is hands-on learning that occurs in person or virtually and provides developmentally appropriate opportunities for students of all ages to:

- **participate** in rich experiences connected to the world outside the school;
- **reflect** on the experiences to derive meaning; and
- **apply** the learning to their decisions and actions.

Adapted from David A. Kolb, *Experiential Learning: Experience as the Source of Learning and Development*, 2nd ed. (Upper Saddle River, N.J.: Pearson Education, 2015)

Planned learning experiences in the community may include outdoor education, project/program-based learning, job shadowing and job twin-ning, field trips, field studies, work experience, and cooperative education. These experiences provide opportunities for students to see the relevance of their classroom learning and its connection to the broader world. They also help them develop transferable and interpersonal skills and work habits that prepare them for their future, and enable them to explore careers of interest as they plan their pathway through school to their postsecondary destination, whether in apprenticeship training, college, community living, university, or the workplace.

Experiential learning opportunities associated with various aspects of the curriculum help broaden students' knowledge of themselves and of a range of career opportunities – two areas of learning outlined in [Creating Pathways to Success: An Education and Career/Life Planning Program for Ontario Schools – Policy and Program Requirements, Kindergarten to Grade 12, 2013](#). The key to providing successful experiential learning opportunities is to ensure that the experiential learning cycle (participate, reflect, apply) is a planned part of the experience.

In secondary school, pathways programs that incorporate experiential learning are available to students. They include the following courses and programs:

- cooperative education courses, outlined in [The Ontario Curriculum, Grades 11–12: Cooperative Education, 2018](#)
- Ontario Youth Apprenticeship Program (OYAP) (see [“Prepare for Apprenticeship”](#) on the Ontario government website)
- [Specialist High Skills Major \(SHSM\)](#) program

- [Dual credit](#) programs

Pathways to a Specialist High Skills Major (SHSM)

The [Specialist High Skills Major \(SHSM\)](#) is a specialized, ministry-approved program that allows students in Grades 11 and 12 to focus their learning on a specific economic sector while meeting the requirements of the Ontario Secondary School Diploma (OSSD).

The SHSM program assists students in their transition from secondary school to apprenticeship training, college, university, or the workplace.

This program enables students to gain sector-specific skills and knowledge in engaging, career-related learning environments and to prepare in a focused way for graduation and postsecondary education, training, or employment.

Course offerings and program planning should support students who are pursuing specialized programs, including the SHSM program. Bundles of credits provide students with knowledge and skills that are connected with the specific sector of their SHSM program and that are required for success in their chosen destination.

Health and Safety

In Ontario, various laws, including the [Education Act](#), the [Occupational Health and Safety Act \(OHSA\)](#), [Ryan’s Law \(Ensuring Asthma Friendly Schools\), 2015](#), and [Sabrina’s Law, 2005](#), collectively ensure that school boards provide a safe and productive learning and work environment for both students and employees. Under the Education Act, teachers are required to ensure that all reasonable safety procedures are carried out in courses and activities for which they are responsible. Teachers should model safe practices at all times; communicate safety requirements to students in accordance with school board policies, Ministry of Education policies, and any applicable laws; and encourage students to assume responsibility for their own safety and the safety of others.

Concern for safety should be an integral part of instructional planning and implementation. Teachers are encouraged to review:

- their responsibilities under the [Education Act](#);
- their rights and responsibilities under the [Occupational Health and Safety Act](#);
- their school board’s health and safety policy for employees;

- their school board’s policies and procedures on student health and safety (e.g., on concussions; on medical conditions such as asthma; with respect to outdoor education excursions);
- relevant provincial subject association guidelines and standards for student health and safety, such as Ophea’s [Ontario Physical Activity Safety Standards in Education](#) (formerly the Ontario Physical Education Safety Guidelines);
- any additional mandatory requirements, particularly for higher-risk activities (e.g., field trips that involve water-based activities), including requirements for approvals (e.g., from the Supervisory Officer), permissions (e.g., from parents/guardians), and/or qualifications (e.g., proof of students’ successful completion of a swim test).

Wherever possible, potential risks should be identified and procedures developed to prevent or minimize, and respond to, incidents and injuries. School boards provide and maintain safe facilities and equipment, as well as qualified instruction. In safe learning environments, teachers will:

- be aware of up-to-date safety information;
- plan activities with safety as a primary consideration;
- inform students and parents of risks involved in activities;
- observe students to ensure that safe practices are being followed;
- have a plan in case of emergency;
- show foresight;
- act quickly.

Students should be made aware that health and safety is everyone’s responsibility – at home, at school, and in the community. Teachers should ensure that students have the knowledge and skills needed for safe participation in all learning activities. Students must be able to demonstrate knowledge of the equipment being used and the procedures necessary for its safe use. Health and safety resource guides for [Kindergarten to Grade 8](#) and for [Grades 9 to 12](#) provide the scope and sequence of Ontario curriculum expectations to assist teachers in bringing health and safety education into the classroom in every subject area. The guides identify expectations in the Ontario curriculum that can help students develop knowledge and skills related to health and safety (injury prevention and health protection), safe behaviours, and safe practices.

Learning outside the classroom, such as on field trips or during field studies, can provide a meaningful and authentic dimension to students’ learning experiences, but they also take the teacher and students out of the predictable classroom environment and into unfamiliar settings. Teachers must plan these activities carefully in accordance with their school board’s relevant policies and procedures and in collaboration with other school board staff (e.g., the principal, outdoor education lead, Supervisory Officer) to ensure students’ health and safety.

The information provided in this section is not exhaustive. Teachers are expected to follow school board health and safety policies and procedures.

Ethics

The Ontario curriculum provides varied opportunities for students to learn about ethical issues and to explore the role of ethics in both public and personal decision making. Students may make ethical judgements when evaluating evidence and positions on various issues, and when drawing their own conclusions about issues, developments, and events. Teachers may need to help students determine which factors they should consider when making such judgements. It is crucial that teachers provide support and supervision to students throughout the research and inquiry process, ensuring that students engaged in an inquiry are aware of potential ethical concerns and that they address such concerns in acceptable ways. Teachers may supervise students' use of surveys and/or interviews, for example, to confirm that their planned activities will respect the dignity, privacy, and confidentiality of their participants. When students' activities involve Indigenous communities and/or individuals, teachers need to ensure the appropriate use and protection of Indigenous knowledge. Teachers also supervise the choice of the research topics to protect students from exposure to information and/or perspectives for which they may not be emotionally or intellectually prepared (for example, where a student's investigation might involve personal interviews that could lead to the disclosure of abuse or other sensitive topics).

Teachers must thoroughly address the issues of plagiarism and cultural appropriation with students. In a digital world that provides quick access to abundant information, it is easy to copy the words, music, or images of others and present them as one's own. Even at the secondary level, students need to be reminded of the ethical issues related to plagiarism and appropriation. Before starting an inquiry, students should have an understanding of the range of forms of plagiarism and appropriation, from blatant to nuanced, as well as of their consequences. Students often struggle to find a balance between creating works in their own voice or style and acknowledging the work of others. It is not enough to tell them not to plagiarize or appropriate others' work, and to admonish those who do. Teachers need to explicitly teach all students how to use their own voice or style while appropriately acknowledging the work of others, using accepted forms of documentation.

Cross-curricular and integrated learning

Introduction

A variety of overarching perspectives, themes, and skills are intentionally incorporated by educators, on an ongoing basis, into teaching and learning across all subjects and disciplines of the curriculum – they are part of “cross-curricular learning”. Educators plan programs to include learning in these areas, which are relevant in the context of most curriculum subjects, and are critical to students in navigating their world. They range from environmental education, Indigenous education, and financial literacy to social-emotional learning, critical literacy, mathematical literacy, and STEM education. These various themes, perspectives, and skills are explored in this section.

Another approach to teaching and learning “across subjects” is called “integrated learning”. This approach differs from cross-curricular learning because it involves combining curriculum expectations from more than one subject in a single lesson, and evaluating student achievement of the expectations within the respective subjects from which they are drawn.

Scope and Sequence Resource Guides

“Scope and sequence” resource guides are compilations of existing curriculum expectations, from all subjects and disciplines, that relate to specific ministry priorities and initiatives. For example, scope and sequence resource guides have been developed for **environmental education** ([elementary](#) and [secondary](#)); **financial literacy** ([elementary](#) and [secondary](#)); **First Nations, Métis, and Inuit connections** ([elementary](#) and [secondary](#)); and **health and safety** ([elementary](#) and [secondary](#)).

These documents identify expectations that involve learning about the particular topic, as well as teacher supports that touch on the topic or that describe opportunities for addressing it. The teacher supports include the examples, sample questions, teacher prompts, student responses, and/or instructional tips that accompany the expectations and describe optional ways in which teachers can elicit the learning described in the expectation. Teachers can glean ideas from the teacher supports, based on their professional judgement and taking into account the interests of the students and the local communities represented in their classrooms, for incorporating learning about these topics across subjects. The scope and sequence resource guides can also support divisional/school planning on particular topics or issues across classrooms and grades.

Integrated Learning

Integrated learning engages students in a rich learning experience that helps them make connections across subjects and brings the learning to life. Integrated learning provides students with opportunities to work towards meeting expectations from two or more subjects within a single unit, lesson, or activity. It can be a solution to the problems of fragmented learning and isolated skill instruction, because it provides opportunities for students to learn and apply skills in meaningful contexts across subject boundaries. In such contexts, students have opportunities to develop their ability to think and reason and to transfer knowledge and skills from one subject area to another. Although the learning is integrated, *the specific knowledge and skills from the curriculum for each subject are taught.*

Elementary Curriculum

By linking expectations from different subjects within a single unit, lesson, or activity, elementary teachers can provide students with multiple opportunities to reinforce and demonstrate their knowledge and skills in a variety of contexts. Teachers then evaluate student achievement in terms of the individual expectations, towards assigning a grade for each of the subjects involved.

One example would be a unit linking expectations from the science and technology curriculum and from the social studies curriculum. Connections can be made between these curricula in a number of areas – for example, the use of natural resources, considered from a scientific and an economic perspective; variations in habitat and ecosystems across the regions of Canada, exploring both the biology and the geography of those regions; historical changes in technology; and the impact of science and technology on various peoples and on the environment. In addition, a unit combining science and technology and social studies expectations could teach inquiry/research skills common to the two subjects, while also introducing approaches unique to each.

Secondary Curriculum

Ontario's secondary curriculum is designed to provide opportunities for educators to integrate student learning across disciplines and subjects. Some secondary expectations are written to implicitly connect with and support content learning and skill development outlined in other curricula. For example, the secondary math and science curricula are aligned so that students can apply what they learn in math to what they are learning in the sciences. For instance, in Grade 11 and 12 math courses, students learn the mathematical concepts needed to support learning in chemistry and physics courses in those grades. As another example, expectations in social sciences and humanities are aligned with some of the expectations in the English curriculum.

Financial Literacy

The education system has a vital role to play in preparing young people to take their place as informed, engaged, and knowledgeable citizens in the global economy. Financial literacy education can provide the preparation Ontario students need to make informed decisions and choices in a complex and fast-changing financial world.

Because making informed decisions about economic and financial matters has become an increasingly complex undertaking in the modern world, students need to build knowledge and skills in a wide variety of areas. In addition to learning about the specifics of saving, spending, borrowing, and investing, students need to develop broader skills in problem solving, research and inquiry, decision making, critical thinking, and critical literacy related to financial issues, so that they can analyse and manage the risks that accompany various financial choices. They also need to develop an understanding of world economic forces and the effects of those forces at the local, national, and global level. In order to make wise choices, they will need to understand how such forces affect their own and their families' economic and financial circumstances. Finally, to become responsible citizens in the global economy, they will need to understand the social, environmental, and ethical implications of their own choices as consumers. For all of these reasons, financial literacy is an essential component of the education of Ontario students in a twenty-first century context – one that can help ensure that Ontarians will continue to prosper in the future.

Resource documents – [The Ontario Curriculum, Grades 4–8: Financial Literacy Scope and Sequence of Expectations, 2016](#) and [The Ontario Curriculum, Grades 9–12: Financial Literacy Scope and Sequence of Expectations, 2016](#) – have been prepared to assist teachers in bringing financial literacy into the classroom. These documents identify the curriculum expectations and related examples and prompts, in disciplines across the Ontario curriculum, through which students can acquire skills and knowledge related to financial literacy.

STEM Education

K–12 STEM education is the study of science, technology, engineering, and mathematics, including cross-curricular and/or integrative study, and the application of those subjects in real-world contexts. As students engage in STEM education, they develop [transferable skills](#) that they need to meet the demands of today's global economy and society.

STEM education helps students develop an understanding and appreciation of each of the core subjects of mathematics, science, and technological education. At the same time, it supports a more holistic understanding and application of skills and knowledge related to engineering

design and innovation. STEM learning integrates and applies concepts, processes, and ways of thinking associated with these subjects to design solutions to real-world problems.

Engineering design and innovation engages students in *applying* the principles of science, technology, and mathematics to develop economical and sustainable solutions to technical and complex societal problems to meet human needs.

Among the transferable skills developed through STEM education are computational thinking, coding, design thinking, innovating, use of the scientific method, scientific inquiry skills, and engineering design skills. These skills are in high demand in today's globally connected world, with its unprecedented advancements in technology.

Approaches to STEM education may vary across Ontario schools. STEM subjects may be taught separately, but with an effort to make cross-curricular connections a part of student learning. Problem-solving application projects may be designed to combine two or more STEM subjects. Alternatively, content from all four STEM subjects might be fully integrated to reinforce students' understanding of each subject, by enhancing their understanding of the interrelationships among them, and by providing the opportunity to apply a spectrum of knowledge and skills in novel ways in real-world contexts. As STEM education is implemented, it is important to engage diverse perspectives and ways of thinking, including those inherent in the arts and humanities. Diverse perspectives engage students in a variety of creative and critical thinking processes that are essential for developing innovative and effective solutions that impact communities or ecosystems.

A robust K–12 STEM education enables Ontario educators and students to become innovators and leaders of change in society and the workforce, and creates opportunities in our diverse communities to foster integrative thinking and problem solving.

Indigenous Education

To move forward on their learning journey, students must have a solid understanding of where we have been as a province and as a country. Consistent with Ontario's vision for Indigenous education, all students will have knowledge of the rich diversity of First Nations, Métis, and Inuit histories, cultures, perspectives, and contributions, as well as an awareness of the importance of Indigenous ways of knowing in a contemporary context. Ontario is committed to ensuring that First Nations, Métis, and Inuit survivors and communities bring their perspectives to students' learning about our shared history.

It is essential that learning activities and resources used to support Indigenous education are authentic and accurate and do not perpetuate culturally and historically inaccurate ideas and understandings. It is important for educators and schools to select resources that represent the

uniqueness of First Nations, Métis, and Inuit histories, perspectives, and world views authentically and respectfully. It is also important to select resources that reflect local Indigenous communities as well as First Nations, Métis, and Inuit individuals and communities from across Ontario and Canada. Resources that best support Indigenous education feature Indigenous voices and narratives and are developed by, or in collaboration with, First Nations, Métis, and Inuit communities. Schools can contact their board's Indigenous lead and work with their Indigenous Education Councils for assistance in evaluating and selecting resources.

Cultural Safety

It is important to create a learning environment that is respectful and that makes students feel safe and comfortable not only physically, socially, and emotionally but also in terms of their cultural heritage. A culturally safe learning environment is one in which students feel comfortable about expressing their ideas, opinions, and needs and about responding authentically to topics that may be culturally sensitive. Educators should be aware that some students may experience emotional reactions when learning about issues that have affected their own lives, their family, and/or their community, such as the legacy of the residential school system. Before addressing such topics in the classroom, teachers need to consider how to prepare and debrief students, and they need to ensure that appropriate resources are available to support students both inside and outside the classroom.

Literacy

Literacy is the ability to use language and images in rich and varied forms to read, write, listen, speak, view, represent, discuss, and think critically about ideas. Literacy enables us to share information and to interact with others. Literacy is an essential tool for personal growth and active participation in a democratic society.

Ontario Ministry of Education, *Paying Attention to Literacy: Six Foundations for Improvement in Literacy, K-12*, 2013

The Importance of Literacy

Literacy⁸ continues to evolve as the world changes and its demands shift and become more complex. A focus on literacy goes beyond traditional forms of reading and writing. Today's

⁸ This page has been adapted from Adolescent Literacy Learning, *Adolescent Literacy Guide: A Professional Learning Resource for Literacy, Grades 7–12. Revised 2016*, pages 4–19, and the *2016 Student Achievement Literacy Planning Resource: Grades 7–12*, page 7.

students live with technological innovations that previous generations never experienced. They are accustomed to receiving information quickly, and often in a non-linear format, and they may engage in social interactions using a variety of technologies.

Literacy skills are embedded in the expectations for all subjects and disciplines of the Ontario curriculum. Each subject provides opportunities for literacy development, often in specialized ways. Literacy needs to be explicitly taught in all subjects. Literacy demands, such as vocabulary acquisition and accessing and managing information, become more complex across subjects and disciplines as students progress through the grades.

The Scope of Literacy

In Ontario schools, all students are equipped with the literacy skills necessary to be critical and creative thinkers, effective meaning-makers and communicators, collaborative co-learners, and innovative problem-solvers. These are the skills that will enable them to achieve personal, career, and societal goals. Students develop literacy skills as they think, express, and reflect.

In every subject, before, during, and after they read, view, listen, speak, or write, students select and use a variety of literacy strategies and subject-specific processes. This helps them comprehend and organize information and ideas, and communicate meaning. Teachers assist students in learning and selecting appropriate literacy strategies based on assessment of their individual needs and learning preferences.

Students learn to think, express, and reflect in discipline-specific ways. Teachers purposefully teach students about the literacy demands of the particular subject area. Students learn the vocabulary and terminology that are unique to a particular subject area and must be able to interpret symbols, charts and diagrams. Cross-curricular and subject-specific literacy skills are essential to students' success in all subjects of the curriculum, and in all areas of their lives.

Critical Thinking and Critical Literacy

Critical thinking is the process of thinking about ideas or situations in order to understand them fully, identify their implications, make a judgement, and/or guide decision making. It is an essential transferable skill that enables students to become independent, informed, and responsible members of society, and so is a focus of learning across all subjects and disciplines. Critical thinking includes skills such as questioning, predicting, analysing, synthesizing, examining opinions, identifying values and issues, detecting bias, and distinguishing between alternatives. Students who are taught these skills become critical thinkers who can move beyond superficial conclusions to a deeper understanding of the issues they are examining.

They are able to engage in an inquiry process in which they explore complex and multifaceted issues, and questions for which there may be no clear-cut answers.

Students use critical-thinking skills when they assess, analyse, and/or evaluate the impact of something and when they form an opinion and support that opinion with a rationale. In order to think critically, students need to ask themselves effective questions in order to interpret information; detect bias in their sources; determine why a source might express a particular bias; examine the opinions, perspectives, and values of various groups and individuals; look for implied meaning; and use the information gathered to form a personal opinion or stance, or a personal plan of action with regard to making a difference.

Students approach critical thinking in various ways. Some students find it helpful to discuss their thinking, asking questions and exploring ideas. Other students may take time to observe a situation or consider a text carefully before commenting; they may prefer not to ask questions or express their thoughts orally while they are thinking.

Critical literacy is the term used to refer to a particular aspect of critical thinking. Critical literacy involves looking beyond the literal meaning of a text to determine what is present and what is missing, in order to analyse and evaluate the text's complete meaning and the author's intent. Critical literacy is concerned with issues related to fairness, equity, and social justice. Critically literate students adopt a critical stance, asking what view of the world the text advances and whether they find this view acceptable, who benefits from the text, and how the reader is influenced.

Critically literate students understand that meaning is not found in texts in isolation. People make sense of a text, or determine what a text means, in a variety of ways. Students therefore need to take into account: points of view (e.g., those of people from various cultures); context (e.g., the beliefs and practices of the time and place in which a text was created and those in which it is being read or viewed); the background of the person who is interacting with the text (e.g., upbringing, friends, communities, education, experiences); intertextuality (e.g., information that a reader or viewer brings to a text from other texts experienced previously); gaps in the text (e.g., information that is left out and that the reader or viewer must fill in); and silences in the text (e.g., the absence of the voices of certain people or groups).

Students who are critically literate are able, for example, to actively analyse media messages and determine possible motives and underlying messages. They are able to determine what biases might be contained in texts, media, and resource material and why that might be, how the content of these materials might be determined and by whom, and whose perspectives might have been left out and why. Only then are students equipped to produce their own interpretation of an issue. Opportunities should be provided for students to engage in a critical discussion of "texts", including books and textbooks, television programs, movies, documentaries, web pages, advertising, music, gestures, oral texts, newspaper and magazine

articles, letters, cultural text forms, stories, and other forms of expression. Such discussions empower students to understand the impact on members of society that was intended by the text's creators. Language and communication are never neutral: they are used to inform, entertain, persuade, and manipulate.

The literacy skill of *metacognition* supports students' ability to think critically through reflection on their own thought processes. Acquiring and using metacognitive skills has emerged as a powerful approach for promoting a focus on thinking skills in literacy and across all disciplines, and for empowering students with the skills needed to monitor their own learning. As they reflect on their strengths and needs, students are encouraged to advocate for themselves to get the support they need in order to achieve their goals.

Mathematical Literacy

Mathematical literacy is an individual's capacity to formulate, employ, and interpret mathematics in a variety of contexts. It includes reasoning mathematically and using mathematical concepts, procedures, facts, and tools to describe, explain, and predict phenomena. It assists individuals to recognize the role that mathematics plays in the world and to make the well-founded judgments and decisions needed by constructive, engaged, and reflective citizens.

Council of Ministers of Education, Canada (CMEC),
Measuring Up: Canadian Results of the OECD PISA Study, 2016, p. 10

The Importance of Mathematical Literacy⁹

Mathematical literacy involves more than executing procedures. It implies a knowledge base and the competence and confidence to apply this knowledge in the practical world. A mathematically literate person can estimate; interpret data; solve day-to-day problems; reason in numerical, graphical, and geometric situations; and communicate using mathematics.

As knowledge expands and the economy evolves, more people are working with technologies or working in settings where mathematics is a cornerstone. Problem solving, the processing of information, and communication are becoming routine job requirements. Outside the workplace, mathematics arises in many everyday situations. Mathematical literacy is necessary both at work and in daily life.

⁹ Adapted from *Leading Math Success: Mathematical Literacy, Grades 7–12 – The Report of the Expert Panel on Student Success in Ontario*, 2004, pages 10 and 24.

Mathematical literacy is as important as proficiency in reading and writing. Mathematics is so entwined with today's way of life that we cannot fully comprehend the information that surrounds us without a basic understanding of mathematical ideas. Confidence and competence in mathematics lead to productive participation in today's complex information society, and open the door to opportunity.

The Scope of Mathematical Literacy

Mathematical literacy encompasses the ability to:

- estimate in numerical or geometric situations
- know and understand mathematical concepts and procedures
- question, reason, and solve problems
- make connections within mathematics and between mathematics and life
- generate, interpret, and compare data
- communicate mathematical reasoning

Mathematical literacy has several dimensions – for example, numerical literacy, spatial literacy, and data literacy – and extends beyond the mathematics classroom to other fields of study.

Teachers should take advantage of the abundant opportunities that exist for fostering mathematical literacy across the curriculum. All teachers have a responsibility to communicate the view that all students can and should do mathematics.

Environmental Education

Environmental education is both the responsibility of the entire education community and a rich opportunity for cross-curricular learning. It can be taught across subjects and grades, providing context that can enrich and enliven learning in all subject areas. It also provides opportunities for critical thinking, learning about citizenship, and developing personal responsibility. It offers students the opportunity to develop a deeper understanding of themselves, their role in society, and their dependence on one another and on the Earth's natural systems.

The curriculum provides opportunities for students to learn about environmental processes, issues, and solutions, and to demonstrate their learning as they practise and promote environmental stewardship at school and in their communities.

Acting Today, Shaping Tomorrow: A Policy Framework for Environmental Education in Ontario Schools outlines an approach to environmental education that recognizes the need for all Ontario students to learn “in, about and/or for” the environment, and promotes environmental

responsibility on the part of students, school staff, and leaders at all levels of the education system.

Resource documents – [The Ontario Curriculum, Grades 1–8 and The Kindergarten Program: Environmental Education, Scope and Sequence of Expectations, 2017](#) and [The Ontario Curriculum, Grades 9–12: Environmental Education, Scope and Sequence of Expectations, 2017](#) – have been prepared to assist teachers in planning lessons that integrate environmental education with other subject areas. They identify curriculum expectations and related examples and prompts in disciplines across the Ontario curriculum that provide opportunities for student learning “in, about, and/or for” the environment. Teachers can use these documents to plan lessons that relate explicitly to the environment, or they can draw on them for opportunities to use the environment as the *context for learning*. These documents can also be used to make curriculum connections to school-wide environmental initiatives.

Social-Emotional Learning Skills

The development of social-emotional learning (SEL) skills helps students foster overall health and well-being, positive mental health, and the ability to learn, build resilience, and thrive.

Students will learn skills to:	So that they can:
<ul style="list-style-type: none"> • identify and manage emotions 	<ul style="list-style-type: none"> • express their feelings and understand the feelings of others
<ul style="list-style-type: none"> • recognize sources of stress and cope with challenges 	<ul style="list-style-type: none"> • develop personal resilience
<ul style="list-style-type: none"> • maintain positive motivation and perseverance 	<ul style="list-style-type: none"> • foster a sense of optimism and hope
<ul style="list-style-type: none"> • build relationships and communicate effectively 	<ul style="list-style-type: none"> • support healthy relationships and respect diversity
<ul style="list-style-type: none"> • develop self-awareness and self-confidence 	<ul style="list-style-type: none"> • develop a sense of identity and belonging
<ul style="list-style-type: none"> • think critically and creatively 	<ul style="list-style-type: none"> • make informed decisions and solve problems

Social-emotional learning skills are an explicit component of learning in the elementary health and physical education curriculum. However, there are opportunities for students to develop SEL skills in connection with their learning in all subjects and disciplines. Skills to support mental

health and well-being can be developed across the curriculum, in the context of school activities, at home, and in the community.

It is beneficial for students to make connections between SEL skills, [transferable skills](#), and learning skills and work habits (see [Growing Success](#), 2010, Chapter 2). Taken together, these interrelated skills support students' overall health and well-being, positive mental health, and the ability to learn and to become lifelong learners. They enhance students' experience in school and beyond, preparing them to succeed personally and to become economically productive and actively engaged citizens. [School Mental Health Ontario](#) (SMHO) has resources to support the development of social-emotional learning in Ontario schools.

Transferable skills

Introduction

The Importance of Transferable Skills in the Curriculum

Today’s graduates will enter a world that is more competitive, more globally connected, and more technologically engaged than it has been in any other period of history. Over the course of the next decade, millions of young Canadians will enter a workforce that is dramatically different from the one we know today. With the growing automation of jobs, extraordinary technological advancements, and the realities of a global economy, students will need to be prepared for job flexibility, frequent career re-orientation, and work and civic life in a globalized, digital age. Equipping students with transferable skills and a desire for lifelong learning will help to prepare them for these new realities, and to navigate and shape their future successfully.

Transferable skills are the skills and attributes that students need in order to thrive in the modern world. Based on international research, information provided by employers, and its work with jurisdictions across Canada, the Ontario Ministry of Education has defined seven important categories of transferable skills – sometimes referred to as “competencies”¹⁰ – that will help students navigate the world of work and meet with success in the future:

- critical thinking and problem solving
- innovation, creativity, and entrepreneurship
- self-directed learning
- communication
- collaboration
- global citizenship and sustainability
- digital literacy

¹⁰ These categories of transferable skills are aligned with the [six “global competencies”](#) developed collaboratively by ministers of education across Canada on the basis of the competencies outlined in *21st Century Competencies: Foundation Document for Discussion* (Ontario Ministry of Education, 2016). The global competencies were then published by the Council of Ministers of Education, Canada (CMEC) as part of an effort to prepare students across the nation for a complex and unpredictable future with rapidly changing political, social, economic, technological, and environmental landscapes. The new categories of transferable skills outlined here have been updated on the basis of current research, and a seventh category – “digital literacy” – has been added.

These seven broad categories of skills, necessary in today’s rapidly changing world, can be seen as a framework encompassing the wide range of discrete transferable skills that students acquire over time. Developing transferable skills essentially means “learning for transfer” – that is, taking what is learned in one situation and applying it to other, new situations. Students in Ontario schools “learn for transfer” in all of the subjects and disciplines of the Ontario curriculum, from Kindergarten to Grade 12. In fact, in every grade and subject, their learning is assessed, in part, in terms of their ability to apply or transfer what they have learned to familiar and new contexts (see the category “Application” in the [Sample Achievement Charts](#)). The curriculum provides opportunities for students to develop transferable skills in age- and grade-appropriate ways throughout their school years. Students develop transferable skills not in isolation but as part of their learning in all subjects of the curriculum. These skills are developed through students’ cognitive, social, emotional, and physical engagement in learning. Educators facilitate students’ development of transferable skills explicitly through a variety of teaching and learning methods, models, and approaches, and assessment practices, in a safe, inclusive, and equitable learning environment.

Critical Thinking and Problem Solving

Definition

Critical thinking and problem solving involve locating, processing, analysing, and interpreting relevant and reliable information to address complex issues and problems, make informed judgements and decisions, and take effective action. With critical thinking skills comes an awareness that solving problems can have a positive impact in the world, and this contributes to achieving one’s potential as a constructive and reflective citizen. Learning is deepened when it occurs in the context of authentic and meaningful real-world experiences.

Student Descriptors

- Students engage in inquiry processes that include locating, processing, interpreting, synthesizing, and critically analysing information in order to solve problems and make informed decisions. These processes involve critical, digital, and data literacy.
- Students solve meaningful and complex real-life problems by taking concrete steps – identifying and analysing the problem, creating a plan, prioritizing actions to be taken, and acting on the plan – as they address issues and design and manage projects.
- Students detect patterns, make connections, and transfer or apply what they have learned in a given situation to other situations, including real-world situations.
- Students construct knowledge and apply what they learn to all areas of their lives – at school, home, and work; among friends; and in the community – with a focus on making connections and understanding relationships.

- Students analyse social, economic, and ecological systems to understand how they function and how they interrelate.

Innovation, Creativity, and Entrepreneurship

Definition

Innovation, creativity, and entrepreneurship support the ability to turn ideas into action in order to meet the needs of a community. These skills include the capacity to develop concepts, ideas, or products for the purpose of contributing innovative solutions to economic, social, and environmental problems. Developing these skills involves a willingness to assume leadership roles, take risks, and engage in independent, unconventional thinking in the context of experimenting, conducting research, and exploring new strategies, techniques, and perspectives. An entrepreneurial mindset understands the importance of building and scaling ideas for sustainable growth.

Student Descriptors

- Students formulate and express insightful questions and opinions to generate novel ideas.
- Students contribute solutions to economic, social, and environmental problems in order to meet a need in a community by: enhancing concepts, ideas, or products through a creative process; taking risks in their creative thinking as they devise solutions; making discoveries through inquiry research, by testing hypotheses and experimenting with new strategies or techniques.
- Students demonstrate leadership, initiative, imagination, creativity, spontaneity, and ingenuity as they engage in a range of creative processes, motivating others with their ethical entrepreneurial spirit.

Self-Directed Learning

Definition

Self-directed learning involves becoming aware of and managing one's own process of learning. It includes developing dispositions that support motivation, self-regulation, perseverance, adaptability, and resilience. It also calls for a growth mindset – a belief in one's ability to learn – combined with the use of strategies for planning, reflecting on, and monitoring progress towards one's goals, and reviewing potential next steps, strategies, and results. Self-reflection

and thinking about thinking (metacognition) support lifelong learning, adaptive capacity, well-being, and the ability to transfer learning in an ever-changing world.

Student Descriptors

- Students learn to think about their own thinking and learning (metacognition) and to believe in their ability to learn and grow (growth mindset). They develop their ability to set goals, stay motivated, and work independently.
- Students who regulate their own learning are better prepared to become lifelong learners. They reflect on their thinking, experiences, and values, and respond to critical feedback, to enhance their learning. They also monitor the progress of their learning.
- Students develop a sense of identity in the context of Canada’s various and diverse communities.
- Students cultivate emotional intelligence to better understand themselves and others and build healthy relationships.
- Students learn to take the past into account in order to understand the present and approach the future in a more informed way.
- Students develop personal, educational, and career goals and persevere to overcome challenges in order to reach those goals. They learn to adapt to change and become resilient in the face of adversity.
- Students become managers of the various aspects of their lives – cognitive, emotional, social, physical, and spiritual – to enhance their mental health and overall well-being.

Collaboration

Definition

Collaboration involves the interplay of the cognitive (thinking and reasoning), interpersonal, and intrapersonal competencies needed to work with others effectively and ethically. These skills deepen as they are applied, with increasing versatility, to co-construct knowledge, meaning, and content with others in diverse situations, both physical and virtual, that involve a variety of roles, groups, and perspectives.

Student Descriptors

- Students participate successfully in teams by building positive and respectful relationships, developing trust, and acting cooperatively and with integrity.
- Students learn from others and contribute to their learning as they co-construct knowledge, meaning, and content.

- Students assume various roles on the team, respect a diversity of perspectives, and recognize different sources of knowledge, including Indigenous ways of knowing.
- Students address disagreements and manage conflict in a sensitive and constructive manner.
- Students interact with a variety of communities and/or groups and use various technologies appropriately to facilitate working with others.

Communication

Definition

Communication involves receiving and expressing meaning (e.g., through reading and writing, viewing and creating, listening and speaking) in different contexts and with different audiences and purposes. Effective communication increasingly involves understanding local and global perspectives and societal and cultural contexts, and using a variety of media appropriately, responsibly, safely, and with a view to creating a positive digital footprint.

Student Descriptors

- Students communicate effectively in different contexts, orally and in writing, using a variety of media.
- Students communicate using the appropriate digital tools, taking care to create a positive digital footprint.
- Students ask effective questions to acquire knowledge; listen to all points of view and ensure that those views are heard; voice their own opinions; and advocate for ideas.
- Students learn about a variety of languages, including Indigenous languages, and understand the cultural importance of language.

Global Citizenship and Sustainability

Definition

Global citizenship and sustainability involves understanding diverse world views and perspectives in order to effectively address the various political, environmental, social, and economic issues that are central to living sustainably in today's interconnected and interdependent world. It also involves acquiring the knowledge, motivation, dispositions, and skills required for engaged citizenship, along with an appreciation of the diversity of people and perspectives in the world. It calls for the ability to envision and work towards a better and more sustainable future for all.

Student Descriptors

- Students understand the political, environmental, economic, and social forces at play in the world today, how they interconnect, and how they affect individuals, communities, and countries.
- Students make responsible decisions and take actions that support quality of life for all, now and in the future.
- Students recognize discrimination and promote principles of equity, human rights, and democratic participation.
- Students recognize the traditions, knowledge, and histories of Indigenous peoples, appreciate their historical and contemporary contributions to Canada, and recognize the legacy of residential schools.
- Students learn from and with people of diverse cultures and backgrounds and develop cross-cultural understanding.
- Students engage in local, national, and global initiatives to make a positive difference in the world.
- Students contribute to society and to the culture of local, national, and global communities, both physical and virtual, in a responsible, inclusive, sustainable, ethical, and accountable manner.
- Students, as citizens, participate in various groups and online networks in a safe and socially responsible manner.

Digital Literacy

Definition

Digital literacy involves the ability to solve problems using technology in a safe, legal, and ethically responsible manner. With the ever-expanding role of digitalization and big data in the modern world, digital literacy also means having strong data literacy skills and the ability to engage with emerging technologies. Digitally literate students recognize the rights and responsibilities, as well as the opportunities, that come with living, learning, and working in an interconnected digital world.

Student Descriptors

- Students select and use appropriate digital tools to collaborate, communicate, create, innovate, and solve problems.
- Students understand how to manage and regulate their use of technology to support their mental health and well-being.

- Students use digital tools to define and plan data searches, collect data, and identify relevant data sets. They analyse, interpret, and graphically represent, or “visualize”, data in various ways to solve problems and inform decisions.
- Students demonstrate a willingness and confidence to explore and use new or unfamiliar digital tools and emerging technologies (e.g., open source software, wikis, robotics, augmented reality). Students understand how different technologies are connected and recognize their benefits and limitations.
- Students manage their digital footprint by engaging in social media and online communities respectfully, inclusively, safely, legally, and ethically. Students understand their rights with respect to personal data and know how to protect their privacy and security and respect the privacy and security of others.
- Students analyse and understand the impact of technological advancements on society, and society’s role in the evolution of technology.

Assessment and Evaluation

Introduction

Growing Success: Assessment, Evaluation, and Reporting in Ontario Schools, First Edition, Covering Grades 1 to 12, 2010 sets out the Ministry of Education’s assessment, evaluation, and reporting policy. The policy aims to maintain high standards, improve student learning, and benefit students, parents, and teachers in elementary and secondary schools across the province. Successful implementation of this policy depends on the professional judgement¹¹ of educators at all levels as well as on their ability to work together and to build trust and confidence among parents and students.

A brief summary of some major aspects of the current assessment, evaluation, and reporting policy is given below. Teachers should refer to *Growing Success* for more detailed information.

Fundamental Principles

The primary purpose of assessment and evaluation is to improve student learning.

The seven fundamental principles given below (excerpted from *Growing Success*, page 6) lay the foundation for rich and challenging practice. When these principles are fully understood and observed by all teachers, they will guide the collection of meaningful information that will help inform instructional decisions, promote student engagement, and improve student learning.

To ensure that assessment, evaluation, and reporting are valid and reliable, and that they lead to the improvement of learning for all students, teachers use practices and procedures that:

- are fair, transparent, and equitable;
- support all students;

¹¹ “Professional judgement”, as defined in *Growing Success* (p. 152), is “judgement that is informed by professional knowledge of curriculum expectations, context, evidence of learning, methods of instruction and assessment, and the criteria and standards that indicate success in student learning. In professional practice, judgement involves a purposeful and systematic thinking process that evolves in terms of accuracy and insight with ongoing reflection and self-correction”.

- are carefully planned to relate to the curriculum expectations and learning goals and, as much as possible, to the interests, learning styles and preferences, needs, and experiences of all students;
- are communicated clearly to students and parents at the beginning of the school year or course and at other appropriate points throughout the school year or course;
- are ongoing, varied in nature, and administered over a period of time to provide multiple opportunities for students to demonstrate the full range of their learning;
- provide ongoing descriptive feedback that is clear, specific, meaningful, and timely to support improved learning and achievement;
- develop students' self-assessment skills to enable them to assess their own learning, set specific goals, and plan next steps for their learning.

Learning Skills and Work Habits

The development of learning skills and work habits is an integral part of a student's learning. To the extent possible, however, the evaluation of learning skills and work habits, apart from any that may be included as part of a curriculum expectation in a course, should *not* be considered in the determination of a student's grades. Assessing, evaluating, and reporting on the achievement of curriculum expectations and on the demonstration of learning skills and work habits *separately* allows teachers to provide information to the parents and student that is specific to each of these two areas.

The six learning skills and work habits are responsibility, organization, independent work, collaboration, initiative, and self-regulation.

Content Standards and Performance Standards

The Ontario curriculum for Grades 1 to 12 comprises *content standards* and *performance standards*. Assessment and evaluation will be based on both the content standards and the performance standards.

The content standards are the overall and specific curriculum expectations given in the curriculum for every subject and discipline.

The performance standards are outlined in the achievement chart, also provided in the curriculum for every subject and discipline (each achievement chart is specific to the subject/discipline; see the [sample charts provided](#)). The achievement chart is a standard province-wide guide and is to be used by all teachers as a framework for assessing and evaluating student achievement of the expectations in the particular subject or discipline. It

enables teachers to make consistent judgements about the quality of student learning, based on clear performance standards and on a body of evidence collected over time. It also provides teachers with a foundation for developing clear and specific feedback for students and parents.

The purposes of the achievement chart are to:

- provide a common framework that encompasses all curriculum expectations for all subjects/courses across the grades;
- guide the development of high-quality assessment tasks and tools (including rubrics);
- help teachers plan instruction for learning;
- provide a basis for consistent and meaningful feedback to students in relation to provincial content and performance standards;
- establish categories and criteria for assessing and evaluating students' learning.

Assessment "for Learning" and "as Learning"

Assessment is the process of gathering information that accurately reflects how well a student is achieving the curriculum expectations in a grade or course. The primary purpose of assessment is to improve student learning. Assessment for the purpose of improving student learning is seen as both "assessment *for* learning" and "assessment *as* learning". As part of assessment *for* learning, teachers provide students with descriptive feedback and coaching for improvement. Teachers engage in assessment *as* learning by helping all students develop their capacity to be independent, autonomous learners who are able to set individual goals, monitor their own progress, determine next steps, and reflect on their thinking and learning.

As essential steps in assessment *for* learning and *as* learning, teachers need to:

- plan assessment concurrently and integrate it seamlessly with instruction;
- share learning goals and success criteria with students at the outset of learning to ensure that students and teachers have a common and shared understanding of these goals and criteria as learning progresses;
- gather information about student learning before, during, and at or near the end of a period of instruction, using a variety of assessment strategies and tools;
- use assessment to inform instruction, guide next steps, and help students monitor their progress towards achieving their learning goals;
- analyse and interpret evidence of learning;
- give and receive specific and timely descriptive feedback about student learning;
- help students to develop skills of peer assessment and self-assessment.

Evaluation

Evaluation refers to the process of judging the quality of student learning on the basis of established performance standards, and assigning a value to represent that quality. Evaluation accurately summarizes and communicates to parents, other teachers, employers, institutions of further education, and students themselves what students know and can do with respect to the overall curriculum expectations. Evaluation is based on assessment *of* learning that provides evidence of student achievement at strategic times throughout the course, often at the end of a period of learning.

All curriculum expectations must be accounted for in instruction and assessment, but *evaluation focuses on students' achievement of the overall expectations*. Each student's achievement of the overall expectations is evaluated on the basis of the student's achievement of related specific expectations. The overall expectations are broad in nature, and the specific expectations define the particular content or scope of the knowledge and skills referred to in the overall expectations. Teachers will use their professional judgement to determine which specific expectations should be used to evaluate achievement of the overall expectations, and which ones will be accounted for in instruction and assessment but not necessarily evaluated.

Determining a report card grade involves the interpretation of evidence collected through observations, conversations, and student products (tests/exams, assignments for evaluation), combined with the teacher's professional judgement and consideration of factors such as the number of tests/exams or assignments for evaluation that were not completed or submitted and the fact that some evidence may carry greater weight than other evidence.

Secondary

Seventy per cent of the final grade (a percentage mark) in a course will be based on evaluation conducted throughout the course. This portion of the grade should reflect the student's most consistent level of achievement, with special consideration given to more recent evidence. Thirty per cent will be based on a final evaluation administered at or towards the end of the course. This evaluation will be based on evidence from one or a combination of the following: an examination, a performance, an essay, and/or another method of evaluation suitable to the course content. The final evaluation allows the student an opportunity to demonstrate comprehensive achievement of the overall expectations for the course.

Reporting Student Achievement

Elementary

Three formal report cards are issued in Ontario’s publicly funded elementary schools, as described below.

The Elementary Progress Report Card shows a student’s development of learning skills and work habits during the fall of the school year, as well as the student’s general progress in working towards achievement of the curriculum expectations in each subject (reported as “progressing very well”, “progressing well”, or “progressing with difficulty”).

The Elementary Provincial Report Card shows a student’s achievement at specific points in the school year. The first Provincial Report Card reflects student achievement of the overall curriculum expectations introduced and developed from September to January/February of the school year, as well as the student’s development of learning skills and work habits during that period. The second reflects achievement of curriculum expectations introduced or further developed from January/February to June, as well as further development of learning skills and work habits during that period. The Provincial Report Card for Grades 1–6 uses letter grades; the report card for Grades 7 and 8 uses percentage grades.

Secondary

The Provincial Report Card, Grades 9–12, shows a student’s achievement at specific points in the school year or semester. There are two formal reporting periods for a semestered course and three formal reporting periods for a non-semestered course. The reports reflect student achievement of the overall curriculum expectations, as well as development of learning skills and work habits.

Communication with parents and students

Although there are formal reporting periods, communication with parents and students about student achievement should be continuous throughout the year or course, by a variety of means, such as parent-teacher or parent-student-teacher conferences, portfolios of student work, student-led conferences, interviews, phone calls, checklists, and informal reports. Communication about student achievement should be designed to provide detailed information that will encourage students to set goals for learning, help teachers to establish plans for teaching, and assist parents in supporting learning at home.

Categories of Knowledge and Skills

The categories represent four broad areas of knowledge and skills within which the expectations for any given subject or course can be organized. The four categories should be considered as interrelated, reflecting the wholeness and interconnectedness of learning.

The categories help teachers focus not only on students' acquisition of knowledge but also on their development of the skills of thinking, communication, and application.

The categories of knowledge and skills are as follows:

Knowledge and Understanding. Subject-specific content acquired in each grade or course (knowledge), and the comprehension of its meaning and significance (understanding).

Thinking. The use of critical and creative thinking skills and/or processes.

Communication. The conveying of meaning and expression through various forms.

Application. The use of knowledge and skills to make connections within and between various contexts.

In all subjects and courses, students should be given numerous and varied opportunities to demonstrate the full extent of their achievement of the curriculum expectations across all four categories of knowledge and skills.

Teachers will ensure that student learning is assessed and evaluated in a balanced manner with respect to the four categories, and that achievement of particular expectations is considered within the appropriate categories. The emphasis on “balance” reflects the fact that all categories of the achievement chart are important and need to be a part of the process of instruction, learning, assessment, and evaluation. However, it also indicates that for different courses, the *relative* importance of each of the categories may vary. The importance accorded to each of the four categories in assessment and evaluation should reflect the emphasis accorded to them in the curriculum expectations for the subject or course and in instructional practice.

Criteria and Descriptors

To further guide teachers in their assessment and evaluation of student learning, the achievement chart provides “criteria” and “descriptors”.

A set of criteria is identified for each category in the achievement chart. The criteria are subsets of the knowledge and skills that define the category. The criteria identify the aspects of student

performance that are assessed and/or evaluated, and they serve as a guide to what teachers look for. Each curriculum has subject- or discipline-specific criteria and descriptors. For example, in the English curriculum, in the Knowledge and Understanding category, the criteria are “knowledge of content” and “understanding of content”. The former includes examples such as forms of text and elements of style, and the latter includes examples such as relationships among facts. “Descriptors” indicate the characteristics of the student’s performance, with respect to a particular criterion, on which assessment or evaluation is focused. *Effectiveness* is the descriptor used for each of the criteria in the Thinking, Communication, and Application categories. What constitutes effectiveness in any given performance task will vary with the particular criterion being considered. Assessment of effectiveness may therefore focus on a quality such as appropriateness, clarity, accuracy, precision, logic, relevance, significance, fluency, flexibility, depth, or breadth, as appropriate for the particular criterion.

Levels of Achievement

The achievement chart also identifies four levels of achievement, defined as follows:

Level 1 represents achievement that falls much below the provincial standard. The student demonstrates the specified knowledge and skills with limited effectiveness. Students must work at significantly improving in specific areas, as necessary, if they are to be successful in a subject or course in the next grade.

Level 2 represents achievement that approaches the standard. The student demonstrates the specified knowledge and skills with some effectiveness. Students performing at this level need to work on identified learning gaps to ensure future success.

Level 3 represents the provincial standard for achievement. The student demonstrates the specified knowledge and skills with considerable effectiveness. Parents of students achieving at level 3 can be confident that their children will be prepared for work in subsequent grades or courses.

Level 4 identifies achievement that surpasses the provincial standard. The student demonstrates the specified knowledge and skills with a high degree of effectiveness. *However, achievement at level 4 does not mean that the student has achieved expectations beyond those specified for the grade or course.*

Specific “qualifiers” are used with the descriptors in the achievement chart to describe student performance at each of the four levels of achievement – the qualifier *limited* is used for level 1; *some* for level 2; *considerable* for level 3; and *a high degree of* or *thorough* for level 4. Hence, achievement at level 3 in the Thinking category for the criterion “use of planning skills” would

be described in the achievement chart as “[The student] uses planning skills with *considerable* effectiveness”.

Sample Achievement Charts

Three samples of the achievement chart are provided, from the following subjects/disciplines:

- The Arts, Grades 1–8
- Science and Technology, Grades 1–8
- English, Grades 9–12

These three samples illustrate the consistent characteristics of the performance standards across all subjects and disciplines and across all grades. The samples also illustrate how the achievement chart varies – particularly with respect to the examples provided for the criteria in each category – to reflect the nature of the particular subject or discipline. For instance, the examples for the criterion “Application of knowledge and skills” in the Application category of the achievement chart for the arts include performance skills, composition, and choreography, whereas those for science and technology include investigation skills and safe use of equipment and technology.

As discussed in the preceding sections, the achievement chart identifies four categories of knowledge and skills and four levels of achievement in the particular subject/discipline.

The Achievement Chart for The Arts, Grades 1–8

Knowledge and Understanding – Subject-specific content acquired in each grade (knowledge), and the comprehension of its meaning and significance (understanding)				
Categories	Level 1	Level 2	Level 3	Level 4
	The student:			
Knowledge of content <i>(e.g., facts, genres, terms, definitions, techniques, elements, principles, forms, structures, conventions)</i>	demonstrates limited knowledge of content	demonstrates some knowledge of content	demonstrates considerable knowledge of content	demonstrates thorough knowledge of content
Understanding of content <i>(e.g., concepts, ideas, procedures, processes, themes, relationships)</i>	demonstrates limited understanding of content	demonstrates some understanding of content	demonstrates considerable understanding of content	demonstrates thorough understanding of content

<i>among elements, informed opinions)</i>				
Thinking – The use of critical and creative thinking skills and/or processes				
Categories	Level 1	Level 2	Level 3	Level 4
	The student:			
Use of planning skills <i>(e.g., formulating questions, generating ideas, gathering information, focusing research, outlining, organizing an arts presentation or project, brainstorming/ bodystorming, blocking, sketching, using visual organizers, listing goals in a rehearsal log, inventing notation)</i>	uses planning skills with limited effectiveness	uses planning skills with some effectiveness	uses planning skills with considerable effectiveness	uses planning skills with a high degree of effectiveness
Use of processing skills <i>(e.g., analysing, evaluating, inferring, interpreting, editing, revising, refining, forming conclusions, detecting bias, synthesizing)</i>	uses processing skills with limited effectiveness	uses processing skills with some effectiveness	uses processing skills with considerable effectiveness	uses processing skills with a high degree of effectiveness
Use of critical/creative thinking processes <i>(e.g., creative and analytical processes, design process, exploration of the elements, problem solving, reflection, elaboration, oral discourse, evaluation, critical literacy, metacognition,</i>	uses critical/creative thinking processes with limited effectiveness	uses critical/creative thinking processes with some effectiveness	uses critical/creative thinking processes with considerable effectiveness	uses critical/creative thinking processes with a high degree of effectiveness

<i>invention, critiquing, reviewing)</i>				
Communication – The conveying of meaning through various forms				
Categories	Level 1	Level 2	Level 3	Level 4
	The student:			
Expression and organization of ideas and understandings in art forms (dance, drama, music, and the visual arts), including media/multimedia forms (e.g., expression of ideas and feelings using visuals, movements, the voice, gestures, phrasing, techniques), and in oral and written forms (e.g., clear expression and logical organization in critical responses to art works and informed opinion pieces)	expresses and organizes ideas and understandings with limited effectiveness	expresses and organizes ideas and understandings with some effectiveness	expresses and organizes ideas and understandings with considerable effectiveness	expresses and organizes ideas and understandings with a high degree of effectiveness
Communication for different audiences (e.g., peers, adults, younger children) and purposes through the arts (e.g., drama presentations, visual arts exhibitions, dance and music performances) and in oral and written forms (e.g., debates, analyses)	communicates for different audiences and purposes with limited effectiveness	communicates for different audiences and purposes with some effectiveness	communicates for different audiences and purposes with considerable effectiveness	communicates for different audiences and purposes with a high degree of effectiveness
Use of conventions in dance, drama, music, and the visual arts	uses conventions, vocabulary,	uses conventions, vocabulary,	uses conventions, vocabulary,	uses conventions, vocabulary,

<i>(e.g., allegory, narrative or symbolic representation, style, articulation, drama conventions, choreographic forms, movement vocabulary) and arts vocabulary and terminology in oral and written forms</i>	and terminology of the arts with limited effectiveness	and terminology of the arts with some effectiveness	and terminology of the arts with considerable effectiveness	and terminology of the arts with a high degree of effectiveness
Application – The use of knowledge and skills to make connections within and between various contexts				
Categories	Level 1	Level 2	Level 3	Level 4
	The student:			
Application of knowledge and skills <i>(e.g., performance skills, composition, choreography, elements, principles, processes, technologies, techniques, strategies, conventions) in familiar contexts</i> <i>(e.g., guided improvisation, performance of a familiar work, use of familiar forms)</i>	applies knowledge and skills in familiar contexts with limited effectiveness	applies knowledge and skills in familiar contexts with some effectiveness	applies knowledge and skills in familiar contexts with considerable effectiveness	applies knowledge and skills in familiar contexts with a high degree of effectiveness
Transfer of knowledge and skills <i>(e.g., concepts, strategies, processes, techniques) to new contexts</i> <i>(e.g., a work requiring stylistic variation, an original composition, student-led choreography, an interdisciplinary or</i>	transfers knowledge and skills to new contexts with limited effectiveness	transfers knowledge and skills to new contexts with some effectiveness	transfers knowledge and skills to new contexts with considerable effectiveness	transfers knowledge and skills to new contexts with a high degree of effectiveness

<i>multidisciplinary project)</i>				
Making connections within and between various contexts (<i>e.g., between the arts; between the arts and personal experiences and the world outside the school; between cultural and historical, global, social, and/or environmental contexts; between the arts and other subjects</i>)	makes connections within and between various contexts with limited effectiveness	makes connections within and between various contexts with some effectiveness	makes connections within and between various contexts with considerable effectiveness	makes connections within and between various contexts with a high degree of effectiveness

The Achievement Chart for Science and Technology, Grades 1–8

Knowledge and Understanding – Subject-specific content acquired in each grade (knowledge), and the comprehension of its meaning and significance (understanding)				
Categories	Level 1	Level 2	Level 3	Level 4
	The student:			
Knowledge of content (<i>e.g., facts; terminology; definitions; safe use of tools, equipment, and materials</i>)	demonstrates limited knowledge of content	demonstrates some knowledge of content	demonstrates considerable knowledge of content	demonstrates thorough knowledge of content
Understanding of content (<i>e.g., concepts, ideas, theories, principles, procedures, processes</i>)	demonstrates limited understanding of content	demonstrates some understanding of content	demonstrates considerable understanding of content	demonstrates thorough understanding of content

Thinking and Investigation – The use of critical and creative thinking skills and inquiry and problem-solving skills and/or processes				
Categories	Level 1	Level 2	Level 3	Level 4
	The student:			
Use of initiating and planning skills and strategies (e.g., <i>formulating questions, identifying the problem, developing hypotheses, scheduling, selecting strategies and resources, developing plans</i>)	uses initiating and planning skills and strategies with limited effectiveness	uses initiating and planning skills and strategies with some effectiveness	uses initiating and planning skills and strategies with considerable effectiveness	uses initiating and planning skills and strategies with a high degree of effectiveness
Use of processing skills and strategies (e.g., <i>performing and recording, gathering evidence and data, observing, manipulating materials and using equipment safely, solving equations, proving</i>)	uses processing skills and strategies with limited effectiveness	uses processing skills and strategies with some effectiveness	uses processing skills and strategies with considerable effectiveness	uses processing skills and strategies with a high degree of effectiveness
Use of critical/creative thinking processes, skills, and strategies (e.g., <i>analysing, interpreting, problem solving, evaluating, forming and justifying conclusions on the basis of evidence</i>)	uses critical/creative thinking processes, skills, and strategies with limited effectiveness	uses critical/creative thinking processes, skills, and strategies with some effectiveness	uses critical/creative thinking processes, skills, and strategies with considerable effectiveness	uses critical/creative thinking processes, skills, and strategies with a high degree of effectiveness
Communication – The conveying of meaning through various forms				
Categories	Level 1	Level 2	Level 3	Level 4
	The student:			
Expression and organization of ideas and information in art forms (dance, drama, music, and the visual arts), including media/multimedia forms	expresses and organizes ideas and information with limited effectiveness	expresses and organizes ideas and information with some effectiveness	expresses and organizes ideas and information with considerable effectiveness	expresses and organizes ideas and information with a high degree of effectiveness

<i>(e.g., clear expression, logical organization) in oral, visual, and/or written forms (e.g., diagrams, models)</i>				
Communication for different audiences (e.g., peers, adults) and purposes (e.g., to inform, to persuade) in oral, visual, and/or written forms	communicates for different audiences and purposes with limited effectiveness	communicates for different audiences and purposes with some effectiveness	communicates for different audiences and purposes with considerable effectiveness	communicates for different audiences and purposes with a high degree of effectiveness
Use of conventions, vocabulary, and terminology of the discipline in oral, visual, and/or written forms (e.g., symbols, formulae, scientific notation, SI units)	uses conventions, vocabulary, and terminology of the discipline with limited effectiveness	uses conventions, vocabulary, and terminology of the discipline with some effectiveness	uses conventions, vocabulary, and terminology of the discipline with considerable effectiveness	uses conventions, vocabulary, and terminology of the discipline with a high degree of effectiveness
Application – The use of knowledge and skills to make connections within and between various contexts				
Categories	Level 1	Level 2	Level 3	Level 4
	The student:			
Application of knowledge and skills (e.g., concepts and processes, safe use of equipment and technology, investigation skills) in familiar contexts	applies knowledge and skills in familiar contexts with limited effectiveness	applies knowledge and skills in familiar contexts with some effectiveness	applies knowledge and skills in familiar contexts with considerable effectiveness	applies knowledge and skills in familiar contexts with a high degree of effectiveness
Transfer of knowledge and skills (e.g., concepts and processes, safe use of equipment and technology, investigation skills) to unfamiliar contexts	transfers knowledge and skills to unfamiliar contexts with limited effectiveness	transfers knowledge and skills to unfamiliar contexts with some effectiveness	transfers knowledge and skills to unfamiliar contexts with considerable effectiveness	transfers knowledge and skills to unfamiliar contexts with a high degree of effectiveness

Making connections between science, technology, society, and the environment <i>(e.g., assessing the impact of science and technology on people, other living things, and the environment)</i>	makes connections between science, technology, society, and the environment with limited effectiveness	makes connections between science, technology, society, and the environment with some effectiveness	makes connections between science, technology, society, and the environment with considerable effectiveness	makes connections between science, technology, society, and the environment with a high degree of effectiveness
Proposing courses of practical action to deal with problems relating to science, technology, society, and the environment	proposes courses of practical action of limited effectiveness	proposes courses of practical action of some effectiveness	proposes courses of practical action of considerable effectiveness	proposes highly effective courses of practical action

The Achievement Chart for English, Grades 9–12

Knowledge and Understanding – Subject-specific content acquired in each course (knowledge), and the comprehension of its meaning and significance (understanding)				
Categories	50 – 59% (Level 1)	60 – 69% (Level 2)	70 – 79% (Level 3)	80 – 100% (Level 4)
	The student:			
Knowledge of content <i>(e.g., forms of text; strategies used when listening and speaking, reading, writing, and viewing and representing; elements of style; literary terminology, concepts, and theories; language conventions)</i>	demonstrates limited knowledge of content	demonstrates some knowledge of content	demonstrates considerable knowledge of content	demonstrates thorough knowledge of content
Understanding of content <i>(e.g., concepts; ideas; opinions; relationships among facts, ideas, concepts, themes)</i>	demonstrates limited understanding of content	demonstrates some understanding of content	demonstrates considerable understanding of content	demonstrates thorough understanding of content

Thinking – The use of critical and creative thinking skills and/or processes				
Categories	50– 59% (Level 1)	60– 69% (Level 2)	70–79% (Level 3)	80 –100% (Level 4)
	The student:			
Use of planning skills <i>(e.g., generating ideas, gathering information, focusing research, organizing information)</i>	uses planning skills with limited effectiveness	uses planning skills with some effectiveness	uses planning skills with considerable effectiveness	uses planning skills with a high degree of effectiveness
Use of processing skills <i>(e.g., drawing inferences, interpreting, analysing, synthesizing, evaluating)</i>	uses processing skills with limited effectiveness	uses processing skills with some effectiveness	uses processing skills with considerable effectiveness	uses processing skills with a high degree of effectiveness
Use of critical/creative thinking processes <i>(e.g., oral discourse, research, critical analysis, critical literacy, metacognition, creative process)</i>	uses critical/creative thinking processes with limited effectiveness	uses critical/creative thinking processes with some effectiveness	uses critical/creative thinking processes with considerable effectiveness	uses critical/creative thinking processes with a high degree of effectiveness
Communication – The conveying of meaning through various forms				
Categories	50– 59% (Level 1)	60– 69% (Level 2)	70–79% (Level 3)	80 –100% (Level 4)
	The student:			
Expression and organization of ideas and information <i>(e.g., clear expression, logical organization)</i> in oral, graphic, and written forms, including media forms	expresses and organizes ideas and information with limited effectiveness	expresses and organizes ideas and information with some effectiveness	expresses and organizes ideas and information with considerable effectiveness	expresses and organizes ideas and information with a high degree of effectiveness
Communication for different audiences and purposes <i>(e.g., use of appropriate style, voice, point of view)</i> in oral, graphic, and written forms, including media forms	communicates for different audiences and purposes with limited effectiveness	communicates for different audiences and purposes with some effectiveness	communicates for different audiences and purposes with considerable effectiveness	communicates for different audiences and purposes with a high degree of effectiveness
Use of conventions <i>(e.g., grammar, spelling,</i>	uses conventions,	uses conventions,	uses conventions,	uses conventions,

<i>punctuation, usage), vocabulary, and terminology of the discipline in oral, graphic, and written forms, including media forms</i>	vocabulary, and terminology of the discipline with limited effectiveness	vocabulary, and terminology of the discipline with some effectiveness	vocabulary, and terminology of the discipline with considerable effectiveness	vocabulary, and terminology of the discipline with a high degree of effectiveness
Application – The use of knowledge and skills to make connections within and between various contexts				
Categories	50– 59% (Level 1)	60– 69% (Level 2)	70–79% (Level 3)	80 –100% (Level 4)
	The student:			
Application of knowledge and skills <i>(e.g., literacy strategies and processes; literary terminology, concepts, and theories) in familiar contexts</i>	applies knowledge and skills in familiar contexts with limited effectiveness	applies knowledge and skills in familiar contexts with some effectiveness	applies knowledge and skills in familiar contexts with considerable effectiveness	applies knowledge and skills in familiar contexts with a high degree of effectiveness
Transfer of knowledge and skills <i>(e.g., literacy strategies and processes; literary terminology, concepts, and theories) to new contexts</i>	transfers knowledge and skills to new contexts with limited effectiveness	transfers knowledge and skills to new contexts with some effectiveness	transfers knowledge and skills to new contexts with considerable effectiveness	transfers knowledge and skills to new contexts with a high degree of effectiveness
Making connections within and between various contexts <i>(e.g., between the text and personal knowledge and experience, other texts, and the world outside school)</i>	makes connections within and between various contexts with limited effectiveness	makes connections within and between various contexts with some effectiveness	makes connections within and between various contexts with considerable effectiveness	makes connections within and between various contexts with a high degree of effectiveness

Curriculum context

Preface

The Ontario Curriculum, Grades 1–8: Mathematics, 2020 focuses on fundamental mathematics concepts and skills, as well as on making connections between related math concepts, between mathematics and other disciplines, and between mathematics and everyday life. It also supports new learning about mathematical modelling, coding, and financial literacy, and integrates mathematics learning with learning in other STEM (science, technology, engineering, and mathematics) subjects. As well, this curriculum is designed to help students build confidence in approaching mathematics and acquire a positive attitude towards mathematics, cope with stress and anxiety, persevere and learn from their mistakes, work collaboratively with others towards a shared goal, value deep thinking and making connections, and become capable and confident math learners.

Vision and Goals

Recent research and practice have provided a clearer understanding of how students learn mathematical concepts and skills. In addition, technology has changed how we access information and how students interact with mathematics. All students bring to school their mathematical experiences learned in various contexts. Schools should take advantage of these various experiences so that mathematics classrooms become places of diverse and inclusive learning that value multiple ways of knowing and doing. These places will allow all students to become flexible and adaptive learners in an ever-changing world. The vision of the mathematics curriculum is to help all students develop a positive identity as a mathematics learner and see themselves as mathematically skilled, to support them as they use mathematics to make sense of the world, and to enable them to make critical decisions based on mathematically sound principles. This vision is attained in a mathematics classroom filled with enthusiasm and excitement – a classroom where all students receive the highest-quality mathematics instruction and learning opportunities, interact as confident mathematics learners, and are thereby enabled to reach their full potential.

Success in mathematics has often been viewed as an important indicator of career success. The goal of the Ontario mathematics curriculum is to provide all students with the foundational skills required to:

- understand the importance of and appreciate the beauty of mathematics;
- recognize and appreciate multiple mathematical perspectives;

- make informed decisions and contribute fully to their own lives and to today's competitive global community;
- adapt to changes and synthesize new ideas;
- work both independently and collaboratively to creatively approach challenges;
- communicate effectively;
- think critically and creatively and see connections to other disciplines beyond mathematics, such as other STEM disciplines.

In order to develop a strong understanding of mathematics, all students must feel that they are connected to the curriculum. They must see themselves in what is taught, in why it is taught, and in how it is taught. They must also see how their learning applies to their own context and to the world. The needs of learners are diverse, and all learners have the capacity to develop the knowledge, concepts, skills, and perspectives they need to become informed, productive, and responsible citizens in their own communities and in the world.

How mathematics is contextualized, positioned, promoted, discussed, taught, learned, evaluated, and applied affects all students. Mathematics must be appreciated for its innate beauty, as well as for its role in making sense of the world. Having a solid foundation in mathematics and a deep appreciation for and excitement about mathematics will help ensure that all students are confident and capable as they step into the future.

The Importance and Beauty of Mathematics

Mathematics is integral to every aspect of daily life – social, economic, cultural, and environmental. It is part of the story of human history. People around the world have used and continue to use mathematical knowledge, skills, and attitudes to make sense of the world around them and develop new mathematical thinking and appreciation for mathematics. The relationships between cultures and mathematics are conceptualized and practiced in many different ways across many different contexts. From counting systems, measurement, and calculation to arithmetic, geometry, and spatial sense, mathematics has been evident in the daily lives of people across history.

Today, mathematics continues to be found all around us. For example, mathematics can be found in medicine, sports performance analysis, navigation systems, electronic music production, computer gaming, quantum physics, fashion design, and so much more. Mathematics skills are necessary when we buy goods and services online, complete our taxes, create art, and play sports. Mathematics also exists in nature, storytelling, puzzles, and games. Proficiency with mathematical ideas is needed for many careers, including but not limited to engineering, health care and medicine, computer science, finance, landscape design, architecture, agriculture, the arts, the culinary arts, and many skilled trades. In fact, in every

field of pursuit, the analytical, problem-solving, critical-thinking, and creative-thinking skills that students develop through the study of mathematics are evident. In the modern age of evolving technologies, artificial intelligence, and access to vast sources of information and big data, knowing how to navigate, interpret, analyse, reason, evaluate, and problem solve is foundational to everyday life.

While mathematics can be understood as a way of studying and understanding structure, order, and relationships, the aesthetics of mathematics have also motivated the development of new mathematical thinking. The power of mathematics is evident in the connections between seemingly abstract mathematical ideas. The applications of mathematics have often yielded fascinating representations and results. The beauty in mathematics can be found in the process of deriving elegant and succinct approaches to resolving problems. Other times, messy problems and seeming chaos may culminate in beautiful, sometimes surprising, results that are both simple and generalizable. Most important, the beauty of mathematics is experienced when exciting breakthroughs in problem solving are made and an air of relief and awe is enjoyed. The two aspects of mathematics, aesthetics and application, are deeply interconnected.

The Ontario mathematics curriculum strives to equip all students with the knowledge, skills, and habits of mind that are essential to understanding and enjoying the importance and beauty of mathematics.

Learning in the mathematics curriculum begins with a focus on the fundamental concepts and foundational skills. This leads to an understanding of mathematical structures, operations, [processes](#), and language that provides students with the means necessary for reasoning, justifying conclusions, and expressing and communicating mathematical ideas clearly. Through relevant and meaningful learning opportunities and through the strategic use of technology, all students are supported as they learn and apply mathematical concepts and skills within and across strands and other subject areas.

The Ontario mathematics curriculum helps establish an inclusive mathematical learning community where all students are invited to experience the living practice of mathematics, to work through challenges, and to find success and beauty in problem solving. As students engage with the curriculum, they may incorporate their prior experience and existing mathematical understanding, and then integrate the new ideas they learn into their daily lives. As all students see themselves reflected in what is taught and how it is taught, they begin to view themselves as competent and confident mathematics learners. As a result, they develop improved mathematical knowledge, concepts, and skills as well as an improved sense of mathematical agency and identity. This encouragement of mathematical confidence subsequently opens doors for all students to explore the importance and beauty of mathematics while they make connections to other subjects, explore the world, and later pursue further studies.

Principles Underlying the Ontario Mathematics Curriculum

The Ontario mathematics curriculum for Grades 1 to 8 is founded on the following principles:

- **A mathematics curriculum is most effective when it values and celebrates the diversity that exists among students.**

The Ontario mathematics curriculum is based on the belief that all students can and deserve to be successful in mathematics. It recognizes that not all students necessarily learn mathematics in the same way, use the same resources, and/or learn within the same time frames. Setting high expectations and building a safe and inclusive community of learners requires the use of a variety of differentiated instructional and assessment strategies and approaches that create an optimal and equitable environment for mathematics learning.

- **A robust mathematics curriculum is essential for ensuring that all students reach their full potential.**

The Ontario mathematics curriculum challenges all students by including learning expectations that capitalize on students' prior knowledge; involve higher-order thinking skills; and require students to make connections between their lived experiences, mathematical concepts, other subject areas, and situations outside of school. This learning enables all students to gain a powerful knowledge of the usefulness of the discipline and an appreciation of the importance of mathematics.

- **A mathematics curriculum provides all students with the foundational mathematics concepts and skills they require to become capable and confident mathematics learners.**

The Ontario mathematics curriculum provides a balanced approach to the teaching and learning of mathematics. It is based on the belief that all students learn mathematics most effectively when they develop a solid understanding of the fundamental concepts and skills in mathematics and are given opportunities to apply these concepts and skills as they solve increasingly complex tasks and investigate mathematical ideas, applications, and situations in everyday contexts. As students begin to see the relevance of mathematics and to see themselves as capable mathematics learners, they begin to develop a positive identity as a mathematics learner.

- **A progressive mathematics curriculum includes the strategic integration of technology to support and enhance the learning and doing of mathematics.**

The Ontario mathematics curriculum strategically integrates the use of appropriate technologies to help all students develop mathematical knowledge, concepts, and skills, while recognizing the continuing importance of students' mastering the fundamentals of mathematics. For some students, assistive technology also provides an essential means of accessing the mathematics curriculum and demonstrating their learning. Students

develop the ability to select appropriate tools and strategies to perform particular tasks, to investigate ideas, and to solve problems. The curriculum sets out a framework for learning important skills, such as problem solving, coding, and modelling, as well as opportunities to develop critical data literacy skills, information literacy skills, and financial literacy skills.

- **A mathematics curriculum acknowledges that the learning of mathematics is a dynamic, gradual, and continuous process, with each stage building on the last.**

The Ontario mathematics curriculum is dynamic, continuous, and coherent and is designed to help all students develop an understanding of the universal coherence and nature of mathematics. Students see how concepts develop and how they are interconnected. Teachers observe and listen to all students and then responsively shape instruction in ways that will foster and deepen student understanding of important mathematics. The fundamental concepts, skills, and processes are introduced in the primary grades and solidified and extended throughout the junior and intermediate grades. The program is continuous, as well, from the elementary to the secondary level. Teachers connect mathematics to students' everyday experiences, which helps all students develop a deeper understanding of the relevance of mathematics to the world beyond the classroom. Students also come to understand that learning in mathematics never ends.

- **A mathematics curriculum is integrated with the world beyond the classroom.**

The Ontario mathematics curriculum provides opportunities for all students to investigate and experience mathematical situations they might find outside of the classroom and develop an appreciation for the beauty and wide-reaching nature and importance of mathematics. The overall program integrates and balances concept development and skill development, including [social-emotional learning skills](#), as well as the use of [mathematical processes](#) and real-life applications.

- **A mathematics curriculum motivates students to learn and to become lifelong learners.**

The Ontario mathematics curriculum is brought to life in the classroom, where students develop mathematical understanding and are given opportunities to relate their knowledge, concepts, and skills to wider contexts. Making connections to the world around them stimulates their interest and motivates them to become lifelong learners with positive attitudes towards mathematics. Teachers bring the mathematics curriculum to life using their knowledge of:

- the mathematics curriculum;
- the backgrounds and identities of all students, including their past and ongoing experiences with mathematics, learning strengths, and needs;
- mathematical concepts and skills, and how they are connected across the strands and with other disciplines;
- instructional approaches and assessment strategies best suited to meet the learning needs of all students;

- resources designed to support and to enhance the achievement of and engagement with the curriculum expectations, while fostering an appreciation for and joy in math learning.

Roles and Responsibilities in Mathematics Education

Students

It is essential that all students take responsibility for their own learning as they progress through elementary and secondary school. Mastering the skills and concepts connected with learning in the mathematics curriculum requires a commitment to learning that includes:

- continual and consistent personal reflection and goal setting
- a belief that they are capable of succeeding in mathematics
- developing skills in persevering when taking on new challenges
- connecting prior experiences, knowledge, skills, and habits of mind to new learning
- a willingness to work both collaboratively and independently
- dedication to ongoing practice
- an ability to receive and respond to meaningful feedback

Through ongoing practice and reflection, all students can develop a positive and healthy mathematical identity whereby they value and appreciate mathematics as a discipline, see themselves as mathematics learners, and understand what successful math learning looks like.

Students' attitudes towards mathematics education can have a significant impact on their engagement with math learning and their subsequent learning and achievement of the expectations. Students who are engaged in their learning and who have opportunities to solve interesting, relevant, and meaningful problems within a supportive, safe, and inclusive learning environment are more likely to adopt practices and behaviours that support mathematical thinking. More importantly, they are more likely to enjoy mathematics and to pursue their desire to learn math beyond the classroom setting.

With teacher support and encouragement, students learn that they can apply the skills they acquire in mathematics to other contexts and subjects. For example, they can apply the problem-solving skills they use in mathematics to their study of the science and social studies curricula. They can also make connections between their learning and life beyond the classroom. For example, when reading or watching the news, they can look for applications of mathematical modelling and how it can be used to answer important questions related to global health and the environment or to help solve critical social issues that are relevant to their lives and experiences.

Parents

Parents¹² are their children's first role models. It is important for schools and parents to work together to ensure that home and school provide a mutually supportive framework for young people's mathematics education. Research assures us of the positive results of parent engagement on student success – and parent-child communication about mathematics, including parents' fostering of positive attitudes towards mathematics, is one of the many important ways parents may be involved.

Parents can support their children's mathematics success by showing an interest in what their children are learning and by discovering with their children how what is being learned in class can be applied to everyday contexts. Math is everywhere, and parents can help their children make connections between what they are learning at school and everyday experiences at home and in the community – such as cooking at home, shopping at a store, and managing household finances. Parents can include their children when cooking at home by asking them to measure ingredients and to double or halve a recipe. They can include their children when making decisions at the grocery store by asking them to figure out what is the better deal and to estimate the total cost of items in their cart before proceeding to checkout. They can include their children in other ways – for example, when enjoying math-based puzzles and games – and they can create opportunities for mental math estimations and calculations and for making predictions. Parents can support their children's learning by encouraging them to complete their mathematics tasks, to practise new skills and concepts, to apply new mathematics learning to experiences at home, and to connect mathematical experiences at home to learning at school.

More importantly, parents are an integral part of their children's interactions and experiences with mathematics. Having a positive attitude towards mathematics and developing self-efficacy are important elements of students' achievement of the expectations and of all future mathematics learning. By demonstrating a positive attitude towards mathematics, and by speaking positively and often about mathematics, parents can show their children that mathematics is enjoyable, worthwhile, and valuable. Parents can encourage their children to cultivate perseverance when solving problems, to acknowledge any difficulties, to believe that they can succeed in math, and to build their own self-confidence and sense of identity as mathematics learners.

Schools offer a variety of opportunities for parents to learn more about how to support their children: for example, events related to mathematics may be held at the school (e.g., family

¹² The word *parent(s)* is used on this website to refer to parent(s) and guardian(s). It may also be taken to include caregivers or close family members who are responsible for raising the child.

math nights); teachers may provide newsletters or communicate with parents through apps or social media; and school or board websites may provide helpful tips about how parents can engage in their child's mathematics learning outside of school and may even provide links where they can learn more or enjoy math activities together.

If parents need more information about what their children are learning, and how to support their children's success in mathematics, teachers are available to answer questions and provide information and resources.

Teachers

Teachers are critical to the success of students in mathematics. Teachers are responsible for ensuring that all students receive the highest quality of mathematics education. This requires them to have high expectations of all students and to view all students as capable math learners. Teachers bring enthusiasm and skill in providing varied and equitable instructional and assessment approaches to the classroom, addressing individual students' identities, profiles, strengths and needs, and ensuring equitable, accessible, and engaging learning opportunities for every student. The attitude with which teachers themselves approach mathematics is critical, as teachers are important role models for students.

Teachers place students at the centre of their mathematics planning, teaching, and assessment practices, and understand how the learning experiences they provide will develop a love of mathematics and foster a positive "I can do math" attitude in all students. Teachers have a thorough understanding of the mathematics content they teach, which enables them to provide relevant and responsive opportunities through which all students can develop their understanding of mathematical knowledge, concepts, and skills. Teachers understand the learning continuum along which students develop their mathematical thinking and can thus support all students' movement along this continuum. Teachers support students in developing their ability to solve problems, reason mathematically, and connect the mathematics they are learning to the real world around them. Teachers provide ongoing meaningful feedback to all students about their mathematics achievement, which helps to build confidence. They recognize the importance of emphasizing the usefulness of mathematics in students' lives, and of integrating mathematics with other areas of the curriculum – such as making connections with science, engineering, and technology to answer scientific questions or solve problems. They recognize the importance of helping students learn about careers involving mathematics, and of supporting the development of a positive attitude towards mathematics and student mathematical agency.

As part of effective teaching practice, teachers communicate with parents, using multiple ways and by both formal and informal means to meet the diverse needs of families, and to better

understand students' mathematical experiences outside of the school. In addition, teachers discuss with parents what their children are learning in mathematics at school. Communication enables parents to work in partnership with the school, leading to stronger connections between the home and school to support student learning and achievement in mathematics.

Principals

Principals model the importance of lifelong learning, and of how mathematics plays a vital role in the future success of students. Principals provide support for the successful implementation of the mathematics curriculum by emphasizing the importance of mathematics, by promoting the idea that all students are capable of becoming confident mathematics learners, and by encouraging a positive and proactive attitude towards mathematics and student agency in mathematics.

The principal works in partnership with teachers and parents to ensure that all students have access to the best possible educational experience. To support student learning, principals monitor the implementation of the Ontario mathematics curriculum. Principals ensure that English language learners are being provided the accommodations and/or modifications they require for success in the mathematics program. Principals are also responsible for ensuring that every student who has an Individual Education Plan (IEP) is receiving the modifications and/or accommodations described in their plan – in other words, for ensuring that the IEP is properly developed, implemented, and monitored.

Ensuring that teachers have the agency, support, confidence, resources, and tools they need to deliver a high-quality program is essential. Principals collaborate with teachers and school and system leaders to develop professional learning opportunities that deepen teachers' knowledge of the curriculum, mathematical content, and pedagogy, and enhance their self-efficacy in teaching mathematics. Additional professional learning and support to increase teachers' knowledge, awareness, and comfort level in teaching mathematics may be provided by principals where necessary.

Community Partners

Community partners are an important resource for a school’s mathematics education program. Relationships with local businesses, volunteer groups, and community organizations, such as those for newcomer families, can provide opportunities for authentic perspectives and real-world application of mathematics. Nurturing partnerships with other schools can facilitate the sharing of resources, strategies, and facilities; the development of professional learning opportunities for staff; and the hosting of special events such as family math nights or a mathematics community walk.

Communities provide social contexts for learning. Students bring knowledge and experiences from their homes and communities that can be powerful assets in creating productive environments for learning. By involving others in the community, teachers and principals can position mathematics learning as collaborative and experiential. Membership in a community also helps students develop a sense of identity and belonging and build their identity as mathematics learners.

The Program in Mathematics

Curriculum Expectations

The Ontario Curriculum, Grades 1–8: Mathematics, 2020 identifies the expectations for each grade and describes the knowledge, concepts, and skills that students are expected to acquire, demonstrate, and apply in their class work and activities, on tests, in demonstrations, and in various other activities on which their achievement is assessed and evaluated.

Mandatory learning is described in the overall and specific expectations of the curriculum.

Two sets of expectations – overall expectations and specific expectations – are listed for each *strand*, or broad area of the curriculum, in mathematics for Grades 1 to 8. The strands include Strand A and five strands, lettered B, C, D, E, and F. *Taken together, the overall and specific expectations represent the mandated curriculum.*

The *overall expectations* describe in general terms the knowledge, concepts, and skills that students are expected to demonstrate by the end of each grade. The *specific expectations* describe the expected knowledge, concepts, and skills in greater detail. The specific expectations are grouped under numbered subheadings, each of which indicates the strand and the overall expectation to which the group of specific expectations corresponds (e.g., “B2” indicates that the group relates to overall expectation 2 in strand B). This organization is not meant to imply that the expectations in any one group are achieved independently of the

expectations in the other groups, nor is it intended to imply that learning the expectations happens in a linear, sequential way. The numbered headings are used merely as an organizational structure to help teachers focus on particular aspects of knowledge, concepts, and skills as they develop various lessons and learning activities for students. In the mathematics curriculum, strands B to F use additional subheadings within each group of expectations to identify the topics addressed in the strand.

In the mathematics curriculum, the overall expectations outline the fundamental knowledge, concepts, and skills that are required for engaging in appropriate mathematical situations in and out of the classroom at any grade or stage of development. For this reason, the overall expectations generally remain the same from Grades 1 to 8. The curriculum focuses on connecting, developing, reinforcing, and refining the knowledge, concepts, and skills that students acquire as they work towards meeting the overall expectations in the elementary school program. This approach reflects and accommodates the progressive nature of development of knowledge, concepts, and skills in mathematics learning.

The *specific expectations* reflect this progression in knowledge and skill development through changes in the wordings of the expectations and through the introduction of new expectations, where appropriate. The progression is captured by the increasing complexity of the pedagogical supports (see below) associated with most expectations and by the increasing specificity of mathematical relationships, the diversity of contexts in which the learning is applied, and the variety of opportunities presented for applying it. It should be noted that *all* the skills specified in the early grades continue to be developed and refined as students move through the grades, whether or not each of those skills continues to be explicitly required in an expectation.

There is an exception in [Strand C: Algebra](#), where the overall expectation on mathematical modelling has no accompanying specific expectations. This is because mathematical modelling is an integrated process that is applied in various contexts, allowing students to extend and apply what they have learned in other strands. Students' demonstration of the process of mathematical modelling, as they apply knowledge, concepts, and skills learned in other strands, is assessed and evaluated.

In addition to the expectations outlined within the other five strands, [Strand A](#) focuses on the development and application of social-emotional learning (SEL) skills while using mathematical processes. These skills support students' understanding of mathematical knowledge, concepts, and skills and foster their overall well-being and ability to learn while helping them build resilience and thrive as mathematics learners. As they develop SEL skills, students demonstrate a greater ability to understand and apply the mathematical processes, which are critical to supporting learning in mathematics. In all grades of the mathematics program, the learning related to this strand takes place in the context of learning related to the other five strands and is assessed and evaluated within these contexts.

Examples, Key Concepts, and Sample Tasks

Specific expectations are accompanied by examples, key concepts, and/or sample tasks. These elements or “pedagogical supports” are intended to promote understanding of the intent of the specific expectations, and are offered as illustrations for teachers. *The pedagogical supports do not set out requirements for student learning; they are optional, not mandatory.*

The examples are meant to illustrate the intent of the expectation, illustrating the kind of knowledge or skill, the specific area of learning, the depth of learning, and/or the level of complexity that the expectation entails. The key concepts identify the central principles and mathematical ideas that underpin the learning in that specific expectation. The sample tasks have been developed to model appropriate practice for the grade. They provide possible learning activities for teachers to use with students and illustrate connections between the mathematical knowledge, concepts, and skills. Teachers can choose to draw on the sample tasks that are appropriate for their classrooms, or they may develop their own approaches that reflect a similar level of complexity. Whatever the specific ways in which the requirements outlined in the expectations are implemented in the classroom, they must, wherever possible, be inclusive and reflect the diversity of the student population and the population of the province. Teachers will notice that some of the sample tasks not only address the requirements of the expectation they are associated with but also incorporate mathematical concepts or skills described in expectations in other strands in the same grade.

The Mathematical Processes

Students learn and apply the mathematical processes as they work to achieve the expectations outlined in the curriculum. All students are actively engaged in applying these processes throughout the program. They apply these processes, together with social-emotional learning (SEL) skills, across the curriculum to support learning in mathematics. See the section [“Strand A: Social-Emotional Learning \(SEL\) Skills in Mathematics and the Mathematical Processes”](#) for more information.

The mathematical processes that support effective learning in mathematics are as follows:

- problem solving
- reasoning and proving
- reflecting
- connecting
- communicating
- representing
- selecting tools and strategies

The mathematical processes can be seen as the processes through which all students acquire and apply mathematical knowledge, concepts, and skills. These processes are interconnected. Problem solving and communicating have strong links to all the other processes. A problem-solving approach encourages students to reason their way to a solution or a new understanding. As students engage in reasoning, teachers further encourage them to pose questions, make conjectures, and justify solutions, orally and in writing. The communication and reflection that occur before, during, and after the process of problem solving help students not only to articulate and refine their thinking but also to see the problem they are solving from different perspectives. This opens the door to recognizing the range of strategies that can be used to arrive at a solution. By seeing how others solve a problem, students can begin to reflect on their own thinking (a process known as “metacognition”) and the thinking of others, as well as their own language use (a process known as “metalinguistic awareness”), and to consciously adjust their own strategies in order to make their solutions as efficient and accurate as possible.

The mathematical processes cannot be separated from the knowledge, concepts, and skills that students acquire throughout the year. All students problem solve, communicate, reason, reflect, and so on, as they develop the knowledge, the understanding of mathematical concepts, and the skills required in all the strands in every grade.

Problem Solving

Problem solving is central to doing mathematics. By learning to solve problems and by learning *through* problem solving, students are given, and create, numerous opportunities to connect mathematical ideas and to develop conceptual understanding. Problem solving forms the basis of effective mathematics programs that place all students’ experiences and queries at the centre. Thus, problem solving should be the mainstay of mathematical instruction. It is considered an essential process through which all students are able to achieve the expectations in mathematics and is an integral part of the Ontario mathematics curriculum.

Problem solving:

- increases opportunities for the use of critical thinking skills (e.g., selecting appropriate tools and strategies, estimating, evaluating, classifying, assuming, recognizing relationships, conjecturing, posing questions, offering opinions with reasons, making judgements) to develop mathematical reasoning;
- helps all students develop a positive math identity;
- allows all students to use the rich prior mathematical knowledge they bring to school;
- helps all students make connections among mathematical knowledge, concepts, and skills, and between the classroom and situations outside the classroom;
- promotes the collaborative sharing of ideas and strategies and promotes talking about mathematics;

- facilitates the use of creative-thinking skills when developing solutions and approaches;
- helps students find enjoyment in mathematics and become more confident in their ability to do mathematics.

Most importantly, when problem solving is in a mathematical context relevant to students' experiences and derived from their own problem posing, it furthers their understanding of mathematics and develops their math agency.

Problem-Solving Strategies. Problem-solving strategies are methods that can be used to solve problems of various types. Common problem-solving strategies include the following: simulating; making a model, picture, or diagram; looking for a pattern; guessing and checking; making an organized list; making a table or chart; solving a simpler version of the problem (e.g., with smaller numbers); working backwards; and using logical reasoning. Teachers can support all students as they develop their use of these strategies by engaging with solving various kinds of problems – instructional problems, routine problems, and non-routine problems. As students develop this repertoire over time, they become more confident in posing their own questions, more mature in their problem-solving skills, and more flexible in using appropriate strategies when faced with new problem-solving situations.

Reasoning and Proving

Reasoning and proving are a mainstay of mathematics and involves students using their understanding of mathematical knowledge, concepts, and skills to justify their thinking. Proportional reasoning, algebraic reasoning, spatial reasoning, statistical reasoning, and probabilistic reasoning are all forms of mathematical reasoning. Students also use their understanding of numbers and operations, geometric properties, and measurement relationships to reason through solutions to problems. Teachers can provide all students with learning opportunities where they must form mathematical conjectures and then test or prove them to see if they hold true. Initially, students may rely on the viewpoints of others to justify a choice or an approach to a solution. As they develop their own reasoning skills, they will begin to justify or prove their solutions by providing evidence.

Reflecting

Students reflect when they are working through a problem to monitor their thought process, to identify what is working and what is not working, and to consider whether their approach is appropriate or whether there may be a better approach. Students also reflect after they have solved a problem by considering the reasonableness of their answer and whether adjustments need to be made. Teachers can support all students as they develop their reflecting and metacognitive skills by asking questions that have them examine their thought processes, as well as questions that have them think about other students' thought processes. Students can

also reflect on how their new knowledge can be applied to past and future problems in mathematics.

Connecting

Experiences that allow all students to make connections – to see, for example, how knowledge, concepts, and skills from one strand of mathematics are related to those from another – will help them to grasp general mathematical principles. Through making connections, students learn that mathematics is more than a series of isolated skills and concepts and that they can use their learning in one area of mathematics to understand another. Seeing the relationships among procedures and concepts also helps develop mathematical understanding. The more connections students make, the deeper their understanding, and understanding, in turn, helps them to develop their sense of identity. In addition, making connections between the mathematics they learn at school and its applications in their everyday lives not only helps students understand mathematics but also allows them to understand how useful and relevant it is in the world beyond the classroom. These kinds of connections will also contribute to building students' mathematical identities.

Communicating

Communication is an essential process in learning mathematics. Students communicate for various purposes and for different audiences, such as the teacher, a peer, a group of students, the whole class, a community member, or their family. They may use oral, visual, written, or gestural communication. Communication also involves active and respectful listening. Teachers provide differentiated opportunities for all students to acquire the language of mathematics, developing their communication skills, which include expressing, understanding, and using appropriate mathematical terminology, symbols, conventions, and models.

For example, teachers can ask students to:

- share and clarify their ideas, understandings, and solutions;
- create and defend mathematical arguments;
- provide meaningful descriptive feedback to peers; and
- pose and ask relevant questions.

Effective classroom communication requires a supportive, safe, and respectful environment in which all members of the class feel comfortable and valued when they speak and when they question, react to, and elaborate on the statements of their peers and the teacher.

Representing

Students represent mathematical ideas and relationships and model situations using tools, pictures, diagrams, graphs, tables, numbers, words, and symbols. Teachers recognize and value the varied representations students begin learning with, as each student may have different prior access to and experiences with mathematics. While encouraging student engagement and affirming the validity of their representations, teachers help students reflect on the appropriateness of their representations and refine them. Teachers support students as they make connections among various representations that are relevant to both the student and the audience they are communicating with, so that all students can develop a deeper understanding of mathematical concepts and relationships. All students are supported as they use the different representations appropriately and as needed to model situations, solve problems, and communicate their thinking.

Selecting Tools and Strategies

Students develop the ability to select appropriate technologies, tools, and strategies to perform particular mathematical tasks, to investigate mathematical ideas, and to solve problems.

Technology. A wide range of technological and digital tools can be used in many contexts for students to interact with, learn, and do mathematics.

Students can use:

- calculators and computers to perform complex operations; create graphs; and collect, organize, and display data;
- digital tools, apps, and social media to investigate mathematical concepts and develop an understanding of mathematical relationships;
- statistical software to manipulate, analyse, represent, sort, and communicate data;
- software to code;
- dynamic geometry software and online geometry tools to develop spatial sense;
- computer programs to represent and simulate mathematical situations (i.e., mathematical modelling);
- communications technologies to support and communicate their thinking and learning;
- computers, tablets, and mobile devices to access mathematical information available on the websites of organizations around the world and to develop information literacy.

Developing the ability to perform mental computations is an important aspect of student learning in mathematics. Students must, therefore, use technology with discretion, and only when it makes sense to do so. When students use technology in their mathematics learning,

they should apply mental computation, reasoning, and estimation skills to predict and check answers.

Tools. All students should be encouraged to select and use tools to illustrate mathematical ideas. Students come to understand that making their own representations is a powerful means of building understanding and of explaining their thinking to others. Using tools helps students:

- see patterns and relationships;
- make connections between mathematical concepts and between concrete and abstract representations;
- test, revise, and confirm their reasoning;
- remember how they solved a problem;
- communicate their reasoning to others, including by gesturing.

Strategies. Problem solving often requires students to select an appropriate strategy. Students learn to judge when an exact answer is needed and when an estimate is all that is required, and they use this knowledge to guide their selection. For example, computational strategies include mental computation and estimation to develop a sense of the numbers and operations involved. The selection of a computational strategy is based on the flexibility students have with applying operations to the numbers they are working with. Sometimes, their strategy may involve the use of algorithms or the composition and decomposition of numbers using known facts. Students can also create computational representations of mathematical situations using code.

The Strands in the Mathematics Curriculum

The expectations in the mathematics curriculum are organized into six distinct but related strands: A. Social-Emotional Learning (SEL) Skills in Mathematics and the Mathematical Processes; B. Number; C. Algebra; D. Data; E. Spatial Sense; and F. Financial Literacy.

The program in all grades is designed to ensure that students build a solid foundation in mathematics and develop a positive mathematical identity by connecting and applying mathematical concepts in a variety of ways. To support this process, teachers capitalize on students' prior knowledge, skills, and experiences; integrate concepts from across the strands; and often apply the mathematics that students are learning to types of situations that might occur outside the classroom.

The following chart shows the flow of the learning through the curriculum and the interrelationships among its various components.

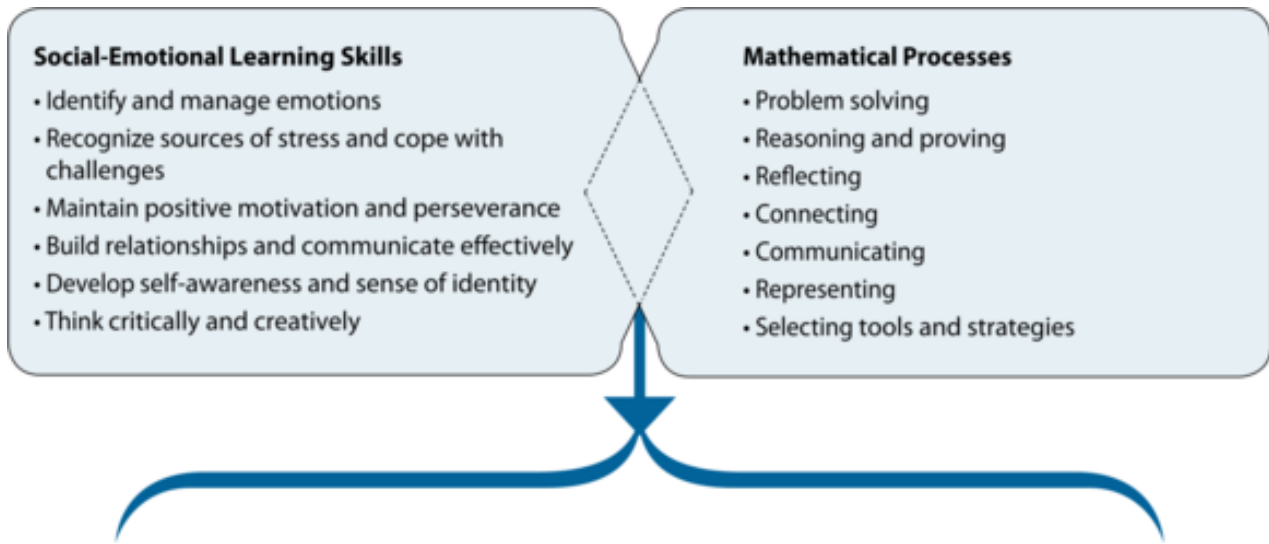

Strand B. Number	Strand C. Algebra	Strand D. Data	Strand E. Spatial Sense	Strand F. Financial Literacy
<p>B1. Number Sense</p> <ul style="list-style-type: none"> • whole numbers • rational and irrational numbers • fractions, decimals, and percents <p>B2. Operations</p> <ul style="list-style-type: none"> • properties and relationships • math facts • mental math • addition and subtraction • multiplication and division 	<p>C1. Patterns and Relations</p> <ul style="list-style-type: none"> • patterns <p>C2. Equations and Inequalities</p> <ul style="list-style-type: none"> • variables and expressions • equalities and inequalities <p>C3. Coding</p> <ul style="list-style-type: none"> • coding skills <p>C4. Mathematical Modelling</p>	<p>D1. Data Literacy</p> <ul style="list-style-type: none"> • data collection and organization • data visualization • data analysis <p>D2. Probability</p>	<p>E1. Geometric and Spatial Reasoning</p> <ul style="list-style-type: none"> • geometric reasoning • location and movement <p>E2. Measurement</p> <ul style="list-style-type: none"> • attributes • length • mass, capacity and volume • area and surface area • angles • time • the metric system 	<p>Grades 1 to 8:</p> <p>F1. Money</p> <ul style="list-style-type: none"> • money concepts <p>Grades 4 to 8:</p> <p>F1. Finances</p> <ul style="list-style-type: none"> • financial management • consumer and civic awareness

Strand A – Social-Emotional Learning and Mathematical Processes

There is strong evidence that developing social-emotional learning skills at school contributes to all students' overall health and well-being and to successful academic performance. It also supports positive mental health, as well as students' ability to learn, build resilience, and thrive. The development of social-emotional learning skills throughout their school years will support all students in becoming healthier and more successful in their daily lives and as contributing members of society. In all grades, learning related to the expectations in this strand occurs in the context of learning related to the other five strands and is assessed and evaluated within these contexts.

Social-emotional learning skills can be developed across all subjects of the curriculum – including mathematics – as well as during various school activities, at home, and in the community. These skills support students in understanding mathematical concepts and in applying the [mathematical processes](#) that are key to learning and doing mathematics. They help all students – and indeed all learners, including educators and parents – develop confidence, cope with challenges, and think critically. This in turn enables them to improve and demonstrate mathematics knowledge, concepts, and skills in a variety of situations. Social-emotional learning skills help every student develop a positive identity as a capable “math learner”.

In all grades, Strand A comprises a single overall expectation and a chart listing the social-emotional learning skills, the mathematical processes, and the expected outcomes when students use these skills and processes to show their understanding and application of the mathematical content. The progression of learning from grade to grade is indicated in the examples, which are linked to each social-emotional learning skill in each grade and which highlight how the skills can be integrated with learning across the other five strands. The content and application of the learning changes as students develop and mature. *Students' application of the social-emotional learning skills and mathematical processes must be assessed and evaluated as a part of their achievement of the overall expectations in each of the strands for every grade.*

The chart in [Strand A](#) outlines the social-emotional learning skills, the mathematical processes, and the expected outcomes when students apply both as they learn and do mathematics. The interaction of skills and processes is variable: Different social-emotional learning skills may be applied at different times in connection with different mathematical processes to achieve the outcomes.

Social-Emotional Learning Skills: Key Components and Sample Strategies

The following chart provides detailed information about each of the skills, including key ideas and sample strategies.

<p style="text-align: center;">Skills</p> <p><i>What are the skills? How do they help? What do they look like in mathematics?</i></p>	<p style="text-align: center;">Key Components and Sample Strategies</p>
<p>Identification and Management of Emotions</p> <p>Students often experience a range of emotions over the course of their day at school. They may feel happy, sad, angry, frustrated, or excited, or any number of emotions in combination. Students, and especially younger children, may struggle to identify and appropriately express their feelings. Learning to recognize different emotions, and to manage them effectively, can help students function and interact more successfully. When students understand the influence of thoughts and emotions on behaviour, they can improve the quality of their interactions. In mathematics, as they learn new mathematics concepts and interact with others while problem solving, students have many opportunities to develop awareness of their emotions and to use communication skills to express their feelings and to respond constructively when they recognize emotions in others.</p>	<ul style="list-style-type: none"> ● Recognizing a range of emotions in self and others ● Gauging the intensity and/or the level of emotion ● Understanding connections between thoughts, feelings, and actions ● Recognizing that new or challenging learning may involve a sense of excitement or an initial sense of discomfort ● Managing strong emotions and using strategies to self-regulate ● Applying strategies such as: <ul style="list-style-type: none"> ○ using a “feelings chart” to learn words to express feelings ○ using a “feelings thermometer” or pictures to gauge intensity of emotion
<p>Stress Management and Coping</p> <p>Every day, students are exposed to a range of challenges that can contribute to feelings of stress. As they learn stress management and coping skills, they come to recognize that stress is a part of life and that it can be managed. We can learn ways to respond to challenges that enable us to “bounce back” and, in this way, build resilience in the face of life’s obstacles. Over time, with support, practice, feedback, reflection, and experience, students begin to build a set of personal coping strategies that they can carry with them through life. In mathematics, students work through challenging problems,</p>	<ul style="list-style-type: none"> ● Problem solving ● Seeking support from peers, teachers, family, or their extended community ● Managing stress through physical activity ● Applying strategies such as: <ul style="list-style-type: none"> ○ breaking a task or problem down into pieces and tackling one piece at a time ○ thinking of a similar problem ○ deep breathing ○ guided imagery ○ stretching ○ pausing and reflecting

<p>understanding that their resourcefulness in using coping strategies is helping them build personal resilience.</p>	
<p>Positive Motivation and Perseverance Positive motivation and perseverance skills help students to “take a long view” and remain hopeful even when their personal and/or immediate circumstances are difficult. With regular use, practices and habits of mind that promote positive motivation help students approach challenges in life with an optimistic and positive mindset and an understanding that there is struggle in most successes and that repeated effort can lead to success. These practices include noticing strengths and positive aspects of experiences, reframing negative thoughts, expressing gratitude, practising optimism, and practising perseverance – appreciating the value of practice, of making mistakes, and of the learning process. In mathematics students have regular opportunities to apply these practices as they solve problems and develop an appreciation for learning from mistakes as a part of the learning process.</p>	<ul style="list-style-type: none"> ● Reframing negative thoughts and experiences ● Practising perseverance ● Embracing mistakes as a necessary and helpful part of learning ● Reflecting on things to be grateful for and expressing gratitude ● Practising optimism ● Applying strategies such as: <ul style="list-style-type: none"> ○ using an iterative approach by trying out different methods, including estimating and guessing and checking, to support problem solving ○ supporting peers by encouraging them to keep trying if they make a mistake ○ using personal affirmations like “I can do this.”
<p>Healthy Relationship Skills When students interact in positive and meaningful ways with others, mutually respecting diversity of thought and expression, their sense of belonging within the school and community is enhanced. Learning healthy relationship skills helps students establish positive patterns of communication and inspires healthy, cooperative relationships. These skills include the ability to understand and appreciate another person’s perspective, to empathize with others, to listen attentively, to be assertive, and to apply conflict-resolution skills. In mathematics, students have opportunities to develop and practise skills that support positive interaction with others as they work together in small groups or in pairs to solve math problems and confront challenges. Developing these skills helps students to communicate with teachers, peers, and family</p>	<ul style="list-style-type: none"> ● Being cooperative and collaborative ● Using conflict-resolution skills ● Listening attentively ● Being respectful ● Considering other ideas and perspectives ● Practising kindness and empathy ● Applying strategies such as: <ul style="list-style-type: none"> ○ seeking opportunities to help others ○ taking turns playing different roles (e.g., leader, scribe or illustrator, data collector, observer) when working in groups

<p>about mathematics with an appreciation of the beauty and wonder of mathematics.</p>	
<p>Self-Awareness and Sense of Identity Knowing who we are and having a sense of purpose and meaning in our lives enables us to function in the world as self-aware individuals. Our sense of identity enables us to make choices that support our well-being and allows us to connect with and have a sense of belonging in various cultural and social communities. Educators should note that for First Nations, Métis, and Inuit students, the term “sense of identity and belonging” may also mean belonging to and identifying with a particular community and/or nation. Self-awareness and identity skills help students explore who they are – their strengths, difficulties, preferences, interests, values, and ambitions – and how their social and cultural contexts have influenced them. In mathematics, as they learn new skills, students use self-awareness skills to monitor their progress and identify their strengths; in the process, they build their identity as capable math learners. Educators play a key role in reinforcing that everyone – students, educators, and parents – is a math learner and in sharing an appreciation of the beauty and wonder of mathematics.</p>	<ul style="list-style-type: none"> ● Knowing oneself ● Caring for oneself ● Having a sense of mattering and of purpose ● Identifying personal strengths ● Having a sense of belonging and community ● Communicating their thinking, positive emotions, and excitement about mathematics ● Applying strategies such as: <ul style="list-style-type: none"> ○ building their identity as a math learner as they learn independently as a result of their efforts and challenges ○ monitoring progress in skill development ○ reflecting on strengths and accomplishments and sharing these with peers or caring adults
<p>Critical and Creative Thinking Critical and creative thinking skills enable us to make informed judgements and decisions on the basis of a clear and full understanding of ideas and situations, and their implications, in a variety of settings and contexts. Students learn to question, interpret, predict, analyse, synthesize, detect bias, and distinguish between alternatives. They practise making connections, setting goals, creating plans, making and evaluating decisions, and analysing and solving problems for which there may be no clearly defined answers. Executive functioning skills – the skills and processes that allow us to take initiative, focus, plan, retain and transfer learning, and determine priorities – also support critical and creative</p>	<ul style="list-style-type: none"> ● Making connections ● Making decisions ● Evaluating choices, reflecting on and assessing strategies ● Communicating effectively ● Managing time ● Setting goals ● Applying organizational skills ● Applying strategies such as: <ul style="list-style-type: none"> ○ determining what is known and what needs to be found ○ using various webs, charts, diagrams, and representations to help identify connections and interrelationships

thinking. In all aspects of the mathematics curriculum, students have opportunities to develop critical and creative thinking skills. Students have opportunities to build on prior learning, go deeper, and make personal connections through real-life applications.

- using organizational strategies and tools, such as planners, trackers, and goal-setting frameworks

Strand B – Number

Understanding how numbers work is foundational to many aspects of mathematics. Recognizing and understanding number properties is foundational to developing an understanding of branches of mathematics such as arithmetic and algebra. In the Number strand, as students progress through Grades 1 to 8, they learn about different types of numbers and how those numbers behave when various operations are applied to them.

A vital aspect of number work in elementary grades is to build what is often called number sense, where students develop the ability to flexibly relate numbers and relate computations. Students who have developed number sense regularly use number relationships to make sense of calculations and to assess the reasonableness of numbers used to describe situations, for example, in the media.

Students learn to count effectively and then become fluent with math facts in order to perform calculations efficiently and accurately, whether mentally or by using algorithms on paper. This strand is built on the belief that it is important to develop automaticity, which is the ability to use mathematical skills or perform mathematical procedures with little or no mental effort. Automaticity with math facts enables students to engage in critical thinking and problem solving.

Most students learn math facts gradually over a number of years, connecting to prior knowledge, using tools and calculators. Mastery comes with practice, and practice helps to build fluency and depth. Students draw on their ability to apply math facts as they manipulate algebraic expressions, equations, and inequalities. Mental math skills involve the ability to perform mathematical calculations without relying on pencil and paper. They enable students to estimate answers to calculations, and so to work accurately and efficiently on everyday problems and judge the reasonableness of answers that they have arrived at through calculation. In order to develop effective mental math strategies, all students need to have strong skills in number sense and a solid conceptual understanding of the operations.

Though individual students may progress at different rates, generally speaking, addition/subtraction facts should be mastered by the end of Grade 3, and

multiplication/division facts should be mastered by the end of Grade 5.¹³ However, all students should continue to learn about effective strategies and to practice and extend their proficiency in the operations throughout the grades and in the context of learning in all the strands of the mathematics curriculum.

Strand C – Algebra

In this strand, students develop algebraic reasoning through working with patterns, variables, expressions, equations, inequalities, coding, and the process of mathematical modelling.

As students progress through the grades, they study a variety of patterns, including those found in real life. Students learn to identify regularities in numeric and non-numeric patterns and classify them based on the characteristics of those regularities. They create and translate patterns using various representations. Students determine pattern rules for various patterns in order to extend them, make near and far predictions, and determine their missing elements. They develop recursive and functional thinking as well as additive and multiplicative thinking as they work with linear patterns, and use this thinking to develop the general terms of the patterns to solve for unknown values. Understanding patterns and determining the relationship between two variables has many connections to science and is foundational to further mathematics. In the primary grades, students focus on understanding which quantities remain the same and which can change in everyday contexts, and on how to establish equality between numerical expressions. In the junior and intermediate grades, students work with variables in algebraic expressions, equations, and inequalities in various contexts.

As students progress through the grades, their coding experiences also progress, from representing movements on a grid, to solving problems involving optimization, to manipulating models to find which one best fits the data they are working with in order to make predictions. Coding can be incorporated across all strands and provides students with opportunities to apply and extend their math thinking, reasoning, and communicating.

Students in all grades also engage in the process of mathematical modelling.

The Mathematical Modelling Process

Mathematical modelling provides authentic connections to real-life situations. The process starts with ill-defined, often messy real-life problems that may have several different solutions that are all correct. Mathematical modelling requires the modeller to be critical and creative

¹³ Chapin, S. H., & Johnson, A. (2006). *Math matters: Understanding the math you teach, Grades K–8* (2nd ed.). Sausalito, CA: Math Solutions Publications.

and make choices, assumptions, and decisions. Through this process, they create a mathematical model that describes a situation using mathematical concepts and language, and that can be used to solve a problem or make decisions and can be used to deepen understanding of mathematical concepts.

The process of mathematical modelling¹⁴ has four key components that are interconnected and applied in an iterative way, where students may move between and across, as well as return to, each of the four components as they change conditions to observe new outcomes until the model is ready to be shared and acted upon. While moving through these steps, social-emotional learning skills and mathematical processes are applied as needed.

1. Understand the problem

- What questions need answering?
- What information is needed?

2. Analyse the situation

- What assumptions do I make about the situation?
- What changes, what remains the same?

3. Create a mathematical model

- What representations, tools, technologies, and strategies will help build the model?
- What mathematical knowledge, concepts, and skills might be involved?

4. Analyse and assess the model

- Can this model provide a solution?
- What are alternative models?

¹⁴ Hirsch, C. R., & McDuffie, A. R. (Eds.). (2016). *Annual perspectives in mathematics education 2016: Mathematical modeling and modeling mathematics*. Reston, VA: National Council of Teachers of Mathematics.

The Process of Mathematical Modelling

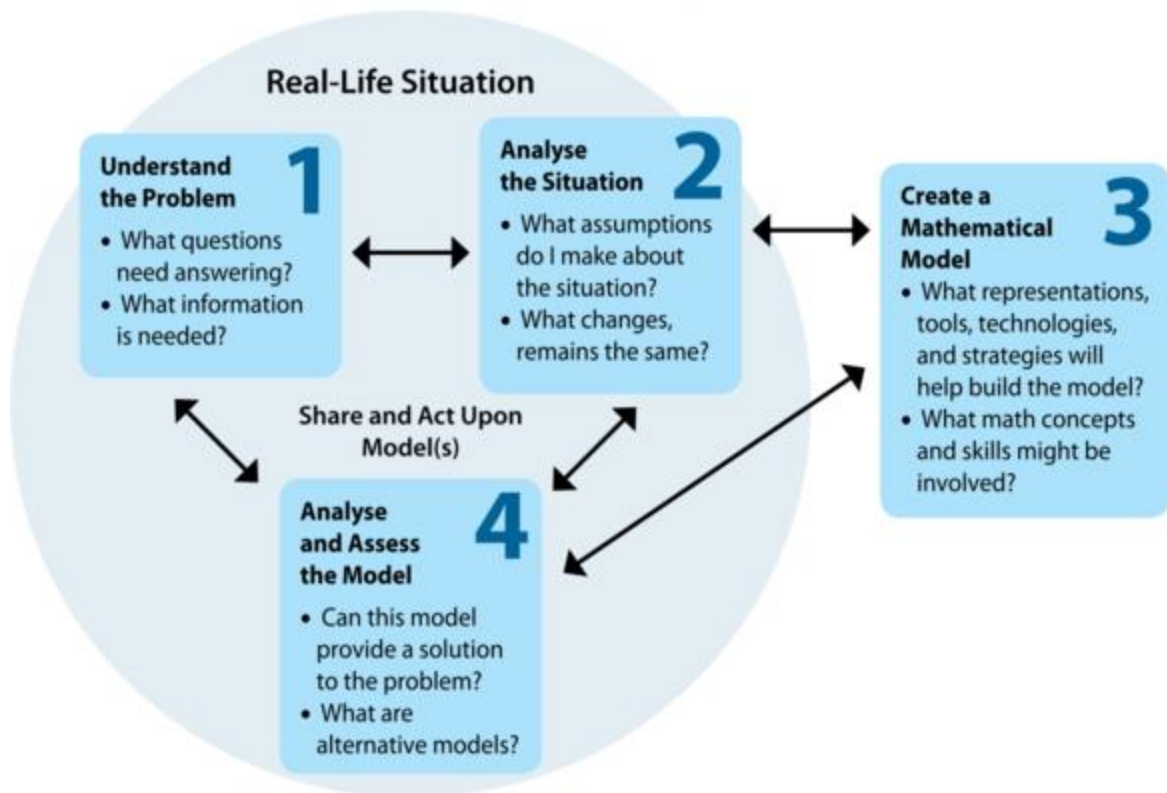

Strand D – Data

The related topics of statistics and probability, which are addressed in this strand, are highly relevant to real life. The public is bombarded with data through advertising, opinion polls, politics, population trends, and scientific discoveries, to name just a few. Thus, one of the key focuses in this strand is to support students in developing **critical thinking skills** throughout their development of data literacy, so that they can analyse, synthesize, understand, generate, and use data, both as consumers and producers.

The main purpose for collecting and organizing data is to gather information in order to answer questions. When questions stimulate students' curiosity, they become engaged in collecting, organizing, and interpreting the data that provide answers to their questions. Relevant questions often arise from class discussions; classroom events, issues, and thematic activities; and topics in various subject areas. When students collect and organize data, they have an opportunity to learn more about themselves, their environment, issues in their school or community, and so on. Learning activities should help students understand the processes that are involved in formulating questions, seeking relevant information, and organizing that information in meaningful ways. Involving students in collecting and organizing data allows them to participate in the decision making that is required at different steps of the process.

As students progress through the grades, they develop an understanding of qualitative data and both discrete and continuous quantitative data, and use that understanding to select appropriate ways to organize and display data. Students learn the fundamentals of statistics and develop the skills to visualize and critically analyse data, including identifying any possible biases within the data. Starting in the junior grades, students make intentional choices in creating infographics in order to represent key information about a set of data for a particular audience and to engage in the critical interpretation of data. In addition, students learn how to use data to make compelling arguments about questions of interest.

The learning in this strand also supports students in developing probabilistic reasoning. As students progress through the grades, they begin to understand the relationship between probability and data, and how data is used to make predictions about populations. Students' intuitive understanding of probability is nurtured in the early grades to help them make connections to their prior experience with probability in everyday life, beginning with simply understanding that some events are likely to happen while others are not likely. Eventually, students begin to understand and represent these probabilities as fractions, decimals and percents. From Grades 5 to 8, students compare experimental probabilities involving independent and dependent events with their theoretical probabilities, and use these measures to make predictions about events.

Strand E – Spatial Sense

This strand combines the areas of geometry and measurement in order to emphasize the relationship between the two areas and to highlight the role of spatial reasoning in underpinning the development of both. Study in this strand provides students with the language and tools to analyse, compare, describe, and navigate the world around them. It is a gateway to professions in other STEM (science, technology, engineering, and mathematics) disciplines, and builds foundational skills needed for construction, architecture, engineering, research, and design.

In this strand, students analyse the properties of shapes – the elements that define a shape and make it unique – and use these properties to define, compare, and construct shapes and objects, as well as to explore relationships among properties. Students begin with an intuition about their surroundings and the objects in them, and learn to visualize objects from different perspectives. Over time, students develop an increasingly sophisticated understanding of size, shape, location, movement, and change, in both two and three dimensions. They understand and choose appropriate units to estimate, measure, and compare attributes, and they use appropriate tools to make measurements. They apply their understanding of the relationships between shapes and measurement to develop formulas to calculate length, area, volume, and more.

Strand F – Financial Literacy

All Ontario students need the skills and knowledge to take responsibility for managing their personal financial well-being with confidence, competence, a critical and compassionate awareness of the world around them.

Financial Literacy is a dedicated strand throughout the elementary math curriculum. Financial literacy is more than just knowing about money and financial matters and having the skills to work with this knowledge. Students develop the confidence and capacity to successfully apply the necessary knowledge, concepts, and skills in a range of relevant real-life contexts and for a range of purposes. They also develop the ability to make informed decisions as consumers and citizens while taking into account the ethical, societal, environmental, and personal aspects of those decisions.

In Grades 1 to 3, students demonstrate an understanding of the value and use of money by recognizing Canadian coins and bills, representing various amounts, and calculating change in simple transactions. In Grades 4 to 8, students extend their learning to the knowledge, concepts, and skills required to make informed financial decisions relevant to their lived experiences and plan simple sample budgets. Students begin to develop consumer and civic awareness in the junior and intermediate grades. Making connections to what they are learning in the Media Literacy strand of the language curriculum as well as the social studies, history and geography curriculum, students become informed consumers and learn about the broader economic systems in their local communities, communities in other global contexts that their families are connected to, and beyond. Educators consider and respond to the range of equity issues related to the diverse circumstances and lived experiences of students and their families.

This strand connects with other mathematics strands in many ways, such as applying knowledge, concepts, and skills related to:

- numbers and operations to calculate change;
- percents to calculate sales tax and interest;
- mathematical modelling to understand real-life financial situations, including the financial applications of linear rates;
- unit rates to compare goods and services, and mental math to quickly determine those with the best value;
- social-emotional learning to become confident and critical consumers, and to persevere in managing financial well-being.

Some Considerations for Program Planning in Mathematics

Teachers consider many factors when planning a mathematics program that cultivates the best possible environment in which all students can maximize their mathematical learning. This section highlights the key strategies and approaches that teachers and school leaders should consider as they plan effective and inclusive mathematics programs. Additional information can be found in the [“Considerations for Program Planning”](#) section, which provides information applicable to all curricula.

Instructional Approaches in Mathematics

Instruction in mathematics should support all students in acquiring the knowledge, skills, and habits of mind they need in order to achieve the curriculum expectations and be able to enjoy and participate in mathematics learning for years to come.

Effective math instruction begins with knowing the identity and profile of the students, having high expectations for and of all students, and believing that all students can learn and do mathematics. It uses culturally relevant and responsive practices and differentiated learning experiences to meet individual students' learning strengths and needs. It focuses on the development of conceptual understanding and procedural fluency, skill development, communication, and problem-solving skills. It takes place in a safe, positive, and inclusive learning environment, where all students feel valued, empowered, engaged, and able to take risks and approach the learning of mathematics in a confident manner. Instruction that is student-centred and that builds on students' strengths is effective as it motivates and engages students meaningfully and instils positive habits of mind, such as curiosity and open-mindedness; a willingness to think, to question, to challenge and be challenged; and an awareness of the value of listening intently, reading thoughtfully, and communicating with clarity.

Learning should be relevant and inspired by the lived realities of all students and embedded in authentic, real-life contexts that allow students to develop the fundamental mathematical concepts and skills and to see the beauty and wide-ranging nature of mathematics. This approach enables students to use mathematical reasoning to see connections throughout their lives.

High-Impact Practices

Teachers understand the importance of knowing the identities and profiles of all students and of choosing the instructional approaches that will best support student learning. The approaches that teachers employ vary according to both the learning outcomes and the needs of the students, and teachers choose from and use a variety of accessible, equitable high-impact instructional practices.

The thoughtful use of these high-impact instructional practices – including knowing when to use them and how they might be combined to best support the achievement of specific math goals – is an essential component of effective math instruction. Researchers have found that the following practices consistently have a high impact on teaching and learning mathematics:¹⁵

- **Learning Goals, Success Criteria, and Descriptive Feedback.** Learning goals and success criteria outline the intention for the lesson and how this intention will be achieved to ensure teachers and students have a clear and common understanding of what is being learned and what success looks like. The use of descriptive feedback involves providing students with the precise information they need in order to reach the intended learning goal. Using this practice makes all other practices more effective.
- **Direct Instruction.** This is a concise, intentional form of instruction that begins with a clear learning goal. It is not a lecture or a show-and-tell. Instead, direct instruction is a carefully planned and focused approach that uses questioning, activities, or brief demonstrations to guide learning, check for understanding, and make concepts clear. Direct instruction prioritizes feedback and formative assessment throughout the learning process and concludes with a clear summary of the learning.
- **Problem-Solving Tasks and Experiences.** It is an effective practice to use a problem, carefully chosen by the teacher or students, to introduce, clarify, or apply a concept or skill. This practice provides opportunities for students to demonstrate their agency by representing, connecting, and justifying their thinking. Students communicate and reason with one another and generate ideas that the teacher connects in order to highlight important concepts, refine existing understanding, eliminate unfruitful strategies, and advance learning.
- **Teaching about Problem Solving.** Teaching students about the process of problem solving makes explicit the critical thinking that problem solving requires. It involves teaching students to identify what is known and unknown and to draw on similarities between various types of problems. Teaching about problem solving involves using representations to model the problem-solving situation. This practice reinforces that

¹⁵ Hattie, J., Fisher, D., Frey, N., Gojak, L. M., Moore, S. D., & Mellman, W. (2017). *Visible learning for mathematics: What works best to optimize student learning, Grades K–12*. Thousand Oaks, CA: Corwin Mathematics.

problem solving requires perseverance and an awareness that mistakes can ultimately lead to growth in learning.

- **Tools and Representations.** The use of a variety of appropriate tools and representations supports a conceptual understanding of mathematics at all grade levels. Carefully chosen and used effectively, representations and tools such as manipulatives make math concepts accessible to a wide range of learners. At the same time, student interactions with representations and tools also give teachers insight into students' thinking and learning.
- **Math Conversations.** Effective math conversations provide multiple opportunities for all students to engage in meaningful math talk by listening to and responding to the ideas of others. These conversations involve reasoning, proving, building on the thinking of others, defending and justifying their own thinking, and adjusting their perspectives as they build their mathematical understanding, confidence, and identity.
- **Small-Group Instruction.** A powerful strategy for moving student learning forward, small-group instruction involves targeted and timely mathematics instruction that meets the learning needs of specific students at appropriate times. By working with small and flexible groups, whether they are homogenous or heterogenous, the teachers can personalize learning in order to prevent gaps from developing, close gaps that already exist, or extend thinking. Small-group instruction also provides opportunities for teachers to learn more about student identities, experiences, and communities, which the teachers can use as a basis for their mathematics instruction.
- **Deliberate Practice.** Practice is best when it is purposeful and spaced over time. It must always follow understanding. This ensures that there is continual, consistent, and relevant feedback, so students know that they are practising correctly. Practice is an essential part of an effective mathematics program.
- **Flexible Groupings.** The intentional combination of large-group, small-group, partnered, and independent working arrangements, in response to student and class learning needs, can foster a rich mathematical learning environment. Creating flexible groupings in a mathematics class enables students to work independently of the teacher but with the support of their peers, and it strengthens [collaboration](#) and [communication](#) skills. Regardless of the size of the group, it is of utmost importance that individual students are accountable for and have ownership of their learning.

While a lesson may prominently feature one of these high-impact practices, other practices will inevitably also be involved. The practices are rarely used in isolation, nor is there any single “best” instructional practice. Teachers choose the right practice, for the right time, in order to create an optimal learning experience for all students. They use their knowledge of the students, a deep understanding of the curriculum and of the mathematics that underpins the expectations, and a variety of assessment strategies to determine which high-impact instructional practice, or combination of practices, best supports the students. These decisions

are made continually throughout a lesson. The appropriate use of high-impact practices plays an important role in supporting student learning.

The Role of Information and Communication Technology in Mathematics

The mathematics curriculum was developed with the understanding that the strategic use of technology is part of a balanced mathematics program. Technology can extend and enrich teachers' instructional strategies to support all students' learning in mathematics. Technology, when used in a thoughtful manner, can support and foster the development of mathematical reasoning, problem solving, and communication.

When using technology to support the teaching and learning of mathematics, teachers consider the issues of student safety, privacy, ethical responsibility, equity and inclusion, and well-being.

The strategic use of technology to support the achievement of the curriculum expectations requires a strong understanding of:

- the mathematical concepts being addressed;
- high-impact teaching practices that can be used as appropriate to achieve the learning goals;
- the capacity of the chosen technology to augment the learning, and how to use this technology.

Technology can be used specifically to support the “doing” of mathematics (e.g., digital tools, computation devices, calculators, data-collection programs) or to facilitate access to information and allow better communication and collaboration (e.g., collaborative documents and web-based content that enable students to connect with experts and other students, near or far). Technology can support English language learners in accessing mathematics terminology and ways of solving problems in their first language. Assistive technologies are critical in enabling some students with special education needs to have equitable access to the curriculum and in supporting their learning, and must be provided in accordance with students' Individual Education Plan (IEP), as required.

Teachers understand the importance of technology and how it can be leveraged to support learning and to ensure that the mathematics curriculum expectations can be met by all students. Additional information can be found in the [“The Role of Information and Communications Technology”](#) subsection of [“Considerations for Program Planning”](#).

Planning Mathematics Programs for Students with Special Education Needs

Classroom teachers are the key educators of students with special education needs. They have a responsibility to support all students in their learning, and they work collaboratively with special education teachers, where appropriate, to achieve this goal. Classroom teachers commit to assisting every student to prepare for living with the highest degree of independence possible. More information on planning for and assessing students with special education needs can be found in the [“Planning for Students with Special Education Needs” subsection of “Considerations for Program Planning”](#).

Principles for Supporting Students with Special Education Needs

The following principles¹⁶ guide teachers in effectively planning and teaching mathematics programs to students with special education needs, and also benefit all students:

- The teacher plays a critical role in student success in mathematics.
- It is important for teachers to develop an understanding of the general principles of how students learn mathematics.
- The learning expectations outline developmentally appropriate key concepts and skills of mathematics across all of the strands that are interconnected and foundational.
- There is an important connection between procedural knowledge and conceptual understanding of mathematics.
- The use of concrete representations and tools is fundamental to learning mathematics in all grades and provides a way of representing both concepts and student understanding.
- The teaching and learning process involves ongoing assessment. Students with special education needs should be provided with various opportunities to demonstrate their learning and thinking in multiple ways.

An effective mathematics learning environment and program that addresses the mathematical learning needs of students with special education needs is purposefully planned with the principles of Universal Design for Learning in mind and integrates the following elements:

- knowing the student’s strengths, interests, motivations, and needs in mathematics learning in order to differentiate learning and make accommodations and modifications as outlined in the student’s Individual Education Plan;

¹⁶ Adapted from Ontario. Ministry of Education. (2005) *Education for All: The Report of the Expert Panel on Literacy and Numeracy Instruction for Students with Special Education Needs, Kindergarten to Grade 6*. Toronto: Author.

- building the student’s confidence and a positive identity as a mathematics learner;
- valuing the student’s prior knowledge and connecting what the student knows with what the student needs to learn;
- focusing on the connections between broad concepts in mathematics;
- connecting mathematics with familiar, relevant, everyday situations and providing rich and meaningful learning contexts;
- fostering a positive attitude towards mathematics and an appreciation of mathematics through multimodal means, including through the use of assistive technology and the performance of authentic tasks;
- implementing research-informed instructional approaches (e.g., Concrete – Semi-Concrete – Representational – Abstract) when introducing new concepts to promote conceptual understanding, procedural accuracy, and fluency;
- creating a balance of explicit instruction, learning in flexible groupings, and independent learning. Each form of learning should take place in a safe, supportive, and stimulating environment while taking into consideration that some students may require more systematic and intensive support, more explicit and direct instruction before engaging in independent learning;
- providing environmental, assessment, and instructional accommodations that are specified in the student’s Individual Education Plan in order to maximize the student’s learning (e.g., making available learning tools such as manipulatives, resources, adapted game pieces, oversized tangrams, and calculators; ensuring access to assistive technology);
- building an inclusive community of learners and encouraging students with special education needs to participate in various mathematics-oriented class projects and activities;
- building partnerships with administrators and other teachers, particularly special education teachers, where available, to share expertise and knowledge of the curriculum expectations; co-develop content in the Individual Education Plan that is specific to mathematics; and systematically implement intervention strategies, as required, while making meaningful connections between school and home to ensure that what the student is learning in the school is relevant and can be practised and reinforced beyond the classroom.

Planning Mathematics Programs for English Language Learners

English language learners are working to achieve the curriculum expectations in mathematics while they are acquiring English-language proficiency. An effective mathematics program that supports the success of English language learners is purposefully planned with the following considerations in mind.

- Students’ various linguistic identities are viewed as a critical resource in mathematics instruction and learning. This enables students to use their linguistic repertoire in a fluid and dynamic way, mixing and meshing languages to communicate. This translanguaging practice¹⁷ is creative and strategic, and allows students to communicate, interact, and connect with peers and teachers for a variety of purposes, such as when developing conceptual knowledge and when seeking clarity and understanding.
- Knowledge of English language learners’ mathematical strengths, interests, and identities, including their social and cultural backgrounds is important. These “funds of knowledge”¹⁸ are historically and culturally developed skills and assets that can be incorporated into mathematics learning to create a richer and more highly scaffolded learning experience for all students, promoting a positive, inclusive teaching and learning environment.
- In addition to assessing their level of English-language proficiency, an initial assessment of the math knowledge and skills of newcomer English language learners is required in Ontario schools.
- Differentiated instruction is essential in supporting English language learners, who face the dual challenge of learning new conceptual knowledge while acquiring English-language proficiency. Designing mathematics learning to have the right balance for English language learners is achieved through program adaptations (i.e., accommodations and/or modifications) that ensure the tasks are mathematically challenging, reflective of learning demands within the mathematics curriculum, and comprehensible and accessible to English language learners. Using the full range of a student’s language assets, including additional languages that a student speaks, reads, and writes, as a resource in the mathematics classroom supports access to their prior learning, reduces the language demands of the mathematics curriculum, and increases engagement;
- Working with students and their families and with available community supports allows for the multilingual representation of mathematics concepts to create relevant and real-life learning contexts and tasks.

In a supportive learning environment, scaffolding the learning of mathematics assessment and instruction offers English language learners the opportunity to:

¹⁷ García, O., Johnson, S. I., & Seltzer, K. (2017). *The translanguaging classroom: Leveraging student bilingualism for learning*. Philadelphia, PA: Caslon.

¹⁸ Marshall, E., & Toohey, K. (2010). Representing family: Community funds of knowledge, bilingualism, and multimodality. *Harvard Educational Review*, 80(2), 221-242.

- access their other language(s) (e.g., by using technology to access mathematical terminology and ways of solving problems in their first language), prior learning experiences, and background knowledge in mathematics;
- learn new mathematical concepts in authentic, meaningful, and familiar contexts;
- engage in open and parallel tasks to allow for multiple entry points for learning;
- work in a variety of settings that support co-learning and multiple opportunities to practice (e.g., with partners or in small groups, as part of cooperative learning, in group conferences);
- access the language of instruction during oral, written, and multimodal instruction and assessment, during questioning, and when encountering texts, learning tasks, and other activities in the mathematics program;
- use oral language in different strategically planned activities, such as “think-pair-share”, “turn-and-talk”, and “adding on”, to express their ideas and engage in mathematical discourse;
- develop both everyday and academic vocabulary, including specialized mathematics vocabulary in context, through rephrasing and recasting by the teacher and through using student-developed bilingual word banks or glossaries;
- practise using sentence frames adapted to their English-language proficiency levels to describe concepts, provide reasoning, hypothesize, make judgements, and explain their thinking;
- use a variety of concrete and/or digital learning tools to demonstrate their learning in mathematics in multiple ways (e.g., orally, visually, kinesthetically), through a range of representations (e.g., portfolios, displays, discussions, models), and in multiple languages (e.g., multilingual word walls and anchor charts);
- have their learning assessed in terms of the processes they use in multiple languages, both during the learning and through teachers’ observations and conversations.

Strategies used to differentiate instruction and assessment for English language learners in the mathematics classroom also benefit many other learners in the classroom, since programming is focused on leveraging all students’ strengths, meeting learners where they are in their learning, being aware of language demands in the mathematics program, and making learning visible. For example, different cultural approaches to solve mathematical problems can help students make connections to the Ontario curriculum and provide classmates with alternate ways of solving problems.

English language learners in English Literacy Development (ELD) programs in Grades 3 to 8 require accelerated support to develop both their literacy skills and their numeracy skills. These students have significant gaps in their education because of limited or interrupted prior schooling. They are learning key mathematical concepts missed in prior years in order to build a solid foundation of mathematics. At the same time, they are learning the academic language of mathematics in English while not having acquired developmentally appropriate literacy skills in

their first language. Programming for these students is, therefore, highly differentiated and intensive. These students often require focused support over a longer period than students in English as a Second Language (ESL) programs. The use of the student’s oral competence in languages other than English is a non-negotiable scaffold. The strategies described above, such as the use of visuals, the development of everyday and academic vocabulary, the use of technology, and the use of oral competence, are essential in supporting student success in ELD programs and in mathematics.

Supporting English language learners is a shared responsibility. Collaboration with administrators and other teachers, particularly ESL/ELD teachers, where possible, contributes to creating equitable outcomes for English language learners. Additional information on planning for and assessing English language learners can be found in the [“Planning for English Language Learners” subsection of "Considerations for Program Planning”](#).

Human Rights, Equity, and Inclusive Education in Mathematics

Research indicates that there are groups of students who continue to experience systemic barriers to learning mathematics. Systemic barriers can result in inequitable outcomes, such as chronic underachievement and low confidence in mathematics. Achieving equitable outcomes in mathematics for all students requires educators to pay attention to these barriers and to how they can overlap and intersect, compounding their effect. Educators ensure that students have access to enrichment support, as necessary, and they capitalize on the rich cultural knowledge, experience, and competencies that all students bring to mathematics learning. When educators develop pedagogical practices that are differentiated, culturally relevant, and responsive, and hold high and appropriate expectations of students, they maximize the opportunity for all students to learn, and they create the conditions necessary to ensure that students have a positive identity as a mathematics learner and can succeed in mathematics and in all other subjects.

It is essential to develop practices that learn from and build on students’ cultural competencies and linguistic resources, recognizing that students bring a wealth of mathematical knowledge, information, experiences, and skills into the classroom, often in languages different from the language of instruction. Educators create the conditions for authentic mathematics experiences by connecting mathematics learning to students’ communities and lives; by respecting and harnessing students’ prior knowledge, experiences, strengths, and interests; and by acknowledging and actively reducing and eliminating the systemic barriers that some students face. Mathematics learning that is student-centered allows students to find relevance and meaning in what they are learning, to make real-life connections to the curriculum.

Mathematics classrooms also provide an opportunity for cross-curricular learning and for teaching about human rights. To create safe, inclusive, and engaging learning environments, educators must be committed to equity and inclusion for all students and to upholding and promoting human rights. Every student, regardless of their background, identity, or personal circumstances, has the right to have mathematics opportunities that allow them to succeed, personally and academically. In any mathematics classroom, it is crucial to acknowledge students' multiple social identities and how students intersect with the world.¹⁹ Educators have an obligation to develop and nurture learning environments that are reflective of and responsive to students' strengths, needs, cultures, and diverse lived experiences, and to set appropriate and high expectations for all.

Culturally Relevant and Responsive Pedagogy in Mathematics

Rich, high-quality instruction and tasks are the foundation of culturally relevant and responsive pedagogy (CRRP) in mathematics. In CRRP classrooms, teachers learn about their own identities and pay attention to how those identities affect their teaching, their ideas, and their biases. Teachers also learn about students' identities, identifications, and/or affiliations and build on students' ideas, questions, and interests to support the development of an engaging mathematics classroom community.

In mathematics spaces using CRRP, students are engaged in shaping much of the learning so that students have mathematical agency and feel invested in the outcomes. Students develop agency that motivates them to take ownership of their learning of, and progress in, mathematics. Teaching about diverse mathematical figures in history and from different global contexts enables students not only to see themselves reflected in mathematical learning – a key factor in developing students' sense of self – but also to learn about others, and the multiple ways mathematics exists in all aspects of the world around them.

Culturally reflective and responsive teachers know that there is more than one way to develop a solution. Students are exposed to multiple ways of knowing and are encouraged to explore multiple ways of finding answers. For example, an Indigenous pedagogical approach emphasizes holistic, experiential learning; teacher modelling; and the use of collaborative and engaging activities. Teachers differentiate instruction and assessment opportunities to encourage different ways of learning, to allow all students to learn from and with each other, and to promote an awareness of and respect for the diverse and multiple ways of knowing that make up our classrooms, schools, and the world. When making connections between mathematics and real-life applications, teachers may work in partnership with Indigenous communities to co-teach. Teachers may respectfully incorporate Indigenous culturally specific

¹⁹ Culturally Responsive Pedagogy Towards Equity and Inclusivity in Ontario Schools, *Capacity Building Series*, 35. Toronto: Ontario Ministry of Education, November 2013.

examples as a way to meaningfully infuse Indigenous knowledge into the mathematics program. In this way, culturally specific examples can be used without cultural appropriation.

More information on equity and inclusive education can be found in the "[Human Rights, Equity, and Inclusive Education](#)" subsection of "[Considerations for Program Planning](#)".

Cross-Curricular and Integrated Learning in Mathematics

When planning an integrated mathematics program, educators should consider that, although the mathematical content in the curriculum is outlined in discrete strands, students develop mathematical thinking, such as proportional reasoning, algebraic reasoning, and spatial reasoning, that transcends the expectations in the strands and even connects to the learning in many other subject areas. By purposefully drawing connections across all areas of mathematics and to other subject areas, and by applying learning to relevant real-life contexts, teachers extend and enhance student learning experiences and deepen their knowledge and skills across disciplines and beyond the classroom.

For example, proportional reasoning, which is developed through the study of ratios and rates in the Number strand, is also used when students are working towards meeting learning expectations in other strands of the math curriculum, such as Spatial Sense, and in other disciplines, such as science, geography, and the arts. Students then apply this learning in their everyday lives – for example, when adjusting a recipe or preparing a mixture or solutions.

Similarly, algebraic reasoning is applied beyond the Algebra strand. For example, it is applied in measurement when learning about formulas, such as *area of a parallelogram = base × height*. It is applied in other disciplines, such as science, when students study simple machines and learn about the formula *work = force × distance*. Algebraic reasoning is also used when making decisions in everyday life – for example, when determining which service provider offers a better consumer contract or when calculating how much time it will take for a frozen package to thaw.

Spatial thinking has a fundamental role throughout the Ontario curriculum, from Kindergarten to Grade 12, including in mathematics, the arts, health and physical education, and science. For example, a student demonstrates spatial reasoning when mentally rotating and matching shapes in mathematics, planning their move to the basketball hoop, and using diagonal and converging lines to create perspective drawing in visual art. In everyday life, there are many applications of spatial reasoning, such as when creating a garden layout or when using a map to navigate the most efficient way of getting from point A to point B.

Teaching mathematics as a narrowly defined subject area places limits on the depth of learning that can occur. When teachers work together to develop integrated learning opportunities and highlight cross-curricular connections, students are better able to:

- make connections between mathematics and other subject areas, and among the strands of the mathematics curriculum;
- improve their ability to provide multiple responses to a problem;
- debate and test whether responses are effective and efficient;
- apply a range of knowledge and skills to solve problems in mathematics and in their daily experiences and lives.

When students are provided with opportunities to learn mathematics through real-life applications, integrating learning expectations from across the curriculum, they use their knowledge of other subject matter to enhance their learning of and engagement in mathematics. More information about integrating learning across the curriculum can be found in [“Cross-Curricular and Integrated Learning”](#).

Literacy in Mathematics

Literacy skills needed for reading and writing in general are essential for the learning of mathematics. To engage in mathematical activities and develop computational fluency, students require the ability to read and write mathematical expressions, to use a variety of literacy strategies to comprehend mathematical text, to use language to analyse, summarize, and record their observations, and to explain their reasoning when solving problems. Research shows that “mathematics texts contain more concepts per sentence and paragraph than any other type of text”.²⁰ Reading a mathematics text requires specific literacy strategies, unique to mathematics. Learning in “some areas of math in particular, such as word problems and number combinations may be mediated by language and reading due to the nature of the task.”²¹ As a result, there is a strong correlation between reading and math achievement.

The learning of mathematics requires students to navigate discipline-specific texts that “must be written and read in appropriate ways”; therefore, it is important that math instruction

²⁰ Kenney, Joan M. et al. (2007). *Literacy strategies for improving mathematics instruction*. Heatherton, Vic: Hawker Brownlow Education. Page 11.

²¹ Rutherford-Becker, Kristy J. & Vanderwood, Michael L. (2009). Evaluation of the relationship between literacy and mathematics skills as assessed by curriculum-based measures. *California School Psychologist*, Vol.14, page 25.

addresses both “mathematical texts and literacies.”²² Many of the activities and tasks students undertake in mathematics involve the use of written, oral, visual, and multimodal communication skills as they encounter mathematical texts such as “equations, graphs, diagrams, proofs, justifications, displays of manipulatives (e.g., base ten blocks), calculator readouts, verbal mathematical discussions, and written descriptions of problems.”²³ The language of mathematics includes special terminology. To support all students in developing an understanding of mathematical texts, teachers need to explicitly teach mathematical vocabulary, focusing on the many meanings and applications of the terms students may encounter. In all mathematics programs, students are required to use appropriate and correct terminology and are encouraged to use language with care and precision in order to communicate effectively.

More information about the importance of literacy across the curriculum can be found in the “[Literacy](#)” and “[Mathematical Literacy](#)” subsections of “Cross-curricular and Integrated Learning”.

Transferable Skills in Mathematics

The Ontario curriculum emphasizes a set of skills that are critical to all students’ ability to thrive in school, in the world beyond school, and in the future. These are known as transferable skills. Educators facilitate students’ development of transferable skills across the curriculum, from Kindergarten to Grade 12. They are as follows:

- **Critical Thinking and Problem Solving.** In mathematics, students and educators learn and apply strategies to understand and solve problems flexibly, accurately, and efficiently. They learn to understand and visualize a situation and use the tools and language of mathematics to reason, make connections to real-life situations, communicate, and justify solutions.
- **Innovation, Creativity, and Entrepreneurship.** In mathematics, students and educators solve problems with curiosity, creativity, and a willingness to take risks. They pose questions, make and test conjectures, and consider problems from different perspectives to generate new learning and apply it to novel situations.

²² Siebert, D., & Hendrickson, S. (2010). (Re)imagining literacies for mathematics classrooms. In R. J. Draper, P. Broomhead, A. P. Jensen, J. D. Nokes, & D. Siebert (Eds.), *(Re)imagining content-area literacy instruction*. New York, NY: Teachers College Press. Page 43.

²³ Siebert, D., & Hendrickson, S. (2010). (Re)imagining literacies for mathematics classrooms. In R. J. Draper, P. Broomhead, A. P. Jensen, J. D. Nokes, & D. Siebert (Eds.), *(Re)imagining content-area literacy instruction*. New York, NY: Teachers College Press. Page 41.

- **Self-Directed Learning.** By reflecting on their own thinking and emotions, students, with the support of educators, can develop perseverance, resourcefulness, resilience, and a sense of self. In mathematics, they initiate new learning, monitor their thinking and their emotions when solving problems and apply strategies to overcome challenges. They see mathematics as useful, interesting, and doable and confidently look for ways to apply their learning.
- **Collaboration.** In mathematics, students and educators engage with others productively, respectfully, and critically in order to better understand ideas and problems, generate solutions, and refine their thinking.
- **Communication.** In mathematics, students and educators use the tools and language of mathematics to describe their thinking and to understand the world. They use mathematical vocabulary, symbols, conventions, and representations to make meaning, express a point of view, and make convincing and compelling arguments in a variety of ways, including multimodally, for example, using combinations of oral, visual, textual, and gestural communication.
- **Global Citizenship and Sustainability.** In mathematics, students and educators recognize and appreciate multiple ways of knowing, doing, and learning, and value different perspectives. They see how mathematics is used in all walks of life and how engaged citizens can use it as a tool to raise awareness and generate solutions for real-life issues.
- **Digital Literacy.** In mathematics, students and educators learn to be discerning users of technology. They select when and how to use appropriate tools to understand and model real-life situations, predict outcomes, and solve problems, and they assess and evaluate the reasonableness of their results.

More information on instructional approaches can be found in the "[Transferable Skills](#)" section of "Program Planning".

Assessment and Evaluation of Student Achievement

Growing Success: Assessment, Evaluation, and Reporting in Ontario Schools, First Edition, Covering Grades 1 to 12, 2010 sets out the Ministry of Education’s assessment, evaluation, and reporting policy. The policy aims to maintain high standards, improve student learning, and benefit all students, parents, and teachers in elementary and secondary schools across the province. Successful implementation of this policy depends on the professional judgement²⁴ of teachers at all levels as well as their high expectations of all students, and on their ability to work together and to build trust and confidence among parents and students.

Major aspects of assessment, evaluation, and reporting policy are summarized in the main “[Assessment and Evaluation](#)” section. The key tool for assessment and evaluation in mathematics – the achievement chart – is provided below.

The Achievement Chart for Mathematics

The achievement chart identifies four [categories of knowledge and skills](#) and four [levels of achievement](#) in mathematics. (For important background, see “[Content Standards and Performance Standards](#)” in the main Assessment and Evaluation section.)

Knowledge and Understanding – Subject-specific content acquired in each grade (knowledge), and the comprehension of its meaning and significance (understanding)				
Categories	Level 1	Level 2	Level 3	Level 4
	The student:			
Knowledge of content <i>(e.g., math facts, computational strategies, terminology, mathematical models, money values)</i>	demonstrates limited knowledge of content	demonstrates some knowledge of content	demonstrates considerable knowledge of content	demonstrates thorough knowledge of content
Understanding of content <i>(e.g., concepts, theories, procedures,</i>	demonstrates limited understanding of content	demonstrates some understanding of content	demonstrates considerable understanding of content	demonstrates thorough understanding of content

²⁴ “Professional judgement”, as defined in *Growing Success* (p. 152), is “judgement that is informed by professional knowledge of curriculum expectations, context, evidence of learning, methods of instruction and assessment, and the criteria and standards that indicate success in student learning. In professional practice, judgement involves a purposeful and systematic thinking process that evolves in terms of accuracy and insight with ongoing reflection and self-correction”.

<i>principles, mathematical processes)</i>				
Thinking – The use of critical and creative thinking skills and/or processes				
Categories	Level 1	Level 2	Level 3	Level 4
	The student:			
Use of planning skills <i>(e.g., interpreting and expressing problems, identifying unknown(s), making conjectures and estimates, identifying steps to take, considering the use of models and representations, selecting strategies and tools)</i>	uses planning skills with limited effectiveness	uses planning skills with some effectiveness	uses planning skills with considerable effectiveness	uses planning skills with a high degree of effectiveness
Use of processing skills* <i>(e.g., carrying out plans: collecting data, questioning, testing, revising, modelling, solving, inferring, forming conclusions; looking back at solutions: reflecting, evaluating reasonableness, reasoning, justifying, proving)</i>	uses processing skills with limited effectiveness	uses processing skills with some effectiveness	uses processing skills with considerable effectiveness	uses processing skills with a high degree of effectiveness
Use of critical/creative thinking processes* <i>(e.g., making and testing conjectures, posing and solving problems, critiquing solutions, providing mathematical reasoning)</i>	uses critical/creative thinking processes with limited effectiveness	uses critical/creative thinking processes with some effectiveness	uses critical/creative thinking processes with considerable effectiveness	uses critical/creative thinking processes with a high degree of effectiveness
Communication – The conveying of meaning through various forms				
Categories	Level 1	Level 2	Level 3	Level 4
	The student:			
Expression and organization of ideas and information <i>(e.g., clear expression, logical organization) in oral,</i>	expresses and organizes ideas and information	expresses and organizes ideas and information	expresses and organizes ideas and information with	expresses and organizes ideas and information with a high

visual, and/or written forms (e.g., pictorial, graphic, numeric, algebraic forms; gestures and other non-verbal forms; models)	with limited effectiveness	with some effectiveness	considerable effectiveness	degree of effectiveness
Communication for different audiences (e.g., peers, adults) and purposes (e.g., to generate ideas, present data, justify a solution) in oral, visual, and/or written forms	communicates for different audiences and purposes with limited effectiveness	communicates for different audiences and purposes with some effectiveness	communicates for different audiences and purposes with considerable effectiveness	communicates for different audiences and purposes with a high degree of effectiveness
Use of conventions, vocabulary, and terminology of the discipline in oral, visual, and/or written forms (e.g., terms, symbols)	uses conventions, vocabulary, and terminology with limited effectiveness	uses conventions, vocabulary, and terminology with some effectiveness	uses conventions, vocabulary, and terminology with considerable effectiveness	uses conventions, vocabulary, and terminology with a high degree of effectiveness
Application – The use of knowledge and skills to make connections within and between various contexts				
Categories	Level 1	Level 2	Level 3	Level 4
	The student:			
Application of knowledge and skills (e.g., representations and computational strategies) in familiar contexts	applies knowledge and skills in familiar contexts with limited effectiveness	applies knowledge and skills in familiar contexts with some effectiveness	applies knowledge and skills in familiar contexts with considerable effectiveness	applies knowledge and skills in familiar contexts with a high degree of effectiveness
Transfer of knowledge and skills (e.g., representations and computational strategies) to new contexts	transfers knowledge and skills to new contexts with limited effectiveness	transfers knowledge and skills to new contexts with some effectiveness	transfers knowledge and skills to new contexts with considerable effectiveness	transfers knowledge and skills to new contexts with a high degree of effectiveness

<p>Making connections within and between various contexts (<i>e.g., connections to everyday and real-life situations; connections involving an understanding of the relationships between different measurements; connections among concepts, representations, and forms within mathematics; connections involving use of prior knowledge and experience; connections among mathematics and other disciplines, including other STEM [science, technology, engineering, and mathematics] subjects</i>)</p>	<p>makes connections within and between various contexts with limited effectiveness</p>	<p>makes connections within and between various contexts with some effectiveness</p>	<p>makes connections within and between various contexts with considerable effectiveness</p>	<p>makes connections within and between various contexts with a high degree of effectiveness</p>
--	---	--	--	--

* Note:

The processing skills and critical/creative thinking processes in the Thinking category include some but not all aspects of the *mathematical processes* laid out in Strand A: Social-Emotional Learning and Mathematical Processes. Some aspects of the mathematical processes relate to the other categories of the achievement chart.

Criteria and Descriptors for Mathematics

To guide teachers in their assessment and evaluation of student learning, the achievement chart provides “criteria” and “descriptors” within each of the four categories of knowledge and skills.

A set of criteria is identified for each category in the achievement chart. The criteria are subsets of the knowledge and skills that define the category. The criteria identify the aspects of student performance that are assessed and/or evaluated, and they serve as a guide to what teachers look for. In the mathematics curriculum, the criteria for each category are as follows:

Knowledge and Understanding

- knowledge of content (e.g., math facts, computational strategies, terminology, mathematical models, money values)
- understanding of content (e.g., concepts, theories, procedures, principles, mathematical processes)

Thinking

- use of planning skills (e.g., interpreting and expressing problems, identifying unknown(s), making conjectures and estimates, identifying steps to take, considering the use of models and representations, selecting strategies and tools)
- use of processing skills (e.g., carrying out plans: collecting data, questioning, testing, revising, modelling, solving, inferring, forming conclusions; looking back at solutions: reflecting, evaluating reasonableness, reasoning, justifying, proving)
- use of critical/creative thinking processes (e.g., making and testing conjectures, posing and solving problems, critiquing solutions, providing mathematical reasoning)

Communication

- expression and organization of ideas and information (e.g., clear expression, logical organization) in oral, visual, and/or written forms (e.g., pictorial, graphic, numeric, algebraic forms; gestures and other non-verbal forms; models)
- communication for different audiences (e.g., peers, adults) and purposes (e.g., to generate ideas, present data, justify a solution) in oral, visual, and/or written forms
- use of conventions, vocabulary, and terminology of the discipline in oral, visual, and/or written forms (e.g., terms, symbols)

Application

- application of knowledge and skills (e.g., representations and computational strategies) in familiar contexts
- transfer of knowledge and skills (e.g., representations and computational strategies) to new contexts
- making connections within and between various contexts (e.g., connections to everyday and real-life situations; connections involving an understanding of the relationships between different measurements; connections among concepts, representations, and forms within mathematics; connections involving use of prior knowledge and experience; connections among mathematics and other disciplines, including other STEM [science, technology, engineering, and mathematics] subjects)

“Descriptors” indicate the characteristics of the student’s performance, with respect to a particular criterion, on which assessment or evaluation is focused. *Effectiveness* is the descriptor used for each of the criteria in the Thinking, Communication, and Application categories. What constitutes effectiveness in any given performance task will vary with the particular criterion being considered. Assessment of effectiveness may therefore focus on a quality such as appropriateness, clarity, accuracy, precision, logic, relevance, significance, fluency, flexibility, depth, or breadth, as appropriate for the particular criterion.

Mathematics, Grade 1

Expectations by strand

A. Social-Emotional Learning (SEL) Skills in Mathematics and the Mathematical Processes

This strand focuses on students' development and application of social-emotional learning skills to support their learning of math concepts and skills, foster their overall well-being and ability to learn, and help them build resilience and thrive as math learners. As they develop SEL skills, students demonstrate a greater ability to understand and apply the mathematical processes, which are critical to supporting learning in mathematics. In all grades of the mathematics program, the learning related to this strand takes place in the context of learning related to all other strands, and it should be assessed and evaluated within these contexts.

Overall expectations

Throughout this grade, in order to promote a positive identity as a math learner, to foster well-being and the ability to learn, build resilience, and thrive, students will:

A1. Social-Emotional Learning (SEL) Skills and the Mathematical Processes

apply, to the best of their ability, a variety of social-emotional learning skills to support their use of the mathematical processes and their learning in connection with the expectations in the other five strands of the mathematics curriculum

To the best of their ability, students will learn to:	... as they apply the mathematical processes :	... so they can:
1. identify and manage emotions	<ul style="list-style-type: none"> • problem solving: develop, select, and apply problem-solving strategies • reasoning and proving: develop and apply reasoning skills (e.g., classification, recognition of relationships, use of counter-examples) to justify thinking, make and investigate conjectures, and construct and defend arguments 	1. express and manage their feelings, and show understanding of the feelings of others, as they engage positively in mathematics activities
2. recognize sources of stress and cope with challenges	<ul style="list-style-type: none"> • reflecting: demonstrate that as they solve problems, they are pausing, looking back, and monitoring their thinking to help clarify their understanding (e.g., by comparing and adjusting strategies used, by explaining why they think their results are reasonable, by recording their thinking in a math journal) 	2. work through challenging math problems, understanding that their resourcefulness in using various strategies to respond to stress is helping them build personal resilience
3. maintain positive motivation and perseverance	<ul style="list-style-type: none"> • connecting: make connections among mathematical concepts, procedures, and representations, and relate mathematical ideas to other contexts (e.g., other curriculum areas, daily life, sports) 	3. recognize that testing out different approaches to problems and learning from mistakes is an important part of the learning process, and is aided by a sense of optimism and hope
4. build relationships and communicate effectively	<ul style="list-style-type: none"> • communicating: express and understand mathematical thinking, and engage in mathematical arguments using everyday language, language resources as necessary, appropriate mathematical terminology, a variety of representations, and mathematical conventions 	4. work collaboratively on math problems – expressing their thinking, listening to the thinking of others, and practising inclusivity – and in that way fostering healthy relationships
5. develop self-awareness and sense of identity	<ul style="list-style-type: none"> • representing: select from and create a variety of representations of mathematical ideas (e.g., 	5. see themselves as capable math learners, and strengthen their sense of ownership of their learning, as part of their emerging sense of identity and belonging

6. think critically and creatively	representations involving physical models, pictures, numbers, variables, graphs), and apply them to solve problems <ul style="list-style-type: none"> • selecting tools and strategies: select and use a variety of concrete, visual, and electronic learning tools and appropriate strategies to investigate mathematical ideas and to solve problems 	6. make connections between math and everyday contexts to help them make informed judgements and decisions
------------------------------------	--	--

B. Number

Overall expectations

By the end of Grade 1, students will:

B1. Number Sense

demonstrate an understanding of numbers and make connections to the way numbers are used in everyday life

Specific expectations

By the end of Grade 1, students will:

B1.1 Whole Numbers

read and represent whole numbers up to and including 50, and describe various ways they are used in everyday life

Teacher supports

Key concepts

- Reading numbers involves interpreting them as a quantity when they are expressed in words or numerals, or represented using physical quantities or diagrams.
- The numerals 0 to 9 are used to form numbers. They are referred to as the digits in a number and each digit corresponds to a place value. For example, in the number 25, the digit 2 represents 2 tens and the digit 5 represents 5 ones.
- Sometimes numbers used every day do not represent a quantity. For example:

- Postal codes and license plates are made up of the numerals 0 to 9 and letters.
 - Addresses are assigned numbers in order.
 - Numbers on sports jerseys organize the players on a team.
 - Numbers can rank positions, such as finishing 3rd in a race.
- Sometimes numbers used every day describe quantities (e.g., 12 turtles).
 - Recognizing small quantities without counting (subitizing) is helpful for working with numbers.
 - Numbers can be represented in a variety of ways including the use of counts such as tallies, position, or distance on a number line, in words, using money, and using mathematical learning tools such as ten frames.

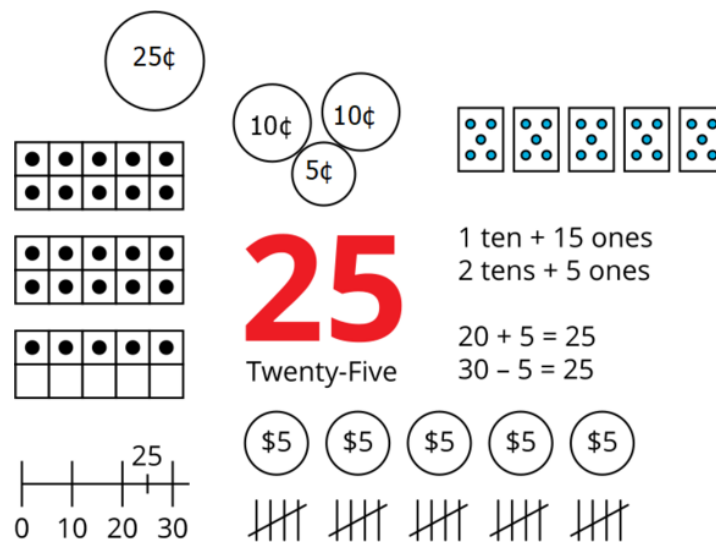

Note

- Every strand in the mathematics curriculum relies on numbers.
- Numbers may have cultural significance.
- Subitizing can help lay the foundation for work with place value, addition and subtraction, and estimation. For example, students looking at the number 32 can visualize 3 ten frames and 2 more; students can see a representation of 7 as 3 + 4. See **SE B1.2**.
- Subitizing is easier when objects are organized (e.g., dots on a die or a domino) than when they are unorganized (i.e., objects randomly positioned).
- Sometimes a quantity is recognized all at once (perceptual subitizing).
- Sometimes a quantity is recognized as smaller quantities that can be added together (conceptual subitizing).

B1.2 Whole Numbers

compose and decompose whole numbers up to and including 50, using a variety of tools and strategies, in various contexts

Teacher supports

Key concepts

- Numbers are composed when two or more numbers are combined to create a larger number. For example, twenty and five are composed to make twenty-five.
- Numbers are decomposed when they are taken apart to make two or more smaller numbers that represent the same quantity. For example, 25 can be represented as two 10s and one 5.

Note

- When a number is decomposed and then recomposed, the quantity is unchanged. This is the conservation principle.
- Numbers can be decomposed by their place value.
- Composing and decomposing numbers in a variety of ways can support students in becoming flexible with their mental math strategies for addition and subtraction.
- Certain tools are helpful for showing the composition and decomposition of numbers. For example:
 - Ten frames can show how numbers compose to make 10 or decompose into groups of 10.
 - Rekenreks can show how numbers are composed as groups of 5s and 10s or decomposed into 5s and 10s.
 - Coins and bills can show how numbers are composed and decomposed according to their values.
 - Number lines can be used to show how numbers are composed or decomposed using different combinations of “jumps”.

B1.3 Whole Numbers

compare and order whole numbers up to and including 50, in various contexts

Teacher supports

Key concepts

- Numbers are compared and ordered according to their “how muchness”.
- Numbers with the same units can be compared directly. For example, 5 cents and 20 cents, 12 birds and 16 birds. Numbers that do not show a unit are assumed to have units of ones (e.g., 5 and 12 are considered as 5 ones and 12 ones).
- Numbers can be ordered in ascending order – from least to greatest – or can be ordered in descending order – from greatest to least.

Note

- The “how muchness” of a number is its magnitude.
- There is a stable order to how numbers are sequenced, and patterns exist within this sequence that make it possible to predict the order and make comparisons.
- The sequence from 1 to 19 has fewer patterns than sequences involving greater numbers and so requires a lot of practice to consolidate.
- The “decades” that follow the teens pick up on the 1 to 9 pattern. Within each decade, the 1 to 9 sequence is repeated. After 9 comes the next decade. The pattern of naming the decade is not always overt in English. For example, 30 means “three tens”, but this connection may not be noticed by hearing the word “thirty”.
- Number lines and hundreds charts model the sequence of numbers and can be used to uncover patterns.

B1.4 Whole Numbers

estimate the number of objects in collections of up to 50, and verify their estimates by counting

Teacher supports

Key concepts

- Estimation is used to approximate quantities that are too great to subitize.
- Different strategies can be used to estimate the quantity in a collection. For example, a portion of the collection can be subitized and then that amount visualized to count the remainder of the collection.
- Although there are many different ways to count a collection (see **SE B1.5**), if the count is carried out correctly, the count will always be the same.

Note

- Estimating collections involves unitizing, for example, into groups of 5, and then counting by those units (skip counting by 5s).
- Estimation skills are important for determining the reasonableness of calculations and in developing a sense of measurement.

B1.5 Whole Numbers

count to 50 by 1s, 2s, 5s, and 10s, using a variety of tools and strategies

Teacher supports

Key concepts

- The count of objects does not change, regardless of how the objects are arranged (e.g., close together or far apart) or in what order they are counted (order irrelevance).
- Counting objects may involve counting an entire collection or counting the quantity of objects that satisfy certain attributes.
- Objects can be counted individually or in groups of equal quantities. The skip count is based on the number of objects in the equal groups.
- Each object in a collection must be touched or included in the count only once and matched to the number being said (one-to-one-correspondence).
- The numbers in the counting sequence must be said once, and always in the standard order (stable order).
- The last number said during a count describes how many there are in the whole collection (cardinality), including when groups are combined to solve an addition problem.

Note

- The counting principles are: one-to-one correspondence, stable order, conservation principle, order irrelevance, and cardinality.
- When skip counting groups of objects of the same quantity, the unit of skip count is the number of objects in each group. For example, when each group has two objects, the counter should count by twos.
- When skip counting a set of objects that leaves remainders or leftovers, the leftovers must still be counted for the total to be accurate. For example, when counting a collection of 37 by 5s, the 2 left over need to be counted individually and added to 35.

- Skip counting is an efficient way to count larger collections, and it also helps build basic facts and mental math strategies and establishes a strong foundation for multiplication and division.
- Counts can be tracked using tally marks. An application of this is identified in the Data strand; see **Data, SE D1.2**.

B1.6 Fractions

use drawings to represent and solve fair-share problems that involve 2 and 4 sharers, respectively, and have remainders of 1 or 2

Teacher supports

Key concepts

- Fair-sharing or equal-sharing means that quantities are shared equally. For a whole to be shared equally, it must be partitioned so that each sharer receives the same amount.

Note

- Words can have multiple meanings. It is important to be aware that in many situations, fair does not mean equal, and equal is not equitable. Educators should clarify how they are using the term "fair share" and ensure that students understand that in the math context fair means equal and the intent behind such math problems is to find equal amounts.
- Fair-share or equal-share problems provide a natural context for encountering fractions and division. Present these problems in the way that students will best connect to.
- Whole numbers and fractions are used to describe fair-share or equal-share amounts. For example, 5 containers of playdough shared between 2 people means that each person receives 2 containers and half of another container. Or each person could receive 5 halves, depending on the sharing strategy used.
- Fractions have specific names. In Grade 1, students should be introduced to the terminology of "half/halves" and "fourth/fourths".

B1.7 Fractions

recognize that one half and two fourths of the same whole are equal, in fair-sharing contexts

Teacher supports

Key concepts

- When something is shared fairly, or equally as two pieces, each piece is $\frac{1}{2}$ of the original amount. Two $\frac{1}{2}$ s make up a whole.
- When something is shared fairly, or equally as four pieces, each piece is $\frac{1}{4}$ of the original amount. Four $\frac{1}{4}$ s make up a whole.
- If the original amount is shared as two pieces or four pieces, the fractions $\frac{1}{2}$ and $\frac{2}{4}$ are equivalent.
- A half of a half is a fourth.
- If something is cut in half, it is not possible for one person to get “the big half” while the other person gets “the small half”. If something is cut in half, both pieces are exactly equal. If there is a “big half”, then it isn’t a half.

Note

- Words can have multiple meanings. It is important to be aware that in many situations, fair does not mean equal, and equal is not equitable. Educators should clarify how they are using the term “fair share” and ensure that students understand that in the math context fair means equal and the intent behind such math problems is to find equal amounts.
- Different fractions can describe the same amount as long as they are based on the same whole.
- The size of the whole matters. If $\frac{1}{2}$ and $\frac{1}{4}$ are based on the same whole, then $\frac{1}{2}$ is twice as big as $\frac{1}{4}$. But if a small sticky note is cut into halves, and a big piece of chart paper is cut into fourths, then the $\frac{1}{4}$ of the chart paper is bigger than the $\frac{1}{2}$ of the sticky note.
- The fair-share problems that students engage in for learning around **SE B1.6** will provide the opportunity to notice that $\frac{1}{2}$ and $\frac{2}{4}$ are the same amount.
- Students in this grade are not expected to write fractions symbolically; they should write “half”, not “ $\frac{1}{2}$ ”.

B1.8 Fractions

use drawings to compare and order unit fractions representing the individual portions that result when a whole is shared by different numbers of sharers, up to a maximum of 10

Teacher supports

Key concepts

- When one whole is shared equally by a number of sharers, the number of sharers determines the size of each individual portion and is reflected in how that portion is named. For example, if a whole is equally shared among eight people, the whole has been split into *eighths*, and each part is one eighth of the whole. One eighth is a unit fraction, and there are 8 one eighths in a whole.
- The size of the whole matters. When comparing fractions as numbers, it is assumed they refer to the same-sized whole. Without a common whole, it is quite possible for one fourth to be larger than one half.
- Sharing a whole equally among more sharers creates smaller shares; conversely, sharing a whole equally among fewer sharers creates larger shares. So, for example, 1 one fourth is larger than 1 one fifth, when taken from the same whole or set.

B2. Operations

use knowledge of numbers and operations to solve mathematical problems encountered in everyday life

Specific expectations

By the end of Grade 1, students will:

B2.1 Properties and Relationships

use the properties of addition and subtraction, and the relationship between addition and subtraction, to solve problems and check calculations

Teacher supports

Key concepts

- When zero is added or subtracted from a quantity, the quantity does not change.
- Adding numbers in any order gives the same result.
- Addition and subtraction are inverse operations, and the same situation can be represented and solved using either operation. Addition can be used to check the answer to a subtraction question, and subtraction can be used to check the answer to an addition question.

Note

- Students need to understand the commutative and identity properties, but they do not need to name them in Grade 1. These properties help in developing addition and subtraction facts.
- This expectation supports most other expectations in the Number strand and is applied throughout the grade. Whether working with numbers or with operations, recognizing and applying properties and relationships builds a strong foundation for doing mathematics.
- Part-whole models help with noticing the inverse operations of addition and subtraction (see **SE B2.4**).
- The inverse relationship can be used to check that a solution is correct.

B2.2 Math Facts

recall and demonstrate addition facts for numbers up to 10, and related subtraction facts

Teacher supports

Key concepts

- Understanding the relationships that exist among numbers and among operations provides strategies for learning basic facts.
- Knowing the fact families can help with recalling the math facts (e.g., $4 + 6 = 10$, $10 - 4 = 6$, and $10 - 6 = 4$).
- There are many strategies that can help with developing and understanding the math facts:
 - Counting on and counting back supports $+ 1$, $+ 2$, $- 1$, and $- 2$ facts.
 - The commutative property (e.g., $6 + 4 = 10$ and $4 + 6 = 10$).
 - The identity property (e.g., $6 + 0 = 6$ and $6 - 0 = 6$).
 - Doubles, doubles $+ 1$, and doubles $- 1$ (e.g., $4 + 5$ can be thought of as $4 + 4$ plus 1 more; 9 can be thought of as 10 less 1 or double 5 less one).

Note

- Addition and subtraction are inverse operations. This means that addition facts can be used to understand and recall subtraction facts (e.g., $5 + 3 = 8$, so $8 - 5 = 3$ and $8 - 3 = 5$).

- Having automatic recall of addition and subtraction facts is useful when carrying out mental and written calculations and frees up working memory when solving complex problems and tasks.

B2.3 Mental Math

use mental math strategies, including estimation, to add and subtract whole numbers that add up to no more than 20, and explain the strategies used

Teacher supports

Key concepts

- Mental math refers to doing calculations in one’s head. Sometimes the numbers or the number of steps in a calculation are too complex to completely hold in one’s head, so jotting down partial calculations and diagrams can be used to complete the calculations.
- Estimation is a useful mental strategy when either an exact answer is not needed or there is insufficient time to work out a calculation.

Note

- To do calculations in one’s head involves using flexible strategies that build on known facts, number relationships, and counting strategies. These strategies continue to expand and develop through the grades.
- Mental math may or may not be quicker than paper-and-pencil strategies, but speed is not the goal. The value of mental math is in its portability and flexibility, since it does not require a calculator or paper and pencil. Practising mental math strategies also deepens an understanding of the relationships between numbers.
- Estimation can be used to check the reasonableness of calculations and should be continually encouraged when students are doing mathematics.
- Number lines, circular number lines, and part-whole models can help students visualize and communicate mental math strategies.

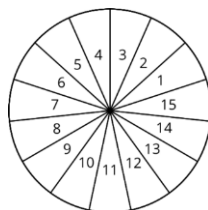
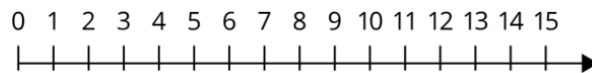

B2.4 Addition and Subtraction

use objects, diagrams, and equations to represent, describe, and solve situations involving addition and subtraction of whole numbers that add up to no more than 50

Teacher supports

Key concepts

- Situations involving addition and subtraction may involve:
 - adding a quantity onto an existing amount or removing a quantity from an existing amount;
 - combining two or more quantities;
 - comparing quantities.
- Acting out a situation by representing it with objects, a drawing, or a diagram can support students in identifying the given quantities in a problem and the unknown quantity.
- Set models can be used to add a quantity on to an existing amount or to remove a quantity from an existing amount.
- Linear models can be used to determine the difference between two numbers by comparing quantities.
- Part-whole models can be used to show the relationship between what is known and what is unknown and how addition and subtraction relate to the situation.

Note

- An important part of problem solving is the ability to choose the operation that matches the action in a situation. Addition and subtraction are useful for showing:
 - when a quantity *changes*, either by *joining* another quantity to it or *separating* a quantity from it;
 - when two quantities (parts) are *combined* to make one whole quantity;
 - when two quantities are *compared*.
- In addition and subtraction, what is unknown can vary:
 - In *change* situations, sometimes the result is unknown, sometimes the starting point is unknown, and sometimes the change is unknown.
 - In *combine* situations, sometimes one part is unknown, sometimes the other part is unknown, and sometimes the total is unknown.

- In *compare* situations, sometimes the larger number is unknown, sometimes the smaller number is unknown, and sometimes the difference is unknown.
- It is important to model the corresponding equation that represents the situation. The unknown may appear anywhere in an equation (e.g., $8 + ? = 19$; $? + 11 = 19$; or $8 + 11 = ?$), and matching the structure of the equation to what is happening in the situation reinforces the meaning of addition and subtraction.
- Sometimes changing a “non-standard” equation (where the unknown is not after the equal sign) into its “standard form” can make it easier to carry out the calculation. Part-whole models make the inverse relationship between addition and subtraction evident and help students develop a flexible understanding of the equal sign. These are important ideas in the development of algebraic reasoning.
- Counting up or counting down are strategies students may use to determine an unknown quantity.

B2.5 Multiplication and Division

represent and solve equal-group problems where the total number of items is no more than 10, including problems in which each group is a half, using tools and drawings

Teacher supports

Key concepts

- With equal-group problems, a group of a given size is repeated a certain number of times to create a total. Sometimes the size of each group is unknown, sometimes the number of groups is unknown, and sometimes the total is unknown.

Note

- For this expectation, students are always given the size of the equal groups and they determine either the number of equal groups or the total needed (not to exceed 10). In **SE B1.6**, students solve fair-share problems that find the size of an equal group.
- It is important that students represent equal-group situations using tools and drawings; this enables them to use counting to solve the problem.
- Solving equal-group problems lays a strong foundation for work with skip counting, using doubles as a fact strategy, multiplication and division, and fractions.

C. Algebra

Overall expectations

By the end of Grade 1, students will:

C1. Patterns and Relationships

identify, describe, extend, create, and make predictions about a variety of patterns, including those found in real-life contexts

Specific expectations

By the end of Grade 1, students will:

C1.1 Patterns

identify and describe the regularities in a variety of patterns, including patterns found in real-life contexts

Teacher supports

Key concepts

- Human activities, histories, and the natural world are made up of all kinds of patterns, and many of them are based on the regularity of an attribute.
- The regularity of attributes may include colour, shape, texture, thickness, orientation, or materials.

Note

- Students can engage in mathematics and patterns through the contexts, cultural histories, and stories of various cultures.
- Patterns do not need to be classified as repeating or otherwise in Grade 1. Instead, focus on the attributes that are being used in patterns.

C1.2 Patterns

create and translate patterns using movements, sounds, objects, shapes, letters, and numbers

Teacher supports

Key concepts

- The same pattern structure can be represented in various ways.
- Patterns can be created by changing one or more attributes.

Note

- When patterns are translated, they are being re-represented using the same type of pattern structure (e.g., AB, AB, AB... to red-black, red-black, red-black).

C1.3 Patterns

determine pattern rules and use them to extend patterns, make and justify predictions, and identify missing elements in patterns

Teacher supports

Key concepts

- Patterns can be extended because they are repetitive by nature.
- Pattern rules are generalizations about a pattern, and they can be described in words.
- Patterns can be extended in multiple directions, by showing what comes next or what came before.
- To make a near prediction about a pattern is to state or show what a pattern will look like just beyond the given representation of that pattern. The prediction can be verified by extending that pattern.
- To make a far prediction about a pattern is to state or show what a pattern will look like well beyond the given representation of that pattern. Often calculations are needed to make an informed prediction or to verify a prediction.
- To identify missing elements of patterns is to complete a representation for a given pattern by filling in the missing parts.

Note

- In order to extend, predict, or determine missing elements in patterns, students need to generalize patterns using pattern rules.
- Rules can be used to verify predictions and to critically analyse extensions and solutions for missing elements.

C1.4 Patterns

create and describe patterns to illustrate relationships among whole numbers up to 50

Teacher supports

Key concepts

- There are patterns in numbers and the way that digits repeat from 0 to 9.

Note

- Creating and analysing patterns that involve decomposing numbers will support students in understanding how numbers are related.
- Creating and analysing patterns involving addition and subtraction facts can help students develop fluency with math facts, as well as understand how to maintain equality among expressions.

C2. Equations and Inequalities

demonstrate an understanding of variables, expressions, equalities, and inequalities, and apply this understanding in various contexts

Specific expectations

By the end of Grade 1, students will:

C2.1 Variables

identify quantities that can change and quantities that always remain the same in real-life contexts

Teacher supports

Key concepts

- Quantities that can change are also referred to as “variables”.
- Quantities that remain the same are also referred to as “constants”.

Note

- Identifying quantities in real life that stay the same and those that can change will help students understand the concept of variability.
- Identifying what is constant and what changes is one aspect of mathematical modelling.
- When students create models of 10 by adding numbers (terms), they are implicitly working with variables. These terms are variables that can change (e.g., in coding, a student's code could be $\text{TotalSteps} = \text{FirstSteps} + \text{SecondSteps}$).
- In mathematics notation, variables are only expressed as letters or symbols. When coding, variables may be represented as words, abbreviated words, symbols, or letters.
- Students are also implicitly working with variables as they are working with attributes (e.g., length, mass, colour, number of buttons), as the value of those attributes can vary.

C2.2 Equalities and Inequalities

determine whether given pairs of addition and subtraction expressions are equivalent or not

Teacher supports

Key concepts

- Numerical expressions are equivalent when they produce the same result, and an equal sign is a symbol denoting that the two expressions are equivalent.
- Numerical expressions are not equivalent when they do not produce the same result, and an equal sign with a slash through it (\neq) is a symbol denoting that the two expressions are not equivalent.

Note

- The equal sign should not be interpreted as the "answer", but rather, that both parts on either side of the equal sign are equal, therefore creating balance.

C2.3 Equalities and Inequalities

identify and use equivalent relationships for whole numbers up to 50, in various contexts

Teacher supports

Key concepts

- When numbers are decomposed, the parts are equivalent to the whole.
- The same whole can result from different parts.

Note

- Many mathematical concepts are based on an underlying principle of equivalency.
- The commutative property is an example of an equivalent relationship.

C3. Coding

solve problems and create computational representations of mathematical situations using coding concepts and skills

Specific expectations

By the end of Grade 1, students will:

C3.1 Coding Skills

solve problems and create computational representations of mathematical situations by writing and executing code, including code that involves sequential events

Teacher supports

Key concepts

- In coding, a sequential set of instructions is executed in order.

Note

- Coding can support students in developing a deeper understanding of mathematical concepts.
- Coding can include a combination of pseudocode, block-based coding programs, and text-based coding programs.
- Students can program for various agents such as a pixelated image on a screen, a classmate acting out the code when appropriate, or a physical device (e.g., robot, microcontroller).

- Students can decompose large problems into smaller tasks and develop sequential steps to accomplish each sub-task.

C3.2 Coding Skills

read and alter existing code, including code that involves sequential events, and describe how changes to the code affect the outcomes

Teacher supports

Key concepts

- Changing the sequence of instructions in code may produce the same outcome as the original sequence, but it may also produce a different outcome. It is important for students to understand when the order matters.

Note

- Similarly, for some mathematical concepts, the sequence of instructions does not matter, as illustrated by the commutative property of addition (e.g., $6 + 3 = 3 + 6$). For other concepts, the order does matter; the commutative property does not work for subtraction (e.g., $6 - 3$ is not the same as $3 - 6$).
- Altering code can develop students' understanding of mathematical concepts. Altering code is also a way of manipulating and controlling the outcomes of the code.

C4. Mathematical Modelling

apply the process of mathematical modelling to represent, analyse, make predictions, and provide insight into real-life situations

This overall expectation has no specific expectations. Mathematical modelling is an iterative and interconnected process that is applied to various contexts, allowing students to bring in learning from other strands. Students' demonstration of the process of mathematical modelling, as they apply concepts and skills learned in other strands, is assessed and evaluated.

Read more about the [mathematical modelling process](#).

Teacher supports

Key concepts

- The process of mathematical modelling requires: understanding the problem; analysing the situation; creating a mathematical model; and analysing and assessing the model.

Note

- A mathematical modelling task is different from a real-life application due to the cyclic nature of modelling, which involves examining a problem from outside mathematics, modelling it, and then checking the model against the real-life situation and adjusting as necessary.
- The process of mathematical modelling should not be confused with using a "model" to represent or solve a problem that does not require the whole process.
- Mathematical modelling tasks can be utilized in many ways and can support students with making connections among many mathematical concepts across the math strands and across other curricula.

D. Data

Overall expectations

By the end of Grade 1, students will:

D1. Data Literacy

manage, analyse, and use data to make convincing arguments and informed decisions, in various contexts drawn from real life

Specific expectations

By the end of Grade 1, students will:

D1.1 Data Collection and Organization

sort sets of data about people or things according to one attribute, and describe rules used for sorting

Teacher supports

Key concepts

- Data can be sorted in more than one way, depending on the attribute.
- Data can be sorted into categories using attributes, and the categories can be used to create tables and graphs.

Note

- A variable is any attribute, number, or quantity that can be measured or counted.
- Early experiences in sorting and classifying supports students with understanding how data can be organized.

D1.2 Data Collection and Organization

collect data through observations, experiments, and interviews to answer questions of interest that focus on a single piece of information; record the data using methods of their choice; and organize the data in tally tables

Teacher supports

Key concepts

- Data can either be qualitative (descriptive, e.g., colour, type of pet) or quantitative (numerical, e.g., number of pets, height).
- The type and amount of data to be collected is based on the question of interest.
- Data can be collected through observations, experiments, interviews, or written questionnaires over a period of time.
- Tally tables can be used to organize data as it is collected. The data is recorded in groups of five tallies to make it easier to count.
- The distribution of data among the categories can change as more data is added.

Note

- In the primary grades, students should collect data from a small population (e.g., objects in a bin, the days in a month, students in Grade 1).

D1.3 Data Visualization

display sets of data, using one-to-one correspondence, in concrete graphs and pictographs with proper sources, titles, and labels

Teacher supports

Key concepts

- Different representations can be used to present data, depending on the type of data and the information to be highlighted.
- Both concrete graphs and pictographs allow for visual comparisons of quantities that are represented in the graphs.
- With one-to-one correspondence, there is one object for each piece of data in a concrete graph or one picture for each piece of data in a pictograph.
- The source, title, and labels provide important information about data in a graph or table:
 - The source indicates where the data was collected.
 - The title introduces the data contained in the graph or the table.
 - Labels provide additional information, such as the categories into which the data are sorted. On a pictograph, a key tells us how many each picture represents.

Note

- The source can be included in the title of a graph.
- The structure of a concrete graph can be transformed into a pictograph.

D1.4 Data Analysis

order categories of data from greatest to least frequency for various data sets displayed in tally tables, concrete graphs, and pictographs

Teacher supports

Key concepts

- The frequency of a category represents its count.
- The frequencies in a tally table should match the frequencies in graphs of the same information.

- The category with the greatest frequency has the greatest number of tallies in a tally table, the greatest number of objects in a concrete graph, and the greatest number of pictures in a pictograph.

Note

- Ordering the categories by frequencies will support students when they identify the mode in Grade 2.

D1.5 Data Analysis

analyse different sets of data presented in various ways, including in tally tables, concrete graphs, and pictographs, by asking and answering questions about the data and drawing conclusions, then make convincing arguments and informed decisions

Teacher supports

Key concepts

- Different representations are used for different purposes to convey different types of information. Tally tables, concrete graphs, and pictographs are used to represent counts or frequencies of various categories.
- Information in tally tables, concrete graphs, and pictographs can prompt the asking and answering of questions like, which category has the greatest frequency?
- Sometimes considering the frequency can support making informed decisions, such as what type of books should be ordered for the class library.
- Questions of interest are intended to be answered through the analysis of the representations. Sometimes the analysis raises more questions that require further collection, representation, and analysis of data.

Note

- There are three levels of graph comprehension that students should learn about and practise:
 - Level 1: information is read directly from the graph and no interpretation is required.
 - Level 2: information is read and used to compare (e.g., greatest, least) or perform operations (e.g., addition, subtraction).

- Level 3: information is read and used to make inferences about the data using background knowledge of the topic.
- Analysing data can be complex, so it is important to provide students with strategies that will support them to build these skills.

D2. Probability

describe the likelihood that events will happen, and use that information to make predictions

Specific expectations

By the end of Grade 1, students will:

D2.1 Probability

use mathematical language, including the terms “impossible”, “possible”, and “certain”, to describe the likelihood of events happening, and use that likelihood to make predictions and informed decisions

Teacher supports

Key concepts

- The likelihood of an event happening ranges from impossible to certain.
- Understanding likelihood can help with making predictions about future events and can influence the decisions people make in daily life.

Note

- The first stage of understanding the continuum is for students to be able to identify events that happen at the two ends and understand that the likelihood of other types of events falls somewhere in between.

D2.2 Probability

make and test predictions about the likelihood that the categories in a data set from one population will have the same frequencies in data collected from a different population of the same size

Teacher supports

Key concepts

- Data can vary from one population to another.
- Data can be used to make predictions that are not based on personal feelings or opinions alone.

Note

- In order to do an accurate comparison between data sets in Grade 1, it is important for students to collect data from a same-sized population (e.g., same number of objects in a bin, days in a month, students in Grade 1).

E. Spatial Sense

Overall expectations

By the end of Grade 1, students will:

E1. Geometric and Spatial Reasoning

describe and represent shape, location, and movement by applying geometric properties and spatial relationships in order to navigate the world around them

Specific expectations

By the end of Grade 1, students will:

E1.1 Geometric Reasoning

sort three-dimensional objects and two-dimensional shapes according to one attribute at a time, and identify the sorting rule being used

Teacher supports

Key concepts

- Geometric shapes exist in two dimensions (pictures or drawings) and in three dimensions (objects).

- Three-dimensional objects and two-dimensional shapes can be sorted by identifying and paying attention to similarities and ignoring differences.
- Shapes and objects have more than one, and often many, attributes, so they can be sorted in more than one way. Sorting rules indicate which attribute to sort for and are used to determine what belongs and what does not belong in a group.
- Attributes are characteristics or features of an object or shape (e.g., length, area, colour, texture, ability to roll). Attributes can be used to describe, compare, sort, and measure.
- Geometric properties are specific attributes that are the same for an entire “class” of shapes or objects. So, for example, a group of shapes might all be red (attribute), but in order for them all to be squares, they must have four equal sides and four right angles (the geometric properties of a square). Geometric properties are used to identify two-dimensional shapes and three-dimensional objects.

Note

- Sorting by attributes is used in counting, measurement, and geometry. When a student counts “this” and not “that”, they have sorted; when they measure length, they focus on one attribute and not another; when they say that this shape is a triangle and not a square, their sorting has led them to identify the shape.

E1.2 Geometric Reasoning

construct three-dimensional objects, and identify two-dimensional shapes contained within structures and objects

Teacher supports

Key concepts

- Each face of a three-dimensional object is a two-dimensional shape. Often, a shape is identified by the number of sides it has. Common shapes on faces of three-dimensional objects are triangles, rectangles, pentagons, hexagons, and octagons.
- While the number of sides often determines a shape’s name, this does not mean, for example, that all triangles look the same even though they all have three sides. Triangles can be oriented differently and have different side lengths, and yet still be triangles.

Note

- Constructing three-dimensional objects helps build understanding of attributes and properties of two-dimensional shapes and three-dimensional objects.

E1.3 Geometric Reasoning

construct and describe two-dimensional shapes and three-dimensional objects that have matching halves

Teacher supports

Key concepts

- If two shapes or objects match in every way, they are congruent. Shapes with matching halves have congruent halves.
- Congruent halves can be superimposed onto one another through a series of slides (translations), flips (reflections), or turns (rotations). This means that congruent halves are also symmetrical.
- Both three-dimensional objects and two-dimensional shapes can have matching, congruent, symmetrical halves.

E1.4 Location and Movement

describe the relative locations of objects or people, using positional language

Teacher supports

Key concepts

- Positional language often includes direction and distance to describe the location of one object in relation to another.
- Words and phrases such as *above*, *below*, *to the left*, *to the right*, *behind*, and *in front* describe the position of one object in relation to another. Numbers can describe the distance of one object from another.

E1.5 Location and Movement

give and follow directions for moving from one location to another

Teacher supports

Key concepts

- Movement encompasses distance and direction.
- Words or phrases such as *above*, *below*, *to the left*, *to the right*, *behind*, or *in front of* describe the direction of one object in relation to another. Numbers can describe the distance of one object from another.
- A combination of words and numbers can describe a path to move from one location to another. The order of the steps taken on this path is often important.

E2. Measurement

compare, estimate, and determine measurements in various contexts

Specific expectations

By the end of Grade 1, students will:

E2.1 Attributes

identify measurable attributes of two-dimensional shapes and three-dimensional objects, including length, area, mass, capacity, and angle

Teacher supports

Key concepts

- Every shape or object has several attributes that can be compared. The same shape or object can be described and compared using different attributes.
- There are particular words that describe commonly measured attributes:
 - length is the distance from one point to the other and can be measured in any direction;
 - area is the amount of surface an object has;
 - mass is how heavy an object is;
 - capacity is the amount an object holds;
 - angle is the amount of turn between one line and another.

E2.2 Attributes

compare several everyday objects and order them according to length, area, mass, and capacity

Teacher supports

Key concepts

- Objects can be compared and ordered according to whether they have more or less of an attribute. Comparing the same objects by different attributes may produce different ordering.
- There are specific words and phrases that help describe and compare attributes:
 - *more, less, smaller, and bigger* often only *describe* general comparisons unless a specific attribute is included (bigger area; smaller capacity);
 - *tall, short, wide, narrow, long, and distance* are all associated with length;
 - adding the suffix “-er” or “-est” typically creates a comparative term (e.g., heavier, lighter, heaviest, lightest).
- Objects can be directly compared by matching, covering, or filling one object with the other to determine which has more length, mass, area, or capacity.
- When a direct comparison cannot be easily made, a third object can serve as a “go-between” tool to make an indirect comparison. For example, a string can be used to compare the lengths of two objects that are not easily brought together, or a third container can be used to determine which of two containers holds more water. Indirect comparisons require using the transitivity principle and the conservation principle.

E2.3 Time

read the date on a calendar, and use a calendar to identify days, weeks, months, holidays, and seasons

Teacher supports

Key concepts

- Time is an abstract concept that cannot be seen or felt. The passing of time can be measured by counting things that repeat. The passing of a day, for example, is marked by the rising and setting of the sun.
- Calendars keep track of days, weeks, months, and years, as well as holidays and seasons.

- There are other kinds of calendars, such as lunar, solar, agricultural, ecological, and personal calendars, that keep track of personal, social, and religious events.
- Calendars enable people to communicate a date to others.

F. Financial Literacy

Overall expectations

By the end of Grade 1, students will:

F1. Money and Finances

demonstrate an understanding of the value of Canadian currency

Specific expectations

By the end of Grade 1, students will:

F1.1 Money Concepts

identify the various Canadian coins up to 50¢ and coins and bills up to \$50, and compare their values

Teacher supports

Key concepts

- Canadian coins and bills differ from one another in value and appearance (e.g., size, shape, colour, image, and/or texture).
- Identifying the correspondence between the abstract concept of value and the concrete representation of coins and bills.

Note

- The value of money can be an abstract concept because it is often represented by currency that is not concrete or accessible.
- Being able to identify Canadian currency by size, shape, colour, image, and/or texture allows for quick recognition of different denominations.
- An understanding of unitizing is applied to identify the relationships between coins and their corresponding values.

Mathematics, Grade 2

Expectations by strand

A. Social-Emotional Learning (SEL) Skills in Mathematics and the Mathematical Processes

This strand focuses on students' development and application of social-emotional learning skills to support their learning of math concepts and skills, foster their overall well-being and ability to learn, and help them build resilience and thrive as math learners. As they develop SEL skills, students demonstrate a greater ability to understand and apply the mathematical processes, which are critical to supporting learning in mathematics. In all grades of the mathematics program, the learning related to this strand takes place in the context of learning related to all other strands, and it should be assessed and evaluated within these contexts.

Overall expectations

Throughout this grade, in order to promote a positive identity as a math learner, to foster well-being and the ability to learn, build resilience, and thrive, students will:

A1. Social-Emotional Learning (SEL) Skills and the Mathematical Processes

apply, to the best of their ability, a variety of social-emotional learning skills to support their use of the mathematical processes and their learning in connection with the expectations in the other five strands of the mathematics curriculum

To the best of their ability, students will learn to:	... as they apply the mathematical processes :	... so they can:
1. identify and manage emotions	<ul style="list-style-type: none"> • problem solving: develop, select, and apply problem-solving strategies • reasoning and proving: develop and apply reasoning skills (e.g., classification, recognition of relationships, use of counter-examples) to justify thinking, make and investigate conjectures, and construct and defend arguments 	1. express and manage their feelings, and show understanding of the feelings of others, as they engage positively in mathematics activities
2. recognize sources of stress and cope with challenges	<ul style="list-style-type: none"> • reflecting: demonstrate that as they solve problems, they are pausing, looking back, and monitoring their thinking to help clarify their understanding (e.g., by comparing and adjusting strategies used, by explaining why they think their results are reasonable, by recording their thinking in a math journal) 	2. work through challenging math problems, understanding that their resourcefulness in using various strategies to respond to stress is helping them build personal resilience
3. maintain positive motivation and perseverance	<ul style="list-style-type: none"> • connecting: make connections among mathematical concepts, procedures, and representations, and relate mathematical ideas to other contexts (e.g., other curriculum areas, daily life, sports) 	3. recognize that testing out different approaches to problems and learning from mistakes is an important part of the learning process, and is aided by a sense of optimism and hope
4. build relationships and communicate effectively	<ul style="list-style-type: none"> • communicating: express and understand mathematical thinking, and engage in mathematical arguments using everyday language, language resources as necessary, appropriate mathematical terminology, a variety of representations, and mathematical conventions 	4. work collaboratively on math problems – expressing their thinking, listening to the thinking of others, and practising inclusivity – and in that way fostering healthy relationships
5. develop self-awareness and sense of identity	<ul style="list-style-type: none"> • representing: select from and create a variety of representations of mathematical ideas (e.g., 	5. see themselves as capable math learners, and strengthen their sense of ownership of their learning, as part of their emerging sense of identity and belonging

6. think critically and creatively	representations involving physical models, pictures, numbers, variables, graphs), and apply them to solve problems <ul style="list-style-type: none"> • selecting tools and strategies: select and use a variety of concrete, visual, and electronic learning tools and appropriate strategies to investigate mathematical ideas and to solve problems 	6. make connections between math and everyday contexts to help them make informed judgements and decisions
------------------------------------	--	--

B. Number

Overall expectations

By the end of Grade 2, students will:

B1. Number Sense

demonstrate an understanding of numbers and make connections to the way numbers are used in everyday life

Specific expectations

By the end of Grade 2, students will:

B1.1 Whole Numbers

read, represent, compose, and decompose whole numbers up to and including 200, using a variety of tools and strategies, and describe various ways they are used in everyday life

Teacher supports

Key concepts

- Reading numbers involves interpreting them as a quantity when they are expressed in words, in standard notation, or represented using physical objects or diagrams.
- The numerals 0 to 9 are used to form numbers. They are referred to as the digits in a number and each digit corresponds to a place value. For example, in the number 107, the digit 1 represents 1 hundred, the digit 0 represents 0 tens, and the digit 7 represents 7 ones.

- There are patterns in the way numbers are formed. Each decade repeats the 0 to 9 counting sequence. Any quantity, no matter how great, can be described in terms of its place-value.
- A number can be represented in expanded form (e.g., $187 = 100 + 80 + 7$ or $1 \times 100 + 8 \times 10 + 7 \times 1$) to show place-value relationships.
- Numbers can be composed and decomposed in various ways, including by place value.
- Numbers are composed when two or more numbers are combined to create a larger number. For example, 30, 20, and 5 are composed to make 55.
- Numbers are decomposed when they are represented as a composition of two or more smaller numbers. For example, 125 can be represented as 100 and 25; or 50, 50, 20, and 5.
- Numbers are used throughout the day, in various ways and contexts. Most often numbers describe and compare quantities. They express magnitude and provide a way to answer questions such as “how much?” and “how much more?”.

Note

- Every strand in the mathematics curriculum relies on numbers.
- Numbers may have cultural significance.
- When a number is decomposed and then recomposed, the quantity is unchanged. This is the conservation principle.
- There are non-standard but equivalent ways to decompose a number using place value, based on understanding the relationships between the place values. For example, 187 could be decomposed as 18 tens and 7 ones or decomposed as 10 tens and 87 ones, and so on.
- Composing and decomposing numbers in a variety of ways can support students in becoming flexible with mental math strategies for addition and subtraction.
- Certain tools are helpful for showing the composition and decomposition of numbers. For example:
 - Ten frames can show how numbers compose to make 10 or decompose into groups of 10.
 - Rekenreks can show how numbers are composed using groups of 5s and 10s or decomposed into 5s and 10s.
 - Coins and bills can show how numbers are composed and decomposed according to their values.
 - Number lines can be used to show how numbers are composed or decomposed using different combinations of “jumps”.

- Breaking down numbers and quantities into smaller parts (decomposing) and reassembling them in new ways (composing) highlights relationships between numbers and builds strong number sense.
- Composing and decomposing numbers is also useful when doing a calculation or making a comparison.
- As students build quantities to 200 concretely, they should use both written words and numerals to describe the quantity so that they can make connections among the representations.

B1.2 Whole Numbers

compare and order whole numbers up to and including 200, in various contexts

Teacher supports

Key concepts

- Numbers are compared and ordered according to their “how muchness” or magnitude.
- Numbers with the same units can be compared directly (e.g., 145 minutes compared to 62 minutes). Numbers that do not show a unit are assumed to have units of ones (e.g., 75 and 12 are considered as 75 ones and 12 ones).
- Benchmark numbers can be used to compare quantities. For example, 32 is less than 50 and 62 is greater than 50, so 32 is less than 62.
- Numbers can be compared by their place value. For example, 200 is greater than 20 because the digit 2 in 200 represents 2 hundreds and the 2 in 20 represents 2 tens; one hundred is greater than one ten.
- Numbers can be ordered in ascending order – from least to greatest – or they can be ordered in descending order – from greatest to least.

Note

- Moving between concrete (counting objects and sets) and abstract (symbolic and place value) representations of a quantity builds intuition and understanding of numbers.
- Understanding place value enables any number to be compared and ordered. There is a stable order to how numbers are sequenced, and patterns exist within this sequence that make it possible to predict the order and make comparisons.
- The sequence from 1 to 19 has fewer patterns than sequences involving greater numbers and so requires a lot of practice to consolidate.

- The decades that follow the teens pick up on the 1 to 9 pattern to describe the number of tens in a number. This pattern is not always overt in English. For example, 30 means “three tens”, but this connection may not be noticed by only hearing the word “thirty”.
- Within each decade, the 1 to 9 sequence is repeated. After 9 comes the next decade. After 9 decades comes the next hundred.
- The 1 to 9 sequence names each hundred. Within each hundred, the decade sequence and the 1 to 99 sequences are repeated.
- Number lines and hundreds charts model the sequence of numbers and can be used to uncover patterns.

B1.3 Whole Numbers

estimate the number of objects in collections of up to 200 and verify their estimates by counting

Teacher supports

Key concepts

- Estimation is used to approximate large quantities and develops a sense of magnitude.
- Different strategies can be used to estimate the quantity in a collection. For example, a small portion of the collection can be counted, and then used to visually skip count the rest of the collection.
- The greater the number of objects in the skip count, the fewer the number of counts are needed.
- Although there are different ways to count a collection (see **SE B1.4**), if the count is carried out correctly, the count will always be the same.

Note

- Estimation strategies often build on “unitizing” an amount (e.g., “I know this amount is 10”) and visually repeating the unit (e.g., by skip counting by 10s) until the whole is filled or matched. Unitizing is an important building block for place value, multiplication, measurement, and proportional reasoning.

B1.4 Whole Numbers

count to 200, including by 20s, 25s, and 50s, using a variety of tools and strategies

Teacher supports

Key concepts

- The count of objects does not change, regardless of how the objects are arranged (e.g., close together or far apart).
- Counting usually has a purpose, such as determining how many are in a collection, how long before something will happen, or to compare quantities and amounts.
- Counting objects may involve counting an entire collection or counting the quantity of objects that satisfy certain attributes.
- A count can start from zero or from any other starting number.
- The unit of skip count is identified as the number of objects in a group. For example, when counting by twos, each group has two objects.
- Counting can involve a combination of skip counts and single counts.

Note

- Each object in a collection must be touched or included in the count only once and matched to the number being said (one-to-one-correspondence).
- The numbers in the counting sequence must be said once, and always in the standard order (stable order).
- The number of objects must remain the same, regardless of how they are arranged, whether they are close together or spread far apart (conservation principle).
- The objects can be counted in any order, and the starting point does not affect how many there are (order irrelevance).
- The last number said during a count describes how many there are in the whole collection. It does not describe only the last object (cardinality).
- When all objects are not accounted for by using a skip count then the remaining objects are counted on either individually or by another type of skip count. For example, when counting a collection of 137 objects by 5s, the 2 left is counted on either by 1s or by 2s.
- Counting by ones up to and over 100 reinforces the concept that the 0 to 9 and decade sequence that appeared in the first hundred repeats in every hundred.
- Skip counting is an efficient way to count collections, and it also helps build basic facts and mental math strategies and establishes a strong foundation for multiplication and division.

B1.5 Whole Numbers

describe what makes a number even or odd

Teacher supports

Key concepts

- A whole number is even if it can be shared into two equal-sized groups or many groups of 2 without a remainder.
- A whole number is odd if it cannot be shared into two equal-sized groups or into many groups of 2 without a remainder.

Note

- There are patterns in the number system that can be used to identify a whole number as even or odd. For example, if a whole number with more than one digit ends in an even number, it is even.

B1.6 Fractions

use drawings to represent, solve, and compare the results of fair-share problems that involve sharing up to 10 items among 2, 3, 4, and 6 sharers, including problems that result in whole numbers, mixed numbers, and fractional amounts

Teacher supports

Key concepts

- Fair-sharing or equal-sharing means that quantities are shared equally. For a whole to be shared equally, it must be partitioned so that each sharer receives the same amount.

Note

- Words can have multiple meanings. It is important to be aware that in many situations, fair does not mean equal, and equal is not equitable. Educators should clarify how they are using the term “fair share” and ensure that students understand that in the math context fair means equal and the intent behind such math problems is to find equal amounts.
- Fair-share or equal-share problems provide a natural context for students to encounter fractions and division. Present these problems in the way that students will best connect to.
- Whole numbers and fractions are used to describe fair-share or equal-share amounts. For example, 4 pieces of ribbon shared between 3 people means that each person receives 1 whole ribbon and 1 one third of another ribbon.

- When assigning these types of problems, start with scenarios where there is a remainder of 1. As students become adept at solving these problems, introduce scenarios where there is a remainder of 2 that needs to be shared equally.
- Fractions have specific names. In Grade 2, students should be using the terminology of “halves”, “fourths”, and “thirds”.

B1.7 Fractions

recognize that one third and two sixths of the same whole are equal, in fair-sharing contexts

Teacher supports

Key concepts

- When something is shared fairly, or equally as three pieces, each piece is $1 \frac{1}{3}$ of the original amount. Three one thirds make up a whole.
- When something is shared fairly, or equally as six pieces, each piece is $1 \frac{1}{6}$ of the original amount. Six one sixths make up a whole.
- If the original amount is shared as three pieces or six pieces, the fractions $1 \frac{1}{3}$ and $2 \frac{1}{6}$ (two sixths) are equivalent, and $2 \frac{1}{3}$ (two thirds) and $4 \frac{1}{6}$ (four sixths) are equivalent.

Note

- Words can have multiple meanings. It is important to be aware that in many situations, fair does not mean equal, and equal is not equitable. Educators should clarify how they are using the term “fair share” and ensure that students understand that in the math context fair means equal and the intent behind such math problems is to find equal amounts.
- Different fractions can describe the same amount as long as they are based on the same whole.
- Fair-share problems involving six sharers that result in remainders (see **SE B1.6**) provide a natural opportunity to recognize that $1 \frac{1}{3}$ and $2 \frac{1}{6}$ (two sixths) are equal.

B2. Operations

use knowledge of numbers and operations to solve mathematical problems encountered in everyday life

Specific expectations

By the end of Grade 2, students will:

B2.1 Properties and Relationships

use the properties of addition and subtraction, and the relationships between addition and multiplication and between subtraction and division, to solve problems and check calculations

Teacher supports

Key concepts

- When zero is added or subtracted from a quantity, the quantity does not change.
- Two numbers can be added in any order because either order gives the same result.
- When adding more than two numbers, it does not matter which two numbers are added first.
- Addition and subtraction are inverse operations, and the same situation can be represented and solved using either operation. Addition can be used to check the answer to a subtraction question, and subtraction can be used to check the answer to an addition question.
- Repeated addition can be used as a multiplication strategy by adding equal groups of objects to determine the total number of objects.
- Repeated addition can also be used as a division strategy by adding equal groups of objects to reach a given total number of objects.
- Repeated subtraction can be used as a division strategy by removing equal groups of objects from a given total number of objects.
- Repeated addition or repeated subtraction can be used to check answers for multiplication and division calculations when they are not used as the initial strategy to do the multiplication or division calculation.
- The commutative property for addition states that the order in which two numbers are added does not change the total. For example, $5 + 3$ is the same as $3 + 5$, because 3 can be added onto 5 or 5 can be added onto 3; either way the result is 8. This is particularly helpful when learning math facts (see **SE B2.2**).
- The commutative property does not hold true for subtraction. For example, $5 - 4 = 1$; however, it is not the same as $4 - 5 = -1$. Students in Grade 2 do not need to know that $4 - 5 = -1$, only that it has a result that is less than zero. To help students grasp this concept, show them how the scale on a thermometer includes numbers less than zero.
- The associative property states that when adding a group of numbers, the pair of numbers added first does not matter; the result will be the same. For example, in determining the sum of $8 + 7 + 2$, 8 and 2 can be added first and then that result can be

added to 7. Using this property is particularly helpful when doing mental math (see **SE B2.3**) and when looking for ways to “make 10” is useful.

Note

- This expectation supports most other expectations in the Number strand and is applied throughout the grade. Whether working with numbers or with operations, recognizing and applying properties and relationships builds a strong foundation for doing mathematics.
- Students need to develop an understanding of the commutative, identity, and associative properties, but they do not need to name them in Grade 2. These properties help to develop automaticity with addition and subtraction facts.
- Support students in making connections between skip counts and repeat addition.

B2.2 Math Facts

recall and demonstrate addition facts for numbers up to 20, and related subtraction facts

Teacher supports

Key concepts

- The focus in Grade 1 math facts was on recalling and demonstrating addition facts for numbers up to 10, and related subtraction facts. In Grade 2, students will expand their range to include numbers that add up to 20, e.g., $9 + 9 = 18$ and related subtraction facts, e.g., $18 - 9 = 9$.
- There are many strategies that can help with developing and understanding math facts:
 - Working with fact families, such as $7 + 6 = 13$; $6 + 7 = 13$; $13 - 7 = 6$; $13 - 6 = 7$.
 - Using doubles with counting on and counting back; for example, $7 + 9$ can be thought of as $7 + 7$ plus 2 more; 15 can be thought of as 16 less 1 (double 8 less one).
 - Using the commutative property (e.g., $5 + 8 = 13$ and $8 + 5 = 13$).
 - Using the identity property (e.g., $6 + 0 = 6$ and $6 - 0 = 6$).
 - "Making 10" by decomposing numbers in order to make 10. For example, to add 8 and 7, the 7 can be decomposed as 2 and 5, resulting in $8 + 2 + 5$.

Note

- Ten is an important anchor for learning basic facts and mental math computations.

- Addition and subtraction are inverse operations. This means that addition facts can be used to understand and recall subtraction facts (e.g., $5 + 3 = 8$, so $8 - 5 = 3$ and $8 - 3 = 5$).
- Having automatic recall of addition and subtraction facts is important when carrying out mental or written calculations, and frees up working memory to do complex calculations, problems, and tasks.

B2.3 Mental Math

use mental math strategies, including estimation, to add and subtract whole numbers that add up to no more than 50, and explain the strategies used

Teacher supports

Key concepts

- Mental math refers to doing a calculation in one's head. Sometimes the numbers or the number of steps in a calculation are too complex to completely hold in one's head, so jotting down partial calculations and diagrams can be used to complete the calculations.
- Mental math involves using flexible strategies that build on basic facts, number relationships, and counting strategies. These strategies continue to expand and develop through the grades.
- Number lines, circular number lines, and part-whole models can be used to show strategies for doing the calculations.
- Estimation is a useful mental strategy when either an exact answer is not needed or there is insufficient time to work out a solution.

Note

- Strategies for doing mental calculations will vary depending on the numbers, facts, and properties that are used. For example:
 - For $18 + 2$, simply count on.
 - For $26 + 13$, decompose 13 into 10 and 3, add 10 to 26, and then add on 3 more.
 - For $39 + 9$, add 10 to 39 and then subtract the extra 1.
- Mental math may or may not be quicker than paper-and-pencil strategies, but speed is not the goal. The value of mental math is in its portability and flexibility, since it does not require a calculator or paper and pencil. Practising mental math strategies also deepens an understanding of the relationships between numbers.

- Estimation can be used to check the reasonableness of calculations and should be continually encouraged when students are doing mathematics.

B2.4 Addition and Subtraction

use objects, diagrams, and equations to represent, describe, and solve situations involving addition and subtraction of whole numbers that add up to no more than 100

Teacher supports

Key concepts

- Situations involving addition and subtraction may involve:
 - adding a quantity onto an existing amount or removing a quantity from an existing amount;
 - combining two or more quantities;
 - comparing quantities.
- Acting out a situation by representing it with objects, a drawing, or a diagram can support students in identifying the given quantities in a problem and the unknown quantity.
- Set models can be used to represent adding a quantity to an existing amount or removing a quantity from an existing amount.
- Linear models can be used to determine the difference between two numbers by comparing two quantities.
- Part-whole models can be used to show the relationship between what is known and what is unknown and how addition and subtraction relate to the situation.

Note

- An important part of problem solving is the ability to choose the operation that matches the action in a situation. Addition and subtraction are useful for showing:
 - when a quantity *changes*, either by *joining* another quantity to it or *separating* a quantity from it;
 - when two quantities (parts) are *combined* to make one whole quantity;
 - when two quantities are *compared*.
- In addition and subtraction situations, what is unknown can vary:

- In *change* situations, sometimes the result is unknown, sometimes the starting point is unknown, and sometimes the change is unknown.
 - In *combine* situations, sometimes one part is unknown, sometimes the other part is unknown, and sometimes the total is unknown.
 - In *compare* situations, sometimes the larger number is unknown, sometimes the smaller number is unknown, and sometimes the difference is unknown.
- In order to reinforce the meaning of addition and subtraction, it is important to model the correct equation by matching its structure to the situation and placing the unknown correctly; for example, $8 + ? = 19$, or $? + 11 = 19$, or $8 + 11 = ?$.
 - Sometimes changing a “non-standard” equation (where the unknown is not after the equal sign) into its “standard form” can make it easier to carry out the calculation.
 - Part-whole models make the inverse relationship between addition and subtraction evident and support students in developing a flexible understanding of the equal sign. These are important ideas in the development of algebraic reasoning.

B2.5 Multiplication and Division

represent multiplication as repeated equal groups, including groups of one half and one fourth, and solve related problems, using various tools and drawings

Teacher supports

Key concepts

- Multiplication can describe situations involving repeated groups of equal size.
- Multiplication names the unknown *total* when the *number of groups* and the *size of the groups* are known.

Note

- Multiplication as repeated equal groups is one meaning of multiplication. In later grades, other meanings that students will learn include scaling, combinations, and measures, all of which require a major shift in thinking from addition.
- With addition and subtraction, each number represents distinct and visible objects that can be counted. For example, $7 + 3$ can be represented by combining 7 blocks and 3 blocks. However, with multiplication involving repeated equal groups, one number refers to the number of objects in a group, and the other number refers to the number of

groups or number of counts of a group. For example, 7×2 can be interpreted as *7 groups of 2 blocks* or a *group of 7 blocks, 2 times*.

- Multiplication requires a “double count”. One count keeps track of the number of equal groups. The other count keeps track of the total number of objects. Double counting is evident when people use fingers to keep track of the number of groups as they skip count towards a total.

B2.6 Multiplication and Division

represent division of up to 12 items as the equal sharing of a quantity, and solve related problems, using various tools and drawings

Teacher supports

Key concepts

- Division, like multiplication, can describe situations involving repeated groups of equal size.
- While multiplication names the unknown *total* when the *number of groups* and the *size of the groups* are known, division names *either* the unknown number of groups *or* the unknown size of the groups when the *total* is known.

Note

- The inverse relationship between multiplication and division means that any situation involving repeated equal groups can be represented with either multiplication or division. While this idea will be formalized in Grade 3 (see **SE B2.1**), it is helpful to notice this relationship in Grade 2 as well.
- While it may be important for students to develop an understanding of these operations separately at first, it is also important for students to observe both multiplication and division situations together, to recognize similarities and differences.
- There are two different types of division problems.
 - Equal-sharing division (also called “partitive division”):
 - *What is known*: the total and number of groups.
 - *What is unknown*: the size of the groups.
 - *The action*: a total is shared equally among a given number of groups. Equal-sharing division is also being used to develop an understanding of fractions in **SEs B1.6** and **B1.7**.

- Equal-grouping division (also called “measurement division” or “quotative division”):
 - *What is known*: the *total* and the *size* of groups.
 - *What is unknown*: the number of groups.
 - *The action*: from a total, equal groups of a given size are measured out. (Students often use repeated addition or subtraction to represent this action.)
- Equal-group situations can be represented with objects, number lines, or drawings, and often the model alone can be used to solve the problem. It is important to model the corresponding equation (addition or subtraction and division) for different situations and to make connections between the actions in a situation, the strategy used to solve it, and the operations themselves.
- Although the number sentences representing both division situations might be the same, the action suggested and the drawing used to represent each of them would be very different. It is important to provide students with experiences representing both types of division situations.

C. Algebra

Overall expectations

By the end of Grade 2, students will:

C1. Patterns and Relationships

identify, describe, extend, create, and make predictions about a variety of patterns, including those found in real-life contexts

Specific expectations

By the end of Grade 2, students will:

C1.1 Patterns

identify and describe a variety of patterns involving geometric designs, including patterns found in real-life contexts

Teacher supports

Key concepts

- Human activities, histories, and the natural world are made up of all kinds of patterns and many of them are based on geometric designs.
- Patterns may involve attributes such as colour, shape, texture, thickness, orientation, or material.

Note

- Students can engage in mathematics and patterns through the contexts, cultural histories, and stories of various cultures.
- Patterns do not need to be classified as repeating or otherwise in Grade 2. Instead, focus on the geometric design – are shapes being repeated? Do shapes appear to grow? Do shapes appear to shrink?

C1.2 Patterns

create and translate patterns using various representations, including shapes and numbers

Teacher supports

Key concepts

- The same pattern structure can be represented in various ways.
- Patterns can be created by varying a single attribute, or more than one.
- Pattern structures can be generalized.

Note

- Comparing translated patterns highlights the equivalence of their underlying mathematical structure, even though the representations differ.

C1.3 Patterns

determine pattern rules and use them to extend patterns, make and justify predictions, and identify missing elements in patterns represented with shapes and numbers

Teacher supports

Key concepts

- Patterns can be extended because they are repetitive by nature.
- Pattern rules are generalizations about a pattern, and they can be described in words.
- Patterns can be extended in multiple directions, such as up, down, right, and left.
- To make a near prediction about a pattern is to state or show what a pattern will look like just beyond the given representation of that pattern. The prediction can be verified by extending the pattern.
- To make a far prediction about a pattern is to state or show what a pattern will look like well beyond the given representation of that pattern. Often calculations are needed to make an informed prediction or to verify a prediction.
- To identify missing elements of patterns is to complete a representation for a given pattern by filling in the missing parts.

Note

- In order to extend, predict, or determine missing elements, students need to generalize patterns, using pattern rules.
- Rules should be used to verify predictions and to critically analyse extensions and solutions for missing elements.

C1.4 Patterns

create and describe patterns to illustrate relationships among whole numbers up to 100

Teacher supports

Key concepts

- Patterns exist in increasing and decreasing numbers based on place value.

Note

- Creating and analysing patterns that involve decomposing numbers will support students in understanding how numbers are related.
- Creating and analysing patterns involving addition and subtraction facts can help students develop fluency with math facts, as well as understand how to maintain equality among expressions.

C2. Equations and Inequalities

demonstrate an understanding of variables, expressions, equalities, and inequalities, and apply this understanding in various contexts

Specific expectations

By the end of Grade 2, students will:

C2.1 Variables

identify when symbols are being used as variables, and describe how they are being used

Teacher supports

Key concepts

- Symbols can be used to represent quantities that change or quantities that are unknown.
- Quantities that can change are also referred to as “variables”.
- Quantities that remain the same are also referred to as “constants”.

Note

- Identifying quantities in real life that stay the same and those that can change will help students understand the concept of variability.
- Identifying what is constant and what changes is one aspect of mathematical modelling.
- When students find different addends for a sum no more than 100, they are implicitly working with variables. These terms are variables that can change (e.g., in coding, a student’s code could be $\text{TotalSteps} = \text{FirstSteps} + \text{SecondSteps}$).
- In mathematics notation, variables are only expressed as letters or symbols. When coding, variables may be represented as words, abbreviated words, symbols, or letters.
- Students are also implicitly working with variables as they are working with attributes (e.g., length, mass, colour, number of buttons), as the value of those attributes can vary.

C2.2 Equalities and Inequalities

determine what needs to be added to or subtracted from addition and subtraction expressions to make them equivalent

Teacher supports

Key concepts

- Numerical expressions are equivalent when they produce the same result, and an equal sign is a symbol denoting that the two expressions are equivalent.
- Numerical expressions are not equivalent when they do not produce the same result, and an equal sign with a slash through it (\neq) is a symbol denoting that the two expressions are not equivalent.

Note

- When using a balance model, the representations of the addition or subtraction expressions are manipulated until there is an identical representation on both sides of the balance.
- When using a balance scale, the objects on the scale are manipulated until the scale is level.

C2.3 Equalities and Inequalities

identify and use equivalent relationships for whole numbers up to 100, in various contexts

Teacher supports

Key concepts

- When numbers are decomposed, the sum of the parts is equivalent to the whole.
- The same whole can result from different parts.

Note

- Many mathematical concepts are based on an underlying principle of equivalency.
- The commutative and associate properties of addition are founded on equivalency.

C3. Coding

solve problems and create computational representations of mathematical situations using coding concepts and skills

Specific expectations

By the end of Grade 2, students will:

C3.1 Coding Skills

solve problems and create computational representations of mathematical situations by writing and executing code, including code that involves sequential and concurrent events

Teacher supports

Key concepts

- In coding, a sequential set of instructions is executed based on the order of instructions given (e.g., a pixelated image stops its motion and then changes colours).
- Concurrent events are when multiple things are occurring at the same time (e.g., a pixelated image is changing its colours while moving).
- Sometimes concurrent programs need to use time delays or wait blocks. For example, to ensure that two pixelated images do not collide on the screen, or, similarly that robots do not collide in real life, one may need to pause while the other passes.
- Some sequential events can be executed concurrently if they are independent of each other (e.g., two pixelated images are moving across the screen at the same time).

Note

- Coding can support the development of a deeper understanding of mathematical concepts.
- Coding can provide an opportunity for students to communicate their understanding of mathematical concepts.
- Coding can include a combination of pseudocode, block-based coding programs, and text-based coding programs.
- Students can program for various agents, such as a pixelated image on a screen, a classmate acting out the code when appropriate, or a physical device (e.g., robot, microcontroller).

C3.2 Coding Skills

read and alter existing code, including code that involves sequential and concurrent events, and describe how changes to the code affect the outcomes

Teacher supports

Key concepts

- Code can be altered to develop students' understanding of mathematical concepts, and to ensure that the code is generating the expected outcome.
- Changing the sequence of instructions in code can sometimes produce the same outcome and can sometimes produce a different outcome.
- Predicting the outcome of code allows students to visualize the movement of an object in space or imagine the output of specific lines of code. This is a valuable skill when debugging and problem solving.
- When predicting the outcomes of programs involving time delays or wait blocks, it is important to confirm that the action is actually possible; for example, one agent pauses to allow another agent to pass when both are trying to occupy the same location at the same time.

Note

- It is important for students to understand when order matters.
- Some mathematical concepts are founded on the idea that the sequence of instructions does not matter; for example, the commutative and associative properties of addition. The order for subtraction, however, does affect the result.

C4. Mathematical Modelling

apply the process of mathematical modelling to represent, analyse, make predictions, and provide insight into real-life situations

This overall expectation has no specific expectations. Mathematical modelling is an iterative and interconnected process that is applied to various contexts, allowing students to bring in learning from other strands. Students' demonstration of the process of mathematical modelling, as they apply concepts and skills learned in other strands, is assessed and evaluated.

Read more about the [mathematical modelling process](#).

Teacher supports

Key concepts

- The process of mathematical modelling requires: understanding the problem; analysing the situation; creating a mathematical model; and analysing and assessing the model.

Note

- A mathematical modelling task is different from a real-life application due to the cyclic nature of modelling, which involves examining a problem from outside mathematics, modelling it, and then checking the model against the real-life situation and adjusting as necessary.
- The process of mathematical modelling should not be confused with using a "model" to represent or solve a problem that does not require the whole process.
- Mathematical modelling tasks can be utilized in many ways and can support students with making connections among many mathematical concepts across the math strands and across other curricula.

D. Data

Overall expectations

By the end of Grade 2, students will:

D1. Data Literacy

manage, analyse, and use data to make convincing arguments and informed decisions, in various contexts drawn from real life

Specific expectations

By the end of Grade 2, students will:

D1.1 Data Collection and Organization

sort sets of data about people or things according to two attributes, using tables and logic diagrams, including Venn and Carroll diagrams

Teacher supports

Key concepts

- Data can be sorted in more than one way. For example, the same set of data can be sorted in a Venn diagram, a Carroll diagram, and a two-way table.
- Different sorting tools can be used for different purposes.

- A two-circle Venn diagram can be used to sort data based on two characteristics (e.g., red and large) of two attributes (e.g., colour and size).
- A Carroll diagram can be used to sort data into complementary sets for two characteristics (e.g., red – not red, large – not large) of two attributes (e.g., colour and size).
- A two-way table can be used to sort data into all the possible combinations of the characteristics of two attributes.

Note

- A variable is any attribute, number, or quantity that can be measured or counted.

D1.2 Data Collection and Organization

collect data through observations, experiments, and interviews to answer questions of interest that focus on two pieces of information, and organize the data in two-way tally tables

Teacher supports

Key concepts

- The type and amount of data to be collected is based on the question of interest.
- Data can either be qualitative (e.g., colour, type of pet) or quantitative (e.g., number of pets, height).
- Data can be collected through observations, experiments, interviews, or written questionnaires over a period of time.
- A two-way tally table can be used to collect and organize data involving two attributes. The data is recorded in groups of 5 tallies to make it easier to count.

Note

- In the primary grades, students are collecting data from a small population (e.g., same number of objects in a bin, days in a month, students in the Grade 2 class).

D1.3 Data Visualization

display sets of data, using one-to-one correspondence, in concrete graphs, pictographs, line plots, and bar graphs with proper sources, titles, and labels

Teacher supports

Key concepts

- The same data can be represented using a concrete graph, pictograph, line plot, or a bar graph.
- The order of the categories in graphs does not matter for qualitative data.
- The categories for concrete graphs, pictographs, line plots, and bar graphs can be represented horizontally or vertically.
- The source, title, and labels provide important information about data in a graph or table:
 - The source indicates where the data was collected.
 - The title introduces the data contained in the graph or table.
 - Labels provide additional information, such as the category represented by each bar in a bar graph, or each “X” in a line plot. On a pictograph, a key tells how many each picture represents.

Note

- Support students with making connections between the different graphs so that they can transition between concrete and abstract representations of the data.

D1.4 Data Analysis

identify the mode(s), if any, for various data sets presented in concrete graphs, pictographs, line plots, bar graphs, and tables, and explain what this measure indicates about the data

Teacher supports

Key concepts

- A mode of a variable is the category that has the greatest count (frequency).
- Multiple modes of a variable exist when two or more categories have equivalent frequencies that are greater than any others.
- A variable has no mode when there is no category that has a frequency greater than any others.

Note

- When data is presented in a two-way table, the mode must be identified for each variable.

D1.5 Data Analysis

analyse different sets of data presented in various ways, including in logic diagrams, line plots, and bar graphs, by asking and answering questions about the data and drawing conclusions, then make convincing arguments and informed decisions

Teacher supports

Key concepts

- Different representations are used for different purposes to convey different types of information.
- Venn and Carroll diagrams are used to compare data with two different attributes. They help to ask and answer questions like, “What’s the same?” and “What’s different?”
- Line plots and bar graphs are used to show the differences between frequencies quickly and at a glance. They help to ask and answer questions like, “Which is greatest?” and “Which is least?”
- Questions of interest are intended to be answered through the analysis of the representations. Sometimes the analysis raises more questions that require further collection, representation, and analysis of data.

Note

- There are three levels of graph comprehension that students should learn about and practise:
 - Level 1: information is read directly from the graph and no interpretation is required.
 - Level 2: information is read and used to compare (e.g., greatest, least) or perform operations (e.g., addition, subtraction).
 - Level 3: information is read and used to make inferences about the data using background knowledge of the topic.
- Analysing data can be complex, so it is important to provide students with strategies that will support them to build these skills.

D2. Probability

describe the likelihood that events will happen, and use that information to make predictions

Specific expectations

By the end of Grade 2, students will:

D2.1 Probability

use mathematical language, including the terms “impossible”, “possible”, and “certain”, to describe the likelihood of complementary events happening, and use that likelihood to make predictions and informed decisions

Teacher supports

Key concepts

- The likelihood of an event can be represented along a continuum from impossible to certain.
- Complementary events are events that cannot happen at the same time.
- If the likelihood of selecting a red marble out of a bag is certain, then its complement of not selecting a red marble out of a bag is impossible.
- Understanding likelihood can help with making predictions about future events.

D2.2 Probability

make and test predictions about the likelihood that the mode(s) of a data set from one population will be the same for data collected from a different population

Teacher supports

Key concepts

- Data can vary from one population to another.
- If two populations are similar, the modes for the two data sets will more than likely be the same.
- Data can be used to make predictions that are not based on personal feelings or opinions alone.

Note

- In order for students to do an accurate comparison in Grade 2, it is important for them to collect data from the same-sized population (e.g., the same number of days in a month, cubes in a container, or students in Grade 2).

E. Spatial Sense

Overall expectations

By the end of Grade 2, students will:

E1. Geometric and Spatial Reasoning

describe and represent shape, location, and movement by applying geometric properties and spatial relationships in order to navigate the world around them

Specific expectations

By the end of Grade 2, students will:

E1.1 Geometric Reasoning

sort and identify two-dimensional shapes by comparing number of sides, side lengths, angles, and number of lines of symmetry

Teacher supports

Key concepts

- Two-dimensional shapes have geometric properties that allow them to be identified, compared, sorted, and classified.
- Geometric properties are attributes that are the same for an entire group of shapes. Some attributes are relevant for classifying shapes. Others are not. For example, colour and size are attributes but are *not* relevant for geometry since there are large rectangles, small rectangles, blue rectangles, and yellow rectangles. Having four sides is an attribute *and* a property because all rectangles, by definition, have four sides.
- Two-dimensional shapes can be sorted by comparing geometric attributes such as:
 - the number of sides;
 - the number of angles and whether the corners (vertices) are square;
 - the number of equal (congruent) side lengths and how those sides are arranged;
 - whether the sides are curved or straight;
 - whether there are any parallel sides (sides that run side by side in the same direction and remain the same distance apart);
 - the number of lines of symmetry.

- Each class of two-dimensional shapes has common properties, and these properties are unaffected by the size or orientation of the shape.
- A line of symmetry is an imaginary “mirror line” over which one half folds onto the other. Line symmetry is a geometric property of some shapes. For example, rectangles have two lines of symmetry and squares have four lines of symmetry. Some triangles have three lines of symmetry, some have one line of symmetry, and some have no lines of symmetry.

E1.2 Geometric Reasoning

compose and decompose two-dimensional shapes, and show that the area of a shape remains constant regardless of how its parts are rearranged

Teacher supports

Key concepts

- Two-dimensional shapes can be combined to create larger shapes (composing) or broken into smaller shapes (decomposing). All shapes can be decomposed into smaller shapes. The ability to compose and decompose shapes provides a foundation for developing area formulas in later grades.
- If a two-dimensional shape is broken into smaller parts (decomposed) and reassembled in a different way (composed), the area of the shape remains the same even though the shape itself has changed. This is known as the property of conservation.

E1.3 Geometric Reasoning

identify congruent lengths and angles in two-dimensional shapes by mentally and physically matching them, and determine if the shapes are congruent

Teacher supports

Key concepts

- Congruent two-dimensional shapes can fit exactly on top of each other. They have the same shape and the same size.

- Checking for congruence is closely related to measurement. Side lengths and angles can be *directly compared* by matching them, one against the other. They can also be measured.
- Non-congruent shapes can have specific elements that are congruent. For example, two shapes could have a congruent angle or a congruent side length (i.e., those elements match), but if the other side lengths are different, or the angles between the lengths are different, then the two shapes are not considered congruent.

Note

- Visualizing congruent shapes – mentally manipulating and matching shapes to predict congruence – is a skill that can be developed through hands-on experience with shapes.

E1.4 Location and Movement

create and interpret simple maps of familiar places

Teacher supports

Key concepts

- A three-dimensional space can be represented using a two-dimensional map by noting where objects are positioned relative to each other. A map provides a bird’s-eye view of an area.
- Words such as *above*, *below*, *to the left*, *to the right*, *behind*, and *in front of* can orient the location of one object in relation to another.
- A grid adds a structure to a map. It helps to show where one object is in relation to another and can be a guide to determining distances and pathways. The location of objects on a map grid corresponds to an actual or virtual grid overlaid on the corresponding three-dimensional space.
- Sometimes location on a grid is described by the intersection of the grid lines – this provides a precise location. Sometimes location on a grid is described by the space or region between the grid lines – this describes a more general location. It is important to be clear about which approach is used.
- Labelling a grid, with either numbers or letters, helps to describe locations on the grid more accurately.

E1.5 Location and Movement

describe the relative positions of several objects and the movements needed to get from one object to another

Teacher supports

Key concepts

- A three-dimensional space can be represented on a two-dimensional map by noting where objects are positioned relative to each other. A map provides a bird's-eye view of an area.
- Words such as *above*, *below*, *to the left*, *to the right*, *behind*, and *in front of* can orient the location of one object in relation to another (direction). Numbers describe the distance one object is from another.
- A combination of words, numbers, and units are used to describe movement from one location to another (e.g., 5 steps to the left).
- The order of these steps is often important when describing the movement needed to get from one object to another.

E2. Measurement

compare, estimate, and determine measurements in various contexts

Specific expectations

By the end of Grade 2, students will:

E2.1 Length

choose and use non-standard units appropriately to measure lengths, and describe the inverse relationship between the size of a unit and the number of units needed

Teacher supports

Key concepts

- A length is the distance between two points, in any direction. Width, height, and depth are all measurements that compare length, or the distance between two points.

- Units quantify comparisons and are used to change from comparison questions (e.g., which is longer?) to measurement questions (e.g., how long, how much longer?).
- An appropriate unit is one that matches the attribute well (e.g., a unit of length to measure length, a unit of time to measure time) and is easy to repeat.
- To directly measure an object:
 - select a unit that matches the attribute being measured (e.g., a paper clip to measure length);
 - repeat (iterate) the unit or copies of the unit without gaps or overlaps;
 - determine how many units it takes to match the object completely;
 - choose smaller units (or partial units) for greater accuracy.
- Measurements of continuous quantities are always approximate. The smaller the unit chosen, the greater the potential accuracy of the measurement. If different-sized units are used to match an object more completely, each unit is counted and tracked separately.
- The size of the unit affects the count – there is an inverse relationship between the size of the unit and the number of units it takes to cover, match, or fill an attribute. The smaller the unit, the greater the count; the larger the unit, the smaller the count. Regardless of whether a small or large unit is used to measure the length of an object, the object’s length is constant; only the count changes. This is known as the conservation property.

E2.2 Length

explain the relationship between centimetres and metres as units of length, and use benchmarks for these units to estimate lengths

Teacher supports

Key concepts

- Standard units make it possible to reliably communicate measurements. Centimetres and metres are standard metric units for measuring length. There are 100 centimetres in 1 metre.
- Measurements of continuous quantities, such as lengths, are always approximate. The smaller the unit selected, the greater the potential accuracy. Different-sized units can be used to match an object more completely, but the count of each unit must be tracked separately.

- To measure a length that is, for example, between 1 metre and 2 metres, a combination of metres and centimetres can be used, or centimetres only, or rounding the length to the nearest metre.

Note

- In Grade 2, students are not using decimals in their measurements.
- Having familiar reference points (benchmarks) for centimetres and metres makes it easier to estimate the length of objects.

E2.3 Length

measure and draw lengths in centimetres and metres, using a measuring tool, and recognize the impact of starting at points other than zero

Teacher supports

Key concepts

- Rulers, measuring tapes, tape measures – in fact, all measuring tools – replace the need to lay out and count actual physical units. The measuring tool repeats the unit so there are no gaps or overlaps and includes a scale to keep track of the unit count.
- A scale – such as the scale on a ruler – starts at the beginning of the first unit, which is labelled 0 because no units have been laid out. At the end of the first unit, the scale is labelled 1, because 1 complete unit has been laid out. The scale continues to count full units.
- When the edge of an object is matched with the 0 on the measuring tool, the scale accurately keeps track of the count. However, a length can be measured from any starting point, as long as the count is adjusted based on the starting point to accurately reflect the length of the object.
- The distance between two end points stays constant, no matter where on the scale the count begins. A measurement counts the number of units between the start of a length and the end of a length.

E2.4 Time

use units of time, including seconds, minutes, hours, and non-standard units, to describe the duration of various events

Teacher supports

Key concepts

- Measuring time involves questions such as: “What time is it?” and “How much time has passed?”. The focus in Grade 2 is on the second question.
- The passage of time is measured by counting units of time that repeat in a regular and predictable manner: the beats of a metronome; the dripping of a faucet; the natural cycles of a day; the swing of a pendulum; the seconds, minutes, and hours of a clock.
- Similar to measuring physical length, a length of time can be measured using different units of different sizes. The smaller the unit of time used, the more precise the measurement. Similar to all continuous attributes, the measurement of time is always approximate.
- Around the world, standard units of time – seconds, minutes, hours – are used to communicate the length of time of an event. Measuring tools, such as stopwatches, keep track of the unit count.

F. Financial Literacy

Overall expectations

By the end of Grade 2, students will:

F1. Money and Finances

demonstrate an understanding of the value of Canadian currency

Specific expectations

By the end of Grade 2, students will:

F1.1 Money Concepts

identify different ways of representing the same amount of money up to Canadian 200¢ using various combinations of coins, and up to \$200 using various combinations of \$1 and \$2 coins and \$5, \$10, \$20, \$50, and \$100 bills

Teacher supports

Key concepts

- There are a variety of ways to represent the same amount of money.
- There are various strategies to determine the different ways to represent the same amount of money; for example, using an organized list, representing the amounts with drawings, or using money manipulatives.

Note

- Combining a variety of coins and bills to produce a set amount requires an understanding of the relationship between the denominations of coins and bills and their value.
- Skip-counting skills and the ability to compose and decompose numbers support learning about different ways to make money amounts.

Mathematics, Grade 3

Expectations by strand

A. Social-Emotional Learning (SEL) Skills in Mathematics and the Mathematical Processes

This strand focuses on students' development and application of social-emotional learning skills to support their learning of math concepts and skills, foster their overall well-being and ability to learn, and help them build resilience and thrive as math learners. As they develop SEL skills, students demonstrate a greater ability to understand and apply the mathematical processes, which are critical to supporting learning in mathematics. In all grades of the mathematics program, the learning related to this strand takes place in the context of learning related to all other strands, and it should be assessed and evaluated within these contexts.

Overall expectations

Throughout this grade, in order to promote a positive identity as a math learner, to foster well-being and the ability to learn, build resilience, and thrive, students will:

A1. Social-Emotional Learning (SEL) Skills and the Mathematical Processes

apply, to the best of their ability, a variety of social-emotional learning skills to support their use of the mathematical processes and their learning in connection with the expectations in the other five strands of the mathematics curriculum

To the best of their ability, students will learn to:	... as they apply the mathematical processes :	... so they can:
1. identify and manage emotions	<ul style="list-style-type: none"> • problem solving: develop, select, and apply problem-solving strategies • reasoning and proving: develop and apply reasoning skills (e.g., classification, recognition of relationships, use of counter-examples) to justify thinking, make and investigate conjectures, and construct and defend arguments 	1. express and manage their feelings, and show understanding of the feelings of others, as they engage positively in mathematics activities
2. recognize sources of stress and cope with challenges	<ul style="list-style-type: none"> • reflecting: demonstrate that as they solve problems, they are pausing, looking back, and monitoring their thinking to help clarify their understanding (e.g., by comparing and adjusting strategies used, by explaining why they think their results are reasonable, by recording their thinking in a math journal) 	2. work through challenging math problems, understanding that their resourcefulness in using various strategies to respond to stress is helping them build personal resilience
3. maintain positive motivation and perseverance	<ul style="list-style-type: none"> • connecting: make connections among mathematical concepts, procedures, and representations, and relate mathematical ideas to other contexts (e.g., other curriculum areas, daily life, sports) 	3. recognize that testing out different approaches to problems and learning from mistakes is an important part of the learning process, and is aided by a sense of optimism and hope
4. build relationships and communicate effectively	<ul style="list-style-type: none"> • communicating: express and understand mathematical thinking, and engage in mathematical arguments using everyday language, language resources as necessary, appropriate mathematical terminology, a variety of representations, and mathematical conventions 	4. work collaboratively on math problems – expressing their thinking, listening to the thinking of others, and practising inclusivity – and in that way fostering healthy relationships
5. develop self-awareness and sense of identity	<ul style="list-style-type: none"> • representing: select from and create a variety of representations of mathematical ideas (e.g., 	5. see themselves as capable math learners, and strengthen their sense of ownership of their learning, as part of their emerging sense of identity and belonging

6. think critically and creatively	representations involving physical models, pictures, numbers, variables, graphs), and apply them to solve problems <ul style="list-style-type: none"> • selecting tools and strategies: select and use a variety of concrete, visual, and electronic learning tools and appropriate strategies to investigate mathematical ideas and to solve problems 	6. make connections between math and everyday contexts to help them make informed judgements and decisions
------------------------------------	--	--

B. Number

Overall expectations

By the end of Grade 3, students will:

B1. Number Sense

demonstrate an understanding of numbers and make connections to the way numbers are used in everyday life

Specific expectations

By the end of Grade 3, students will:

B1.1 Whole Numbers

read, represent, compose, and decompose whole numbers up to and including 1000, using a variety of tools and strategies, and describe various ways they are used in everyday life

Teacher supports

Key concepts

- Reading numbers involves interpreting them as a quantity when they are expressed in words, in standard notation, or represented using physical objects or diagrams.
- The numerals 0 to 9 are used to form numbers. They are referred to as the digits in a number and each digit corresponds to a place value. For example, in the number 4107,

the digit 4 represents 4 thousands, the digit 1 represents 1 hundred, the digit 0 represents 0 tens, and the digit 7 represents 7 ones.

- There are patterns in the way numbers are formed. Each decade repeats the 0 to 9 counting sequence. Any quantity, no matter how great, can be described in terms of its place value.
- A number can be represented in expanded form (e.g., $3187 = 3000 + 100 + 80 + 7$ or $3 \times 1000 + 1 \times 100 + 8 \times 10 + 7 \times 1$) to show place value relationships.
- Numbers can be composed and decomposed in various ways, including by place value.
- Numbers are composed when two or more numbers are combined to create a larger number. For example, 300, 200, and 6 combine to make 506.
- Numbers are decomposed when they are represented as a composition of two or more smaller numbers. For example, 512 can be represented as 250 and 250 and 10 and 2.
- Tools may be used when representing numbers. For example, 362 may be represented as the sum of 36 ten-dollar bills and 1 toonie or 3 base ten flats, 6 base ten rods, and 2 base ten units.
- Numbers are used throughout the day, in various ways and contexts. Most often, numbers describe and compare quantities. They express magnitude and provide a way to answer questions such as “how much?” and “how much more?”.

Note

- Every strand in the mathematics curriculum relies on numbers.
- Numbers may have cultural significance.
- When a number is decomposed and then recomposed, the quantity is unchanged. This is the conservation principle.
- There are non-standard but equivalent ways to decompose a number using place value, based on understanding the relationships between the place values. For example, 587 could be decomposed as 58 tens and 7 ones or decomposed as 50 tens and 87 ones, and so on.
- Composing and decomposing numbers in a variety of ways can support students in becoming flexible with mental math strategies for addition and subtraction.
- Closed, partial, and open number lines are important tools for representing numbers and showing the composition and decomposition of numbers. Numbers on a closed number line can be represented as a position on a number line or as a distance from zero. Partial number lines can be used to show the position of a number relative to other numbers. Open number lines can be used to show the composition of large numbers without drawing them to scale.
- Breaking down numbers and quantities into smaller parts (decomposing) and reassembling them in new ways (composing) highlights relationships between numbers

and builds strong number sense. Composing and decomposing numbers is also useful when doing a calculation or making a comparison.

- As students build quantities to 1000 concretely, they should also use both written words and numerals to describe the quantity so that they can make connections among the representations.

B1.2 Whole Numbers

compare and order whole numbers up to and including 1000, in various contexts

Teacher supports

Key concepts

Concepts

- Numbers are compared and ordered according to their “how muchness” or magnitude.
- Numbers with the same units can be compared directly (e.g., 645 days compared to 625 days). Numbers that do not show a unit are assumed to have units of ones (e.g., 75 and 12 are considered as 75 ones and 12 ones).
- Sometimes numbers without the same unit can be compared, such as 625 weeks and 75 days. Knowing that the unit "weeks" is greater than the unit "days", and knowing that 625 is greater than 75, one can infer that 625 weeks is a greater length of time than 75 days.
- Benchmark numbers can be used to compare quantities. For example, 132 is less than 500 and 620 is greater than 500, so 132 is less than 620.
- Numbers can be compared by their place value. For example, when comparing 825 and 845, the greatest place value in which the numbers differ is compared. For this example, 2 tens (from 825) and 4 tens (from 845) are compared. Since 4 tens is greater than 2 tens, 845 is greater than 825.
- Numbers can be ordered in ascending order – from least to greatest – or can be ordered in descending order – from greatest to least.

Note

- Understanding place value enables any number to be compared and ordered. There is a stable order to how numbers are sequenced, and patterns exist within this sequence that make it possible to predict the order of numbers and make comparisons.
- Once millimetres have been introduced (see **Spatial Sense SE, E2.2**), the millimetre markings on a metre stick can serve as a physical number line that spans from 0 to 1000.

Using the centimetre labels to determine the count of millimetres connects the Number strand to the Spatial Sense strand and strengthens the “times ten” mental math focus in **SE B2.2**.

B1.3 Whole Numbers

round whole numbers to the nearest ten or hundred, in various contexts

Teacher supports

Key concepts

- Rounding numbers is often done to estimate a quantity or measure, estimate the results of a computation, and make an estimated comparison.
- How close a rounded number is to the original number depends on the unit or place value that it is being rounded to. A number rounded to the nearest ten is closer to the original number than a number being rounded to the nearest hundred.
- Whether a number is rounded “up” or “down” depends on the context. For example, when paying by cash in a store, the amount owing is rounded to the nearest five cents.
- In the absence of a context, numbers are typically rounded based on the midpoint. This approach involves considering the amount that is halfway between two units and determining whether a number is closer to one unit than other:
 - Rounding 237 to the nearest 10 becomes 240, since 237 is closer to 240 than 230.
 - Rounding 237 to the nearest 100 becomes 200, since 237 is closer to 200 than 300.
- If a number is exactly on the midpoint, the “half round up”, which is the common method for rounding would round up to the nearest 10. So, 235 rounded to the nearest 10 becomes 240.

Note

- The degree to which a number is rounded is often determined by the precision that is required.

B1.4 Whole Numbers

count to 1000, including by 50s, 100s, and 200s, using a variety of tools and strategies

Teacher supports

Key concepts

- Counting usually has a purpose, such as determining how many are in a collection, determining how long before something will happen, or comparing quantities and amounts.
- A count can start from zero or any other starting number.
- The unit of skip counting is identified as the number of objects in a group. For example, when counting by twos, each group has two objects.
- Counting can involve a combination of skip counts and single counts.
- The 0 to 9 and decade counting sequences that appear in the first hundred repeat in every subsequent hundred.

Note

- Skip counting helps build basic facts and mental math strategies and establishes a strong foundation for multiplication and division.
- Counting up to and over each of the hundreds reinforces the 0 to 9 pattern in the place value system.

B1.5 Whole Numbers

use place value when describing and representing multi-digit numbers in a variety of ways, including with base ten materials

Teacher supports

Key concepts

- Any whole number can be described using the place value of its digits.
- The *place* (or position) of a digit determines its *value* (*place value*). The 5 in 511, for example, has a value of 5 hundreds (500) and not 5.
- The order of the digits makes a difference. The number 385 describes a different quantity than 853.
- The digits in a number represent groups of ones, tens, hundreds, and so on. A zero in a column indicates that there are no groups of that size in the number. It serves as a placeholder, holding the other digits in their correct “place”. For example, 57 means 5 tens and 7 ones, but 507 means 5 hundreds, 0 tens, and 7 ones.

- Expanded notation represents a number according to place value. For example, 987 means there are 9 groups of 100, 8 groups of 10, and 7 ones, which in expanded notation is $900 + 80 + 7$ or $9 \times 100 + 8 \times 10 + 7 \times 1$.

Note

- The value of the digits in each of the positions follows a “times ten” multiplicative pattern. For example, 50 is ten times greater than 5, and 500 is ten times greater than 50.
- Base ten materials are important for demonstrating the quantities of numbers and for reinforcing that each digit represents a place value.
- Understanding place value is foundational for understanding the magnitude of numbers and is important for various calculation strategies and algorithms.
- There is a “hundreds-tens-ones” pattern that repeats within each period (e.g., units, thousands, millions). Although students in Grade 3 are working with numbers only to 1000, early exposure to this larger pattern and the names of the periods – into millions and beyond – satisfies a natural curiosity around “big numbers”.

Place Value Patterns

one billions	hundred millions	ten millions	one millions	hundred thousands	ten thousands	one thousands	hundreds	tens	ones

B1.6 Fractions

use drawings to represent, solve, and compare the results of fair-share problems that involve sharing up to 20 items among 2, 3, 4, 5, 6, 8, and 10 sharers, including problems that result in whole numbers, mixed numbers, and fractional amounts

Teacher supports

Key concepts

- Fair-sharing or equal-sharing means that quantities are shared equally. For a whole to be shared equally, it must be partitioned so that each sharer receives the same amount.
 - Sometimes the share is a whole number (e.g., if 4 pieces of ribbon are shared equally among 2 people, each person gets 2 pieces of ribbon).
 - Sometimes the share is a fractional amount (e.g., if 4 pieces of ribbon are shared equally among 8 people, each person gets one half of a ribbon).

- Sometimes the share results in a whole plus a fractional amount (mixed number) (e.g., if 4 pieces of ribbon are shared equally among 3 people, each person gets 4 one thirds or 1 and one third pieces of the ribbon).
- Comparing two different sharing situations involves reviewing the relationship (ratio) between the amount to be shared and the number of sharers.
 - If the amounts to be shared are the same, then the greater the number of sharers, the less each sharer gets.
 - If the number of sharers is the same, then the greater the amount to be shared, the greater each sharer gets.
 - If the amounts to be shared are the same as the number of sharers, then the amount each sharer gets is the same for each situation.

Note

- Words can have multiple meanings. It is important to be aware that in many situations, fair does not mean equal, and equal is not equitable. Educators should clarify how they are using the term “fair share” and ensure that students understand that in the math context fair means equal and the intent behind such math problems is to find equal amounts.
- Fair-share or equal-share problems provide a natural context for students to encounter fractions and division. Present these problems in the way that students will best connect to.
- Fractional amounts can be expressed as a count of unit fractions (e.g., 2 one thirds), as words (e.g., two thirds), as a combination of numbers and words (e.g., 2 thirds), and symbolically (e.g., $\frac{2}{3}$). As students come to understand fraction terms (halves, fourths, and so on) and use them independently, it is appropriate to introduce the corresponding symbolic fractional notation (see **SE B2.9**). Continuing to use all four ways of expressing fractions helps to reinforce the meaning behind the symbols.

B1.7 Fractions

represent and solve fair-share problems that focus on determining and using equivalent fractions, including problems that involve halves, fourths, and eighths; thirds and sixths; and fifths and tenths

Teacher supports

Key concepts

- When something is shared fairly or equally as five pieces, each piece is $1\frac{1}{5}$ of the original amount. Five one fifths make up a whole.
- When something is shared fairly or equally as ten pieces, each piece is $1\frac{1}{10}$ of the original amount. Ten one tenths make up a whole.
- Fractions are equivalent when they represent the same value or quantity.
- If the original amount is shared as five pieces or ten pieces, the fractions one fifth and 2 one tenths (two tenths) are equivalent. Similarly 2 one fifths (two fifths) and 4 one tenths (four tenths) are equivalent, 3 one fifths (three fifths) and 6 one tenths (six tenths) are equivalent, 4 one fifths (four fifths) and 8 one tenths (eight tenths) are equivalent, and 5 one tenths (five tenths), and 10 one tenths (ten tenths) are equivalent.
- Different fractions can describe the same amount. Five tenths, four eighths, three sixths, and two fourths all represent the same amount as one half.

Note

- Words can have multiple meanings. It is important to be aware that in many situations, fair does not mean equal, and equal is not equitable. Educators should clarify how they are using the term "fair share" and ensure that students understand that in the math context fair means equal and the intent behind such math problems is to find equal amounts.
- Fair-share or equal-sharing scenarios provide a natural context for students to encounter and use equivalent fractions (see **SE B1.6**). Present these problems in the way that students will best connect to.
- Patterns that exist between equivalent fractions can be used to generate other equivalent fractions.
- When two fractions (or ratios) are equivalent, the relationships among the numerators and the denominators are constant. For example, in $\frac{1}{2}$ and $\frac{3}{6}$, the denominator in both fractions is twice the numerator; and the numerator of one fraction is three times that of the other, just as the denominator of one is three times that of the other.

B2. Operations

use knowledge of numbers and operations to solve mathematical problems encountered in everyday life

Specific expectations

By the end of Grade 3, students will:

B2.1 Properties and Relationships

use the properties of operations, and the relationships between multiplication and division, to solve problems and check calculations

Teacher supports

Key concepts

- Multiplication and division can describe situations involving repeated groups of equal size:
 - Multiplication names the unknown *total* when the *number of groups* and the *size of the groups* are known.
 - Division names *either* the number of groups *or* the size of the groups when only one is known along with the *total*.
- Multiplication and division are inverse operations. (See **SEs B2.2, B2.6, and B2.7.**)
- Any division question can be thought of as a multiplication question unless 0 is involved (e.g., $16 \div 2 = ?$ is the same as $? \times 2 = 16$), and vice versa. This inverse relationship can be used to perform and check calculations.

Note

- Multiplication and division problems can be solved in various ways, depending on the numbers that are given and the facts that are known.
- Since students are developing their multiplication and division facts for 2, 5, and 10 in Grade 3, it is important for them to solve problems concretely so that they can make connections to these facts and how they can be used to solve any multiplication problem.
- Students need to understand the distributive property of multiplication over addition, and the commutative and associative properties of multiplication. They should be able to use these properties authentically as they solve problems, but they do not need to name them.
- This expectation supports many other expectations in the Number strand and is applied throughout the grade. Whether working with numbers or operations, recognizing and applying properties and relationships builds a strong foundation for doing mathematics.

B2.2 Math Facts

recall and demonstrate multiplication facts of 2, 5, and 10, and related division facts

Teacher supports

Key concepts

- Multiplication and division are inverse operations, and the basic facts for division can be rephrased using multiplication (see **SE B2.1**). For example, $16 \div 2$ can be rewritten as $? \times 2 = 16$, and thought of as “how many groups of 2 are in 16?” (i.e., grouping division).

Note

- Using repeated equal groups to model multiplication and division facts builds understanding of the facts as well as the operations (see **SE B2.6**).
- Having automatic recall of multiplication and division facts is important when carrying out mental or written calculations and frees up working memory when solving complex problems and tasks.
- Working with doubles, halving, and skip counting by 2, 5, and 10 provides a strong foundation and starting point for learning the multiplication facts of 2, 5, and 10.
- Multiplication and division involve a “double count”. One count keeps track of the number of equal groups. The other count keeps track of the running total. Double counting can be observed when students use fingers to keep track of the number of groups as they skip count towards a total.

B2.3 Mental Math

use mental math strategies, including estimation, to add and subtract whole numbers that add up to no more than 1000, and explain the strategies used

Teacher supports

Key concepts

- Mental math refers to doing a calculation in one’s head. Sometimes the numbers or the number of steps in a calculation are too complex to completely hold in one’s head, so jotting down partial calculations and diagrams are can be used to complete the calculations.

- Number lines, circular number lines, and part-whole models can be used to show strategies for doing the calculations.
- Estimation by rounding (see **SE B1.3**) is a useful mental strategy when either an exact answer is not needed or there is insufficient time to work out a solution.

Note

- Strategies to do mental calculations will vary depending on the numbers, facts, and properties that are used. For example:
 - For $187 + 2$, simply count on.
 - For $726 + 38$, decompose 38 as 34 and 4, add 4 to 726 to get 730, and then add on 34 to get 764.
 - For $839 + 9$, add 10 onto 839 and then subtract the extra 1.
- Mental math may or may not be quicker than paper-and-pencil strategies, but speed is not the goal. The value of mental math is in its portability and flexibility, since it does not require a calculator or paper and pencil. Practising mental math strategies also deepens an understanding of numbers.
- Mental math involves using flexible strategies that build on basic facts, number relationships, and counting strategies. These strategies continue to expand and develop through the grades.
- Estimation can be used to check the reasonableness of calculations and should be continually encouraged when students are doing mathematics.

B2.4 Addition and Subtraction

demonstrate an understanding of algorithms for adding and subtracting whole numbers by making connections to and describing the way other tools and strategies are used to add and subtract

Teacher supports

Key concepts

- The most common standard algorithms for addition and subtraction in North America use a very compact organizer to *decompose* and *recompose* numbers based on place value (see **SEs B1.1** and **B1.5**).

- The North American algorithms for addition and subtraction both start from the right and move to the left, digit by digit.
- The digits in the unit column are added or subtracted.
- When the sum of two digits exceeds 9 or the difference is below zero, a “regroup” or a “trade” (decomposing and recomposing) from the next column is made so that the operation can be carried out.
- The process is repeated for every column and small numbers are used to track and manage the regroupings.
- The example below shows how North American addition and subtraction algorithms are often written. They also include one way to represent the hidden place-value compositions and decompositions that occur as part of the algorithm.

How It Is Written	What It Means
$\begin{array}{r} \overset{1}{4}79 \\ + 269 \\ \hline 748 \end{array}$	$\begin{array}{r} 479 \\ + 269 \\ \hline 18 \quad (9 + 9) \\ 130 \quad (70 + 60) \\ 600 \quad (400 + 200) \\ \hline 748 \end{array}$

How It Is Written	What It Means
$\begin{array}{r} \overset{8}{9}00 \\ - 247 \\ \hline 653 \end{array}$	$\begin{array}{l} \rightarrow 800 + 90 + 10 \\ \rightarrow 200 + 40 + 7 \\ \rightarrow 600 + 50 + 3 \end{array}$

Note

- An algorithm describes a process or set of steps to carry out a procedure. A standard algorithm is one that is known and used by a community. Different cultures have different standard algorithms that they use to perform calculations.
- Algorithms for addition or subtraction describe the steps needed to carry out the operation; organize the steps efficiently; and, if performed accurately, produce the correct answer.
- When working with standard algorithms, it is important to reinforce the actual quantities that are being used in the calculations by continuously referring to the *place* value of the digits rather than their *face* value (see **SE B1.5**). For example, when talking about adding $126 + 287$, instead of using the digits ($7 + 6$; $8 + 2$; $1 + 2$), use the values ($7 + 6$; $20 + 80$; $100 + 200$) of the numbers that are being added together.

B2.5 Addition and Subtraction

represent and solve problems involving the addition and subtraction of whole numbers that add up to no more than 1000, using various tools and algorithms

Teacher supports

Key concepts

- Situations involving addition and subtraction may involve:
 - adding a quantity onto an existing amount or removing a quantity from an existing amount;
 - combining two or more quantities;
 - comparing quantities.
- Acting out a situation, by representing it with objects, a drawing, or a diagram, can help support students to identify the given quantities in a problem and the unknown quantity.
- Set models can be used to add a quantity to an existing amount or removing a quantity from an existing amount.
- Linear models can be used to determine the difference between two quantities by comparing them visually.
- Part-whole models can be used to show the relationship between what is known and what is unknown and how addition and subtraction relate to the situation.

Note

- An important part of problem solving is the ability to choose the operation that matches the action in a situation. For additive situations – situations that involve addition or subtraction – there are three “problem structures” that describe a different usage of the operation:
 - *Change* situations, where one quantity is changed, by having an amount either *joined* to it or *separated* from it. Sometimes the result is unknown; sometimes the starting point is unknown; sometimes the change is unknown.
 - *Combine* situations, where two quantities are *combined*. Sometimes one part is unknown; sometimes the other part is unknown; sometimes the result is unknown.
 - *Compare* situations, where two quantities are being *compared*. Sometimes the larger amount is unknown; sometimes the smaller amount is unknown; sometimes the difference between the two amounts is unknown.

- Representing a situation with a drawing helps visualize the actions and quantities in a problem. Part-whole models are helpful for showing the relationship between what is known and unknown, and how addition and subtraction relate to the situation.
- In order to reinforce the meaning of addition and subtraction, it is important to model the corresponding equation that represents the situation, and to place the unknown quantity correctly (e.g., $125 + ? = 275$, or $? + 150 = 275$, or $125 + 150 = ?$). Matching the structure of the equation to what is happening in the situation reinforces the meaning of addition and subtraction.
- Sometimes changing a “non-standard” equation (where the unknown is not after the equal sign) into its “standard form” can make it easier to carry out the calculation.
- Part-whole models make the inverse relationship between addition and subtraction evident and support students in developing a flexible understanding of the equal sign. These are all important ideas in the development of algebraic reasoning.
- Mental addition and subtraction strategies can be used to solve any computation. As numbers become greater, or there is a need to communicate strategies with others, the steps may need to be written down.
- Algorithms, including many for addition and subtraction, use place value to produce a procedure that will work with any numbers (see **SE B2.4**). When working with algorithms, it is important to reinforce the actual quantities in the equation by continuously referencing the *place* value of the digits rather than their *face* value (see **SEs B1.1** and **B1.5**). For example, if adding $26 + 32$ from left to right, talk about adding 20 and 30, then 6 and 2).

B2.6 Multiplication and Division

represent multiplication of numbers up to 10×10 and division up to $100 \div 10$, using a variety of tools and drawings, including arrays

Teacher supports

Key concepts

- One way to model multiplication and division is to use repeated groups of equal size.
- Multiplication and division are related. A division problem can be thought of as a multiplication problem with a missing factor (unless 0 is involved). So $24 \div 6$ can be rewritten as $6 \times ? = 24$.
- The array can be a very useful model for multiplication and division because it structures repeated groups of equal size into rows and columns.
 - In a multiplication situation the number of rows and the number of columns for the array are both known.

- In a division situation the total number of objects is known, as well as either the number of rows or the number of columns. In order to create an array to represent a division situation, the objects are arranged into the rows or columns that are known until all the objects have been distributed evenly.

Note

- The array helps make visual connections to skip counting, the distributive property, and the inverse relationship between multiplication and division.

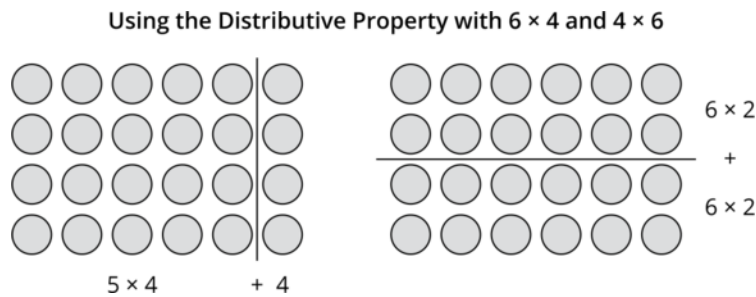

- The beads on a rekenrek are arranged as an array and can be adjusted to show columns and rows up to 10×10 . The rows of beads that are set up as 5 red and 5 white can support students with making connections to the distributive property and understanding numbers in terms of their relationship to 5 and 10.
- Several tools can be used to model multiplication and division, including ten frames, relational rods, and hops on a number line.

B2.7 Multiplication and Division

represent and solve problems involving multiplication and division, including problems that involve groups of one half, one fourth, and one third, using tools and drawings

Teacher supports

Key concepts

- Multiplication and division are both useful for describing situations involving repeated groups of equal size.
 - Multiplication names the unknown *total* when the *number of groups* and the *size of the groups* are known.
 - Division names *either* the unknown *size of groups* (sharing division), *or* the unknown *number of groups* (grouping division) when the *total* is known.

- The inverse relationship between multiplication and division means that any situation involving repeated equal groups can be represented with either multiplication or division. See also **SE B2.1**.
- There are two types of division problems:
 - Equal-sharing division (also called “partitive division”):
 - *What is known*: the total and number of groups.
 - *What is unknown*: the size of the groups.
 - *The action*: a total shared equally among a given number of groups. (See **SEs B1.6** and **B1.7** for connections between equal-sharing division and fractions.)
 - Equal-grouping division (sometimes called “measurement division” or “quotative division”):
 - *What is known*: the total and the size of groups.
 - *What is unknown*: the number of groups.
 - *The action*: from a total, equal groups of a given size are measured out.
- Repeated addition and repeated subtraction are often used as strategies to solve multiplication and division problems.
- Repeated addition is often used as a multiplication strategy, by adding equal groups to find the total.
- Repeated addition is also often used as a division strategy, by thinking of the division as multiplication with a missing factor (e.g., thinking of $15 \div 3$ as $3 \times ? = 15$ and asking how many groups of 3 are in 15).
- Repeated subtraction is often used as a division strategy, by removing equal groups from the given total. Each round of sharing is “unitized” as a group and subtracted from the total. Each repeated round is represented as a subtracted group.

Note

- The use of drawings, tools (arrays, number lines), and objects can help to visualize the quantities and the actions involved in the situation, as well as what is known and unknown.
- Often the representation alone may be enough for a problem to be solved by counting. In these cases, it is important to also include the corresponding multiplication or division equation to make connections to the operations and build algebraic reasoning.

B2.8 Multiplication and Division

represent the connection between the numerator of a fraction and the repeated addition of the unit fraction with the same denominator using various tools and drawings, and standard fractional notation

Teacher supports

Key concepts

- The denominator is the bottom number of a fraction expressed in fractional notation and represents the relative size of each part (the unit fraction). If a whole is divided into five equal-sized parts, each part is one fifth ($\frac{1}{5}$). The greater the number of partitions of a whole, the smaller the unit fraction is relative to the whole.
- The numerator is the top number of a fraction expressed in fractional notation and represents the count of equal parts (unit fractions). If there are 2 one fifths, it is written as $\frac{2}{5}$. This count can be represented with repeated addition (e.g., $\frac{2}{5}$ is one fifth plus one fifth).

B2.9 Multiplication and Division

use the ratios of 1 to 2, 1 to 5, and 1 to 10 to scale up numbers and to solve problems

Teacher supports

Key concepts

- Ratios deal with multiplicative relationships in a variety of contexts. For example:
 - If the ratio of vowels to consonants in a word is 1 to 2, then there are twice as many consonants in the word as there are vowels.
 - If a set has 1 red object and 5 blue objects, then the ratio of red to blue is 1 to 5.
 - If there are ten times as many birds as there are kittens in the pet store, then the ratio of birds to kittens is 10 to 1 or the ratio of kittens to birds is 1 to 10.

Note

- A ratio of “ a to b ” can be written symbolically as $a:b$, for example, 1 to 2 can be written as 1:2.

- To scale up means to multiply a starting number by a factor. An application of this is scaling a number line. To support this understanding, use a double number line with one number line showing the starting values and the second number line showing the scaling. For example, scaling the numbers 0 to 4 by 5 is illustrated on a double number line below.

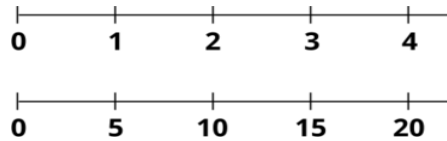

C. Algebra

Overall expectations

By the end of Grade 3, students will:

C1. Patterns and Relationships

identify, describe, extend, create, and make predictions about a variety of patterns, including those found in real-life contexts

Specific expectations

By the end of Grade 3, students will:

C1.1 Patterns

identify and describe repeating elements and operations in a variety of patterns, including patterns found in real-life contexts

Teacher supports

Key concepts

- Patterns may involve a repeating element and a repeating operation (e.g., in a design, different sizes of squares may be repeated).
- The shortest string of elements that repeat in a pattern is referred to as the “pattern core”.
- The quantifying measure or numerical value in a pattern may involve a repeat of addition, subtraction, multiplication, or division.

Note

- Students can engage in mathematics and patterns through the contexts, cultural histories, and stories of various cultures.
- Have students focus on how attributes are staying the same and how they are changing.
- A repeat operation involving addition and subtraction of zero will result in a pattern whose elements are not altered.
- A repeat operation involving multiplication and division by one will result in a pattern whose elements are not altered.

C1.2 Patterns

create and translate patterns that have repeating elements, movements, or operations using various representations, including shapes, numbers, and tables of values

Teacher supports

Key concepts

- The same pattern structure can be represented in various ways.
- Patterns with a repeating element can be based on attributes (e.g., colour, size, orientation).
- Patterns with a repeating operation can be based on repeating operations of addition, subtraction, multiplication, and/or division.
- Pattern structures can be generalized.
- When translating a pattern from a concrete representation to a table of values, each iteration of the pattern can be referred to as the term number, and the number of elements in each iteration can be referred to as the term value. In a table of values, the term number is shown in the left-hand column and the term value is shown in the right-hand column.

Note

- Comparing translated patterns highlights the equivalence of their underlying mathematical structure, even though the representation differs.

C1.3 Patterns

determine pattern rules and use them to extend patterns, make and justify predictions, and identify missing elements in patterns that have repeating elements, movements, or operations

Teacher supports

Key concepts

- Patterns can be extended because they are repetitive by nature.
- Pattern rules are generalizations about a pattern, and they can be described in words.
- Patterns can be extended in multiple directions – up, down, right, left, diagonally.
- To make a near prediction about a pattern is to state or show what a pattern will look like just beyond the given representation of that pattern. The prediction can be verified by extending the pattern.
- To make a far prediction about a pattern is to state or show what a pattern will look like well beyond the given representation of that pattern. Often calculations are needed to make an informed prediction or to verify a prediction.
- To identify missing elements of patterns is to complete a representation for a given pattern by filling in the missing parts.

Note

- In order to extend, predict, or determine missing elements, students need to generalize patterns, using pattern rules.
- Rules should be used to verify predictions and to critically analyse extensions and solutions for missing elements.

C1.4 Patterns

create and describe patterns to illustrate relationships among whole numbers up to 1000

Teacher supports

Key concepts

- Patterns can be used to understand relationships among numbers.
- There are many patterns within the whole number system.

Note

- Many number strings are based on patterns and the use of patterns to develop a mathematical concept.

C2. Equations and Inequalities

demonstrate an understanding of variables, expressions, equalities, and inequalities, and apply this understanding in various contexts

Specific expectations

By the end of Grade 3, students will:

C2.1 Variables

describe how variables are used, and use them in various contexts as appropriate

Teacher supports

Key concepts

- Variables are used in formulas (e.g., the perimeter of a square can be determined by four times its side length (s), which can be expressed as $4s$).
- Variables are used in coding so that the code can be run more than once with different numbers.
- Variables are defined when doing a mathematical modelling task.

Note

- Identifying quantities in real life that stay the same and those that can change will help students understand the concept of variability.
- Identifying what is constant and what changes is one aspect of mathematical modelling.
- When students find different addends for a sum no more than 200, they are implicitly working with variables. These numbers are like variables that can change (e.g., in coding, a student's code could be $\text{TotalSteps} = \text{FirstSteps} + \text{SecondSteps}$).
- In mathematics notation, variables are only expressed as letters or symbols. When coding, variables may be represented as words, abbreviated words, symbols, or letters.
- Students are also implicitly working with variables as they are working with attributes (e.g., length, mass, colour, number of buttons), as the value of those attributes can vary.

C2.2 Equalities and Inequalities

determine whether given sets of addition, subtraction, multiplication, and division expressions are equivalent or not

Teacher supports

Key concepts

- Numerical expressions are equivalent when they produce the same result, and an equal sign is the symbol denoting two equivalent expressions.
- Numerical expressions are not equivalent when they do not produce the same result, and an equal sign with a slash through it (\neq), is a symbol denoting that the two expressions are not equivalent.
- Various strategies can be used to determine whether expressions are equivalent. Visual representations of the expressions can be manipulated until they look the same or close to the same.

Note

- The equal sign should not be interpreted as the "answer", but rather, that both parts on either side of the equal sign are equal, therefore creating balance.

C2.3 Equalities and Inequalities

identify and use equivalent relationships for whole numbers up to 1000, in various contexts

Teacher supports

Key concepts

- When numbers are decomposed, the sum of the parts is equivalent to the whole.
- The same whole can result from different parts.

Note

- Many mathematical concepts are based on an underlying principle of equivalency.
- The commutative properties of addition and multiplication are founded on equivalency.

C3. Coding

solve problems and create computational representations of mathematical situations using coding concepts and skills

Specific expectations

By the end of Grade 3, students will:

C3.1 Coding Skills

solve problems and create computational representations of mathematical situations by writing and executing code, including code that involves sequential, concurrent, and repeating events

Teacher supports

Key concepts

- Loops make code more readable and reduce the number of instructions that need to be written. Loops can also help to emphasize the repetitive properties of some mathematical tasks and concepts.
- Using loops helps students organize their code and provides a foundation for considering efficiencies in program solutions.

Note

- Coding can support students in developing a deeper understanding of mathematical concepts.
- Loops provide an opportunity to experience the power of code and the process of automating algorithmic components.
- By manipulating conditions within a loop and the number of times that the loop will be repeated, students can determine the relationship between variables in lines of code.
- Coding can include a combination of pseudocode, block-based coding programs, and text-based coding programs.
- Students can program for various agents, such as a pixelated image on a screen, a classmate acting out the code when appropriate, or a physical device (e.g., robot, microcontroller).

C3.2 Coding Skills

read and alter existing code, including code that involves sequential, concurrent, and repeating events, and describe how changes to the code affect the outcomes

Teacher supports

Key concepts

- Code can be altered to develop students' understanding of mathematical concepts, and to ensure that the code is generating the expected outcome.
- Altering code to use loops can simplify instructions while generating the same outcome.
- The placement of a loop in the code can affect the outcome.
- Changing the sequence of instructions in code can sometimes produce the same outcome and can sometimes produce a different outcome.

Note

- It is important for students to understand when order matters. Some mathematical concepts are founded on the idea that the sequence of instructions does not matter; for example, the commutative and associative properties of addition.
- Predicting the outcome of code allows students to visualize the movement of an object in space or imagine the output of specific lines of code. This is a valuable skill when debugging code and problem solving.

C4. Mathematical Modelling

apply the process of mathematical modelling to represent, analyse, make predictions, and provide insight into real-life situations

This overall expectation has no specific expectations. Mathematical modelling is an iterative and interconnected process that is applied to various contexts, allowing students to bring in learning from other strands. Students' demonstration of the process of mathematical modelling, as they apply concepts and skills learned in other strands, is assessed and evaluated.

Read more about the [mathematical modelling process](#).

Teacher supports

Key concepts

- The process of mathematical modelling requires: understanding the problem; analysing the situation; creating a mathematical model; and analysing and assessing the model.

Note

- A mathematical modelling task is different from a real-life application due to the cyclic nature of modelling, which involves examining a problem from outside mathematics, modelling it, and then checking the model against the real-life situation and adjusting as necessary.
- The process of mathematical modelling should not be confused with using a "model" to represent or solve a problem that does not require the whole process.
- Mathematical modelling tasks can be utilized in many ways and can support students with making connections among many mathematical concepts across the math strands and across other curricula.

D. Data

Overall expectations

By the end of Grade 3, students will:

D1. Data Literacy

manage, analyse, and use data to make convincing arguments and informed decisions, in various contexts drawn from real life

Specific expectations

By the end of Grade 3, students will:

D1.1 Data Collection and Organization

sort sets of data about people or things according to two and three attributes, using tables and logic diagrams, including Venn, Carroll, and tree diagrams, as appropriate

Teacher supports

Key concepts

- Data can be sorted in more than one way.
- Two-way tables are used to sort data into all of the possible combinations for the characteristics of two attributes.
- A three-circle Venn diagram can be used to sort data based on three characteristics (e.g., red, large, stripes) for three attributes (e.g., colour, size, markings).
- A Carroll diagram can be used to sort data into complementary sets for two characteristics (e.g., red – not red, stripes – no stripes) for two attributes (e.g., colour, markings).
- A tree diagram can be used to sort data into all the possible combinations of characteristics for two or more attributes (e.g., red stripes, red dots, blue stripes, blue dots, green stripes, green dots).

Note

- A variable is any attribute, number, or quantity that can be measured or counted.
- The number of possible combinations of categories can be determined by multiplying together the number of possibilities for each attribute (variable) under consideration. For example, there are 24 possible combinations for four shapes – circle, rectangle, triangle, hexagon combined with three colours – red, blue, green and combined with two sizes – large, not large (i.e., $4 \times 3 \times 2 = 24$).

D1.2 Data Collection and Organization

collect data through observations, experiments, and interviews to answer questions of interest that focus on qualitative and quantitative data, and organize the data using frequency tables

Teacher supports

Key concepts

- The type and amount of data to be collected is based on the question of interest.
- Data can either be qualitative (e.g., colour, type of pet) or quantitative (e.g., number of pets, height).
- Data can be collected through observations, experiments, interviews, or written questionnaires over a period of time.
- Frequency tables are an extension of tally tables, in which the tallies are counted and represented as numerical values for each category.

Note

- In the primary grades, students are collecting data from a small population (e.g., objects in a container, the days in a month, students in Grade 3).
- When students are dealing with a lot of categories for data involving two attributes, one strategy is to reorganize the categories into their complements and use a Carroll diagram to organize the data.

D1.3 Data Visualization

display sets of data, using many-to-one correspondence, in pictographs and bar graphs with proper sources, titles, and labels, and appropriate scales

Teacher supports

Key concepts

- The order of the categories in graphs does not matter for qualitative data (i.e., the categories can be arranged in any order).
- The categories for pictographs and bar graphs can be drawn either horizontally or vertically.
- Graphing data using many-to-one correspondence provides a way to show large amounts of data within a reasonable view and is indicated by the scale of the frequency on the bar graph and the key for a pictograph.
- The source, titles, and labels provide important information about data in a graph or table:
 - The source indicates where the data was collected.
 - The title introduces the data contained in the graph or table.
 - Labels provide additional information, such as the labels on the axes of a graph that describe what is being measured (the variable).

Note

- Have students use scales of 2, 5, and 10 to apply their understanding of multiplication facts for 2, 5 and 10.

D1.4 Data Analysis

determine the mean and identify the mode(s), if any, for various data sets involving whole numbers, and explain what each of these measures indicates about the data

Teacher supports

Key concepts

- Modes can be identified for qualitative and quantitative data. A variable can have one, none, or multiple modes.
- The mean can only be determined for quantitative data. The mean of a variable can be determined by dividing the sum of the data values by the total number of values in the data set.
- Depending on the data set, the mean and the mode may be the same value.

Note

- The mean and the mode are two of the three measures of central tendency. The median is the third measure and is introduced in Grade 4.
- The mean is often referred to as the average. Support students with conceptually understanding the mean by decomposing and recomposing the values in the data set so that all values are the same.

D1.5 Data Analysis

analyse different sets of data presented in various ways, including in frequency tables and in graphs with different scales, by asking and answering questions about the data and drawing conclusions, then make convincing arguments and informed decisions

Teacher supports

Key concepts

- Different representations are used for different purposes to convey different types of information.
- Frequency tables show numerically how often an item or value occurs in a set of data. They are quicker and easier to read than tallies.

- Graphs of quantitative data show the distribution and the shape of the data. For example, the data on a vertical bar graph may be skewed to the left, skewed to the right, centered, or equally distributed among all of the categories.
- It is important to pay attention to the scale on pictographs and other graphs. If the scale on a pictograph is that one picture represents 2 students, then the frequency of a category is double what is shown.
- Data that is presented in tables and graphs can be used to ask and answer questions, draw conclusions, and make convincing arguments and informed decisions.
- Questions of interest are intended to be answered through the analysis of the representations. Sometimes the analysis raises more questions that require further collection, representation, and analysis of data.

Note

- There are three levels of graph comprehension that students should learn about and practise:
 - Level 1: information is read directly from the graph and no interpretation is required.
 - Level 2: information is read and used to compare (e.g., greatest, least) or perform operations (e.g., addition, subtraction).
 - Level 3: information is read and used to make inferences about the data using background knowledge of the topic.
- Analysing data can be complex, so it is important to provide students with strategies that will support them to build these skills.

D2. Probability

describe the likelihood that events will happen, and use that information to make predictions

Specific expectations

By the end of Grade 3, students will:

D2.1 Probability

use mathematical language, including the terms “impossible”, “unlikely”, “equally likely”, “likely”, and “certain”, to describe the likelihood of events happening, and use that likelihood to make predictions and informed decisions

Teacher supports

Key concepts

- The likelihood of an event occurring can be represented along a continuum from impossible to certain with benchmarks in between of unlikely, equally likely, and likely.
- "Equally likely" is sometimes thought of as an equal chance of events happening, such as rolling a 4 on a die or rolling a 6.
- Understanding likelihood can help with making predictions about future events.

Note

- Students' ability to make predictions depends on an informal understanding of concepts related to possible outcomes, randomness, and independence of events. (These terms are for teacher reference only; students are not expected to use or define these terms.)
 - Possible outcomes: To make a prediction in a situation of chance, it is necessary to know all possible outcomes. For example, when drawing a cube from a bag containing red, blue, and yellow cubes, a possible outcome is a yellow cube, whereas an impossible outcome is a green cube.
 - Randomness: A random event is not influenced by any factors other than chance. For example, when a regular die is rolled, the result showing any number from 1 to 6 is entirely by chance and each roll has an equal chance of happening.
 - The independence of an event is connected to whether or not the outcome of that event is influenced by another event. For example, if you throw a dice two times, the outcome of the first toss does not impact the second toss.

D2.2 Probability

make and test predictions about the likelihood that the mean and the mode(s) of a data set will be the same for data collected from different populations

Teacher supports

Key concepts

- Data can vary from one population to another.
- If two populations are similar, the modes for the two data sets will more than likely be the same and the means will be relatively close.
- Data can be used to make predictions that are not based on personal feelings or opinions alone.

Note

- In the primary grades, students are collecting data from a small population. A population is the total number of individuals or items that fit a particular description (e.g., the days in a month, cubes in a container, students in Grade 3).
- In order to do an accurate comparison, it is important to survey the same number of individuals or items in the different populations.

E. Spatial Sense

Overall expectations

By the end of Grade 3, students will:

E1. Geometric and Spatial Reasoning

describe and represent shape, location, and movement by applying geometric properties and spatial relationships in order to navigate the world around them

Specific expectations

By the end of Grade 3, students will:

E1.1 Geometric Reasoning

sort, construct, and identify cubes, prisms, pyramids, cylinders, and cones by comparing their faces, edges, vertices, and angles

Teacher supports

Key concepts





- Three-dimensional objects have attributes that allow them to be identified, compared, sorted, and classified.
- Geometric properties are attributes that are the same for an entire group of three-dimensional objects. Some attributes are relevant for classifying objects by geometry. Others are not. For example, colour and size are attributes but are *not* relevant for geometry since there are large cubes, small cubes, blue cubes, and yellow cubes. Having six congruent faces, where each side is a square, is an attribute *and* a geometric property because all cubes, by definition, have this property.

- When sorting and building objects, some of the attributes that are useful to name and notice are the number and shape of the faces, the number of edges, and the number of vertices and angles.
- When three-dimensional objects are sorted by geometric properties or categories, classes emerge. Each class of three-dimensional object has common geometric properties, and these properties are unaffected by the size or orientation of an object.

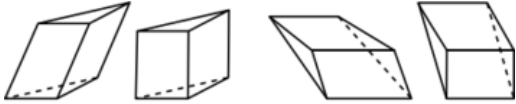
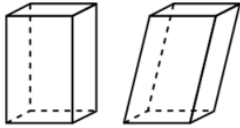
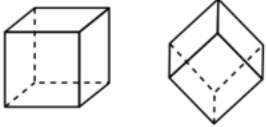
Note

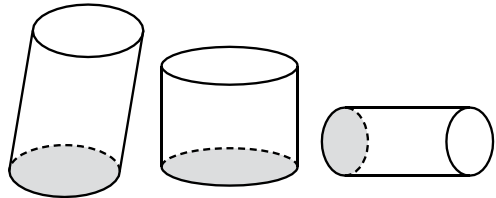
- Constructing three-dimensional objects highlights the geometric properties of an object. Properties can be used as a “rule” for constructing a certain class of objects.
- The following table lists properties of some common three-dimensional objects.

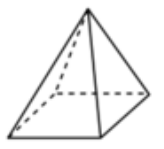
<p>Prisms</p>	<ul style="list-style-type: none"> • Prisms have two congruent, polygon faces. These faces form the base of the prism. (Note that the base may or may not be the “bottom” of the prism). • The two bases are connected by rectangles or parallelograms of the same height (e.g., the bases are parallel). • A prism is named by the shape of its base. For example, triangle-based prisms have two bases that are triangles, which are connected by rectangles or parallelograms. 	 <p>Triangle-Based Prisms</p>  <p>Rectangle-Based Prisms</p>
<p>Cubes</p>	<ul style="list-style-type: none"> • Cubes have six congruent faces and each face is a square. • Because cubes have all the properties of a prism, they can also be called square-based prisms. 	 <p>Cubes or Square-Based Prisms</p>

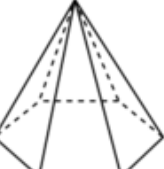
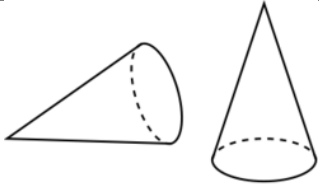
<p>Cylinders</p>	<ul style="list-style-type: none"> • Cylinders have two congruent bases; straight lines of equal length can be drawn that join one base to the other. • Cylinders are named by the shape of their base. For example, a tin can is a circular cylinder. 	
<p>Pyramids</p>	<ul style="list-style-type: none"> • Pyramids have a single polygon for a base. • Triangles join each side of the base and meet at a vertex called the apex. • A pyramid is named by the shape of its base. For example, a square-based pyramid has a square for its base and four triangular faces. 	<p style="text-align: center;">Pyramids</p> <div style="display: flex; justify-content: space-around;"> <div style="text-align: center;">  Triangle-Based Pyramid </div> <div style="text-align: center;">  Square-Based Pyramid </div> </div> <div style="display: flex; justify-content: space-around; margin-top: 20px;"> <div style="text-align: center;">  Pentagon-Based Pyramid </div> <div style="text-align: center;">  Hexagon-Based Pyramid </div> </div>
<p>Cones</p>	<ul style="list-style-type: none"> • Cones have one base; straight lines can be drawn from any point on the base's edge to its top point, called its apex. • Cones are named by the shape of their base. For example, an ice cream cone is a circular cone. 	 <p style="text-align: center;">Cones</p>

E1.2 Geometric Reasoning

compose and decompose various structures, and identify the two-dimensional shapes and three-dimensional objects that these structures contain

Teacher supports

Key concepts

- Structures are composed of three-dimensional objects with faces that are two-dimensional shapes. Recognizing and describing the shapes and objects in three-dimensional structures provides insight into how structures are built.

- Objects and structures can be decomposed physically and visually (e.g., using the “mind’s eye”). Visualization is an important skill to develop.
- Triangles are useful for strengthening and stabilizing a structure; rectangular prisms are commonly used because of their ability to be stacked. This expectation is closely related to the strand Understanding Structures and Mechanisms, Grade 3 expectations 3.1–3.10, in *The Ontario Curriculum, Grades 1-8: Science and Technology, 2007*.

E1.3 Geometric Reasoning

identify congruent lengths, angles, and faces of three-dimensional objects by mentally and physically matching them, and determine if the objects are congruent

Teacher supports

Key concepts

- Congruence is a relationship between three-dimensional objects that have the same shape and the same size. Congruent three-dimensional shapes match every face exactly, in the exact same position.
- Checking for congruence is closely related to measurement. Side lengths and angles can be *directly compared* by matching them, one against the other. They can also be measured.
- Two objects that are not congruent can still have specific elements that are congruent. For example, two objects might have a face that is congruent (i.e., the face is the same size and shape), but if the other faces are different in any way (e.g., the faces have different angles or side lengths), then the two objects are not congruent. Likewise, even if all faces are congruent but they are in a different arrangement, the two objects would not be congruent because they would not be the exact same shape.

Note

- The skill of visualizing congruent objects – mentally manipulating and matching objects to predict congruence – can be developed through hands-on experience.

E1.4 Location and Movement

give and follow multistep instructions involving movement from one location to another, including distances and half- and quarter-turns

Teacher supports

Key concepts

- Instructions to move from one location to another location requires information about direction and distance from a given location.
 - Numbers and units describe distance (e.g., 5 steps; 3 kilometres).
 - Absolute direction can be conveyed using cardinal language (i.e., N, S, E, W), which were introduced in Grade 2 to locate selected communities, countries, and/or continents on a map (See *The Ontario Curriculum: Social Studies, Grades 1 to 6; History and Geography, Grades 7 and 8, 2018, Grade 2, B3.3*).
 - Relative direction can be conveyed using qualitative language (*right, left, forward, backward, up, down*).
 - Relative direction can be quantified and made more precise by describing the amount of turn.
- The amount of a turn involves the measure of angles, a skill that is more formally developed in Grades 4 and 5. In Grade 3, the language of half- and quarter-turn parallels the minute hand of an analog clock. A turn may be clockwise (moving in the same direction as the hands of a clock) or counterclockwise (the opposite direction from the hands of a clock).
 - A full turn is a full circle that results in an object facing in the same direction (e.g., start at 12 o'clock, end at 12 o'clock). A full turn clockwise or counterclockwise produces the same result.
 - A half-turn results in an object facing the opposite direction, (e.g., start at 12 o'clock, end at 6 o'clock). A half-turn clockwise or counterclockwise produces the same result.

A quarter-turn results in an object facing either 9 o'clock or 3 o'clock, (i.e., start at 12 o'clock, and go a quarter-turn right, and end at 3 o'clock, or go a quarter-turn left, and end at 9 o'clock).

E2. Measurement

compare, estimate, and determine measurements in various contexts

Specific expectations

By the end of Grade 3, students will:

E2.1 Length, Mass, and Capacity

use appropriate units of length to estimate, measure, and compare the perimeters of polygons and curved shapes, and construct polygons with a given perimeter

Teacher supports

Key concepts

- Perimeter is the total length or distance around an object or region. A perimeter measurement is a length measurement.
- If a perimeter is made up of straight lines, the parts are measured with a ruler and the measurements are combined. This is an application of the additivity property.
- Curved perimeters are difficult to measure accurately with a ruler. A “go-between”, like a string, is used to match the perimeter of the object and then measured. The measurement of the go-between is used as the measurement of the perimeter. This is an application of the transitivity property.
- Different shapes can have the same perimeter. A shape with a perimeter of 20 cm could be a 5 cm by 5 cm square, a skinny rectangle that is 2 cm by 8 cm, or a completely curved shape. To construct a shape with a given perimeter, the amount of length must always be tracked so that the remaining length can be distributed appropriately around the rest of the shape.
- Measurements of continuous quantities, like length, are always approximate. The smaller the unit, the greater the potential accuracy. If different-sized units are used to measure an object, each unit is counted and tracked separately.
- Because measurements are approximate, a combination of units might be used for greater accuracy (e.g., a combination of centimetres and millimetres for a length between 5 cm and 6 cm).
- The appropriate unit of length depends on the reason for measuring an object. Larger units are used for approximate measurements; smaller units are used for precise measurements and detailed work. While non-standard units are appropriate for quick, personal measurements, standard units are used when communicating measurements.

Note

- In Grade 3, students should not use decimals in their measurements.

E2.2 Length, Mass, and Capacity

explain the relationships between millimetres, centimetres, metres, and kilometres as metric units of length, and use benchmarks for these units to estimate lengths

Teacher supports

Key concepts

- Millimetres, centimetres, metres, and kilometres are standard metric units of length. The metre is the metric standard or base unit of length.
 - 1 metre is equal to 100 centimetres or 1000 millimetres.
 - 1000 metres is 1 kilometre long.
- For convenience, there are symbols for metric units: millimetre (mm), centimetre (cm), metre (m), kilometre (km).
- Standard and non-standard units are equally accurate (provided that the measurement itself is carried out well). However, *standard* units allow people to communicate distances and lengths with others in ways that are consistently understood. Metric units are the standard for all but three countries in the world and are the focus of this expectation.
- The metric system is universally used by scientists because it uses standard prefixes which helps understanding of measurements and conversions.

Note

- Canada officially adopted the metric system in 1970, through the Weights and Measures Act. This act was amended in 1985 to allow Canadians to use a combination of metric and imperial units (called “Canadian” units in the [Weights and Measures Act](#)). In addition to metric units, other common standard units of length are inches, feet, yards, and miles. The process for measuring length with imperial units is the same as for using metric and non-standard units. Only the length of the unit and the measuring tools differ.

E2.3 Length, Mass, and Capacity

use non-standard units appropriately to estimate, measure, and compare capacity, and explain the effect that overfilling or underfilling, and gaps between units, have on accuracy

Teacher supports

Key concepts

- Capacity is the amount a container can hold. It can be directly compared by pouring the contents of one container into another.
- Similar to measuring length, capacity can be quantified and measured by determining how many equal-sized units something holds. Using units supports moving from comparison questions (Which holds more?) to measurement questions (How much? How much more?).
- To directly measure the capacity of an object:
 - choose a unit of capacity (e.g., the capacity of a container lid or a paper cup);
 - repeat (iterate) the unit without overfilling or underfilling it (e.g., filling a unit with marbles creates more gaps than using rice, sand, or water);
 - count how many units it takes to fill the container completely (i.e., without overfilling or underfilling the container).
- If different-sized units are used to fill an object more completely, each unit is counted and tracked separately.

Note

- In Grade 3, students are not using decimals in their measurements.

E2.4 Length, Mass, and Capacity

compare, estimate, and measure the mass of various objects, using a pan balance and non-standard units

Teacher supports

Key concepts

- Mass is the amount of matter in an object. Objects with more mass have more weight.

- Although the weight of an object may vary in different locations, its mass is constant. For example, the weight of an object on Jupiter is more than it is on Earth because weight is affected by gravity, but the mass of the object is the same in both places.
- Mass is quantified and measured by using units of mass and finding out how many units it takes to match the mass of the object. Any collection of uniform objects with the same amount of mass can serve as a unit of mass. Units enable a move from comparison questions (Which is heavier?) to measurement questions (How much heavier?).
- Two-pan balance scales or spring scales are used to indirectly compare and measure the mass of an object.
 - Before measuring, ensure that the two pans on the balance are “balanced” or the spring scale is set to start at zero. This is equivalent to eliminating gaps or overlaps when measuring other attributes.
 - For a balance scale, place the object on one pan and add units of mass to the other pan until the two pans balance.
 - For spring scales, place the object on the spring scale and record the distance the spring scale moves; remove the object and replace it with just enough units of mass to pull the spring down the same distance.
 - Count how many units it takes to match the object.
- If different-sized units are used to match an object’s mass more exactly, each unit is counted and tracked separately. For example, if 5 small washers equal 1 large washer, then 2 large washers and 3 small washers could be written as $2\frac{3}{5}$ large washers.

E2.5 Length, Mass, and Capacity

use various units of different sizes to measure the same attribute of a given item, and demonstrate that even though using different-sized units produces a different count, the size of the attribute remains the same

Teacher supports

Key concepts

- Measurement is more than a count; it is a spatial comparison. Units enable a spatial comparison to be quantified.
- How much length, mass, area, or capacity an object has remains constant unless the object itself has been changed (conservation principle). An amount is not changed by

measuring with different units; only the count of units changes. Using smaller units produces a greater count than using larger units (inverse relationship).

E2.6 Time

use analog and digital clocks and timers to tell time in hours, minutes, and seconds

Teacher supports

Key concepts

- Clocks can answer two questions: “What time is it?” and “How much time has passed?”. The focus in Grade 3 is on the first question.
- A colon (:) is used to separate units of time. Generally, time is read in hours and minutes, so 12:36 means 36 minutes after 12:00. To describe time more precisely, another colon is used to show seconds, so 12:36:15 means it is 15 seconds after 12:36.
- Analog clocks use fractions of a circle to provide benchmark times: quarter past the hour; half past the hour; and quarter to the hour. Benchmark times are not evident in digital clocks.
- Analog clocks have a face with three different scales. Navigating these scales can make reading an analog clock challenging.
 - The shorter hour hand (0 to 12, numbered scale) measures broad approximate time.
 - The longer minute hand (0 to 60, unnumbered markings) measures time more precisely.
 - The optional second hand (same 0 to 60 scale as that used by the minute hand) is used for precise time.
- The 24-hour clock is widely used in transportation schedules and in the military. For many parts of the world, it is the standard way of describing time.

Note

- Digital clocks are easier to read but may be more challenging to understand. To know that 9:58 is almost 10:00 requires an understanding that there are 60 minutes in an hour. This is unlike the place-value system, which moves in groups of 10 and 100. Using both digital and analog clocks helps make the 0 to 60 scale visible.

E2.7 Area

compare the areas of two-dimensional shapes by matching, covering, or decomposing and recomposing the shapes, and demonstrate that different shapes can have the same area

Teacher supports

Key concepts

- Area is the amount of surface or space inside a two-dimensional region. An area can be directly compared to another area by covering and matching the areas to determine which is larger.
- The same area can take the form of an infinite number of shapes.
- To better compare two areas, an area can be decomposed and “re-shaped” to make covering and matching easier. If the amount of an area doesn’t change, the comparison is valid.

E2.8 Area

use appropriate non-standard units to measure area, and explain the effect that gaps and overlaps have on accuracy

Teacher supports

Key concepts

- Units quantify comparisons and are used to change comparison questions (e.g., Which is longer?) into measurement questions (e.g., How long and how much longer?). A unit of area is used to measure area.
- A unit of area is an amount of area. It is not a shape. Two different shapes, if they have the same area, can represent the same unit.
- Area is measured by counting how many units of area it takes to cover (tile) a surface without gaps or overlaps.
- Gaps between units produce an underestimate, and overlaps produce an overestimate. Both affect the accuracy of the count.
- Units of area can be decomposed, rearranged, and redistributed to better cover an area and minimize gaps or overlaps. If the amount of area is preserved, the unit is constant, regardless of its form.
- Choosing an appropriate object or shape to represent a unit of area is an important decision when measuring area. The object must:

- tile a surface without gaps or overlaps;
- retain a constant area;
- be able to be decomposed and rearranged as necessary.

E2.9 Area

use square centimetres (cm^2) and square metres (m^2) to estimate, measure, and compare the areas of various two-dimensional shapes, including those with curved sides

Teacher supports

Key concepts

- Squares tile a grid without gaps or overlaps and are the conventional shape used to describe units of area. A square with a side length of 1 unit (i.e., a unit square) has 1 square unit of area. Any standard unit of length (i.e., metric or imperial) can produce a standard unit of area.
- Square centimetres and square metres are standard metric units of area.
 - A square with dimensions $1 \text{ cm} \times 1 \text{ cm}$ has an area of one square centimetre (1 cm^2).
 - A square with dimensions $1 \text{ m} \times 1 \text{ m}$ has an area of 1 square metre (1 m^2).
 - Square centimetres and square metres are amounts of area. Although they both “start out” as squares, they can come in any shape.
- Area is measured by counting the number of full or partial units needed to cover a surface. For example, a surface that is completely covered by eighteen 1-unit squares has an area of 18 square units.

Note

- Since the same unit of area can come in any shape, objects used to represent these units may need to be decomposed, rearranged, and redistributed to better cover an area and minimize gaps and overlaps.
- Shapes chosen to represent square centimetres and square metres must retain a constant area, even if they are rearranged into a different shape or form. Tracking the count of partial units and combining partial units into whole units ensures that the measurement is as accurate as possible.
- If students are using a three-dimensional object to determine the area of another shape, they should pay attention to the area of the face that they are using to measure with.

F. Financial Literacy

Overall expectations

By the end of Grade 3, students will:

F1. Money and Finances

demonstrate an understanding of the value and use of Canadian currency

Specific expectations

By the end of Grade 3, students will:

F1.1 Money Concepts

estimate and calculate the change required for various simple cash transactions involving whole-dollar amounts and amounts of less than one dollar

Teacher supports

Key concepts

- Addition and subtraction skills can be applied to estimate and calculate change during simple cash transactions.

Note

- Real-life contexts build understanding of simple cash transactions while developing proficiency with addition, subtraction, mental math strategies, and math facts.
- Tasks involving only whole-dollar amounts support an understanding of place value. (The concept of place value up to hundredths is not addressed until Grade 5.)

Mathematics, Grade 4

Expectations by strand

A. Social-Emotional Learning (SEL) Skills in Mathematics and the Mathematical Processes

This strand focuses on students' development and application of social-emotional learning skills to support their learning of math concepts and skills, foster their overall well-being and ability to learn, and help them build resilience and thrive as math learners. As they develop SEL skills, students demonstrate a greater ability to understand and apply the mathematical processes, which are critical to supporting learning in mathematics. In all grades of the mathematics program, the learning related to this strand takes place in the context of learning related to all other strands, and it should be assessed and evaluated within these contexts.

Overall expectations

Throughout this grade, in order to promote a positive identity as a math learner, to foster well-being and the ability to learn, build resilience, and thrive, students will:

A1. Social-Emotional Learning (SEL) Skills and the Mathematical Processes

apply, to the best of their ability, a variety of social-emotional learning skills to support their use of the mathematical processes and their learning in connection with the expectations in the other five strands of the mathematics curriculum

To the best of their ability, students will learn to:	... as they apply the mathematical processes :	... so they can:
1. identify and manage emotions	<ul style="list-style-type: none"> • problem solving: develop, select, and apply problem-solving strategies • reasoning and proving: develop and apply reasoning skills (e.g., classification, recognition of relationships, use of counter-examples) to justify thinking, make and investigate conjectures, and construct and defend arguments 	1. express and manage their feelings, and show understanding of the feelings of others, as they engage positively in mathematics activities
2. recognize sources of stress and cope with challenges	<ul style="list-style-type: none"> • reflecting: demonstrate that as they solve problems, they are pausing, looking back, and monitoring their thinking to help clarify their understanding (e.g., by comparing and adjusting strategies used, by explaining why they think their results are reasonable, by recording their thinking in a math journal) 	2. work through challenging math problems, understanding that their resourcefulness in using various strategies to respond to stress is helping them build personal resilience
3. maintain positive motivation and perseverance	<ul style="list-style-type: none"> • connecting: make connections among mathematical concepts, procedures, and representations, and relate mathematical ideas to other contexts (e.g., other curriculum areas, daily life, sports) 	3. recognize that testing out different approaches to problems and learning from mistakes is an important part of the learning process, and is aided by a sense of optimism and hope
4. build relationships and communicate effectively	<ul style="list-style-type: none"> • communicating: express and understand mathematical thinking, and engage in mathematical arguments using everyday language, language resources as necessary, appropriate mathematical terminology, a variety of representations, and mathematical conventions 	4. work collaboratively on math problems – expressing their thinking, listening to the thinking of others, and practising inclusivity – and in that way fostering healthy relationships
5. develop self-awareness and sense of identity	<ul style="list-style-type: none"> • representing: select from and create a variety of representations of mathematical ideas (e.g., 	5. see themselves as capable math learners, and strengthen their sense of ownership of their learning, as part of their emerging sense of identity and belonging

6. think critically and creatively	representations involving physical models, pictures, numbers, variables, graphs), and apply them to solve problems <ul style="list-style-type: none"> • selecting tools and strategies: select and use a variety of concrete, visual, and electronic learning tools and appropriate strategies to investigate mathematical ideas and to solve problems 	6. make connections between math and everyday contexts to help them make informed judgements and decisions
------------------------------------	--	--

B. Number

Overall expectations

By the end of Grade 4, students will:

B1. Number Sense

demonstrate an understanding of numbers and make connections to the way numbers are used in everyday life

Specific expectations

By the end of Grade 4, students will:

B1.1 Whole Numbers

read, represent, compose, and decompose whole numbers up to and including 10 000, using appropriate tools and strategies, and describe various ways they are used in everyday life

Teacher supports

Key concepts

- Reading numbers involves interpreting them as a quantity when they are expressed in words, in standard notation, or represented using physical objects or diagrams.
- The numerals 0 to 9 are used to form numbers. They are referred to as the digits in a number and each digit corresponds to a place value. For example, in the number 4107, the digit 4 represents 4 thousands, the digit 1 represents 1 hundred, the digit 0 represents 0 tens, and the digit 7 represents 7 ones.

- There are patterns in the way numbers are formed. Each place value column repeats the 0 to 9 counting sequence. Any quantity, no matter how great, can be described in terms of its place value.
- A number can be represented in expanded form (e.g., $4187 = 4000 + 100 + 80 + 7$ or $4 \times 1000 + 1 \times 100 + 8 \times 10 + 7 \times 1$) to show place value relationships.
- Numbers can be composed and decomposed in various ways, including by place value.
- Numbers are composed when two or more numbers are combined to create a larger number. For example, 1300, 200, and 6 combine to make 1506.
- Numbers are decomposed when they are represented as a composition of two or more smaller numbers. For example, 5125 can be decomposed into 5000 and 100 and 25.
- Tools may be used when representing numbers. For example, 1362 may be represented as the sum of 136 ten-dollar bills and 1 toonie or 13 base ten flats, 6 base ten rods, and 2 base ten units.
- Numbers are used throughout the day, in various ways and contexts. Most often, numbers describe and compare quantities. They express magnitude and provide a way to answer questions such as “how much?” and “how much more?”.

Note

- Every strand of mathematics relies on numbers.
- When a number is decomposed and then recomposed, the quantity is unchanged. This is the conservation principle.
- There are non-standard but equivalent ways to decompose a number using place value, based on understanding the relationships between the place values. For example, 587 could be decomposed as 58 tens and 7 ones or decomposed as 50 tens and 87 ones, and so on.
- Composing and decomposing numbers in a variety of ways can support students in becoming flexible with their mental math strategies.
- Closed number lines with appropriate scales can be used to represent numbers as a position on a number line or as a distance from zero. Depending on the number, estimation may be needed to represent it on a number line.
- Partial number lines can be used to show the position of a number relative to other numbers.
- Open number lines can be used to show the composition of large numbers without drawing them to scale.
- It is important for students to understand key aspects of place value. For example:
 - The order of the digits makes a difference. The number 385 describes a different quantity than the number 853.
 - The *place* (or position) of a digit determines its *value* (*place value*). The 5 in 511, for example, has a value of 500, not 5. To determine the value of a digit in a number,

multiply the value of the digit by the value of its place. For example, in the number 5236, the 5 represents 5000 (5×1000) and the 2 represents 200 (2×100).

- A zero in a column indicates that there are no groups of that size in the number. It serves as a placeholder, holding the other digits in their correct “place”. For example, 189 means 1 hundred, 8 tens, and 9 ones, but 1089 means 1 thousand, 0 hundreds, 8 tens, and 9 ones.
- The value of the digits in each of the positions follows a “times 10” multiplicative pattern. For example, 500 is 10 times greater than 50, 50 is 10 times greater than 5, and 5 is 10 times greater than 0.5.
- Going from left to right, a “hundreds-tens-ones” pattern repeats within each period (ones, thousands, millions, billions, and so on). Exposure to this larger pattern and the names of the periods – into millions and beyond – satisfies a natural curiosity around “big numbers”, although students at this grade do not need to work beyond thousands.

Place Value Patterns

one billions	hundred millions	ten millions	one millions	hundred thousands	ten thousands	one thousands	hundreds	tens	ones

B1.2 Whole Numbers

compare and order whole numbers up to and including 10 000, in various contexts

Teacher supports

Key concepts

- Numbers are compared and ordered according to their “how muchness” or magnitude.
- Numbers with the same units can be compared directly (e.g., 7645 kilometres compared to 6250 kilometres). Numbers that do not show a unit are assumed to have units of ones (e.g., 75 and 12 are considered as 75 ones and 12 ones).
- Sometimes numbers without the same unit can be compared, such as 625 kilometres and 75 metres. Knowing that the unit “kilometres” is greater than the unit “metres”, and knowing that 625 is greater than 75, one can infer that 625 kilometres is a greater distance than 75 metres.
- Benchmark numbers can be used to compare quantities. For example, 4132 is less than 5000 and 6200 is greater than 5000, so 4132 is less than 6200.
- Numbers can be compared by their place value. For example, when comparing 8250 and 8450, the greatest place value where the numbers differ is compared. For this example, 2

hundreds (from 8250) and 4 hundreds (from 8450) are compared. Since 4 hundreds is greater than 2 hundreds, 8450 is greater than 8250.

- Numbers can be ordered in ascending order – from least to greatest – or can be ordered in descending order – from greatest to least.

Note

- An understanding of place value enables whole numbers to be compared and ordered. There is a stable order to how numbers are sequenced, and patterns exist within this sequence that make it possible to predict the order of numbers and make comparisons.

B1.3 Whole Numbers

round whole numbers to the nearest ten, hundred, or thousand, in various contexts

Teacher supports

Key concepts

- Rounding numbers is often done to estimate a quantity or measure, estimate the results of a computation, and make quick comparisons.
- Rounding involves making decisions about what level of precision is needed, and is used often in measurement. How close a rounded number is to the actual amount depends on the unit it is being rounded to. The result of rounding a number to the nearest ten is closer to the original number than the result of rounding the same number to the nearest hundred. Similarly, the result of rounding a number rounded to the nearest hundred is closer to the original number than the result of rounding the same number to the nearest thousand. The larger the unit, the broader the approximation; the smaller the unit, the more precise.
- Whether a number is rounded up or down depends on the context. For example, when paying by cash in a store, the amount owing is rounded to the nearest five cents (or nickel).
- In the absence of a context, numbers are typically rounded on a midpoint. This approach visualizes the amount that is halfway between two units and determines whether a number is closer to one unit than the other.
 - Rounding 1237 to the nearest 10 becomes 1240, since 1237 is closer to 1240 than 1230.
 - Rounding 1237 to the nearest 100 becomes 1200, since 1237 is closer to 1200 than 1300.

- Rounding 1237 to the nearest 1000 becomes 1000, since 1237 is closer to 1000 than 2000.
- If a number is exactly on the midpoint, convention rounds the number up (unless the context suggests differently). So, 1235 rounded to the nearest 10 becomes 1240.

B1.4 Fractions and Decimals

represent fractions from halves to tenths using drawings, tools, and standard fractional notation, and explain the meanings of the denominator and the numerator

Teacher supports

Key concepts

- A fraction is a number that tells us about the relationship between two quantities.
- A fraction can represent a quotient (division).
 - It shows the relationship between the number of wholes (numerator) and the number of partitions the whole is being divided into (denominator).
 - For example, 3 granola bars (3 wholes) are shared equally with 4 people (number of partitions), which can be expressed as $\frac{3}{4}$.
- A fraction can represent a part of a whole.
 - It shows the relationship between the number of parts selected (numerator) and the total number of parts in one whole (denominator).
 - For example, if 1 granola bar (1 whole) is partitioned into 4 pieces (partitions), each piece is one fourth ($\frac{1}{4}$) of the granola bar. Two pieces are 2 one fourths ($\frac{2}{4}$) of the granola bar, three pieces are three one fourths ($\frac{3}{4}$) of the granola bar, and four pieces are four one fourths ($\frac{4}{4}$) of the granola bar.
- A fraction can represent a comparison.
 - It shows the relationship between two parts of the same whole. The numerator is one part and the denominator is the other part.
 - For example, a bag has 3 red beads and 2 yellow beads. The fraction $\frac{2}{3}$ represents that there are two thirds as many yellow beads as red beads. The fraction $\frac{3}{2}$, which

is $1\frac{1}{2}$ as a mixed number, represents that there are 1 and one half times more red beads than yellow beads.

- A fraction can represent an operator.
 - When considering fractions as an operator, the fraction increases or decrease by a factor.
 - For example, in the case of $\frac{3}{4}$ of a granola bar, $\frac{3}{4}$ of \$100, or $\frac{3}{4}$ of a rectangle, the fraction reduces the original quantity to $\frac{3}{4}$ its original size.

Note

- A fraction is a number that can tell us information about the relationship between two quantities. These two quantities are expressed as parts and wholes in different ways, depending on the way the fraction is used.
 - $\frac{3}{4}$ as a quotient ($3 \div 4$): 3 represents three wholes divided into 4 equal parts (wholes to parts relationship).
 - $\frac{3}{4}$ as a part of a whole: 3 is representing the number of parts selected from a whole that has been partitioned into 4 equal parts (parts to a whole relationship).
 - $\frac{3}{4}$ as a comparison: 3 parts of a whole compared to 4 parts of the same whole (parts to parts of the same whole relationship).
- A fraction is an operator when one interprets a fraction relative to a whole. For example, each person gets three fourths of a granola bar, or three one fourths of the area is shaded.

B1.5 Fractions and Decimals

use drawings and models to represent, compare, and order fractions representing the individual portions that result from two different fair-share scenarios involving any combination of 2, 3, 4, 5, 6, 8, and 10 sharers

Teacher supports

Key concepts

- Fair sharing means that quantities are shared equally. For a whole to be shared equally, it must be partitioned in such a way that each sharer receives the same amount.

- Fair-share or equal-share problems can be represented using various models. The choice of model may be influenced by the context of the problem. For example,
 - A set model may be chosen when the problem is dealing with objects such as beads or sticker books. The whole may be the entire set or each item in the set.
 - A linear model may be chosen when the problem is dealing with things involving length, like the length of a ribbon or the distance between two points.
 - An area model may be chosen when the problem is dealing with two-dimensional shapes like a garden plot or a flag.
- Fractions that are based on the same whole can be compared by representing them using various tools and models. For example, if an area model is chosen, then the area that the fractions represent are compared. If a linear model is chosen, then the lengths that the fractions represent are compared.
- Ordering fractions requires an analysis of the fractional representations. For example, when using an area model, the greater fraction covers the most area. If using a linear model, the fraction with the larger length is the greater fraction.

Note

- Words can have multiple meanings. It is important to be aware that in many situations, fair does not mean equal, and equal is not equitable. Educators should clarify how they are using the term "fair share" and ensure that students understand that in the math context fair means equal and the intent behind such math problems is to find equal amounts.
- Fair-share or equal-share problems provide a natural context for students to encounter fractions and division. Present these problems in the way that students will best connect to.
- Different modes and tools can be used to represent fractions:
 - Set models include collections of objects (e.g., beads in a bag, stickers in a sticker book), where each object is considered an equal part of the set. The attributes of the set (e.g., colour, size, shape) may or not be considered. Either each item in the set can be considered one whole or the entire set can be considered as the whole, depending on the context of the problem. If the entire set is the whole it will be important that the tool used can be easily partitioned. For example, concrete pattern blocks are difficult to partition; however, paper pattern blocks could be cut.
 - Linear models include number lines, the length of relational rods, and line segments. It is important for students to know the difference between $\frac{3}{4}$ of a line segment and $\frac{3}{4}$ as a position on a number line. Three fourths of a line segment treats the fraction as an operator and the whole is represented by the entire length

of the line segment; for example, if the whole line segment represents 8 apples, then $\frac{3}{4}$ would be positioned at the 6. Three fourths as a position on a number line treats the fraction as a part-whole relationship where the number 1 on the number line is 1 whole, the number 2 on the number line is 2 wholes, and so on. So as a position, $\frac{3}{4}$ is located three fourths of the way from 0 to 1.

- Other measurement models include area, volume, capacity, and mass. Area is the most common model used with shapes like rectangles and circles. Circles are difficult to partition when the fractions are not halves, fourths, or eighths, so providing models of partitioned circles is imperative. Making connections to the analog clock may also be helpful; for example, $\frac{1}{4}$ past the hour.

B1.6 Fractions and Decimals

count to 10 by halves, thirds, fourths, fifths, sixths, eighths, and tenths, with and without the use of tools

Teacher supports

Key concepts

- To count by a fractional amount is to count by a unit fraction. For example, when counting by the unit fraction one third, the sequence is: 1 one third, 2 one thirds, 3 one thirds, and so on. Counting by unit fractions can reinforce that the numerator is actually counting units. A fractional count equivalent to the unit fraction makes one whole (e.g., 3 one thirds).
- A fractional count can exceed one whole. For example, 5 one thirds means that there is 1 whole (or 3 one thirds) and an additional 2 one thirds.
- The numerator of a fraction shows the count of units (the denominator).

Note

- Counting by the unit fraction with a visual representation can reinforce the relationship between the numerator and the denominator as parts of the whole. Fractions can describe amounts greater than 1 whole.
- The fewer partitions of a whole, the smaller the number of counts needed to make a whole. For example, it takes 3 counts of one third to make a whole, whereas it takes 5 counts of one fifth to make a whole.

- When the numerator is greater than the denominator (e.g., $\frac{5}{3}$), the fraction is called *improper* and can be written as a mixed number (in this case, $1\frac{2}{3}$). Understanding counts can support understanding the relationship between improper fractions and mixed numbers.
- Counting of unit fractions is implicitly the addition of unit fractions.

B1.7 Fractions and Decimals

read, represent, compare, and order decimal tenths, in various contexts

Teacher supports

Key concepts

- The place value of the first position to the right of the decimal point is tenths.
- Decimal tenths can be found in numbers less than 1 (e.g., 0.6) or more than 1 (e.g., 24.7).
- When representing a decimal tenth, the whole should also be indicated.
- Decimal tenths can be compared and ordered by visually identifying the size of the decimal number relative to 1 whole.
- Between any two consecutive whole numbers are other numbers. Decimal numbers are the way that the base ten number system shows these “in-between” numbers. For example, the number 3.6 describes a quantity between 3 and 4.
- As with whole numbers, a zero in a decimal indicates that there are no groups of that size in the number. So, 5.0 means there are 0 tenths. It is important that students understand that 5 and 5.0 represent the same amount and are equivalent.
- Writing zero in the tenths position can be an indication of the precision of a measurement (e.g., the length was exactly 5.0 cm, versus a measurement that may have been rounded to the nearest ones, such as 5 cm).
- Decimals are read in a variety of ways in everyday life. Decimals like 2.5 are commonly read as two point five; the decimal in baseball averages is typically ignored (e.g., a player hitting an average of 0.300 is said to be “hitting 300”). To reinforce the decimal’s connection to fractions, and to make evident its place value, it is highly recommended that decimals be read as their fraction equivalent. So, 2.5 should be read as “2 and 5 tenths”. The word “and” is used to separate the whole-number part of the number and the decimal part of the number.
- Many tools that are used to represent whole numbers can be used to represent decimal numbers. It is important that 1 whole be emphasized to see the representation in tenths

and not as wholes. For example, a base ten rod or a ten frame that was used to represent 10 wholes can be used to represent 1 whole that is partitioned into tenths.

B1.8 Fractions and Decimals

round decimal numbers to the nearest whole number, in various contexts

Teacher supports

Key concepts

- Rounding numbers is often done to estimate a quantity or a measure, to estimate the results of a computation, and to estimate a comparison.
- A decimal number rounded to the nearest whole number means rounding the number to the nearest one; for example, is 1.7 closer to 1 or 2?
- Decimal tenths are rounded based on the closer distance between two whole numbers. For example:
 - 56.2 is rounded to 56, because it is two tenths from 56 as opposed to eight tenths to 57.
- If a decimal tenth is exactly between two whole numbers, the convention is to round up, unless the context suggests differently – in some circumstances, it might be better to round down.

Note

- As with whole numbers, rounding decimal numbers involves making decisions about the level of precision needed. Whether a number is rounded up or down depends on the context and whether an overestimate or an underestimate is preferred.

B1.9 Fractions and Decimals

describe relationships and show equivalences among fractions and decimal tenths, in various contexts

Teacher supports

Key concepts

- The fraction $\frac{1}{10}$ as a quotient is $1 \div 10$ and the result is 0.1, which is read as one tenth.
- A count of decimal tenths is the same as a count of unit fractions of one tenth and can be expressed in decimal notation (i.e., 0.1 (1 one tenth), 0.2 (2 one tenths), 0.3 (3 one tenths), and so on).
- A count of 10 one tenths makes 1 whole and can be expressed in decimal notation (1.0).
- A count by tenths can be greater than 1 whole. For example, 15 tenths is 1 whole and 5 tenths and can be expressed in decimal notation as 1.5.

B2. Operations

use knowledge of numbers and operations to solve mathematical problems encountered in everyday life

Specific expectations

By the end of Grade 4, students will:

B2.1 Properties and Relationships

use the properties of operations, and the relationships between addition, subtraction, multiplication, and division, to solve problems involving whole numbers, including those requiring more than one operation, and check calculations

Teacher supports

Key concepts

- The commutative property holds true for addition and for multiplication. The order of the numbers does not matter; the results will be the same. For example, $4 + 6 = 6 + 4$ and $4 \times 6 = 6 \times 4$.
- The associative property holds true for addition and for multiplication. The pairs of numbers that are added first or multiplied first does not matter; the results will be the same. For example, $(2 + 3) + 5 = 2 + (3 + 5)$. Similarly, $(2 \times 3) \times 5 = 2 \times (3 \times 5)$.
- The distributive property can be used to determine the product of two numbers. For example, to determine 8×7 one can rewrite 8 as 5 and 3 and find the sum of the

products for 5×7 and 3×7 (i.e., $8 \times 7 = (5 + 3) \times 7$ which equals $(5 \times 7) + (3 \times 7)$, which is $35 + 21$, or 56).

- Addition and subtraction are inverse operations. Any subtraction question can be thought of as an addition question (e.g., $54 - 48 = ?$ is the same as $48 + ? = 54$) and vice versa. This inverse relationship can be used to perform and check calculations.
- Multiplication and division are inverse operations. Any division question can be thought of as a multiplication question unless 0 is involved (e.g., $16 \div 2 = ?$ is the same as $? \times 2 = 16$), and vice versa. This inverse relationship can be used to perform and check calculations.
- Sometimes a property may be used to check an answer. For example, 4×7 may be first determined using the distributive property as $(2 \times 7) + (2 \times 7)$, and then checked by decomposing (4×7) as $(2 \times 2) \times 7$ and using the associative property $2 \times (2 \times 7)$.
- Sometimes the reverse operation may be used to check an answer. For example, $32 \div 4 = 8$ could be checked by multiplying 4 and 8 to determine if it equals 32.

Note

- This expectation supports many other expectations in the Number strand and is applied throughout the grade. Whether working with numbers or operations, recognizing and applying properties and relationships builds a strong foundation for doing mathematics.
- The four operations are related. Addition and subtraction strategies can be used to think about and solve multiplication and division questions (see **SEs B2.5, B2.6, and B2.7**).
- When addition is used to solve a subtraction question, this is often referred to as finding the missing addend.
- The context of a problem may influence how students think about performing the calculations.
- Operation sense involves the ability to represent situations with symbols and numbers. Understanding the meaning of the operations, and the relationships between and among them, enables one to choose the operation that most closely represents a situation and most efficiently solves the problem given the tools at hand.

B2.2 Math Facts

recall and demonstrate multiplication facts for 1×1 to 10×10 , and related division facts

Teacher supports

Key concepts

- The identity principle states that when multiplying an amount by 1 or dividing an amount by 1, the amount stays the same (e.g., $5 \times 1 = 5$ and $5 \div 1 = 5$).
- The facts of 1, 2, 5, and 10 can be used to determine the facts for other numbers. For example:
 - 2×7 can be determined by knowing 7×2 .
 - 7×3 can be determined by knowing 7×2 and then adding one more group of 7.
 - 7×4 can be determined by knowing 7×2 and then doubling.
- Division facts can be determined using multiplication facts (e.g., $24 \div 6$ can be determined using the multiplication facts for 6).

Note

- Having automatic recall of multiplication and division facts is important when carrying out mental or written calculations, and frees up working memory when solving complex problems and tasks.
- The development of the other facts using the facts for 1, 2, 5, and 10 is based on the commutative, distributive, or associative properties and in being able to decompose numbers. For example:
 - 2×7 can be determined by knowing 7×2 (commutative property).
 - 7×3 can be determined by knowing 7×2 and then adding one more group of 7 (decomposing and using the distributive property).
 - 7×4 can be determined by knowing 7×2 and then doubling (decomposition and associative property).
 - 7×6 can be determined by knowing 7×5 and adding one more 7.
 - 7×9 can be determined by knowing 7×10 and taking away 7.
- The array can be used to model multiplication and division because it structures repeated groups of equal size into rows and columns.
 - In a multiplication situation, the number of rows and columns for the array are known.
 - In a division situation, the total number of objects is known, as well as either the number of rows or the number of columns. In order to create an array to represent a division situation, the objects are arranged into the rows or columns that are known until all the objects have been distributed evenly.

- A strategic approach to learning multiplication and division facts recognizes that some facts are foundational for learning other facts. Although the precise order might differ and different strategies are certainly possible, researchers tend to suggest learning facts in related clusters. For example:
 - Foundational facts: 2-facts, 5-facts, 10-facts.
 - Near facts: 3-facts, 6-facts, 9-facts (using 2-facts, 5-facts, and 10-facts and adding or subtracting a group).
 - Doubles: 4-facts, 6-facts (doubling strategies); 8-facts (doubling a double).
 - Adding or subtracting doubles: 8-facts, 7-facts.
- Practice is important for moving from understanding to automaticity. Focusing on one set of number facts at a time (e.g., the 6-facts) and related facts (5-facts or 3-facts) is a useful strategy for building mastery.

B2.3 Mental Math

use mental math strategies to multiply whole numbers by 10, 100, and 1000, divide whole numbers by 10, and add and subtract decimal tenths, and explain the strategies used

Teacher supports

Key concepts

- Multiplying a whole number by 10 can be visualized as shifting of the digit(s) to the left by one place. For example, $5 \times 10 = 50$; $50 \times 10 = 500$; $500 \times 10 = 5000$.
- Multiplying a whole number by 100 can be visualized as shifting of the digit(s) to the left by two places. For example, $5 \times 100 = 500$; $50 \times 100 = 5000$; $500 \times 100 = 50\ 000$.
- Mentally multiplying a whole number by 1000 can be visualized as a shifting of the digit(s) to the left by three places. For example, $5 \times 1000 = 5000$; $50 \times 1000 = 50\ 000$; $500 \times 1000 = 500\ 000$.
- Mentally dividing a whole number by 10 can be visualized as a shifting of the digit(s) to the right by one place, since the value of the numbers will be one tenth of what they were. For example, $5000 \div 10 = 500$, $500 \div 10 = 50$, $50 \div 10 = 5$, $5 \div 10 = 0.5$.
- Mental math strategies for addition and subtraction of whole numbers can be used with decimal numbers.
- To mentally add and subtract decimal numbers, the strategies may vary depending on the numbers given. For example:

- If given $44.9 + 31.9$, one could round both numbers to 45 and 32 to make 77 and then remove 0.1 twice from the rounding, to make 76.8.
- If given $34.6 + 42.5$, one could first make 1 by combining the 0.5 from both of the numbers, then add it to 34 to make 35. Next add 40 from 42 onto the 35 to make 75. Then add on the remaining numbers 2 and 0.1 to make 77.1.

Note

- Mental math may or may not be quicker than paper-and-pencil strategies, but speed is not the goal. The value of mental math is in its portability and flexibility, since it does not require a calculator or paper and pencil. Practising mental math strategies also deepens an understanding of numbers.
- Mental math involves using flexible strategies that build on basic facts, number relationships, and counting strategies. These strategies continue to expand and develop through the grades.
- When mentally adding and subtracting decimals – or anything – the unit matters. Only like units are combined. For example, hundreds are combined with hundreds, tens with tens, ones with ones, and tenths with tenths.
- Estimation can be used to check the reasonableness of calculations and should be continually encouraged when students are doing mathematics.

B2.4 Addition and Subtraction

represent and solve problems involving the addition and subtraction of whole numbers that add up to no more than 10 000 and of decimal tenths, using appropriate tools and strategies, including algorithms

Teacher supports

Key concepts

- Situations involving addition and subtraction may involve:
 - adding a quantity onto an existing amount or removing a quantity from an existing amount;
 - combining two or more quantities;
 - comparing quantities.
- There are a variety of tools and strategies that can be used to add and subtract numbers, including decimal tenths:

- Acting out a situation, by representing it with objects, a drawing, or a diagram, can help support students in identifying the given quantities in a problem and the unknown quantity.
- Set models can be used to add a quantity to an existing amount or removing a quantity from an existing amount.
- Linear models can be used to determine the difference between two quantities by comparing them visually.
- Part-whole models can be used to show the relationship between what is known and what is unknown and how addition and subtraction relate to the situation.

Note

- An important part of problem solving is the ability to choose the operation that matches the action in a situation. For additive situations – situations that involve addition or subtraction – there are three “problem structures”:
 - *Change* situations, where one quantity is changed, by having an amount either *joined* to it or *separated* from it. Sometimes the result is unknown; sometimes the starting point is unknown; sometimes the change is unknown.
 - *Combine* situations, where two quantities are *combined*. Sometimes one part is unknown; sometimes the other part is unknown; sometimes the result is unknown.
 - *Compare* situations, where two quantities are being *compared*. Sometimes the larger amount is unknown; sometimes the smaller amount is unknown; sometimes the difference between the two amounts is unknown.
- The use of drawings and models, including part-whole models, helps with recognizing the actions and quantities involved in a situation. This provides insight into which operation to use and helps in choosing the appropriate equation to represent the situation.
- A variety of strategies may be used to add or subtract, including algorithms.
- An algorithm describes a process or set of steps to carry out a procedure. A standard algorithm is one that is known and used by a community. Different cultures have different standard algorithms that they use to perform calculations.
- The most common (standard) algorithms for addition and subtraction in North America use a compact organizer to *decompose* and *recompose* numbers based on place value. They begin with the smallest unit – whether it be the ones column or decimal tenths – and use regrouping or trading strategies to carry out the computation. (See **Grade 3, SE B2.4.**)
- When carrying out an addition or subtraction algorithm, only common units can be combined or separated. This is particularly noteworthy when using the North American standard algorithms with decimal numbers because unlike with whole numbers, the smallest unit in a number is not always common (e.g., $90 - 24.7$). In this case, the number

90 can be changed to 90.0 so that the units can more easily be aligned; that is, 0 is used as a placeholder.

- Making explicit the compactness and efficiency of the standard algorithm strengthens understanding of place value and the properties of addition and subtraction.

How It Is Written		What It Means
$\begin{array}{r} ^8 ^9 ^1 \\ 90.0 \\ - 24.7 \\ \hline 65.3 \end{array}$	<p>→</p> <p>→</p> <p>→</p>	$\begin{array}{r} (80.0 + 9.0 + 1.0) \\ - (20.0 + 4.0 + 0.7) \\ \hline 60.0 + 5.0 + 0.3 \end{array}$

B2.5 Multiplication and Division

represent and solve problems involving the multiplication of two- or three-digit whole numbers by one-digit whole numbers and by 10, 100, and 1000, using appropriate tools, including arrays

Teacher supports

Key concepts

- Situations involving multiplication include:
 - groups of equal quantity – involves determining the total quantity given the number of equal groups and the size of each group;
 - scale factor – involves changing the size of an initial quantity;
 - area – involves a multiplication of two linear measures;
 - combinations – involves determining the total number of combinations of two or more things.
- A variety of tools and strategies can be used to represent multiplication problems:
 - Acting out a situation, by representing it with objects, a drawing, or a diagram, can help to identify the given quantities in a problem and the quantity.
 - The array can be used to represent groups of equal quantity.
 - A double number line can be used to represent scaling.
 - Rectangular grids can be used to represent area measures.
 - A tree diagram can be used to represent various combinations.

Note

- The numbers that are multiplied together are called factors. The result of a multiplication is called the product.
- Situations involving multiplication include:
 - repeated equal groups (see **Grade 2, B2.5**);
 - scale factor – ratio comparisons, rates and scaling (see **SEs B1.5 and B2.8 and Grade 3, SE B2.9**);
 - area and other measurements (see **Spatial Sense, SEs E2.5 and E2.6**);
 - combinations of attributes.
- The array can be a model for showing multiplication and division because it structures repeated groups of equal size into rows and columns (see **Spatial Sense, E2.5**). The array makes visual connections to skip counting, the distributive property, the inverse relationship between multiplication and division, and the measurement of area.
- A double number line can be used to show the comparison between the original amount (one number line) and the scaled amount (another number line).
- A grid showing a rectangle partitioned vertically and horizontally can be used to show the decomposition of two factors and the sum of these parts.

B2.6 Multiplication and Division

represent and solve problems involving the division of two- or three-digit whole numbers by one-digit whole numbers, expressing any remainder as a fraction when appropriate, using appropriate tools, including arrays

Teacher supports

Key concepts

- Situations involving division include:
 - groups of equal quantity – involves determining either the number of groups or the size of each group;
 - scale factor – involves determining either the original quantity or the value that the original value was multiplied by;
 - area – involves determining the value of either linear measure;
 - combinations – involves determining the number of possible values of one attribute or the other.

- A variety of tools and strategies can be used to represent division problems:
 - Acting out a situation, by representing it with objects, a drawing, or a diagram, can help identify the given quantities in a problem and the unknown quantity that needs to be determined.
 - The array can be used to represent groups of equal quantity.
 - A double number line can be used to represent scaling.
 - Rectangular grids can be used to represent area measures.
 - A tree diagram can be used to represent various combinations.

Note

- Multiplication and division are inverse operations (see **SE B2.1**).
 - The numbers that are multiplied together are called factors. The result of a multiplication is called the product.
 - When a multiplication statement is rewritten as a division statement, the product is referred to as the dividend, one of the factors is the divisor, and the other factor is the quotient (result of division).
- Situations involving multiplication and division include:
 - repeated equal groups (see **Grade 2, SE B2.5**);
 - scale factor – ratio comparisons, rates, and scaling (see **SEs B1.5 and 2.8 and Grade 3, SE B2.9**);
 - area and other measurements (see **Spatial Sense, SEs E2.5 and E2.6**);
 - combinations.
- When an array is used to represent division, the total quantity is given, and one of the factors (which can be either a row or column of the array). The total quantity is equally divided among these rows or columns.
- When a double number line is used to represent a division in which the original and new quantities are known, one needs to determine the scale factor that is used to go from the original number line to the new one.
- When a rectangle is used to represent division, and the total number of 1-unit squares and one dimension are known, one needs to arrange the unit squares into a rectangle that has the given dimension.
- For each division situation, there are two division types:
 - equal-sharing division (also called “partitive division”):
 - *What is known:* the *total* and *number* of groups.

- *What is unknown:* the *size* of the groups.
 - *The action:* a total shared equally among a given number of groups.
- See **SE B1.5** for connections between equal-sharing division and fractions.
 - equal-grouping division (also called “measurement division” or “quotative division”):
 - *What is known:* the *total* and the *size* of groups.
 - *What is unknown:* the *number* of groups.
 - *The action:* from a total, equal groups of a given size measured out.
- Division does not always result in whole number amounts. The real-life situation determines whether the fraction is rounded up or rounded down or remains a fraction. For example:
 - 17 items shared among 5 (i.e., $17 \div 5$) means each receives 3 items and $\frac{2}{5}$ of another item.
 - 17 people needing to go in cars that hold 5 people means that 3 cars are needed for 15 of them, plus another car is needed for the remaining 2, so 4 cars are needed in all.
 - Determining how many \$5 items can be bought with \$17 means that 3 items can be purchased; there is not enough money for the fourth item.

B2.7 Multiplication and Division

represent the relationship between the repeated addition of a unit fraction and the multiplication of that unit fraction by a whole number, using tools, drawings, and standard fractional notation

Teacher supports

Key concepts

- The numerator in a fraction describes the count of unit fractions. So, 4 one thirds (four thirds) is written in standard fractional form as $\frac{4}{3}$.
- There is a relationship between the repeated addition of a unit fraction, the multiplication of that unit fraction, and standard fractional notation:
 - 4 one thirds (four thirds).can be represented as $\frac{1}{3} + \frac{1}{3} + \frac{1}{3} + \frac{1}{3} = 4 \times \frac{1}{3}$ or $\frac{4}{3}$

Note

- It is important that students recognize the connection between counting unit fractions (see **SE B1.6**), repeated addition and multiplication of unit fractions, and the meaning of the numerator (see **SE B1.4**).
- As students come to associate multiplication with the count (the numerator) and division with the unit size (the denominator), they come to understand the standard fractional notation and its connection to the operations of multiplication and division.

B2.8 Multiplication and Division

show simple multiplicative relationships involving whole-number rates, using various tools and drawings

Teacher supports

Key concepts

- A rate describes the multiplicative relationship between two quantities expressed with different units (e.g., bananas per dollar; granola bars per child; kilometres per hour).
- A rate can be expressed in words, such as 50 kilometers per hour.
- A rate can be expressed as a division statement, such as 50 km/h.
- There are many applications for rates in real life.

Note

- Like ratios, rates make comparisons based on multiplication and division; however, rates compare two related but different measures or quantities. For example, if 12 cookies are eaten by 4 people, then the rate is 12 cookies per 4 people. An equivalent rate is 6 cookies per 2 people. A unit rate is 3 cookies per person.

C. Algebra

Overall expectations

By the end of Grade 4, students will:

C1. Patterns and Relationships

identify, describe, extend, create, and make predictions about a variety of patterns, including those found in real-life contexts

Specific expectations

By the end of Grade 4, students will:

C1.1 Patterns

identify and describe repeating and growing patterns, including patterns found in real-life contexts

Teacher supports

Key concepts

- The complexity of a repeating pattern depends on:
 - the nature of the attribute(s);
 - the number of changing attributes;
 - the number of elements in the core of the pattern;
 - the number of changing elements within the core.
- In growing patterns, there is an increase in the number of elements or the size of the elements from one term to the next.

Note

- Students can engage in mathematics and patterns through the contexts, cultural histories, and stories of various cultures.

C1.2 Patterns

create and translate repeating and growing patterns using various representations, including tables of values and graphs

Teacher supports

Key concepts

- The same pattern structure can be represented in various ways.
- Repeating patterns can vary in complexity, but all are created by iterating their pattern core.
- Growing patterns are created by increasing the number of elements in each iteration.
- When translating a pattern from a concrete representation to a table of values, each iteration of the pattern can be referred to as the term number, and the number of elements in each iteration can be referred to as the term value. In a table of values, the term number is shown in the left-hand column and the term value is shown in the right-hand column.
- The term value is dependent on the term number. The term number (x) is represented on the horizontal axis of the Cartesian plane, and the term value (y) is represented on the vertical axis. Each point (x, y) on the Cartesian plane is plotted to represent the pattern.

Note

- The creation of growing patterns in this grade is not limited to linear patterns.
- For (x, y) , the x -value is the independent variable and the y -value is the dependent variable.
- Comparing translated patterns highlights the equivalence of their underlying mathematical structure, even though the representations differ.

C1.3 Patterns

determine pattern rules and use them to extend patterns, make and justify predictions, and identify missing elements in repeating and growing patterns

Teacher supports

Key concepts

- Patterns can be extended because they are repetitive by nature.

- Pattern rules are generalizations about a pattern, and they can be described in words.
- Patterns can be extended in multiple directions – up, down, right, left, diagonally.
- To make a near prediction about a pattern is to state or show what a pattern will look like just beyond the given representation of that pattern. The prediction can be verified by extending the pattern.
- To make a far prediction about a pattern is to state or show what a pattern will look like well beyond the given representation of that pattern. Often calculations are needed to make an informed prediction or to verify a prediction.
- To identify missing elements of patterns is to complete a representation for a given pattern by filling in the missing parts.

Note

- In order to extend, predict, or determine missing elements, students need to generalize patterns, using pattern rules.
- Rules should be used to verify predictions and to critically analyse extensions and solutions for missing elements.

C1.4 Patterns

create and describe patterns to illustrate relationships among whole numbers and decimal tenths

Teacher supports

Key concepts

- Patterns can be used to understand relationships between whole numbers and decimal numbers.

Note

- Many number strings are based on patterns and the use of patterns to develop a mathematical concept.

C2. Equations and Inequalities

demonstrate an understanding of variables, expressions, equalities, and inequalities, and apply this understanding in various contexts

Specific expectations

By the end of Grade 4, students will:

C2.1 Variables

identify and use symbols as variables in expressions and equations

Teacher supports

Key concepts

- Symbols can be used to represent quantities that change or quantities that are unknown.
- An expression is a mathematical statement that involves numbers, letters, and/or operations, for example, $a + 3$.
- An equation is a statement of equality between two expressions, for example, $1a + 3 = 5 + 10$.
- Formulas are a type of equation, for example, $A = b \times h$.
- Quantities that can change are also referred to as “variables”.
- Quantities that remain the same are also referred to as “constants”.

Note

- Identifying quantities in real life that stay the same and those that can change will help students understand the concept of variability.
- Identifying what is constant and what changes is one of the aspects of mathematical modelling.
- In mathematics notation, variables are only expressed as letters or symbols. When coding, variables may be represented as words, abbreviated words, symbols, or letters.
- In an expression like $4a$, it is understood that the operation between the 4 and the a is multiplication. In working with some technologies, $4a$ would need to be inputted as $4*a$, in which the asterisk denotes multiplication. The forward slash (/) is used for division.

C2.2 Equalities and Inequalities

solve equations that involve whole numbers up to 50 in various contexts, and verify solutions

Teacher supports

Key concepts

- Equations are mathematical statements such that the expressions on both sides of an equal sign are equivalent.
- In equations, symbols are used to represent unknown quantities.

Note

- To solve an equation using guess-and-check, the process is iterative. The unknown value is estimated and then tested. Based on the result of the test, the guess is refined to get closer to the actual value.
- To solve an equation using a balance model, the expressions are visually represented and are manipulated until they are equivalent.

C2.3 Equalities and Inequalities

solve inequalities that involve addition and subtraction of whole numbers up to 20, and verify and graph the solutions

Teacher supports

Key concepts

- Inequalities can be solved as equations, but the values that result must be tested to determine if they hold true for the inequality.
- A number line shows the range of values that hold true for an inequality. An open dot on a number line is used when an inequality involves “less than” or “greater than”, and a closed dot is used when it also includes “equal to”.
- Number lines help students notice the range of values that hold true for inequalities.

C3. Coding

solve problems and create computational representations of mathematical situations using coding concepts and skills

Specific expectations

By the end of Grade 4, students will:

C3.1 Coding Skills

solve problems and create computational representations of mathematical situations by writing and executing code, including code that involves sequential, concurrent, repeating, and nested events

Teacher supports

Key concepts

- A loop is used to control a structure that allows for a sequence of instructions to be repeated.
- Loops make the code more readable and reduce the number of instructions that need to be written.
- Loops can be used to repeat steps or tasks that occur more than once in an algorithm or solution.
- Loops can exist within loops, referred to as “nested loops”.

Note

- Coding can support students in developing a deeper understanding of mathematical concepts.
- Coding can include a combination of pseudocode, block-based coding programs, and text-based coding programs.
- Students can program for various agents, such as a pixelated image on a screen, a classmate acting out the code when appropriate, or a physical device (e.g., robot, microcontroller).

C3.2 Coding Skills

read and alter existing code, including code that involves sequential, concurrent, repeating, and nested events, and describe how changes to the code affect the outcomes

Teacher supports

Key concepts

- Code can be simplified by using loops or by combining steps and operations.
- Reading code is done to make a prediction about what the expected outcome will be. Based on that prediction, one can determine if the code needs to be altered prior to its execution.
- Code must sometimes be altered so that the expected outcome can be achieved.
- Code can be altered to be used for a new situation.

Note

- Using loops helps students organize their code and provides a foundation for considering efficiencies in program solutions.
- By manipulating conditions within a loop and the number of times the loop is repeated, students can determine the relationship between variables in lines of code and can explore math concepts, such as pattern intervals and terms.

C4. Mathematical Modelling

apply the process of mathematical modelling to represent, analyse, make predictions, and provide insight into real-life situations

This overall expectation has no specific expectations. Mathematical modelling is an iterative and interconnected process that is applied to various contexts, allowing students to bring in learning from other strands. Students' demonstration of the process of mathematical modelling, as they apply concepts and skills learned in other strands, is assessed and evaluated.

Read more about the [mathematical modelling process](#).

Teacher supports

Key concepts

- The process of mathematical modelling requires: understanding the problem; analysing the situation; creating a mathematical model; and analysing and assessing the model.

Note

- A mathematical modelling task is different from a real-life application due to the cyclic nature of modelling, which involves examining a problem from outside mathematics, modelling it, and then checking the model back against the real-life situation and adjusting as necessary.
- The process of mathematical modelling should not be confused with using a "model" to represent or solve a problem that does not require the whole process.
- Mathematical modelling tasks can be utilized in many ways and can support students with making connections among many mathematical concepts across the math strands and across other curricula.

D. Data

Overall expectations

By the end of Grade 4, students will:

D1. Data Literacy

manage, analyse, and use data to make convincing arguments and informed decisions, in various contexts drawn from real life

Specific expectations

By the end of Grade 4, students will:

D1.1 Data Collection and Organization

describe the difference between qualitative and quantitative data, and describe situations where each would be used

Teacher supports

Key concepts

- It is important to know whether the data that is needed to answer a question is qualitative or quantitative, so that appropriate collection can be planned and carried out, appropriate representations chosen, and appropriate analysis conducted.

- Qualitative data involves variables that can be placed into categories like “type of sports” or “colour”.
- Quantitative data involves variables that can be counted or ordered, like “the number of legs on an insect” or “the length of an object”.

D1.2 Data Collection and Organization

collect data from different primary and secondary sources to answer questions of interest that involve comparing two or more sets of data, and organize the data in frequency tables and stem-and-leaf plots

Teacher supports

Key concepts

- The type and amount of data to be collected is based on the question of interest. Data can either be qualitative or quantitative. Sometimes more than one data set is needed to answer a question of interest.
- Data may need to be collected from a primary source through observations, experiments, interviews, or written questionnaires, or from a secondary source that has already collected the data, such as Statistics Canada or the school registry.
- Two or more data sets can be organized in separate frequency tables or within the same frequency table.
- A stem-and-leaf plot is one way to organize quantitative data. It can provide a sense of the shape of the data. The digits in the number are separated out into a stem and a leaf. For example, the number 30 has a stem of 3 and a leaf of 0. The stems and the leaves are ordered from least to greatest value in the plot.

Stem	Leaf
0	5 5
1	0 0 0 5 5 5 5
2	0 0 5 5
3	0 5 5 5

Key: 3|0 is 30 minutes

D1.3 Data Visualization

select from among a variety of graphs, including multiple-bar graphs, the type of graph best suited to represent various sets of data; display the data in the graphs with proper sources, titles, and labels, and appropriate scales; and justify their choice of graphs

Teacher supports

Key concepts

- Multiple bar graphs show comparisons. They have bars in which data sets are shown side by side to compare two aspects of the data.
- Multiple bar graphs can be created in more than one way, including with horizontal and vertical bars.
- The source, titles, labels, and scales provide important information about the data in a graph or table:
 - The source indicates where the data was collected.
 - The title introduces the data shown in the graph or table.
 - Labels provide additional information, such as the labels on the axes of a graph describe what is being measured (the variable).
 - Scales are indicated on the axis showing frequencies in bar graphs and in the key of pictographs.

Note

- The numerical values of the frequencies need to be considered when a scale is chosen.
- Depending on the scale that is chosen, the length of the bars on a bar graph may need to be estimated.

D1.4 Data Visualization

create an infographic about a data set, representing the data in appropriate ways, including in frequency tables, stem-and-leaf plots, and multiple-bar graphs, and incorporating any other relevant information that helps to tell a story about the data

Teacher supports

Key concepts

- Infographics are used to share data and information on a topic, in an appealing way.
- Infographics contain different representations of the data, such as tables, plots, and graphs, and minimal text.
- Information to be included in an infographic needs to be carefully considered so that it is clear and concise.
- Infographics tell a story about the data with a specific audience in mind.

Note

- Creating infographics has applications in other subject areas, such as communicating key findings and messages in STEM projects.

D1.5 Data Analysis

determine the mean and the median and identify the mode(s), if any, for various data sets involving whole numbers, and explain what each of these measures indicates about the data

Teacher supports

Key concepts

- The mean, median, and mode can be determined for quantitative data. Only the mode can be determined for qualitative data.
- The mean is calculated by adding up all of the values of a data set and then dividing that sum by the number of values in the set.
- The median is the middle data value for an ordered list. If there is an even number of data values, then the median is the mean of the two middle values in the ordered list.
- A variable can have one mode, multiple modes, or no mode.

Note

- The mean, median, and mode are the three measures of central tendency.

D1.6 Data Analysis

analyse different sets of data presented in various ways, including in stem-and-leaf plots and multiple-bar graphs, by asking and answering questions about the data and drawing conclusions, then make convincing arguments and informed decisions

Teacher supports

Key concepts

- Different representations are used for different purposes to convey different types of information.
- Stem-and-leaf plots are helpful for quickly determining highest and lowest values, as well as the mode and median for a set of data.
- Multiple-bar graphs are used to organize data sets side by side and allow for easy comparisons between the sets of data.
- Data presented in tables, plots, and graphs can be used to ask and answer questions, draw conclusions, and make convincing arguments and informed decisions.
- Questions of interest are intended to be answered through the analysis of the representations. Sometimes the analysis raises more questions that require further collection, representation, and analysis of data.

Note

- There are three levels of graph comprehension that students should learn about and practise:
 - Level 1: information is read directly from the graph and no interpretation is required.
 - Level 2: information is read and used to compare (e.g., greatest, least) or perform operations (e.g., addition, subtraction).
 - Level 3: information is read and used to make inferences about the data using background knowledge of the topic.
- As graphs become more sophisticated, have students highlight the parts of the graph they need to answer a question, including the scales when appropriate.

D2. Probability

describe the likelihood that events will happen, and use that information to make predictions

Specific expectations

By the end of Grade 4, students will:

D2.1 Probability

use mathematical language, including the terms “impossible”, “unlikely”, “equally likely”, “likely”, and “certain”, to describe the likelihood of events happening, represent this likelihood on a probability line, and use it to make predictions and informed decisions

Teacher supports

Key concepts

- Probability has a continuum from impossible to certain with the following benchmarks between: unlikely, equally likely, and likely.

Note

- Sometimes equally likely is thought of as an equal chance of events happening (e.g., rolling a 4 or rolling a 6 on a single die). However, on a probability line equally likely is the probability that an event will happen half of the time (e.g., rolling an even number with a single die).

D2.2 Probability

make and test predictions about the likelihood that the mean, median, and mode(s) of a data set will be the same for data collected from different populations

Teacher supports

Key concepts

- Data can vary from one population to another.
- If two populations are similar, the modes for the two data sets collected will more than likely be the same and the means and the medians will be relatively close.

E. Spatial Sense

Overall expectations

By the end of Grade 4, students will:

E1. Geometric and Spatial Reasoning

describe and represent shape, location, and movement by applying geometric properties and spatial relationships in order to navigate the world around them

Specific expectations

By the end of Grade 4, students will:

E1.1 Geometric Reasoning

identify geometric properties of rectangles, including the number of right angles, parallel and perpendicular sides, and lines of symmetry

Teacher supports

Key concepts

- Geometric properties are specific attributes that define a class of shapes or objects. The geometric properties of a rectangle describe the attributes that all rectangles have, and include:
 - four sides, four vertices, and four right angles;
 - opposite sides that are of equal length (congruent);
 - opposite sides that are parallel;
 - adjacent sides that are perpendicular;
 - at least two lines of symmetry – horizontal and vertical.
- Geometric properties are often related. Rectangles have four right angles, so they must also have two sets of parallel sides, and the opposite sides must be of equal length. This type of spatial reasoning is used by structural engineers and others.
- The geometric properties of a square include all the geometric properties of a rectangle; therefore, all squares are also rectangles. Squares have additional geometric properties (four equal sides, four lines of symmetry, including two diagonals), therefore not all rectangles are squares.

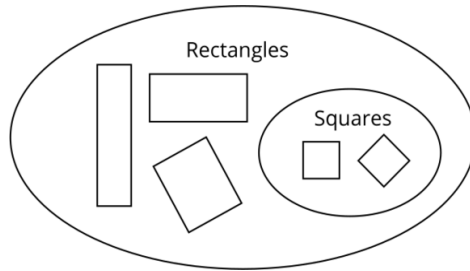

- The geometric properties of a shape, and not its size or orientation, define the name of a shape. A rotated square that might look like a diamond is still a square, because it has all the geometric properties of a square.

E1.2 Location and Movement

plot and read coordinates in the first quadrant of a Cartesian plane, and describe the translations that move a point from one coordinate to another

Teacher supports

Key concepts

- The Cartesian plane uses two perpendicular number lines to describe locations on a grid. The x -axis is a horizontal number line, the y -axis is a vertical number line, and these two number lines intersect at the origin, $(0, 0)$.
- The number lines on the Cartesian plane extend infinitely in all four directions and include both positive and negative numbers, which are centred by the origin, $(0, 0)$. In the first quadrant of the Cartesian plane, the x - and y -coordinates are positive.
- Pairs of numbers (coordinates) describe the precise location of any point on the plane. The coordinates are enclosed by parentheses as an ordered pair. The first number in the pair describes the horizontal distance from the origin, and the second number describes the vertical distance from the origin. The point $(1, 5)$ is located 1 unit to the right of the origin (along the x -axis) and 5 units above the x -axis. As a translation from $(0, 0)$, the point $(1, 5)$ is right 1 unit and up 5 units.

Note

- An understanding of the Cartesian plane supports work in geometry, measurement, Algebra, and Data, as well as practical applications such as navigation, graphic design, engineering, astronomy, and computer animation.

E1.3 Location and Movement

describe and perform translations and reflections on a grid, and predict the results of these transformations

Teacher supports

Key concepts

- Transformations on a shape result in changes to its position or its size. As a shape transforms, its vertices (points on a grid) move. This explains how transformations involve location and movement.
- A translation involves distance and direction. Every point on the original shape “slides” the same distance and direction to create a translated image. This is called the translation vector. For example, on a grid, a vector could describe each point moving “5 units to the right and 2 units up”. It is a mathematical convention that the horizontal distance (x) is given first, followed by the vertical distance (y).

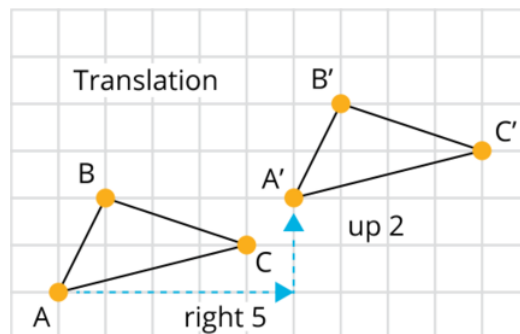

- A reflection involves a line of reflection that acts like a mirror. Every point on the original shape is “flipped” across the line of reflection to create a reflected image. The points on the original image are the same distance from the line of reflection as the points on the reflected image. Reflections are symmetrical.

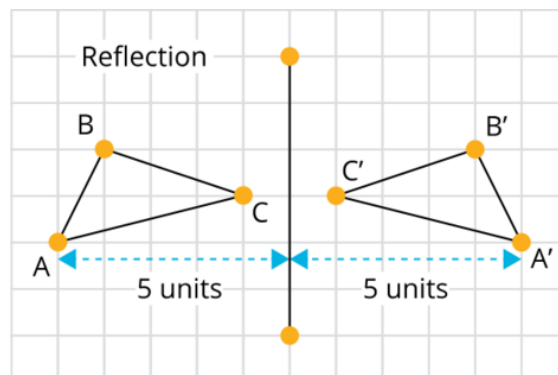

Note

- Online dynamic geometry applications enable students to see how transformations behave in real time and are recommended tools for the study of transformation and movement.

E2. Measurement

compare, estimate, and determine measurements in various contexts

Specific expectations

By the end of Grade 4, students will:

E2.1 The Metric System

explain the relationships between grams and kilograms as metric units of mass, and between litres and millilitres as metric units of capacity, and use benchmarks for these units to estimate mass and capacity

Teacher supports

Key concepts

- Millilitres and litres are standard metric units of capacity. Grams and kilograms are metric units of mass:
 - 1 kilogram (kg) is equivalent to 1000 grams (g).
 - 1 litre (L) is equivalent to 1000 millilitres (mL).
 - 1 mL of water has a mass of 1 g.
 - 1 mL of liquid occupies the space of a 1 cm cube.
- Although standard and non-standard units are equally accurate for measuring (provided the measurement itself is carried out accurately), *standard* units allow people to communicate distances and lengths in ways that are consistently understood.
- The metric system is universally used among scientists because it uses standard prefixes for measurements and conversions. Metric units are the standard unit for all but three countries in the world.

Note

- Canada officially adopted the metric system in 1970, through the Weights and Measures Act. This Act was amended in 1985 to allow Canadians to use a combination of metric and imperial units (called “Canadian” units in the [Weights and Measures Act](#)). In addition to metric units, other commonly used units of capacity are gallons, quarts, cups, tablespoons, and teaspoons; other commonly used units of mass are ounces, pounds, and tons. Measuring with imperial units follows the same process as measuring with metric and non-standard units. Only the units and the measuring tools differ. Imperial units are the typical units used in construction and the trades. Students in elementary grades learn to work with metric units first.

E2.2 The Metric System

use metric prefixes to describe the relative size of different metric units, and choose appropriate units and tools to measure length, mass, and capacity

Teacher supports

Key concepts

- The metric system parallels the base ten number system. One system can reinforce and help with visualizing the other system.
- The same set of metric prefixes is used for all attributes (except time) and describes the relationship between the units. For any given unit, the next largest unit is 10 times its size, and the next smallest unit is one-tenth its size.

Note

- Although not all metric prefixes are used commonly in Canada, understanding the system reinforces the connection to place value.

E2.3 Time

solve problems involving elapsed time by applying the relationships between different units of time

Teacher supports

Key concepts

- Elapsed time describes how much time has passed between two times or dates. Clocks and calendars are used to measure and/or calculate elapsed time.
- Addition, subtraction, and different counting strategies can be used to calculate the difference between two dates or times. Open number lines (time lines) can be used to track the multiple steps and different units used to determine elapsed time.

Note

- Elapsed time problems often involve moving between different units of time. This requires an understanding of the relationships between units of time (years, months, weeks, days, hours, minutes, seconds), including an understanding of a.m. and p.m. as conventions to convert the 24-hour clock into a 12-hour clock.

E2.4 Angles

identify angles and classify them as right, straight, acute, or obtuse

Teacher supports

Key concepts

- The rays that form an angle (i.e., the “arms” of an angle) meet at a vertex. The size of an angle is not affected by the length of its arms.
- A right angle is a quarter turn, and it is sometimes called a “square angle” because all angles of a square (or rectangle) are right. If two lines meet at a right angle, the lines are perpendicular.
- Angles can be compared by overlaying one angle on another and matching them. A turn greater than a right angle is an obtuse angle. A turn less than a right angle is an acute angle. A half turn, where the arms of the angle create a straight line, is a straight angle.
- Right angles measure exactly 90° , a fact that will be addressed formally in Grade 5.

E2.5 Area

use the row and column structure of an array to measure the areas of rectangles and to show that the area of any rectangle can be found by multiplying its side lengths

Teacher supports

Key concepts

- To measure the area of a rectangle, it must be completely covered by units of area (square units), without gaps or overlaps. The alignment of square units produces the rows and columns of an array, with the same number of units in each row.
 - The array replaces the need to count individual units and makes it possible to calculate an area.
 - Both the number of units in each row and the number of units in a column can be determined from the length of the rectangle's sides.
- Thinking about a row or a column as “a group that is repeated” (unitized) connects the array to multiplication: the base of a rectangle corresponds to the number of squares in a row and the height of a rectangle corresponds to the number of squares in a column.
- Multiplying the base of a rectangle by its height is a way to indirectly measure the area of a rectangle, meaning it is no longer necessary to count all the individual square units that cover a rectangle's surface.

Note

- Many students do not immediately recognize the row-and-column structure of an array; instead, it appears as a random scattering of squares, or a “spiral” of squares that goes around the outside towards the centre. Recognizing an array's structure requires careful attention and instruction.

E2.6 Area

apply the formula for the area of a rectangle to find the unknown measurement when given two of the three

Teacher supports

Key concepts

- The formula for finding the area of a rectangle can be generalized to describe the relationship between a rectangle's side lengths and its area: $A = \text{base} \times \text{height}$ (or $b \times h$).
- Both multiplication and division can be used to solve problems involving the area of a rectangle.

- Multiplication is used to determine the unknown area when the base and height of a rectangle are given ($Area = base \times height$).
- Division is used to determine either the length of the base or the length of the height when the total area is given ($Area \div base = height$; $Area \div height = base$).
- Either side length can be considered the base or the height of a rectangle.
- An area measurement needs to include both the number of units and the size of the units. Standard metric units of area are the square centimetre (cm^2) and the square metre (m^2). If a surface is completely covered by 18 square centimetres, the area of that surface is 18 cm^2 . If a surface is completely covered by 18 unit squares, the area of that surface is 18 square units.

Note

- The area of a rectangle is used to determine the area formulas for other polygons. Using “base” and “height” rather than “length” and “width” builds a unifying foundation for work in Grade 5 involving the area formulas for triangles and parallelograms.

F. Financial Literacy

Overall expectations

By the end of Grade 4, students will:

F1. Money and Finances

demonstrate the knowledge and skills needed to make informed financial decisions

Specific expectations

By the end of Grade 4, students will:

F1.1 Money Concepts

identify various methods of payment that can be used to purchase goods and services

Teacher supports

Key concepts

- Consumers have a choice of method of payment when purchasing goods and services.
- There is an underlying agreement between the vendor and consumer that is finalized when a payment is made.

Note

- Depending on individual circumstances and context as well as consumers' and vendors' preferences, ideas about which payment method is best in each situation will vary.
- Recognizing how people pay for goods and services helps to develop consumer awareness and an understanding of the factors that contribute to the choice of payment method.

F1.2 Money Concepts

estimate and calculate the cost of transactions involving multiple items priced in whole-dollar amounts, not including sales tax, and the amount of change needed when payment is made in cash, using mental math

Teacher supports

Key concepts

- Estimating and calculating the cost of cash transactions requires the application of addition, subtraction, mental math strategies, and math facts.

Note

- Real-life situations, using the cultural context of students in the class, provide opportunities to develop an understanding of the use of money.
- Providing multiple opportunities to apply mental math strategies to real-life situations will build students' ability to recall math facts, while reinforcing their knowledge and understanding of operations. These opportunities can provide meaningful contexts to practise mental math strategies in order to increase students' confidence and the accuracy of their calculations.

F1.3 Financial Management

explain the concepts of spending, saving, earning, investing, and donating, and identify key factors to consider when making basic decisions related to each

Teacher supports

Key concepts

- Every financial decision involves a trade-off – giving up something today or in the future to gain something else.

Note

- Each person, family, or community may be facing a different financial situation, and some of these financial situations may be challenging or difficult. Having a safe, respectful, and inclusive environment will ensure that all perspectives and opinions are valued and included when examining the above financial concepts.

F1.4 Financial Management

explain the relationship between spending and saving, and describe how spending and saving behaviours may differ from one person to another

Teacher supports

Key concepts

- Money can be used for spending, saving, or giving. It can be spent on things that are needed, wanted, or required. Saving and spending behaviours are impacted by a variety of factors, perspectives, and circumstances.
- An understanding of the relationship between spending and saving, and consideration of the possible trade-offs, may influence financial decision-making.
- Saving can be achieved by using less, sharing, reusing, recycling, upcycling, and/or caring for one's possessions so that they do not need to be replaced.

Note

- Each person, family, or community may be facing a different financial situation, and some of these financial situations may be challenging or difficult. Having a safe, respectful, and

inclusive environment will ensure that all perspectives and opinions are valued and included when examining the relationship between saving and spending.

F1.5 Consumer and Civic Awareness

describe some ways of determining whether something is reasonably priced and therefore a good purchase

Teacher supports

Key concepts

- In order to become better-informed consumers, it is important for students to critically consider the price of the purchase they are considering, as well as different ratings, reviews, and perspectives before, making a purchase.
- The habit of thoughtfully considering and examining potential purchases helps to determine the best value for money.

Mathematics, Grade 5

Expectations by strand

A. Social-Emotional Learning (SEL) Skills in Mathematics and the Mathematical Processes

This strand focuses on students' development and application of social-emotional learning skills to support their learning of math concepts and skills, foster their overall well-being and ability to learn, and help them build resilience and thrive as math learners. As they develop SEL skills, students demonstrate a greater ability to understand and apply the mathematical processes, which are critical to supporting learning in mathematics. In all grades of the mathematics program, the learning related to this strand takes place in the context of learning related to all other strands, and it should be assessed and evaluated within these contexts.

Overall expectations

Throughout this grade, in order to promote a positive identity as a math learner, to foster well-being and the ability to learn, build resilience, and thrive, students will:

A1. Social-Emotional Learning (SEL) Skills and the Mathematical Processes

apply, to the best of their ability, a variety of social-emotional learning skills to support their use of the mathematical processes and their learning in connection with the expectations in the other five strands of the mathematics curriculum

To the best of their ability, students will learn to:	... as they apply the mathematical processes :	... so they can:
1. identify and manage emotions	<ul style="list-style-type: none"> • problem solving: develop, select, and apply problem-solving strategies • reasoning and proving: develop and apply reasoning skills (e.g., classification, recognition of relationships, use of counter-examples) to justify thinking, make and investigate conjectures, and construct and defend arguments 	1. express and manage their feelings, and show understanding of the feelings of others, as they engage positively in mathematics activities
2. recognize sources of stress and cope with challenges	<ul style="list-style-type: none"> • reflecting: demonstrate that as they solve problems, they are pausing, looking back, and monitoring their thinking to help clarify their understanding (e.g., by comparing and adjusting strategies used, by explaining why they think their results are reasonable, by recording their thinking in a math journal) 	2. work through challenging math problems, understanding that their resourcefulness in using various strategies to respond to stress is helping them build personal resilience
3. maintain positive motivation and perseverance	<ul style="list-style-type: none"> • connecting: make connections among mathematical concepts, procedures, and representations, and relate mathematical ideas to other contexts (e.g., other curriculum areas, daily life, sports) 	3. recognize that testing out different approaches to problems and learning from mistakes is an important part of the learning process, and is aided by a sense of optimism and hope
4. build relationships and communicate effectively	<ul style="list-style-type: none"> • communicating: express and understand mathematical thinking, and engage in mathematical arguments using everyday language, language resources as necessary, appropriate mathematical terminology, a variety of representations, and mathematical conventions 	4. work collaboratively on math problems – expressing their thinking, listening to the thinking of others, and practising inclusivity – and in that way fostering healthy relationships
5. develop self-awareness and sense of identity	<ul style="list-style-type: none"> • representing: select from and create a variety of representations of mathematical ideas (e.g., 	5. see themselves as capable math learners, and strengthen their sense of ownership of their learning, as part of their emerging sense of identity and belonging

6. think critically and creatively	<p>representations involving physical models, pictures, numbers, variables, graphs), and apply them to solve problems</p> <ul style="list-style-type: none"> • selecting tools and strategies: select and use a variety of concrete, visual, and electronic learning tools and appropriate strategies to investigate mathematical ideas and to solve problems 	6. make connections between math and everyday contexts to help them make informed judgements and decisions
------------------------------------	---	--

B. Number

Overall expectations

By the end of Grade 5, students will:

B1. Number Sense

demonstrate an understanding of numbers and make connections to the way numbers are used in everyday life

Specific expectations

By the end of Grade 5, students will:

B1.1 Whole Numbers

read, represent, compose, and decompose whole numbers up to and including 100 000, using appropriate tools and strategies, and describe various ways they are used in everyday life

Teacher supports

Key concepts

- Reading numbers involves interpreting them as a quantity when they are expressed in words, in standard notation, in expanded notation, or on a number line.
- The numerals 0 to 9 are used to form numbers. They are referred to as the digits in a number, and each digit corresponds to a place value. For example, with the number 45 107, the digit 4 represents 4 ten thousands, the digit 5 represents 5 thousands, the digit 1 represents 1 hundred, the digit 0 represents 0 tens, and the digit 7 represents 7 ones.

- There are patterns to the way numbers are formed. Each place value period repeats the 0 to 9 counting sequence. Any quantity, no matter how great, can be described in terms of its place value.
- A number can be represented in expanded form as $34\,187 = 30\,000 + 4\,000 + 100 + 80 + 7$, or as $3 \times 10\,000 + 4 \times 1\,000 + 1 \times 100 + 3 \times 10 + 7$, to show place value relationships.
- Numbers can be composed and decomposed in various ways, including by place value.
- Numbers are composed when two or more numbers are combined to create a larger number. For example, the numbers 100 and 2 can be composed to make the sum 102 or the product 200.
- Numbers can be decomposed as a sum of numbers. For example, 53 125 can be decomposed into 50 000 and 3000 and 100 and 25.
- Numbers can be decomposed into their factors. For example, 81 can be decomposed into the factors 1, 3, 9, 27, and 81.
- Numbers are used throughout the day, in various ways and contexts. Most often numbers describe and compare quantities. They express magnitude, and provide a way to answer questions such as “how much?” and “how much more?”.

Note

- Every strand of mathematics relies on numbers.
- Numbers may have cultural significance.
- Seeing how a quantity relates to other quantities helps in understanding the magnitude, or “how muchness”, of a number.
- Closed number lines with appropriate scales can be used to represent numbers as a position on a number line or as a distance from zero. Depending on the number, estimation may be needed to represent it on a number line.
- Partial number lines can be used to show the position of a number relative to other numbers.
- Composing and decomposing numbers in a variety of ways can support students in becoming flexible with their mental math strategies.
- Open number lines can be used to show the composition or decomposition of large numbers without drawing the number line to scale.
- It is important for students to understand key aspects of place value. For example:
 - The order of the digits makes a difference. The number 21 385 describes a different quantity than 82 153.
 - The *place* (or position) of a digit determines its *value* (*place value*). The 5 in 51 981, for example, has a value of 50 000, not 5. To determine the value of a digit in a number, multiply the value of the digit by the value of its place. For example, in the number 15 236, the 5 represents 5000 (5×1000), and the 2 represents 200 (2×100).

- Expanded notation represents the values of each digit separately, as a sum. Using expanded form, 7287 is written $7287 = 7000 + 200 + 80 + 7$ or $7 \times 1000 + 2 \times 100 + 8 \times 10 + 7 \times 1$.
- A zero in a column indicates that there are no groups of that size in the number. It serves as a placeholder and holds the other digits in their correct “place”. For example, 189 means 1 hundred, 8 tens, and 9 ones, but 1089 means 1 thousand, 0 hundreds, 8 tens, and 9 ones.
- The value of the digits in each of the positions follows a “times 10” multiplicative pattern, when moving right to left. For example, 50 is 10 times greater than 5, and 500 is 10 times greater than 50. Conversely, a “divide ten” pattern is observed when moving from left to right. For example, 500 is 10 times smaller than 5000, and 50 is 10 times smaller than 500.
- Going from left to right, a “hundreds-tens-ones” pattern repeats within each period (units, thousands, millions, billions, and so on). Exposure to this larger pattern and the names of the periods – into millions and beyond – satisfies a natural curiosity around “big numbers”, although students at this grade do not need to work beyond 100 000.
- The number “seventy-eight thousand thirty-seven” is written as “78 037”, and not “78 000 37” (as if being spelled out with numbers). Listening for the period name (seventy-eight *thousand*) gives structure to the number and signals where a digit belongs. If there are no groups of that place value in a number, 0 is used to describe that amount, holding the other digits in their correct place.

Place Value Patterns

one billions	hundred millions	ten millions	one millions	hundred thousands	ten thousands	one thousands	hundreds	tens	ones

B1.2 Whole Numbers

compare and order whole numbers up to and including 100 000, in various contexts

Teacher supports

Key concepts

- Numbers are compared and ordered according to their “how muchness” or magnitude.
- Numbers with the same units can be compared directly (e.g., 72 cm² compared to 62 cm²). Numbers that do not show a unit are assumed to have units of ones (e.g., 75 and 12 are considered as 75 ones and 12 ones).

- Sometimes numbers without the same unit can be compared, such as 6200 kilometres and 6200 metres. Knowing that the unit *kilometre* is greater than the unit *metre*, and knowing that 6200 kilometres is greater than 6200 metres can allow one to infer that 6200 kilometres is a greater distance than 6200 metres.
- Sometimes numbers without the same unit may need to be rewritten to have the same unit in order to be compared. For example, 12 metres and 360 centimetres can be compared as 1200 centimetres and 360 centimetres. Therefore, 12 metres is greater than 360 centimetres.
- Benchmark numbers can be used to compare quantities. For example, 41 320 is less 50 000 and 62 000 is greater than 50 000, so 41 320 is less than 62 000.
- Numbers can be compared by their place value. For example, when comparing 82 150 and 84 150, the greatest place value where the numbers differ is compared. For this example, 2 thousands (from 82 150) and 4 thousands (from 84 150) are compared. Since 4 thousand is greater than 2 thousand, then 84 150 is greater than 82 150.
- Numbers can be ordered in ascending order – from least to greatest – or can be ordered in descending order – from greatest to least.

Note

- Numbers can be compared proportionally. For example, 100 000 is 10 times greater than 10 000; it is also 100 times greater than 1000. It would take 1000 hundred-dollar bills to make \$100 000.
- Depending on the context of the problem, numbers can be compared additively or multiplicatively.

B1.3 Fractions, Decimals, and Percents

represent equivalent fractions from halves to twelfths, including improper fractions and mixed numbers, using appropriate tools, in various contexts

Teacher supports

Key concepts

- Equivalent fractions describe the same relationship or quantity.
- When working with fractions as a quotient, equivalent fractions are ones that have the same result when the numerators are divided by the denominators.
- When working with fractions as a part of a whole, the partitions of the fraction can be split or merged to create equivalent fractions. The whole remains the same size.

- When working with fractions as a comparison, the ratios between the numerator and the denominator of equivalent fractions are equal.

Note

- Models and tools can be used to develop understanding of equivalent fractions. For example:
 - Fraction strips or other partitioned models, such as fraction circles, can be used to create the same area as the original fraction using split or merged partitions.
 - Strips of paper can be folded to show the splitting of partitions to create equivalence.
 - A double number line or a ratio table can be used to show equivalent fractions based on different scales.
- A fraction is a number that conveys a relationship between two quantities.
- A fraction can represent a quotient (division):
 - It shows the relationship between the number of wholes (numerator) and the number of partitions the whole is being divided into (denominator).
 - For example, 3 granola bars (3 wholes) are shared equally with 4 people (number of partitions), which can be expressed as $\frac{3}{4}$.
- A fraction can represent a part of a whole:
 - It shows the relationship between the number of parts selected (numerator) and the total number of parts in one whole (denominator).
 - For example, if 1 granola bar (1 whole) is partitioned into 4 pieces (partitions), each piece is one fourth ($\frac{1}{4}$) of the granola bar. Two pieces are 2 one fourths ($\frac{2}{4}$) of the granola bar, three pieces are 3 one fourths ($\frac{3}{4}$) of the granola bar, and four pieces are four one fourths ($\frac{4}{4}$) of the granola bar.
- A fraction can represent a comparison:
 - It shows the relationship between two parts of the same whole. The numerator is one part and the denominator is the other part.
 - For example, a bag has 3 red beads and 2 yellow beads. The fraction $\frac{2}{3}$ represents that there are two thirds as many yellow beads as red beads. The fraction $\frac{3}{2}$, which is $1\frac{1}{2}$ as a mixed number, represents that there are 1 and one half times more red beads than yellow beads.

- A fraction can represent an operator:
 - When considering fractions as an operator, the fraction increases or decreases a quantity by a factor.
 - For example, in the case of $\frac{3}{4}$ of a granola bar, $\frac{3}{4}$ of \$100, or $\frac{3}{4}$ of a rectangle, the fraction reduces the original quantity to $\frac{3}{4}$ its original size.

B1.4 Fractions, Decimals, and Percents

compare and order fractions from halves to twelfths, including improper fractions and mixed numbers, in various contexts

Teacher supports

Key concepts

- When working with fractions as parts of a whole, the fractions are compared to the same whole.
- Fractions can be compared spatially by using models to represent the fractions. If an area model is chosen, then the areas that the fractions represent are compared. If a linear model is chosen, then the lengths that the fractions represent are compared.
- If two fractions have the same denominator then the numerators can be compared. In this case the numerator with the greater value is the greater fraction because the number of parts considered is greater (e.g., $\frac{2}{3} > \frac{1}{3}$).
- If two fractions have the same numerators, then the denominators can be compared. In this case the denominator with the greater value is the smaller fraction because the size of each partition of the whole is smaller (e.g., $\frac{5}{6} < \frac{5}{3}$).
- Fractions can be compared by using the benchmark of "half" and considering each fraction relative to it. For example, $\frac{5}{6}$ is greater than $\frac{3}{8}$ because $\frac{5}{6}$ is greater than one half and $\frac{3}{8}$ is less than one half.
- Fractions can be ordered in ascending order – least to greatest – or in descending order – greatest to least.

Note:

- The choice of model used to compare fractions may be influenced by the context of the problem. For example:

- a linear model may be chosen when the problem is dealing with comparing things involving length, like lengths of a ribbon or distances.
- an area model may be chosen when the problem is dealing with comparing the area of two-dimensional shapes, like a garden or a flag.

B1.5 Fractions, Decimals, and Percents

read, represent, compare, and order decimal numbers up to hundredths, in various contexts

Teacher supports

Key concepts

- The place value of the first position to the right of the decimal point is tenths. The second position to the right of the decimal point is hundredths.
- Decimal numbers can be less than one (e.g., 0.65) or greater than one (e.g., 24.72).
- The one whole needs to be shown or explicitly indicated when decimal numbers are represented visually since their representation is relative to the whole.
- Decimal numbers can be compared and ordered by identifying the size of the decimal number visually relative to 1 whole. Using knowledge of fractions (e.g., $\frac{2}{10} > \frac{15}{100}$ or thinking about money (e.g., \$2.50 is more than \$2.05), are helpful strategies when comparing decimal numbers.

Note

- Between any two consecutive whole numbers are other numbers. Decimals are how the base ten number system shows these “in-between” numbers. For example, the number 3.62 describes a quantity between 3 and 4 and, more precisely, between 3.6 and 3.7.
- Decimals are sometimes called *decimal fractions* because they represent fractions with denominators of 10, 100, 1000, and so on. The first decimal place represents tenths, the second represents hundredths, and so on. Columns can be added indefinitely to describe smaller and smaller partitions. Decimals, like fractions, have what could be considered a numerator (a count of units) and a denominator (the value of the unit); however, with decimals, only the numerator is visible. The denominator (or unit) is “hidden” within the place value convention.
- The decimal point indicates the location of the unit. The unit is always to the left of the decimal point. There is symmetry around the *ones* column, so tens are matched by tenths, and hundreds are matched by hundredths. Note that the symmetry does not revolve around the *decimal*, so there is no “oneth”.

Place Value Symmetry

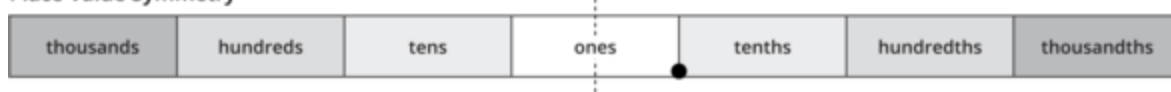

- Between any two places in the base ten system, there is a constant 10:1 ratio, and this is true for decimals as well. If a digit shifts one space to the right it becomes one tenth as great, and if it shifts two spaces to the right it becomes one hundredth as great. So, 0.05 is one tenth as great as 0.5 and one hundredth as great as 5. It also means that 5 is 100 times as great as 0.05, in the same way that there are 100 nickels (\$0.05) in \$5.00.
- As with whole numbers, a zero in a decimal indicates that there are no groups of that size in the number:
 - 5.07 means 5 ones, 0 tenths, 7 hundredths.
 - 5.10 means 5 ones, 1 tenth, 0 hundredths.
 - 5.1 (five and one tenth) and 5.10 (5 and 10 hundredths) are equivalent (although writing zero in the tenths and hundredths position can indicate the precision of a measurement; for example, the race was won by 5.00 seconds and the winning time was 19.29 seconds).
- Decimals are read in a variety of ways in everyday life. Decimals like 2.5 are commonly read as two point five; in math, the term π (π) is commonly approximated as three point one four; the decimal in baseball averages is typically ignored; and decimals used in numbered lists function merely as labels, like in a numbered list. However, to reinforce the decimal's connection to fractions, and to make visible its place value denominator, it is recommended that decimals be read as their fraction equivalent. So, 2.57 should be read as "2 and 57 hundredths".
- Decimals can be compared and ordered like any other numbers, including fractions. Like fractions, decimals describe an amount that is relative to the whole.
- Many of the tools that are used to represent whole numbers can also be used to represent decimal numbers. It is important to emphasize 1 whole to recognize the representation in tenths and hundredths and not as wholes. For example, a base ten rod that was used to represent 10 ones can be used to represent 1 whole that is partitioned into tenths, and a base ten flat that was used to represent 100 ones can be used to represent 1 whole that is partitioned into hundredths.

B1.6 Fractions, Decimals, and Percents

round decimal numbers to the nearest tenth, in various contexts

Teacher supports

Key concepts

- Rounding makes a number simpler to work with and is often used when estimating computations, measuring, and making quick comparisons.
- Rounding compares a number to a given reference point – is it closer to this or to that? For example, is 1.75 closer to 1 or to 2? Is 1.84 closer to 1.8 or to 1.9?
 - Rounding 56.23 to the nearest tenth becomes 56.2, since 56.23 is closer to 56.2 than 56.3 (it is three hundredths away from 56.2 versus seven hundredths away from 56.3).
 - Rounding 56.28 to the nearest tenth becomes 56.3, since 56.28 is closer to 56.3 than 56.2.
 - If a decimal hundredth is exactly between two decimal tenths, the convention is to round up, unless the context suggests differently (e.g., 56.25 is rounded to 56.3.)
- In the absence of a context, numbers are typically rounded around the midpoint.

Note

- As with whole numbers, rounding decimal numbers involves making decisions about the level of precision needed. Whether a number is rounded up or down depends on the context and whether an overestimate or an underestimate is preferred.

B1.7 Fractions, Decimals, and Percents

describe relationships and show equivalences among fractions, decimal numbers up to hundredths, and whole number percents, using appropriate tools and drawings, in various contexts

Teacher supports

Key concepts

- Fractions, decimals, and percents all describe relationships to a whole. While fractions may use any number as a denominator, decimal units are in powers of ten (tenths, hundredths, and so on) and percents express a rate out of 100 (“percent” means “per hundred”). For both decimals and percents, the “denominator” (the value of the unit or the divisor) is hidden within the convention itself (i.e., the place value convention and the percent sign).
- Percent is a special rate, “per 100”, and can be represented with the symbol %. The whole is partitioned into 100 equal parts. Each part is one percent, or 1%, of the whole.

- The unit fraction $\frac{1}{100}$ expressed as a quotient is $1 \div 100$ and the result is 0.01, which is read as one hundredth. This unit fraction and its decimal equivalent are equal to 1%.
 - Any fraction can be expressed as a fraction with a denominator of 100.
 - A decimal hundredth can be rewritten as a whole number percent (e.g., $0.56 = 56\%$).
 - If a fraction or decimal number can be expressed as a hundredth, it can be expressed as a whole number percent. For example, $\frac{4}{5}$ is equivalent to $\frac{80}{100}$, and 0.8 is equivalent to 0.80, and they are both equivalent to 80%.

- Common benchmark percentages include:
 - $1\% = \frac{1}{100} = 0.01$
 - $10\%, 20\%, 30\%, \dots = \frac{1}{10}, \frac{2}{10}, \frac{3}{10}, \dots = 0.1, 0.2, 0.3, \dots$
 - $20\% = \frac{1}{5}$ or $\frac{2}{10} = 0.2$
 - $25\% = \frac{1}{4} = 0.25$
 - $50\% = \frac{1}{2} = 0.5$
 - $75\% = \frac{3}{4} = 0.75$
 - $100\% = 1 = 1.00$

- A percent can be greater than 100% (e.g., $150\% = \frac{150}{100} = 1.50$).
- Some fractions are easier than others to express with a denominator of 100.

B2. Operations

use knowledge of numbers and operations to solve mathematical problems encountered in everyday life

Specific expectations

By the end of Grade 5, students will:

B2.1 Properties and Relationships

use the properties of operations, and the relationships between operations, to solve problems involving whole numbers and decimal numbers, including those requiring more than one operation, and check calculations

Teacher supports

Key concepts

- The *commutative* property holds true for addition and for multiplication. The order in which the numbers are added or multiplied does not matter; the results will be the same (e.g., $45 + 62 = 62 + 45$ and $12 \times 6 = 6 \times 12$).
- The *associative* property holds true for addition and for multiplication. The pairs of numbers first added or multiplied does not matter; the results will be the same. For example, $(24 + 365) + 15 = 24 + (365 + 15)$. Similarly, $(12 \times 3) \times 5 = 12 \times (3 \times 5)$.
- The *distributive* property can be used to determine the product of two numbers. For example, to determine 12×7 the 12 can be rewritten as 10 and 2 and the sum of their products is determined (i.e., $12 \times 7 = (10 + 2) \times 7$, which is $(10 \times 7) + (2 \times 7)$).
- Addition and subtraction are inverse operations. Any subtraction question can be thought of as an addition question (e.g., $154 - 48 = ?$ is the same as $48 + ? = 154$). This inverse relationship can be used to perform and check calculations.
- Multiplication and division are inverse operations. Any division question can be thought of as a multiplication question, unless 0 is involved (e.g., $132 \div 11 = ?$ is the same as $? \times 11 = 132$) and vice versa. This inverse relationship can be used to perform and check calculations.
- Sometimes a property may be used to check an answer. For example, 12×7 may be first determined using the distributive property as $(10 \times 7) + (2 \times 7)$. The factors could also be decomposed as $2 \times 6 \times 7$ and the associative property applied: $2 \times (6 \times 7)$ to verify the results.
- Sometimes the reverse operation may be used to check an answer. For example, $32 \div 4 = 8$ could be checked by multiplying 4 and 8 to determine if it equals 32.

Note

- This expectation supports most other expectations in the Number strand and is applied throughout the grade. Whether working with numbers or operations, recognizing and applying properties and relationships builds a strong foundation for doing mathematics.

- When addition is used to solve a subtraction question, this is often referred to as finding the missing addend.
- Addition and subtraction strategies can be used to think about and solve multiplication and division questions (see **SEs B2.6** and **B2.7**).
- The context of a problem may influence how students think about performing the calculations.
- Operation sense involves the ability to represent situations with symbols and numbers. Understanding the meaning of the operations, and the relationships between and amongst them, enables one to choose the operation that most closely represents a situation and most efficiently solves the problem given the tools at hand.
- Solving problems with more than one operation involves similar processes to solving problems with a single operation. For both types of problems:
 - Identify the actions and quantities in a problem and what is known and unknown.
 - Represent the actions and quantities with a diagram (physically or mentally).
 - Choose the operation(s) that match the actions to write the equation.
 - Solve by using the diagram (counting) or the equation (calculating).
- In multi-operation problems, sometimes known as two-step problems, there is an *ultimate* question (asking for the final answer or result being sought), and a *hidden* question (a step or calculation that must be taken to get to the final result). Identifying both questions is a critical part of solving these types of problems.
- The actions in a situation inform the choice of operation. The same operation can describe different situations:
 - Does the situation involve changing (joining, separating), combining, or comparing? Then the situation can be represented with addition and subtraction.
 - Does the situation involve equal groups (or rates), ratio comparisons, or arrays? Then the situation can be represented with multiplication and division.
- Representing a situation as an equation is often helpful for solving a problem. Identifying what is known and unknown in a situation informs how an equation is structured:
 - For addition and subtraction, is the start, change, or result unknown? Addition determines an unknown result. Subtraction determines an unknown starting amount or the amount of change.
 - For multiplication and division, is the total, the number of groups, or the size of the groups unknown? Multiplication names the unknown total (the product). Division determines either the unknown number of groups (quotative or grouping division) or the unknown size of each group (partitive or sharing division).

B2.2 Math Facts

recall and demonstrate multiplication facts from 0×0 to 12×12 , and related division facts

Teacher supports

Key concepts

- The identity principle states that when multiplying an amount by 1 or dividing an amount by 1, the amount stays the same (e.g., $1 \times 5 = 5$ and $5 \div 1 = 5$).
- The facts of 1, 2, 5, and 10 can be used to determine the facts for other numbers. For example:
 - 2×12 can be determined by knowing 12×2 .
 - 7×12 can be determined by knowing 7×10 and adding two more 7s.
 - 8×12 can be determined by knowing $(8 \times 5) + (8 \times 5) + (8 \times 2)$, which is $40 + 40 + 16$, or 96.
- Division facts can be determined using multiplication facts (e.g., $24 \div 6$ can be determined using the multiplication facts for 6).
- When multiplying any number by zero, the result is zero. For example, 5 groups of zero is $0 + 0 + 0 + 0 + 0 = 0$. Also, zero groups of anything is nothing.
- Zero divided by any non-zero number is zero. For example, $\frac{0}{5} = n$ can be rewritten as $5 \times n = 0$. If 5 represents the number of groups and n represents the number of items in each group, then there must be zero items in each group.
- Any number divided by zero has no meaning and is said to be “undefined”. For example, there is no answer to the question, “How many groups of 0 are in 5?”

Note

- Automatic recall of math facts is an important foundation for doing calculations, both mentally and with paper and pencil. For example, knowing facts up to 12 is important for mentally converting inches to feet, units that are commonly used in everyday life.
- The commutative property of multiplication (e.g., $11 \times 12 = 12 \times 11$) reduces, by almost half, the number of facts to be learned and recalled.
- The distributive property means that a multiplication problem can be split (decomposed) into smaller parts, and the products of those smaller parts can be added together (composed) to get the total. It enables a known fact to be used to find an unknown fact. For example, in building on the facts for 1 to 10:

- Multiplication by 11 adds one more row to the corresponding 10 fact; there are also interesting patterns in the 11 facts up to $\times 9$ that make them quick to memorize.
- Multiplication by 12 adds a double of what is being multiplied to the corresponding 10 fact; it can also be thought of as the double of the corresponding $\times 6$ fact.
- The associative property means that the $\times 12$ facts can be decomposed into factors and rearranged to make a mental calculation easier. For example, 5×12 can be thought of as $5 \times 6 \times 2$ or double 30.
- Practice is important for moving from understanding to automaticity. Practising with one set of number facts at a time (e.g., the 11 facts) helps build understanding and a more strategic approach to learning the facts.

B2.3 Mental Math

use mental math strategies to multiply whole numbers by 0.1 and 0.01 and estimate sums and differences of decimal numbers up to hundredths, and explain the strategies used

Teacher supports

Key concepts

- The inverse relationship between multiplication and division helps when doing mental math with powers of ten.
- Multiplying a number by 0.1 is the same as dividing a number by 10. Therefore, a shifting of the digit(s) to the right by one place can be visualized. For example, $500 \times 0.1 = 50$; $50 \times 0.1 = 5$; and $5 \times 0.1 = 0.5$.
- Multiplying a number by 0.01 is the same as dividing a number by 100. Therefore, a shifting of the digit(s) to the right by two places can be visualized. For example, $500 \times 0.01 = 5$; $50 \times 0.01 = 0.5$; and $5 \times 0.01 = 0.05$.
- Mental math strategies for addition and subtraction of whole numbers can be used with decimal numbers. The strategies may vary depending on the numbers given. For example:
 - If given $0.12 + 0.15$, the like units can be combined to get 0.27.
 - If given $44 - 31.49$, 31.49 can be rounded to 31.5, and then 31.5 subtracted from 44 to get 12.5.

Note

- Mental math may or may not be quicker than paper-and-pencil strategies, but speed is not the goal. The value of mental math is in its portability and flexibility, since it does not require a calculator or paper and pencil. Practising mental math strategies also deepens an understanding of numbers.
- Mental math involves using flexible strategies that build on basic facts, number relationships, and counting.
- As numbers and calculations become too difficult to keep track of mentally, partial quantities are written down and totalled as a separate step.
- When adding and subtracting numbers, the like units are combined. For example, hundreds with hundreds, tens with tens, ones with ones, tenths with tenths, and hundredths with hundredths.
- Estimation can be used to check the reasonableness of calculations and should be continually encouraged when students are doing mathematics.

B2.4 Addition and Subtraction

represent and solve problems involving the addition and subtraction of whole numbers that add up to no more than 100 000, and of decimal numbers up to hundredths, using appropriate tools, strategies, and algorithms

Teacher supports

Key concepts

- Situations involving addition and subtraction may involve:
 - adding a quantity on to an existing amount or removing a quantity from an existing amount;
 - combining two or more quantities;
 - comparing quantities.
- Acting out a situation, by representing it with objects, a drawing or a diagram, can help identify the quantities given in a problem and what quantity needs to be determined.
- Set models can be used to add a quantity on to an existing amount or to remove a quantity from an existing amount.
- Linear models can be used to determine the difference by comparing two quantities.
- Part-whole models can be used to show the relationship between what is known and what is unknown and how addition and subtraction relate to the situation.

Note

- An important part of problem solving is the ability to choose the operation that matches the action in a situation. For additive situations – situations that involve addition or subtraction – there are three “problem types”:
 - *Change* situations, where one quantity is changed by having an amount either *joined* to it or *separated* from it. Sometimes the result is unknown; sometimes the starting point is unknown; sometimes the change is unknown.
 - *Combine* situations, where two quantities are *combined*. Sometimes one part is unknown; sometimes the other part is unknown; sometimes the result is unknown.
 - *Compare* situations, where two quantities are being *compared*. Sometimes the larger amount is unknown; sometimes the smaller amount is unknown; sometimes the difference between the two amounts is unknown.
- A variety of strategies may be used to add or subtract, including algorithms.
- An algorithm describes a process or set of steps to carry out a procedure. A standard algorithm is one that is known and used by a community. Different cultures have different standard algorithms that they use to perform calculations.
- The most common standard algorithms for addition and subtraction in North America use a compact organizer to *decompose* and *compose* numbers based on place value. They begin with the smallest unit – whether it is the unit (ones) column, decimal tenths, or decimal hundredths – and use regrouping or trading strategies to carry out the computation. (See **Grade 4, SE B2.4**, for a notated subtraction example with decimals and **Grade 3, SE B2.4**, for a notated addition example with whole numbers; the same process applies to decimal hundredths.)
- When carrying out an addition or subtraction algorithm, only common units can be combined or separated. This is particularly noteworthy when using the North American standard algorithms with decimals because unlike with whole numbers, the smallest unit in a number is not always common (e.g., $90 - 24.7$). The expression “line up the decimals” is really about making sure that common units are aligned. Using a zero as a placeholder is one strategy to align unit values. Unpacking the compactness and efficiency of the standard algorithm strengthens understanding of place value and the properties of addition and subtraction.

B2.5 Addition and Subtraction

add and subtract fractions with like denominators, in various contexts

Teacher supports

Key concepts

- As with whole numbers and decimal numbers, only common units can be combined or separated. This is also true for fractions. Adding fractions with like denominators is the same as adding anything with like units:
 - 3 apples and 2 apples are 5 apples.
 - 3 fourths and 2 fourths are 5 fourths.
- Fractions with the same denominator can be added by combining the counts of their unit. For example, 3 one fourths and 2 one fourths are 5 one fourths (i.e., $\frac{3}{4} + \frac{2}{4} = \frac{5}{4}$).
- Fractions with the same denominator can be subtracted by comparing the counts of their unit. For example, 7 one fourths is more than 2 one fourths by 5 one fourths (i.e., $\frac{7}{4} - \frac{2}{4} = \frac{5}{4}$).

Note

- The numerator in a fraction can describe the count of unit fractions (e.g., 4 one thirds is written in standard fractional form as $\frac{4}{3}$).
- The type of models and tools that are used to represent the addition or subtraction of fractions with like denominators can vary depending on the context. For example:
 - Hops on a number line may represent adding a fraction on to an existing amount or subtracting a fraction from an existing amount. The existing amounts are positions on a number line.
 - An area model may be used to combine fractional areas or remove fractional areas.

B2.6 Multiplication and Division

represent and solve problems involving the multiplication of two-digit whole numbers by two-digit whole numbers using the area model and using algorithms, and make connections between the two methods

Teacher supports

Key concepts

- Numbers multiplied together are called factors, and their result is called a product.
- The multiplication of two two-digit numbers using the distributive property can be modelled as the area of a rectangle:

- When the dimensions of a rectangle are decomposed, the area is also decomposed.
 - When the two-digit length is decomposed into tens and ones, and the two-digit width is decomposed into tens and ones, the area is subdivided into four areas – tens by tens, ones by tens, tens by ones, and ones by ones.
 - Known facts can be used to determine each of the smaller areas.
 - The smaller areas are added together resulting in the product.
- The area model is a visual model of the standard algorithm showing the sum of the partial products.
 - The product can be determined using an area model or the standard algorithm.

Note

- The context of multiplication problems may involve:
 - repeated equal groups;
 - scale factors – ratio comparisons, rates, and scaling;
 - area measures;
 - combinations of attributes given two or more sets (see **Data, D2.2**).
- The array can be a useful model for showing multiplication and division because it structures repeated groups of equal size into rows and columns. The array makes visual connections to skip counting, the distributive property, the inverse relationship between multiplication and division, and the measurement of area.
- The area model using a rectangle is sometimes referred to as an open array. Even though the area model can be used to represent the multiplication of any two numbers, support students in not confusing it with the actual context of the problem.
- Open arrays show how a multiplication statement can be thought of as the area of a rectangle ($b \times h$). An unknown product is decomposed into partial products (smaller rectangles) with “dimensions” that access known facts and friendly numbers. The partial products are then totalled (see **Grade 4, SE B2.4**, for more details). Standard algorithms for multiplication are based on the distributive property.
- The most common standard algorithm for multiplication in North America is a compact and efficient organizer that decomposes factors based on the distributive property. It creates partial products, which are then added together to give the total product. There are variations on how this algorithm is recorded, with some being more compact than others; however, the underlying process is the same. Priority should be given to understanding, especially when an algorithm is first introduced.

What It Looks Like

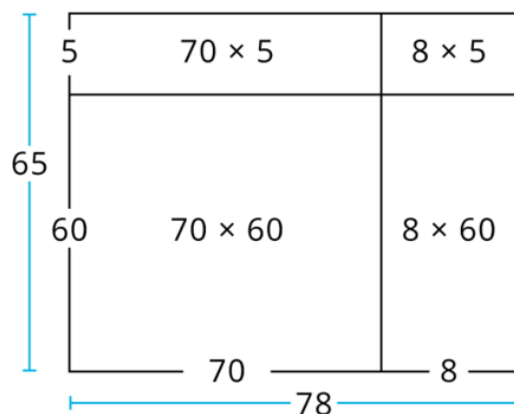

How It Is Written		What It Means	
Variation 1	Variation 2		
$\begin{array}{r} 78 \\ \times 65 \\ \hline \end{array}$	$\begin{array}{r} 78 \\ \times 65 \\ \hline \end{array}$		
$\begin{array}{r} 390 \\ \hline \end{array}$	$\left\{ \begin{array}{l} 40 \\ 350 \end{array} \right.$	$\rightarrow 5 \times 8 = 40$ $\rightarrow 5 \times 70 = 350$	
$\begin{array}{r} 4680 \\ \hline \end{array}$	$\left\{ \begin{array}{l} 480 \\ 4200 \end{array} \right.$	$\rightarrow 60 \times 8 = 480$ $\rightarrow 60 \times 70 = 4200$	
$\begin{array}{r} 5070 \\ \hline \end{array}$	$\begin{array}{r} 5070 \\ \hline \end{array}$		

B2.7 Multiplication and Division

represent and solve problems involving the division of three-digit whole numbers by two-digit whole numbers using the area model and using algorithms, and make connections between the two methods, while expressing any remainder appropriately

Teacher supports

Key concepts

- Multiplication and division are inverse operations (see **B2.1**).
 - The numbers multiplied together are called factors. The result of a multiplication is called the product.

- When a multiplication statement is rewritten as a division statement, the product is referred to as the dividend, one of the factors is the divisor, and the other factor is the quotient (result of division).
- Using the area model of a rectangle to solve a division question draws on multiplication as its inverse operation. A rectangle is gradually created by arranging all the square units (dividend) into rows and columns for a given dimension (divisor).
- Determining the quotient using an algorithm requires an understanding of place value, multiplication facts, and subtraction.
- Division does not always result in whole number amounts. For example, $320 \div 15$ is 21 with a remainder of 5, which can also be expressed as $\frac{5}{15}$ or one third.
- The context of a problem can influence how the remainder is represented and interpreted. For example:
 - A rope is 320 cm long and is divided into 15 equal sections; how long is each section? ($320 \div 15 = ?$). Each section is $21\frac{1}{3}$ centimetres. In this case, measuring $\frac{1}{3}$ of a centimetre of ribbon is possible, given that it is a linear dimension.
 - A van holds 18 students. There are 45 students. How many vans are needed to transport the students? Dividing 45 by 18 means that 2.5 vans are needed. This requires rounding up to 3 vans.

Note

- The context of a division problem may involve:
 - repeated equal groups;
 - scale factors – ratio comparisons, rates, and scaling (see **Grade 3, SE B2.9**);
 - area measures;
 - combinations of attributes.
- Multiplication and division are related and therefore the rectangle area model can be used to show how a division question can be solved using repeated addition or repeated subtraction. The area model using a rectangle is sometimes referred to as an open array. Even though the area model can be used to represent division, support students in not confusing it with the actual context of the problem.
- For each division situation, there are two division types:
 - equal-sharing division (sometimes called partitive division):
 - *What is known:* the *total* and *number* of groups;
 - *What is unknown:* the *size* of the groups;

- *The action*: a total is shared equally among a given number of groups.
 - equal-grouping division (sometimes called measurement or quotative division):
 - *What is known*: the *total* and the *size* of groups.
 - *What is unknown*: the *number* of groups.
 - *The action*: from a total, equal groups of a given size are measured.
- Note that since area situations use *base* and *height* to describe the size and number of groups, and because these dimensions are interchangeable, the two types of division are indistinguishable.
- Often division does not result in whole number amounts. In the absence of a context, remainders can be treated as a leftover quantity, or they can be distributed equally as fractional parts across the groups. For example, the answer to $17 \div 5$ can be written as 3 with 2 remaining, or as 3 and $\frac{2}{5}$, where the 2 left over are distributed among 5. So, the result is $3\frac{2}{5}$ or 3.4.
- In real-world situations, the context determines how a remainder should be dealt with:
 - Sometimes the remainder is ignored, leaving a smaller amount (e.g., how many boxes of 5 can be made from 17 items?).
 - Sometimes the remainder is rounded up, producing a greater amount (e.g., how many boxes are needed to pack 17 items into boxes of 5?).
 - Sometimes the remainder is rounded to the nearest whole number, producing an approximation (e.g., if 5 people share 17 items, approximately how many will each receive?).
- There are two common algorithms used for division in North America (with variations on each). In both algorithms the recording scheme is not immediately clear, and both will require direct instruction for students to understand and replicate the procedure. Visual models are very important for building conceptual understanding.
 - The most common division algorithm, sometimes referred to as “long division” or “bring-down division”, decomposes the total using place value. Unlike other algorithms, this algorithm starts at the left and moves to the right. Column by column, it “shares” each place-value amount and trades the remainder for smaller pieces, which it adds to the amount in the next column. The partial quotients are then added together for the full quotient. Note that there are variations in how long division is recorded for this algorithm.

Variation 1	Variation 2
$\begin{array}{r l} 1 & \\ 30 & 31\frac{3}{12} \\ \hline 12 \overline{)375} & \\ - 360 & \\ \hline 15 & \\ - 12 & \\ \hline 3 & \end{array}$	$\begin{array}{r l} & 31\frac{3}{12} \\ \hline 12 \overline{)375} & \\ - 36\downarrow & \\ \hline 15 & \\ - 12 & \\ \hline 3 & \end{array}$

- Another well-known algorithm, sometimes called the “repeated subtraction” or “grouping division” algorithm, uses estimation and “think multiplication” to produce partial products. The partial products can be groups of any size, and are determined by a combination of estimation strategies, known facts, and mental strategies. Unlike other algorithms, the amount to be shared is not decomposed into place-value partitions but is considered as a whole.

$$\begin{array}{r|l} 31\frac{3}{12} & \\ \hline 12 \overline{)375} & \\ - 240 & \times 20 \\ \hline 135 & \\ - 120 & \times 10 \\ \hline 15 & \\ - 12 & \times 1 \\ \hline 3 & 31 \end{array}$$

B2.8 Multiplication and Division

multiply and divide one-digit whole numbers by unit fractions, using appropriate tools and drawings

Teacher supports

Key concepts

- Multiplication and division can describe situations involving repeated equal groups.
- The multiplication of a whole number with a unit fraction such as $4 \times \frac{1}{3}$ can be interpreted as 4 groups of one third of a whole and can be determined using repeated addition. For example, $4 \times \frac{1}{3} = 4$ one thirds $= \frac{1}{3} + \frac{1}{3} + \frac{1}{3} + \frac{1}{3} = \frac{4}{3}$.

- Since multiplication and division are inverse operations, the division of a whole number by a unit fraction such as $4 \div \frac{1}{3}$ can be interpreted as “How many one thirds are in 4 wholes?” Since it takes 3 one thirds to make 1 whole, it will take four times as many to make 4 wholes, so $4 \div \frac{1}{3} = 12$.

Note

- Counting unit fractions, adding unit fractions with like denominators, and multiplying unit fractions all represent the same action of repeating (or iterating) an equal group, in this case a unit fraction. This count is also reflected in the numerator.
- The use of drawings, tools (fraction strips, number lines), and objects can help visualize the role of the unit fraction to solve multiplication and division problems.

B2.9 Multiplication and Division

represent and create equivalent ratios and rates, using a variety of tools and models, in various contexts

Teacher supports

Key concepts

- A ratio describes the multiplicative relationship between two quantities.
- Ratios can compare one part to another part of the same whole, or a part to the whole. For example, if there are 12 beads in a bag that has 6 yellow beads and 6 blue beads, then:
 - the ratio of yellow beads to blue beads is 6 to 6 (6 : 6) or 1 to 1 because there is one yellow bead for every blue bead;
 - the ratio of yellow beads to the total number of beads is 6 to 12 (6 : 12) or 1 to 2, and this can be interpreted as one half of the beads in the bag are yellow, or that there are twice as many beads in the bag than the number that are yellow.
- Determining equivalent ratios involves scaling up or down. The ratio of blue marbles to red marbles (10 : 15) can be scaled down to 2 : 3 or scaled up to 20 : 30. In all cases, there are two thirds ($\frac{2}{3}$) as many blue marbles as red marbles.
- A rate describes the multiplicative relationship between two quantities expressed with different units. For example, 1 dime to 10 cents can be expressed as 1 dime per 10 cents or 2 dimes per 20 cents, or 3 dimes per 30 cents and so on.

Note

- Ratios compare two (or more) different quantities to each other using multiplication or division. This means the comparison is *relative* rather than *absolute*. For example, if there are 10 blue marbles and 15 red marbles:
 - an absolute comparison uses addition and subtraction to determine that there are 5 more red marbles than blue ones;
 - a relative comparison uses multiplication and division to determine that there are $\frac{2}{3}$ as many blue marbles as red marbles.
- Like ratios, rates make comparisons based on multiplication and division; however, rates compare two related but different measures or quantities. For example, if 12 cookies are eaten by 4 people, the rate is 12 cookies per 4 people. An equivalent rate is 6 cookies per 2 people. A unit rate is 3 cookies per person.
- A three-term ratio shows the relationship between three quantities. The multiplicative relationship can differ among the three terms. For example, there are 6 yellow beads, 9 red beads, and 2 white beads in a bag. This situation can be expressed as a ratio of yellow : red : white = 6 : 9 : 2. The multiplicative relationship between yellow to white is 6 : 2 or 3 : 1, meaning there are three times more yellow beads than white beads. The multiplicative relationship between yellow and red beads is 6 : 9 or 2 : 3, meaning there are two thirds as many yellow beads as there are red beads.
- A ratio table is very helpful for noticing patterns when a ratio or rate is scaled up or down. Ratio tables connect scaling to repeated addition, multiplication and division, and proportional reasoning.
- A ratio or rate relationship can also be described using fractions, decimals, and percents.

C. Algebra

Overall expectations

By the end of Grade 5, students will:

C1. Patterns and Relationships

identify, describe, extend, create, and make predictions about a variety of patterns, including those found in real-life contexts

Specific expectations

By the end of Grade 5, students will:

C1.1 Patterns

identify and describe repeating, growing, and shrinking patterns, including patterns found in real-life contexts

Teacher supports

Key concepts

- Repeating patterns have a pattern core that is repeated over and over.
- In growing patterns, there is an increase in the number of elements or the size of the elements from one term to the next.
- In shrinking patterns, there is a decrease in the number of elements or the size of the elements from one term to the next.
- Many real-life objects and events can be viewed as having more than one type of pattern.

Note

- Growing and shrinking patterns are not limited to linear patterns.

C1.2 Patterns

create and translate growing and shrinking patterns using various representations, including tables of values and graphs

Teacher supports

Key concepts

- Growing patterns are created by increasing the number of elements or the size of the elements in each iteration (term).
- A growing pattern can be created by repeating a pattern's core. Each iteration shows how the total number of elements grows with each addition of the pattern core.

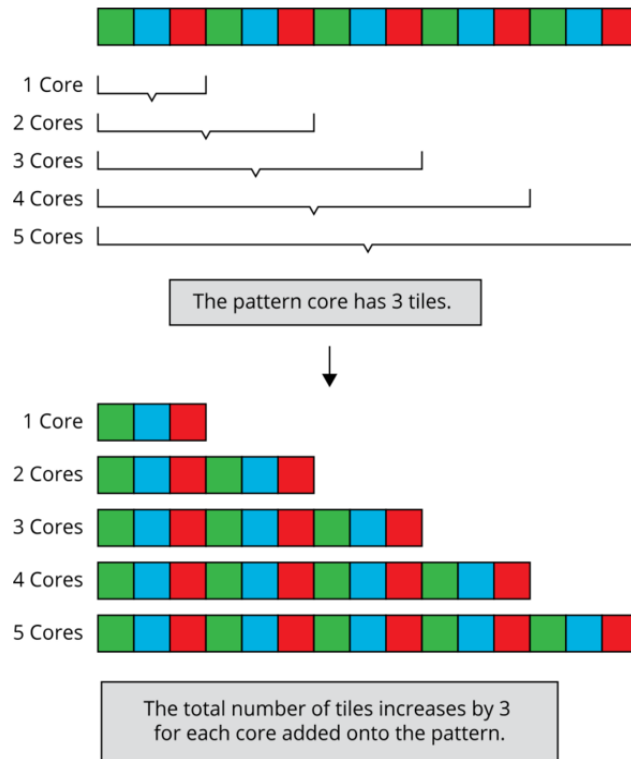

- Shrinking patterns are created by decreasing the number of elements or the size of the elements in each iteration.
- In translating a pattern from a concrete representation to a table of values and a graph, each iteration of the pattern can be referred to as the term number, and the number of elements in each iteration can be referred to as the term value. The term value is dependent on the term number. The term number (x) is represented on the horizontal axis of the Cartesian plane, and the term value (y) is represented on the vertical axis. Each point (x, y) on the Cartesian plane is plotted to represent the pattern. In a table of values, the term number is shown in the left-hand column and the term value is shown in the right-hand column.
- A pattern's structure is the same when a pattern is translated from one representation to another.

Note

- The creation of growing and shrinking patterns in this grade is not limited to linear patterns.
- For (x, y) , the x -value is the independent variable and the y -value is the dependent variable.

C1.3 Patterns

determine pattern rules and use them to extend patterns, make and justify predictions, and identify missing elements in repeating, growing, and shrinking patterns

Teacher supports

Key concepts

- Patterns can be extended because they are repetitive by nature.
- Pattern rules are generalizations about a pattern, and they can be described in words.
- Patterns can be extended in multiple directions, showing what comes next and what came before.
- To make a near prediction about a pattern is to state or show what a pattern will look like just beyond the given representation of that pattern. The prediction can be verified by extending that pattern.
- To make a far prediction about a pattern is to state or show what a pattern will look like well beyond the given representation of that pattern. Often calculations are needed to make an informed prediction that can be justified.
- Identifying the missing elements in a pattern represented using a table of values may require determining the term number (x) or the term value (y).
- Identifying the missing elements in a pattern represented on a graph may require determining a point (x, y) within the given representation or beyond it, in which case the pattern will need to be extended.
- The algebraic expression that represents a linear growing pattern is also referred to as the general term or the n th term. It can be used to solve for the term value or the term number.

Note

- Determining a point within the graphical representation of a pattern is called interpolating.
- Determining a point beyond the graphical representation of a pattern is called extrapolating.

C1.4 Patterns

create and describe patterns to illustrate relationships among whole numbers and decimal tenths and hundredths

Teacher supports

Key concepts

- Patterns can be used to understand relationships among numbers.
- There are many patterns within the decimal number system.

Note

- Many number strings are based on patterns and on the use of patterns to develop a mathematical concept.
- The use of the word “strings” in coding is different from its use in “number strings”.

C2. Equations and Inequalities

demonstrate an understanding of variables, expressions, equalities, and inequalities, and apply this understanding in various contexts

Specific expectations

By the end of Grade 5, students will:

C2.1 Variables and Expressions

translate among words, algebraic expressions, and visual representations that describe equivalent relationships

Teacher supports

Key concepts

- Algebraic expressions are a combination of variables, operations, and numbers, such as $3a$ and $a + b$.
- Algebraic expressions are used to generalize relationships. For example, the perimeter of a square is four times its side length (s), which can be expressed as $4s$.
- For expressions like $3a$, it is understood that the operation between the number, 3, and the variable, a , is multiplication.
- When two expressions are set with an equal sign, it is called an equation.

Note

- The letter x is often used as a variable. It is important for students to know when it is being used as a variable.

- The letters used as a symbol are often representative of the words they represent. For example, the letters l and w are often used to represent the *length* and *width* of a rectangle, and also the formula for the area of a rectangle, $A = lw$.
- Many forms of technology require expressions like $3a$ to be entered as $3*a$, where the asterisk is used to denote multiplication. The expression $a \div 2$ is entered as $a/2$.
- Words and abbreviated words are used in a variety of coding languages to represent variables and expressions. For example, in the instruction: “input ‘the side length of a square’, sideA”, the computer is defining the variable sideA and stores whatever the user inputs into its temporary location.

C2.2 Variables and Expressions

evaluate algebraic expressions that involve whole numbers

Teacher supports

Key concepts

- To evaluate an algebraic expression, the variables are replaced with numerical values and calculations are performed based on the order of operations.

Note

- When students are working with formulas, they are evaluating expressions.
- Replacing the variables with numerical values often requires the use of brackets. For example, the expression $4s$ becomes $4(s)$ and then $4(5)$ when $s = 5$. The operation between 4 and (5) is understood to be multiplication.
- Many coding applications involve algebraic expressions being evaluated, and this may be carried out in several steps. For example, the instruction: “input ‘the side of a square’, sideA” is instructing the computer to define the variable sideA and store whatever the user inputs into the temporary location called sideA. The instruction: “calculate $4*sideA$, perimeterA” instructs the computer to take the value that is stored in “sideA” and multiply it by 4, and then store that result in the temporary location, which is another variable, called perimeterA.

C2.3 Equalities and Inequalities

solve equations that involve whole numbers up to 100 in various contexts, and verify solutions

Teacher supports

Key concepts

- Equations are mathematical statements such that the expressions on both sides of the equal sign are equivalent.
- In equations, variables are used to represent unknown quantities.
- There are many strategies for solving equations, including guess-and-check, the balance model, and the reverse flow chart.
- Formulas are equations in which any of the variables can be solved for. When solving for a variable in a formula, values for the variables are substituted in, and then further calculations may be needed depending on which variable is being solved for. For example, for $A = lw$, if $l = 10$ and $w = 3$, then $A = (10)(3) = 30$. If $A = 50$ and $l = 10$, then $50 = 10w$, and solving this will require either using known multiplication facts or dividing both sides by 10 to solve for w .

Note

- The strategy of using a reverse flow chart can be used to solve equations like $\frac{m}{4} - 2 = 10$; for example:



- The flow chart used in coding is different from the reverse flow chart that can be used to solve equations.
- Many coding applications involve formulas and solving equations.

C2.4 Equalities and Inequalities

solve inequalities that involve one operation and whole numbers up to 50, and verify and graph the solutions

Teacher supports

Key concepts

- Inequalities can be solved like an equation, and then values need to be tested to identify those that hold true for the inequality.

- A number line shows the range of values that hold true for an inequality. An open dot on a number line is used when an inequality involves “less than” or “greater than”, and a closed dot is used when it also includes “equal to”.

Note

- The solution for an inequality that has one variable, such as $x + 3 < 4$, can be graphed on a number line.
- The solution for an inequality that has two variables, such as $x + y < 4$, can be graphed on a Cartesian plane, showing the set of points that hold true.

C3. Coding

solve problems and create computational representations of mathematical situations using coding concepts and skills

Specific expectations

By the end of Grade 5, students will:

C3.1 Coding Skills

solve problems and create computational representations of mathematical situations by writing and executing code, including code that involves conditional statements and other control structures

Teacher supports

Key concepts

- Conditional statements are a representation of binary logic (yes or no, true or false, 1 or 0).
- A conditional statement evaluates a Boolean condition, something that can be either true or false.
- Conditional statements are usually implemented as “if...then” statements or “if...then...else” statements. If a conditional statement is true, then there is an interruption in the current flow of the program being executed and a new direction is taken or the program will end.

- Conditional statements, like loops, can be nested to allow for a range of possible outcomes or to implement decision trees.

Note

- Coding can support the development of a deeper understanding of mathematical concepts.
- Coding can be used to learn how to automate simple processes and enhance mathematical thinking. For example, students can code expressions to recall previously stored information (defined variables), then input values (e.g., from a sensor, count, or user input) and redefine the value of the variable. For examples of these, refer to the notes in **SEs C2.1, C2.2, and C2.3**.
- The construction of the code should become increasingly complex and align with other developmentally appropriate learning.

C3.2 Coding Skills

read and alter existing code, including code that involves conditional statements and other control structures, and describe how changes to the code affect the outcomes

Teacher supports

Key concepts

- Reading code is done to make a prediction about what the expected outcome will be. Based on that prediction, one can determine if the code needs to be altered prior to its execution.
- Reading code helps with troubleshooting why a program is not able to execute.
- Code must sometimes be altered so that the expected outcome can be achieved.
- Code can be altered to be used for a new situation.

Note

- When students are reading code, they are exercising problem-solving skills related to predicting and estimating.
- When code is altered with the aim of reaching an expected outcome, students get instant feedback when it is executed. Students exercise problem-solving strategies to further alter the program if they did not get the expected outcome. If the outcome is as expected, but it gives the wrong answer mathematically, students will need to alter their thinking.

C4. Mathematical Modelling

apply the process of mathematical modelling to represent, analyse, make predictions, and provide insight into real-life situations

This overall expectation has no specific expectations. Mathematical modelling is an iterative and interconnected process that is applied to various contexts, allowing students to bring in learning from other strands. Students' demonstration of the process of mathematical modelling, as they apply concepts and skills learned in other strands, is assessed and evaluated.

Read more about the [mathematical modelling process](#).

Teacher supports

Key concepts

- The process of mathematical modelling requires: understanding the problem; analysing the situation; creating a mathematical model; and analysing and assessing the model.

Note

- A mathematical modelling task is different from a real-life application due to the cyclic nature of modelling, which involves examining a problem from outside mathematics, modelling it, and then checking the model back against the real-life situation and adjusting as necessary.
- The process of mathematical modelling should not be confused with using a "model" to represent or solve a problem that does not require the whole process.
- Mathematical modelling tasks can be utilized in many ways and can support students with making connections among many mathematical concepts across the math strands and across other curricula.

D. Data

Overall expectations

By the end of Grade 5, students will:

D1. Data Literacy

manage, analyse, and use data to make convincing arguments and informed decisions, in various contexts drawn from real life

Specific expectations

By the end of Grade 5, students will:

D1.1 Data Collection and Organization

explain the importance of various sampling techniques for collecting a sample of data that is representative of a population

Teacher supports

Key concepts

- Sampling is gathering information by using a subset of a population. It is more efficient and practical than trying to get data from every item in a population. It is more cost effective too.
- Simple random sampling is a method used to obtain a subset such that each subject in the population has an equal chance of being selected (e.g., randomly selecting 10% of the population using a random generator).
- Stratified random sampling involves partitioning the population into strata and then taking a random sample from each. For example, a school population could be divided into two strata: one with students who take a bus to school and the other with those who don't take a bus. Then a survey could be given to 10% of the population randomly selected from each of these strata.
- Systematic random sampling is used when the subjects from a population are selected through a systematic approach that has been randomly determined. For example, a sample could be determined from an alphabetized list of names, using a starting name and count (e.g., every fourth name) that are randomly selected.
- Data from a sample is used to make judgements and predictions about a population.

Note

- A census is an attempt to collect data from an entire population.

D1.2 Data Collection and Organization

collect data, using appropriate sampling techniques as needed, to answer questions of interest about a population, and organize the data in relative-frequency tables

Teacher supports

Key concepts

- The type and amount of data to be collected is based on the question of interest. Data can either be qualitative (e.g., colour, type of pet) or quantitative (e.g., number of pets, height).
- Depending on the question of interest, the data may need to be collected from a primary or a secondary source.
- Depending on the question of interest, a random sample of the population may need to be taken. Types of sampling methods include simple random sampling, stratified random sampling, and systematic random sampling.
- A relative frequency table is an extension of a frequency table and shows each category expressed as a proportion of the total frequencies, represented using fractions, decimals, or percentages. The sum of the relative frequencies is 1 or 100%.

Note

- Every subject in the sample must be collected in the same manner in order for the data to be representative of the population.

D1.3 Data Visualization

select from among a variety of graphs, including stacked-bar graphs, the type of graph best suited to represent various sets of data; display the data in the graphs with proper sources, titles, and labels, and appropriate scales; and justify their choice of graphs

Teacher supports

Key concepts

- Relative frequencies can be used to compare data sets that are of different sizes.
- Stacked-bar graphs can be created in more than one way to show different comparisons, including with horizontal and vertical bars.
- Stacked-bar graphs display the data values proportionally. Stacked-bar graphs can be used to display percent, or relative frequency. Each bar in the graph represents a whole, and each of the segments in a bar represents a different category. Different colours are used within each bar to easily distinguish between categories.
- The source, titles, labels, and scales provide important information about data in a graph or table:

- The source indicates where the data was collected.
- The title introduces the data contained in the graph.
- Labels on the axes of a graph describe what is being measured (the variable). A key on a stacked-bar graph indicates what each portion of the bar represents.
- Scales are indicated on the axis showing frequencies in bar graphs and in the key of pictographs.
- The scale for relative frequencies is indicated using fractions, decimals, or percents.

Note

- The type of scale chosen is dependent on whether frequencies or relative frequencies will be displayed on the graphs.
- Depending on the scale that is chosen, it may be necessary to estimate the length of the bars or the portions of the bars on a stacked-bar graph.

D1.4 Data Visualization

create an infographic about a data set, representing the data in appropriate ways, including in relative-frequency tables and stacked-bar graphs, and incorporating any other relevant information that helps to tell a story about the data

Teacher supports

Key concepts

- Infographics are used in real life to share data and information on a topic, in a concise and appealing way.
- Infographics contain different representations, such as tables, plots, and graphs, with minimal text.
- Information to be included in an infographic needs to be carefully considered so that it is clear, concise, and connected.
- Infographics tell a story about the data with a specific audience in mind. When creating infographics, students need to create a narrative about the data for that audience.

Note

- Creating infographics has applications in other subject areas, such as communicating key findings and messages in STEM projects.

D1.5 Data Analysis

determine the mean and the median and identify the mode(s), if any, for various data sets involving whole numbers and decimal numbers, and explain what each of these measures indicates about the data

Teacher supports

Key concepts

- The mean, median and mode can be determined for quantitative data. Only the mode can be determined for qualitative data.
- A variable can either have one mode, multiple modes, or no modes.
- The use of the mean, median, or mode to make an informed decision is relative to the context.

Note

- The mean, median, and mode are the three measures of central tendency.

D1.6 Data Analysis

analyse different sets of data presented in various ways, including in stacked-bar graphs and in misleading graphs, by asking and answering questions about the data, challenging preconceived notions, and drawing conclusions, then make convincing arguments and informed decisions

Teacher supports

Key concepts

- Different representations are used for different purposes to convey different types of information.
- Stacked-bar graphs present information in a way that allows the reader to compare multiple data sets proportionally.

- Sometimes graphs misrepresent data or show it inappropriately, which could influence the conclusions that we make. Therefore, it is important to always interpret presented data with a critical eye.
- Data presented in tables, plots, and graphs can be used to ask and answer questions, draw conclusions, and make convincing arguments and informed decisions.
- Sometimes presented data challenges current thinking and leads to new and different conclusions and decisions.
- Questions of interest are intended to be answered through the analysis of the representations. Sometimes the analysis raises more questions that require further collection, representation, and analysis of data.

Note

- There are three levels of graph comprehension that students should learn about and practise:
 - Level 1: information is read directly from the graph and no interpretation is required.
 - Level 2: information is read and used to compare (e.g., greatest, least) or perform operations (e.g., addition, subtraction).
 - Level 3: information is read and used to make inferences about the data using background knowledge of the topic.
- Working with misleading graphs supports students to analyse their own graphs for accuracy.

D2. Probability

describe the likelihood that events will happen, and use that information to make predictions

Specific expectations

By the end of Grade 5, students will:

D2.1 Probability

use fractions to express the probability of events happening, represent this probability on a probability line, and use it to make predictions and informed decisions

Teacher supports

Key concepts

- The probability of events is measured in numeric values ranging from 0 to 1.
- Fractions can be used to express the probability of events across the 0 to 1 continuum.

Note

- Have students make connections between the words to describe the likelihood of events (from Grade 4) and possible fractions that can be used to represent those benchmarks on the probability line.

D2.2 Probability

determine and compare the theoretical and experimental probabilities of an event happening

Teacher supports

Key concepts

- The more trials done in an experiment, the closer the experimental probability will be to the theoretical probability.
- The sum of the probabilities of all possible outcomes is 1.
- The probability of an event can be used to predict the likelihood of that event happening again in the future.

Notes

- “Odds in favour” is a comparison of the probability that an event will occur to the probability that the event will not occur (complementary events). For example, the odds in favour of rolling a 6 is $\frac{1}{6} : \frac{5}{6}$, which can be simplified to 1 : 5 since the fractions are both relative to the same whole.

E. Spatial Sense

Overall expectations

By the end of Grade 5, students will:

E1. Geometric and Spatial Reasoning

describe and represent shape, location, and movement by applying geometric properties and spatial relationships in order to navigate the world around them

Specific expectations

By the end of Grade 5, students will:

E1.1 Geometric Reasoning

identify geometric properties of triangles, and construct different types of triangles when given side or angle measurements

Teacher supports

Key concepts

- Triangles have been an important shape for mathematicians throughout history, and they continue to be significant in engineering, astronomy, navigation, and surveying.
- Geometric properties are specific attributes that define a “class” of shapes or objects. The following are geometric properties of triangles:
 - All triangles have three sides and three angles.
 - The combined length of any two sides of a triangle is always greater than the length of the third side.
 - The interior angles of a triangle always add up (sum) to 180° (e.g., $70^\circ + 60^\circ + 50^\circ = 180^\circ$).
 - The exterior angles of a triangle always add up (sum) to 360° (e.g., $110^\circ + 120^\circ + 130^\circ = 360^\circ$).
 - The interior angle and its corresponding exterior angle always add up (sum) to 180° (e.g., $130^\circ + 50^\circ = 180^\circ$).

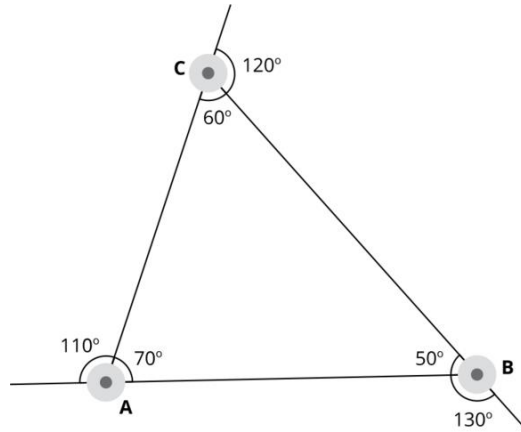

- Triangles can be classified by the number of equal side lengths or number of equal angles:

Classifying Triangles by Number of Equal Sides or Number of Equal Angles		
<p>Equilateral Triangle: 3 Equal Sides 3 Equal Angles</p>	<p>Isosceles Triangle: 2 Equal Sides 2 Equal Angles</p>	<p>Scalene Triangle: No Equal Sides No Equal Angles</p>

- Triangles can be classified by the type of angle measures:

Classifying Triangles by Type of Angle Measures		
<p>Acute Triangle: All Angles Are Less Than 90°</p>	<p>Right Triangle: 1 Angle Is 90°</p>	<p>Obtuse Triangle: 1 Angle Is Greater Than 90°</p>

- There are different techniques for constructing triangles depending on what is known and unknown:
 - When all side lengths of a triangle are known but the angles are unknown, a ruler and compass can be used to construct the triangle. To do so, one could draw the length of one of the sides, then set the compass for the length of another side. The compass can then be put at one of the ends of the line and an arc drawn. Now the compass should be set to the length of the third side and set on the other end of

the line to draw another arc. Where the two arcs intersect is the third vertex of the triangle (see the diagram below). The sides can be completed by drawing a line from the ends of the original line to the point of intersection.

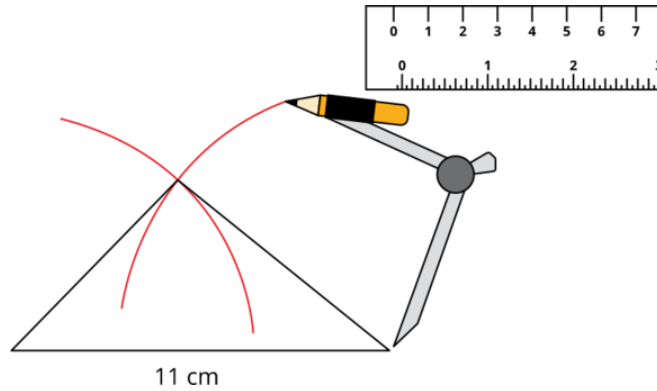

- When one side length and all the angles of a triangle are known, a protractor and a ruler can be used to construct the triangle. The unknown vertex is the point where the arms of the angles intersect:

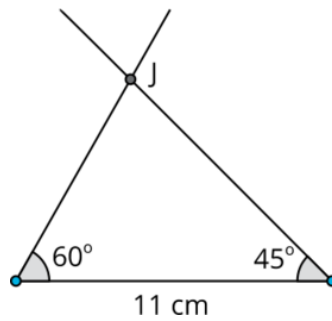

Note

- Triangles can also be constructed using dynamic geometry applications in many ways, including by transforming points and by constructing circles.

E1.2 Geometric Reasoning

identify and construct congruent triangles, rectangles, and parallelograms

Teacher supports

Key concepts

- Congruent two-dimensional shapes can be transposed exactly onto each other. Congruent shapes have congruent angles and congruent lengths.
- If all the side lengths of two triangles are congruent, all the angles will also be congruent.
- If all the angles of two triangles are congruent, it is not necessarily true that the side lengths are congruent.
- Parallelograms, including rectangles and squares, require a combination of congruent angles and congruent side lengths to be congruent.
- Constructing congruent shapes involves measuring and using protractors and rulers. For more information on using protractors, see **SE E2.4**. For more information on using rulers, see **Grade 2, SE E2.3**.

E1.3 Geometric Reasoning

draw top, front, and side views of objects, and match drawings with objects

Teacher supports

Key concepts

- Three-dimensional objects can be represented in two dimensions.
- Given accurate top, front, and side views of an object, with enough information included, the object can be reproduced in three dimensions. Conventions exist (e.g., shading squares to show different heights; using lines as way to show changes in elevations) to clarify any potential ambiguities.
- Architects and builders use plan (top view) and elevation (side view) drawings to guide their construction. STEM (science, technology, engineering, and mathematics) professionals use three-dimensional modelling apps to model a project before building a prototype. Visualizing objects from different perspectives is an important skill used in many occupations, including all forms of engineering.

E1.4 Location and Movement

plot and read coordinates in the first quadrant of a Cartesian plane using various scales, and describe the translations that move a point from one coordinate to another

Teacher supports

Key concepts

- The X-Y Cartesian plane uses two perpendicular number lines to describe locations on a grid. The x-axis is a horizontal number line, the y-axis is a vertical number line, and these two number lines intersect perpendicularly at the origin, (0, 0).
- Pairs of numbers (coordinates) describe the precise location of any point on the plane. The coordinates are enclosed by parentheses as an ordered pair (x, y). The first number in the pair describes the horizontal distance from the origin, and the second number describes the vertical distance from the origin.
- The point (1, 5) is located 1 unit to the right of the origin (along the x-axis) and 5 units above the x-axis. As a translation from the origin, the point (1, 5) is right 1 unit and up 5 units.
- The x- and y-axes on the Cartesian plane, like any other number line or graduated measurement tool, are continuous scales that can be infinitely subdivided into smaller increments. The numbering of the axes may occur at any interval.
 - Sometimes a gridline is marked in multiples of a number and the subdivisions must be deduced (e.g., for an axis marked in multiples of 10, a coordinate of 15 is half the distance between 10 and 20):

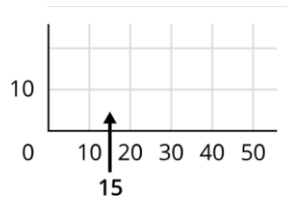

- Sometimes the axes are labelled in whole number increments, and the location of a decimal coordinate must be deduced (e.g., for an axis labelled 1, 2, 3, 4, ..., a coordinate of 1.5 is plotted five tenths or one half of the distance between 1 and 2):

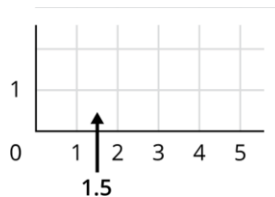

- Sometimes not every gridline is labelled, and the value of the unlabelled grid line must be deduced (e.g., when every fifth line is labelled 10, 20, 30, 40, ...):

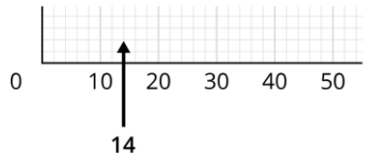

- The number lines on the Cartesian plane extend infinitely in all directions and include both positive and negative numbers, which are centred by the origin, (0, 0). In the first quadrant of the Cartesian plane, the x - and y -coordinates are both positive.

E1.5 Location and Movement

describe and perform translations, reflections, and rotations up to 180° on a grid, and predict the results of these transformations

Teacher supports

Key concepts

- Transformations on a shape, result in changes to its position or its size. As a shape transforms, its vertices (points on a grid) move. The transformation describes the results of the movement. This explains how transformations involve location and movement.
- A translation involves distance and direction. Every point on the original shape “slides” the same distance and direction to create a translated image. This is called the translation vector. For example, on a grid, a vector could describe each point moving “5 units to the right and 2 units up”. It is a mathematical convention that the horizontal distance (x) is given first, followed by the vertical distance (y).
- A reflection involves a line of reflection that acts like a mirror. Every point on the original shape is “flipped” across the line of reflection to create a reflected image. Every point on the original image is the same distance from the line of reflection as the corresponding point on the reflected image. Reflections are symmetrical.
- A rotation involves a *centre* of rotation and an *angle* of rotation. Every point on the original shape turns around the centre of rotation by the same specified angle. Any point on the original is the same distance to the centre of rotation as the corresponding point on the rotated image.

Note

- At this grade level, students can express the translation vector using arrows; for example, $(5\rightarrow, 2\uparrow)$.

- Dynamic geometry applications are recommended for visualizing and understanding how transformations, and especially rotations, behave.

E2. Measurement

compare, estimate, and determine measurements in various contexts

Specific expectations

By the end of Grade 5, students will:

E2.1 The Metric System

use appropriate metric units to estimate and measure length, area, mass, and capacity

Teacher supports

Key concepts

- The choice of an appropriate unit depends on which attribute is being measured and the reason for measuring it.
 - The attribute to be measured determines whether to choose a unit of length, area, mass, or capacity.
 - The reason and context for measuring determines how accurate a measurement needs to be. Large units are used for broad, approximate measurements; small units are used for precise measurements and detailed work.
- When choosing the appropriate size of unit, it is helpful to know that the same set of metric prefixes applies to all attributes (except time) and describes the relationship between the units. For any given unit, the next largest unit is 10 times its size, and the next smallest unit is one tenth its size.

Note

- Although not all metric prefixes are used commonly in English Canada, understanding the system reinforces the connection to place value:

Metric Prefix	kilo-unit	hecto-unit	deca-unit	unit	deci-unit	centi-unit	milli-unit
Unit Value	1000 units	100 units	10 units	1 unit	$\frac{1}{10}$ unit	$\frac{1}{100}$ unit	$\frac{1}{1000}$ unit
Place Value	thousand	hundred	ten	one	one tenth	one hundredth	one thousandth

- Canada, as well as all but three countries in the world, has adopted the metric system as its official measurement system. It is also universally used by the scientific community because its standard prefixes make measurements and conversions easy to perform and understand. However, Canadians also commonly refer to the imperial system in daily life (gallons, quarts, tablespoons, teaspoons, pounds), and the *Weights and Measures Act* was officially amended in 1985 to allow Canadians to use a combination of metric and imperial units. The most appropriate unit is dependent on the context. Sometimes it is a metric unit (this is the emphasis in this expectation), sometimes it is an imperial unit, and sometimes it is personal non-standard unit or benchmark.
- Although the size of a unit may change, the process for measuring an attribute remains the same. This is true whether using inches, centimetres, or handspans.

E2.2 The Metric System

solve problems that involve converting larger metric units into smaller ones, and describe the base ten relationships among metric units

Teacher supports

Key concepts

- Conversions within the metric system rely on understanding the relative size of the metric units (see **SE E2.1**) and the multiplicative relationships in the place-value system (see **Number, SE B1.1**).
- Because both place value and the metric system are based on a system of tens, metric conversions can be visualized as a shifting of digits to the left or right of the decimal point a certain number of places. The amount of shift depends on the relative size of the units being converted. For example, since 1 km is 1000 times as long as 1 m, 28.5 km becomes 28 500 m when the digits shift three places to the left.
- There is an inverse relationship between the size of a unit and the count of units: the smaller the unit, the greater the count. Remembering this principle is important for estimating whether a conversion will result in more or fewer units.

Note

- Although this expectation focuses on converting from larger to smaller units, it is important that students understand that conversions can also move from smaller to larger units using decimals. Exposure to decimal measurements is appropriate for Grade 5 students.

E2.3 Angles

compare angles and determine their relative size by matching them and by measuring them using appropriate non-standard units

Teacher supports

Key concepts

- The lines (rays) that form an angle (i.e., the “arms” of an angle) meet at a vertex. The size of the angle is not affected by the length of its arms.
- Angles are often difficult to transport and compare *directly* (i.e., by overlaying and matching one against another); therefore, angles are often compared *indirectly* by using a third angle to make the comparison:
 - If the third angle can be adjusted and transported, it can be made to match the first angle and then be moved to the second angle to make the comparison directly. This involves the property of transitivity (if A equals C, and C is greater than B, then A is also greater than B).
 - If the third angle is a smaller but fixed angle, it can operate as a unit that is iterated to produce a count. Copies of the third angle are fitted into the other two angles to produce a measurement. The unit count is compared to determine which angle is greater and how much greater.
- In the same way that units of length are used to measure length, and units of mass are used to measure mass, units of angle are used to measure angles. Any object with an angle can represent a unit of angle and be used to measure another angle.

E2.4 Angles

explain how protractors work, use them to measure and construct angles up to 180° , and use benchmark angles to estimate the size of other angles

Teacher supports

Key concepts

- Protractors, like rulers or any other measuring tool, replace the need to lay out and count individual physical units. The protractor repeats a unit so there are no gaps or overlaps and includes a scale to keep track of the unit count.
- A degree is a very small angle and is a standard unit for measuring angles. When 180 degrees are placed together, they form a straight line as demonstrated on a 180° protractor.
- Since a degree is such a small unit, standard protractors often use a scale (typically in increments of 10) with markings to show the individual degrees. If every degree was labelled, the protractor would need to be much larger.
- Protractors usually include a double scale to make it easier to count the degrees in angles that rays open clockwise and those that open counterclockwise. The outer scale goes from 0° to 180° and reads from left to right, whereas the inner scale goes from 0° to 180° and reads from right to left.
- To use a protractor to make an accurate measurement (i.e., a count of degrees):
 - align the vertex of the lines (rays) with the vertex of the protractor (i.e., the midpoint of the protractor where all the degree angles meet);
 - align the arm of the line (ray) with the zero line on the protractor, similar to measuring from zero with a ruler;
 - choose the scale that begins the count at zero and read the measurement where the arm of the line (ray) crosses the number scale, i.e., if the rays open to the right, use the inner scale and if the rays open to the left, use the outer scale.

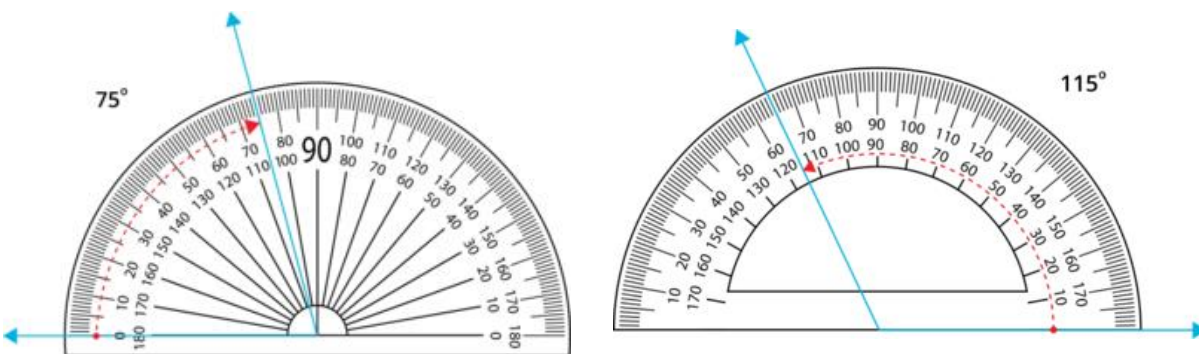

- Being able to identify benchmark angles, such as 45°, 90°, 135°, and 180°, is helpful for estimating other angles.

E2.5 Area

use the area relationships among rectangles, parallelograms, and triangles to develop the formulas for the area of a parallelogram and the area of a triangle, and solve related problems

Teacher supports

Key concepts

- For some shapes and some attributes, length measurements can be used to calculate other measurements. This is true for the area of rectangles, parallelograms, and triangles. Indirectly measuring the area of these shapes is more accurate than measuring them directly (i.e., by laying out and counting square units and partial units).
- The spatial relationships between rectangles, parallelograms, and triangles can be used to determine area formulas. The array is an important model for visualizing these relationships.
- The area (A) of any rectangle can be indirectly measured by multiplying the length of its base (b) by the length of its height (h) and can be represented symbolically as $A = b \times h$. It also, can be determined by multiplying the rectangles length (l) by its width (w) or $A = l \times w$ (see **Grade 4, SE E2.6**). This formula can be used to generate formulas for the area of other shapes.
- Any parallelogram can be rearranged (composed) into a rectangle with the same area. For all parallelograms it is true that:
 - the *areas* of the parallelogram and its rearrangement as a rectangle are equal;
 - the *base lengths* of the parallelogram and its rearrangement as a rectangle are equal;
 - the *heights* of the parallelogram and its rearrangement as a rectangle are equal;
 - this means that, the area of any parallelogram can be indirectly measured, like a rectangle, by multiplying the length of its base by the length of its height;
 - this relationship can be represented symbolically using the formula, $A = b \times h$, where A represents *Area*, b represents *base* and h represents *height*.
- Any triangle can be doubled to create a parallelogram (i.e., by rotating a triangle around the midpoint of a side). Any parallelogram can be divided into two congruent triangles. Half of a parallelogram is a triangle.
- For all triangles it is true that:
 - the *base lengths* of the triangle and the parallelogram formed by rotating a copy of the triangle are equal;
 - the *heights* of the triangle and the parallelogram are equal;

- the *area* of the parallelogram is double that of the triangle, and the area of the triangle is half that of the parallelogram;
- therefore, since $A = b \times h$ for a parallelogram, the area (A) of a triangle can be measured indirectly by multiplying the length of its base (b) by the length of its height (h) and dividing by 2;
- this relationship can be represented using the formula $A = (b \times h) \div 2$. Because multiplying by one half is the same as dividing by 2, it can also be represented as $A = \frac{1}{2}(b \times h)$.

Note

- Any side of a rectangle, parallelogram, or triangle can be its base, and each base has a corresponding height.

E2.6 Area

show that two-dimensional shapes with the same area can have different perimeters, and solve related problems

Teacher supports

Key concepts

- Different shapes can have the same area. Therefore, shapes that have the same area do not necessarily have the same perimeter.
- An area can be maximized for a given perimeter, and a perimeter can be minimized for a given area. Choosing the most appropriate shape depends upon the situation and possible constraints (e.g., minimizing the amount of fencing needed; maximizing the area for a goat to graze).
- Perimeter measures the distance around a shape, and area measures the amount of space occupied within the shape. They are two different attributes.
- The perimeter, P , of a rectangle is the sum of its lengths (l) and widths (w), which can be expressed as $P = l + l + w + w$, or $P = 2l + 2w$.

F. Financial Literacy

Overall expectations

By the end of Grade 5, students will:

F1. Money and Finances

demonstrate the knowledge and skills needed to make informed financial decisions

Specific expectations

By the end of Grade 5, students will:

F1.1 Money Concepts

describe several ways money can be transferred among individuals, organizations, and businesses

Teacher supports

Key concepts

- Money can be transferred in a wide variety of ways.
- Some methods of transferring money might work for some individuals, families, communities, organizations, or businesses, but not for others, depending on a variety of factors (e.g., purpose, context, geography, personal circumstances and preferences, available financial institutions, time constraints, security considerations, available funds).

F1.2 Money Concepts

estimate and calculate the cost of transactions involving multiple items priced in dollars and cents, including sales tax, using various strategies

Teacher supports

Key concepts

- Estimating and calculating the cost and change required in cash transactions requires the application of addition, subtraction, multiplication, division, mental math strategies, and math facts.
- Sales tax²⁵ has an impact on the total cost of a purchase.

Note

- In Grade 5, students should be representing money amounts using standard currency notation, including for calculations.
- Real-life contexts provide opportunities to practise strategies for accurately calculating money amounts that include cents (decimals to hundredths).
- Practice with estimating and calculating money amounts and determining change strengthens students' understanding of addition, subtraction, and place value.
- Working with money reinforces students' understanding of the concept of percent and of decimals to hundredths and helps to connect their understanding of the concept of place value to its use in real-life contexts.

F1.3 Financial Management

design sample basic budgets to manage finances for various earning and spending scenarios

Teacher supports

Key concepts

- Budgets are financial planning tools that can be used in real-life contexts.
- Creating a sample basic budget requires the consideration of factors involved (e.g., earnings, expenses, the goals of the budget) and how to use a budget to inform financial decisions.

²⁵ In general, Indigenous peoples in Canada are required to pay taxes on the same basis as other people in Canada, except where limited exemptions apply. Eligible Status First Nations may claim an exemption from paying the 8% Ontario component of the Harmonized Sales Tax (HST) on qualifying goods and services purchased off-reserve. Qualifying goods and services are described in the [Ontario First Nations Harmonized Sales Tax \(HST\) rebate](#). Under Section 87 of the Indian Act, the personal property of eligible Status First Nations or a band situated on a reserve is tax exempt.

- Keeping a record of earnings and expenditures is a key components of a budget.

F1.4 Financial Management

explain the concepts of credit and debt, and describe how financial decisions may be impacted by each

Teacher supports

Key concepts

- The concepts of credit and debt are introduced to identify how using credit and carrying debt might impact financial well-being.

Note

- Financial decisions involve choices and are based on varying circumstances (e.g., there are many situations where someone may decide to take a loan to acquire an asset, or use a payment plan to purchase an item to meet an immediate need).

F1.5 Consumer and Civic Awareness

calculate unit rates for various goods and services, and identify which rates offer the best value

Teacher supports

Key concepts

- Unit rates can be used to make direct comparisons in order to identify the “better buy”. This is a skill that supports consumer awareness, allowing consumers to determine the best value when making a purchase.

Note

- Unit rate is an important concept that can be applied to solve mathematical problems across strands.

F1.6 Consumer and Civic Awareness

describe the types of taxes that are collected by the different levels of government in Canada, and explain how tax revenue is used to provide services in the community

Teacher supports

Key concepts

- Different levels of government and other elected bodies (i.e., federal, provincial, territorial, and municipal governments; band councils) collect a variety of taxes from individuals and businesses in order to pay for facilities, services, and programs (e.g., roads and highways, hospitals, education, national defence, police and fire services, parks and playgrounds, garbage collection, and many other programs and services).

Note

- Contributing to and distributing financial resources through taxes impacts the standard of living in communities.

Mathematics, Grade 6

Expectations by strand

A. Social-Emotional Learning (SEL) Skills in Mathematics and the Mathematical Processes

This strand focuses on students' development and application of social-emotional learning skills to support their learning of math concepts and skills, foster their overall well-being and ability to learn, and help them build resilience and thrive as math learners. As they develop SEL skills, students demonstrate a greater ability to understand and apply the mathematical processes, which are critical to supporting learning in mathematics. In all grades of the mathematics program, the learning related to this strand takes place in the context of learning related to all other strands, and it should be assessed and evaluated within these contexts.

Overall expectations

Throughout this grade, in order to promote a positive identity as a math learner, to foster well-being and the ability to learn, build resilience, and thrive, students will:

A1. Social-Emotional Learning (SEL) Skills and the Mathematical Processes

apply, to the best of their ability, a variety of social-emotional learning skills to support their use of the mathematical processes and their learning in connection with the expectations in the other five strands of the mathematics curriculum

To the best of their ability, students will learn to:	... as they apply the mathematical processes :	... so they can:
1. identify and manage emotions	<ul style="list-style-type: none"> • problem solving: develop, select, and apply problem-solving strategies • reasoning and proving: develop and apply reasoning skills (e.g., classification, recognition of relationships, use of counter-examples) to justify thinking, make and investigate conjectures, and construct and defend arguments 	1. express and manage their feelings, and show understanding of the feelings of others, as they engage positively in mathematics activities
2. recognize sources of stress and cope with challenges	<ul style="list-style-type: none"> • reflecting: demonstrate that as they solve problems, they are pausing, looking back, and monitoring their thinking to help clarify their understanding (e.g., by comparing and adjusting strategies used, by explaining why they think their results are reasonable, by recording their thinking in a math journal) 	2. work through challenging math problems, understanding that their resourcefulness in using various strategies to respond to stress is helping them build personal resilience
3. maintain positive motivation and perseverance	<ul style="list-style-type: none"> • connecting: make connections among mathematical concepts, procedures, and representations, and relate mathematical ideas to other contexts (e.g., other curriculum areas, daily life, sports) 	3. recognize that testing out different approaches to problems and learning from mistakes is an important part of the learning process, and is aided by a sense of optimism and hope
4. build relationships and communicate effectively	<ul style="list-style-type: none"> • communicating: express and understand mathematical thinking, and engage in mathematical arguments using everyday language, language resources as necessary, appropriate mathematical terminology, a variety of representations, and mathematical conventions 	4. work collaboratively on math problems – expressing their thinking, listening to the thinking of others, and practising inclusivity – and in that way fostering healthy relationships
5. develop self-awareness and sense of identity	<ul style="list-style-type: none"> • representing: select from and create a variety of representations of mathematical ideas (e.g., 	5. see themselves as capable math learners, and strengthen their sense of ownership of their learning, as part of their emerging sense of identity and belonging

6. think critically and creatively	representations involving physical models, pictures, numbers, variables, graphs), and apply them to solve problems <ul style="list-style-type: none"> • selecting tools and strategies: select and use a variety of concrete, visual, and electronic learning tools and appropriate strategies to investigate mathematical ideas and to solve problems 	6. make connections between math and everyday contexts to help them make informed judgements and decisions
------------------------------------	--	--

B. Number

Overall expectations

By the end of Grade 6, students will:

B1. Number Sense

demonstrate an understanding of numbers and make connections to the way numbers are used in everyday life

Specific expectations

By the end of Grade 6, students will:

B1.1 Rational Numbers

read and represent whole numbers up to and including one million, using appropriate tools and strategies, and describe various ways they are used in everyday life

Teacher supports

Key concepts

- Reading numbers involves interpreting them as a quantity when they are expressed in words, in standard notation, or in expanded notation.
- The numerals 0 to 9 are used to form numbers. They are referred to as the digits in a number and each digit corresponds to a place value. For example, in the number 945 107, the digit 9 represents 9 hundred thousands, the digit 4 represents 4 ten thousands, the

digit 5 represents 5 thousands, the digit 1 represents 1 hundred, the digit 0 represents 0 tens, and the digit 7 represents 7 ones.

- There are patterns to the way numbers are formed. Each place value column, or period, repeats the 0 to 9 counting sequence.
- Any quantity, no matter how great, can be described in terms of its place value. For example, 1500 may be said as fifteen hundred or one thousand five hundred.
- A number can be represented in expanded form (e.g., $634\ 187 = 600\ 000 + 30\ 000 + 4000 + 100 + 80 + 7$, or $6 \times 100\ 000 + 3 \times 10\ 000 + 4 \times 1000 + 1 \times 100 + 8 \times 10 + 7$) to show place value relationships.
- Numbers are used throughout the day, in various ways and contexts. Most often numbers describe and compare quantities. They express magnitude, and provide a way to answer questions such as “how much?” and “how much more?”.

Note

- Every strand of mathematics relies on numbers.
- Numbers may have cultural significance.
- Seeing how a quantity relates to *other* quantities supports students in developing an understanding of the magnitude or “how muchness” of a number.
- There are patterns in the place value system that support the reading, writing, saying, and understanding of numbers and that suggest important ways for numbers to be composed and decomposed.
 - The *place* (or position) of a digit determines its *value* (*place value*). The 5 in 511, for example, has a value of 500, not 5.
 - A zero in a column indicates that there are no groups of that size in the number. It serves as a placeholder, holding the other digits in their correct “place”.
 - The value of the columns increases by a constant “times 10” multiplicative pattern. For example, as the digit 5 shifts to the left, from 5000 to 50 000, the digit’s value becomes 10 times as great. As it shifts to the right, from 5000 to 500, its value becomes one tenth as great.
 - To find the value of a digit in a number, the value of the digit is multiplied by the value of its place. For example, in the number 52 036, the 5 represents 50 000 ($5 \times 10\ 000$) and the 2 represents 2000 (2×1000).
 - Expanded notation represents the value of each digit separately, as an expression. Using expanded form, 7287 is written as $7287 = 7000 + 200 + 80 + 7$, or $7 \times 1000 + 2 \times 100 + 8 \times 10 + 7 \times 1$.
 - Each period – thousands, millions, billions, trillions – is 1000 times the previous period.

- A “hundreds-tens-ones” pattern repeats within each period (ones, thousands, millions, billions, and so on), and each period is 1000 times the one preceding it. Exposure to these patterns, and the names of these periods, also satisfies a natural curiosity around “big numbers” and could lead to conversations about periods beyond millions (billions, trillions, quadrillions, and so on).

Place Value Patterns

one billions	hundred millions	ten millions	one millions	hundred thousands	ten thousands	one thousands	hundreds	tens	ones

- The number “five hundred eight thousand thirty-seven” is written as “508 037” and not “508 1000 37” (as if being spelled out with numbers). Listening for the period name (508 thousand), and the hundreds-tens-ones pattern that precedes the period, gives structure to the number and signals where a digit belongs. If there are no groups of a particular place value, 0 is used to describe that amount, holding the other digits in their correct place.
- Large numbers are difficult to visualize. Making connections to real-life contexts helps with this, as does comparing large numbers to other numbers using proportional reasoning. For example, a small city might have a population of around 100 000, and 1 000 000 would be 10 of these cities.

B1.2 Rational Numbers

read and represent integers, using a variety of tools and strategies, including horizontal and vertical number lines

Teacher supports

Key concepts

- Integers are whole numbers and their opposites.
- Zero is neither negative nor positive.
- On a horizontal number line, positive integers are displayed to the right of zero and negative integers are displayed to the left of zero.
- On a vertical number line, positive integers are displayed above the zero and negative integers are displayed below the zero.
- Integers can be represented as points on a number line, or as vectors that shows magnitude and direction. The integer -5 can be shown as a point positioned 5 units to the left of zero or 5 units below zero. The integer -5 can also be shown as a vector with

its tail positioned at zero and its head at -5 on the number line, to show that it has a length of 5 units and is moving in the negative direction.

- Each integer has an opposite, and both are an equal distance from zero. For example, -4 and $+4$ are opposite integers and both are 4 units from zero.
- Zero can be represented with pairs of opposite integers. For example, $(+3)$ and $(-3) = 0$.
- Integers measure "whole things" relative to a reference point. For example, 1 degree Celsius is used to measure temperature. Zero degrees is freezing (reference point). The temperature $+10^{\circ}\text{C}$ is ten degrees above freezing. The temperature -10°C is ten degrees below freezing.

Note

- Engaging with everyday examples of negative integers (e.g., temperature, elevators going up and down, sea level, underground parking lots, golf scores, plus/minus in hockey, saving and spending money, depositing and withdrawing money from a bank account, walking forward and backwards) helps build familiarity and a context for understanding numbers less than zero.
- Pairs of integers such as $(+2)$ and (-2) are sometimes called "zero pairs".
- The Cartesian plane (see **Spatial Sense, SE E1.3**) uses both horizontal and vertical integer number lines to plot locations, and negative rotations to describe clockwise turns (see **Spatial Sense, SE E1.4**). Both are mathematical contexts for using and understanding positive and negative integers.

B1.3 Rational Numbers

compare and order integers, decimal numbers, and fractions, separately and in combination, in various contexts

Teacher supports

Key concepts

- Numbers with the same units can be compared directly (e.g., 72.5 cm^2 compared to 62.4 cm^2).
- Sometimes numbers without the same unit can be compared, such as 6.2 kilometres and 6.2 metres. Knowing that the unit *kilometre* is greater than the unit *metre* can allow one to infer that 6.2 kilometres is greater than 6.2 metres.
- Sometimes numbers without the same unit may need to be rewritten with the same unit in order to be compared. For example, 1.2 metres and 360 centimetres can be compared

as 120 centimetres and 360 centimetres. Thus, 360 centimetres is greater than 1.2 metres.

- Whole numbers (zero and positive integers) and decimal numbers can be compared and ordered according to their place value.
- Benchmark numbers can be used to compare quantities. For example, $\frac{5}{6}$ is greater than $\frac{1}{2}$ and 0.25 is less than $\frac{1}{2}$, so $\frac{5}{6}$ is greater than 0.25.
- If two fractions have the same denominator, then the numerators can be compared. In this case the numerator with the greater value is the greater fraction because the number of parts considered is greater (e.g., $\frac{2}{3} > \frac{1}{3}$).
- If two fractions have the same numerators, then the denominators can be compared. In this case the denominator with the greater value is the smaller fraction because the size of each partition of the whole is smaller (e.g., $\frac{5}{6} < \frac{5}{3}$).
- Having more digits does not necessarily mean that a number is greater. For example, -7528 has four digits but it is less than $+3$ because -7528 is less than zero and $+3$ is greater than zero.
- Any positive number is greater than any negative number.
- When comparing positive numbers, the greater number is the number with the greater magnitude. On a horizontal number line, the greater number is the farthest to the right of zero. On a vertical number line, the greater number is the farthest above zero.
- When comparing negative integers, the least number is the negative integer with the greater magnitude. On a horizontal number line, the lesser number is the farthest to the left of zero. On a vertical number line, the lesser number is the farthest below zero.
- Numbers can be ordered in ascending order – from least to greatest – or can be ordered in descending order – from greatest to least.

Note

- Comparing numbers helps with understanding and describing their order and magnitude.
- Visual models like the number line – particularly if they are proportional – can be used to order numbers; show the relative magnitude of numbers; and highlight equivalences among fractions, decimals, and whole numbers.
- The absolute value of a number is its distance from zero, or its magnitude. Both -5 and $+5$ have an absolute value of 5, because both are 5 units from zero on the number line.

B1.4 Fractions, Decimals, and Percents

read, represent, compare, and order decimal numbers up to thousandths, in various contexts

Teacher supports

Key concepts

- The place value of the first position to the right of the decimal point is tenths. The second position to the right of the decimal point is hundredths. The third position to the right of the decimal point is thousandths.
- Decimal numbers can be less than one (e.g., 0.654) or greater than one (e.g., 24.723).
- The one whole needs to be shown or explicitly indicated when decimal numbers are represented visually since their representation is relative to the whole.
- Decimal numbers can be represented as a composition or decomposition of numbers according to their place value. For example, decimals can be written in expanded notation $3.628 = 3 + 0.6 + 0.02 + 0.008$, or $3 \times 1 + 6 \times 0.1 + 2 \times 0.01 + 8 \times 0.001$.
- Decimal numbers can be compared by their place value. For example, when comparing 0.8250 and 0.845, the greatest place value where the numbers differ is compared. For this example, 2 hundredths (from 0.825) and 4 hundredths (from 0.845) are compared. Since 4 hundredths is greater than 2 hundredths, 0.845 is greater than 0.825.
- Numbers can be ordered in ascending order – from least to greatest or can be ordered in descending order – from greatest to least.

Note

- Between any two consecutive whole numbers are decimal thousandths. For example, the number 3.628 describes a quantity between 3 and 4 and, more precisely, between 3.6 and 3.7 and, even more precisely, between 3.62 and 3.63.
- Decimals are sometimes called decimal fractions because they represent fractions with denominators of 10, 100, 1000, and so on. Decimal place value columns are added to describe smaller partitions. Decimals, like fractions, have a numerator and a denominator; however, with decimals, only the numerator is visible. The denominator (or unit) is “hidden” within the place value convention.
- Decimals can be composed and decomposed like whole numbers. Expanded notation shows place value subdivisions (e.g., $3.628 = 3 + 0.6 + 0.02 + 0.008$, or $3 \times 1 + 6 \times 0.1 + 2 \times 0.01 + 8 \times 0.001$).
- The decimal point indicates the location of the unit. The unit is always to the left of the decimal point. There is symmetry around the unit column, so tens are matched by tenths, and hundreds are matched by hundredths. Note that the symmetry does not revolve around the *decimal*, so there is no “oneth”:

Place Value Symmetry

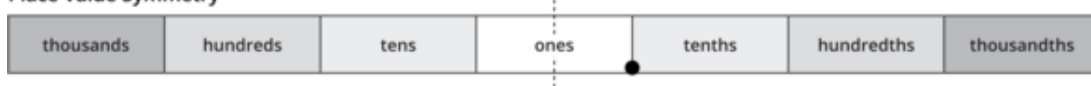

- Between any two places in the base ten system, there is a constant 10 : 1 ratio, and this is true for decimals as well. As a digit shifts one space to the right it becomes one tenth as great and if it shifts two spaces to the right it becomes one hundredth as great. So, 0.005 is one tenth as great as 0.05, one hundredth as great as 0.5, and one thousandth as great as 5. This also means that 5 is 1000 times as great as 0.005.
- As with whole numbers, a zero in a decimal indicates that there are no groups of that size in the number:
 - 5.007 means that there are 5 wholes, 0 tenths, 0 hundredths, and 7 thousandths.
 - 5.100 means that there are 5 wholes, 1 tenth, 0 hundredths, and 0 thousandths.
 - 5.1 (five and one tenth), 5.10 (5 and 10 hundredths), and 5.100 (5 and 100 thousandths) are all equivalent (although writing zero in the tenths and hundredths position can indicate the precision of a measurement; for example, the race was won by 5.00 seconds and the winning time was 19.29 seconds). Writing zero in the tenths, hundredths, and thousandths position can indicate the precision of a measurement (e.g., baseball batting averages are given to the nearest thousandths).
- Decimals are read in a variety of ways in everyday life. Decimals like 2.5 are commonly read as two point five; in math, the term pi (π) is commonly approximated as three point one four; the decimal in baseball averages is typically ignored. However, to reinforce the decimal's connection to fractions, and to make visible its place value denominator, it is recommended that decimals be read as their fraction equivalent. So, 2.573 is read as "2 and 573 thousandths."

B1.5 Fractions, Decimals, and Percents

round decimal numbers, both terminating and repeating, to the nearest tenth, hundredth, or whole number, as applicable, in various contexts

Teacher supports

Key concepts

- Rounding makes a number simpler to work with and is often used when estimating computations, measuring, and making quick comparisons.
- A decimal number is rounded to the nearest hundredth, tenth, or whole number based on which hundredth, tenth or whole number it is closest to. If it is the same distance, it is usually rounded up. However, depending on context it may be rounded down.

Note

- Decimal numbers that terminate are like 3.5, 46.27, and 0.625.
- Decimal numbers that repeat are like 3.555555... and can be represented using the symbol with a dot above the repeating digit, (e.g., $3.\dot{5}$). If a string of digits repeats, a bar can be shown above the string, or dots above the first and last digits (e.g., 3.546754675467 is written as $3.\overline{5467}$ or $3.\dot{5}46\dot{7}$).
- Rounding involves making decisions about what level of precision is needed and is often used in measurement. How close a rounded number is to the actual amount depends on the unit it is being rounded to: the larger the unit, the broader the approximation; the smaller the unit, the more precise. Whether a number is rounded up or down depends on the context.

B1.6 Fractions, Decimals, and Percents

describe relationships and show equivalences among fractions and decimal numbers up to thousandths, using appropriate tools and drawings, in various contexts

Teacher supports

Key concepts

- Any fraction can become a decimal number by treating the fraction as a quotient (e.g., $\frac{8}{5} = 8 \div 5 = 1.6$).
- Some fractions as quotients produce a repeating decimal. For example, $\frac{1}{3} = 1 \div 3 = 0.333\dots$ or $\frac{1}{7} = 1 \div 7 = 0.\overline{142857}$. When decimal numbers are rounded they become approximations of the fraction.
- If a fraction can be expressed in an equivalent form with a denominator of tenths, hundredths, thousandths, and so on, it can also be expressed as an equivalent decimal. For example, because $\frac{1}{4}$ can be expressed as $\frac{25}{100}$, it can also be expressed as 0.25.
- A terminating decimal can be expressed in an equivalent fraction form. For example, $0.625 = \frac{625}{1000}$, which can be expressed as other equivalent fractions, $\frac{125}{200}$ or $\frac{25}{40}$ or $\frac{5}{8}$.
- Any whole number can be expressed as a fraction and as a decimal number. For example, $3 = \frac{3}{1} = 3.0$.

Note

- Decimals are how place value represents fractions and are sometimes called decimal fractions. While fractions may use any number as a denominator, decimals have denominators (units) that are based on a system of tens (tenths, hundredths, and so on).

B2. Operations

use knowledge of numbers and operations to solve mathematical problems encountered in everyday life

Specific expectations

By the end of Grade 6, students will:

B2.1 Properties and Relationships

use the properties of operations, and the relationships between operations, to solve problems involving whole numbers, decimal numbers, fractions, ratios, rates, and whole number percents, including those requiring multiple steps or multiple operations

Teacher supports

Key concepts

- Properties of operations are helpful for carrying out calculations:
 - The identity property: $a + 0 = a$, $a - 0 = a$, $a \times 1 = a$, $\frac{a}{1} = a$.
 - The commutative property: $a + b = b + a$, $a \times b = b \times a$.
 - The associative property: $(a + b) + c = a + (b + c)$, $(a \times b) \times c = a \times (b \times c)$.
 - The distributive property: $a \times (b + c) = (a \times b) + (a \times c)$.
- The commutative, associative, and identity properties can be applied for any type of number.
- The order of operations property needs to be followed when given a numerical expression that involves multiple operations. Any calculations in the brackets are done first. Multiplication and division are done before addition and subtraction. Multiplication and division are done in the order they appear in the expression from left to right. Addition and subtraction are done in the order they appear in the expression from left to right.

- Multi-step problems may involve working with a combination of whole numbers, decimal numbers, and fractions.
- Multi-step problems may involve working with a combination of relationships, including ratios, rates, and percents.
- There may be more than one way to solve a multi-step problem.

Note

- This expectation supports most other expectations in the Number strand and is applied throughout the grade. Whether working with numbers or operations, recognizing and applying properties and relationships builds a strong foundation for doing mathematics.
- Solving problems with more than one operation involves similar processes to solving problems with a single operation. For both types of problems:
 - Identify the actions and quantities in a problem and what is known and unknown.
 - Represent the actions and quantities with a diagram (physically or mentally).
 - Choose the operation(s) that match the actions to write the equation.
 - Solve by using the diagram (counting) or the equation (calculating).
- In multi-step problems, sometimes known as two-step problems, there is an *ultimate* question (asking for the final answer or result being sought), and a *hidden* question (a step or calculation that must be taken to get to the final result). Identifying both questions is a critical part of solving these types of problems.
- The actions in a situation inform the choice of operation. The same operation can describe different situations:
 - Does the situation involve changing (joining, separating), combining, or comparing? Then the situation can be represented with addition and subtraction.
 - Does the situation involve equal groups (or rates), ratio comparisons, or arrays? Then the situation can be represented with multiplication and division.
- Representing a situation with an equation is often helpful for solving a problem. Identifying what is known and unknown in a situation informs how an equation is structured.

B2.2 Math Facts

understand the divisibility rules and use them to determine whether numbers are divisible by 2, 3, 4, 5, 6, 8, 9, and 10

Teacher supports

Key concepts

- There are number patterns that can be used to quickly test whether a number can be evenly divided by another number.
- Divisibility rules can be used to determine factors of numbers.

Note

- Divisibility rules can be applied to all integers; the signs can be ignored.
- Divisibility rules do not apply to decimal numbers that are not whole numbers.

B2.3 Mental Math

use mental math strategies to calculate percents of whole numbers, including 1%, 5%, 10%, 15%, 25%, and 50%, and explain the strategies used

Teacher supports

Key concepts

- Percents represent a rate out of 100 (“per cent” means “per hundred”) and are always expressed in relation to a whole. To visually determine the percent of an amount, the whole is subdivided into 100 parts (percent) and described using the percent symbol (%).
- Since 1% is 1 hundredth of an amount, and 10% is 1 tenth, other percents can be calculated by mentally multiplying an amount by tenths and hundredths. For example, $0.01 \times 500 = 5$ or $\frac{1}{100}$ of 500 = 5.
- Calculating the percent of a whole number can be determined by decomposing the percent as a multiple of 1%. For example, 3% of 500 can be determined by decomposing 3% as $3 \times 1\%$. Since 1% of 500 is 5, then 3% of 500 is $3 \times 1\% \text{ of } 500 = 3 \times 5 = 15$.

Note

- Multiplying a whole number by a percent is the same as multiplying a whole number by a fraction with a denominator of 100 (e.g., $3\% \times 500 = \frac{3}{100} \times 500$ or 0.03×500).
- Dividing an amount by 100 is the same as multiplying it by 0.01. Since 0.01×500 is 5 (i.e., $\frac{1}{100}$ of 500), then 1% of 500 is also 5.

- Percents can be composed from other percents. Since 1% of 500 is 5, then 3% of 500 is 15. This builds on an understanding of fractions and the meaning of the numerator: $\frac{3}{100}$ is the same as 3 one hundredths.
- Relationships between fractions, decimals, and percents also provide building blocks for mentally calculating unknown percents. For example: $\frac{1}{4} = 25\%$; $\frac{1}{2} = 50\%$; $\frac{3}{4} = 75\%$. Five percent is half of 10%, and 15% is 10% plus 5%.
- Calculating a percent is a frequently used skill in everyday life (e.g., when determining sales tax, discounts, or gratuities).
- Mental math is not always quicker than paper and pencil strategies, but speed is not its goal. The value of mental math is in its portability and flexibility, since it does not require a calculator or paper and pencil. Practising mental math strategies also deepens understanding of numbers and operations.

B2.4 Addition and Subtraction

represent and solve problems involving the addition and subtraction of whole numbers and decimal numbers, using estimation and algorithms

Teacher supports

Key concepts

- Situations involving addition and subtraction may involve:
 - adding a quantity onto an existing amount or removing a quantity from an existing amount;
 - combining two or more quantities;
 - comparing quantities.
- If an exact answer is not needed, an estimation can be used. The estimation can be made by rounding the numbers and then adding or subtracting.
- Estimation may also be used prior to a calculation so that when the calculation is performed, one can determine if it seems reasonable or not.
- If an exact answer is needed, a variety of strategies can be used, including algorithms.

Note

- There are three types of situations that involve addition and subtraction. A problem may combine several situations with more than one operation to form a multi-step or multi-

operation problem (see **SE B2.1**). Recognizing the type and structure of a situation provides a helpful starting point for solving problems.

- *Change* situations, where one quantity is changed, either by having an amount *joined* to it or *separated* from it. Sometimes the result is unknown; sometimes the starting point is unknown; sometimes the change is unknown.
 - *Combine* situations, where two quantities are *combined*. Sometimes one part is unknown; sometimes the other part is unknown; sometimes the result is unknown.
 - *Compare* situations, where two quantities are being *compared*. Sometimes the greater amount is unknown; sometimes the lesser amount is unknown; sometimes the difference between the two amounts is unknown.
- The most common standard algorithms for addition and subtraction in North America use a compact organizer to decompose and compose numbers based on place value. They begin with the smallest unit – whether it is the unit column, decimal tenths, or decimal hundredths – and use regrouping or trading strategies to carry out the computation. (See **Grade 4, SE B2.4** for a notated subtraction example with decimals, and **Grade 3, SE B2.4** for a notated addition example with whole numbers; the same process applies to decimal hundredths.)
 - When carrying out an addition or subtraction algorithm, only common units can be combined or separated. This is particularly noteworthy when using the North American standard algorithms with decimals because, unlike with whole numbers, the smallest unit in a number is not always common (e.g., $90 - 24.7$). The expression “line up the decimal” is about making sure that common units are aligned. Using zero as a placeholder is one strategy to align values.

B2.5 Addition and Subtraction

add and subtract fractions with like and unlike denominators, using appropriate tools, in various contexts

Teacher supports

Key concepts

- The type of models (e.g., linear model, area model) and tools (e.g., concrete materials) that are used to represent the addition or subtraction of fractions can vary depending on the context.
- Addition and subtraction of fractions with the same denominator may be modelled using fraction strips partitioned into the units defined by the denominators with the counts of

the units (numerators) being combined or compared. The result is based on the counts of the same unit.

- For example, if adding, 3 one fourths (three fourths) and 2 one fourths (two fourths) are 5 one fourths (five fourths), or $\frac{3}{4} + \frac{2}{4} = \frac{5}{4}$
- For example, if subtracting, taking 2 one fourths (two fourths) from 7 one fourths (seven fourths) leaves 5 one fourths (five fourths), or $\frac{7}{4} - \frac{2}{4} = \frac{5}{4}$. Or, when thinking about the difference, 5 one fourths (five fourths) is 2 one fourths less than 7 one fourths (seven fourths).
- Addition and subtraction of fractions with unlike denominators may be modelled using fraction strips of the same whole that are partitioned differently. When these fractions are combined or compared, the result is based on the counts of one of the denominators or of a unit that both denominators have in common.
- Hops on a number line may represent adding a fraction on to an existing amount or subtracting a fraction from an existing amount.

Note

- The three types of addition and subtraction situations (see **B2.4**) also apply to fractions.
- As with whole numbers and decimals (see **SE B2.4**), only common units can be added or subtracted. This is also true for fractions. Adding fractions with like denominators is the same as adding anything with like units:
 - 3 apples and 2 apples are 5 apples.
 - 3 fourths and 2 fourths are 5 fourths.
- When adding and subtracting fractions as parts of a whole, the fractions must be based on the same whole. Thus, avoid using a set model because the tendency is to change the size of the whole.
- The numerator in a fraction represents the count of unit fractions. The denominator represents what is being counted (the unit). To add or subtract fractions is to change the total count of units, so only the numerator is added or subtracted.
- If students are adding and subtracting fractions with unlike denominators, they may need to estimate the sum and difference, depending on the tools they are using. This kind of estimation will support fraction sense.
- Without a context, the addition and subtraction of fractions are assumed to be treating the fractions as parts of a whole. Fractions as parts of a whole are commonly added and subtracted in everyday life (e.g., construction, cooking), particularly when combining or comparing units that are commonly used, such as imperial units (inches, feet, pounds, cups, teaspoons).

- Adding and subtracting fractions as comparisons may also have everyday applications. For example, when adding up test scores – a student got 3 of the 4 possible marks ($\frac{3}{4}$) for question 1 and got 4 of the 5 possible marks ($\frac{4}{5}$) for question 2. For the two questions together, the student got 7 of 9 possible marks ($\frac{7}{9}$). In this example, the fractions are comparing what a student got compared to what was possible.

B2.6 Multiplication and Division

represent composite numbers as a product of their prime factors, including through the use of factor trees

Teacher supports

Key concepts

- A number can be decomposed as a product of its factors.
- A prime number can only be expressed as a product of two unique factors, the number itself and 1, for example, $1 = 1 \times 1$.
- A composite number can be expressed as a product of two or more factors. For example, 8 can be written as a product of the factors 1×8 , 2×4 , and $2 \times 2 \times 2$.
- The number 1 is neither prime, nor composite, since it has only one unique factor: itself. It is called a unit.
- Any whole number can be written as a product of its prime factors. Factor trees can be used to show how a number can be repeatedly decomposed until all of its factors are prime.

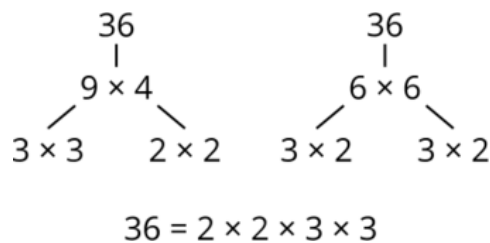

Note

- Prime and composite numbers can be visualized using rectangles. Rectangles with areas that are prime numbers have only one possible set of whole number dimensions; rectangles with areas that are composite numbers have more than one. For example, there is only one rectangle with whole number dimensions that has an area of 11 cm^2

(1 cm × 11 cm), but there are two rectangles that have an area of 4 cm² (1 cm × 4 cm and 2 cm × 2 cm).

- A factor may also be decomposed into other factors.
- The factors of a number can assist with mental calculations. For example, 36 × 4 might be challenging to do mentally, but thinking of this as the product 4 × 3 × 3 × 4 means that the known fact 12 × 12 can be used to determine the product.

B2.7 Multiplication and Division

represent and solve problems involving the multiplication of three-digit whole numbers by decimal tenths, using algorithms

Teacher supports

Key concepts

- An area model can be used to visualize multiplication with decimals.
 - The two numbers being multiplied can be the dimensions of a rectangle.
 - The dimensions can be decomposed by their place value.
 - The number of smaller rectangles formed will depend on how the dimensions have been decomposed.
 - Known facts can be used to determine each of the smaller areas.
 - The smaller areas are added together resulting in the product.

$$235 \times 0.3$$

	200	30	5
0.3	60.0	9.0	1.5

$$\begin{array}{r} \text{Total} = 60.0 \\ \phantom{\text{Total}} + 9.0 \\ \phantom{\text{Total}} + \underline{1.5} \\ \phantom{\text{Total}} 70.5 \end{array}$$

- There are many different algorithms that can be used for multiplication. Students may use one of these algorithms, or their own, and are not required to know all or more than one method. Standard multiplication algorithms for whole numbers can also be applied to decimal numbers. As with whole numbers, these algorithms add partial products to create a total. For example, with 235×0.3 , the partial products are formed by multiplying each whole number by three tenths. Note the connection between this and multiplying a whole number by 30% (see **SE B2.3**) and by a fraction (see **SE B2.9**).

How It May Be Written

$$\begin{array}{r} 23.5 \\ \times 0.3 \\ \hline 0.15 \\ 0.90 \\ + 6.00 \\ \hline 7.05 \end{array}$$

What Is Happening

$\rightarrow 0.3 \times 0.5 = 0.15$
 $\rightarrow 0.3 \times 3.0 = 0.9$
 $\rightarrow 0.3 \times 20.0 = 6.0$

- Another algorithm approach uses factoring and properties of operations. It enables multiplication by tenths to be treated as a whole number calculation, which is then multiplied by a tenth (0.1). For example:
 - 235×0.3 can be thought of as $235 \times 3 \times 0.1$.
 - A standard algorithm determines that 235×3 equals 705.
 - 705 is then multiplied by one tenth (0.1).
 - One tenth of 705 is 70.5.

Multiply by
Whole Numbers

$$\begin{array}{r} 235 \\ \times 3 \\ \hline 705 \end{array}$$

Then Multiply
by 0.1

$\rightarrow 705 \times 0.1 = 70.5$

- The context of multiplication problems may involve:
 - repeated equal groups, including rates.
 - scale factors – ratio comparisons, rates, and scaling.
 - area and certain other measurement attributes.
 - the number of possible combinations of attributes given two or more sets (see **Data, SE D2.2**).
- Connections can be made between the multiplication of a whole number by a decimal number and multiplying a whole number by a percent. For example, 235×0.3 is connected to multiplying a whole number by 30% (see **SE B2.3**) and by a fraction (see **SE B2.9**).
- Multiplication of a whole number by a decimal number between 0 and 1 will result in a product much less than the original number.
- Estimating a product prior to a calculation helps with judging if the calculation is reasonable.

B2.8 Multiplication and Division

represent and solve problems involving the division of three-digit whole numbers by decimal tenths, using appropriate tools, strategies, and algorithms, and expressing remainders as appropriate

Teacher supports

Key concepts

- A strategy to divide whole numbers by decimal numbers is to create an equivalent division statement using whole numbers. For example, $345 \div 0.5$ will have the same result as $3450 \div 5$.
- Often division does not result in whole number amounts. In the absence of a context, remainders can be treated as a leftover quantity, or they can be distributed equally as fractional parts across the groups.
 - When using the standard “long-division” algorithm, the whole number dividend can be expressed as a decimal number by adding zeroes to the right of the decimal point until a terminating decimal number can be determined, or until a decimal number is rounded to an appropriate number of places. For example, $27 \div 8$ can be expressed as $27.000 \div 8$ to accommodate an answer of 3.375.
 - A remainder can be expressed as a fraction (e.g., $27 \div 8 = 3\frac{3}{8}$).

Note

- Multiplication and division are related (see **SE B2.1**).
- When dividing by tenths, contexts often use quotative division and ask “How many tenths are in this amount?” It is more difficult to think of division with decimals as partitive, where an amount is shared evenly among a tenth, although it is possible. For example, thinking of $22 \div 0.5$ partitively means thinking that if 22 is only 5 tenths of the whole, what is the whole?
- The context of a division problem may involve:
 - repeated equal groups, including rates;
 - scale factor – ratio comparisons, rates, and scaling;
 - the area of rectangles;
 - the number of possible combinations of attributes given two or more sets (see **Data, SE D2.2**).
- In real-world situations, the context determines how a remainder should be dealt with:

- Sometimes the remainder is ignored, leaving a smaller amount (e.g., how many boxes of 5 can be made from 17 items?).
 - Sometimes the remainder is rounded up, producing a greater amount (e.g., how many boxes are needed if 17 items are packed in boxes of 5?).
 - Sometimes the remainder is rounded to the nearest whole number, producing an approximation (e.g., if 5 people share 17 items, approximately how many will each receive?).
- Division of a whole number by a decimal number between 0 and 1 will result in a quotient greater than the original whole number.
 - Estimating a quotient prior to a calculation helps with judging if the calculation is reasonable.

B2.9 Multiplication and Division

multiply whole numbers by proper fractions, using appropriate tools and strategies

Teacher supports

Key concepts

- A proper fraction can be decomposed as a product of the count and its unit fraction (e.g., $\frac{3}{4} = 3 \times \frac{1}{4}$ or $\frac{1}{4} \times 3$).
- The strategies used to multiply a whole number by a proper fraction may depend on the context of the problem.
 - If the situation involves scaling, $5 \times \frac{3}{4}$ may be interpreted as "the total number of unit fractions is five times greater". Thus, $5 \times \frac{3}{4} = 5 \times 3 \times \frac{1}{4} = 15 \times \frac{1}{4} = \frac{15}{4}$ (15 fourths).
 - If the situation involves equal groups, $5 \times \frac{3}{4}$ may be interpreted as "five groups of three fourths". Thus, $5 \times \frac{3}{4} = \frac{3}{4} + \frac{3}{4} + \frac{3}{4} + \frac{3}{4} + \frac{3}{4} =$ or $3\frac{3}{4}$.
 - If the situation involves area, $5 \times \frac{3}{4}$ may be interpreted as "the area of a rectangle with a length of five units is multiplied by its width of three fourths of a unit". The area could be determined by finding the area of a rectangle with dimension 5 by 1 and then subtracting the extra area, which is 5 one fourths. Therefore:
 - $5 \times \frac{3}{4}$
 - $= (5 \times 1) - 5 \times (\frac{1}{4})$
 - $= 5 - \frac{5}{4}$

$$= 5 - 1\frac{1}{4}$$

$$= 3\frac{3}{4}$$

Note

- How tools are used to multiply a whole number by a proper fraction can be influenced by the contexts of a problem. For example:
 - A double number line may be used to show multiplication as scaling.
 - Hops on a number line may be used to show multiplication as repeat addition.
 - A grid may be used to show multiplication as area of a rectangle.
- The strategies that are used to multiply a whole number by a proper fraction may depend on the type of numbers given. For example, in the case of $8 \times \frac{3}{4} = 8 \times 3 \times \frac{1}{4}$. Using the associative property, the product of $8 \times \frac{1}{4}$ may be multiplied first and then multiplied by 3. This results in $2 \times 3 = 6$. Another approach is to multiply 8×3 first, which results in 24, which is then multiplied by $\frac{1}{4}$ and resulting in 6.

B2.10 Multiplication and Division

divide whole numbers by proper fractions, using appropriate tools and strategies

Teacher supports

Key concepts

- Multiplication and division are related. The same situation or problem can be represented with a division or a multiplication sentence. For example, the division question $6 \div \frac{3}{4} = ?$ can also be thought of as a multiplication question, $\frac{3}{4} \times ? = 6$.
- The strategies used to divide a whole number by a proper fraction may depend on the context of the problem.
 - If the situation involves scaling, $24 \div \frac{3}{4}$ may be interpreted as “some scale factor of three fourths gave a result of 24”.
 - Therefore, $\frac{3}{4} \times ? = 24$
 - $3 \times \frac{1}{4} \times ? = 24$ or $\frac{1}{4} \times ? = 8$
 - Therefore, the quotient is 32 because 32 one fourths is 8.

- If the situation involves equal groups, $24 \div \frac{3}{4}$ may be interpreted as “How many three fourths are in 24?” Either three fourths is repeatedly added until it has a sum of 24 or it is repeatedly subtracted until the result is zero.
- If the situation involves area, $24 \div \frac{3}{4}$ may be interpreted as “What is the length of a rectangle that has an area of 24 square units, if its width is three fourths of a unit?” Therefore, $\frac{3}{4} \times ? = 24$ may be determined by physically manipulating 24 square units so that a rectangle is formed such that one dimension is three fourths of one whole.

Note

- In choosing division situations that divide a whole number by a fraction, consider whether the problem results in a full group or a partial group (remainder). In Grade 6, students should solve problems that result in full groups.

B2.11 Multiplication and Division

represent and solve problems involving the division of decimal numbers up to thousandths by whole numbers up to 10, using appropriate tools and strategies

Teacher supports

Key concepts

- Multiplication and division are related. The same situation or problem can be represented with a division or a multiplication sentence.
- The strategies used to divide a decimal number by a single digit whole number may depend on the context of the problem and the numbers used.
 - If the situation involves scaling, $2.4 \div 8$ may be interpreted as “some scale factor of 8 gave a result of 2.4” or “What is the scale factor of 8 to give a result of 2.4?” Therefore, $8 \times ? = 2.4$. The result of 0.3 could be determined using the multiplication facts for 8 and multiplying it by one tenth.
 - If the situation involves equal groups, $3.24 \div 8$ may be interpreted as “How much needs to be in each of the 8 groups to have a total of 3.24?” The result of 0.405 could be determined using the standard algorithm.
 - If the situation involves area, $48.16 \div 8$ may be interpreted as “What is the width of a rectangle that has an area of 48.16 square units, if its length is 8 units?”

Therefore, $8 \times ? = 48.16$. The result of 6.02 could be determined using short division.

Note

- Using the inverse operation of multiplication is helpful for estimating and for checking that a calculation is accurate. For example, $1.935 \div 9 = ?$ can be written as $9 \times ? = 1.935$, which verifies that the missing factor must be less than 1.

B2.12 Multiplication and Division

solve problems involving ratios, including percents and rates, using appropriate tools and strategies

Teacher supports

Key concepts

- A ratio describes the multiplicative relationship between two or more quantities.
- Ratios can compare one part to another part of the same whole, or a part to the whole. For example, if there are 25 beads in a bag, of which 10 are red and 15 are blue:
 - The ratio of blue beads to red beads is $15 : 10$ or $\frac{15}{10}$, and this can be interpreted as there are one half times more blue beads than red beads.
 - The ratio of red beads to the total number of beads is $10 : 25$ or $\frac{10}{25}$, and this can be interpreted as 40% of the beads are red.
- Any ratio can be expressed as a percent.
- A rate describes the multiplicative relationship between two quantities expressed with different units. For example, walking 10 km per 2 hours or 5 km per hour.
- Problems involving ratios and rates may require determining an equivalent ratio or rate. An equivalent ratio or rate can be determined by scaling up or down. For example:
 - The ratio of blue marbles to red marbles ($10 : 15$) can be scaled down to $2 : 3$ or scaled up to $20 : 30$. In all cases, there are $\frac{2}{3}$ or approximately 66% as many blue marbles as red marbles.
 - The walking rate 10 km per 2 hours ($10 \text{ km}/2\text{h}$) can be scaled down to 5 km/h (unit rate) or scaled up to 50 km/10 h.

Note

- Ratios compare two (or more) different quantities to each other using multiplication or division. This means the comparison is *relative* rather than *absolute*. For example, if there are 10 blue marbles and 15 red marbles:
 - An absolute comparison uses addition and subtraction to determine that there are 5 more red marbles than blue.
 - A relative comparison uses proportional thinking to determine that:
 - for every 2 blue marbles there are 3 red marbles;
 - there are $\frac{2}{3}$ as many blue marbles as red marbles;
 - there are 1.5 times as many red marbles as blue marbles;
 - 40% of the marbles are blue and 60% of the marbles are red.
- A three-term ratio shows the relationship between three quantities. The multiplicative relationship can differ among the three terms. For example, there are 6 yellow beads, 9 red beads, and 2 white beads in a bag. This situation can be expressed as a ratio of yellow : red : white beads = 6 : 9 : 2. The multiplicative relationship between yellow to white is 6 : 2 or 3 : 1, meaning there are three times more yellow beads than white beads. The multiplicative relationship between yellow and red beads is 6 : 9 or 2 : 3, meaning there are two thirds as many yellow beads as there are red beads.
- Ratio tables can be used for noticing patterns when a ratio or rate is scaled up or down. Ratio tables connect scaling to repeated addition, multiplication and division, and proportional reasoning.

C. Algebra

Overall expectations

By the end of Grade 6, students will:

C1. Patterns and Relationships

identify, describe, extend, create, and make predictions about a variety of patterns, including those found in real-life contexts

Specific expectations

By the end of Grade 6, students will:

C1.1 Patterns

identify and describe repeating, growing, and shrinking patterns, including patterns found in real-life contexts, and specify which growing patterns are linear

Teacher supports

Key concepts

- Repeating patterns have a pattern core that is repeated over and over.
- In growing patterns, there is an increase in the number of elements or the size of the elements from one term to the next.
- Some linear growing patterns have a direct relationship between the term number and the term value; for example, a pattern where each term value is four times its term number. Growing patterns that are linear can be plotted as a straight line on a graph.
- Each iteration of a pattern can be referred to as the term number, and the number of elements in each iteration can be referred to as the term value. The term value is dependent on the term number. The relationship between the term number and the term value can be generalized.
- In shrinking patterns, there is a decrease in the number of elements or the size of the elements from one term to the next.

Note

- Growing and shrinking patterns are not limited to linear patterns.
- Many real-life objects and events can be viewed as having more than one type of pattern.

C1.2 Patterns

create and translate repeating, growing, and shrinking patterns using various representations, including tables of values, graphs, and, for linear growing patterns, algebraic expressions and equations

Teacher supports

Key concepts

- Growing patterns are created by increasing the number of elements or the size of the elements in each iteration (term).
- A growing pattern can be created by repeating a pattern's core. Each iteration shows how the total number of elements grows with each addition of the pattern core.

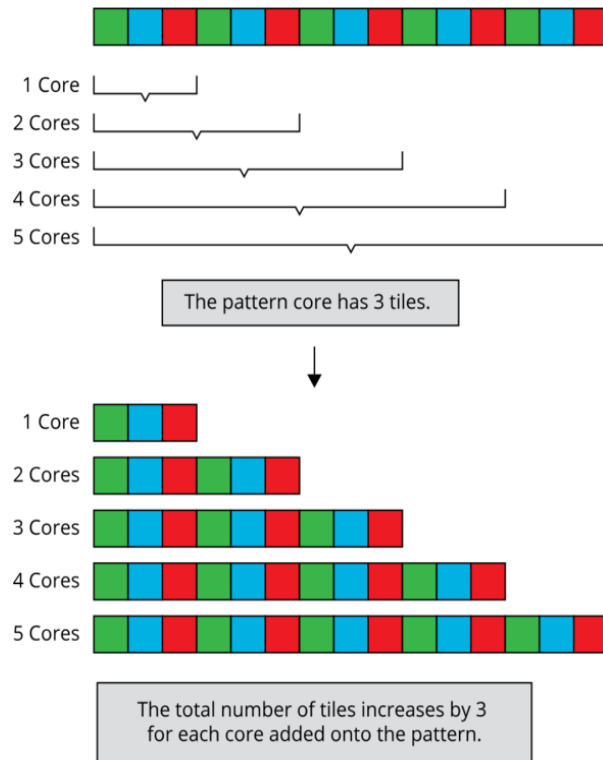

- Shrinking patterns are created by decreasing the number of elements or the size of the elements in each iteration.
- In translating a pattern from a concrete representation to a graph, the term number (x) is represented on the horizontal axis of the Cartesian plane, and the term value (y) is represented on the vertical axis. Each point (x, y) on the Cartesian plane is plotted to represent the pattern. In a table of values, the term number is shown in the left-hand column and the term value is shown in the right-hand column.
- A linear growing pattern can be represented using an algebraic expression or equation to show the relationship between the term number and the term value.
- Examining possible physical structures of a linear growing pattern can provide insight into the different algebraic equations that show the relationship between the term number and term value. For example, in Diagram 1, each term value can be viewed as four more than double the term number, which can be expressed as term value = $2 \times (\text{term number}) + 4$ or $y = 2x + 4$.

Diagram 1

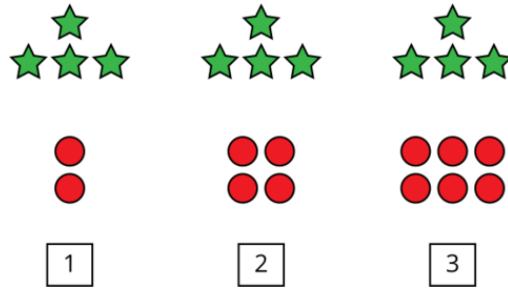

- Diagram 2 shows that for the same pattern, each term value can also be viewed as twice the term number plus two, which can be expressed as term value = term number + two + term number + two or $y = x + 2 + x + 2$. This expression for Diagram 2 can be simplified to $y = 2x + 4$, which is the same expression derived for Diagram 1.

Diagram 2

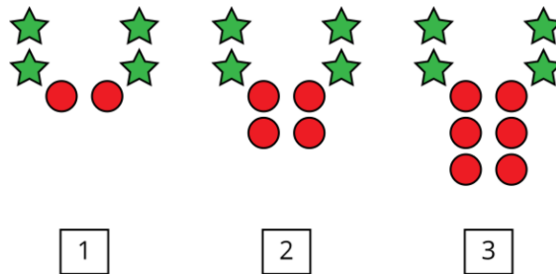

Note

- The creation of growing and shrinking patterns in this grade is not limited to linear patterns.
- The general equation for a linear growing pattern is $y = mx + b$, where x represents the term number, m represents the value of the multiplier, b represents a constant value, and y represents the term value.

C1.3 Patterns

determine pattern rules and use them to extend patterns, make and justify predictions, and identify missing elements in repeating, growing, and shrinking patterns, and use algebraic representations of the pattern rules to solve for unknown values in linear growing patterns

Teacher supports

Key concepts

- Patterns can be extended because they are repetitive by nature.
- Pattern rules are generalizations about a pattern, and they can be described in words.
- Patterns can be extended in multiple directions, showing what comes next and what came before.
- To make a near prediction about a pattern is to state or show what a pattern will look like just beyond the given representation of that pattern. The prediction can be verified by extending that pattern.
- To make a far prediction about a pattern is to state or show what a pattern will look like well beyond the given representation of that pattern. Often calculations are needed to make an informed prediction that can be justified.
- Identifying the missing elements in a pattern represented using a table of values may require determining the term number (x) or the term value (y).
- Identifying the missing elements in a pattern represented on a graph may require determining the point (x, y) within the given representation or beyond it, in which case the pattern will need to be extended.
- The algebraic expression that represents a linear growing pattern is also referred to as the general term or the n th term. It can be used to solve for the term value or the term number.

Note

- Determining a point within the graphical representation of a pattern is called interpolating.
- Determining a point beyond the graphical representation of a pattern is called extrapolating.

C1.4 Patterns

create and describe patterns to illustrate relationships among whole numbers and decimal numbers

Teacher supports

Key concepts

- Patterns can be used to demonstrate relationships among numbers.
- There are many patterns within the decimal number system.

Note

- Many number strings are based on patterns and on the use of patterns to develop a mathematical concept.
- The use of the word “strings” in coding is different from its use in “number strings”.

C2. Equations and Inequalities

demonstrate an understanding of variables, expressions, equalities, and inequalities, and apply this understanding in various contexts

Specific expectations

By the end of Grade 6, students will:

C2.1 Variables and Expressions

add monomials with a degree of 1 that involve whole numbers, using tools

Teacher supports

Key concepts

- A monomial with a degree of 1 has a variable with an exponent of one. For example, the exponent of m for the monomial $2m$ is 1. When the exponent is not shown, it is understood to be one.
- Monomials with a degree of 1 with the same variables can be added together; for example, $2m$ and $3m$ can be combined as $5m$.

Note

- Examples of monomials with a degree of 2 are x^2 and xy . The reason that xy has a degree of 2 is because both x and y have an exponent of 1. The degree of the monomial is determined by the sum of all the exponents of its variables.
- Adding monomials using tools supports students in understanding which monomials can be combined. Only monomials with the same variables (like terms) can be combined.

C2.2 Variables and Expressions

evaluate algebraic expressions that involve whole numbers and decimal tenths

Teacher supports

Key concepts

- To evaluate an algebraic expression, the variables are replaced with numerical values, and calculations are performed based on the order of operations.

Note

- When students are working with formulas, they are evaluating expressions.
- Replacing the variables with numerical values often requires the use of brackets. For example, the expression $4.5m$ becomes $4.5(m)$ and then $4.5(7)$ when $m = 7$. The operation between 4.5 and (7) is understood to be multiplication.
- Many coding applications involve algebraic expressions being evaluated. This may be carried out in several steps. For example, the instruction: “input ‘the side of a square’, sideA” is instructing the computer to define the variable “sideA” and store whatever the user inputs into the temporary location called “sideA”. The instruction: “calculate sideA*sideA, areaA” instructs the computer to take the value that is stored in “sideA” and multiply it by itself, and then store that result in the temporary location, which is another variable called “areaA”.

C2.3 Equalities and Inequalities

solve equations that involve multiple terms and whole numbers in various contexts, and verify solutions

Teacher supports

Key concepts

- Equations are mathematical statements such that the expressions on both sides of the equal sign are equivalent.
- In equations, variables are used to represent unknown quantities.
- There are many strategies to solve equations including guess-and-check, the balance model, and the reverse flow chart.

- The strategy of using a reverse flow chart can be used to solve equations like $\frac{m}{4} - 2 = 10$. The first diagram shows the flow of operations performed on the variable m to produce the result 10. The second diagram shows the reverse flow chart, or flow of the reverse operations, in order to identify the value of the variable m .

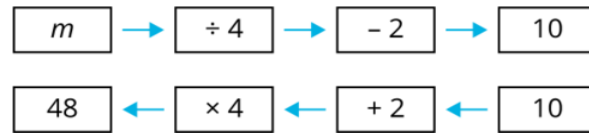

- Formulas are equations in which any of the variables can be solved for. When solving for a variable in a formula, values for the variables are substituted in, and then further calculations may be needed depending on which variable is being solved for. For example, for $A = lw$, if $l = 10$ and $w = 3$, then $A = (10)(3) = 30$. If $A = 50$ and $l = 10$, then $50 = 10w$, and solving this will require either using known multiplication facts or dividing both sides by 10 to solve for w .

Note

- Some equations may require monomials to be added together before they can be solved using the reverse flow chart method.
- The flow chart used in coding is different from the reverse flow chart that can be used to solve equations.

C2.4 Equalities and Inequalities

solve inequalities that involve two operations and whole numbers up to 100, and verify and graph the solutions

Teacher supports

Key concepts

- Inequalities can be solved like an equation, and then values need to be tested to identify those that hold true for the inequality.
- A number line shows the range of values that hold true for an inequality by placing a dot at the greatest or least possible value. An open dot is used if the inequality involves “less than” or “greater than”; if the inequality includes the equal sign ($=$), then a closed dot is used.

Note

- The solution for an inequality that has one variable, such as $2x + 3 < 9$, can be graphed on a number line.
- The solution for an inequality that has two variables, such as $x + y < 4$, can be graphed on a Cartesian plane, showing the set of points that hold true.

C3. Coding

solve problems and create computational representations of mathematical situations using coding concepts and skills

Specific expectations

By the end of Grade 6, students will:

C3.1 Coding Skills

solve problems and create computational representations of mathematical situations by writing and executing efficient code, including code that involves conditional statements and other control structures

Teacher supports

Key concepts

- A flow chart can be used to plan and organize thinking. The symbols used in flow charts have specific meanings, including those that represent a process, a decision, and program input/output.
- Efficient code may involve using the instructions to solve a problem, using the smallest amount of space to store program data, and/or executing as fast as possible.
- Using loops whenever possible is one way to make code more efficient.
- Conditional statements are a representation of binary logic (yes or no, true or false, 1 or 0).
- A conditional statement evaluates a Boolean condition, something that can either be true or false.
- Conditional statements are usually implemented as “if...then” statements, or “if...then...else” statements. If a conditional statement is true, then there is an

interruption in the current flow of the program being executed and a new direction is taken or the program will end.

- Conditional statements, like loops, can be nested to allow for a range of possible outcomes or to implement decision trees.

Note

- Coding can support students in developing a deeper understanding of mathematical concepts.
- The reverse flow chart that is used to solve equations is not the same as the flow chart used in coding.
- More efficient code can reduce execution time and reduce computer storage space.
- Coding can be used to learn how to automate simple processes and enhance mathematical thinking. For example, students can code expressions to recall previously stored information (defined variables), then input values (e.g., from a sensor, count, or user input) and redefine the value of the variable. For examples of these, refer to the notes in **SEs C2.2** and **C2.3**.
- The construction of the code should become increasingly complex and align with other developmentally and grade-appropriate learning.

C3.2 Coding Skills

read and alter existing code, including code that involves conditional statements and other control structures, and describe how changes to the code affect the outcomes and the efficiency of the code

Teacher supports

Key concepts

- Reading code is done to make predictions as to what the expected outcome will be. Based on that prediction, one can determine if the code needs to be altered prior to its execution.
- Reading code helps with troubleshooting why a program is not able to execute.
- Code is altered so that an expected outcome can be achieved.
- Code can be altered to be used for a new situation.
- Altering code to make it more efficient often involves refining algorithms so that there are no unnecessary steps and using control structures effectively.
- Loops can be used to create efficient code.

Note

- When students are reading code, they are exercising problem-solving skills related to predicting and estimating.
- When code is altered with the aim of reaching an expected outcome, students get instant feedback when it is executed. Students exercise problem-solving strategies to further alter the program if they did not get the expected outcome. If the outcome is as expected, but it gives the wrong answer mathematically, students will need to alter their thinking.
- Efficient code can be altered more easily than inefficient code to adapt to new mathematical situations. For example, in a probability simulation, the number of trials can be increased by changing the number of repeats rather than writing additional lines of code for each of the new trials.

C4. Mathematical Modelling

apply the process of mathematical modelling to represent, analyse, make predictions, and provide insight into real-life situations

This overall expectation has no specific expectations. Mathematical modelling is an iterative and interconnected process that is applied to various contexts, allowing students to bring in learning from other strands. Students' demonstration of the process of mathematical modelling, as they apply concepts and skills learned in other strands, is assessed and evaluated.

Read more about the [mathematical modelling process](#).

Teacher supports

Key concepts

- The process of mathematical modelling requires: understanding the problem; analysing the situation; creating a mathematical model; and analysing and assessing the model.

Note

- A mathematical modelling task is different from a real-life application due to the cyclic nature of modelling, which involves examining a problem from outside mathematics, modelling it, and then checking the model back against the real-life situation and adjusting as necessary.

- The process of mathematical modelling should not be confused with using a "model" to represent or solve a problem that does not require the whole process.
- Mathematical modelling tasks can be utilized in many ways and can support students with making connections among many mathematical concepts across the math strands and across other curricula.

D. Data

Overall expectations

By the end of Grade 6, students will:

D1. Data Literacy

manage, analyse, and use data to make convincing arguments and informed decisions, in various contexts drawn from real life

Specific expectations

By the end of Grade 6, students will:

D1.1 Data Collection and Organization

describe the difference between discrete and continuous data, and provide examples of each

Teacher supports

Key concepts

- Quantitative data is either discrete or continuous.
- Discrete data includes variables that can be counted using whole numbers, such as the number of students in a class, the number of pencils in a pencil case, or the number of words in a sentence.
- Continuous data can have an infinite number of possible values for a given range of a variable (e.g., height, length, distance, mass, time, perimeter, and area). Continuous data can take on any numerical value, including decimals and fractions.

Note

- A variable is any attribute, number, or quantity that can be measured or counted.

D1.2 Data Collection and Organization

collect qualitative data and discrete and continuous quantitative data to answer questions of interest about a population, and organize the sets of data as appropriate, including using intervals

Teacher supports

Key concepts

- The type and amount of data to be collected will be based on the question of interest.
- Some questions of interest may require answering multiple questions that involve any combination of qualitative data and quantitative data.
- Depending on the question of interest, the data may need to be collected from a primary or a secondary source.
- Depending on the question of interest, a random sample of the population may need to be taken. Types of sampling methods include simple random sampling, stratified random sampling, and systematic random sampling.
- When continuous data is collected, it can be recorded and organized using intervals in frequency tables.

Note

- A census is an attempt to collect data from an entire population.
- Every subject in the sample must be collected in the same manner in order for the data to be representative of the population.

D1.3 Data Visualization

select from among a variety of graphs, including histograms and broken-line graphs, the type of graph best suited to represent various sets of data; display the data in the graphs with proper sources, titles, and labels, and appropriate scales; and justify their choice of graphs

Teacher supports

Key concepts

- Understanding the features and purposes of different kinds of graphs is important when selecting appropriate displays for a set of data.

- Pictographs, line plots, bar graphs, multiple-bar graphs, and stacked-bar graphs are used to display qualitative data and discrete quantitative data.
- Histograms display continuous quantitative data using intervals. The bars on a histogram do not have gaps between them due to the continuous nature of the data. This contrasts with bar graphs, which do have gaps between the bars to show the discrete categories.
- Broken-line graphs are used to show change over time and are helpful for identifying trends. To create a broken-line graph, students apply their understanding of scales and estimation.
- The source, titles, labels, and scales provide important information about data in a graph or table:
 - The source indicates where the data was collected.
 - The title introduces the data contained in the graph.
 - Labels provide additional information, such as the intervals that have been used in a histogram.
 - Scales identify the possible values of a variable along an axis of a graph.

Note

- It is important for students to understand the difference between a bar graph and a histogram and to recognize that they are not the same.
- At least one of the variables of a broken-line graph is not continuous.

D1.4 Data Visualization

create an infographic about a data set, representing the data in appropriate ways, including in tables, histograms, and broken-line graphs, and incorporating any other relevant information that helps to tell a story about the data

Teacher supports

Key concepts

- Infographics are used in real life to share data and information on a topic, in a concise and appealing way.
- Infographics contain different representations, such as tables, plots, and graphs with limited text.
- Information to be included in an infographic needs to be carefully considered so that it is clear, concise, and connected.

- Infographics tell a story about the data with a specific audience in mind. When creating infographics, students need to create a narrative about the data for that audience.

Note

- Creating infographics has applications in other subject areas, such as communicating key findings and messages in STEM projects.

D1.5 Data Analysis

determine the range as a measure of spread and the measures of central tendency for various data sets, and use this information to compare two or more data sets

Teacher supports

Key concepts

- The mean, median, and mode are the three measures of central tendency. The mean, median, and mode can be determined for quantitative data. Only the mode can be determined for qualitative data.
- A variable can have one mode, multiple modes, or no modes.
- The use of the mean, median, or mode to make an informed decision is relative to the context.
- The range is one type of measure to describe the spread of a data set, and it is the difference between the greatest and least data values.
- Data sets are compared by the mean, median, or mode of the same variable.
- If the data sets that are both representative of a similar population, then it is possible to compare the mean, median, and mode of data sets that have a different number of data values.
- If the data sets are representing different populations, then it is important for the comparison of the mean, median, and mode be based on the same number of data values.

Note

- The range and the measures of central tendency provide information about the shape of the data and how this can be visualized graphically (e.g., when the three measures of central tendency are the same, then a histogram is symmetrical).

D1.6 Data Analysis

analyse different sets of data presented in various ways, including in histograms and broken-line graphs and in misleading graphs, by asking and answering questions about the data, challenging preconceived notions, and drawing conclusions, then make convincing arguments and informed decisions

Teacher supports

Key concepts

- A histogram provides a picture of the distribution or shape of the data.
 - A normal distribution results in a symmetrical histogram that looks like a bell. In this case, the mode, mean, and median are the same.
 - If data are skewed to the left (goes up from left to right), then the mean is likely to be less than the median. If the data are skewed to the right (goes down from left to right), then the mean is likely to be greater than the median.
- Broken-line graphs show changes in data over time.
- Sometimes graphs misrepresent data or show it inappropriately and this can influence conclusions about the data. Therefore, it is important to always interpret presented data with a critical eye.
- Data presented in tables, plots, and graphs can be used to ask and answer questions, draw conclusions, and make convincing arguments and informed decisions.
- Sometimes presented data challenges current thinking and leads to new and different conclusions and decisions.
- Questions of interest are intended to be answered through the analysis of the representations. Sometimes the analysis raises more questions that require further collection, representation, and analysis of data.

Note

- Broken-line graphs are not used to make predictions, only to show what has happened to the data over time. Only data values that show a strong relationship between two variables can be used to make predictions.
- There are three levels of graph comprehension that students should learn about and practise:
 - Level 1: information is read directly from the graph and no interpretation is required.
 - Level 2: information is read and used to compare (e.g., greatest, least) or perform operations (e.g., addition, subtraction).
 - Level 3: information is read and used to make inferences about the data using background knowledge of the topic.
- Working with misleading graphs helps students analyse their own graphs for accuracy.

D2. Probability

describe the likelihood that events will happen, and use that information to make predictions

Specific expectations

By the end of Grade 6, students will:

D2.1 Probability

use fractions, decimals, and percents to express the probability of events happening, represent this probability on a probability line, and use it to make predictions and informed decisions

Teacher supports

Key concepts

- The probability of events has numeric values ranging from 0 to 1, and percent values ranging from 0% to 100%.
- Fractions and decimals can be used to express the probability of events across the 0 to 1 continuum.

Note

- Have students make connections between words to describe the likelihood of events (i.e., “impossible”, “unlikely”, “equally likely”, “likely”, and “certain”) and possible fractions, decimals, and percents that can be used to represent those benchmarks on the probability line.

D2.2 Probability

determine and compare the theoretical and experimental probabilities of two independent events happening

Teacher supports

Key concepts

- Two events are independent if the probability of one does not affect the probability of the other. For example, the probability for rolling a die the first time does not affect the probability for rolling a die the second time.
- The more trials completed in an experiment, the closer the experimental probability will be to the theoretical probability.
- The sum of the probabilities of all possible outcomes is 1 or 100%
- The probability of an event can be used to predict the likelihood of that event happening again in the future.
- Tree diagrams are helpful to determine all the possible outcomes for two independent events.

Note

- “Odds in favour” is a comparison of the probability that an event will occur with the probability that the event will not occur (complementary events). For example, the probability that the sum of two dice is 2 is $\frac{1}{36}$ and the probability that the sum of two dice is not 2 is $\frac{35}{36}$. The odds in favour of rolling a sum of 2 is $\frac{1}{36} : \frac{35}{36}$ or 1 : 35, since the fractions are both relative to the same whole.

E. Spatial Sense

Overall expectations

By the end of Grade 6, students will:

E1. Geometric and Spatial Reasoning

describe and represent shape, location, and movement by applying geometric properties and spatial relationships in order to navigate the world around them

Specific expectations

By the end of Grade 6, students will:

E1.1 Geometric Reasoning

create lists of the geometric properties of various types of quadrilaterals, including the properties of the diagonals, rotational symmetry, and line symmetry

Teacher supports

Key concepts

- A geometric property is an attribute that helps define an entire class of shapes.
- Quadrilaterals are polygons with four sides and four interior angles that add up to 360° . These are defining geometric properties of quadrilaterals. If a polygon has one of these attributes, it will automatically have the other and will be a quadrilateral.
- There are many different sub-categories, or classes, of quadrilaterals, and they are defined by their geometric properties. Certain attributes are particularly relevant for defining the geometric properties of shapes:
 - angles:
 - the number of right angles;
 - the number of reflex angles;
 - sides:
 - the number of equal sides;
 - whether the equal sides are adjacent or opposite;
 - the number of parallel sides;

- symmetries:
 - the number of lines of symmetry;
 - the order of rotational symmetry;
- diagonals:
 - whether they are of equal length;
 - whether they intersect at right angles;
 - whether they intersect at their midpoint.

Note

- Quadrilaterals can be sorted and defined by their geometric properties. Analysing geometric properties is an important part of geometric reasoning. The goal is not to memorize these property lists but to generate and use property lists to create spatial arguments.

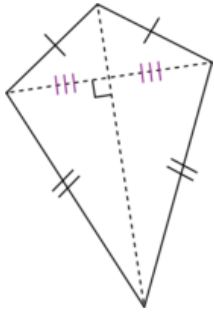
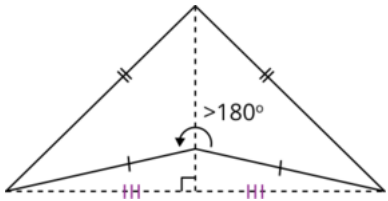
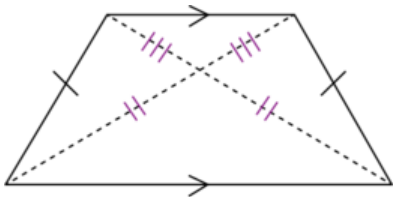
Quadrilateral	Sample Properties	Example
Kite	<ul style="list-style-type: none"> • two pairs of congruent sides that are adjacent (next to each other) • (at least) one line of reflection • (at least) one bisected diagonal (i.e., one diagonal is split in half) • diagonals that intersect at right angles 	
Dart	<p>A kite with:</p> <ul style="list-style-type: none"> • one reflex angle (i.e., greater than 180°) • one diagonal that is not inside the dart 	
Trapezoid	<ul style="list-style-type: none"> • at least one pair of parallel sides <p><i>Note</i> Some definitions of trapezoid specify only one pair of parallel sides. The Ontario mathematics curriculum uses an inclusive definition: any quadrilateral with</p>	 <p style="text-align: center;">Isosceles Trapezoid</p>

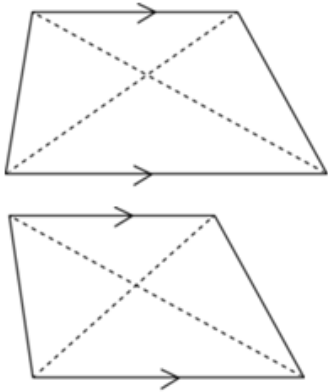
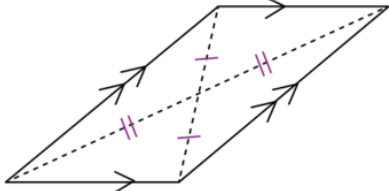
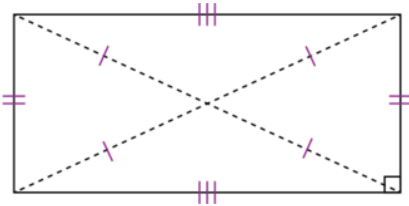
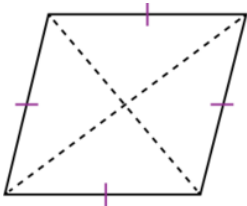
	<p>at least one pair of parallel sides is a trapezoid.</p>	 <p style="text-align: center;">Trapezoid</p>
<p>Parallelogram</p>	<p>a trapezoid with:</p> <ul style="list-style-type: none"> • two pairs of parallel sides • bisected diagonals (i.e., diagonals that split each other in half) • congruent opposite sides 	
<p>Rectangle</p>	<p>a parallelogram with:</p> <ul style="list-style-type: none"> • four right angles • congruent diagonals • (at least) two lines of symmetry • rotational symmetry of (at least) order 2 	
<p>Rhombus</p>	<p>a parallelogram with:</p> <ul style="list-style-type: none"> • all congruent sides • diagonals that intersect at right angles • (at least) two lines of symmetry • rotational symmetry of (at least) order 2 <p>a kite with:</p> <ul style="list-style-type: none"> • all congruent sides • two pairs of parallel sides 	

	<ul style="list-style-type: none"> • (at least) two lines of symmetry • rotational symmetry of (at least) order 2 	
<p>Square</p>	<p>a rectangle with:</p> <ul style="list-style-type: none"> • four congruent sides • congruent diagonals • four lines of symmetry • rotational symmetry of order 4 <p>a rhombus with:</p> <ul style="list-style-type: none"> • four right angles • diagonals that intersect at right angles • four lines of symmetry • rotational symmetry of order 4 <p>a kite with:</p> <ul style="list-style-type: none"> • four congruent sides • four right angles • congruent diagonals that intersect at right angles • four lines of symmetry • rotational symmetry of order 4 	

- Relationships exist among the properties of quadrilaterals. For example, a square is a special type of rectangle, which is a special type of parallelogram.

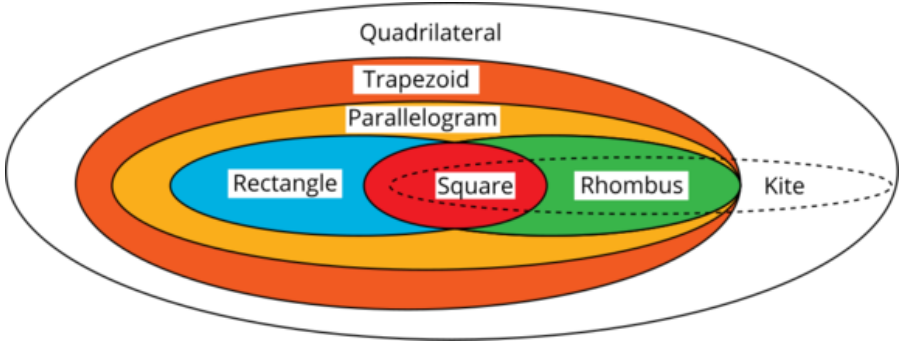

- Minimum property lists identify the fewest properties guaranteed to identify the class (e.g., if a quadrilateral has four lines of symmetry it must be a square).

E1.2 Geometric Reasoning

construct three-dimensional objects when given their top, front, and side views

Teacher supports

Key concepts

- Three-dimensional objects can be represented in two dimensions.
- Given accurate top, front, and side views of an object, with sufficient information included, an object can be reproduced in three dimensions. Conventions exist (e.g., shading squares to show different heights) to clarify any ambiguities.
- Architects and builders use plan (top view) and elevation (side view) to guide their construction. Visualizing objects from different perspectives is an important skill used in many occupations, including all forms of engineering. STEM (science, technology, engineering, and mathematics) professionals use three-dimensional modelling apps to model a project before building a prototype. Three-dimensional objects can be represented in two dimensions.
- Given accurate top, front, and side views of an object, with sufficient information included, an object can be reproduced in three dimensions. Conventions exist (e.g., shading squares to show different heights) to clarify any ambiguities.
- Architects and builders use plan (top view) and elevation (side view) to guide their construction. Visualizing objects from different perspectives is an important skill used in many occupations, including all forms of engineering. STEM (science, technology, engineering, and mathematics) professionals use three-dimensional modelling apps to model a project before building a prototype.

E1.3 Location and Movement

plot and read coordinates in all four quadrants of a Cartesian plane, and describe the translations that move a point from one coordinate to another

Teacher supports

Key concepts

- The X-Y Cartesian plane uses two perpendicular number lines to describe locations on a grid. The x -axis is a horizontal number line, the y -axis is a vertical number line, and these two number lines intersect perpendicularly at the origin, $(0, 0)$, forming four quadrants.
- Pairs of numbers (coordinates) describe the precise location of any point on the plane. The coordinates are enclosed by parentheses as an ordered pair (x, y) . The first number in the pair describes the horizontal distance and the direction from the origin. The second number describes the vertical distance and the direction from the origin. For example, the point $(4, 2)$ is located four units to the right of the origin and two units up; the point $(4, -2)$ is located four units to the right of the origin and two units down; the point $(-4, 2)$ is located four units to the left of the origin and two units up; the point $(-4, -2)$ is located four units to the left of the origin and two units down.

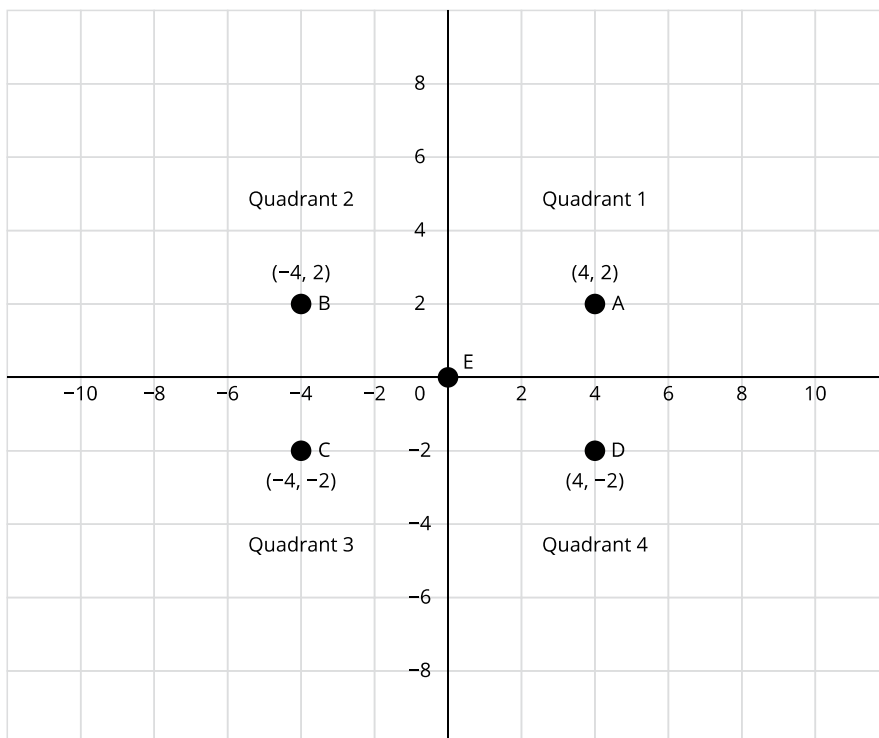

E1.4 Location and Movement

describe and perform combinations of translations, reflections, and rotations up to 360° on a grid, and predict the results of these transformations

Teacher supports

Key concepts

- Transformations on a shape result in changes to its position or its size. As a shape transforms, its vertices (points on a grid) move. The transformation describes the results of the movement. This explains how transformations involve location and movement.
- Transformations can be combined or composed. Sometimes a single transformation can be created by combining multiple transformations.
- A translation involves distance and direction. Every point on the original shape “slides” the same distance and direction to create a translated image. This is called the translation vector. For example, on a grid, a vector could describe that each point moves “5 units right and 2 units up”. It is a mathematical convention that the horizontal distance (x) be given first, followed by the vertical distance (y).
- A reflection involves a line of reflection that acts like a mirror. Every point on the original shape is “flipped” across the line of reflection to create a reflected image. Every point on the original image is the same distance from the line of reflection as the corresponding point on the reflected image. Reflections are symmetrical.
- A rotation involves a *centre* of rotation and an *angle* of rotation. Every point on the original shape turns around the centre of rotation by the same specified angle. Any point on the original is the same distance to the centre of rotation as the corresponding point on the reflected image.
- Because a rotation is a turn, and 360° produces a full turn, a counterclockwise rotation of 270° produces the same result as a clockwise rotation of 90° . Convention has it that a positive angle describes a counterclockwise turn and a negative angle describes a clockwise turn, based on the numbering system of the Cartesian plane (see **SE E1.3**).

Note

- At this grade level, students can express the translation vector using arrows; for example, $(5 \rightarrow, 2 \uparrow)$.
- Dynamic geometry applications are recommended to support students to understand how transformations behave, either as a single transformation, or combined with others.

E2. Measurement

compare, estimate, and determine measurements in various contexts

Specific expectations

By the end of Grade 6, students will:

E2.1 The Metric System

measure length, area, mass, and capacity using the appropriate metric units, and solve problems that require converting smaller units to larger ones and vice versa

Teacher supports

Key concepts

- The choice of an appropriate unit depends on which attribute is being measured and the reason for measuring it.
 - The attribute to be measured determines whether to choose a unit of length, area, mass, or capacity.
 - The reason or context for measuring determines how accurate a measurement needs to be. Large units are used for broad, approximate measurements; small units are used for precise measurements and detailed work.
- When choosing the appropriate size of unit, it is helpful to know that the same set of metric prefixes applies to all attributes (except time) and describes the relationship between the units. Although not all metric prefixes are used commonly in English Canada, understanding the system reinforces the connection to place value:

Metric Prefix	kilo-unit	hecto-unit	deca-unit	unit	deci-unit	centi-unit	milli-unit
Unit Value	1000 units	100 units	10 units	1 unit	$\frac{1}{10}$ unit	$\frac{1}{100}$ unit	$\frac{1}{1000}$ unit
Place Value	thousand	hundred	ten	one	one tenth	one hundredth	one thousandth

- For any metric unit, the next largest unit (e.g., the unit to its left) is 10 times as great, and the next smallest unit (e.g., the unit immediately to its right) is one tenth as great. Both place value and the metric system use the same system of tens, so converting between units parallels multiplying or dividing by powers of 10 (e.g., by 10, 100, 1000). For example, since 1 m is $\frac{1}{1000}$ of 1 km, 28 500 m is 28.5 km ($28\,500 \div 1000$), and since 1 cm is $\frac{1}{100}$ of 1m, 58 centimetre cm is 0.58 metres m ($58 \div 100$).
- There is an inverse relationship between the size of a unit and the count of units: larger units produce a smaller measure, and smaller units produce a larger measure. This

principle is important for estimating whether a conversion will result in a having larger or smaller count of units.

- Because both place value and the metric system are based on a system of tens, metric conversions can be visualized as a shifting of digits to the left or right of the decimal point a certain number of places. The amount of shift depends on the relative size of the units being converted. For example, since 1 km is 1000 times as long as 1 m, 28.5 km becomes 28 500 m when the digits shift three places to the left.
- Conversions are ratios, so the same tools that are useful for scaling and finding equivalent ratios are useful for unit conversions (e.g., double number lines, ratio tables, ratio boxes).

E2.2 Angles

use a protractor to measure and construct angles up to 360° , and state the relationship between angles that are measured clockwise and those that are measured counterclockwise

Teacher supports

Key concepts

- The lines (rays) that form an angle (i.e., the “arms” of an angle) meet at a vertex. The size of the angle is not affected by the length of its arms.
- Protractors, like rulers or any other measuring tool, replace the need to lay out and count individual physical units. The protractor repeats a unit so there are no gaps or overlaps and includes a scale to keep track of the unit count.
- A degree is a very small angle and is a standard unit for measuring angles. When 360 degrees are placed together, they form a circle.

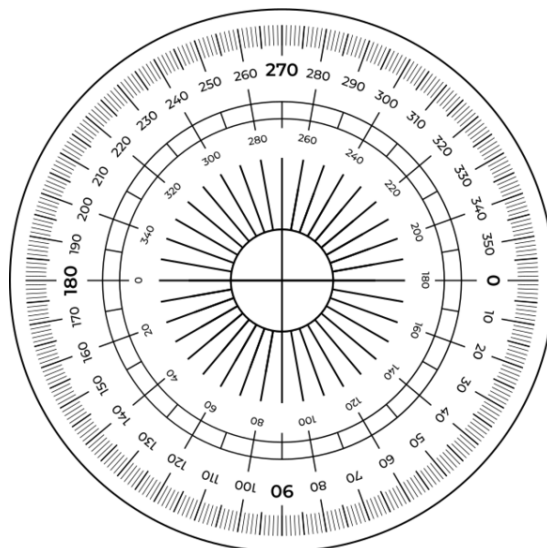

- Since a degree is such a small unit, standard protractors often use a scale (typically in increments of 10) with markings to show the individual degrees. If every degree were labelled, the protractor would need to be much larger.
- Protractors usually include a double scale to make it easier to count the degrees in angles that open clockwise and those that open counterclockwise. On a 180° protractor, the outer scale goes from 0° to 180° and reads from left to right whereas the inner scale goes from 0° to 180° and reads from right to left.
- To make an accurate measurement (i.e., a count of degrees) using a protractor:
 - align the vertex of the line (ray) with the vertex of the protractor (i.e., the midpoint of the protractor where all the degree angles meet);
 - align one arm of the line (ray) with the zero line of the protractor, similar to measuring from zero with a ruler;
 - choose the scale that begins the count at zero, use the scale to count the degrees in the angle, and read the measurement where the arm of the line (ray) crosses the number scale – that is, if the rays open to the right, use the inner scale, and if the rays open to the left, use the outer scale.
- Many common protractors are semi-circular, meaning the scale only counts 180°. There are two strategies to measure or construct a reflex angle: measure the angle beyond the straight angle and add 180° to that amount or subtract the remaining angle from 360°.

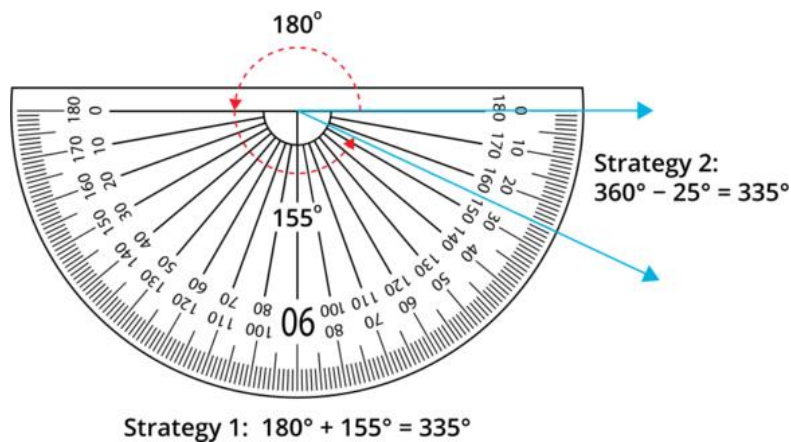

Note

- Smaller angles may be added together to determine a larger angle. This is the additivity principle of measurement.

E2.3 Angles

use the properties of supplementary angles, complementary angles, opposite angles, and interior and exterior angles to solve for unknown angle measures

Teacher supports

Key concepts

- Angles can be measured indirectly (calculated) by applying angle properties. Measuring angles indirectly is often quicker than measuring them directly and is the only choice if the location of an angle is impossible or impractical to measure.
- Smaller angles may be added together to determine a larger angle. This is the additivity principle of measurement.
- Angle properties can be used to determine unknown angles.
 - A straight angle measures 180° ; this property is used to determine the measurement of a supplementary angle and is applied when determining the exterior angles of a polygon.
 - A right-angle measures 90° ; this property is used to determine the measurement of a complementary angle.
 - Interior angles of quadrilaterals sum to 360° ; this property is used to find an unknown angle in a quadrilateral.
 - Interior angles of triangles sum to 180° ; this property is used to find an unknown angle in a triangle.
- Angle properties can also be used to determine other unknown measures (e.g., the exterior angle measures of a polygon) or to explain why opposite angles are equal.

E2.4 Area and Surface Area

determine the areas of trapezoids, rhombuses, kites, and composite polygons by decomposing them into shapes with known areas

Teacher supports

Key concepts

- Partial areas can be added together to find a whole area. If an area is decomposed and rearranged into a different shape (recomposed), the area remains constant. These are applications of the additivity and conservation principles.
- The area of a polygon can be determined by decomposing it into triangles, rectangles, and parallelograms – polygons with known area formulas:
 - Area of a parallelogram or rectangle = $b \times h$, where b represents the base and h represents the height
 - Area of a triangle = $b \times h \div 2$ or $\frac{1}{2} b \times h$
- Spatial relationships among quadrilaterals inform measurement relationships. For example, since all rhombuses, squares, and rectangles are specific types of parallelograms (see **SE E1.1**), the same area (A) formula applies to all: $A = b \times h$.
- Trapezoids can be decomposed into rectangles, parallelograms, or triangles in various ways. The illustrations below show how the four different decomposition strategies result in the same formula on simplification.
- A trapezoid can be decomposed into two triangles and a rectangle and the areas combined:

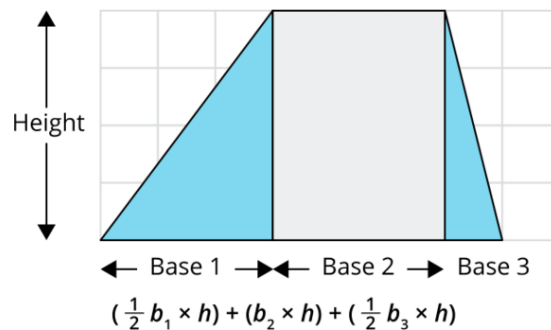

- A trapezoid can be doubled to create a parallelogram whose area is then halved:

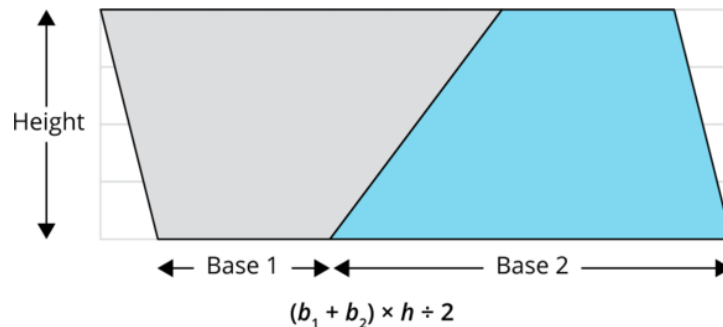

- Two triangles can be added to a trapezoid to create a larger rectangle, and then their areas can be subtracted:

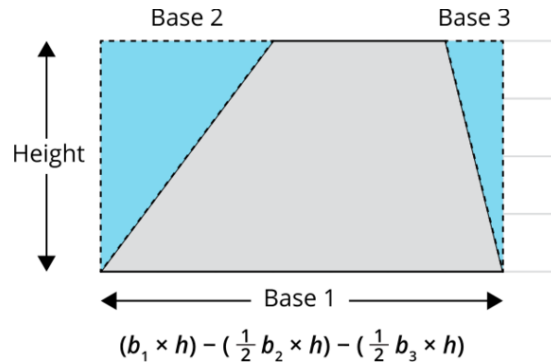

- A trapezoid can be decomposed and then recomposed into a rectangle with the same area, where the base of the rectangle is the average of the two bases of the trapezoid (i.e., by creating two triangles from the midpoints of the sides):

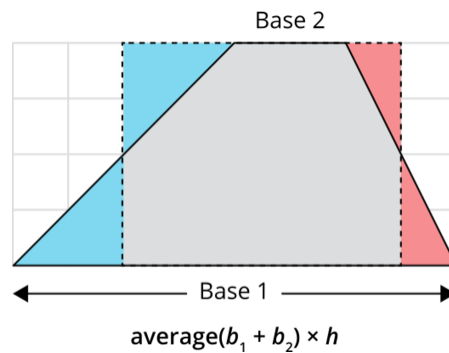

Note

- The same composition and decomposition strategies used to find the area of a trapezoid can be used to determine the area of kites (by decomposing into two triangles) and composite polygons.

E2.5 Area and Surface Area

create and use nets to demonstrate the relationship between the faces of prisms and pyramids and their surface areas

Teacher supports

Key concepts

- Area is additive: partial areas can be added together to find a whole area. Finding the surface area of a prism or pyramid is an application of the property of additivity.
- Nets help in visualizing the two-dimensional shapes that make up the faces of prisms and pyramids.
- Prisms have two parallel, congruent faces, which are the prism's bases. For an object to be a prism, the bases must be joined by rectangles or parallelograms. Rectangles produce "right" prisms and parallelograms produce "oblique" prisms. The shape of a base gives the prism its name (e.g., a prism with two triangles for bases is a triangle-based prism, or triangular prism).
- Pyramids have a single polygon for a base. For an object to be a pyramid, triangles must be joined to each side of the base and meet at the pyramid's apex. The shape of the base gives the pyramid its name (e.g., a pyramid with a square for a base is a square-based pyramid).

Note

- Visualizing the nets for prisms and pyramids – imagining them in the "mind's eye" – involves identifying the number and type of polygons that form their faces. It also involves recognizing how the dimensions of the prism or pyramid relate to the dimensions of the different faces. Being able to visualize a net is helpful for determining surface area.

E2.6 Area and Surface Area

determine the surface areas of prisms and pyramids by calculating the areas of their two-dimensional faces and adding them together

Teacher supports

Key concepts

- Area is additive: partial areas can be added together to find a whole area. Finding the surface area of a prism or pyramid is an application of the property of additivity.
- The faces joining the bases of a prism are rectangles or parallelograms. The faces joining the base of a pyramid are triangles. The areas of these faces can be determined by using

the formula for the area of a rectangle or parallelogram ($b \times h$) and the formula for the area of a triangle ($\frac{1}{2} b \times h$)

- The base of a prism or a pyramid can be any polygon.
 - If the base is a triangle, parallelogram, or trapezoid, then a formula can be used to measure the area of the base indirectly.
 - If the base is not one of these shapes, then its area may still be measured indirectly, by decomposing the shape and recomposing it into areas with known formulas (see **SE E2.4**), or it may be measured directly by overlaying a grid and counting the square units.

F. Financial Literacy

Overall expectations

By the end of Grade 6, students will:

F1. Money and Finances

demonstrate the knowledge and skills needed to make informed financial decisions

Specific expectations

By the end of Grade 6, students will:

F1.1 Money Concepts

describe the advantages and disadvantages of various methods of payment that can be used to purchase goods and services

Teacher supports

Key concepts

- Various methods of payment can be used when purchasing goods and services.
- Considering the advantages and disadvantages of various payment options helps consumers make informed purchasing decisions.

F1.2 Financial Management

identify different types of financial goals, including earning and saving goals, and outline some key steps in achieving them

Teacher supports

Key concepts

- Setting financial goals, including earning and saving goals, is an important life skill.
- Key steps and considerations are involved in achieving set financial goals.

Note

- An understanding of trade-offs may be helpful when setting achievable financial goals.
- Identifying the process of setting financial goals, including considering various influencing factors, and the steps involved in achieving those goals provides a context for developing social-emotional learning skills that build the confidence and competence students need to manage their finances.

F1.3 Financial Management

identify and describe various factors that may help or interfere with reaching financial goals

Teacher supports

Key concepts

- Anticipating potential barriers and considering factors that may help or interfere with reaching financial goals are part of the financial planning process.
- Achievable financial goals are based on context, research, knowledge, and an understanding of each individual situation.

F1.4 Consumer and Civic Awareness

explain the concept of interest rates, and identify types of interest rates and fees associated with different accounts and loans offered by various banks and other financial institutions

Teacher supports

Key concepts

- There are interest rates and fees associated with financial products such as bank accounts and loans.
- Critically examining and comparing the interest rates and fees offered by different financial institutions allows consumers to make informed choices.

F1.5 Consumer and Civic Awareness

describe trading, lending, borrowing, and donating as different ways to distribute financial and other resources among individuals and organizations

Teacher supports

Key concepts

- Financial and other resources can be distributed through different means depending on the context (e.g., cultural, socio-economic, historical, technological).
- Being aware of the various ways in which financial and other resources can be distributed may provide greater flexibility in choosing an appropriate method in a given situation or context.

Mathematics, Grade 7

Expectations by strand

A. Social-Emotional Learning (SEL) Skills in Mathematics and the Mathematical Processes

This strand focuses on students' development and application of social-emotional learning skills to support their learning of math concepts and skills, foster their overall well-being and ability to learn, and help them build resilience and thrive as math learners. As they develop SEL skills, students demonstrate a greater ability to understand and apply the mathematical processes, which are critical to supporting learning in mathematics. In all grades of the mathematics program, the learning related to this strand takes place in the context of learning related to all other strands, and it should be assessed and evaluated within these contexts.

Overall expectations

Throughout this grade, in order to promote a positive identity as a math learner, to foster well-being and the ability to learn, build resilience, and thrive, students will:

A1. Social-Emotional Learning (SEL) Skills and the Mathematical Processes

apply, to the best of their ability, a variety of social-emotional learning skills to support their use of the mathematical processes and their learning in connection with the expectations in the other five strands of the mathematics curriculum

To the best of their ability, students will learn to:	... as they apply the mathematical processes :	... so they can:
1. identify and manage emotions	<ul style="list-style-type: none"> • problem solving: develop, select, and apply problem-solving strategies • reasoning and proving: develop and apply reasoning skills (e.g., classification, recognition of relationships, use of counter-examples) to justify thinking, make and investigate conjectures, and construct and defend arguments 	1. express and manage their feelings, and show understanding of the feelings of others, as they engage positively in mathematics activities
2. recognize sources of stress and cope with challenges	<ul style="list-style-type: none"> • reflecting: demonstrate that as they solve problems, they are pausing, looking back, and monitoring their thinking to help clarify their understanding (e.g., by comparing and adjusting strategies used, by explaining why they think their results are reasonable, by recording their thinking in a math journal) 	2. work through challenging math problems, understanding that their resourcefulness in using various strategies to respond to stress is helping them build personal resilience
3. maintain positive motivation and perseverance	<ul style="list-style-type: none"> • connecting: make connections among mathematical concepts, procedures, and representations, and relate mathematical ideas to other contexts (e.g., other curriculum areas, daily life, sports) 	3. recognize that testing out different approaches to problems and learning from mistakes is an important part of the learning process, and is aided by a sense of optimism and hope
4. build relationships and communicate effectively	<ul style="list-style-type: none"> • communicating: express and understand mathematical thinking, and engage in mathematical arguments using everyday language, language resources as necessary, appropriate mathematical terminology, a variety of representations, and mathematical conventions 	4. work collaboratively on math problems – expressing their thinking, listening to the thinking of others, and practising inclusivity – and in that way fostering healthy relationships
5. develop self-awareness and sense of identity	<ul style="list-style-type: none"> • representing: select from and create a variety of representations of mathematical ideas (e.g., 	5. see themselves as capable math learners, and strengthen their sense of ownership of their learning, as part of their emerging sense of identity and belonging

6. think critically and creatively	representations involving physical models, pictures, numbers, variables, graphs), and apply them to solve problems <ul style="list-style-type: none"> • selecting tools and strategies: select and use a variety of concrete, visual, and electronic learning tools and appropriate strategies to investigate mathematical ideas and to solve problems 	6. make connections between math and everyday contexts to help them make informed judgements and decisions
------------------------------------	--	--

B. Number

Overall expectations

By the end of Grade 7, students will:

B1. Number Sense

demonstrate an understanding of numbers and make connections to the way numbers are used in everyday life

Specific expectations

By the end of Grade 7, students will:

B1.1 Rational Numbers

represent and compare whole numbers up to and including one billion, including in expanded form using powers of ten, and describe various ways they are used in everyday life

Teacher supports

Key concepts

- The numerals 0 to 9 are used to form numbers. They are referred to as the digits in a number and each digit corresponds to a place value. For example, in the number 876 345 107, the digit 8 represents 8 hundred millions, the digit 7 represents 7 ten millions, the digit 6 represents 6 millions, the digit 3 represents 3 hundred thousands, the digit 4 represents 4 ten thousands, the digit 5 represents 5 thousands, the digit 1 represents 1 hundred, the digit 0 represents 0 tens, and the digit 7 represents 7 ones.

- Reading numbers involves interpreting them as a quantity when they are expressed in words, in standard notation, or in expanded notation using powers of ten. Large numbers may be expressed as a decimal number with the unit expressed in words. For example, 36.2 million is equivalent to $36\,200\,000 = 36.2 \times 10^6$.
- Expanded notation with powers of ten shows a number as an expression by using addition, multiplication, and exponents. The number “three hundred seven million, twenty thousand, and fifty”, can be expressed as 307 020 050 and $3 \times 10^8 + 7 \times 10^6 + 2 \times 10^4 + 5 \times 10$.
- Numbers without units identified are assumed to be based on ones.
- Numbers can be written in terms of another number. For example:
 - 1 billion is 1000 millions.
 - 1 billion millimetres is equal to 1000 kilometres.
 - 1 billion seconds is about 32 years.
- Sometimes an approximation of a large number is used to describe a quantity. For example, the number 7 238 025 may be rounded to 7 million, or 7.2 million or 7.24 million, depending on the amount of precision needed.
- Numbers can be compared by their place value or they can be compared using proportional reasoning. For example, 1 billion is 1000 times greater than 1 million.

Note

- Every strand of mathematics relies on numbers.
- Some numbers have cultural significance.
- Real-life contexts can provide an understanding of the magnitude of large numbers. For example:
 - 1 billion seconds is about 32 years.
 - When they are closest to each other, Earth and Saturn are 1.2 billion kilometres apart.
 - Given that Earth’s population is 7.5 billion (and counting), if you are “one in a million”, there are 7500 people just like you.
- There are patterns in the place value system that help people read, write, say, and understand numbers, and that suggest important ways for numbers to be composed and decomposed.
 - The *place* (or position) of a digit determines its *value* (place value). The 5 in 511, for example, has a value of 500, not 5.
 - A zero in a column indicates that there are no groups of that size in the number. It serves as a placeholder, holding the other digits in their correct “place”.

- The value of the columns increases and decreases by powers of ten. With each shift to the left, a digit's value increases by a power of 10 (i.e., its value is ten times as great). With each shift to the right, a digit's value decreases by a power of 10 (i.e., its value is one tenth as great).
- To find the value of a digit in a number, the value of a digit is multiplied by the value of its place.
- Each period – thousands, millions, billions, trillions – is 1000 times as great as the previous period. Periods increase in powers of 1000 (10^3).

Place Value Patterns

Trillions			Billions			Millions			Thousands					
100s	10s	1s	100s	10s	1s	100s	10s	1s	100s	10s	1s	100s	10s	1s
$n \times 10^{14}$	$n \times 10^{13}$	$n \times 10^{12}$	$n \times 10^{11}$	$n \times 10^{10}$	$n \times 10^9$	$n \times 10^8$	$n \times 10^7$	$n \times 10^6$	$n \times 10^5$	$n \times 10^4$	$n \times 10^3$	$n \times 10^2$	$n \times 10^1$	$n \times 10^0$

- When inputting numbers electronically, the “^” sign is used for exponents; for example, 10^6 would be entered as 10^6.

B1.2 Rational Numbers

identify and represent perfect squares, and determine their square roots, in various contexts

Teacher supports

Key concepts

- Any whole number multiplied by itself produces a square number, or a perfect square, and can be represented as a power with an exponent of 2. For example, 9 is a square number because $3 \times 3 = 9$, or 3^2 .
- The inverse of squaring a number is to take its square root. The square root of 9 ($\sqrt{9}$) is 3.
- A perfect square can be represented as a square with an area equal to the value of the perfect square. The side length of a perfect square is the square root of its area. In general, the *area* (A) of a square is *side* (s) \times *side* (s), $A = s^2$.

Note

- Perfect squares are often referred to as square numbers.
- Students should become familiar with the common perfect squares (1, 4, 9, 16, 25, 36, 49, 64, 81, 100, 121, 144) and their associated square roots.
- Squares and square roots are inverse operations.

B1.3 Rational Numbers

read, represent, compare, and order rational numbers, including positive and negative fractions and decimal numbers to thousandths, in various contexts

Teacher supports

Key concepts

- Rational numbers are any numbers that can be expressed as $\frac{a}{b}$, where a and b are integers, and $b \neq 0$. Examples of rational numbers include: $\frac{-5}{4}$, $\frac{3}{6}$, -7 , 0 , 205 , 45.328 , $6.\dot{4}$, -32.5 .
- Fractions (positive and negative) are rational numbers. Any fraction can be expressed as a decimal number that either terminates or repeats.
- Whole numbers are rational numbers since any whole number can be expressed as a fraction (e.g., $5 = \frac{5}{1}$).
- Integers (whole numbers and their opposites) are rational numbers since any integer can be expressed as a fraction (e.g., $-4 = \frac{-4}{1}$, $+8 = \frac{8}{1}$).
- Rational numbers can be represented as points on a number line to show their relative distance from zero.
- The farther a rational number is to the right of zero on a horizontal number line, the greater the number.
- The farther a rational number is to the left of zero on a horizontal number line, the lesser the number.
- Fractions can be written in a horizontal format (e.g., $1/2$ or $\frac{1}{2}$) as well as stacked format (e.g., $\frac{1}{2}$).

Note

- There are an infinite number of rational numbers.
- Whole numbers, integers, positive fractions, and positive decimal numbers can be represented using concrete tools.
- Negative fractions and negative decimal numbers can be represented using a number line.
- Negative fractions have the same magnitude as their corresponding positive fraction. The positive and negative signs indicate their relative position to zero. One way of comparing negative fractions is to rewrite them as decimal numbers (e.g., $\frac{-4}{5} = -0.8$).
- Negative decimal numbers have the same magnitude as their corresponding positive decimal numbers. The positive and negative signs indicate their relative position to zero.

B1.4 Fractions, Decimals, and Percents

use equivalent fractions to simplify fractions, when appropriate, in various contexts

Teacher supports

Key concepts

- Equivalent positive fractions that represent parts of a whole are created by either partitioning or merging partitions.
- A fraction is *simplified* (in lowest terms) when the numerator (count) and the denominator (unit) have no common whole number factor other than 1 (e.g., $\frac{3}{5}$ is in lowest terms, $\frac{4}{6}$ is not in lowest terms because both the numerator and denominator have a common factor of 2).
- Multiplication and division facts are used to create equivalent fractions and reduce fractions to their lowest terms.
- All unit fractions are in lowest terms.

Note

- Positive and negative fractions can represent quotients. Fractions are equivalent when the results of the numerator divided by the denominator are the same.
- Creating equivalent fractions is used to add and subtract fractions that represent parts of a whole when their units (denominators) are different.
- When performing addition, subtraction, multiplication, and division involving fractions, the results are commonly expressed in lowest terms.
- Sometimes, when working with fractions, a fraction may become a complex fraction in which the numerator and/or the denominator are decimal numbers. To express these fractions in lowest terms, both the numerator and the denominator are multiplied by the appropriate power of ten.

B1.5 Fractions, Decimals, and Percents

generate fractions and decimal numbers between any two quantities

Teacher supports

Key concepts

- There are an infinite number of decimal numbers that fall between any two decimal numbers. The place values of the decimal numbers need to be compared to ensure that the number generated does indeed fall between the two numbers.
- The number that falls exactly between any two numbers can be determined by taking the average of the two numbers.
- To determine a fraction between any two fractions, equivalent fractions must be created so that the two fractions have the same denominator in order to do the comparison.

Note

- The number system is infinitely dense. Between any two rational numbers are other rational numbers.

B1.6 Fractions, Decimals, and Percents

round decimal numbers to the nearest tenth, hundredth, or whole number, as applicable, in various contexts

Teacher supports

Key concepts

- Rounding makes a number simpler to work with and is often used when estimating computations, measuring, and making quick comparisons.
- A decimal number is rounded to the nearest thousandth, hundredth, tenth, or whole number based on which hundredth, tenth, or whole number it is closest to. If it is the same distance, it is usually rounded up. However, depending on context, it may be rounded down.
- Rounding involves making decisions about what level of precision is needed and is used in measurement, as well as in statistics. How close a rounded number is to the actual amount depends on the unit it is being rounded to: the larger the unit, the broader the estimate; the smaller the unit, the more precise.

Note

- Some decimal numbers do not terminate or repeat. For example, the decimal representation for π . When working with circles, the decimal representation of π is usually rounded to the nearest hundredth (3.14).

B1.7 Fractions, Decimals, and Percents

convert between fractions, decimal numbers, and percents, in various contexts

Teacher supports

Key concepts

- Converting between fractions, decimals, and percents often makes calculations and comparisons easier to understand and carry out.
- Relationships of quantities relative to a whole can be expressed as a fraction, a decimal number, and a percent. Percents can be greater than 100%.
- Some fractions can be converted to a percent by creating an equivalent fraction with a denominator of 100.
- When fractions are considered as a quotient, the numerator is divided by a denominator and the result is a decimal representation that can be converted to a percent.
- Some decimal numbers when converted to a percent result in a whole number percent (e.g., $0.6 = 60\%$, $0.42 = 42\%$).
- Some decimal numbers when converted to a percent result in a decimal number percent (e.g., $0.423 = 42.3\%$).
- The relationship of multiplying and dividing whole numbers and decimal numbers by 100 is used to convert between decimal numbers and percents.
- Percents can be understood as decimal hundredths.
- Any percent can be represented as a fraction with a denominator of 100. An equivalent fraction can be created expressed in lowest terms.

Note

- Unit fraction conversions can be scaled to determine non-unit conversions (e.g., one fifth = 0.2, so four fifths is $0.2 \times 4 = 0.8$). (See **SE B2.2.**)
- Common benchmark fractions, decimals, and percents include:

- $\frac{1}{2} = 0.5 = 0.50 = 50\%$
- $\frac{1}{4} = 0.25 = 25\%$
- $\frac{1}{5} = 0.2 = 0.20 = 20\%$
- $\frac{1}{8} = 0.125 = 12.5\%$
- $\frac{1}{10} = 0.1 = 0.10 = 10\%$

B2. Operations

use knowledge of numbers and operations to solve mathematical problems encountered in everyday life

Specific expectations

By the end of Grade 7, students will:

B2.1 Properties and Relationships

use the properties and order of operations, and the relationships between operations, to solve problems involving whole numbers, decimal numbers, fractions, ratios, rates, and percents, including those requiring multiple steps or multiple operations

Teacher supports

Key concepts

- Properties of operations are helpful for carrying out calculations.
 - The identity property: $a + 0 = a$, $a - 0 = a$, $a \times 1 = a$, $\frac{a}{1} = a$.
 - The commutative property: $a + b = b + a$, $a \times b = b \times a$.
 - The associative property: $(a + b) + c = a + (b + c)$, $(a \times b) \times c = a \times (b \times c)$.
 - The distributive property: $a \times b = (c + d) \times b = (c \times b) + (d \times b)$.
- The commutative, associative, and identity properties can be applied for any type of number.
- The order of operations needs to be followed when given a numerical expression that involves multiple operations. Any calculations in brackets are done first. Secondly, any

numbers expressed as a power (exponents) are evaluated. Thirdly, multiplication and division are done in the order they appear, from left to right. Lastly, addition and subtraction are done in the order they appear, from left to right.

- Multi-step problems may involve working with a combination of whole numbers, decimal numbers, and fractions.
- Multi-step problems may involve working with a combination of relationships, including ratios, rates, and percents.
- There may be more than one way to solve a multi-step problem.

Note

- This expectation supports most expectations in the Number strand and is applied throughout the grade. Whether working with numbers or operations, recognizing and applying properties and relationships builds a strong foundation for doing mathematics.
- Solving problems with more than one operation involve similar processes to solving problems with a single operation. For both types of problems:
 - Identify the actions and quantities in a problem and what is known and unknown.
 - Represent the actions and quantities with a diagram (physically or mentally).
 - Choose the operations(s) that match the actions to write the equation.
 - Solve by using the diagram (counting) or using the equation (calculating).
- In multi-operation problems, sometimes known as two-step problems, there is often an *ultimate* question (asking for the final answer or result being sought), and a *hidden* question (a step or calculation that must be taken to get to the final result). Identifying both questions is an important part of solving these types of problems.
- The actions in a situation inform the choice of operation. The same operation can describe different situations.
 - Does the situation involve changing (joining, separating), combining, or comparing? Then it can be represented with addition or subtraction.
 - Does the situation involve equal groups (or rates), ratio comparisons (scaling), or arrays? Then it can be represented with multiplication or division.
- Representing a situation as an equation is often helpful in solving it.
- The same situation can be represented with different operations. Each operation has an “inverse” operation – an opposite that “undoes” it. The inverse operation can be used to rewrite an equation to make it easier to calculate, or to check whether a calculation is true.
 - The inverse of addition is subtraction, and the inverse of subtraction is addition. So, for example, $\frac{1}{2} + ? = \frac{3}{4}$ can be rewritten as $\frac{3}{4} - \frac{1}{2} = ?$.

- The inverse of multiplication is division, and the inverse of division is multiplication. So, for example, $\frac{1}{2} \times ? = \frac{3}{8}$ can be rewritten as $\frac{3}{8} \div \frac{1}{2} = ?$.

B2.2 Math Facts

understand and recall commonly used percents, fractions, and decimal equivalents

Teacher supports

Key concepts

- Certain equivalent representations of percents, fractions, and decimals are more commonly used to do mental calculations than others.
- Since 1% is 1 hundredth ($\frac{1}{100}$ or 0.01) of an amount, then any percent can be determined by scaling it up or down.
- Both 1% and 10% ($\frac{1}{10}$ or 0.1) of an amount can be calculated mentally by visualizing how the digits of a number change their place value.
- Five percent ($5\% = \frac{5}{100} = 0.05$) is commonly used to do mental calculations since it is half of ten percent.
- Any percent can be created as a composition of 1%, 5%, and 10%.
- Since 100% of an amount is the amount, then 200% is twice the amount.
- Any fraction can be used as an operator; however, there are certain fractions that are more common than others. For example:
 - One half of an amount ($\frac{1}{2} = 50\% = 0.5$).
 - One fourth of an amount, since it is half of a half ($\frac{1}{4} = 0.25 = 25\%$).
 - Three fourths of an amount, since it is triple one-fourth ($\frac{3}{4} = 0.75 = 75\%$).

Note

- For more about understanding the equivalence between percents, fractions, and decimals, see **SE B1.7**.
- Common benchmark fractions, decimals, and percents include:
 - $\frac{1}{2} = 0.50 = 50\%$
 - $\frac{1}{4} = 0.25 = 25\%$

- $\frac{1}{5} = 0.20 = 0.2 = 20\%$
- $\frac{1}{8} = 0.125 = 12.5\%$
- $\frac{1}{10} = 0.1 = 0.10 = 10\%$
- Unit fraction conversion can be scaled to determine non-unit conversions. For example:
 - 1 one fifth ($\frac{1}{5}$) = 0.2, so 4 one fifths ($\frac{4}{5}$) = $0.2 \times 4 = 0.8$.
 - 1 one fifth ($\frac{1}{5}$) = 20%, so 4 one fifths ($\frac{4}{5}$) = $20\% \times 4 = 80\%$.

B2.3 Mental Math

use mental math strategies to increase and decrease a whole number by 1%, 5%, 10%, 25%, 50%, and 100%, and explain the strategies used

Teacher supports

Key concepts

- Calculating whole number percents is a frequently used skill in daily life (e.g., when determining sales tax, discounts, or gratuities).
- Percents can be composed from other percents. A 15% discount combines a 10% discount and a 5% discount. A 13% tax adds 10% and another 3% ($3 \times 1\%$).
- Visuals are helpful for understanding (and communicating) whether a situation describes a percent increase or decrease or a percent of the whole. Unclear language can obscure the intended meaning.
- Finding a percent *of* a number is scaling an amount down or up. For example, finding 10% of a number is the same as scaling that number to $\frac{1}{10}$ of its size, as illustrated below. On a calculator, $10\% \text{ of } \$50 = 0.10 \times 50 = 5$.

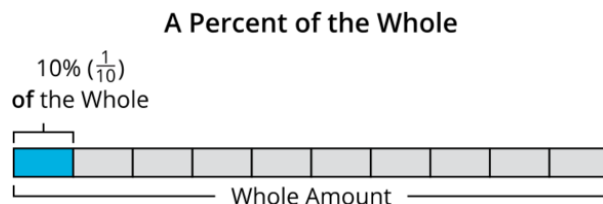

- Decreasing *by* a given percent means the percent is subtracted from the whole. So, a 10% decrease will be 90% ($\frac{9}{10}$) of the whole, as illustrated below. On a calculator, decreasing 50 by 10% = $50 - 10\%$ or $50 - (0.10 \times 50) = 45$.

A Percent Decrease

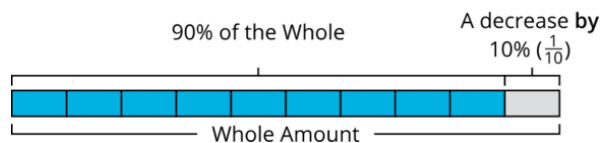

- Increasing *by* a given percent means the percent is added to the whole. So, a 10% increase is 110% ($1\frac{1}{10}$) of the whole, as illustrated below. On a calculator, increasing 50 by 10% = $50 + 10\%$ or $50 + (0.10 \times 50) = 55$.

A Percent Increase

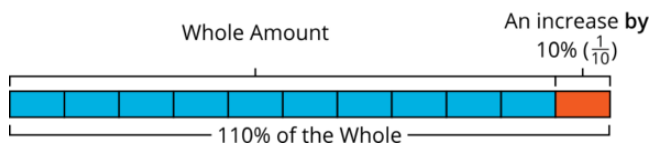

Note

- Mental math is not always quicker than paper and pencil strategies, but speed is not its goal. The value of mental math is in its portability and flexibility, since it does not require a calculator or paper and pencil. Practising mental math strategies also deepens understanding of numbers and operations.
- Estimation is a useful mental strategy when either an exact answer is not needed or there is insufficient time to work out a calculation.

B2.4 Addition and Subtraction

use objects, diagrams, and equations to represent, describe, and solve situations involving addition and subtraction of integers

Teacher supports

Key concepts

- When adding and subtracting integers, it is important to pay close attention to all of the elements of the statement. For example:
 - $(+4) + (-3)$ may be interpreted as combining positive four and negative three.
 - $4 + (-3)$ may be interpreted as adding negative three to positive four.
 - $(-4) - (+3)$ may be interpreted as determining the difference between negative four and positive three by comparing them.

- $(-4) - 3$ may be interpreted as taking away positive three from negative four.
 - $4 - 3$ may be interpreted as taking away positive three from positive four.
 - $-4 - 3$ may be interpreted as taking away positive three from negative four.
- The order in which integers are written in an addition statement does not matter because the commutative property holds true (e.g., $-5 + 3 = 3 + (-5)$). It is important to note that the sign directly in front of the number belongs to the number.
 - The order in which integers are written in a subtraction statement does matter because the commutative property does not hold true. For example, $(-5) - (+3) = -8$ and $(+3) - (-5) = +8$; they do not produce the same result.
 - Addition and subtraction are inverse operations; therefore, a subtraction expression can be rewritten as an addition expression by adding its opposite (e.g., $(-5) - (+3) = (-5) + (-3)$ and $2 - (-4) = 2 + (+4)$).
 - When two positive integers are added together, the result is positive. This can be visualized on a number line as:
 - two vectors moving in a positive direction (right or up);
 - a vector moving in a positive direction from a positive starting position.
 - When two *negative* integers are added together, the result is negative. This can be visualized on a number line as:
 - two vectors moving in a negative direction (left or down);
 - a vector moving in a negative direction from a negative starting position.
 - When a positive and a negative integer are added together, the result is negative if the absolute value of the negative integer is greater than the absolute value of the positive integer. This can be visualized on a number line as:
 - one vector moving in a positive direction and the other vector with a greater magnitude moving in a negative direction (the sign of the resultant vector is negative);
 - a vector moving in a negative direction from a positive starting position with the head of the vector to the left (or below) zero;
 - a vector moving in a positive direction from a negative starting position with the head of the vector to the left (or below) zero.
 - When a positive and a negative integer are added together, the result is positive if the absolute value of the positive integer is greater than the absolute value of the negative integer. This can be visualized on a number line as:

- one vector moving in a negative direction and the other vector with a greater magnitude moving in a positive direction (the sign of the resultant vector is positive);
 - a vector moving in a positive direction from a negative starting position with the head of the vector to the right (or above) zero;
 - a vector moving in a negative direction from a positive starting position and the head of the vector to the right (or above) zero.
- If the two integers added together have the same sign, then their magnitudes are added together.
 - If the two integers added together have different signs, then their magnitude is determined by taking the absolute difference between them.
 - “Zero pairs” are the sum of a positive and a negative number that results in zero.
 - Depending on the models and the integers that are involved in a subtraction, zero pairs may need to be introduced in order to act out the situation. For example, if the situation involves taking away a negative amount but only positive amounts are shown, then adding zero pairs will allow for the negative amount to be removed.
 - If the situation involves comparing two integers, the two integers can be represented as positions on a number line to determine the distance between them (magnitude). The order in which the subtraction statement is written is important in determining the sign. The sign is determined by the direction of the movement from the point represented by the integer after the minus sign (subtrahend) to the point represented by the integer in front of the minus sign (minuend). For example:
 - For $10 - (+2) = +8$, the distance between positive 10 and positive 2 is 8; the movement from positive 2 to 10 is in a positive direction.
 - For $(+2) - (+10) = -8$, the distance between positive 2 and positive 10 is 8; the movement from positive 10 to positive 2 is in a negative direction.
 - For $(2) - (-10) = +12$, the distance between positive 2 and negative 10 is 12; the movement from negative 10 to positive 2 is in a positive direction.

Note

- Familiar real-world contexts for negative and positive integers (e.g., temperature, elevators going up and down, parking garages, sea level, golf scores, plus/minus in hockey, gaining and losing money, walking forward and backwards) provide a starting point for understanding adding and subtracting with integers.
- Situations involving addition and subtraction can be modelled using tools such as a number line and integer tiles.
- When writing an equation, integers are often placed inside brackets and the equation written as $(+3) - (-2) = (+5)$. If an integer sign is not included, the number is considered

positive, so it is also true that $3 - (-2) = 5$. These conventions help reduce confusion between the number and the operation.

- Change can be represented by a positive or negative integer (e.g., rise of 4 expressed as +4, drop of 4 expressed as -4).
- A quantity relative to zero can be represented by a positive or negative integer (e.g., temperature is 3 degrees, temperature is -5 degrees).
- The integers in a situation may be interpreted as changes or as quantities. For example, if the temperature outside drops 5 degrees and then 3 degrees, this may be expressed as the addition of two drops $[(-5) + (-3)]$ or as a subtraction of 3 degrees $(-5 - 3)$. Both statements result in the same answer (-8), meaning the temperature decreased by 8 degrees.
- Modelling addition and subtraction expressions can help with the interpretation of the result relative to the context.

B2.5 Addition and Subtraction

add and subtract fractions, including by creating equivalent fractions, in various contexts

Teacher supports

Key concepts

- The addition and subtraction of fractions with the same denominator can be modelled on the same number line. Each one whole on the number line can be partitioned by the number of units indicated by the denominator. For example:
 - To model $\frac{3}{4} + \frac{2}{4} = \frac{5}{4}$, the number line is partitioned into fourths. Three fourths can be represented as a point and then a vector can be drawn from that point to the right for a distance of two fourths of a unit. The head of the vector is at the point five fourths.
 - To model, $\frac{7}{3} - \frac{2}{3} = \frac{5}{3}$, the number line is partitioned into thirds. Seven thirds and two thirds are represented as points. The distance between the two points is five thirds.
- Strategies to add and subtract fractions with unlike denominators depend on the types of fractions that are given. For example:
 - Mental math can be used to create wholes (ones). For example, for $\frac{1}{2} + \frac{3}{4} = 1\frac{1}{4}$ knowing that three fourths is composed of one half and one fourth, the two halves are combined to make one, and then one fourth is added on.

- Equivalent fractions may be created so that both fractions have a common denominator (e.g., $\frac{2}{3} + \frac{1}{2}$ can be scaled so that both have a denominator of 6, which results in the equivalent expression $\frac{4}{6} + \frac{3}{6}$). This can be modelled using a double number line.

Note

- Fractions are commonly added and subtracted in everyday life, particularly when using imperial units (inches, feet, pounds, cups, teaspoons). Imperial units are commonly used in construction and cooking.
- Only common units can be added or subtracted, whether adding or subtracting whole numbers, decimals, or fractions. Adding fractions with like denominators is the same as adding anything with like units:
 - 3 apples and 2 apples are 5 apples.
 - 3 fourths and 2 fourths are 5 fourths.
- The numerator in a fraction represents the count of unit fractions. The denominator represents what is being counted (the unit). To add or subtract fractions is to change the total count of units. This is why only the numerator is added or subtracted.
- There are helpful ways to visualize the addition and subtraction of fractions. Drawings, fraction strips, clock models, and rulers in imperial units can be used to generate equivalent fractions and model how these common units can be combined or separated.
- The three types of addition and subtraction situations (see **SE B2.1**) also apply to fractions.

B2.6 Multiplication and Division

determine the greatest common factor for a variety of whole numbers up to 144 and the lowest common multiple for two and three whole numbers

Teacher supports

Key concepts

- A number can be written in terms of its factors. For example, the factors of 6 are 1, 2, 3, and 6.
- One is a factor for all numbers. Some numbers only have 1 and themselves as factors, and they are called prime numbers (e.g., 3, 5).

- To determine the common factors among two or more numbers, factors are listed and then the common factors are identified, including the greatest one they have in common. For example:
 - The factors of 6 are {1, 2, 3, 6}.
 - The factors of 12 are {1, 2, 3, 4, 6, 12}.
 - The common factors of 6 and 12 are {1, 2, 3, 6}.
 - The greatest common factor of 6 and 12 is 6.
- The multiples of a number are the multiplication facts related to that number (e.g., the multiplication facts for 2 are 2, 4, 6, 8, 10, 12, ...).
- To determine the lowest common multiple among two or more numbers, multiples are listed and then the common multiples are identified, including the lowest one they have in common. For example:
 - The multiples of 3 are {3, 6, 9, 12, 15, 18, 21, 24, 27, 30, 32, 36 ...} and they are all divisible by 3.
 - The multiples of 4 are {4, 8, 12, 16, 20, 24, 28, 32, 36 ...} and they are all divisible by 4.
 - The common multiples of 3 and 4 are {12, 24, 36 ...}.
 - The lowest common multiple of 3 and 4 is 12.
- The lowest common multiple of a set of numbers is the smallest whole number that divides evenly into all numbers in the set.

Note

- Knowing the greatest common factor among numbers can help with reducing the number of steps to simplify a fraction into its lowest terms. In this case the greatest common factor is being determined for the numerator and the denominator.
- Knowing the lowest common multiple among numbers can help with creating equivalent fractions in order to add or subtract fractions with a common denominator. In this case the lowest common multiple is being determined for all the denominators.

B2.7 Multiplication and Division

evaluate and express repeated multiplication of whole numbers using exponential notation, in various contexts

Teacher supports

Key concepts

- Exponentiation is a fifth number operation, like addition, subtraction, multiplication, and division. It is written as b^n and involves two numbers, where b is the base and n is the exponent or power.
- Exponential notation signifies the multiplication of factors that are all the same, often referred to as repeat multiplication, and known as a power.
- The power has two components: the base and the exponent. The base is the factor that is being repeated, and the exponent states the number of those factors and is written as a superscript. For example:
 - 5^2 has a base of 5, an exponent of 2, and represents 5×5 .
 - 10^5 has a base of 10, an exponent of 5, and represents $10 \times 10 \times 10 \times 10 \times 10$.
- To evaluate a power means to determine the result. Often the power would be rewritten as a product to determine its result. For example, $2^4 = 2 \times 2 \times 2 \times 2 = 16$.
- Powers are used to express very large and very small numbers. They are also used to describe very rapid growth (such as doubling) that increases over time.
- Any number can be written as a power with an exponent 1 (e.g., $5 = 5^1$).

Note

- The term "power of 10" means the base is 10.
- When a number is expressed in expanded form, the place value is written as a power of ten, which means the base is 10. The exponent is dependent on the place value. For example, $500 = 5 \times 10^2$ and $5000 = 5 \times 10^3$.
- Exponential notation can also apply to variables, such as in a formula. For example, in the formula for the area of a circle, $A = \pi r^2$, the r^2 means $r \times r$.
- Using patterns can help with understanding the relationship between the exponents of the same base.

B2.8 Multiplication and Division

multiply and divide fractions by fractions, using tools in various contexts

Teacher supports

Key concepts

- The multiplication and division of two fractions can be interpreted based on the different ways fractions are used: as a quotient, as parts of a whole, as a comparison (ratio), and as an operator.
- The multiplication of two fractions as operators can be modelled as follows:
 - For $\frac{1}{2} \times 1$, the fraction one half as an operator can visually be shown as one half of a rectangle.



- Therefore $\frac{1}{2} \times \frac{1}{2}$, is one half of the one half of a rectangle. The result is one fourth of a rectangle.

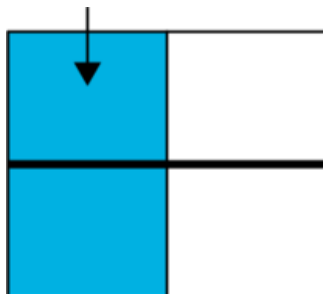

- Division of fractions can be interpreted in two ways:
 - $4 \div \frac{1}{2} = ?$ can be interpreted as “How many one halves are in four?”



- Two one halves make 1, so eight one halves make 4. Therefore, $4 \div \frac{1}{2} = 8$.

- $4 \div \frac{1}{2} = ?$ can also be interpreted as “If 4 is one half of a number, what is the number?”



- Since 4 is one half of a number, the other one half is also 4. Therefore, $4 \div \frac{1}{2} = 8$
- Division of a fraction by its unit fraction (e.g., $\frac{5}{8} \div \frac{1}{8}$) can be interpreted as “How many counts of the unit are in the fraction (i.e., how many one eighths are in five eighths)?” The result is the number of counts (e.g., there are 5 counts of one eighth).
- Dividing a fraction by a fraction with the same denominator (e.g., $\frac{6}{8} \div \frac{2}{8}$) can be interpreted as “How many divisors are in the dividend?” In the fraction strip below, notice there are three counts of two eighths that are in six eighths. Similar to the division of a fraction by its unit fraction, the result is the count.

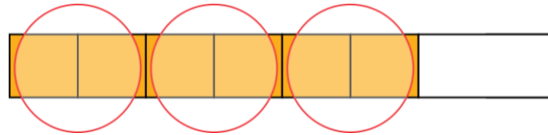

- Sometimes the division of a fraction by a fraction with the same denominator has a fractional result. For example: $\frac{5}{8} \div \frac{2}{8}$

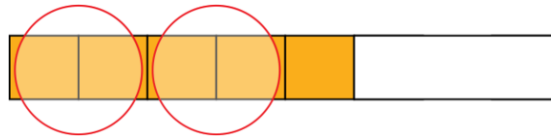

- Notice there are 2 two eighths in five eighths, and then $\frac{1}{2}$ of another two eighths.
- Therefore, $\frac{5}{8} \div \frac{2}{8} = 2\frac{1}{2}$.

Note

- When multiplying a fraction by a fraction using the area of a rectangle, first the rectangle is partitioned horizontally or vertically into the same number of sections as one of the denominators. Next, the region represented by that fraction is shaded to show that fraction of a rectangle. Next, the shaded section of the rectangle is partitioned in the other direction into the same number of sections as the denominator of the second fraction. Now it is possible to identify the portion of the shaded area that is represented by that fraction.

- Any whole number can be written as a fraction with one as its denominator. A whole number divided by a fraction can be used to support students in understanding the two ways division can be interpreted. If context is given, usually only one or the other way is needed. Dividing a whole number by a fraction also helps with making connections to thinking about division of a fraction as the multiplication of its reciprocal.
- In general, dividing fractions with the same denominator can be determined by dividing the numerators and dividing the denominators.
- Multiplying fractions follows a developmental progression that may be helpful in structuring tasks for this grade:
 - A fraction by a whole number (e.g., $5 \times \frac{3}{8}$; 5 groups of $\frac{3}{8}$).
 - A whole number by a fraction (e.g., $\frac{3}{4} \times 24$; multiplication as scaling).
 - A fraction by a fraction, no partitioning (e.g., $\frac{1}{3} \times \frac{3}{4}$; multiplication as scaling).
 - A fraction by a fraction, with partitioning (e.g., $\frac{2}{3} \times \frac{3}{4}$; $\frac{2}{3} \times \frac{4}{5}$).
- Dividing fractions also follows a developmental progression that may be helpful in structuring a task for this grade:
 - A whole number divided by a whole number (e.g., $8 \div 3$).
 - A fraction divided by a whole number (e.g., $\frac{3}{4} \div 2$).
 - A whole number divided by a unit fraction (e.g., $5 \div \frac{1}{3}$).
 - A whole number divided by a fraction (e.g., $5 \div \frac{2}{3}$).
 - A fraction divided by a unit fraction (e.g., $\frac{7}{8} \div \frac{1}{8}$).
 - A fraction divided by a fraction, with the same denominator and a result that is a whole number (e.g., $\frac{4}{5} \div \frac{2}{5}$).
 - A fraction divided by a fraction, with the same denominator and a result that is a fractional amount (e.g., $\frac{3}{4} \div \frac{1}{2}$; $\frac{1}{2} \div \frac{3}{4}$).

B2.9 Multiplication and Division

multiply and divide decimal numbers by decimal numbers, in various contexts

Teacher supports

Key concepts

- Any decimal number multiplied by one is that decimal number.
- One tenth \times one tenth results in a hundredths product ($0.1 \times 0.1 = 0.01$), similar to $10 \times 10 = 100$.
- One tenth \times one hundredth results in a thousandths product ($0.1 \times 0.01 = 0.001$), similar to $10 \times 100 = 1000$.
- One hundredth \times one hundredth results in a ten thousandths product ($0.01 \times 0.01 = 0.0001$), similar to $100 \times 100 = 10\,000$.
- A strategy to multiply decimal numbers is to decompose them as a product of whole numbers with tenths, hundredths, or thousandths and then apply the associative property. For example:

$$\begin{aligned} & \circ 23.5 \times 0.03 \\ & = 235 \times 0.1 \times 3 \times 0.01 \\ & = 705 \times 0.001 \\ & = 0.705 \end{aligned}$$

- Sometimes a combination of words and numbers may be helpful, such as:

$$\begin{aligned} & \circ 23.5 \times 0.03 \\ & = 235 \text{ tenths} \times 3 \text{ hundredths} \\ & = 705 \text{ thousandths or } 0.705 \end{aligned}$$

- The area model can be used to multiply decimal numbers. The decimal numbers can represent the dimensions of a rectangle. Each dimension can be decomposed into its place value, and then the area of each of the sections formed can be determined. For example:
 - 23.5×0.3 can be decomposed as 23 and 5 tenths, and 3 tenths. The partitions that result are 23 by 0.3 (6.9), and 5 tenths by 3 tenths (0.15). The total area is $6.9 + 0.15 = 7.05$.

$$23.5 \times 0.3$$

	23	0.5
0.3	6.9	0.15
	$\begin{array}{r} 6.90 \\ + 0.15 \\ \hline 7.05 \end{array}$	

- Standard multiplication algorithms for whole numbers can also be applied to decimal numbers. As with whole numbers, these algorithms add partial products to create a total. For example, with 23.5×0.3 , the partial products are formed by multiplying each digit according to its place value by three tenths.

How It May Be Written

$\begin{array}{r} 23.5 \\ \times 0.3 \\ \hline 0.15 \\ 0.90 \\ + 6.00 \\ \hline 7.05 \end{array}$	<p style="margin: 0;">What Is Happening</p> <p style="margin: 0;">$0.15 \rightarrow 0.3 \times 0.5 = 0.15$</p> <p style="margin: 0;">$0.90 \rightarrow 0.3 \times 3.0 = 0.9$</p> <p style="margin: 0;">$+ 6.00 \rightarrow 0.3 \times 20.0 = 6.0$</p>
---	--

- To divide decimal numbers, an equivalent division statement with a whole number divisor can be used since the results will be the same. For example: $70.5 \div 0.5 = 705 \div 5$ when both the dividend and the divisor are scaled by 10, and $705 \div 5 = 141$. In some cases, mental calculations can be used to determine the result and at other times the standard algorithm may be applied.
- Estimating a product or quotient prior to a calculation helps in assessing whether a calculation is reasonable.

Note

- Support students in making connections between the area model and the standard algorithms for multiplication.
- Depending on the context, the multiplication of a decimal number may be relative to a scale factor, a measurement, or a partial group.
- Division by decimal amounts disrupts the notion that division “makes numbers smaller”. The question “How many tenths can be made from 3?” (i.e., $3 \div 0.1$) will produce an answer that is larger than three – in fact, it will be ten times as large. As with fractions and measurement, the smaller the unit, the greater the count.

B2.10 Multiplication and Division

identify proportional and non-proportional situations and apply proportional reasoning to solve problems

Teacher supports

Key concepts

- A proportional relationship is when two variables change at the same rate. For example, depositing \$5 into a savings account every month is a proportional situation because the relationship between months and money is constant: \$5 per month. Note that the change is additive (\$5 more per month), but the relationship is multiplicative (\$5 per month):

Month	Deposit	Total Saved	Rate of Change	Rate per Month
1	\$5	\$5	+5	\$5/month
2	\$5	\$10	+5	\$5/month
3	\$5	\$15	+5	\$5/month
4	\$5	\$20	+5	\$5/month

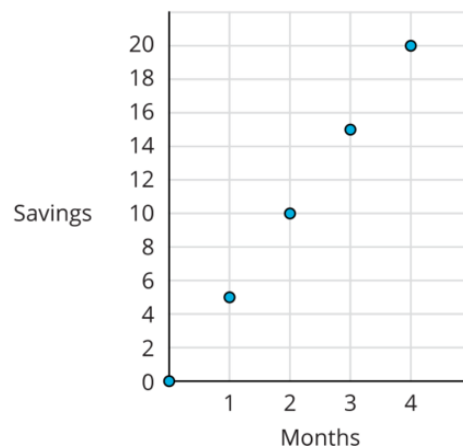

- A non-proportional relationship is when two variables do not change at the same rate. For example, a deposit of \$5 one month and \$2 the next is not proportional because the growth is not constant. The line on a graph would be jagged, not straight.
- Tables and graphs are helpful for seeing proportional (or non-proportional) relationships.
- A proportion is a statement that equates two proportions (ratios, rates): $\frac{a}{b} = \frac{c}{d}$. There are four ways that the proportion can be written for it to hold true. For example, 3 km for every 5 hours and 6 km for every 10 hours can be expressed as:

○ $\frac{3}{5} = \frac{6}{10}$ or

○ $\frac{3}{6} = \frac{5}{10}$ or

○ $\frac{5}{3} = \frac{10}{6}$ or

○ $\frac{6}{3} = \frac{10}{5}$.

- Problems involving proportional relationships can be solved in a variety of ways, including using a table of values, a graph, a ratio table, a proportion, and scale factors.

Note

- Problems that involve proportions with whole numbers provide an opportunity to apply mental calculations that use multiplication and division facts. For example, to solve for m , in a proportion like $\frac{m}{9} = \frac{12}{56}$, one could determine the multiple of 9 that gives 56 and then use that to divide 12 by to find m .
- If two quantities change at the same rate, the quantities are proportional.

C. Algebra

Overall expectations

By the end of Grade 7, students will:

C1. Patterns and Relationships

identify, describe, extend, create, and make predictions about a variety of patterns, including those found in real-life contexts

Specific expectations

By the end of Grade 7, students will:

C1.1 Patterns

identify and compare a variety of repeating, growing, and shrinking patterns, including patterns found in real-life contexts, and compare linear growing patterns on the basis of their constant rates and initial values

Teacher supports

Key concepts

- Repeating patterns have a pattern core that is repeated over and over.
- In growing patterns, there is an increase in the number of elements or the size of the elements from one term to the next.
- If the ratio of the change in one variable to the change in another variable is equivalent between any two sets of data points, then there is a constant rate. An example of a real-life application of a constant rate is an hourly wage of \$15.00 per hour.
- In a comparison of linear growing patterns, the pattern that has the greatest constant rate grows at a faster rate than the others and has a steeper incline as a line on a graph.
- The initial value (constant) of a linear growing pattern is the value of the term when the term number is zero. An example of a real-life application of an initial value is a membership fee.
- The relationship between the term number and the term value can be generalized. A linear growing pattern of the form $y = mx + b$ has a constant rate, m , and an initial value, b . The graph of a linear growing pattern that has an initial value of zero passes through the origin at $(0, 0)$.
- In shrinking patterns, there is a decrease in the number of elements or the size of the elements from one term to the next.

Note

- Growing and shrinking patterns are not limited to linear patterns.

C1.2 Patterns

create and translate repeating, growing, and shrinking patterns involving whole numbers and decimal numbers using various representations, including algebraic expressions and equations for linear growing patterns

Teacher supports

Key concepts

- Growing patterns are created by increasing the number of elements or the size of the elements in each iteration.
- A growing pattern can be created by repeating a pattern core. Each iteration shows how the total number of elements grows with each addition of the pattern core.

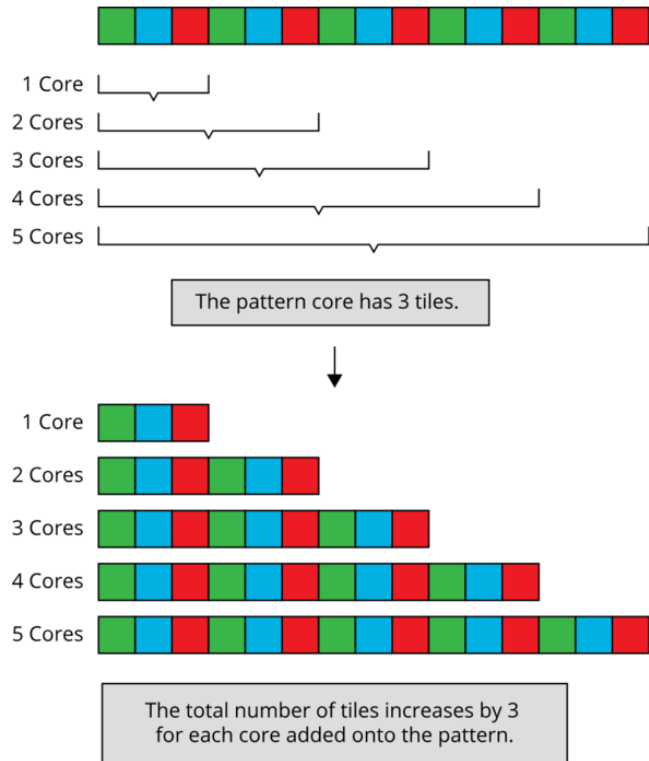

- Shrinking patterns are created by decreasing the number of elements or the size of the elements in each iteration.
- Examining the physical structure of a linear growing pattern can provide insight into the different algebraic equations that show the relationship between the term number and the term value. For example, in Diagram 1, each term value can be viewed as four more than double the term number, which can be expressed as $\text{term value} = 2 \cdot (\text{term number}) + 4$ or $y = 2x + 4$.

Diagram 1

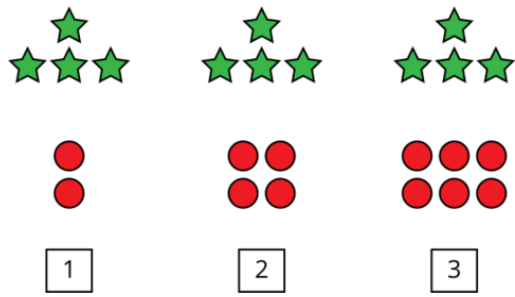

- Diagram 2 shows that for the same pattern, each term value can also be viewed as twice the term number plus two, which can be expressed as $\text{term value} = \text{term number} + 2 + \text{term number} + 2$ or $y = x + 2 + x + 2$. This expression for Diagram 2 can be simplified to $y = 2x + 4$, which is the same expression derived for Diagram 1.

Diagram 2

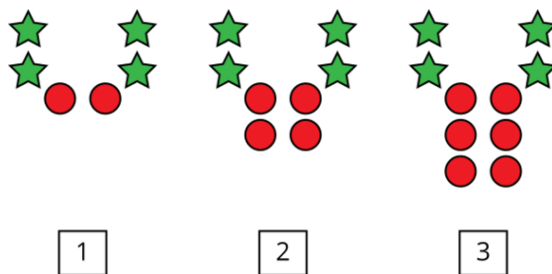

Note

- The creation of growing and shrinking patterns in this grade is not limited to linear patterns.

C1.3 Patterns

determine pattern rules and use them to extend patterns, make and justify predictions, and identify missing elements in repeating, growing, and shrinking patterns involving whole numbers and decimal numbers, and use algebraic representations of the pattern rules to solve for unknown values in linear growing patterns

Teacher supports

Key concepts

- Patterns can be extended because they are repetitive by nature.
- Pattern rules are generalizations about a pattern, and they can be described in words.
- Patterns can be extended in multiple directions, showing what comes next and what came before.
- To make a near prediction about a pattern is to state or show what a pattern will look like just beyond the given representation of that pattern. The prediction can be verified by extending that pattern.
- To make a far prediction about a pattern is to state or show what a pattern will look like well beyond the given representation of that pattern. Often calculations are needed to make an informed prediction that can be justified.
- Identifying the missing elements in a pattern represented using a table of values may require determining the term number (x) or the term value (y).

- Identifying the missing elements in a pattern represented on a graph may require determining the point (x, y) within the given representation or beyond it, in which case the pattern will need to be extended.
- The algebraic expression that represents a linear growing pattern is also referred to as the general term or the n th term. It can be used to solve for the term value or the term number.

Note

- Determining a point within the graphical representation of a pattern is called interpolation.
- Determining a point beyond the graphical representation of a pattern is called extrapolation.

C1.4 Patterns

create and describe patterns to illustrate relationships among integers

Teacher supports

Key concepts

- Patterns can be used to demonstrate relationships within and among number properties, such as expressing numbers in exponential notation.

Note

- Using patterns is a useful strategy in developing understanding of mathematical concepts, such as knowing what sign to use when two integers are added or subtracted.

C2. Equations and Inequalities

demonstrate an understanding of variables, expressions, equalities, and inequalities, and apply this understanding in various contexts

Specific expectations

By the end of Grade 7, students will:

C2.1 Variables and Expressions

add and subtract monomials with a degree of 1 that involve whole numbers, using tools

Teacher supports

Key concepts

- A monomial with a degree of 1 has a variable with an exponent of one. For example, the exponent of m for the monomial $2m$ is 1. When the exponent is not shown, it is understood to be one.
- Monomials with a degree of 1 with the same variables can be added together; for example, $2m$ and $3m$ can be combined as $5m$.
- Monomials with a degree of 1 with the same variables can be subtracted; for example, $10y - 8y = 2y$.
- Monomials can be subtracted in different ways. One way is to compare their representations and determine the missing addend (e.g., $3x + ? = 7x$). Another way is to remove them from the expression representation (e.g., 3 x -tiles are physically removed from the collection of 7 x -tiles).

Note

- Examples of monomials with a degree of 2 are x^2 and xy . The reason that xy has a degree of 2 is because both x and y have an exponent of 1. The degree of the monomial is determined by the sum of all the exponents of its variables.
- Adding and subtracting monomials using tools supports students in understanding which monomials can be simplified. Only monomials with the same variables (like terms) can be simplified.

C2.2 Variables and Expressions

evaluate algebraic expressions that involve whole numbers and decimal numbers

Teacher supports

Key concepts

- To evaluate an algebraic expression, the variables are replaced with numerical values and calculations are performed based on the order of operations.

Note

- When students are working with formulas, they are evaluating expressions.
- Replacing the variables with numerical values often requires the use of brackets. For example, the expression $4.5m$ becomes $4.5(m)$ and then $4.5(7.2)$ when $m = 7.2$. The operation between 4.5 and (7.2) is understood to be multiplication.
- Many coding applications involve algebraic expressions being evaluated. This may be carried out in several steps. For example, the instruction: “input ‘the radius of a circle’, radiusA” is instructing the computer to define the variable “radiusA” and store whatever the user inputs into the temporary location called radiusA. The instruction: “calculate $2 * \text{radiusA}$, diameterA” instructs the computer to take the value that is stored in radiusA and multiply it by two, and then store that result in the temporary location, which is another variable called “diameterA”.

C2.3 Equalities and Inequalities

solve equations that involve multiple terms, whole numbers, and decimal numbers in various contexts, and verify solutions

Teacher supports

Key concepts

- Equations are mathematical statements such that the expressions on both sides of the equal sign are equivalent.
- In equations, variables are used to represent unknown quantities.
- There are many strategies to solve equations including guess-and-check, the balance model, and the reverse flow chart.
- The strategy of using a reverse flow chart can be used to solve equations like $\frac{m}{4} - 2.1 = 10.4$. The first diagram shows the flow of operations performed on the variable m to produce the result 10.4. The second diagram shows the reverse flow chart, or flow of the reverse operations, in order to identify the value of the variable m .

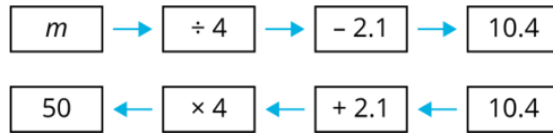

- Formulas are equations in which any of the variables can be solved for. When solving for a variable in a formula, values for the variables are substituted in and then further calculations may be needed depending on which variable is being solved for. For example, $A = lw$, if $l = 10.5$, and $w = 3.5$, then $A = (10.5)(3.5) = 36.75$. If $A = 36.75$ and $l = 10.5$, then $36.75 = 10.5w$, and this will require dividing both sides by 10.5 to solve for w .

Note

- Some equations may require monomials to be added together before they can be solved using the reverse flow chart method.
- The flow chart used in coding is different from the reverse flow chart that can be used to solve equations.

C2.4 Equalities and Inequalities

solve inequalities that involve multiple terms and whole numbers, and verify and graph the solutions

Teacher supports

Key concepts

- An inequality can be solved like an equation, and then values need to be tested to identify those that hold true for the inequality.
- A number line shows the range of values that hold true for an inequality by placing a dot at the greatest or least possible value. An open dot is used when an inequality involves “less than” or “greater than”; if the inequality includes the equal sign ($=$), then a closed dot is used.

Note

- Inequalities that involve multiple terms may need to be simplified before they can be solved.
- The solution for an inequality that has one variable, such as $2x + 3x < 10$, can be graphed on a number line.

- The solution for an inequality that has two variables, such as $x + y < 4$, can be graphed on a Cartesian plane, showing the set of points that hold true.

C3. Coding

solve problems and create computational representations of mathematical situations using coding concepts and skills

Specific expectations

By the end of Grade 7, students will:

C3.1 Coding Skills

solve problems and create computational representations of mathematical situations by writing and executing efficient code, including code that involves events influenced by a defined count and/or sub-program and other control structures

Teacher supports

Key concepts

- Sub-programs are used to assemble a complex program by writing portions of the code that can be modularized. This helps to create efficient code.
- Sub-programs can be used to run specific sequences of code that are only needed or activated in response to specific inputs from the main program.
- Sub-programs can be reused for multiple programs or can be called upon more than once from one main program. For example, a sub-program to determine the area of a rectangle can be used in a program to optimize area, determine the surface area of a rectangle-based prism, and calculate the volume of a rectangle-based prism.

Note

- Coding can support students in developing a deeper understanding of mathematical concepts.
- Coding can be used to learn how to automate simple processes and enhance mathematical thinking. For example, students can code expressions to recall previously stored information (defined variables), then input values (e.g., from a sensor, count, or user input) and redefine the value of the variable. (See SEs C2.2 and C2.3.)

- One way to introduce the idea of a sub-program is to use a defined count. A defined count is used to repeat an instruction either for a predefined number of times (e.g., 10 repeats) or until a condition has been met (e.g., Number \leq 100).
- Students can curate their code from previous learning and use pieces of it as sub-programs for more complex programs.
- If students program a formula for the circle, they may need to use an approximation of pi (3.14 or $\frac{22}{7}$), depending on the programming language they are using.

C3.2 Coding Skills

read and alter existing code, including code that involves events influenced by a defined count and/or sub-program and other control structures, and describe how changes to the code affect the outcomes and the efficiency of the code

Teacher supports

Key concepts

- Reading code is done to make predictions as to what the expected outcome will be. Based on that prediction, one can determine if the code needs to be altered prior to its execution.
- Reading code helps with troubleshooting why a program is not able to execute.
- Code is altered so that an expected outcome can be achieved.
- Code can be altered to be used for a new situation.
- Altering code to make it more efficient often involves refining algorithms so that there are no unnecessary steps and using control structures effectively.
- Loops can be used to create efficient code.
- Using sub-programs makes it easier to debug programs, since each sub-program can be tested individually.

Note

- When students are reading code, they are exercising problem-solving skills related to predicting and estimating.
- By reading code and describing the algorithms, students can begin to communicate their ideas around efficiencies and can begin to compare various “correct” solutions.
- By becoming familiar with pre-existing sub-programs, students can better communicate tools that they might use to solve future, more ambiguous real-life problems.

- When code is altered with the aim of reaching an expected outcome, students get instant feedback when it is executed. Students exercise problem-solving strategies to further alter the program if they did not get the expected outcome. If the outcome is as expected, but it gives the wrong answer mathematically, students will need to alter their thinking.
- Efficient code can be altered more easily than inefficient code to adapt to new mathematical situations. For example, in a probability simulation, the number of trials can be increased by changing the number of repeats rather than writing additional lines of code for each of the new trials.

C4. Mathematical Modelling

apply the process of mathematical modelling to represent, analyse, make predictions, and provide insight into real-life situations

This overall expectation has no specific expectations. Mathematical modelling is an iterative and interconnected process that is applied to various contexts, allowing students to bring in learning from other strands. Students' demonstration of the process of mathematical modelling, as they apply concepts and skills learned in other strands, is assessed and evaluated.

Read more about the [mathematical modelling process](#).

Teacher supports

Key concepts

- The process of mathematical modelling requires: understanding the problem; analysing the situation; creating a mathematical model; and analysing and assessing the model.

Note

- A mathematical modelling task is different from a real-life application due to the cyclic nature of modelling, which involves examining a problem from outside mathematics, modelling it, and then checking the model back against the real-life situation and adjusting as necessary.
- The process of mathematical modelling should not be confused with using a "model" to represent or solve a problem that does not require the whole process.
- Mathematical modelling tasks can be utilized in many ways and can support students with making connections among many mathematical concepts across the math strands and across other curricula.

D. Data

Overall expectations

By the end of Grade 7, students will:

D1. Data Literacy

manage, analyse, and use data to make convincing arguments and informed decisions, in various contexts drawn from real life

Specific expectations

By the end of Grade 7, students will:

D1.1 Data Collection and Organization

explain why percentages are used to represent the distribution of a variable for a population or sample in large sets of data, and provide examples

Teacher supports

Key concepts

- When comparing categories of a large population, it is easier to compare them by relative amounts (i.e., using percentages) rather than by their exact quantities. For example, in a survey administered to 45 896 respondents, 36 572 respondents selected “yes” and 592 selected “maybe”. It is easier to interpret the data if you know that 80% selected “yes” and 1% selected “maybe”.
- A variable for data sets of various populations with different sizes can be compared relatively.

Note

- Samples of varying sizes can also be compared relatively.

D1.2 Data Collection and Organization

collect qualitative data and discrete and continuous quantitative data to answer questions of interest, and organize the sets of data as appropriate, including using percentages

Teacher supports

Key concepts

- The type and amount of data to be collected is based on the questions of interest. Some questions of interest may require answering multiple questions that involve any combination of qualitative data and quantitative data.
- Depending on the question of interest, the data may need to be collected from a primary or a secondary source.
- Depending on the question of interest, a random sample of the population may need to be taken. Types of sampling methods include simple random sampling, stratified random sampling, and systematic random sampling.
- Relative frequency tables are helpful for recording and analysing data and necessary to prepare certain kinds of graphs. The frequencies in a relative frequency table must add to 100% if expressed as percentages and add to 1 if expressed as decimal numbers.
- In order to prepare a circle graph, the angle measures are determined by calculating the percentage of 360 degrees that each sector (category) requires.

D1.3 Data Visualization

select from among a variety of graphs, including circle graphs, the type of graph best suited to represent various sets of data; display the data in the graphs with proper sources, titles, and labels, and appropriate scales; and justify their choice of graphs

Teacher supports

Key concepts

- Circle graphs are used to show how categories represent parts of a whole data set that can be either qualitative or quantitative data. Histograms are used to display intervals of continuous quantitative data.
- Broken-line graphs are used to show changes over time.
- Pictographs, line plots, bar graphs, multiple-bar graphs, and stacked-bar graphs may be used to display qualitative data, and discrete quantitative data.
- The source, titles, labels, and scales provide important information about data in a graph:
 - The source indicates where the data was collected.
 - The title introduces the data contained in the graph.

- Labels provide additional information, such as the categories that are represented in the sectors of a circle graph. Percentages are often used in circle graphs to describe the categories.
- Scales identify the possible values of a variable along an axis of a graph. Values are arranged in ascending order on a scale.

Note

- When there are too many sections in the circle graph, it gets too crowded and hard to read. A possible strategy is to group more than one category together.

D1.4 Data Visualization

create an infographic about a data set, representing the data in appropriate ways, including in tables and circle graphs, and incorporating any other relevant information that helps to tell a story about the data

Teacher supports

Key concepts

- Infographics are used in real life to share data and information on a topic, in a concise and appealing way.
- Infographics contain different representations, such as tables, plots, graphs, with limited text including quotes.
- Information to be included in an infographic needs to be carefully considered so that it is clear, concise, connected, and makes an impact.
- Infographics tell a story about the data with a specific audience in mind. When creating infographics, students need to create a narrative about the data for that audience.

Note

- Creating infographics has applications in other subject areas, such as communicating key findings and messages in STEM projects.

D1.5 Data Analysis

determine the impact of adding or removing data from a data set on a measure of central tendency, and describe how these changes alter the shape and distribution of the data

Teacher supports

Key concepts

- Adding or removing a data value that is not the most frequent value in the set will not impact the mode.
- Adding data values that are extremely different from the existing data values can have a significant impact on the measures of central tendencies. As a result, the distribution and the shape of the data shown in the graphs can change.
- Removing data values that are clustered to one end or the other of an ordered data set can significantly impact the measures of central tendencies. As a result, the distribution and the shape of the data shown in the graphs can change.

Note

- Outliers are measures that are significantly different from the other measures. They may mean that something may have gone wrong in the data collection or they may represent a valid, unexpected piece of the population needing further clarification.

D1.6 Data Analysis

analyse different sets of data presented in various ways, including in circle graphs and in misleading graphs, by asking and answering questions about the data, challenging preconceived notions, and drawing conclusions, then make convincing arguments and informed decisions

Teacher supports

Key concepts

- When interpreting a circle graph, the size of the slices (sectors) will help indicate which category is greatest or least. Sometimes the actual amount is needed, and this will require the percentage to be multiplied by the total number of data values.
- All of the slices (sectors) in a circle graph should add up to 100%.
- Looking at the angle of a sector can help in estimating the percentage that a sector takes up.
- Fractions can also describe the sectors of a circle graph, e.g., if a sector takes up half of the circle, it would represent half of total data.
- Sometimes graphs misrepresent data or show it inappropriately and this can influence the conclusions made about the data. Therefore, it is important to always interpret presented data with a critical eye.
- Data presented in tables, plots, and graphs can be used to ask and answer questions, draw conclusions, and make convincing arguments and informed decisions.

- Sometimes presented data challenges current thinking and leads to new and different conclusions and decisions.
- Questions of interest are intended to be answered through the analysis of the representations. Sometimes the analysis raises more questions that require further collection, representation, and analysis of data.

Note

- There are three levels of graph comprehension that students should learn about and practise:
 - Level 1: information is read directly from the graph and no interpretation is required.
 - Level 2: information is read and used to compare (e.g., greatest, least) or perform operations (e.g., addition, subtraction).
 - Level 3: information is read and used to make inferences about the data using background knowledge of the topic.

D2. Probability

describe the likelihood that events will happen, and use that information to make predictions

Specific expectations

By the end of Grade 7, students will:

D2.1 Probability

describe the difference between independent and dependent events, and explain how their probabilities differ, providing examples

Teacher supports

Key concepts

- Two events are independent when the outcome of one event does not affect the outcome of the other event.
- Two events are dependent when the outcome of the first event affects the outcome of the second event.

Note

- The probabilities for independent and dependent events can be compared when based on the same event with slightly different conditions. For example, the probability of selecting two names from a bag with replacement versus the probability of selecting two names from a bag without replacement.

D2.2 Probability

determine and compare the theoretical and experimental probabilities of two independent events happening and of two dependent events happening

Teacher supports

Key concepts

- The more trials completed in an experiment, the closer the experimental probability will be to the theoretical probability.
- The sum of the probability of all possible outcomes is 1 or 100%.
- The probability of an event can be used to predict the likelihood of that event happening again in the future.
- Tree diagrams are helpful to determine all the possible outcomes for two independent events and two dependent events.

Note

- “Odds in favour” is a comparison of the probability that an event will occur with the probability that the event will not occur (complementary events). For example, the probability that the sum of two dice is 2 is $\frac{1}{36}$ and the probability that the sum of two dice is not 2 is $\frac{35}{36}$. The odds in favour of rolling a sum of 2 is $\frac{1}{36} : \frac{35}{36}$ or 1 : 35, since the fractions are both relative to the same whole

E. Spatial Sense

Overall expectations

By the end of Grade 7, students will:

E1. Geometric and Spatial Reasoning

describe and represent shape, location, and movement by applying geometric properties and spatial relationships in order to navigate the world around them

Specific expectations

By the end of Grade 7, students will:

E1.1 Geometric Reasoning

describe and classify cylinders, pyramids, and prisms according to their geometric properties, including plane and rotational symmetry

Teacher supports

Key concepts

- A geometric property is an attribute that helps define a class of objects.
- Cylinders, pyramids, and prisms represent three broad categories of three-dimensional objects.
- There are many attributes that are used to distinguish and define sub-categories or classes of objects, including:
 - the shape of the base or bases;
 - the number of bases;
 - the number of edges and vertices;
 - whether the object is symmetrical (e.g., whether it has rotational or plane symmetry);
 - whether the faces are perpendicular to the bases.
- Three-dimensional objects can have rotational symmetry (when an object can rotate around an axis and find a new spin position that matches its original position) and plane symmetry (when an object can be split along a plane to create two symmetrical parts). Generating property lists and using them to create geometric arguments builds spatial

sense. Minimum property lists identify the fewest properties needed to identify a class (e.g., if a prism has only one plane of symmetry, it must be an oblique prism). The following is a list of some properties for cylinders, prisms, and pyramids.

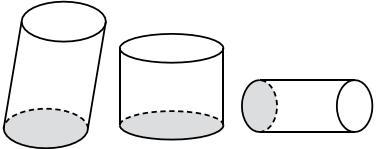
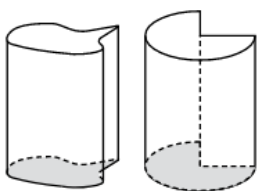
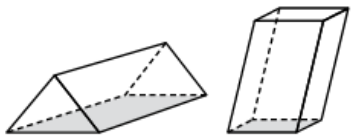
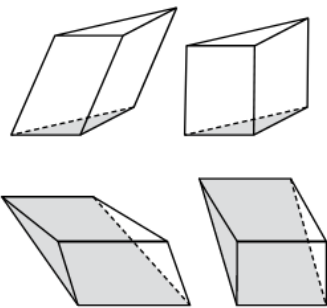
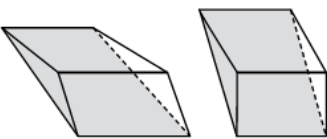
<p>Cylinders</p>	<ul style="list-style-type: none"> • Cylinders have two congruent faces that are parallel to each other. These are the bases of the cylinder. The bases of a cylinder may be circular, or its edges may be curved, straight, or some combination of curved or straight. • Any cross-section of a cylinder that is parallel to the base produces a face that is identical to its base. • Parallel lines (elements) join one base to the other. If the base of a cylinder is circular, it is a circular cylinder. If the base is a polygon, the cylinder is also a prism. • Cylinders may be right-angled or oblique, depending on whether the lines (elements) joining the bases are perpendicular to the bases or not. • All cylinders have translational symmetry (e.g., one base can be translated onto the other base), circular right cylinders also have plane and rotational symmetry. Whether a cylinder has rotational or reflective symmetry can distinguish subcategories of cylinders. • The height of a cylinder is the distance between its bases. 	 <p style="text-align: center;">Cylinders</p>  <p style="text-align: center;">Non-Circular Cylinders</p>  <p style="text-align: center;">Special Cylinders: Prisms</p>
<p>Prisms</p>	<ul style="list-style-type: none"> • Prisms are special types of cylinders, with two congruent, polygonal faces that are parallel to each other. These are the bases of the prism. • Any cross-section of a prism that is parallel to the base produces a face that is identical to the base. • A prism is named for the shape of its base. So, for example, triangle-based prisms (or simply, triangular prisms) have two bases that are triangular, which are joined by parallelograms. 	  <p style="text-align: center;">Triangular Prisms</p>

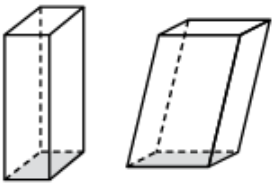
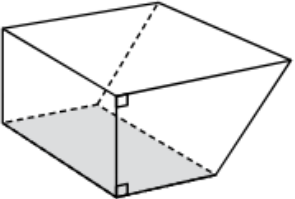
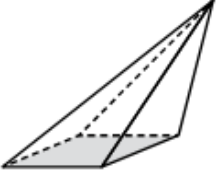
	<ul style="list-style-type: none"> • The lines (elements) joining the bases form faces that are parallelograms (inclusive of rectangles). • Prisms may be right-angled or oblique, depending on whether the lines (elements) joining the bases are perpendicular to the base or not. Rectangular faces produce right prisms; faces that are non-rectangular parallelograms produce oblique prisms. • All prisms have translational symmetry (i.e., one base can be translated onto the other base). Whether a prism has rotational or reflective symmetry can distinguish subcategories of prisms. • The height of a prism is the distance between its bases. 	 <p>Rectangular Prisms</p>  <p>Trapezoidal Prism</p>
<p>Pyramids</p>	<ul style="list-style-type: none"> • Pyramids are a special type of cone with a polygon for a base. Triangles extend from each side of the base and join at the apex of the pyramid. • Any cross section of a pyramid, if it is parallel to its base, produces a scaled (similar) version of its base. • A pyramid is named for the shape of its base. So, for example, a hexagon-based pyramid (or a hexagonal pyramid) has a hexagon for its base and six triangular faces. • Pyramids may be right-angled or oblique, depending on whether the apex of the pyramid lies directly above the centre (i.e., the diagonal bisectors) of its base. • Pyramids may or may not have rotational or reflective symmetry, depending on the shape of their bases. 	 <p>Rectangular Pyramid</p>

E1.2 Geometric Reasoning

draw top, front, and side views, as well as perspective views, of objects and physical spaces, using appropriate scales

Teacher supports

Key concepts

- Three-dimensional objects can be graphically projected in two dimensions. Two-dimensional representations show how things are made, how they can be navigated, or how they can be reproduced, and can be used to represent anything from very small objects to very large spaces. They are used by designers, builders, urban planners, instruction illustrators, and others.
- Top (plan) views, and front and side (elevation) views are “flat drawings” without perspective. They are used in technical drawings to ensure a faithful reproduction in three dimensions.
- Scales are used to convey the proportions of the original (i.e., angles and relative distances). If the scale is 1:100, then 1 cm always represents 100 cm at full size, regardless of the view. A legend communicates the scale.
- A perspective drawing shows three views (top, front, side) in one illustration.
 - Perspective views cannot show the back side, so some elements may be hidden.
 - They are also better at representing straight edges than curves.
 - To achieve the appearance of perspective, they may distort angles and lengths.
 - They are often easier to visualize than elevation drawings and are typically preferred for illustrations.
- Two types of perspective drawings are isometric projections and cabinet projections.

Note

- Isometric projections show an object from the “corner”, with the width and depth going off at equal angles. In isometric projections, a scale is applied consistently to all dimensions (e.g., 1 cm = 2 cm, for the height, width, and depth).

E1.3 Location and Movement

perform dilations and describe the similarity between the image and the original shape

Teacher supports

Key concepts

- A dilation (or dilatation) is a transformation that enlarges or reduces a figure by a certain scale factor. Unlike translations, reflections, and rotations, a dilation does not produce a congruent image.
- A dilated image is *similar* to the original. In everyday language, a *similar* image means it simply resembles something else. In mathematics, *similar* has a very precise meaning. Similar figures have the same shape (angles are congruent) and their corresponding sides are proportional. If the width of a dilated rectangle is now twice as long, so too is its length.

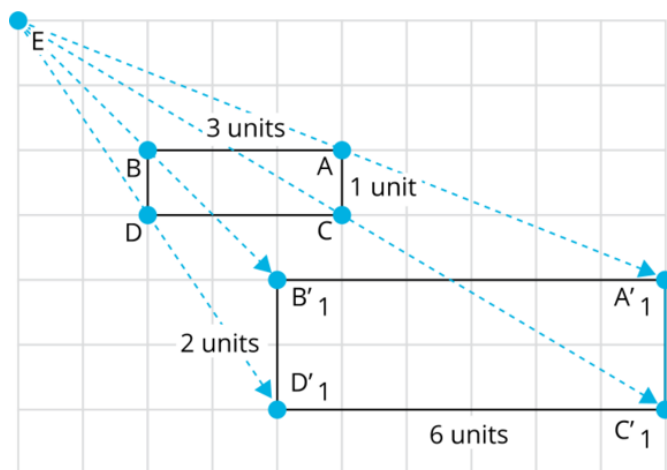

Note

- Dynamic geometry applications are recommended tools for understanding how transformations behave *in motion*. In a dynamic environment, repositioning the point of dilation has an immediate impact, as does changing the scale factor.
- Dilations have connections to the concept of one-point perspective in Grade 7 of the Visual Arts strand of the Arts curriculum (see [The Ontario Curriculum, Grades 1–8: The Arts, 2009](#), p. 143).

E1.4 Location and Movement

describe and perform translations, reflections, and rotations on a Cartesian plane, and predict the results of these transformations

Teacher supports

Key concepts

- Translations, reflections, and rotations all produce congruent images.
- Translations “slide” a shape by a given distance and direction (vector).
- Reflections “flip” a shape across a reflection line to create its opposite.
- Rotations “turn” a shape around a centre of rotation by a given angle.
- When shapes are transformed on a Cartesian plane, patterns emerge between the coordinates of the original and the corresponding coordinates of the image. These patterns are particularly evident when:
 - the translation vector (distance and direction) is compared to the coordinates of the original and the translated image;
 - a shape is reflected across the x -axis or the y -axis;
 - a shape is rotated by 90° or 180° around the point of origin $(0, 0)$.

E2. Measurement

compare, estimate, and determine measurements in various contexts

Specific expectations

By the end of Grade 7, students will:

E2.1 The Metric System

describe the differences and similarities between volume and capacity, and apply the relationship between millilitres (mL) and cubic centimetres (cm^3) to solve problems

Teacher supports

Key concepts

- There is a relationship between volume and capacity.
- Volume can describe many aspects of the same object, so it is important to clarify “which volume” is being measured. For example, the volume of a cup could refer to:
 - the volume of liquid the cup could hold (i.e., its capacity – see the note below);
 - the volume of material needed to make the cup; or

- the volume of space needed if packing the cup in a box.
- Volume is measured in cubic units, and the measure represents the number of cubes needed to completely fill an object. Similar to units of area, a cubic unit is an amount of volume, and can come in any shape. Units of volume can be decomposed, rearranged, partitioned, and redistributed to better fill a volume and minimize gaps and overlaps.
- The row-and-column structure of an array that is the basis for indirectly measuring area (see **Grade 4, E2.5**) also helps structure the count of cubic units and is used to indirectly measure volume (see **SE E2.7**).
- Common metric units of volume include cubic centimetres (cm^3) and cubic metres (m^3). Common metric units of capacity are milliliters (mL), litres (L), and kilolitres (kL).
- There are relationships between metric units of capacity and volume: 1 mL of liquid occupies 1 cm^3 of space, and a 1L container has an interior volume of 1000 cm^3 .
- The relationship between volume and capacity means that the volume of an object can be found using displacement: the amount of water displaced by an object (or the amount that the water rises) when it is submerged is equal to its volume. For example, if an object is dropped into 1 L of water, and the water level rises to 1.5 L, the change is 500 mL, which is equal to a volume of 500 cm^3 .

Note

- Volume and capacity are not the same thing. An object will always take up space (volume), but it may not have capacity. A solid, for example, has volume but no capacity. The capacity of an object will also depend on its design; it may not be the same as the volume. For example, a vase may have a solid chunk of glass for its base resulting in less capacity than volume.
- In real-life experiences, units of volume and capacity may be used interchangeably.

E2.2 The Metric System

solve problems involving perimeter, area, and volume that require converting from one metric unit of measurement to another

Teacher supports

Key concepts

- Multiplicative relationships exist when converting from one metric unit to another. The relationships differ when converting units of length, units of area, and units of volume.

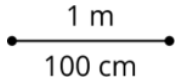
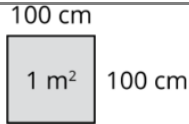
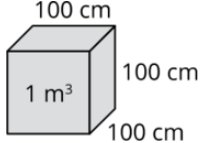
	In Metres	Visual Representation	In Centimetres
Length (one dimension)	1 metre		1 m = 100 cm
Area (two dimensions)	1 square metre = 1 m × 1 m		1 m ² = 100 cm × 100 cm = 10 000 cm ²
Volume (three dimensions)	1 cubic metre = 1 m × 1 m × 1 m		1 m ³ = 100 cm × 100 cm × 100 cm = 1 000 000 cm ³

Note

- The goal is not to memorize these relationships as formulas, but to have the tools to visually represent and understand the relationships, and to use them to calculate unit conversions.
- The relationships between square centimetres and square metres, and between cubic centimetres and cubic metres, are ratios.
 - Since 1 metre = 100 cm, then 5 metres = 500 cm.
 - Since 1 m² = 10 000 cm², then 5 m² = 50 000 cm².
 - Since 1 m³ = 1 000 000 cm³, then 5 m³ = 5 million cm³.
- Since 1 millilitre has a volume of 1 cubic centimetre (see **SE E2.1**), by extension, there are 1 million millilitres in 1 cubic metre.
- In real-life experiences, units of volume and units of capacity may be used interchangeably, and conversions among these units may be necessary.

E2.3 Circles

use the relationships between the radius, diameter, and circumference of a circle to explain the formula for finding the circumference and to solve related problems

Teacher supports

Key concepts

- For some shapes and some attributes, length measurements can be used to calculate other measurements. This is true for the circumference of a circle. Indirectly measuring

the circumference of a circle is quicker and more accurate than measuring it directly (e.g., with a string).

- The distance from any point on a circle to its centre is always the same. This distance is a circle's *radius* (r).
- The *diameter* (d) of a circle is the longest distance from one side of a circle to another. The diameter will always pass through the centre of the circle, and so will be the same as two radiuses (r) (also called radii). This relationship can be expressed symbolically as ($d = 2r$) or ($r = d \div 2$).
- The perimeter of a circle – its distance around – is called its *circumference* (C). The circumference of a circle is a little more than 3 times the length of the diameter, or a little more than 6 times the length of the radius. This ratio is constant and is described using the Greek symbol π (spelled *pi* and pronounced like *pie*). This relationship can be expressed symbolically as ($C = \pi d$) or, equivalently, as ($C = \pi 2r$).
- Pi (π) is equal to $\frac{C}{d}$, which is a very important relationship, used in many math and physics formulas. It is approximately equal to 3.14159, but it is an *irrational number*, which means that it can never be exactly calculated: the decimals never end, and it cannot be represented precisely as a fraction.

Note

- The number of decimals used to express π depends on the level of precision needed. Commonly, π is approximated as 3.14 (or in fraction form as $\frac{22}{7}$). However, sometimes “a little more than 3” is a sufficient estimate; at other times, such as when astrophysicists calculate the circumference of the observable universe, π must be calculated to 39 digits. Some scientific applications round π to hundreds of digits, and mathematicians, using supercomputers, have calculated π to trillions of digits.

E2.4 Circles

construct circles when given the radius, diameter, or circumference

Teacher supports

Key concepts

- Compasses are often used to construct circles by hand. Another strategy is to attach a pencil to the end of a string. The radius must be known when using a compass or string to construct a circle.

- The relationships between the radius, diameter, and circumference may be used to determine the radius of a circle when its diameter or circumference are known.
- Circles of given measurements can also be constructed using technology. Dynamic geometry applications show how changes to radius, diameter or circumference affects the others.

Note

- The diameter (d) is twice the radius (r), (i.e., $d = 2r$), and the radius is half the diameter ($r = \frac{1}{2}d$).
- The circumference is a little more than 3 times (and a very little over 3.14 times) the length of the diameter ($C = \pi d$).
- If one of the three measurements are known – the circumference, the ratio, or the diameter – the other two can be measured indirectly by calculating.

E2.5 Circles

show the relationships between the radius, diameter, and area of a circle, and use these relationships to explain the formula for measuring the area of a circle and to solve related problems

Teacher supports

Key concepts

- A relationship exists between the area of a circle (A) and its radius. This relationship can be expressed symbolically as ($A = \pi r^2$). The relationship between the radius and the diameter ($r = \frac{1}{2}d$) means that if either the radius or the diameter is known, the area can be measured indirectly, without the need to count square tiles. If the area is known, then the radius and the diameter can be determined using this relationship.

Note

- Visual proofs use the formulas for the area of a parallelogram or the area of a triangle to demonstrate the logic of the circle formula for area.

E2.6 Volume and Surface Area

represent cylinders as nets and determine their surface area by adding the areas of their parts

Teacher supports

Key concepts

- Area is additive: partial areas can be added together to find a whole area. Finding the surface area of a cylinder is an application of the property of additivity.
- Nets help to visualize the two-dimensional shapes that make up a three-dimensional object such as a cylinder. Cylinders, for their bases, have two parallel, congruent faces (see **SE E1.1** for a full list of the properties of cylinders) that are joined by a rectangle (to produce a “right” cylinder) or a non-rectangular parallelogram (to produce an “oblique” cylinder).
- In real-life contexts, cylinders can have two closed bases (e.g., closed tin cans), one closed and one open base (e.g., cylindrical pencil holders), or two open bases (e.g., pipes; paper towel rolls).

Note

- Visualizing the net for a cylinder – imagining it in the “mind’s eye” – involves identifying the shapes that form its faces and recognizing how the dimensions of the cylinder relate to the dimensions of the different faces.

E2.7 Volume and Surface Area

show that the volume of a prism or cylinder can be determined by multiplying the area of its base by its height, and apply this relationship to find the area of the base, volume, and height of prisms and cylinders when given two of the three measurements

Teacher supports

Key concepts

- Volume is measured in cubic units, and the measure represents the number of cubes needed to completely fill an object. Similar to units of area, a cubic unit is an amount of volume, and can come in any shape. Units of volume can be decomposed, rearranged, partitioned, and redistributed to better fill a volume and minimize gaps and overlaps (see **SE E2.1**).

- Indirectly measuring the volume of shapes is often quicker, and more accurate than measuring volume directly (i.e., by laying out and stacking cubes).
- All prisms and cylinders have two congruent bases that are parallel to each other (see **SE E1.1**). This means that, at any height in a prism or cylinder, a “slice” could be made, and – as long as the slice is parallel to the base – the cross-section that is created will have congruent faces. From top to bottom, the area of any slice, or layer, is consistent, and it is always equal to the area of the base. This geometric property of prisms and cylinders forms the basis for the formula for calculating their volume.
- Right prisms and right cylinders have bases that are perpendicular to their sides.
- The row-and-column structure of an array that helps to structure the count of square units for area (see **Grade 4, E 2.5**), also helps structure the count of cubic units and is used to indirectly measure volume.
 - A unit is repeated to produce the given length (a row).
 - A row is repeated to produce the given area of the base (a layer).
 - A layer is repeated to produce the given height (the volume).

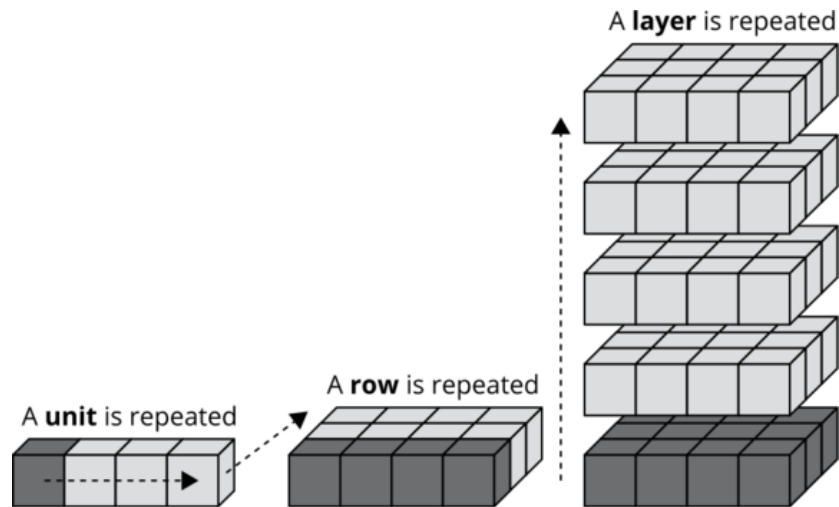

- The *area of the base* determines how many cubes can be placed on the base, which forms a single unit – a layer of cubes. The height of the prism determines how many layers of cubes it takes to fill the volume. Therefore, the formula for finding the volume of a rectangular prism is: (area of the base) \times (height).

Note

- The same is true for any prism or cylinder: the area of the base determines how many cubes can be placed on its base, and the height determines how many layers of cubes it takes to fill the volume. This means that the formula for finding the volume of *any* cylinder or prism is: (area of the base) \times (height).

F. Financial Literacy

Overall expectations

By the end of Grade 7, students will:

F1. Money and Finances

demonstrate the knowledge and skills needed to make informed financial decisions

Specific expectations

By the end of Grade 7, students will:

F1.1 Money Concepts

identify and compare exchange rates, and convert foreign currencies to Canadian dollars and vice versa

Teacher supports

Key concepts

- International currencies have different values compared to Canadian currency.
- Current exchange rates can be used to convert Canadian currency into other currencies. Exchange rates can fluctuate daily.

F1.2 Financial Management

identify and describe various reliable sources of information that can help with planning for and reaching a financial goal

Teacher supports

Key concepts

- Managing finances, including creating financial goals, often requires accessing information from various sources in order to make decisions. It is important to recognize which sources of information are reliable and which are not reliable.

- Gaining experience in assessing the reliability of information sources helps strengthen financial management skills.

F1.3 Financial Management

create, track, and adjust sample budgets designed to meet longer-term financial goals for various scenarios

Teacher supports

Key concepts

- Longer-term financial planning is a complex process with multiple steps requiring consolidation of prior knowledge and skills.
- Longer-term financial planning requires flexibility to respond to changing circumstances and the ability to make adjustments accordingly.
- Budgets include a recording of income and expenses over a period of time.

Note

- Simulated scenarios provide opportunities to learn financial literacy concepts in relevant and real-life contexts.
- Each person, family, or community may be facing a different financial situation, and some of these financial situations may be challenging or difficult. Fostering a safe, respectful, and inclusive environment in the classroom will ensure that all perspectives and opinions are valued and included when examining financial concepts.

F1.4 Financial Management

identify various societal and personal factors that may influence financial decision making, and describe the effects that each might have

Teacher supports

Key concepts

- Many factors, including personal, family, cultural, and societal factors, can impact financial decision making. Awareness of these factors results in more informed decisions.
- Long-term financial well-being requires careful consideration of a variety of factors.

Note

- Social-emotional learning skills and financial management concepts and skills are developed concurrently.
- Each person, family, or community may be facing a different financial situation, and some of these financial situations may be challenging or difficult. Fostering a safe, respectful, and inclusive environment in the classroom will ensure that all perspectives and opinions are valued and included when examining financial concepts.

F1.5 Consumer and Civic Awareness

explain how interest rates can impact savings, investments, and the cost of borrowing to pay for goods and services over time

Teacher supports

Key concepts

- Interest rates can have an impact over time on amounts that are either invested or borrowed.
- Investing small amounts of money over the long term can potentially yield significant gains.

F1.6 Consumer and Civic Awareness

compare interest rates and fees for different accounts and loans offered by various financial institutions, and determine the best option for different scenarios

Teacher supports

Key concepts

- Financial institutions offer a range of accounts and products, including loans.
- Comparing interest rates and fees associated with different accounts and products can support more informed decisions appropriate to an individual's circumstances.

Note

- Simulated scenarios provide opportunities for students to learn financial literacy concepts in relevant and real-life contexts.

Mathematics, Grade 8

Expectations by strand

A. Social-Emotional Learning (SEL) Skills in Mathematics and the Mathematical Processes

This strand focuses on students' development and application of social-emotional learning skills to support their learning of math concepts and skills, foster their overall well-being and ability to learn, and help them build resilience and thrive as math learners. As they develop SEL skills, students demonstrate a greater ability to understand and apply the mathematical processes, which are critical to supporting learning in mathematics. In all grades of the mathematics program, the learning related to this strand takes place in the context of learning related to all other strands, and it should be assessed and evaluated within these contexts.

Overall expectations

Throughout this grade, in order to promote a positive identity as a math learner, to foster well-being and the ability to learn, build resilience, and thrive, students will:

A1. Social-Emotional Learning (SEL) Skills and the Mathematical Processes

apply, to the best of their ability, a variety of social-emotional learning skills to support their use of the mathematical processes and their learning in connection with the expectations in the other five strands of the mathematics curriculum

To the best of their ability, students will learn to:	... as they apply the mathematical processes :	... so they can:
1. identify and manage emotions	<ul style="list-style-type: none"> • problem solving: develop, select, and apply problem-solving strategies • reasoning and proving: develop and apply reasoning skills (e.g., classification, recognition of relationships, use of counter-examples) to justify thinking, make and investigate conjectures, and construct and defend arguments 	1. express and manage their feelings, and show understanding of the feelings of others, as they engage positively in mathematics activities
2. recognize sources of stress and cope with challenges	<ul style="list-style-type: none"> • reflecting: demonstrate that as they solve problems, they are pausing, looking back, and monitoring their thinking to help clarify their understanding (e.g., by comparing and adjusting strategies used, by explaining why they think their results are reasonable, by recording their thinking in a math journal) 	2. work through challenging math problems, understanding that their resourcefulness in using various strategies to respond to stress is helping them build personal resilience
3. maintain positive motivation and perseverance	<ul style="list-style-type: none"> • connecting: make connections among mathematical concepts, procedures, and representations, and relate mathematical ideas to other contexts (e.g., other curriculum areas, daily life, sports) 	3. recognize that testing out different approaches to problems and learning from mistakes is an important part of the learning process, and is aided by a sense of optimism and hope
4. build relationships and communicate effectively	<ul style="list-style-type: none"> • communicating: express and understand mathematical thinking, and engage in mathematical arguments using everyday language, language resources as necessary, appropriate mathematical terminology, a variety of representations, and mathematical conventions 	4. work collaboratively on math problems – expressing their thinking, listening to the thinking of others, and practising inclusivity – and in that way fostering healthy relationships
5. develop self-awareness and sense of identity	<ul style="list-style-type: none"> • representing: select from and create a variety of representations of mathematical ideas (e.g., 	5. see themselves as capable math learners, and strengthen their sense of ownership of their learning, as part of their emerging sense of identity and belonging

6. think critically and creatively	representations involving physical models, pictures, numbers, variables, graphs), and apply them to solve problems <ul style="list-style-type: none"> • selecting tools and strategies: select and use a variety of concrete, visual, and electronic learning tools and appropriate strategies to investigate mathematical ideas and to solve problems 	6. make connections between math and everyday contexts to help them make informed judgements and decisions
------------------------------------	--	--

B. Number

Overall expectations

By the end of Grade 8, students will:

B1. Number Sense

demonstrate an understanding of numbers and make connections to the way numbers are used in everyday life

Specific expectations

By the end of Grade 8, students will:

B1.1 Rational and Irrational Numbers

represent and compare very large and very small numbers, including through the use of scientific notation, and describe various ways they are used in everyday life

Teacher supports

Key concepts

- The numerals 0 to 9 are used to form numbers. They are referred to as the digits in a number and each digit corresponds to a place value. A billion is “a thousand millions”, and a trillion is “a thousand billions” or “a million millions”. After the trillions period come quadrillions, quintillions, sextillions, septillions, octillions, and so on. Each period is 1000 times the preceding one.

- Reading numbers involves interpreting them as a quantity when they are expressed in words, in standard notation, in expanded notation, or in scientific notation. Large numbers may be expressed as a decimal number with the unit expressed in words. For example, 36.24 trillion is equivalent to 36 240 000 000 000 = 36.24×10^{12} .
- When a number is expressed in scientific notation, there is only one non-zero digit to the left of the decimal point. Thus, 36.24×10^{12} is not in scientific notation because there are two digits to the left of the decimal point. In scientific notation, 36 240 000 000 000 is written as 3.624×10^{13} .
- In words, 37 020 005 205 is written and said as “thirty-seven billion twenty million five thousand two hundred five”. Sometimes an approximation to a large number is used to describe a quantity. For example, the number 37 020 005 205 may be rounded to 37 billion or 37.02 billion, depending on the amount of precision needed.
- Understanding the magnitude of a large number may be done by comparing it to other numbers and quantities. For example:
 - One million seconds is around 11.5 days.
 - One billion seconds is around 32 years.
 - One trillion seconds is around 32 000 years.
- A number greater than 1 that is written in scientific notation can be written in standard notation by multiplying the decimal number by ten the number of times indicated by its exponent. For example, for 3.2×10^5 , 3.2 is multiplied by ten, five times. The result is 320 000.
- A number written in standard notation can be written in scientific notation. For a number greater than 1, a decimal point is positioned so that the first non-zero digit is to the left of the decimal point, and then the exponent for the base ten is determined by counting the number of times that decimal number needs to be multiplied by 10 to produce that number in standard notation. For example, $156\,000\,000\,000 = 1.56 \times 10^{11}$.
- Very small numbers refer to numbers between 0 and 1. The closer the number is to zero the smaller the number is. These numbers can also be written in scientific notation. A negative exponent is used to indicate that the decimal number needs to be divided by 10 that many times. For example, for 5.2×10^{-8} , 5.2 is divided by 10 eight times to become 0.000000052.
- To write a small number in scientific notation, the decimal point is positioned so that the first non-zero digit is to the left of the decimal point, and then the exponent is determined by counting the number of times that decimal number needs to be divided by 10 to produce that number in standard notation. For example, $0.0034 = 3.4 \times 10^{-3}$.
- Numbers expressed in scientific notation can be compared by considering the number of times the decimal number is multiplied or divided by ten. The more times it is multiplied by ten, the greater the number. The more times it is divided by ten, the smaller the number.

Note

- Every strand of mathematics relies on numbers.
- Some numbers have cultural significance.
- Real-life contexts can provide an understanding of the magnitude of large and small numbers.
- The number 1 in scientific notation is 1×10^0 .
- The exponent on the base ten, in scientific notation, indicates the number of times the decimal number is multiplied or divided by ten, not how many zeros need to be included for a number to be written in standard notation.
- When inputting numbers electronically, the “^” sign is used for exponents; for example, 10^6 would be entered as 10^6.

B1.2 Rational and Irrational Numbers

describe, compare, and order numbers in the real number system (rational and irrational numbers), separately and in combination, in various contexts

Teacher supports

Key concepts

- Real numbers are a set of numbers that contain all rational and irrational numbers.
- Rational numbers are those that can be expressed in the form $\frac{a}{b}$, where a and b are integers; for example, $-\frac{4}{3}$, 3.12, $\frac{1}{2}$, -7, 0, 205, 6.4, -32.5.
- Fractions (positive and negative) are rational numbers. Any fraction can be expressed as a decimal number that either terminates or repeats.
- Fractions can be written in a horizontal format (e.g., $1/2$ or $\frac{1}{2}$) as well as stacked format (e.g., $\frac{1}{2}$).
- Whole numbers are rational numbers since any whole number can be expressed as a fraction (e.g., $5 = \frac{5}{1}$).
- Integers (whole numbers and their opposites) are rational numbers since any integer can be expressed as a fraction (e.g., $-4 = \frac{-4}{1}$, $+8 = \frac{8}{1}$).
- Irrational numbers are numbers that cannot be expressed as a fraction. Examples of irrational numbers include decimal numbers that never repeat or terminate (e.g., 3.1212212221222...), pi (π), and square roots of non-perfect squares (e.g., $\sqrt{2}$).

- Rational and irrational numbers can be represented as points on a number line to show their relative distance from zero.
- The farther a number is to the right of zero on a horizontal number line, the greater the number.
- The farther a number is to the left of zero on a horizontal number line, the lesser the number.
- There are an infinite number of numbers in the real number system.

Note

- Since Grade 1, students have been working with whole numbers. The set of whole numbers (W) is a subset of integers (I), which are a subset of rational numbers (Q).
- Since Grade 1, students have been working with positive fractions, which are rational numbers. Negative fractions are introduced in Grades 7 and 8 as students represent, compare, and order negative fractions. Students will perform operations with negative fractions in secondary school because they are still developing the skills in Grade 8 to perform operations with integers.
- In Grade 7, students were introduced to pi, which is an irrational number. They may have worked with approximations of pi (3.14 or $\frac{22}{7}$), which are rational numbers. In Grade 8, students are introduced to other types of irrational numbers.
- In Grade 8, the focus is supporting students in making connections among the different number systems and the way they have been building knowledge through the years about the real number system.

Teacher supports

Key concepts

- Real numbers are a set of numbers that contain all rational and irrational numbers.
- Rational numbers are those that can be expressed in the form $\frac{a}{b}$, where a and b are integers; for example, $-\frac{4}{3}$, 3.12, $\frac{1}{2}$, -7, 0, 205, 6.4, -32.5.
- Fractions (positive and negative) are rational numbers. Any fraction can be expressed as a decimal number that either terminates or repeats.
- Fractions can be written in a horizontal format (e.g., $1/2$ or $\frac{1}{2}$) as well as stacked format (e.g., $\frac{1}{2}$).
- Whole numbers are rational numbers since any whole number can be expressed as a fraction (e.g., $5 = \frac{5}{1}$).

- Integers (whole numbers and their opposites) are rational numbers since any integer can be expressed as a fraction (e.g., $-4 = \frac{-4}{1}$, $+8 = \frac{8}{1}$).
- Irrational numbers are numbers that cannot be expressed as a fraction. Examples of irrational numbers include decimal numbers that never repeat or terminate (e.g., 3.12122122212222...), pi (π), and square roots of non-perfect squares (e.g., $\sqrt{2}$).
- Rational and irrational numbers can be represented as points on a number line to show their relative distance from zero.
- The farther a number is to the right of zero on a horizontal number line, the greater the number.
- The farther a number is to the left of zero on a horizontal number line, the lesser the number.
- There are an infinite number of numbers in the real number system.

Note

- Since Grade 1, students have been working with whole numbers. The set of whole numbers (W) is a subset of integers (I), which are a subset of rational numbers (Q).
- Since Grade 1, students have been working with positive fractions, which are rational numbers. Negative fractions are introduced in Grades 7 and 8 as students represent, compare, and order negative fractions. Students will perform operations with negative fractions in secondary school because they are still developing the skills in Grade 8 to perform operations with integers.
- In Grade 7, students were introduced to pi, which is an irrational number. They may have worked with approximations of pi (3.14 or $\frac{22}{7}$), which are rational numbers. In Grade 8, students are introduced to other types of irrational numbers.
- In Grade 8, the focus is supporting students in making connections among the different number systems and the way they have been building knowledge through the years about the real number system.

B1.3 Rational and Irrational Numbers

estimate and calculate square roots, in various contexts

Teacher supports

Key concepts

- The inverse of squaring a number is to take its square root.

- Each positive number has two possible square roots. For example, the square roots of 9 are +3 and -3 because $(+3)(+3) = 9$ and $(-3)(-3) = 9$.
- The symbol $\sqrt{\quad}$ means the positive square root. The symbol $\pm\sqrt{\quad}$ means both the positive and the negative square root.
- Depending on the context, only the positive square root may be appropriate. For example, given the area of a square, the length of its side is determined by taking the square root of the area. Since the side is a dimension, it makes sense to determine only the positive square root.
- Square roots of non-perfect squares are irrational and are left in radical form (e.g., $\sqrt{3}$) or approximated to a decimal number.
- Estimating the square roots of non-perfect squares involves identifying the two perfect squares that are closest to it. For example, $\sqrt{60}$ is between $\sqrt{49}$ and $\sqrt{64}$, so the first step is to determine the square root of those perfect squares, that is, $\sqrt{49} = 7$ and $\sqrt{64} = 8$. The next step is to estimate a value that is close to the closest square root. Since 60 is closer to 64 than to 49, then $\sqrt{60}$ can be estimated as 7.8.

Note

- Solving for a length using the Pythagorean theorem involves applying squares and square roots of numbers.
- A spatial interpretation of a square number is to think of the area of a square with side length the square root of the area (*side* \times *side* or s^2).
- If the area of a square is 9, its side length is $\sqrt{9}$ or 3.
 - 9 is a perfect square.
- If the area of a square is 5, its side length is $\sqrt{5}$.
 - 5 is an imperfect square and its square root is an irrational number, with a decimal that never repeats or terminates.

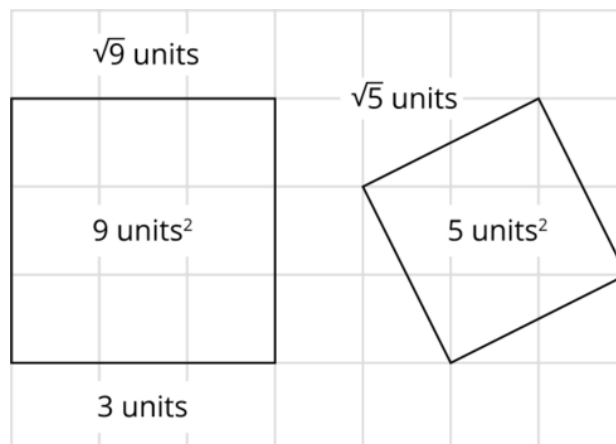

- Perfect squares can be calculated. Imperfect squares can only be estimated. Calculators give approximations of all square roots of non-perfect square numbers.

B1.4 Fractions, Decimals, and Percents

use fractions, decimal numbers, and percents, including percents of more than 100% or less than 1%, interchangeably and flexibly to solve a variety of problems

Teacher supports

Key concepts

- Converting between fractions, decimals, and percents often makes calculations and comparisons easier to understand and carry out.
- Fractions, decimals, and percents all describe relationships to a whole. While fractions may use any number as a denominator, decimal units are in powers of ten (tenths, hundredths, and so on) and percents express a rate out of 100 (“per cent” means “per hundred”).
- Relationships of quantities relative to a whole can be expressed as a fraction, a decimal number, and a percent. The choice of using a fraction, decimal number, or a percent can vary depending on the context of a problem.
- When fractions are considered as a quotient, the numerator is divided by a denominator and the result is a decimal representation that can be converted to a percent.
- To convert a percent to a fraction, it can first be represented out of 100 and then an equivalent proper fraction or mixed number can be made. For example, $104.6\% = \frac{104.6}{100} = \frac{1046}{1000} = 1\frac{46}{1000} = 1\frac{23}{500}$.
- Some decimal numbers when converted to a percent result in whole number percents, and others result in decimal percents (e.g., $0.15 = 15\%$, $0.642 = 64.2\%$, $3.425 = 342.5\%$).
- Percents can be whole number percents (e.g., 32%, 168%) or decimal percents (0.5%, 43.6%, 108.75%). Percents can be understood as decimal hundredths.
- Percents can be composed from other percents. A 15% discount combines a 10% discount and a 5% discount. A 13% tax adds 10% and another 3% ($3 \times 1\%$).
- To convert a percent to a decimal number, the percent is divided by 100 (e.g., $35.4\% = 0.354$, $0.1\% = 0.001$).
- There are three types of problems that involve percents – determining the percent a quantity represents relative to a whole; finding the percent of a number; and finding a number given the percent.
- Common benchmark fractions, decimals, and percents include:

- $150\% = 1\frac{1}{2} = 1.50$
 - $100\% = 1 = 1.00$
 - $75\% = \frac{3}{4} = 0.75$
 - $50\% = \frac{1}{2} = 0.50$
 - $25\% = \frac{1}{4} = 0.25$
 - $20\% = \frac{1}{5} = 0.20$
 - $10\% = \frac{1}{10} = 0.10$
 - $5\% = \frac{1}{20} = 0.05$
 - $1\% = \frac{1}{100} = 0.01$
 - $0.1\% = \frac{1}{1000} = 0.001$
- Unit fraction conversions can be scaled to determine non-unit conversions. For example:
 - $\frac{1}{4} = 0.25 = 25\%$, so $\frac{1}{8} = 0.125 = 12.5\%$ (half of one fourth).
 - $\frac{1}{8} = 0.125 = 12.5\%$, so $\frac{3}{8} = 0.375 = 37.5\%$ (three times one eighth).

Note

- Sometimes when working with percents, students may work with complex fractions in which a decimal number is the numerator. An equivalent proper fraction or mixed number can be made by multiplying both the numerator and denominator by the appropriate number of tens.
- More than one strategy can be used to solve problems involving percents. For example, a coat is on sale for 25% off. The cost of the coat can be determined by finding 25% of the original price and then subtracting that discount value from the original price. Another strategy could be to determine 75% of the original price.

B2. Operations

use knowledge of numbers and operations to solve mathematical problems encountered in everyday life

Specific expectations

By the end of Grade 8, students will:

B2.1 Properties and Relationships

use the properties and order of operations, and the relationships between operations, to solve problems involving rational numbers, ratios, rates, and percents, including those requiring multiple steps or multiple operations

Teacher supports

Key concepts

- Properties of operations are helpful for carrying out calculations.
 - The identity property: $a + 0 = a$, $a - 0 = a$, $a \times 1 = a$, $\frac{a}{1} = a$.
 - The commutative property: $a + b = b + a$, $a \times b = b \times a$.
 - The associative property: $(a + b) + c = a + (b + c)$, $(a \times b) \times c = a \times (b \times c)$.
 - The distributive property: $a \times b = (c + d) \times b = c \times b + d \times b$.
- The commutative, associative, and identity properties can be applied for any type of number.
- When an expression includes multiple operations, there is a convention that determines the order in which those operations are performed:
 - Do calculations in the brackets first.
 - Then evaluate the exponents and roots (exponentiation).
 - Then multiply and divide in the order that these operations appear from left to right (multiplication/division).
 - Then add and subtract in the order that these operations appear from left to right (addition/subtraction).
- Multi-step problems may involve working with a combination of whole numbers, decimal numbers, and positive fractions.
- Multi-step problems may involve working with a combination of relationships, including ratios, rates, and percents.
- There may be more than one way to solve a multi-step problem.

Note

- This expectation supports most other expectations in the Number strand and is applied throughout the grade. Whether working with numbers or operations, recognizing and applying properties and relationships builds a strong foundation for doing mathematics.
- Problems that involve rational numbers in this grade include whole numbers, integers, positive decimal numbers, and positive fractions.
- Solving problems with more than one operation involves similar processes to solving problems with a single operation. For both types of problems:
 - Identify the actions and quantities in a problem and what is known and unknown.
 - Represent the actions and quantities with a diagram (physically or mentally).
 - Choose the operation(s) that match the actions to write the equation.
 - Solve by using the diagram (counting) or the equation (calculating).
- In multi-operation problems, sometimes known as two-step problems, there is often an *ultimate* question (asking for the final answer or result being sought), and a *hidden* question (a step or calculation that must be taken to get to the final result). Identifying both questions is an important part of solving these types of problems.
- The actions in a situation inform the choice of operation. The same operation can describe different situations.
 - Does the situation involve changing (joining, separating), combining or comparing? Then it can be represented with addition or subtraction.
 - Does the situation involve equal groups (or rates), ratio comparisons (scaling), or arrays? Then it can be represented with multiplication or division.
 - Representing a situation with an equation is often helpful in solving it.
- The same situation can be represented with different operations. Each operation has an “inverse” operation – an opposite that “undoes” the other. The inverse operation can be used to rewrite an equation to make it easier to calculate, or to check whether a calculation is true.
 - The inverse of addition is subtraction, and the inverse of subtraction is addition. So, for example, $\frac{1}{2} + ? = \frac{3}{4}$ can be rewritten as $\frac{3}{4} - \frac{1}{2} = ?$.
 - The inverse of multiplication is division, and the inverse of division is multiplication. So, for example, $\frac{1}{2} \times ? = \frac{3}{8}$ can be rewritten as $\frac{3}{8} \div \frac{1}{2} = ?$.

B2.2 Math Facts

understand and recall commonly used square numbers and their square roots

Teacher supports

Key concepts

- A perfect square can be represented as a square with its area the value of the perfect square and a side length that is the positive square root of that perfect square number. In general, the area (A) of a square is *side* (s) \times *side* (s), $A = s^2$.
- Any integer multiplied by itself produces a square number, or a perfect square, and can be represented as a power with an exponent of 2. For example, 9 is a square number because $3 \times 3 = 9$ or $3^2 = 9$.
- A square number can be composed of a product of a perfect square and an even number of tens. For example, the square roots for 9, 900, 90 000, 9 000 000 are 3, 30, 300, 3000.

Note

- Negative integers expressed in exponential notation need to have a bracket around them to indicate it is the base of the power. Without the bracket it would not have the same result. For example, $-3^2 = -(3 \times 3) = -9$ versus $(-3)^2 = (-3 \times -3) = 9$.

B2.3 Mental Math

use mental math strategies to multiply and divide whole numbers and decimal numbers up to thousandths by powers of ten, and explain the strategies used

Teacher supports

Key concepts

- Multiplying a number by 0.1 is the same as dividing a number by 10. Therefore, it can be visualized by shifting the digit(s) to the right by one place. For example, $50 \times 0.1 = 5$, $500 \times 0.1 = 50$ and $5 \times 0.1 = 0.5$.
- Multiplying a number by 0.01 is the same as dividing a number by 100. Therefore, it can be visualized by shifting the digit(s) to the right by two places. For example, $500 \times 0.01 = 5$, $50 \times 0.01 = 0.5$, and $5 \times 0.01 = 0.05$.
- Mentally multiplying and dividing whole numbers and decimals by powers of ten builds on the constant 10:1 ratio that exists between place-value columns. For example, 1000 is

ten times greater than 100, or 100 is one tenth of 1000. Similarly, one hundredth (0.01) is ten times greater than one thousandth (0.001), or 0.001 is one tenth of 0.01.

- Multiplying a whole number and a decimal number by a positive power of ten can be visualized as shifting the digits to the left by one for each multiplication by 10.
 - For example, since 54.3×10^4 means $5.43 \times 10 \times 10 \times 10 \times 10$, the digits “543” shift to the left four places to become 543 000. This is true for whole numbers and decimals.
- Dividing a whole number and a decimal number by a power of 10 can be visualized as shifting the digits to the right by one for each division by 10.
 - For example, for $5.43 \div 10 \div 10 \div 10$, the digits “543” shift to the right three spaces to become 0.00543.
 - Dividing by 10 is the same as multiplying by 0.1, thus $5.43 \div 10 \div 10 \div 10$ is equal to $5.43 \times 0.1 \times 0.1 \times 0.1 = 0.00543$.

Note

- Making connections between division by 10 and multiplication by 0.1 can support students in converting a number in scientific notation of the form 5.43×10^{-3} to a number in standard form.
- Mental math refers to doing calculations in one’s head. Sometimes the numbers or the number of steps in a calculation are too complex to completely hold in one’s head, so jotting down partial calculations and diagrams can be used to complete the calculations.
- Estimation is a useful mental strategy when either an exact answer is not needed or there is insufficient time to work out a calculation.

B2.4 Addition and Subtraction

add and subtract integers, using appropriate strategies, in various contexts

Teacher supports

Key concepts

- When given a context, considerations can support the selection of an appropriate model and operation to solve the problem. For example:
 - Are the integers representing a quantity or change?
 - Is the situation involving the addition of integers with like signs or different signs?

- Is the situation involving the comparison of two integers?
 - When modelling the situation, do zero pairs need to be used to carry out the operation?
 - What will the result of the calculation mean in relation to the problem being solved?
- When adding and subtracting integers, it is important to pay close attention to all of the elements of the statement. For example:
 - $(+4) + (-3)$ may be interpreted as combining positive four and negative three.
 - $4 + (-3)$ may be interpreted as adding negative three to positive four.
 - $(-4) - (+3)$ may be interpreted as determining the difference between negative four and positive three by comparing them.
 - $(-4) - 3$ may be interpreted as taking away positive three from negative four.
 - $4 - 3$ may be interpreted as taking away positive three from positive four.
 - $-4 - 3$ may be interpreted as taking away positive three from negative four.
 - The order that integers are written in an addition statement does not matter because the commutative property holds true (e.g., $-5 + 3 = 3 + (-5)$). It is important to note that the sign directly in front of the number belongs to the number.
 - The order in which integers are written in a subtraction statement does matter because the commutative property does not hold true. For example, $(-5) - (+3) = -8$ and $(+3) - (-5) = +8$; the two expressions do not produce the same result.
 - Addition and subtraction are inverse operations; therefore, a subtraction expression can be rewritten as an addition expression by adding its opposite (e.g., $(-5) - (+3)$ becomes $(-5) + (-3)$; $2 - (-4) = 2 + (+4)$).
 - When two positive integers are added together, the result is positive. This can be visualized on a number line as:
 - two vectors moving in a positive direction (right or up);
 - a vector moving in a positive direction from a positive starting position.
 - When two negative integers are added together, the result is negative. This can be visualized on a number line as:
 - two vectors moving in a negative direction (left or down);
 - a vector moving in a negative direction from a negative starting position.
 - When a positive and a negative integer are added together, the result is negative if the absolute value of the negative integer is greater than the absolute value of the positive integer. This can be visualized on a number line as:

- one vector moving in a positive direction and the other vector with a greater magnitude moving in a negative direction, the sign of the resultant vector is negative;
 - a vector moving in a negative direction from a positive starting position and the head of the vector is to the left (or below) zero;
 - a vector moving in a positive direction from a negative starting position and the head of the vector is to the left (or below) zero.
- When a positive and a negative integer are added together, the result is positive if the absolute value of the positive integer is greater than the absolute value of the negative integer. This can be visualized on a number line as:
 - one vector moving in a negative direction and the other vector with a greater magnitude moving in a positive direction, the sign of the resultant vector is positive;
 - a vector moving in a positive direction from a negative starting position and the head of the vector is to the right (or above) zero;
 - a vector moving in a negative direction from a positive starting position and the head of the vector is to the right (or above) zero.

Note

- If two integers added together have the same sign, then their magnitudes are added together.
- If two integers added together have different signs, then their magnitude is determined by taking the absolute difference between them.
- Depending on the models and the integers that are involved in a subtraction, zero pairs may need to be introduced in order to act out the situation. For example, if the situation involves taking away a negative amount but only positive amounts are shown, then adding zero pairs will allow for the negative amount to be removed.
- If the situation involves comparing two integers, the two integers can be represented as positions on a number line to determine the distance between the two points (magnitude).
- The order the subtraction statement is written is important in determining the sign. The direction of the sign is based on the movement from the point represented by the integer behind the minus sign (subtrahend) to the point represented by the integer in front of the minus sign (minuend). For example:
 - For $10 - (+2) = +8$, the distance between positive 10 and positive 2 is 8; the movement from positive 2 to 10 is in a positive direction.
 - For $(+2) - (+10) = -8$, the distance between positive 2 and positive 10 is 8; the movement from positive 10 to positive 2 is in a negative direction.

- For $(2) - (-10) = +12$, the distance between positive 2 and negative 10 is 12; the movement from negative 10 to positive 2 is in a positive direction.
- Situations involving addition and subtraction can be modelled using tools such as a number line and integer tiles.
- Change can be represented by a positive or negative integer (e.g., rise of 4 expressed as +4, drop of 4 expressed as -4).
- A quantity relative to zero can be represented by a positive or negative integer (e.g., temperature is 3 degrees, temperature is -5 degrees).
- The integers in a situation may be interpreted as changes or as quantities. For example, if the temperature outside drops 5 degrees and then 3 degrees, this may be expressed as the addition of two drops $[(-5) + (-3)]$ or as a subtraction of 3 degrees $(-5 - 3)$. Both statements result in the same answer (-8), meaning the temperature decreased by 8 degrees.
- Familiar real-world contexts for negative and positive integers (temperature, elevators going up and down, parking garages, sea level, golf scores, plus/minus in hockey, gaining and losing money, walking forward and backwards, debts and surplus) provide an authentic opportunity to understand how integers are used in real life to describe a quantity or change.

B2.5 Addition and Subtraction

add and subtract fractions, using appropriate strategies, in various contexts

Teacher supports

Key concepts

- When adding and subtracting proper and improper fractions with the same denominator, the numerators are added, and the denominator remains the same. When the denominators are the same (e.g., three fourths and nine fourths) they have the same units and so can be added (twelve fourths).
- Strategies to add and subtract fractions with unlike denominators depends on the types of fractions that are given. For example:
 - Mental math can be used to create wholes (ones). For example, for $\frac{1}{2} + \frac{3}{4} = 1\frac{1}{4}$, knowing that three fourths is composed of one half and one fourth, the two halves are combined to make one, and then one fourth is added on.

- Equivalent fractions are created so that both fractions have a common denominator (e.g., $\frac{2}{3} + \frac{1}{2}$ can be scaled so that both have a denominator of 6, which results in the equivalent expression $\frac{4}{6} + \frac{3}{6}$).
- One strategy to add and subtract mixed fractions is to decompose the mixed fraction into its whole and fractional parts. The wholes are added or subtracted, and the fractional parts are added or subtracted. If the result of the fractional part is greater than one, it is rewritten as a mixed number and the whole combined with the other wholes. Another strategy to add and subtract mixed fractions is to first rewrite them as improper fractions.

Note

- Fractions are commonly added and subtracted in everyday life, particularly when using imperial units (inches, feet, pounds, cups, teaspoons). Imperial units are commonly used in construction and cooking.
- Only common units can be added or subtracted, whether adding or subtracting whole numbers, decimals, or fractions. Adding fractions with like denominators is the same as adding anything with like units:
 - 3 apples and 2 apples are 5 apples.
 - 3 fourths and 2 fourths are 5 fourths.
- The numerator in a fraction represents the count of unit fractions. The denominator represents what is being counted (the unit). To add or subtract fractions is to change the total count of units. This is why only the numerator is added or subtracted. There are helpful ways to visualize the addition and subtraction of fractions. Drawings, fraction strips, clock models, and rulers in imperial units can be used to generate equivalent fractions and model how these common units can be combined or separated.
- The three types of addition and subtraction situations (see **SE B2.1**) also apply to fractions.

B2.6 Multiplication and Division

multiply and divide fractions by fractions, as well as by whole numbers and mixed numbers, in various contexts

Teacher supports

Key concepts

- The multiplication and division of two fractions can be interpreted based on the different ways fractions are used: as a quotient, as parts of a whole, as a comparison (ratio), and as an operator.
- Multiplication as scaling is one way to multiply a fraction by a whole number. For example, $2 \times \frac{2}{3}$ can be interpreted as doubling two one thirds, which is four one thirds or $\frac{4}{3}$.
- The multiplication of two proper fractions as operators can be modelled as follows:
 - For $\frac{1}{2} \times \frac{2}{3}$, the fraction two thirds can be shown as two thirds of a rectangle:



- $\frac{1}{2}$ as an operator can be shown by taking one half of the two thirds:



- In general, the result of a fraction multiplied by a fraction can be obtained by multiplying the numerators and multiplying the denominators. In this example the product of the denominators are the partitions that were created in the rectangle, and the numerator is the resulting count of these partitions.
- Multiplying a mixed fraction by a mixed fraction can be modelled as the product of the area of a rectangle with its dimensions decomposed into wholes and fractions. For example, the rectangle to model $2\frac{1}{3} \times 3\frac{2}{5}$ has a width of two and one third and a length of three and two fifths. The areas of the four smaller rectangles formed by the

decomposition are $2 \times 3 = 6$, $2 \times \frac{2}{5} = \frac{4}{5}$, $\frac{1}{3} \times 3 = 1$, and $\frac{1}{3} \times \frac{2}{5} = \frac{2}{15}$. The sum of all the areas is $6 \frac{4}{5} + 1 \frac{2}{15} = 7 + \frac{12}{15} + \frac{2}{15} = 7 \frac{14}{15}$.

	3	$\frac{2}{5}$
2	6	$\frac{4}{5}$
$\frac{1}{3}$	$\frac{3}{3} = 1$	$\frac{2}{15}$

$$\begin{aligned}
 & 6 + 1 + \frac{4}{5} + \frac{2}{15} \\
 & = 7 + \frac{12}{15} + \frac{2}{15} \\
 & = 7 \frac{14}{15}
 \end{aligned}$$

- Division of fractions can be interpreted in two ways:

- $4 \div \frac{1}{2} = ?$ can be interpreted as “How many one halves are in four?”



- Two one halves make 1, so eight one halves make 4. Therefore, $4 \div \frac{1}{2} = 8$.

- $4 \div \frac{1}{2} = ?$ can also be interpreted as “If 4 is one half of a number, what is the number?”

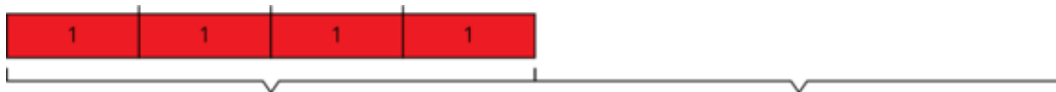

- Since 4 is one half of a number, the other one half is also 4. Therefore, $4 \div \frac{1}{2} = 8$.

- Division of a fraction by its unit fraction (e.g., $\frac{5}{8} \div \frac{1}{8}$) can be interpreted as how many counts of the unit are in the fraction (i.e., how many one eighths are in five eighths)? The result is the number of counts (e.g., there are 5 counts of one eighth).
- Dividing a fraction by a fraction with the same denominator (e.g., $\frac{6}{8} \div \frac{2}{8}$) can be interpreted as “How many divisors are in the dividend?” In the fraction strips below, notice there are three counts of two eighths that are in six eighths. Similar to the division of a fraction by its unit fraction, the result is the count.

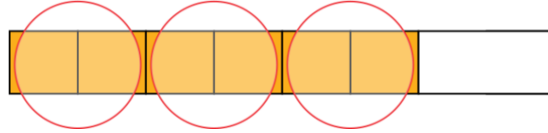

- Sometimes the division of a fraction by a fraction with the same denominator has a fractional result. For example, $\frac{5}{8} \div \frac{2}{8}$.

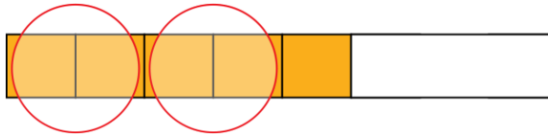

- Notice there are 2 two eighths in five eighths, and then $\frac{1}{2}$ of another two eighths.
- Therefore, $\frac{5}{8} \div \frac{2}{8} = 2\frac{1}{2}$.
- In general, when dividing a fraction by a fraction with the same denominator, the result can be obtained by dividing the numerators and dividing the denominators.
- To multiply fractions by fractions that have unlike denominators, a strategy is to create equivalent fractions so that the two fractions have a common denominator and then divide numerators and divide denominators. For example:

$$\begin{aligned} \frac{3}{4} \div \frac{5}{6} \\ &= \frac{9}{12} \div \frac{10}{12} \\ &= \frac{9 \div 10}{12 \div 12} \\ &= \frac{\frac{9}{10}}{1} = \frac{9}{10} \end{aligned}$$

- A fraction divided by a whole number can use the same strategy. For example:

$$\begin{aligned} \frac{3}{4} \div 5 \\ &= \frac{3}{4} \div \frac{20}{4} \\ &= \frac{3}{20} \end{aligned}$$

- When division involves mixed numbers, a strategy is to convert them to improper fractions and then multiply accordingly.

Note

- When multiplying a fraction by a fraction using the area of a rectangle, first the rectangle is partitioned horizontally or vertically into the same number of sections as one of the denominators. Next, the region represented by that fraction is shaded to show that fraction of a rectangle. Next, the shaded section of the rectangle is partitioned in the other direction into the same number of sections as the denominator of the second fraction. Now it is possible to identify the portion of the shaded area that is represented by that fraction.
- Any whole number can be written as a fraction with one as its denominator. A whole number divided by a fraction can be used to support students in understanding the two ways division can be interpreted. If context is given, usually only one or the other way is needed. Dividing a whole number by a fraction also supports making connections with division of a fraction as the multiplication of its reciprocal.
- In general, dividing fractions with the same denominator can be determined by dividing the numerators and dividing the denominators.
- Since division is the inverse operation of multiplication, the division statement can be rewritten in terms of multiplication. For example, if $\frac{5}{4} \div \frac{2}{3} = n$, then $\frac{2}{3} \times n = \frac{5}{4}$
 - To solve for n , each side of the equal sign is multiplied by $\frac{3}{2}$:
 - $\frac{3}{2} \times \frac{2}{3} \times n = \frac{5}{4} \times \frac{3}{2}$
 - therefore $n = \frac{5}{4} \times \frac{3}{2}$
 - Now the numerators can be multiplied, and the denominators can be multiplied.
 - $n = \frac{15}{8}$
 - The fraction $\frac{3}{2}$ is the reciprocal of $\frac{2}{3}$ because the product of these two fractions is 1.
 - Therefore, another strategy to divide two fractions is to multiply the dividend by the reciprocal of the divisor.
- Multiplying fractions follows a developmental progression that may be helpful in structuring tasks for this grade:
 - A proper or improper fraction by a whole number.
 - A whole number by a proper or improper fraction.
 - A unit fraction by a unit fraction.
 - A unit fraction by a proper or improper fraction.
 - A proper or improper fraction by a proper or improper fraction.
 - A mixed fraction by a proper or improper fraction.
 - A mixed fraction by a mixed fraction.

- Dividing fractions follows a developmental progression that may be helpful in structuring tasks for this grade:
 - A whole number divided by a whole number.
 - A proper or improper fraction divided by a whole number.
 - A whole number divided by a unit fraction.
 - A whole number divided by a proper or improper fraction.
 - A proper or improper fraction divided by a unit fraction.
 - A proper or improper fraction divided by a proper or improper fraction with the same denominators and a result that is a whole number.
 - A proper or improper fraction divided by a proper or improper fraction with the same denominators and a result that is a fractional amount (e.g., $\frac{7}{5} \div \frac{2}{5}$).
 - A proper or improper fraction divided by a proper or improper fraction with unlike denominators.
 - A proper or improper fraction divided by a whole number or mixed fraction.
 - A mixed fraction divided by a whole number.
 - A mixed fraction divided by a mixed fraction.

B2.7 Multiplication and Division

multiply and divide integers, using appropriate strategies, in various contexts

Teacher supports

Key concepts

- Multiplication and division facts for whole numbers can be used for multiplying and dividing integers. The difference is consideration of the sign, which is determined by the numbers being worked with.
- A positive integer multiplied or divided by a positive integer has a result that is positive.
- A positive integer multiplied by a negative integer has a result that is negative. Since multiplication can be understood as repeated equal groups, then the positive integer can represent the number of groups and the negative integer can represent the quantity in each group. For example, $3 \times (-4)$ can be modelled as $(-4) + (-4) + (-4) = -12$.
- The commutative property holds true for the multiplication of integers, so $(+3) \times (-4) = (-4) \times (+3)$. Therefore $(-4) \times (+3) = -12$ or (-12) .
- Since division is the inverse operation, the rules for the signs with multiplication are the same for division:

- A positive number divided by a positive number has a result that is positive.
- A positive number divided by a negative number has a result that is negative.
- A negative number divided by a positive number has a result that is negative.
- A negative number divided by a negative number has a result that is positive.

Note

- When two brackets are side by side, it is understood to be multiplication. For example: $(-3)(-4)$.
- Division of two numbers can be indicated using the division symbol or using the division bar. For example, $12 \div (-3) = \frac{12}{-3}$.
- Multiplication can be understood as repeated equal groups, where the first factor is the number of groups and the second factor is the size of the groups. When the first integer is positive, regardless of the sign of the second integer, this is helpful for visualizing the situation since it links multiplication with the repeated addition of a group.
 - A 3° rise in temperature 4 days in a row can be represented as $(+4) \times (+3) = (+12)$.
 - A 3° drop in temperature 4 days in a row can be represented as $(+4) \times (-3) = (-12)$.
- It is difficult, although not impossible, to conceive of a negative number of groups. To overcome this, properties and reasoning can help:
 - The commutative property says that $(-4) \times (+3)$ is the same as $(+3) \times (-4)$, so both must equal (-12) .
 - Patterning can be used to determine that $(-3) \times (-4)$ must be $(+12)$.
- Understanding division of integers requires a strong understanding of the operation and its relationship to multiplication. Grouping division asks, “How many groups of ___ are in ___?” Sharing division asks, “How many does each receive if ___ are shared among ___?” Both are helpful for understanding division with integers and their relationship to multiplication, repeated addition, and repeated subtraction:
 - $(+20) \div (+5)$ draws on work in earlier grades for an answer of $(+4)$.
 - $(-20) \div (-5)$ can mean how many groups of (-5) are in (-20) . Since there are 4 groups of (-5) in (-20) , $(-20) \div (-5) = (+4)$.
 - $(-20) \div (+5)$ can mean that (-20) can be shared between 5 groups. Since each group would receive (-4) , $(-20) \div (+5) = (-4)$.
 - $(+20) \div (-5)$ can draw on patterns and the inverse relationship between multiplication and division to rewrite this statement as $(-5) \times \underline{\quad} = (-20)$ to see that $(+20) \div (-5) = (-4)$.

- There are conventions for expressing multiplication and division in ways that make algebraic expressions clearer:
 - Multiplication may be shown with the multiplication sign: $(-3) \times (-4)$.
 - Multiplication may be shown with no multiplication sign: $(-3)(-4)$.
 - Multiplication may be shown with the dot operator: $(-3) \cdot (-4)$.
 - Division may be shown with the division sign (\div).
 - Division may be shown with the fraction bar ($\frac{\quad}{\quad}$).

B2.8 Multiplication and Division

compare proportional situations and determine unknown values in proportional situations, and apply proportional reasoning to solve problems in various contexts

Teacher supports

Key concepts

- If two quantities change at the same rate, the quantities are proportional. Proportional growth, when plotted on a graph, forms a straight line (i.e., linear growth) because each point changes at a constant rate.
- Proportions involve multiplicative comparisons (ratios) and are written in the form $a : b = c : d$ or expressed using fractional notation as $\frac{a}{b} = \frac{c}{d}$. When ratios are represented using fractional notation, they are usually read as 3 out of 4, or 3 to 4, rather than as a fraction, three fourths. Writing ratios using fractional notation is helpful for making comparisons and calculating proportions.
- There are four ways a proportion can be written for it to hold true. For example, 3.7 km for every 5 hours and 7.4 km for every 10 hours can be expressed as:

○ $\frac{3.7}{5} = \frac{7.4}{10}$ or

○ $\frac{3.7}{7.4} = \frac{5}{10}$ or

○ $\frac{5}{3.7} = \frac{10}{7.4}$ or

○ $\frac{7.4}{3.7} = \frac{10}{5}$.

- Problems involving proportional relationships can be solved in a variety of ways, including using a table of values, a graph, a ratio table, a proportion, and scale factors.

Note

- One strategy when using a proportion to solve for an unknown value is to position that unknown in the upper part of the equation (e.g., $\frac{m}{9} = \frac{3.4}{6.8}$).
- In solving for proportional situations, comparisons can be made *within* a situation (i.e., the unit rate is constant) and *between* situations (i.e., the scaling factor is constant). So, 6 items costing \$9 is proportional to 12 items costing \$18:

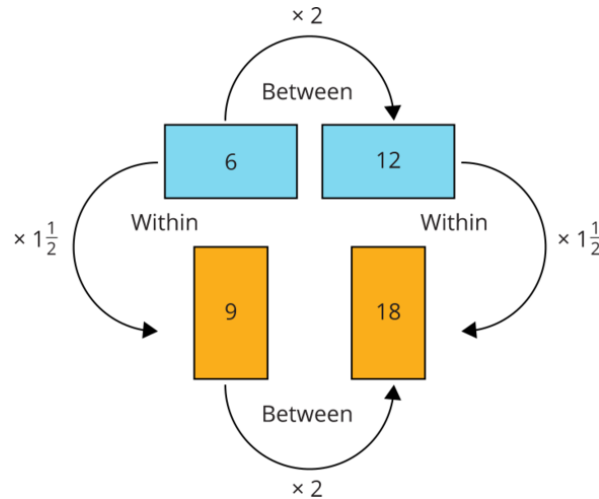

- Scaling a ratio creates other proportional situations. For example, the relationship of 2 blue marbles to 3 red marbles (2 : 3) is in proportion to 6 blue marbles and 9 red marbles (6 : 9). The fractions $\frac{2}{3}$ and $\frac{6}{9}$ are equivalent, so the situations are proportional.

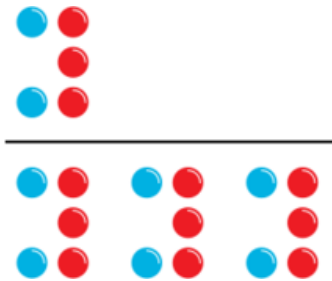

- Ratio tables, double number lines, and between-within diagrams are helpful tools to identify and compare proportional relationships, and to solve for unknown values.
- Tables and graphs are helpful for seeing proportional (or non-proportional) relationships. Any of the points marked on the graph is proportional to each of the other points.

Month	Deposit	Total Saved	Rate of Change	Rate per Month
1	\$5	\$5	+5	\$5/month
2	\$5	\$10	+5	\$5/month
3	\$5	\$15	+5	\$5/month
4	\$5	\$20	+5	\$5/month

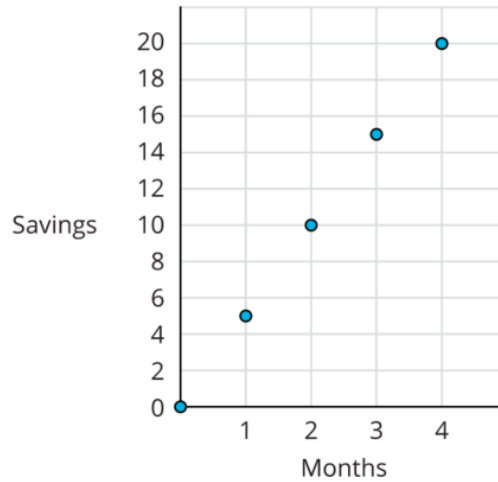

C. Algebra

Overall expectations

By the end of Grade 8, students will:

C1. Patterns and Relationships

identify, describe, extend, create, and make predictions about a variety of patterns, including those found in real-life contexts

Specific expectations

By the end of Grade 8, students will:

C1.1 Patterns

identify and compare a variety of repeating, growing, and shrinking patterns, including patterns found in real-life contexts, and compare linear growing and shrinking patterns on the basis of their constant rates and initial values

Teacher supports

Key concepts

- Repeating patterns have a pattern core that is repeated over and over.
- In growing patterns, there is an increase in the number of elements or size from one term to the next.
- In shrinking patterns, there is a decrease in the number of elements or size from one term to the next.
- If the ratio of the change in one variable to the change in another variable is equivalent between any two sets of data points, then there is a constant rate. An example of a real-life application of a constant rate is an hourly wage of \$15.00 per hour.
- The initial value (constant) of a linear pattern is the value of the term when the term number is zero. An example of a real-life application of an initial value is a membership fee.
- The relationship between the term number and the term value can be generalized. A linear pattern of the form $y = mx + b$ has a constant rate, m , and an initial value, b . The graph of a linear growing pattern that has an initial value of zero passes through the origin at $(0, 0)$.
- The graphical representation of a linear *growing* pattern is a line that rises to the right; for a linear *shrinking* pattern, the line descends to the right.

Note

- Growing and shrinking patterns are not limited to linear patterns.

C1.2 Patterns

create and translate repeating, growing, and shrinking patterns involving rational numbers using various representations, including algebraic expressions and equations for linear growing and shrinking patterns

Teacher supports

Key concepts

- Growing patterns are created by increasing the number of elements or the size of the elements in each iteration.
- Shrinking patterns are created by decreasing the number of elements or the size of the elements in each iteration.
- Graphical representations of linear growing and shrinking patterns appear as straight lines.
- Graphical representations of non-linear growing and shrinking patterns appear as curves.
- Some patterns are based on continuous variables, such as height, distance, or time. Graphical representations of continuous values are solid lines or curves, illustrating their continuous nature.
- A linear growing pattern can be created by repeatedly representing a pattern to show the total number of elements in each iteration of the pattern core.

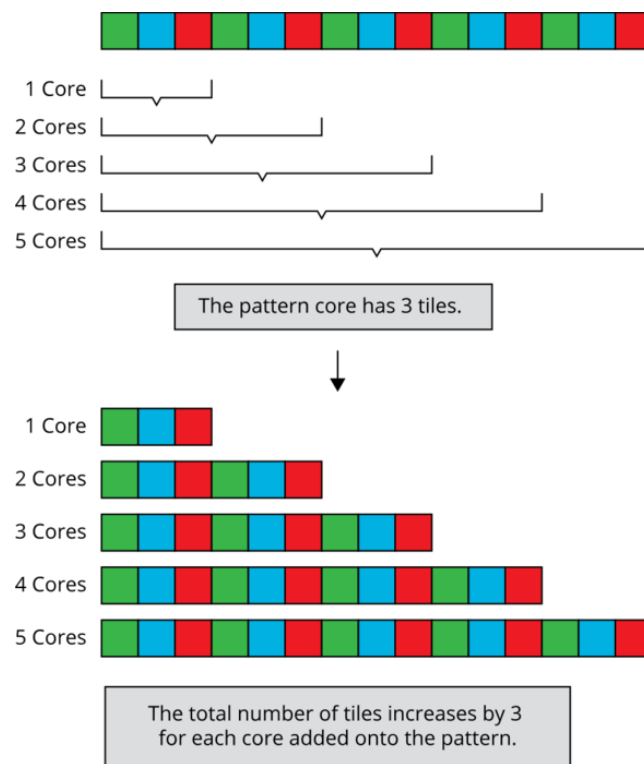

- Examining the physical structure of a linear growing pattern can provide insight into the different algebraic equations that show the relationship between the term number and the term value. For example, in Diagram 1, each term value can be viewed as four more than double the term number, which can be expressed as term value = $2 \times (\text{term number}) + 4$ or $y = 2x + 4$.

Diagram 1

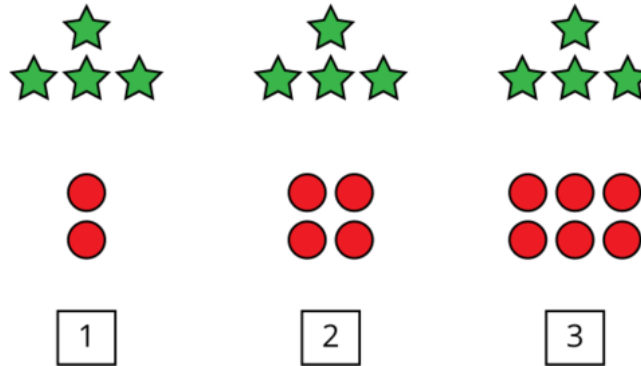

- Diagram 2 shows that for the same pattern, each term value can also be viewed as twice the term number plus two, which can be expressed as term value = term number + two + term number + two or $y = x + 2 + x + 2$. This expression for Diagram 2 can be simplified to $y = 2x + 4$, which is the same expression derived for Diagram 1.

Diagram 2

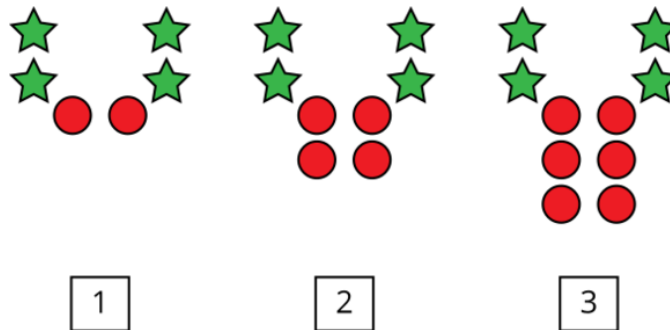

Note

- The creation of growing and shrinking patterns in this grade is not limited to linear patterns.

C1.3 Patterns

determine pattern rules and use them to extend patterns, make and justify predictions, and identify missing elements in growing and shrinking patterns involving rational numbers, and use algebraic representations of the pattern rules to solve for unknown values in linear growing and shrinking patterns

Teacher supports

Key concepts

- Patterns can be extended because they are repetitive by nature.
- Pattern rules are generalizations about a pattern, and they can be described in words.
- Patterns can be extended in multiple directions, showing what comes next and what came before.
- To make a near prediction about a pattern is to state or show what a pattern will look like just beyond the given representation of that pattern. The prediction can be verified by extending that pattern.
- To make a far prediction about a pattern is to state or show what a pattern will look like well beyond the given representation of that pattern. Often calculations are needed to make an informed prediction that can be justified.
- Identifying the missing elements in a pattern represented using a table of values may require determining the term number (x) or the term value (y).
- Identifying the missing elements in a pattern represented on a graph may require determining the point (x, y) within the given representation or beyond it, in which case the pattern will need to be extended.
- The algebraic expression that represents a linear growing and shrinking pattern is also referred to as the general term or the n th term. It can be used to solve for the term value or the term number.

Note

- Determining a point on a graph within a given set of points that fit a pattern is called interpolation. Determining a point on a graph beyond a given set of points that fit a pattern is called extrapolation. This skill set is used in a variety of contexts, including in the science curriculum when students are working on the concept of the mechanical advantage (levers).

C1.4 Patterns

create and describe patterns to illustrate relationships among rational numbers

Teacher supports

Key concepts

- Patterns can be used to demonstrate an understanding of number properties, including the use of exponents to express numbers in scientific notation.

Note

- Using patterns is a useful strategy in developing understanding of mathematical concepts, such as knowing what sign to use when two integers are added or subtracted.

C2. Equations and Inequalities

demonstrate an understanding of variables, expressions, equations, and inequalities, and apply this understanding in various contexts

Specific expectations

By the end of Grade 8, students will:

C2.1 Variables and Expressions

add and subtract monomials with a degree of 1, and add binomials with a degree of 1 that involve integers, using tools

Teacher supports

Key concepts

- A monomial with a degree of 1 has a variable with an exponent of one. For example, the exponent of m for the monomial $2m$ is 1. When the exponent is not shown, it is understood to be one.
- A binomial with a degree of 1 consists of two terms (two binomials) in which at least one of the terms has a variable with an exponent of one (e.g., $2m + 5$ or $2m + 5n$).
- Only like terms can be combined when monomials and binomials are added together. For example:
 - $5m + (-3m + 4n)$
 - $= 5m + (-3m) + 4n$
 - $= 2m + 4n$
- Monomials with a degree of 1 with the same variables can be subtracted (e.g., $-10y - 8y = -18y$).
- Monomials can be subtracted in different ways. One way is to compare them and determine the missing addend (e.g., $3m + ? = 7m$). Another way is to remove them from the expression representation.

- Strategies for performing operations with integers can also be used to add and subtract monomials and binomials.

Note

- Examples of monomials with a degree of 2 are x^2 and xy . The reason that xy has a degree of 2 is because both x and y have an exponent of 1. The degree of the monomial is determined by the sum of all the exponents of its variables.
- Visual representations can support students' understanding of combining like terms.
- When adding binomials, brackets are used around the expressions to show that they are binomials.

C2.2 Variables and Expressions

evaluate algebraic expressions that involve rational numbers

Teacher supports

Key concepts

- To evaluate an algebraic expression, the variables are replaced with numerical values and calculations are performed based on the order of operations.

Note

- When students are working with formulas, they are evaluating expressions.
- Replacing the variables with numerical values often requires the use of brackets. For example, the expression $\frac{3}{4}m$ becomes $\frac{3}{4}(m)$ and then $\frac{3}{4}\left(\frac{2}{5}\right)$ when $m = \frac{2}{5}$. The operation between $\frac{3}{4}$ and $\left(\frac{2}{5}\right)$ is understood to be multiplication.
- Many coding applications involve algebraic expressions being evaluated. This may be carried out in several steps. For example, the instruction: "input 'the radius of a circle', radiusA" is instructing the computer to define the variable "radiusA" and store whatever the user inputs into the temporary location called radiusA. The instruction: "input 'the height of the cylinder', heightA" is instructing the computer to define the variable "heightA" and store whatever the user inputs into the temporary location called heightA. The instruction: "calculate $3.14 * \text{radiusA}^2 * \text{heightA}$, volumeA" instructs the computer to take the value that is stored in radiusA and multiply it by itself, then multiply it by the value stored in heightA, and then store that result in the temporary location, which is

another variable called “volumeA”. (The caret symbol (^) is used with many forms of technology as the exponent symbol.)

C2.3 Equalities and Inequalities

solve equations that involve multiple terms, integers, and decimal numbers in various contexts, and verify solutions

Teacher supports

Key concepts

- Equations are mathematical statements such that the expressions on both sides of the equal sign are equivalent.
- In equations, variables are used to represent unknown quantities.
- There are many strategies to solve equations, including guess-and-check, the balance model, and using the reverse flow chart.
- Equations need to be simplified in order to use the strategy of using a reverse flow chart to solve equations like $\frac{m}{4} - 2 = -10$. The first diagram shows the flow of operations performed on the variable m to produce the result -10 . The second diagram shows the reverse flow chart, or flow of the reverse operations, in order to identify the value of the variable m .

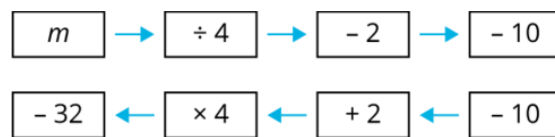

- Formulas are equations in which any of the variables can be solved for. When solving for a variable in a formula, values for the variables are substituted in and then further calculations maybe needed depending on which variable is being solved for. For example, for $A = lw$, if $l = 10.5$, and $w = 3.5$, then $A = (10.5)(3.5) = 36.75$. If $A = 36.75$ and $l = 10.5$, then $36.75 = 10.5w$, and this will require dividing both sides by 10.5 to solve for w .

Note

- The flow chart used in coding is different from the reverse flow chart that can be used to solve equations.
- Many coding applications involve formulas and solving equations.

C2.4 Equalities and Inequalities

solve inequalities that involve integers, and verify and graph the solutions

Teacher supports

Key concepts

- An inequality can be solved like an equation, and then values need to be tested to identify those that hold true for the inequality.
- When multiplying or dividing by a negative integer, the inequality sign needs to be reversed in order for the solution to hold true.
- A number line shows the range of values that hold true for an inequality by placing a dot at the greatest or least possible value. An open dot is used when an inequality involves “less than” or “greater than”; if the inequality includes the equal sign ($=$), then a closed dot is used.

Note

- Inequalities that involve multiple terms may need to be simplified before they can be solved.
- The solution for an inequality that has one variable, such as $-2x + 3x < 10$, can be graphed on a number line.
- The solution for an inequality that has two variables, such as $x + y < 4$, can be graphed on a Cartesian plane, showing the set of points that hold true.

C3. Coding

solve problems and create computational representations of mathematical situations using coding concepts and skills

Specific expectations

By the end of Grade 8, students will:

C3.1 Coding Skills

solve problems and create computational representations of mathematical situations by writing and executing code, including code that involves the analysis of data in order to inform and communicate decisions

Teacher supports

Key concepts

- Data can be stored in lists, or input into a program, in order to find solutions to problems and make decisions.
- A flow chart can be used to plan and organize thinking. The symbols used in flow charts have specific meanings, including those that represent a process, a decision, and program input/output.
- Efficient code can include using the fewest number of instructions to solve a problem, using the smallest amount of space to store program data, or executing as fast as possible.
- Loops can be used to create efficient code.
- Conditional statements, like loops, can be nested to allow for a range of possible outcomes or to implement decision trees.
- Sub-programs are used to assemble a complex program by writing portions of the code that can be modularized. This helps to create efficient code.

Note

- By combining mathematical and coding concepts and skills, students can write programs to draw conclusions from data.
- Students can use data, coding, and math concepts and skills to generate a range of possibilities and likelihoods and decide upon a specific course of action (e.g., optimizing packaging, price points, sports performance).
- Coding can be used to automate simple processes and enhance mathematical thinking. For example, students can code expressions to recall previously stored information (defined variables), then input values (e.g., from a sensor, count, or user input) and redefine the value of the variable. (See **SEs C2.2** and **C2.3**.)

C3.2 Coding Skills

read and alter existing code involving the analysis of data in order to inform and communicate decisions, and describe how changes to the code affect the outcomes and the efficiency of the code

Teacher supports

Key concepts

- Reading code is done to make predictions as to what the expected outcome will be. Based on that prediction, one can determine if the code needs to be altered prior to its execution.
- Reading code helps with troubleshooting why a program is not able to execute.
- Code is altered so that an expected outcome can be achieved.
- Code can be altered to be used for a new situation.
- Altering code to make it more efficient often involves refining algorithms so that there are no unnecessary steps and using control structures effectively.
- Using sub-programs makes it easier to debug programs since each sub-program can be tested individually.

Note:

- Altering existing code and describing how changes affect outcomes allows students to investigate relationships and pose and test what-if questions.
- By describing how changes affect outcomes, students are making predictions.
- By reading and describing code and algorithms, students are learning to articulate complex mathematical ideas and concepts.
- When students are provided with code and algorithms to solve complex problems, they can alter this code to solve similar problems, thereby gaining a deeper understanding of the mathematical and coding concepts involved.

C4. Mathematical Modelling

apply the process of mathematical modelling to represent, analyse, make predictions, and provide insight into real-life situations

This overall expectation has no specific expectations. Mathematical modelling is an iterative and interconnected process that is applied to various contexts, allowing students to bring in learning from other strands. Students' demonstration of the process of mathematical modelling, as they apply concepts and skills learned in other strands, is assessed and evaluated.

Read more about the [mathematical modelling process](#).

Teacher supports

Key concepts

- The process of mathematical modelling requires: understanding the problem; analysing the situation; creating a mathematical model; and analysing and assessing the model.

Note

- A mathematical modelling task is different from a real-life application due to the cyclic nature of modelling, which involves examining a problem from outside mathematics, modelling it, and then checking the model back against the real-life situation and adjusting as necessary.
- The process of mathematical modelling should not be confused with using a "model" to represent or solve a problem that does not require the whole process.
- Mathematical modelling tasks can be utilized in many ways and can support students with making connections among many mathematical concepts across the math strands and across other curricula.

D. Data

Overall expectations

By the end of Grade 8, students will:

D1. Data Literacy

manage, analyse, and use data to make convincing arguments and informed decisions, in various contexts drawn from real life

Specific expectations

By the end of Grade 8, students will:

D1.1 Data Collection and Organization

identify situations involving one-variable data and situations involving two-variable data, and explain when each type of data is needed

Teacher supports

Key concepts

- A variable is any attribute, number, or quantity that can be measured or counted.
- One-variable data refers to one data set from a sample or a population that can be either qualitative or quantitative. Situations involve representing and analysing the data based on that one variable to answer a question like “What is the average height of all the students in the class?”
- Two-variable data refers to two data sets from the same sample or population that can be either qualitative or quantitative. Situations involve representing and analysing the data based on two variables to answer questions like “Is there a relationship between a person’s height and the length of their arm span?”

D1.2 Data Collection and Organization

collect continuous data to answer questions of interest involving two variables, and organize the data sets as appropriate in a table of values

Teacher supports

Key concepts

- The type and amount of data to be collected is based on the questions of interest. Questions of interest involving two variables require two sets of data to be collected from the same sample or population.
- Depending on the question of interest, the continuous data may need to be collected from a primary or a secondary source.
- Depending on the question of interest, a random sample of the population may need to be taken. Types of sampling methods include simple random sampling, stratified random sampling, and systematic random sampling.
- A table of values for a scatter plot is a list of corresponding values of two variables for each subject in a sample or population.

Note

- A scatter plot does not guarantee that there is a relationship between the two variables. Therefore, it is only when there is a relationship that one variable is dependent on the other variable (i.e., for a relation, the x -value in the set of ordered pairs (x, y) is the independent variable and the y -value is the dependent variable).

- Many science experiments involve the relationship between two variables. The independent variable is what the researcher gets to change, and the dependent variable is what the researcher gets to observe or measure during the experiment.

D1.3 Data Visualization

select from among a variety of graphs, including scatter plots, the type of graph best suited to represent various sets of data; display the data in the graphs with proper sources, titles, and labels, and appropriate scales; and justify their choice of graphs

Teacher supports

Key concepts

- Scatter plots are used to display data points for two continuous variables. The horizontal axis identifies the possible values for one variable and the vertical axis identifies the possible values for the other variable.
- Broken-line graphs are used to show change over time. The value on the horizontal axis is usually time. One or none of the variables are continuous.
- Circle graphs are used to show how categories represent a part of the whole data set for one variable.
- Histograms display data as intervals of numeric data, and their frequencies for one variable that is continuous.
- Pictographs, line plots, bar graphs, multiple-bar graphs, and stacked-bar graphs may be used to display qualitative data and discrete data, and their corresponding frequencies for one variable.

Note

- Data that is represented in a table of values displays two pieces of information for each subject in the sample or population. These two pieces of information can be graphed together using a scatter plot. Also, each piece of information can be treated separately and represented using another type of graph such as a histogram or circle graph.

D1.4 Data Visualization

create an infographic about a data set, representing the data in appropriate ways, including in tables and scatter plots, and incorporating any other relevant information that helps to tell a story about the data

Teacher supports

Key concepts

- Infographics are used in real life to share data and information on a topic, in a concise, clear, and appealing way.
- Infographics contain different representations, such as tables, plots, graphs, with limited text such as quotes.
- Information to be included in an infographic needs to be carefully considered and presented so that it is clear and concise. Infographics tell a story about the data with a specific audience in mind. When creating infographics, students need to create a narrative about the data for that audience.

Note

- Creating infographics has applications in other subject areas, such as communicating key findings and messages in STEM projects.

D1.5 Data Analysis

use mathematical language, including the terms “strong”, “weak”, “none”, “positive”, and “negative”, to describe the relationship between two variables for various data sets with and without outliers

Teacher supports

Key concepts

- When data points form close to a line or a curve, this indicates there is a strong relationship between the variables.
- When data points are in a cluster, this indicates there is no relationship.
- The scatter plot of a weak relationship between two variables shows points that are more spread out than those showing a strong relationship.
- The scatter plot of a positive relationship shows points going upwards from the origin and to the right. The scatter plot of a negative relationship shows points going down from the y -axis to the x -axis.
- If a data set has outliers something may have gone wrong in the data collection (or measurement). This requires further investigation. It may represent a valid, unexpected piece of the population needing further clarification. If the investigation uncovers an error, the researcher should fix it. If the data turns out to be from an individual that is not

part of the population, then it should be removed. If none of these are uncovered, then re-sampling may be needed.

Note

- A line of best fit or a curve of best fit can be drawn through the majority of the points and used to make predictions where there is a strong relationship between the two variables.

D1.6 Data Analysis

analyse different sets of data presented in various ways, including in scatter plots and in misleading graphs, by asking and answering questions about the data, challenging preconceived notions, and drawing conclusions, then make convincing arguments and informed decisions

Teacher supports

Key concepts

- Scatterplots are used to determine if a relationship exists between two numerical variables. Analysis of the scatter plot requires identifying how closely the points form a line or curve in order to conclude that there is a relationship.
- The range and the measures of central tendencies may be used to analyse data involving one variable.
- Sometimes graphs misrepresent data or show it inappropriately and this could influence the conclusions that we make about it. Therefore, it is important to always interpret presented data with a critical eye.
- Data presented in tables, plots, and graphs can be used to ask and answer questions, draw conclusions, and make convincing arguments and informed decisions.
- Sometimes presented data challenges current thinking and leads to new and different conclusions and decisions.
- Questions of interest are intended to be answered through the analysis of the representations. Sometimes the analysis raises more questions that require further collection, representation, and analysis of data.

Note

- There are three levels of graph comprehension that students should learn about and practise:

- Level 1: information is read directly from the graph and no interpretation is required.
- Level 2: information is read and used to compare (e.g., greatest, least) or perform operations (e.g., addition, subtraction).
- Level 3: information is read and used to make inferences about the data using background knowledge of the topic.

D2. Probability

describe the likelihood that events will happen, and use that information to make predictions

Specific expectations

By the end of Grade 8, students will:

D2.1 Probability

solve various problems that involve probability, using appropriate tools and strategies, including Venn and tree diagrams

Teacher supports

Key concepts

- Venn diagrams can be used to understand the relationship of probabilities involving multiple events that are given in order to solve a problem. The sum of the components of a Venn diagram is 100% of the total population or sample being referenced.
- Tree diagrams can be used to determine all the possible combinations of outcomes for two or more events that are either independent or dependent.

Note

- Sample space diagrams are a visual way of recording all of the possible outcomes for two events. The diagram below shows the possibilities when two coins are tossed.

		1 st Coin	
		H	T
2 nd Coin	H	(H, H)	(H, T)
	T	(T, H)	(T, T)

D2.2 Probability

determine and compare the theoretical and experimental probabilities of multiple independent events happening and of multiple dependent events happening

Teacher supports

Key concepts

- Two events are independent if the probability of one does not affect the probability of the other. For example, the probability for rolling a die the first time does not affect the probability for rolling a die the second time, third time, and so on.
- The more trials completed in an experiment, the closer the experimental probability will be to the theoretical probability.
- The sum of the probability of all possible outcomes is 1 or 100%.
- The probability of an event can be used to predict the likelihood of that event happening again in the future.
- Tree diagrams are helpful to determine all the possible outcomes for multiple independent events and multiple dependent events.

Note

- “Odds in favour” is a comparison of the probability that an event will occur with the probability that the event will not occur (complementary events). For example, the probability that the sum of two dice is 2 is $\frac{1}{36}$ and the probability that the sum of two dice is not 2 is $\frac{35}{36}$. The odds in favour of rolling a sum of 2 is $\frac{1}{36} : \frac{35}{36}$ or 1:35, since the fractions are both relative to the same whole.

E. Spatial Sense

Overall expectations

By the end of Grade 8, students will:

E1. Geometric and Spatial Reasoning

describe and represent shape, location, and movement by applying geometric properties and spatial relationships in order to navigate the world around them

Specific expectations

By the end of Grade 8, students will:

E1.1 Geometric Reasoning

identify geometric properties of tessellating shapes and identify the transformations that occur in the tessellations

Teacher supports

Key concepts

- A tessellation uses tiles to cover an area without gaps or overlaps. The angles where tiles meet always add up to 360° .
- Tessellating tiles are composed of one or more shapes and fit together in a repeating pattern. They are often used to create artistic designs, including wallpaper, quilts, rugs, and mosaics.
- Complex tessellating tiles can be designed by decomposing shapes and rearranging the parts using combinations of translations, reflections, and rotations (see also **SE E1.3**).
- If a shape can be transformed through a series of rotations, reflections and translations (i.e., by being turned, flipped, or slid), and still look the same, the shape is symmetric. Tessellating tiles are symmetric.
- There are different types of symmetries. For example, there is reflective symmetry, rotational symmetry, and translational symmetry. Symmetry is both an adjective (an attribute) and an action (a transformation). Creating and describing tessellating tiles involves symmetry as both an action and an attribute.

E1.2 Geometric Reasoning

make objects and models using appropriate scales, given their top, front, and side views or their perspective views

Teacher supports

Key concepts

- Two-dimensional drawings, if they are accurately constructed and include enough information, can be used to reproduce actual-sized objects or scaled models in three-dimensions (see also **SE E1.3**).

- Two-dimensional drawings can show how things are made, how they can be navigated, or how they can be reproduced, and can be used to represent anything from very small objects to very large spaces.
- Two-dimensional drawings are read and interpreted when navigating a map, following assembly instructions, or building an object from a plan.
- Top (plan) views, and front, and side (elevation) views are “flat drawings” without perspective. They are used in technical drawings to ensure a faithful reproduction in three-dimensions.
- A perspective drawing shows three views (top, front, side) in one illustration. It is preferred for illustrations; however, angles are distorted and backside elements may be hidden. Isometric grids (also called triangular grids) are used to draw different perspectives, including isometric and cabinet projections.

Note

- Cabinet projections are so named because of their early use in the furniture industry. Isometric means “equal measure” and isometric projections use the same scale.
- A scale is a ratio that compares actual dimensions to the dimensions in the drawing. A scale ensures that the intended lengths and proportions can be reproduced. Depending on the type of drawing, angles may or may not be represented accurately.
 - Top, front, and side views of an object or space (plan and elevation drawings) use the actual angle sizes in the drawing and show all lengths in a common scale. For example, a 60° angle in the drawing is 60° in real life, and a scale of 1:100 means that 1 cm on the drawing equals 100 cm in real life (or 1 mm on the drawing equals 100 mm in real life, and so on).
 - Isometric projections, drawn on a triangular grid, show all lengths in the same scale, including the lines that show depth. However, angles are distorted to create the appearance of perspective. Therefore, for example, a 90° angle in real life appears as a 60° in an isometric drawing.
 - Cabinet projections also distort angles but use two scales to create perspective. The “depth” scale is half that of the “base and height” scale. So, for a scale of 1:100, a cabinet projection of a 1 cm cube would have a base and height of 1 cm, but a depth of 0.5 cm.

E1.3 Geometric Reasoning

use scale drawings to calculate actual lengths and areas, and reproduce scale drawings at different ratios

E1.4 Location and Movement

describe and perform translations, reflections, rotations, and dilations on a Cartesian plane, and predict the results of these transformations

Teacher supports

Key concepts

- When shapes are transformed on a Cartesian plane, the coordinates of the original vertices are transformed to create corresponding coordinates known as image points. Each of the transformations can be defined using a mapping rule in which each point is transformed using that rule.
 - Mapping rule for translations:
 - $(x, y) \rightarrow (x + a, y + b)$. If a is positive, then the x -value of the image point is to the right ' a ' units from the original point. If a is negative, then the x -value of the image point is to the left ' a ' units from the original point. If b is positive, then the y -value of the image point is up ' b ' units from the original point. If b is negative, then the y -value of the image point is down ' b ' units from the original point. For example, $(x, y) \rightarrow (x - 5, y - 2)$; each of the image points are left 5 units and down 2 units from the original point.
 - Mapping rules for reflections:
 - a shape reflected in the x -axis has a mapping rule $(x, y) \rightarrow (x, -y)$. For example, the vertex of the shape originally positioned at $(2, 3)$ is now at $(2, -3)$.
 - A shape reflected in the y -axis has a mapping rule $(x, y) \rightarrow (-x, y)$. For example, the vertex of the shape originally positioned at $(2, 3)$ is now at $(-2, 3)$.
 - Mapping rules for rotations about the origin:
 - a shape rotated 90° counterclockwise has a mapping rule $(x, y) \rightarrow (-y, x)$.
 - a shape rotated 180° counterclockwise has a mapping rule $(x, y) \rightarrow (-x, -y)$.
 - a shape rotated 270° counterclockwise has a mapping rule $(x, y) \rightarrow (y, -x)$.
 - Mapping rules for dilations:

- $(x, y) \rightarrow (ax, ay)$. For example, $(x, y) \rightarrow (2x, 2y)$; each of the image points are double the original points. For example, the image point for $(-3, 4)$ would be $(-6, 8)$.

Note

- Transformations on the Cartesian Plane involve points being relocated to another position.
- Translations “slide” a point, segment, or shape by a given distance and direction (vector).
- Reflections “flip” a point, segment, or shape across a reflection line to create its opposite.
- Rotations “turn” a point, segment, or shape around a point centre of rotation by a given angle.
- Dilations (or dilatations) “enlarge” or “shrink” a distance by a given scale factor. Scale factors with an absolute value greater than 1 enlarge the distance, and those with an absolute value of less than 1 reduce the distance. Negative scale factors dilate the shape and rotate it 180° .
- Translations, reflections, and rotations all produce congruent images:
 - Lines map to lines of the same length.
 - Angles map to angles of the same measure.
 - Parallel lines map to parallel lines.
- Dilations (or dilatations) produce scaled images that are *similar*:
 - Lines map to line lengths at a constant scale factor of the same length.
 - Angles map to angles of the same measure.
 - Parallel lines map to parallel lines.

E2. Measurement

compare, estimate, and determine measurements in various contexts

Specific expectations

By the end of Grade 8, students will:

E2.1 The Metric System

represent very large (mega, giga, tera) and very small (micro, nano, pico) metric units using models, base ten relationships, and exponential notation

Teacher supports

Key concepts

- Technology has enabled accurate measurements including very small and very large measures.
- All metric units are based on a system of tens and the metric prefixes describe the relative size of a unit (see **Grade 4, SE E2.2**). Whereas units from kilo- to milli- are scaled by powers of 10, units beyond these are scaled by powers of 1000. Exponents are helpful for representing these relationships.

Metric Prefix	Meaning	Factor
tera-unit	1 trillion units	1 unit \times 1 000 000 000 000(10^{12})
giga-unit	1 billion units	1 unit \times 1 000 000 000 (10^9)
mega-unit	1 million units	1 unit \times 1 000 000 (10^6)
kilo-unit	1 thousand units	1 unit \times 1000 (10^3)
unit	one unit	1 unit (10^0)
milli-unit	one thousandth of a unit	1 unit \div 1000 ($\frac{1}{10^3}$) or 10^{-3}
micro-unit	one millionth of a unit	1 unit \div 1 000 000 ($\frac{1}{10^6}$) or 10^{-6}
nano-unit	one billionth of a unit	1 unit \div 1 000 000 000 ($\frac{1}{10^9}$ or 10^{-9})
pico-unit	one trillionth of a unit	1 unit \div 1 000 000 000 000 ($\frac{1}{10^{12}}$ or 10^{-12})

E2.2 Lines and Angles

solve problems involving angle properties, including the properties of intersecting and parallel lines and of polygons

Teacher supports

Key concepts

- Angles can be measured indirectly (calculated) by applying angle properties.
- If a larger angle is composed of two smaller angles, only two of the three pieces of information are needed to calculate the third.
- Angle properties can be used to determine unknown angles.

- A straight angle measures 180° ; this is used to determine the measure of a supplementary angle.
- A right angle measures 90° ; this is used to determine the measure of a complementary angle.
- The interior angles of triangles sum to 180° , the interior angles of quadrilaterals sum to 360° , the interior angles of pentagons sum to 540° , and the interior angles of n -sided polygons sum to $(n - 2) \times 180$. The angle properties of a polygon can be used to determine the measure of a missing angle.
- The properties above can be used to determine unknown angles when a line (transversal) intersects two parallel lines:

	<ul style="list-style-type: none"> • Alternate interior angles are equal, so $\angle c = \angle e$ and $\angle d = \angle f$ (Z-pattern). • Opposite angles are equal, so $\angle b = \angle d$, $\angle a = \angle c$, $\angle f = \angle h$ and $\angle e = \angle g$ (angles formed by two lines intersecting). • Alternate exterior angles are equal, so $\angle b = \angle h$, and $\angle a = \angle g$ (Z-pattern). • Corresponding angles are equal, so $\angle b = \angle f$, $\angle c = \angle g$, $\angle a = \angle e$, and $\angle d = \angle h$ (F-pattern). • Co-interior angles sum to 180°, so $\angle c + \angle f = 180^\circ$ and $\angle d + \angle e = 180^\circ$ (C-pattern).
--	--

Note

- The aim of this expectation is not to memorize these angle theorems or the terms, but to use spatial reasoning and known angles to determine unknown angles.
- Smaller angles may be added together to determine a larger angle. This is the additivity principle of measurement.
- If two shapes are similar, their corresponding angles are equal (see **SE E1.3**). Recognizing similarity between shapes (e.g., by ensuring that the corresponding side lengths of a shape are proportional) can help to identify their corresponding angles.

E2.3 Length, Area, and Volume

solve problems involving the perimeter, circumference, area, volume, and surface area of composite two-dimensional shapes and three-dimensional objects, using appropriate formulas

Teacher supports

Key concepts

- Two-dimensional shapes and three-dimensional objects can be decomposed into measurable parts.
- The attributes of length (including distance, perimeter, and circumference), area (including surface area), volume, capacity, and mass all have the property of additivity. Measures of parts can be combined to determine the measure of the whole.
- For some attributes and for some shapes, relationships exist that can be expressed as formulas. To apply these formulas to composite shapes and objects, the shapes and objects are decomposed into parts that have known formulas. For example, an L-shaped area could be decomposed into two rectangles, and the smaller areas added together to calculate the whole. (Note: this will not hold true for its perimeter.)
- Applying formulas to real-world contexts requires judgement and thoughtfulness. For example, to apply the formula for the area of rectangle to a garden:
 - determine whether the garden is rectangular;
 - determine whether the garden is close enough to a rectangle that, for the needs of the moment, the formula can be applied;
 - if not rectangular, determine whether the garden can be broken into smaller rectangles (e.g., if it is an L-shaped garden) and the areas combined;
 - if decomposition results in other shapes, apply appropriate area formulas or draw a scale drawing on a grid and approximate the count of squares.
- Known length formulas at this grade level include:
 - $Perimeter = side + side + side + \dots$
 - $Diameter = 2 \times radius (2r)$
 - $Circumference = \pi \times diameter (\pi d)$
- Known area formulas at this grade level include:
 - $Area \text{ of a rectangle} = base \times height$
 - $Area \text{ of a parallelogram} = base \times height$
 - $Area \text{ of a triangle} = \frac{1}{2}(base \times height)$
 - $Area \text{ of a trapezoid} = \frac{1}{2}(base 1 + base 2) \times height$ (or its equivalent)
 - $Area \text{ of a circle} = \pi \times radius \times radius (\pi r^2)$
- Known volume formulas at this grade level include:
 - $Volume \text{ of a prism} = (area \text{ of the base}) \times height$

- *Volume of a cylinder = (area of the base) × height*

E2.4 Length, Area, and Volume

describe the Pythagorean relationship using various geometric models, and apply the theorem to solve problems involving an unknown side length for a given right triangle

Teacher supports

Key concepts

- The properties of a right triangle can be used to find an unknown side length. The longest side of a right triangle is always opposite the 90° angle and it is called the hypotenuse.
- Given any right triangle, the hypotenuse squared is equal to the sum of the squares of the other two sides. This is known as the Pythagorean relationship. The hypotenuse squared, and each of the sides squared can be represented as three squares formed with the three sides of the triangle, and then visualizing the sum of the areas of the two smaller squares as being equivalent to the area of the larger square.

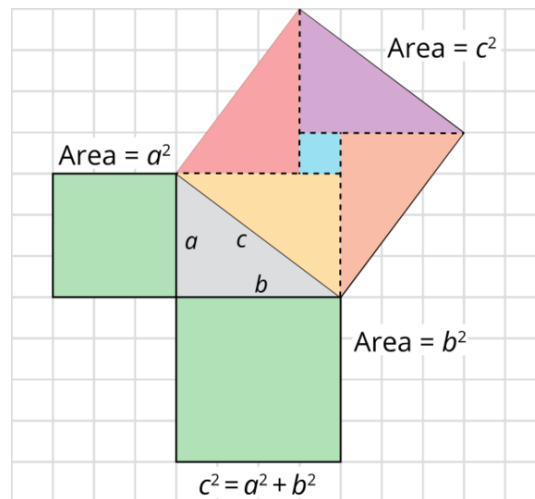

- The Pythagorean theorem expresses this relationship symbolically: $a^2 + b^2 = c^2$, where c is the length of the hypotenuse and a and b are the lengths of the other two sides of the triangle. For example:
 - if side a is 3 units long, then a square constructed on this side has an area of 3^2 or 9 square units;
 - if side b is 4 units long, then a square constructed on this side has an area of 4^2 or 16 square units;

- if the square on side c is equal to the combined areas of the squares on sides a and b , then the square on side c must have an area of 25 square units (9 square units + 16 square units);
 - if the area of the square on side c is 25 square units, then the length of c must be $\sqrt{25}$ or 5 units.
- The inverse relationship between addition and subtraction means that the Pythagorean theorem can be used to find any length on a right triangle (e.g., $c^2 - b^2 = a^2$; $c^2 - a^2 = b^2$).
 - The Pythagorean theorem is used to indirectly measure lengths that would be impractical or impossible to measure directly. For example, the theorem is used extensively in construction, architecture, and navigation, and extensions of the theorem are used to measure distances in space.

Note

- Dynamic geometric software can provide students with opportunities to expand their thinking about the Pythagorean relationship related to the areas of shapes other than squares (e.g., semi-circles with diameters that are each of the sides of the triangle.)
- The properties of a square can be used to find its side length or area. The side length of a square is equal to the square root of its area (see also **SE B1.3**). Constructing a square on a line is one way to indirectly measure the line's length.

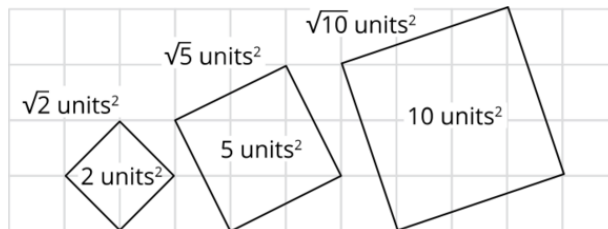

F. Financial Literacy

Overall expectations

By the end of Grade 8, students will:

F1. Money and Finances

demonstrate the knowledge and skills needed to make informed financial decisions

Specific expectations

By the end of Grade 8, students will:

F1.1 Money Concepts

describe some advantages and disadvantages of various methods of payment that can be used when dealing with multiple currencies and exchange rates

Teacher supports

Key concepts

- There are different ways to make a payment in a different currency, and there are advantages and disadvantages for each.
- Exchange rates should be considered when making a purchase that requires a conversion of funds.

Note

- An understanding of how payments can be made in other currencies extends prior knowledge of money concepts.
- Relevant and meaningful contexts help consolidate their financial and mathematical understanding and skills.

F1.2 Financial Management

create a financial plan to reach a long-term financial goal, accounting for income, expenses, and tax implications

Teacher supports

Key concepts

- Income and expenses have an impact on short-, medium-, and long-term financial goals.
- Income, expenses, and tax implications are important elements to consider when creating a financial plan or budget to achieve a financial goal.

F1.3 Financial Management

identify different ways to maintain a balanced budget, and use appropriate tools to track all income and spending, for several different scenarios

Teacher supports

Key concepts

- Balancing a budget requires tracking income, fixed and variable expenses, spending, and saving.
- Various tools (e.g., spreadsheets, apps) are used to help balance budgets and adjust budgets as needed.

Note

- Social-emotional learning skills and financial management concepts and skills are concurrently developed.

F1.4 Financial Management

determine the growth of simple and compound interest at various rates using digital tools, and explain the impact interest has on long-term financial planning

Teacher supports

Key concepts

- Simple and compound interest grow differently over time in various saving and borrowing scenarios.
- Online tools available to calculate the impact of simple and compound interest over a long period of time.

Note

- Simulated scenarios provide opportunities for students to learn financial literacy concepts in relevant and real-life contexts.

F1.5 Consumer and Civic Awareness

compare various ways for consumers to get more value for their money when spending, including taking advantage of sales and customer loyalty and incentive programs, and determine the best choice for different scenarios

Teacher supports

Key concepts

- Discounts and loyalty programs are offered to consumers as a way for them to get more perceived value for their money.
- It is important to understand the advantages and disadvantages of these programs for both consumers and businesses.

Note

- Simulated scenarios provide opportunities for students to learn financial literacy concepts in relevant and real-life contexts.

F1.6 Consumer and Civic Awareness

compare interest rates, annual fees, and rewards and other incentives offered by various credit card companies and consumer contracts to determine the best value and the best choice for different scenarios

Teacher supports

Key concepts

- When choosing any type of consumer contract, such as for credit cards, or a data plan for example, it is important to identify the interest rates, fees, and incentives offered in order to make an informed decision.

- Before making their decision, informed consumers often compare the incentives offered by various businesses and consider the benefit and costs of these incentives for the consumers versus the benefit for businesses.

Note

- Simulated scenarios provide opportunities for students to learn financial literacy concepts in relevant and real-life contexts.

Glossary

The definitions provided in this glossary are specific to the curriculum context in which the terms are used.

24-hour clock

A way of counting time based on the full twenty-four hours of the day from midnight to midnight, rather than using two groups of twelve hours.

absolute value

The distance a real number is from 0 on a number line, regardless of direction; for example, the absolute value of both 5 and -5 is 5. *See also* **real numbers**.

abstract level of understanding

Understanding of mathematics at a symbolic level.

abstraction

In counting, the idea that a quantity can be represented by different things. For example, 5 can be represented by 5 like objects, by 5 different objects, by 5 invisible things (5 ideas), or by 5 points on a line.

acute angle

An angle whose measure is between 0° and 90° . *See also* **angle**, **obtuse angle**.

acute triangle

A triangle whose angles all measure less than 90° . *See also* **triangle**.

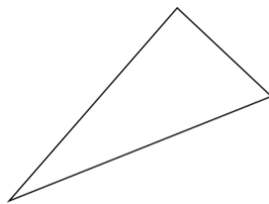

addition

The operation that represents the sum of two or more numbers. The inverse, or opposite, operation of addition is subtraction. *See also* **subtraction**.

algebra tiles

Learning tools that can be used to model operations involving integers, expressions, and equations. Each tile represents a particular term, such as 1, x , or x^2 .

algebraic equation

See **algebraic expression, equation**.

algebraic expression

A collection of one or more terms including variables and numbers separated by mathematical operation symbols. For example $2c - 1$ and $7a + 4b$ are algebraic expressions. See also **term, variable**.

algebraic representation

A representation of mathematical ideas using algebraic expressions or equations. See also **representation**.

algorithm

A specific sequence of well-defined steps to solve a problem or perform a calculation. See also **flexible algorithm**.

alternate angles

Two angles on opposite sides of a transversal when it crosses two lines. The angles are equal when the lines are parallel. The angles form one of these patterns:

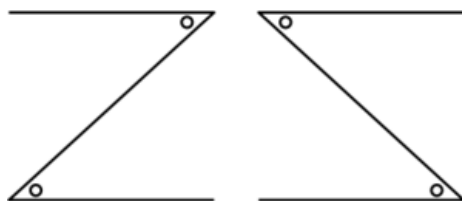

See also **angle, parallel, transversal**.

analog clock

A timepiece that measures the time by the position of its hands. See also **digital clock**.

anchors (of 5 and 10)

Significant numbers, inasmuch as 10 is the basis of our number system, and two 5s make up 10. Relating other numbers to 5 and 10 (e.g., 7 as 2 more than 5 and 3 less than 10) helps students

to develop an understanding of number magnitude, to learn basic addition and subtraction facts, and to acquire number sense and operational sense. *See also* **five frame, ten frame.**

angle

A shape formed by two rays or two line segments with a common endpoint. *See also* **vertex.**

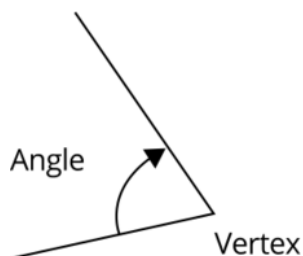

area model

A diagrammatic representation that uses area to demonstrate other mathematical concepts. In an area model for multiplication, for example, the length and width of a rectangle represents the factors, and the area of the rectangle represents the product. The diagram shows the use of an area model to represent 26×14 . *See also* **factor, mathematical model, product.**

	20	6
10	200	60
4	80	24

$26 \times 14 = 200 + 60 + 80 + 24$
 $= 364$

array

A rectangular arrangement of objects into rows and columns, used to represent multiplication (e.g., 3×6 can be represented by 18 objects arranged in 3 rows and 6 columns). Can also be used to represent the area of a rectangle. *See also* **open array.**



associative property

A property of addition and multiplication that allows the numbers being added or multiplied to be regrouped without changing the outcome of the operations. For example,

$(7 + 9) + 1 = 7 + (9 + 1)$ and $(7 \times 4) \times 5 = 7 \times (4 \times 5)$. In general, $(a + b) + c = a + (b + c)$ and $(a \times b) \times c = a \times (b \times c)$. Using the associative property can simplify computation. This property does not generally hold for subtraction or division. *See also* **commutative property, distributive property**.

attribute

A characteristic related to the physical appearance of an object, person, or occurrence, identified on the basis of observation or through manipulation.

automaticity

The ability to use skills or perform mathematical procedures with little or no mental effort. In mathematics, recall of basic facts and performance of computational procedures often become automatic with practice. *See also* **drill, fluency**.

average

See **mean**.

axis (plural: axes)

A reference line used in a graph or coordinate system.

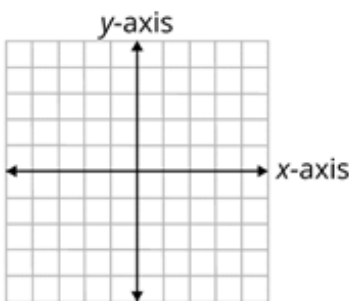

balance

In financial literacy, the amount of money in an account, representing the difference between credits and debits; in budgeting, the action of comparing income and expenses and adjusting the budget so that the income equals or surpasses the expenses. *See also* **budget, credit**.

balance model

A strategy for teaching the concepts of equality and inequality concretely through the use of a balance scale. It involves focusing on what is needed to maintain balance or equality between

two sides. When using this analogy of balance, whatever is done to one side of the equation must also be done to the other side of the equation in order to maintain balance or equivalence. *See also* **balance scale, equality, inequality**.

balance scale

A device consisting of two pans, buckets, or platforms supported at opposite ends of a balance beam. A balance scale is used to compare and measure masses of objects.

balanced budget

A budget in which income is equal to or greater than expenses. *See also* **budget**.

bar graph

A graph consisting of horizontal or vertical bars of equal width that represent the frequency of an event or outcome. There are gaps between the bars to reflect the discrete nature of the data.

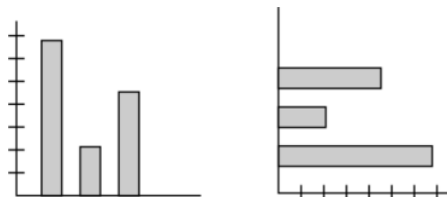

barter

To exchange goods or services for other goods or services. *See also* **goods and services**.

base

See **exponential notation**.

base (shapes)

In three-dimensional objects, the face that is usually seen as the bottom (e.g., the square face of a square-based pyramid). In prisms, the two congruent and parallel faces are called bases (e.g., the triangular faces of a triangle-based prism). *See also* **congruent, parallel, prism, pyramid, three-dimensional object**.

base ten fraction

A fraction whose denominator is a power of ten (e.g., $\frac{3}{10}$, $\frac{29}{100}$, $\frac{7}{1000}$). Also called a *decimal fraction*. *See also* **denominator, power of ten**.

base ten materials

Three-dimensional models designed to represent ones, tens, hundreds, and thousands proportionally. Ten *ones units* are combined to make 1 *tens rod*, 10 rods are combined to make 1 *hundreds flat*, and 10 flats are combined to make 1 *thousands cube*. These materials help students understand the concept of place value and operations with numbers.

base ten number system

A number system that uses the position of a digit to denote its value, including decimal values that are less than one. All numbers can be represented using the digits 0 through 9. The system is based on groupings of ten; for example, 10 ones make a ten, 10 tens make a hundred, 10 hundreds make a thousand, and so on. A whole divided into 10 equal parts results in tenths, a tenth divided into 10 equal parts results in hundredths, and so on. Every place in the number system is related to others by powers of ten that increase in value from right to left; that is to say, any place value position represents a value ten times greater than the place value position immediately to its right. This relationship exists with both decimals and whole numbers. The base ten structure is also used to distinguish among metric units of measurement. Also called the *decimal number system*. See also **place value**.

basic facts

See **math facts**.

bead string

A string with movable beads that are grouped by colour, such as ten white beads, ten red beads, then ten more white beads, ten more red beads, and so on. A bead string is used for counting and representing and for showing relationships between numbers.

benchmark

A number or measurement is internalized and used as a reference to help judge other numbers or measurements. For example, the width of the tip of the little finger is a common benchmark for one centimetre.

bias

An emphasis on characteristics that are not typical of an entire population and that may result in misleading conclusions.

binomial

An algebraic expression containing two terms; for example, $3x + 2$. *See also algebraic expression.*

bisector

A line that divides another line or an angle into two equal parts. A line that divides another line in half and intersects that line at a 90° angle is called a *perpendicular bisector*. A line that cuts an angle in half is called an *angle bisector*. *See also angle, perpendicular.*

block-based programming (coding

A way of programming a computer or other device in which executable actions are organized into blocks that can be clicked, dragged, altered, and connected to other blocks. This is sometimes referred to as *visual programming*. *See also text-based programming.*

blueprint plan

A design, plan, or technical drawing that shows how something is to be built. It includes layout and measurements and typically provides a top view of the space, although it can also include side views as needed.

borrowing

Receiving money with an agreement to repay it in future, usually with interest charged. *See also interest.*

broken-line graph

A graph formed by line segments that join points representing the data to illustrate how it is changing over time.

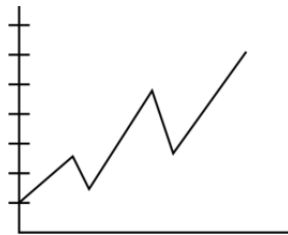

budget

An estimate or plan to manage income and expenses over a set period; for example, many people have a weekly or monthly budget. *See also* **expenses, income**.

cabinet projection

A type of perspective drawing that shows an object “straight on”, with the depth going back at an angle. *See also* **isometric projection, perspective view**.

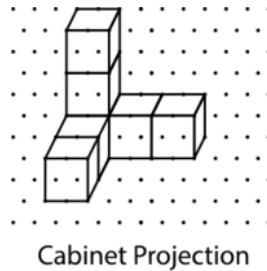

capacity

The greatest amount that a container can hold; usually measured in litres or millilitres.

cardinal directions

The four main points of the compass: north, east, south, and west.

cardinal number

A number that describes the count for a set of objects and answers the question “how many?” For example, if there are three items in a set, the cardinal number is 3. If there are seven items in the set, the cardinal number is 7. *See also* **ordinal number**.

Carroll diagram

A two-way chart that displays complementary data sets for two attributes. The vertical columns represent the yes/no data for one attribute, and the horizontal columns represent the yes/no data for the second attribute.

Carroll Diagram

	Mammal	Not a Mammal
Has Four Legs	horse elephant	frog toad
Does Not Have Four Legs	whale seal	duck trout

A Carroll diagram displays yes/no categorical data in a chart form.

Cartesian plane

A plane that contains an x -axis (horizontal) and a y -axis (vertical), which are used to describe the location of a point. Also called *coordinate plane*.

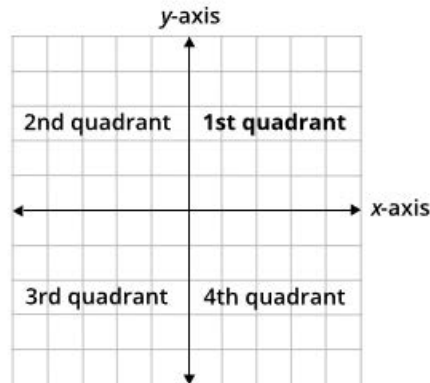

cash transaction

Payment of cash in return for the receipt of goods or services. *See also* **goods and services**.

categorical data

See **qualitative data**.

category

A group of people or things that appear to have certain shared characteristics; for example, people with one pet, or objects that have one straight edge.

census

The collection of data from an entire population.

centre of dilation

A fixed point in the plane about which a two-dimensional shape is dilated. *See also* **dilation**.

centre of rotation

A fixed point in the plane about which a two-dimensional shape is rotated.

cheque

A document that orders a financial institution to pay a specific amount from the issuer's account to the person or organization named on the document.

chequing account

A type of account held at a financial institution that allows for numerous deposits and withdrawals. The money in a chequing account can be accessed using cheques, automated bank machines, or a debit card and can be used for bill payments and money transfers. It usually pays little or no interest. *See also* **savings account**.

circle

A two-dimensional shape with a curved side. All points on the side of a circle are equidistant from its centre. *See also* **two-dimensional shape**.

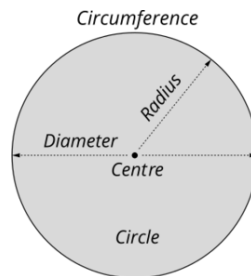

circle graph

A graph in which a circle is used to display data, through the division of the circle proportionally to represent each category. Also called a *pie chart* or *circular diagram*.

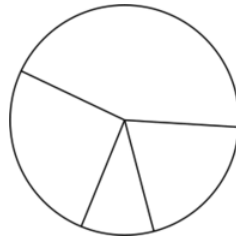

circumference

The distance around a circle; its perimeter. *See also* **circle**.

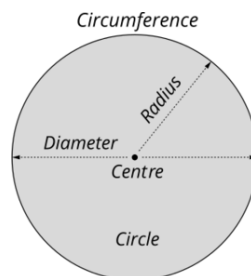

civic awareness

Understanding of the duties and responsibilities of citizens in public space.

clockwise (cw)

The direction an analog clock's hands move. *See also* **counterclockwise**.

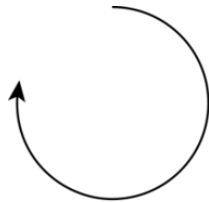
**code**

An instruction or set of instructions that can be executed by a computer or other device. *See also* **execute**.

coding

The process of writing computer programming instructions.

combinations problem

A problem that involves determining the number of possible pairings or combinations between two sets. The following are the six possible outfit combinations, given three shirts – red, yellow, and green – and two pairs of pants – blue and black:

- red shirt and blue pants
- red shirt and black pants
- yellow shirt and blue pants
- yellow shirt and black pants
- green shirt and blue pants
- green shirt and black pants

combining

The act or process of joining quantities. Addition involves combining equal or unequal quantities. Multiplication involves joining groups of equal quantities.

commutative property

A property of addition and multiplication that allows the numbers to be added or multiplied in any order, without affecting the sum or product of the operation. For example, $2 + 3 = 3 + 2$ and $2 \times 3 = 3 \times 2$. In general, $a + b = b + a$ and $a \times b = b \times a$. Using the commutative property can simplify computation. This property does not generally hold for subtraction or division. *See also* **associative property, distributive property.**

comparative bar graph

See **multiple bar graph.**

compare

To note the similarities or differences between numbers or objects. For example, when comparing two numbers, one might consider which of the two represents the larger value.

comparison model

A representation, used in subtraction, in which two sets of items or quantities are set side by side and the difference between them is determined.

compass

In mathematics, a tool used for drawing arcs and circles.

compatible numbers

Numbers that are easy to compute mentally and can be used to estimate or calculate an answer. Also called “friendly” numbers. *See also* **estimation strategies.**

compensation

A mental mathematics strategy in which part of the value of one number is given to another number to make computation easier. For example, $26 + 99$ can be thought of as $25 + 100$; that is, 1 from the 26 is transferred to the 99 to make 100. Compensation sometimes takes place at the end of the computation. For example, $26 + 99$ can be thought of as $26 + 100 = 126$; and since 1 too many was added, take 1 away to get 125.

complementary angles

Two angles whose sum is 90° . *See also* **angle.**

complementary data sets

Two subsets of data that have no overlap but that when combined create a complete data set. For example, the set of people with one or more pets and the set of people who do not have a pet are complementary data sets. *See also* **Carroll diagram**.

complementary events

In probability, two mutually exclusive events that together account for all possible outcomes of an experiment – the complement of any event “A” is the event “not A”. For example, rolling an even number and rolling an odd number using a number cube are complementary events. The sum of the probabilities of complementary events is 1.

compose

Order or arrange parts to form a whole. In geometry, two-dimensional shapes and three-dimensional objects can compose larger shapes and objects. *See also* **decompose, three-dimensional object, two-dimensional shape**.

composite number

A number that has factors in addition to itself and 1. For example, the number 8 has four factors: 1, 2, 4, and 8. *See also* **factor, prime number**.

composite polygon

A polygon comprising two or more basic polygons. *See also* **polygon**.

composition of numbers

The putting together of numbers (e.g., 2 tens and 6 ones can be composed to make 26). *See also* **decomposition of numbers, recomposition of numbers**.

compound interest

Interest paid on the principal amount of a loan or deposit plus any previously accumulated interest. Compound interest is often referred to as “interest on interest”. Given the complicated formula needed to determine compound interest, it is often calculated using a digital tool. For example, an investment of \$5000 with an annual interest rate of 5% might be compounded monthly over 10 years, resulting in a balance of \$8235.05. *See also* **simple interest**.

computational modelling

Using a computer program to create a model of a complex system in order to study its behaviour. This can involve a combination of mathematics, statistics, physics, and computer science.

computational representations

Representations or models of mathematical situations that use computing concepts and tools to find solutions to problems, automate tasks, visualize data, or simulate events.

computational strategies

Any of a variety of methods used for performing computations; for example, estimation, mental calculation, flexible and standard algorithms, and the use of technology (including calculators and spreadsheet programs on computer).

computational thinking

The thought process involved in expressing problems in such a way that their solutions can be reached using computational steps and algorithms. *See also* **algorithm**.

conceptual understanding

The ability to use knowledge flexibly and to make connections between mathematical ideas. These connections are constructed mentally by the learner and can be applied appropriately, and with understanding, in various contexts. *See also* **procedural knowledge**.

concrete graph

A graph on which real objects are used to represent pieces of information; for example, stacking blocks could be used to represent cars, and paper squares could be used to represent animals.

concrete materials

Objects that students handle and use in constructing or demonstrating their understanding of mathematical concepts and skills. Some examples of concrete materials are base ten blocks, connecting cubes, construction kits, number cubes, games, geoboards, geometric solids, measuring tapes, Miras, pattern blocks, spinners, and tiles. Also called *manipulatives*.

concrete pattern

A pattern that is represented by concrete materials (e.g., pattern blocks, interlocking cubes, colour tiles). *See also* **pattern**.

concrete representation

The use of concrete materials to model a mathematical concept or situation.

concurrent events (coding)

Two or more events that occur at the same time. *See also* **sequential events (coding)**.

conditional statement (coding)

A type of coding instruction used to compare values and express and make decisions. A conditional statement tells a program to execute an action depending on whether a condition is true or false. It is often represented as an *if-then* or *if-then-else* statement.

cone

A three-dimensional object with a circular base and a curved surface that tapers proportionally to an apex. *See also* **three-dimensional object**.

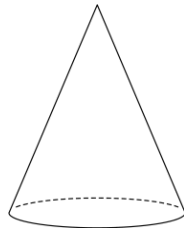
**congruent**

Having the same size and shape. For example, in two congruent triangles, the three corresponding pairs of sides and the three corresponding pairs of angles are equal.

conjecture

A guess or prediction, based on observed patterns, that has not been proven to be either true or false.

connecting cubes

Coloured plastic cubes that connect on one side or on all sides. Connecting cubes are useful for counting by ones and tens; estimating; grouping; modelling the operations, math facts, number

relationships such as greater than or less than, and problem scenarios; patterning; exploring probability, volume, and surface area; and building concrete bar graphs.

constant

A part of an expression that does not change. For example, in the expression $1 + m$, the number 1 is a constant and the letter m is a variable. *See also* **expression, variable**.

constant difference

In subtraction, the property that states that the same quantity can be added to (or subtracted from) each number in a subtraction computation without affecting the answer (difference). This property can be used to simplify subtraction computations. For example, $1001 - 398$ is often regarded as a difficult subtraction computation because it involves regrouping across zeros. However, if 2 is added to each number in the computation, the answer (difference) will be the same, but the computation is much simpler: $1003 - 400 = 603$, so $1001 - 398 = 603$.

constant rate

A rate of change that remains the same and does not go up or down. In the example below, the cost is \$12 each month, which represents a constant rate. *See also* **variable**.

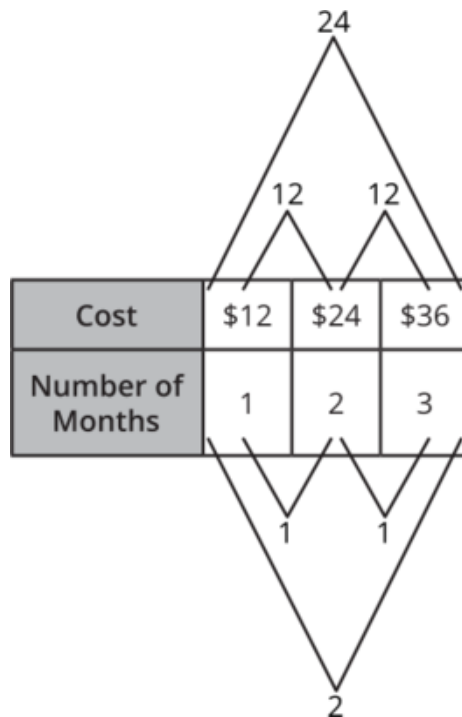

consumer awareness

An understanding of important information about products, goods, services, and related consumer rights, in order to make wise decisions about spending. For example, when buying a car, consumers research the typical resale price and safety history of the make or model they are considering.

consumer contract

Agreement between a supplier and a consumer whereby the supplier agrees to provide goods or services in exchange for payment.

context

The environment, situation, or setting in which an event or activity takes place. Real-life contexts often support students in making sense of mathematics and understanding its relevance.

continuous data

A form of quantitative data. Continuous data is data that can be measured but not counted, such as time, height, and mass. *See also* **quantitative data**.

continuous-line graph

A graph that consists of an unbroken line, in which both axes represent continuous quantities, such as distance and time.

control structure (coding)

A line or block of code that influences the order in which other code is executed. Control structures affect the flow of the program and include sequencing lines of code, repeating lines of code (loops), or selection to execute or not execute specific lines of code (conditional statements). Sequence, repetition, and selection are all control structures. *See also* **execute**.

conventions

Agreed-upon rules or symbols that make the communication of mathematical ideas easier.

converting

Changing.

coordinate system

A system that identifies the points where the lines on a grid intersect. *See also* **coordinates**.

coordinates

An ordered pair used to describe location on a grid or plane. For example, the coordinates (3, 5) describe a location found by moving 3 units to the right and 5 units up from the origin, (0, 0). *See also* **grid, ordered pair**.

core

See **pattern core**.

correlation

The relationship between two variables. For example, if two variables are strongly linked (e.g., size and mass), they have a high correlation.

count

Recite a sequence of numbers in the correct order without referring to objects or quantities.

counterclockwise (ccw)

The opposite direction to the way the hands of an analog clock move. *See also* **clockwise**.

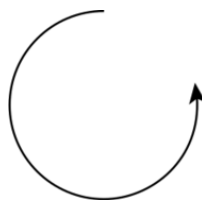
**counting**

The process of determining the total number in a set.

counting all

A strategy for addition in which the student counts every item in two or more sets to find the total. *See also* **counting on**.

counting back

Counting from a larger to a smaller number. The starting number is the largest number in the set and each subsequent number is less in quantity. If a student counts back by 1s from 10 to 1, the sequence of numbers is 10, 9, 8, 7, 6, 5, 4, 3, 2, 1. Young students often use counting back as a strategy for subtraction (e.g., to find $22 - 4$, the student counts “21, 20, 19, 18”).

counting frame

A frame that has moveable beads that are strung on wires. Used for counting, representing, and showing relationships between numbers.

counting on

A strategy for addition in which the student starts with the number of the known quantity, and then continues counting the items in the unknown quantity. To be efficient, students should count on from the larger addend. For example, to find $2 + 7$, they should begin with 7 and then count “8” and “9”. *See also* **counting all**.

counting principles

Concepts that students learn as they gain an understanding of counting; for example, stable order, cardinality, and one-to-one correspondence.

credit

A customer’s ability to obtain goods or services before paying for them, with the agreement that the customer will pay the amount owed in the future. *See also* **debt**.

credit card

A plastic card issued by a financial institution that allows a cardholder to obtain funds with which to pay for goods and services. Cardholders must pay back the money borrowed plus interest according to set conditions, as well as any additional charges. Credit card companies often offer incentives such as cash back on purchases, rewards points, and airline miles. *See also* **goods and services**.

cryptocurrency

A type of currency that exists only in digital or virtual form. It is secured by a mathematical encryption process that makes it nearly impossible to counterfeit or use fraudulently. Bitcoin is one of the earliest and most well-known cryptocurrencies.

cube

A right rectangle-based prism with six congruent square faces. A cube is one of the Platonic solids. Also called *hexahedron*. *See also* **congruent, face, prism, square**.

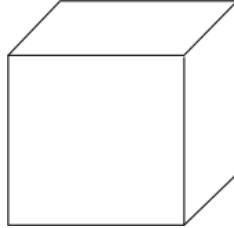

cubic centimetre (cm³)

A metric unit of measurement for volume; one cubic centimetre of volume is equal to one millilitre of capacity.

currency

A system of money in use in a given country, typically including coins and bills. Examples include the dollar in Canada and the euro in many European countries.

curve of best fit

The curve that best describes the distribution of points in a scatter plot.

cyclic pattern

See **repeating pattern**.

cylinder

A three-dimensional object with two congruent, parallel bases, joined by parallel lines called elements. Cylinders can have polygons, curved figures, or a combination of the two as bases. Prisms are a special kind of cylinder that have only polygons as faces. *See also* **circle, congruent, face, parallel, prism**.

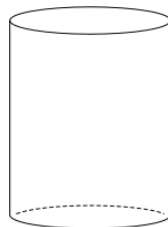

dart

A concave kite. It has two pairs of equal-length sides that are adjacent to each other, with one interior angle that is greater than 180° . *See also* **kite**.

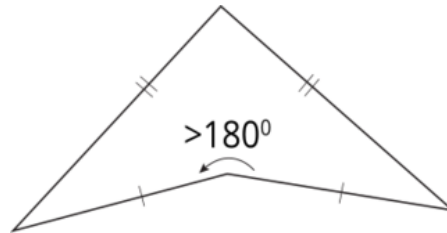
**data**

See **qualitative data**, **quantitative data**.

data literacy

The ability to understand, organize, and evaluate data and to communicate its meaning in various ways.

data set

A collection of related data (e.g., survey results collected to answer a question of interest). Also called a *set of data*. *See also* **question of interest**.

data visualization

A graphic representation of data, such as a chart or a map, intended to help the user interpret patterns and trends within the data.

database

An organized and sorted list of data; usually generated by a computer.

debit card

A plastic card that the cardholder can use to pay for purchases. When the card is used, the purchase amount is deducted directly from the cardholder's chequing account.

debt

Money that is owed; the state of being required to pay back money owed (in debt).

debugging (coding)

The process of finding and fixing errors (known as “bugs”) in a computer program.

decametre

A metric unit of length; one decametre is equal to ten metres.

decimal number

A number that has a decimal point, such as 3.75. The part before the decimal point represents a whole number amount, and the part after the decimal point represents a value that is less than one.

decompose

Separate a whole into parts. In geometry, two-dimensional shapes and three-dimensional objects can be decomposed into smaller shapes and objects. *See also* **compose, three-dimensional object, two-dimensional shape.**

decomposition of numbers

The taking apart of numbers into two or more parts. For example, the number 13 is usually taken apart as 10 and 3 but can be taken apart as 6 and 7, or 6 and 6 and 1, and so forth. Students who can decompose numbers and see the relationship between a whole number and its parts develop computational fluency and have many strategies available for solving arithmetic questions mentally. *See also* **composition of numbers, flexible algorithm, recomposition of numbers.**

deductive reasoning

The process of reaching a conclusion by applying arguments that have already been proven and using evidence that is known to be true. *See also* **inductive reasoning, inference.**

defined count (coding)

In coding, the number of times instructions are repeated based on a predefined value or until a condition has been met.

degree

A unit for measuring angles. For example, one full revolution measures 360° and a right angle measures 90°. *See also* **angle, right angle.**

denominator

The number of equal parts into which a whole or set is divided. The denominator is represented by the number below the line in a fraction; for example, in $\frac{3}{4}$, the denominator is 4. It could mean 4 equal parts, 4 objects in a set, or 3 divided by 4. It is also a name for the divisor of a division sentence. *See also* **division, numerator**.

dependent events

Two events are dependent if the outcome of the first affects the outcome of the second. For example, each time a card is drawn from a deck without being replaced, the probability of selecting a specific card, such as an ace, changes. *See also* **event, independent events**.

dependent variable

A variable whose value depends on the value of another variable. For example, in the expression $b = 2 + d$, b is the dependent variable because its value depends on what d is. In graphing, the dependent variable is usually represented on the vertical axis of a Cartesian plane. *See also* **independent variable, variable**.

derived fact

A math fact to which the student finds the answer by using a fact that they already know. For example, a student who does not know the answer to 6×7 might know that 3×7 is 21 and then double 21 to get 42. *See also* **known fact, math facts**.

diagonal

A line segment joining two vertices of a polygon that are not next to each other (i.e., that are not joined by a side). *See also* **polygon, vertex**.

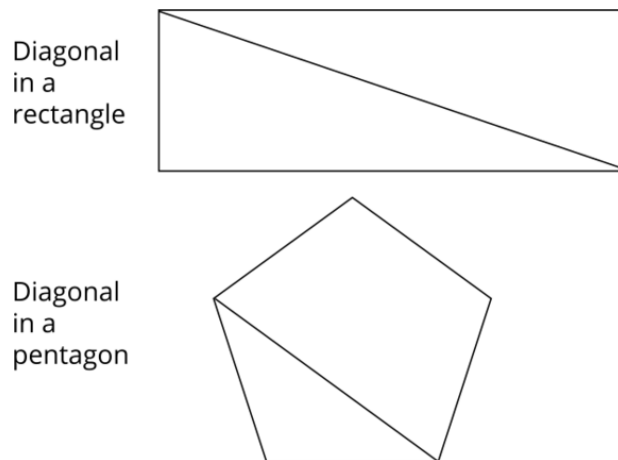

diagonals, properties of

Descriptions of how the diagonals of a polygon behave. Properties of diagonals include the lengths of the diagonals (are they equal or not?), the angles at which the diagonals cross (are they perpendicular or not?), and the point at which the diagonals cross (do they cross at the midpoint or not?). Polygons can be defined by the properties of their diagonals. *See also diagonal, polygon.*

diameter

A line segment that joins two points on a circle and passes through the centre. *See also circle, radius.*

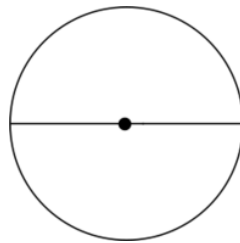

difference

The result of a subtraction problem or the quantifiable distance between two numbers.

digital clock

A type of clock that shows the time using changing digits rather than through the angle of hands on a dial, as an analog clock does. *See also analog clock.*

dilation

A transformation that enlarges or reduces a shape by a scale factor to form a similar shape. Also called a *dilatation*. *See also enlargement, reduction, scale factor, transformation.*

direct variation

A relationship between two variables in which one variable is a constant multiple of the other. *See also variable.*

discrete data

A form of quantitative data. Discrete data is data that can be counted, such as the number of pets, the number of siblings, or the number of buttons. *See also quantitative data.*

distance

The amount of linear space between two points. For example, one might measure the distance between the two sides of a window in order to select the right size of curtain to fit it. *See also linear dimension.*

distribution

An arrangement of data with related frequencies. The distribution of data is often shown visually in graphs and charts, such as bar graphs and histograms. *See also frequency.*

distributive property

The property that allows a number in a multiplication expression to be decomposed into two or more numbers; for example, $51 \times 12 = 51 \times 10 + 51 \times 2$. More formally, the distributive property holds that, for three numbers, a , b , and c , $a \times (b + c) = (a \times b) + (a \times c)$ and $a \times (b - c) = (a \times b) - (a \times c)$; for example, $2 \times (4 + 1) = 2 \times 4 + 2 \times 1$ and $2 \times (4 - 1) = 2 \times 4 - 2 \times 1$. Multiplication is said to be distributed over addition and subtraction.

divisibility rule

A way to determine whether one whole number is divisible by another without doing the division. The divisibility rules are generally considered to be following:

- A number is divisible by 2 if the last digit is even (0, 2, 4, 6, or 8).
- A number is divisible by 3 if the sum of the digits is divisible by 3.
- A number is divisible by 4 if the last two digits form a number divisible by 4.
- A number is divisible by 5 if the last digit is 0 or 5.
- A number is divisible by 6 if the number is divisible by both 2 and 3.
- A number is divisible by 8 if the last three digits form a number divisible by 8.
- A number is divisible by 9 if the sum of the digits is divisible by 9.
- A number is divisible by 10 if the last digit is a 0.

division

The operation characterized by the equal sharing of a quantity into a known number of groups (partitive division), or by the repeated subtraction of an equal number of items from the whole quantity (quotative division). Division is the inverse operation of multiplication. The quantity to be divided is called the *dividend*. The dividend is divided by is the *divisor*. The *quotient* is the result of a division problem. The *remainder* is the number “left over”, which cannot be grouped or shared equally. For example:

$$\begin{array}{ccccccc} 67 & \div & 6 & = & 11 & R & 1 \\ \text{dividend} & & \text{divisor} & & \text{quotient} & \text{remainder} & \end{array}$$

See also **partitive division**, **quotative division**, **repeated subtraction**.

divisor

See **division**.

donating

Giving a gift for charity, humanitarian aid, or to help a cause. Types of donations include money, services, and goods such as clothing, toys, and food.

dot plates

Paper plates with peel-off dots applied in various arrangements to represent numbers from 1 to 10. Dot plates are useful in pattern-recognition activities.

double bar graph

See **multiple-bar graph**.

double number line

A visual model used to represent the equivalencies between two quantities. For example, the illustration below shows a double line with the numbers 0, 1, 2, 3, and 4 on the top line and the numbers 0, 5, 10, 15, and 20 arranged on the bottom line. The numbers on the bottom are five times greater than the numbers on the top line. See also **number line**.

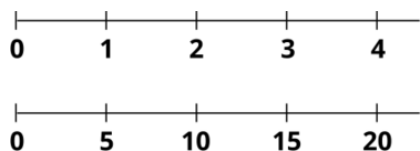

doubles

Basic addition facts in which both addends are the same number (e.g., $4 + 4$, $8 + 8$). Students can apply a knowledge of doubles to learn other addition facts (e.g., if $6 + 6 = 12$, then $6 + 7 = 13$) and multiplication facts (e.g., if $7 + 7 = 14$, then $2 \times 7 = 14$).

drawing

A diagram sketched by hand (or using a computer graphics program) to show mathematical thinking.

drill

Practice that involves repetition of a skill or procedure. Because drill often improves speed but not understanding, it is important that conceptual understanding be developed before drill activities are undertaken. *See also* **automaticity, conceptual understanding.**

dynamic statistical program

A computer program that allows the user to gather, explore, and analyse data through dynamic dragging and animations. Uses of the program include organizing data from existing tables or the Internet, making different types of graphs, and determining measures of central tendency. *See also* **measure of central tendency.**

earning

Obtaining money in return for labour or services. *See also* **income.**

edge

The intersection of a pair of faces on a three-dimensional object. *See also* **face, three-dimensional object.**

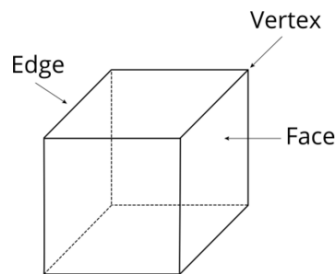

efficient code (coding)

Code that uses the lowest number of instructions to accomplish a task, thereby minimizing storage space and execution time.

elapsed time

A measurement of the amount of time that passes during an event. *See also* **unit of time.**

element

A specific item (e.g., object, shape, number) in a pattern. The elements in the following pattern are a circle and a square. *See also* **pattern.**



enlargement

A transformation that enlarges a shape by a scale factor to form a similar shape. *See also* **dilation, reduction, scale factor, transformation.**

equal sign

The mathematical symbol (=) used to indicate equality. The expression on the left of the equal sign is equivalent to the expression on the right (e.g., $3 + 1 = 2 + 2$). *See also* **equation, expression.**

equal-group problem

A problem that involves sets of equal quantities. If both the number and the size of the groups are known, but the total is unknown, the problem can be solved using multiplication. For example, there are four tricycles. How many wheels are there in total? ($4 \times 3 = ?$) If the total in an equal-group problem is known, but either the number of groups or the size of the groups is unknown, the problem can be solved using division. For example, there are 12 wheels in all. How many tricycles are there? Also called *fair-share problem*.

equality

The state of being equal. An equality can be represented by an equation (e.g., $4 + 5 = 6 + 3$). *See also* **equation, inequality.**

equation

A mathematical statement that has equivalent expressions on either side of an equal sign. *See also* **equal sign, expression.**

equilateral triangle

A triangle with three equal sides and three equal angles. *See also* **triangle.**

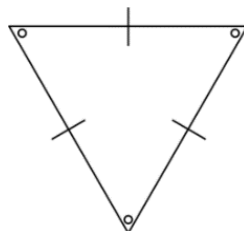

equivalence

The state of being equal or equivalent in value.

equivalent

Having the same value or amount.

equivalent fractions

Different representations in fractional notation of the same part of a whole or group; for example, $\frac{1}{3}$, $\frac{2}{6}$, $\frac{3}{9}$, $\frac{4}{12}$.

estimate

Roughly calculate, or make a reasonable guess.

estimation

The process of arriving at an approximate answer for a computation, or at a reasonable guess with respect to a measurement. *See also estimation strategies.*

estimation strategies

Mental mathematics strategies used to obtain an approximate answer. Students estimate when an exact answer is not required and when they are checking the reasonableness of their mathematics work. Some estimation strategies are as follows:

- **clustering.** A strategy used for estimating the sum of numbers that cluster around one particular value. For example, the numbers 42, 47, 56, and 55 cluster around 50. So, the estimate is $50 + 50 + 50 + 50 = 200$.
- **compatible numbers.** A strategy that involves using numbers that are easy to work with. For example, to estimate the sum of 28, 67, 48, and 56, one could add $30 + 70 + 50 + 60$. These nice numbers are close to the original numbers and can be easily added.
- **front-end estimation.** (Also called *front-end loading*.) A strategy that involves the addition of significant digits (those with the highest place value), with an adjustment of the remaining values. For example:

Step 1 – Add the left-most digit in each number.

$$193 + 428 + 253$$

$$\text{Think } 100 + 400 + 200 = 700.$$

Step 2 – Adjust the estimate to reflect the size of the remaining digits.

$$93 + 28 + 53$$

$$\text{Think } 100 + 25 + 50 = 175.$$

Think $700 + 175 = 875$.

See also **estimation**.

e-Transfer

A banking service that allows clients to send and receive funds between their personal account and someone else's, using email and their online banking service.

evaluate

To determine a value for.

even number

A number that is divisible by 2 and that ends with 0, 2, 4, 6, or 8. *See also* **odd number**.

event

In probability, an event is the outcome of a specific incident or situation being tracked in an experiment, such as rolling a six or rolling an even number on a number cube. *See also* **outcome (probability)**, **probability experiment**.

exchange rate

The value of a country's currency in terms of another country's currency. For example, an exchange rate of 0.73 Canadian dollars to US dollars means that 100 Canadian dollars could be exchanged for 73 US dollars, or 73 US dollars could be exchanged for 100 Canadian dollars.

execute (coding)

To run code or a computer program. *See also* **code**.

expanded form

A way of writing numbers that shows the value of each digit; for example, $432 = 4 \times 100 + 3 \times 10 + 2$. *See also* **place value**.

expenses

Things that one spends money on; for example, most adults' expenses include food, shelter, utilities, and entertainment.

experimental probability

The measurement of the likelihood of an event happening, based on performing an experiment. Also called *empirical probability*. See also **theoretical probability**.

exponent

See **exponential notation**.

exponential notation

A representation of a product in which a number called the *base* is multiplied by itself. The *exponent* is the number of times the base appears in the product. For example, 5^4 is in exponential notation, where 5 is the base and 4 is the exponent; 5^4 means $5 \times 5 \times 5 \times 5$. See also **product**.

expression

A numeric or algebraic representation of a quantity. An expression may include numbers, variables, and operations; for example, $3 + 7$, $2x - 1$.

exterior angle

The angle between a side of a shape and a line that extends outward from an adjacent side. In the image below, the external angle is 120° . See also **angle**, **interior angle**.

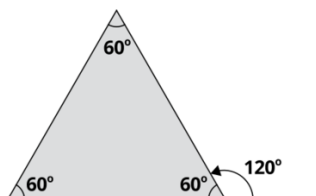

extrapolate

To estimate values lying outside the range of given data. For example, to extrapolate from a graph means to estimate coordinates of points beyond those that are plotted. See also **interpolate**.

face

A flat surface of a three-dimensional object. *See also* **three-dimensional object**.

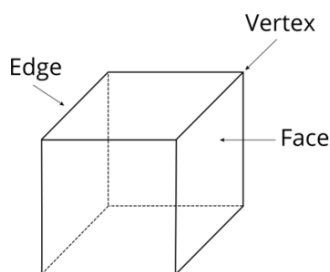

fact family

A group of math facts or equations that use the same set of numbers. For example, using 10, 14, and 4, the following fact family can be created: $10 + 4 = 14$, $4 + 10 = 14$, $14 - 4 = 10$, $14 - 10 = 4$. *See also* **math facts**.

factor

Natural numbers that divide evenly into a given natural number. For example, the factors of 12 are 1, 2, 3, 4, 6, and 12, because all of these numbers divide evenly into 12. *See also* **multiplication**.

factor tree

A diagram drawn to find the factors of a natural number. The chosen number is drawn with two branches leading to any two of its factors. Each of these factors will then be drawn with two branches leading to two of their factors. This process is continuing until no more factors can be found. *See also* **factor**, **natural numbers**.

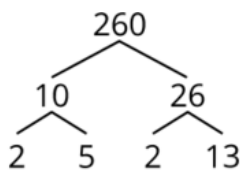

2, 5, 10, 13 and 26
are the factors of 260

fair-share problem

A situation in which a whole is distributed equally among a known number of groups or people. For example, Mark has 12 apples. He wants to share them among 4 friends so that each gets the same number of apples – 3 apples. Also called *equal-share problem*.

far prediction

A determination of a value, an element, or a term in a pattern that is well beyond the portion of the pattern that is provided; for example, a statement about the hundredth term of a pattern when given only the first ten terms. *See also near prediction, pattern.*

fees

Amounts that financial institutions may charge their customers for account set-up and maintenance activities, and minor transactions. Fees may be monthly, annual, semi-annual, quarterly, or per transaction. Examples include monthly charges for some bank accounts, and per-transaction charges such as those for using an automated bank machine.

Fibonacci sequence

A series of numbers in which the first two numbers are 0 and 1, and each following number is the sum of the two numbers before it, as follows: 0, 1, 1, 2, 3, 5, 8, 13, 21, 34,

finances

The money and monetary affairs of a person, business or organization, or country.

financial decision making

Weighing the pros and cons of one's choices about the use of money – for example, about saving, spending, investing, and donating.

financial goal

An objective that a person sets that affects how they spend and save money. Objectives can be short term, such as buying a pair of sneakers, or long term, such as attending university.

financial institution

A company that provides and manages monetary transactions such as deposits, loans, currency exchanges, and investments. For example, central banks, retail and commercial banks, internet banks, credit unions, savings and loan associations, investment banks and companies, brokerage firms, and insurance companies.

financial plan

A written plan that identifies financial goals and outlines specific actions needed to achieve them.

financial well-being

The extent to which a person can comfortably meet all of their current financial commitments (expenses) and needs while also having the financial resilience to continue doing so in the future. It is not only about income. It is about having control over personal finances, being able to absorb a financial setback, being on track to meet financial goals, and being able to make choices that allow a person to enjoy life. (Adapted from Financial Consumer Agency of Canada, “Financial Well-Being in Canada: Survey Results”.)

first quadrant of a Cartesian plane

In the Cartesian plane, the quadrant that contains all the points with both positive x -coordinates and positive y -coordinates. *See also* **Cartesian plane**.

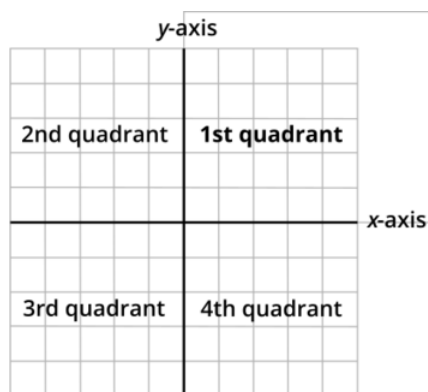

first-degree equation

An algebraic equation in which all variables have the exponent 1; for example, $5(3x - 1) + 6 = -20 + 7x + 5$. Exponents of 1 are never indicated and are assumed. *See also* **algebraic expression, equation**.

first-degree polynomial

A polynomial expression in which all variables have the exponent 1; for example, $4x + 20$. Exponents of 1 are never indicated and are assumed. *See also* **variable**.

five frame

A 1 by 5 array onto which counters or dots are placed, to help students relate a given number to 5 (e.g., 7 is 2 more than 5) and recognize the importance of 5 as an anchor in our number system. *See also* **ten frame**.

flexible algorithm

A non-standard algorithm devised by a person performing a mental calculation, often by decomposing and recomposing numbers. For example, to add 35 and 27, a person might add 35 and 20, and then add 7. Also called a *student-generated algorithm*. See also **algorithm**, **decomposition of numbers**, **recomposition of numbers**.

flip

See **reflection**.

flow chart

A type of diagram that shows the sequence of steps involved in performing an algorithm. In coding, specific symbols are used to indicate different control structures in the algorithm (e.g., an input is written in a parallelogram; a process is written using a rectangle). See also **algorithm**, **coding**, **control structure**, **parallelogram**.

Flow chart used to solve $2a + 5 = 25$

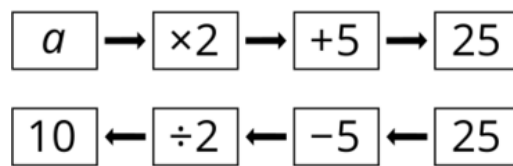

Flow chart to simulate a coin flip:

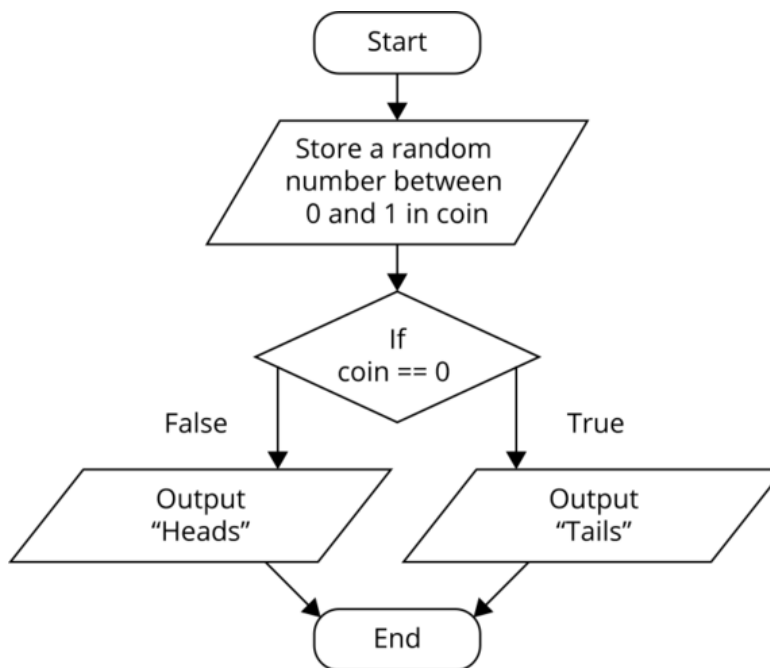

fluency

Proficiency in performing mathematical procedures quickly and accurately. Although computational fluency is a goal, students should also be able to explain how they are performing computations, and why answers make sense. *See also automaticity.*

formula

An equation summarizing a relationship between measurable attributes; for example: *Area of triangle = (base × height) ÷ 2*; *Area of parallelogram = base × height*. *See also attribute.*

fraction

A number that represents a quantity that is not a whole number; for example, $\frac{1}{2}$, $\frac{17}{10}$. A fraction represents a relationship between two quantities. *See also improper fraction, proper fraction.*

fractional amount

A quantity less than 1 or a whole.

fractional notation

A fraction written in the form $\frac{a}{b}$.

frequency

The count of the number of items in a category or the number of times an event or outcome occurs.

frequency table

A table in which data is organized into categories that are listed along with their corresponding frequencies. *See also frequency, relative-frequency table.*

Favourite Sport		
Sport	Tally	Frequency
Hockey	NI I	7
Skiing	IIII	4
Swimming	NI III	8
Basketball	II	2

friendly numbers

See compatible numbers.

function (coding)

A small section of code that performs a single task and returns a value back to the main program. *See also* **code, subprogram**.

functional thinking

A type of thinking that focuses on relationships between two variables. *See also* **recursive thinking, variable**.

Number of Bicycles	Number of Wheels
1	2
2	4
3	6
4	8

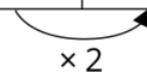

funding

Money that a government or organization provides for a specific purpose. The act of providing resources to finance a need, program, or project.

general term

An algebraic expression that represents any term in a pattern or sequence using the term number as a variable. For example, in the sequence 2, 4, 6, 8, 10, ..., the general term is $2n$. Also called the *n*th term. *See also* **algebraic expression, expression, pattern, variable**.

generalization

The process of determining a general rule or making a conclusion based on the observation of given examples.

generalized prediction

A determination of the *n*th term of a pattern. *See also* **general term, pattern**.

geometric property

An attribute that remains the same for a class of objects or shapes. A geometric property of any parallelogram, for example, is that its opposite sides are equal. *See also* **attribute**.

geometric sequence

A sequence of numbers that have a common ratio, that is, always multiply or divide by the same number, from one term to the next.

geometrically

A way to model patterns using geometric forms such as squares and circles. *See also* **pattern**.

gift card

A plastic or electronic card worth a specific amount of money that can be spent by the recipient at a particular business. Many gift cards will have a minimum (e.g., \$10) and maximum (e.g., \$200) initial loading amount. They are often given as a gift and the value decreases with each use.

giga-

A unit prefix in the metric system denoting a factor of one billion (10^9 or 1 000 000 000).

goods and services

Two different components of everyday business. Goods are products that can be purchased, such as food and clothing. Services are tasks or actions performed by people for payment, such as haircuts.

graph

A visual representation of data. There are many different types of graphs that can be used to show patterns, trends, and relationships in data. *See also* *individual types of graphs*.

graphic representation

A representation of mathematical ideas using graphs. *See also* representation.

graphically

A way to model patterns using a graph. *See also* **pattern**.

greatest common factor

The largest factor that two or more numbers have in common. For example, the greatest common factor of 16 and 24 is 8. *See also* **factor**.

grid

A plane that contains regularly spaced lines that cross one another at right angles to form squares or rectangles.

gross income

An individual's total earnings from pay and/or other sources, before taxes or other deductions. *See also income, net income.*

growing pattern

A pattern that involves a progression (e.g., growth of elements) from term to term (e.g., A, AA, AAA, AAAA). *See also pattern, shrinking pattern.*



guess and check

A strategy for solving math problems that involves making a reasonable guess about the value that will make a statement true, testing the guess to find out whether it is correct, and then adjusting the guess as necessary, perhaps multiple times, to get closer to the solution.

hectometre

A metric unit of length equal to one hundred metres.

heptagon

A polygon with seven sides. *See also polygon.*

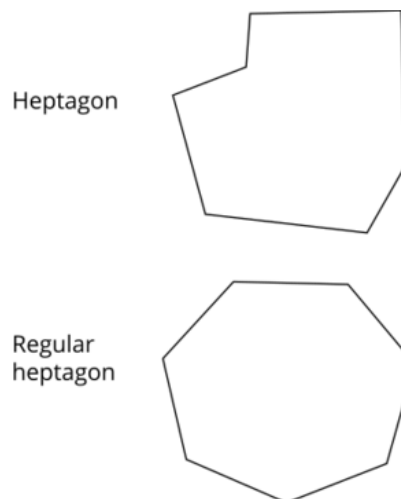

hexagon

A polygon with six sides. *See also* **polygon**.

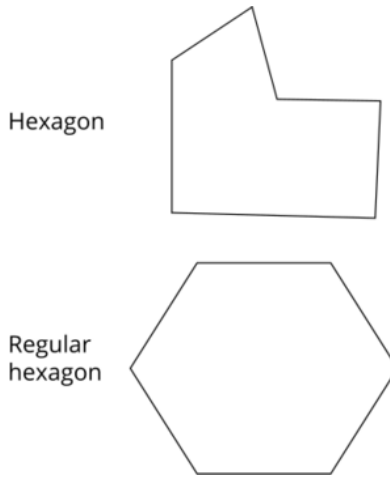

histogram

A type of graph used to display the frequencies of discrete or continuous data that is grouped into equal-sized intervals. For example, data collected for individuals could be shown using intervals of age (e.g., 0 to 9, 10 to 19, 20 to 29, ...). No gaps are left between the bars, to reflect the continuous nature of the data. *See also* **continuous data, discrete data, frequency, interval**.

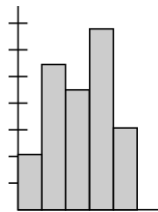

horizontal

Parallel to the horizon, the floor, or the bottom of a page. *See also* **parallel, vertical**.

horizontal format

A left-to-right arrangement of the *addends*, or numbers being added together, often used in presenting computation questions to encourage students to use flexible algorithms (e.g., $23 + 48$). By contrast, a vertical format or arrangement lends itself to the use of standard algorithms. *See also* **flexible algorithm, vertical format**.

$$23 + 48 =$$

Horizontal format

$$\begin{array}{r} 23 \\ + 48 \\ \hline \end{array}$$

Vertical format

hundreds chart

A 10×10 table or chart with each cell containing a natural number from 1 to 100 arranged in order.

hypotenuse

The longest side of a right triangle; the side opposite the right angle. *See also* **Pythagorean theorem, triangle**.

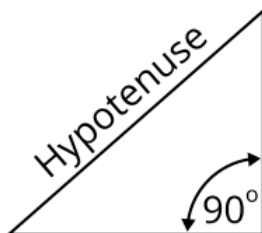

identity

A mathematical statement that is always true; for example, $3 + 5 = 8$ and $x + y = y + x$.

identity property

The identity property occurs when a number is combined with a special number (identity element) by using one of the operations, and the result leaves the original number unchanged. In addition, and subtraction, the identity element is 0; for example, $88 + 0 = 88$ and $56 - 0 = 56$. In multiplication and division, the identity element is 1; for example, $88 \times 1 = 88$ and $56 \div 1 = 56$.

improper fraction

A fraction whose numerator is greater than its denominator; for example, $\frac{12}{5}$. *See also* **denominator, numerator, proper fraction**.

incentive

A reward offered by a company to encourage consumers to buy or use its products or services. *See also* **loyalty program**.

income

Money that an individual receives in exchange for work or by making investments. *See also* **earning**.

independent events

Two or more events that can happen simultaneously without one affecting the outcome of the other(s); for example, rolling a 6 on a number cube *and* drawing a red card from a deck. *See also dependent events, event.*

independent variable

A variable for which values are not dependent on the values of other variables. For example, in the expression $b = 2 + d$, d is the independent variable because its value stands alone. In graphing, the independent variable is usually represented on the horizontal axis of a Cartesian plane. *See also dependent variable.*

inductive reasoning

The process of reaching conclusions based on observations of patterns and applying them to come up with a generalization, or rule. *See also deductive reasoning, inference.*

inequality

The relationship between two expressions or values that are not equal, indicating with a sign whether one is less than ($<$), greater than ($>$), or not equal to (\neq) another; for example, $a < b$ says that a is less than b , $a > b$ says that a is greater than b , and $a \neq b$ says that a is not equal to b . *See also equality.*

inference

A conclusion drawn from any method of reasoning. For example, when comparing two graphs showing the amount of time people spent outdoors during the month of April in two different regions, one might infer that the people living in one region spent less time outdoors because it was more rainy there.

infographic

A visual representation of data that is intended to make the data easy to understand. Infographics may include some combination of charts, diagrams, illustrations, and text, along with graphic design elements.

input (coding)

Information or instructions that are entered into a computer or device; the act of doing so.

integer

Any one of the numbers ..., -4, -3, -2, -1, 0, 1, 2, 3, 4, Integers are the entire set of whole numbers and their opposites (negative numbers).

interest

An amount that a financial institution charges a customer to borrow money (e.g., via a bank loan) or pays a customer to keep money in an account (e.g., an investment account). *See also interest rate.*

interest rate

The proportion of an amount loaned that a lender charges the borrower as interest, usually an annual percentage of the outstanding balance. For example, if a lender charges a one-year loan of \$100 with a 10% interest rate, the borrower would owe \$110 to the lender after 12 months. *See also interest.*

interior angle

An angle inside a shape, between adjacent sides. *See also angle, exterior angle.*

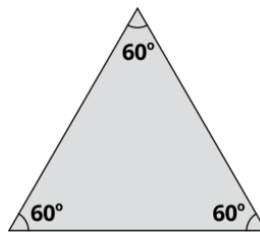

interpolate

To estimate values lying between elements of given data. For example, to interpolate from a graph means to estimate coordinates of points between those that are plotted. *See also extrapolate.*

interval

The set of numbers that exist between two endpoints. For example, ages could be organized into the interval of 0–9, with 0 and 9 being the two endpoints.

inverse operations

Two operations that “undo” or “reverse” each other. For example, for any number, adding 7 and then subtracting 7 gives the original number. The subtraction undoes or reverses the addition.

inverse relationship

A relationship of opposites, in which one action causes the opposite effect of the other. Addition and subtraction are inversely related because they cause opposite effects; for example, the inverse of adding 3 is subtracting 3.

investing

Purchasing something that is expected to make a profit or produce income; for example, purchasing real estate, buying stocks and bonds, and saving money in interest-bearing accounts. *See also* **interest, investment**.

investment

A monetary asset purchased with the expectation that it will produce income or will be sold at a higher price for a profit in the future. Investments can include stocks, bonds, interest-bearing accounts, and real estate. *See also* **investing, profit**.

irrational number

A number that cannot be represented as a terminating or repeating decimal; for example, $\sqrt{5}$, π . *See also* **repeating decimal, terminating decimal**.

irregular shape

A shape whose side or angle measures are not equal.

isometric dot paper

Dot paper used for creating perspective drawings of three-dimensional objects. The dots are formed by the vertices of equilateral triangles. Also called *triangular dot paper* or *triangle dot paper*.

isometric projection

A type of perspective drawing that shows an object from a "corner view", with the width and depth going off at equal angles. *See also* **cabinet projection, perspective view**.

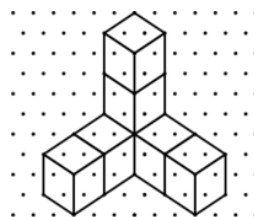

Isometric Projection

isosceles trapezoid

A trapezoid that has two sides of equal length. *See also* **trapezoid**.

isosceles triangle

A triangle that has two sides of equal length. *See also* **triangle**.

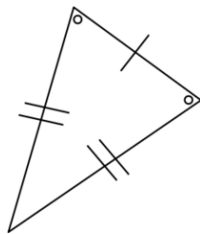

iterate

To repeat a mathematical or computational operation or movement again and again until a desired result or condition is attained.

kite

A quadrilateral that is not a parallelogram but has two pairs of equal-length sides that are adjacent to each other. *See also* **parallelogram, quadrilateral**.

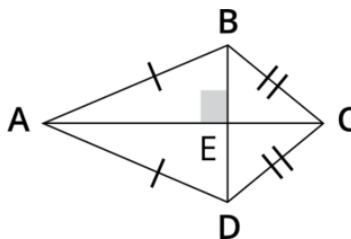

known fact

A math fact that a student readily knows and understands. *See also* **derived fact, math fact**.

legs of a triangle

The two shorter sides of a right triangle. *See also* **hypotenuse, Pythagorean theorem**.

lending

Giving money to a person or business with the expectation that it will be repaid. Lenders may provide funds for mortgages, automobile loans, small business loans, and so on, and may charge interest. *See also* **borrowing, interest, loan**.

likelihood

The chance of something happening. The likelihood of an event can be described using terms such as “impossible”, “likely” or “certain”, or represented using fractions, decimals, or percents.

line

A geometric figure that has no thickness whose length goes on infinitely in both directions.

line of best fit

The line that best describes the distribution of points in a scatter plot.

line of credit

An amount of money that a financial institution agrees to lend to an individual or business. The borrower can draw from the line of credit as needed, up to the agreed-upon amount. Interest must be paid on the amount borrowed. *See also* **borrowing, interest, lending, loan.**

line of reflection

A line that acts as a mirror in the form of a perpendicular bisector so that corresponding points are the same distance from the line. *See also* **bisector, line, perpendicular.**

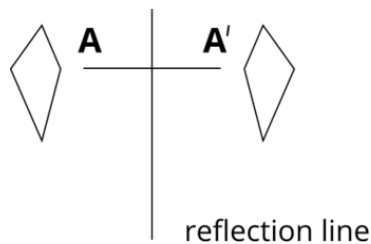

line of symmetry

See **line symmetry.**

line plot

A graph that shows a mark (usually an “X”) above a value on the number line for each entry in the data set.

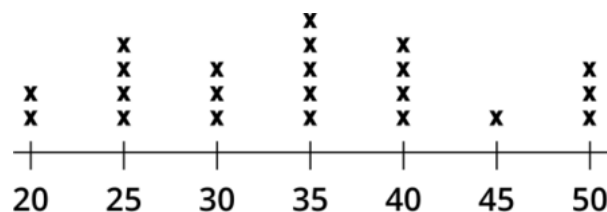

line segment

The part of a line between two points on the line.



line symmetry

A two-dimensional shape has line symmetry if the shape can be divided into two congruent parts that can be matched by folding along a line, known as the *line of symmetry*. *See also congruent, two-dimensional shape.*

linear dimension

A measurement of one linear attribute, that is, distance, length, width, height, or depth. *See also attribute.*

linear equation

An algebraic representation of a linear relationship. The relationship involves one or more first-degree variable terms; for example, $y = 2x - 1$, $2x + 3y = 5$, $y = 3$. The graph of a linear equation is a straight line.

linear pattern

A pattern that increases (grows) or decreases (shrinks) by some value that always remains the same. It has two components: a constant and a multiplier.

loan

An amount of money that is borrowed with the expectation that it will be paid back, usually with interest. *See also borrowing, interest, lending.*

logic diagrams

A graphic organizer showing relationships between sets or groups of objects.

loop (coding)

A computer programming control structure that allows for a sequence of instructions to be repeated while, or until, a condition is met.

lowest common multiple

The smallest number that two numbers can divide into evenly. For example, 30 is the lowest common multiple of 10 and 15.

loyalty program

An incentive program that rewards loyal consumers; they typically receive either a discount on purchases or points that can be used for future purchases. Also called *rewards program*. See also **credit card**.

magnitude

The size of a number or a quantity, which can be thought of as its distance from zero. For example, the magnitude of +9 is 9 and the magnitude of -9 is also 9.

making tens

A strategy by which numbers are combined to make groups of 10. Students can show that 24 is the same as two groups of 10 plus 4 by placing 24 counters on ten frames. Making tens is a helpful strategy in learning addition facts. For example, if a student knows that $7 + 3 = 10$, then the student can surmise that $7 + 5$ equals 2 more than 10, or 12. As well, making tens is a useful strategy for adding a series of numbers (e.g., in adding $4 + 7 + 6 + 2 + 3$, find combinations of 10 first [$4 + 6$, $7 + 3$] and then add any remaining numbers).

manipulatives

See **concrete materials**.

many-to-one correspondence

The correspondence of more than one object to a single symbol or picture. For example, on a pictograph, five cars can be represented by one sticker. See also **one-to-one correspondence**.

mass

The amount of matter in an object; usually measured in grams or kilograms.

math facts

The single-digit addition and multiplication computations (i.e., up to $9 + 9$ and 9×9) and their related subtraction and division facts. Students who know these facts and know how they are derived are more likely to have computational fluency than students who have learned these facts by rote/memorization. Also called *basic facts* and *number facts*. See also **fluency**.

mathematical communication

The process through which mathematical thinking is shared. Students communicate by talking, drawing pictures, drawing diagrams, writing journals, charting, dramatizing, building with concrete materials, and using symbolic language (e.g., $2, =$).

mathematical concept

A connection of mathematical ideas that provides a deep understanding of mathematics. Students develop their understanding of mathematical concepts by taking part in a variety of relevant, authentic, meaningful, and connected learning opportunities.

mathematical language

The conventions, vocabulary, and terminology of mathematics. Mathematical language may be used in oral, visual, or written forms. Some types of mathematical language are:

- terminology (e.g., factor, pictograph)
- visual representations (e.g., 2×3 array, tree diagram)
- symbols, including numbers (e.g., $2, \frac{1}{4}$), operations [e.g., $3 \times 8 = (3 \times 4) + (3 \times 4)$], and signs (e.g., $=, +$).

mathematical model

A structured representation that illustrates mathematical ideas; for example, a five frame shows relationships to the number 5; a ten frame shows relationships to the number 10; a number line shows the order and magnitude of numbers. Models can make mathematical concepts easier to understand. *See also representation.*

mathematical modelling

An iterative and interconnected process of using mathematics to represent, analyse, make predictions, and provide insight into real-life situations. This process involves four components: understanding the problem, analysing the situation, creating a mathematical model, and analysing and assessing the model.

mathematical procedures

The skills, operations, mechanics, manipulations, and calculations that a student uses to solve problems. Also called simply *procedures*.

mathematical skills

Procedures for doing mathematics. Examples of mathematical skills include performing paper-and-pencil calculations, using a ruler to measure length, and constructing a bar graph.

mean

One of the measures of central tendency. The mean of a set of numbers is calculated by adding up all the numbers and then dividing that result by the number of numbers in the set. For example, the mean of 10, 20, and 60 is $(10 + 20 + 60) \div 3 = 30$. Also called *average*. *See also* **measure of central tendency**.

measure of central tendency

A measure that represents the approximate centre of a set of data. Mode, median, and mean are all measures of central tendency. *See also* **mean, median, mode**.

measurable attribute

A quality or feature that can be measured. *See also* **attribute**.

median

One of the measures of central tendency. The median is the middle value of an ordered list. For example, 14 is the median for the set of numbers 7, 9, 14, 21, 39. If there is an even number of data values, then the median is the average of the two middle values. *See also* **measure of central tendency**.

mega-

A unit prefix in the metric system denoting a factor of one million (10^6 or 1 000 000).

mental math strategies

Ways of computing in one's head, with or without the support of paper and pencil. Mental math strategies are often different from those used for paper-and-pencil computations. For example, to calculate $53 - 27$ mentally, one could subtract 20 from 53, and then subtract 7 from 33.

method of payment

A means that a buyer uses to compensate the seller for a good or service. Typical payment methods can include cash, cheques, credit or debit cards, money orders, bank transfers, electronic and wire transfers, gift cards, and online payment services.

metric prefix

A unit prefix that precedes base units such as metre, litre, or gram; the prefixes are based on the base ten system. For example, the prefix “milli” is used for “one thousandth”, so 0.001 gram = 1 milligram.

metric unit

A unit of measurement in the metric system. The base units in the metric system include metres, kilograms, and seconds, among others.

micro-

A unit prefix in the metric system denoting a factor of 10^{-6} or 0.000 001 (one millionth).

midpoint

The halfway point on a line segment; the point that is equally distant from both ends.

minuend

A number from which another number is to be subtracted; for example, in $9 - 3 = 6$, the minuend is 9. *See also subtraction, subtrahend.*

Mira

A learning tool used in geometry to locate reflection lines, reflection images, and lines of symmetry and to determine congruency and line symmetry. *See also congruent, line symmetry, reflection.*

misleading graph

A graph displaying information that misrepresents the data. For example, a pictograph that uses different sizes of pictures or symbols for different categories can be misleading because it may appear as if some categories have a greater or lesser count, when they don't.

mixed number

A number that is composed of a whole number and a fraction; for example, $8\frac{1}{4}$.

mode

One of the measures of central tendency. The mode is the category with the greatest frequency, or the number that appears the most in a set of data. For example, in a set of data with the values 3, 5, 6, 5, 6, 5, 4, 5, the mode is 5. *See also* **measure of central tendency**.

model

Representation of a problem, situation, or system using mathematical concepts.

modelling

See **computational modelling, mathematical modelling**.

monomial

An algebraic expression with one term; for example, $2x$ or $5xy$.

multiple

A number which is the product of a given whole number multiplied by any other whole number. For example, some multiples of 4 are 4, 8, 12, 16, and 20 (4×1 , 4×2 , 4×3 , 4×4 , 4×5).

multiple-bar graph

A graph that combines two or more bar graphs to compare two or more aspects of the data in related contexts; for example, comparing the type of pet that students in different grades have. A graph that compares two sets of data is called a *double bar graph* or a *comparative bar graph*.

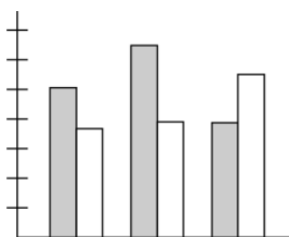

multiplication

An operation that represents repeated addition (sometimes called the “fast way to add”), the combining of equal groups, or an array. The multiplication of *factors* gives a product. For example, 3 and 4 are factors of 12 because $3 \times 4 = 12$. The inverse operation of multiplication is division. *See also* **factor, product, repeated addition**.

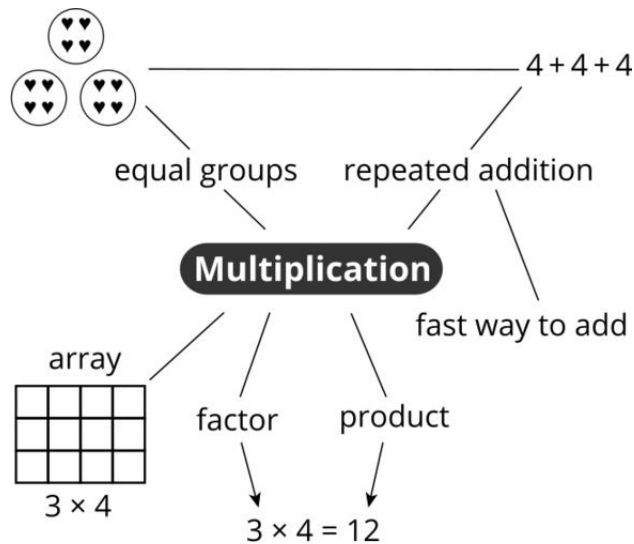

multiplicative relationship

A situation in which a quantity is repeated a given number of times. Multiplicative relationships can be represented symbolically as repeated addition (e.g., $5 + 5 + 5$) and as multiplication (e.g., 3×5).

multiplicative thinking

A way of thinking that involves reasoning about several quantities simultaneously. It requires thinking about situations in relative rather than absolute terms; for example, “If one dog grows from 5 kilograms to 8 kilograms and another dog grows from 3 kilograms to 6 kilograms, which dog grew more?” In looking at this scenario, both dogs increased in size by 3 kilograms. However, the second dog grew two times its size in going from 3 kilograms to 6 kilograms. In order for the first dog to grow that much, it would have had to grow to 5×2 or 10 kilograms. Multiplicative thinking is necessary for understanding fractions, proportional reasoning, and algebraic thinking.

multi-step problem

A problem that is solved by making at least two calculations. For example, shoppers who want to find out how much money they will have left after some purchases can follow these steps:

1. Add the cost of all items to be purchased (subtotal).
2. Multiply the sum of the purchases by the percent of tax.
3. Add the tax to the sum of the purchases (grand total).
4. Subtract the grand total from the shopper’s original amount of money.

municipal government

A level of government that provides those services best managed locally, such as water and sewage, parks, libraries, and local policing. Municipal governments may be cities, towns, villages, or rural (county) or metropolitan municipalities.

nano-

A unit prefix in the metric system denoting a factor of 10^{-9} or 0.000 000 001 (one billionth).

natural numbers

The numbers associated with counting, that is, 1, 2, 3, 4,

near prediction

A determination of a value, an element, or a term in a pattern that is just past the portion of a pattern that is provided; for example, a statement about the tenth term of a pattern when given the first eight terms of the pattern. *See also far prediction, pattern.*

nested events (coding)

Control structures that are placed inside other control structures; for example, loops occurring inside other loops, or a conditional statement being evaluated inside a loop. *See also control structure (coding).*

net

A pattern that can be folded to make a three-dimensional object.

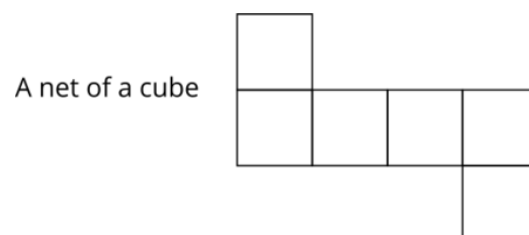

net income

An individual's total earnings from pay and/or other sources, minus income tax and other deductions. *See also gross income.*

non-linear pattern

A pattern that increases (grows) or decreases (shrinks) by a non-constant rate. For example, the Fibonacci sequence (0, 1, 1, 2, 3, 5, 8, 13, 21) is a non-linear pattern because it grows by the sum of each of the previous terms, resulting in a non-constant rate of change. *See also pattern.*

non-numeric pattern

A pattern that does not involve numbers. *See also pattern.*

non-standard units

Common objects used as measurement units; for example, paper clips, cubes, and hand spans. Non-standard units are used in the early development of measurement concepts.

***n*th term**

See general term.

number line

A line that represents a set of numbers using a set of points. The increments on the number line reflect the scale. *See also double number line.*

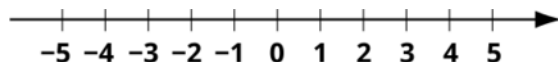
**number sentence**

An equation or inequality that uses numbers and mathematical symbols such as operation signs. *See also equation, inequality.*

number string

A sequence of computations designed to highlight a pattern.

numeral

A word or symbol that represents a number, e.g., “7”, “twelve” or “93”.

numerator

The number above the line in a fraction. It represents the number of equal parts being considered or the dividend of a division sentence. For example, in $\frac{3}{4}$, the numerator is 3. It

could mean 3 of 4 equal parts, 3 of 4 objects in a set, or 3 divided by 4. *See also* **denominator, division.**

numeric pattern

A pattern composed of numbers; for example, 5, 10, 15, 20, *See also* **pattern.**

numeric representation

A representation of mathematical ideas using numbers. *See also* **representation.**

numerically

A way to model patterns using numbers.

obtuse angle

An angle that measures more than 90° and less than 180° . *See also* **acute angle, angle.**

obtuse triangle

A triangle with one angle that measures more than 90° and less than 180° . *See also* **triangle.**

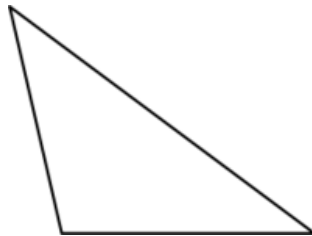

octagon

A polygon with eight sides. *See also* **polygon.**

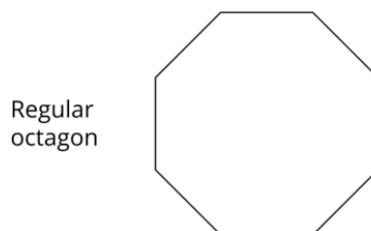
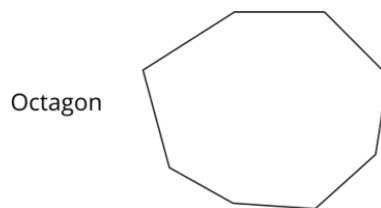

octahedron

A polyhedron with eight faces. The regular octahedron is one of the Platonic solids and has faces that are equilateral triangles. *See also equilateral triangle, face, polygon.*

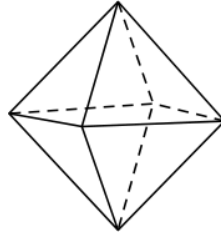

odd number

A number that is not divisible by 2 and ends with 1, 3, 5, 7, or 9. *See also even number.*

one-point perspective

A perspective view in which the parallel lines of buildings and rectangular shapes or objects are drawn to converge at a point on the horizon or eye-level line called the vanishing point. There can be as many vanishing points in a drawing or painting as there are sets of converging parallel lines. In one-point perspective (see illustration below), parallel lines converge at a single point on the horizon or eye-level line. *See also parallel lines, perspective view, two point perspective, vanishing point.*

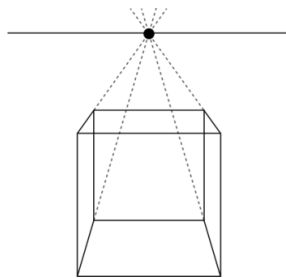

one-to-one correspondence

The correspondence of one object to one symbol or picture. In counting, one-to-one correspondence is the idea that each object being counted must be given one count and only one count. *See also many-to-one correspondence.*

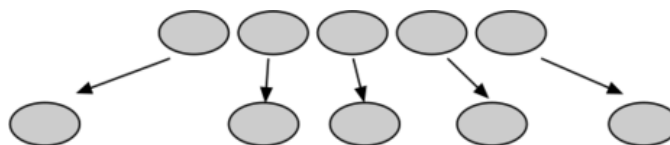

open array

A rectangular arrangement, used to represent multiplication or division, in which the factors of the multiplication expression (the number of implied rows and columns) are recorded on the length and width of the rectangle. An open array does not have to be drawn to scale. For example, 3×67 might be represented by an open array such as the following:

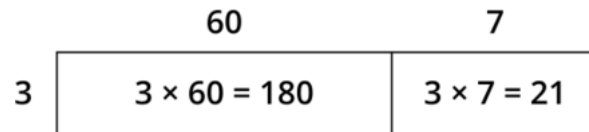

See also *array*.

open number line

An open number line consists of a marked but unlabelled number line that can be used to represent various values depending on the starting point and interval selected.

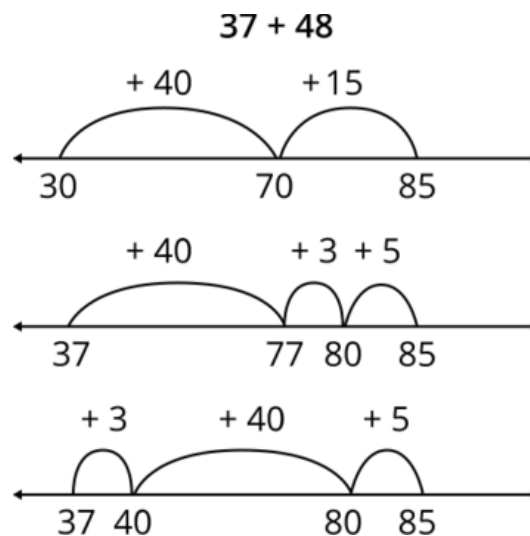

operation

Any of various mathematical processes, of which the most common are adding, subtracting, multiplying, dividing, and squaring.

opposite angles

Angles that are opposite each other, formed by two intersecting lines. Opposite angles are congruent (equal in measure). See also **congruent**.

optimization

The action of finding the most favourable or efficient outcome for a situation; for example, the greatest playing surface (area) for the least fencing (perimeter) when fencing a playground.

order

Arrange according to amount, size, or value.

order of operations

A convention or rule used to simplify expressions. The acronym BEDMAS is often used to describe the order:

- brackets
- exponents
- division or multiplication, whichever comes first
- addition or subtraction, whichever comes first

order of rotational symmetry

The number of times the position of a shape coincides with its original position during one complete rotation about its centre. For example, a square has rotational symmetry of order 4. *See also rotational symmetry, symmetry.*

ordered pair

Two numbers, in order, that are used to describe the location of a point on a plane relative to the origin, (0, 0); for example, (2, 6). On a coordinate plane, the first number is the horizontal coordinate of a point, and the second number is the vertical coordinate of the point. *See also coordinates.*

ordinal number

A number that shows relative position or place; for example, first, second, third, fourth. *See also cardinal number.*

orientation

The relative physical position or direction of something. The orientation of a shape may change following a rotation or reflection. The orientation of a shape does not change following a translation. *See also reflection, rotation, translation.*

origin

The point of intersection of the vertical and horizontal axes of a Cartesian plane. The coordinates of the origin are (0, 0). *See also* **coordinates**.

orthographic (top, side, front) views

Two-dimensional drawings of a three-dimensional object that show several views of the object. *See also* **three-dimensional object, two-dimensional shape**.

outcome (coding)

The result of code processed by a computer or device, which may include data on the screen or movement of a robot.

outcome (probability)

In probability, a possible result of an experiment. For example, flipping a coin has two possible outcomes: the coin will land either heads up or tails up. An experiment may have several or many possible outcomes. *See also* **event, probability experiment**.

outlier

A data value or a data point that lies outside of the overall pattern of the data.

output (coding)

See **outcome** (coding).

pan balance

A device consisting of two pans supported at opposite ends of a balance beam. A pan balance is used to compare and measure masses of objects. Also called *two-pan balance*. *See also* **mass**.

parallel

Extending in the same direction, remaining the same distance apart. Parallel lines or parallel shapes never meet, because they are always the same distance apart.

parallel lines

Lines in the same plane that do not intersect. *See also* **parallel**.

parallel sides

On a shape, sides that would never intersect if extended. *See also* **parallel**.

parallelogram

A quadrilateral whose opposite sides are parallel. *See also* **parallel**.

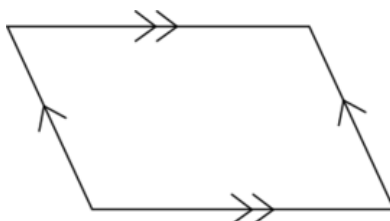

partial variation

A relationship between two variables in which one variable is a multiple of the other, plus some constant number. For example, the cost of a taxi fare has two components, a flat fee (initial value) and a fee per kilometre driven (constant rate). The formula representing the situation of a flat fee of \$2.00 and a fee rate of \$0.50/km is $F = 0.50d + 2.00$, where F is the total fare and d is the number of kilometres driven. *See also* **constant rate, variable**.

partitive division

In partitive division, the whole amount is known and the number of groups is known, while the number of items in each group is unknown. For example, “Daria has 42 bite-sized granola snacks to share among her 6 friends. How many does each friend get?” Also called *distribution division* or *sharing division*. *See also* **division, quotative division**.

part-whole

The idea that a number can be made of two or more parts. For example, 57 can be separated into 50 and 7, or 30 and 20 and 7.

pattern

An arrangement of elements that can be defined by a rule. *See also* **growing pattern, linear pattern, non-numeric pattern, numeric pattern, repeating pattern, shrinking pattern**.

pattern blocks

Learning tools that can be used to support students in learning about shapes, patterning, fractions, angles, and so on. Standard sets include green triangles, orange squares, tan rhombuses and larger blue rhombuses, red trapezoids, and yellow hexagons.

pattern core

The basic string of elements that repeats in a pattern. In an ABB-ABB-ABB pattern, the core is ABB. Also called *stem*. *See also* **element**.

pattern rule

A description of how a pattern repeats, grows, or shrinks, based on a generalization about the pattern structure. For example, the pattern rule for the growing pattern 3, 7, 11, 15, ... might be expressed as “begin at 3, and repeatedly add 4”.

pattern structure

The composition of a pattern. A pattern structure can often be represented by a series of letters. For example, a pattern involving triangle – square – square – triangle – square – square – triangle – square – square can be represented as ABB, ABB, ABB.

pedometer

An instrument for estimating the distance travelled on foot by recording the number of steps taken.

pentagon

A polygon with five sides. *See also* **polygon**.

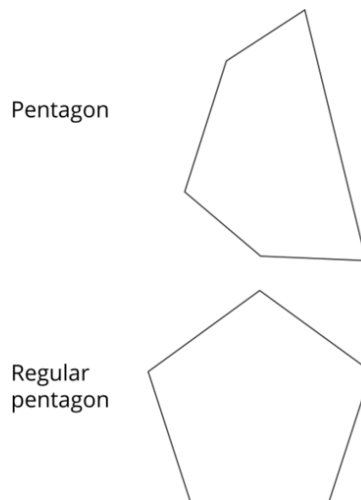

percent

A ratio expressed using the percent symbol, %. Percent means “out of a hundred”. For example, 30% means 30 out of 100. A percent can be represented by a fraction with a denominator of 100; for example, $30\% = \frac{30}{100}$.

perfect square

A number that can be expressed as the product of two identical natural numbers. For example, $9 = 3 \times 3$; thus 9 is a perfect square. *See also square root.*

perimeter

The length of the boundary of a shape, or the distance around a shape. For example, the perimeter of a rectangle is the sum of its side lengths; the perimeter of a circle is its circumference.

perpendicular

The property of lines, line segments, sides, or faces that intersect at a 90° angle.

perspective view

The representation of space and three-dimensional objects on a two-dimensional surface to convey the impression of height, width, depth, and relative distance. *See also one-point perspective, three-dimensional object, two-dimensional shape, two-point perspective.*

pi (π)

A number with a value of approximately 3.142. It is the quotient of the circumference of any circle divided by its diameter. *See also circle, circumference, diameter.*

pico-

A unit prefix in the metric system denoting a factor of 10^{-12} or 0.000 000 000 001 (one trillionth).

pictograph

A graph that uses pictures or symbols to represent one or more data values.



pictorial representation

The use of a picture or diagram to model a mathematical concept or a real-world context or situation.

pie chart

See **circle graph**.

pixelated image (coding)

In programming, a graphical figure that can be moved about a screen by programming actions.

place value

The value of a digit that appears in a number. The value depends on the position or place in which the digit appears in the number. Each place has a value of ten times the place to its right. For example, in the number 5473.9, the digit 5 is in the thousands place and represents 5000; the digit 4 is in the hundreds place and represents 400; the digit 7 is in the tens place and represents 70; the digit 3 is in the ones place and represents 3; and the digit 9 is in the tenths place and represents $\frac{9}{10}$ of one or nine-tenths. See also **base ten number system, expanded form**.

plane symmetry

A three-dimensional object has plane symmetry if a plane can divide the object into two parts that are the mirror images of each other (symmetrical). See also **symmetry, three-dimensional object**.

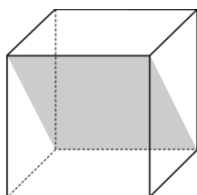

point of intersection

The point at which two or more lines intersect.

point of origin

The starting point on a grid. The coordinates for every other point are determined based on where that point is relative to the origin. At the point of origin, x and y both equal zero, and the x -axis and y -axis intersect. See also **coordinates, grid**.

polygon

A closed shape formed by three or more line segments; for example, triangle, quadrilateral, pentagon, octagon. A polygon cannot have curved sides.

polyhedron

A three-dimensional object that has polygons as faces. *See also* **face, polygon, three-dimensional object**.

population

The total set of subjects (e.g., individuals, objects, species) that fit a particular description; for example, salmon in Lake Ontario.

positional language

Language that is used to describe the relative locations of objects and people. Examples include *over, under, on top, above, below, beneath, in front of, behind, inside, outside, between, up, down, along, and through*.

power

A number written in exponential form; a shorter way of writing repeated multiplication. For example, 10^2 and 2^{-6} are powers. A power may be positive or negative. *See also* **exponential notation**.

power of ten

A power of the number 10 where the number 10 is multiplied by itself repeatedly as many times as expressed by the exponent, an integer. For example, 10^2 ($10 \times 10 = 100$). A negative exponent indicates that the number must be divided by the power of ten. For example, 10^{-2} ($\frac{1}{10 \times 10} = \frac{1}{100} = 0.01$). *See also* **exponential notation, power**.

primary data

Information that is collected directly or first-hand; for example, observations and measurements collected directly by students through surveys and experiments. Also called *first-hand data* or *primary-source data*. *See also* **secondary data**.

Primary Source

Data that is collected firsthand by the researcher.

prime factor

A factor that is a prime number. For example, the prime factors of 21 are 3 and 7. *See also factor, prime number.*

prime factorization

An expression showing a composite number as the product of its prime factors. The prime factorization of 24 is $2 \times 2 \times 2 \times 3$. *See also composite number, factor, prime factor, prime number.*

prime number

A whole number greater than 1 that has only two factors, itself and 1. For example, the only factors of 7 are 7 and 1. *See also composite number, factor.*

prism

A three-dimensional object with two parallel and congruent bases. A prism is named by the shape of its bases, for example, rectangle-based prism, triangle-based prism. *See also base (shapes), congruent, parallel, three-dimensional object.*

probability

A number from 0 to 1 that shows how likely it is that an event will happen.

probability experiment

An experiment used to determine the probability of an outcome. *See also outcome (probability), probability.*

probability line

A line with 0 at the left-hand end (for “impossible”) and 1 at the right-hand end (for “certain”). Probabilities for events can be plotted on the line to show how these probabilities relate to each other. *See also probability.*

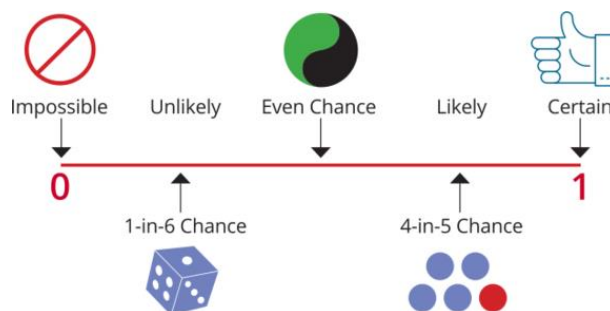

problem solving

Engaging in a task for which the solution is not obvious or known in advance. To solve the problem, students must draw on their prior knowledge, try out different strategies, make connections, and reach conclusions.

problem-solving strategies

Methods used for tackling or resolving problems. The strategies most commonly used include the following: act it out, make a model using mathematical tools, look for a pattern, draw a picture or diagram, guess and check, make a table or chart, create an organized list, make a simpler problem, and work backwards.

product

The quantity that results when two or more numbers are multiplied.

profit

The difference between expenses and income. Profit is calculated as total revenue generated by a business activity less total expenses, costs, and taxes involved in sustaining the activity.

proper fraction

A fraction whose numerator is smaller than its denominator; for example, $\frac{2}{3}$. *See also*

denominator, fraction, improper fraction, numerator.

properties of diagonals

See **diagonals, properties of.**

property (geometric)

See **geometric property.**

proportional

Equivalent; used to describe two or more ratios that are equivalent. For example, $\frac{2}{3}$ is proportional to $\frac{6}{9}$, and 1 : 7 is proportional to 2 : 14.

proportional reasoning

Reasoning that is based on equal ratios and that involves an understanding of the multiplicative relationship in the size of one quantity compared with another. Students express proportional reasoning informally by using phrases such as “twice as big as” and “a third the size of”.

protractor

A tool for measuring angles. *See also* angle.

pseudocode (coding)

An informal way of describing a computer program or algorithm that is an intermediary between everyday language and programming code. Pseudocode is often used before actual coding to explain the design process in a less technical way (e.g., fwd 10 steps, rt 45 degrees, bkwd 4 steps).

pyramid

A three-dimensional object whose base is a polygon and whose other faces are triangles that meet at a common vertex. A pyramid is named by the shape of its base; for example, square-based pyramid, triangle-based pyramid. *See also* base (shapes, face, polygon, three-dimensional object, triangle, vertex).

Pythagorean relationship

The relationship that, for a right triangle, the area of the square drawn on the hypotenuse is equal to the sum of the areas of the squares drawn on the other two sides. In the diagram, $a^2 = b^2 + c^2$. *See also* hypotenuse, Pythagorean theorem, right-angle triangle.

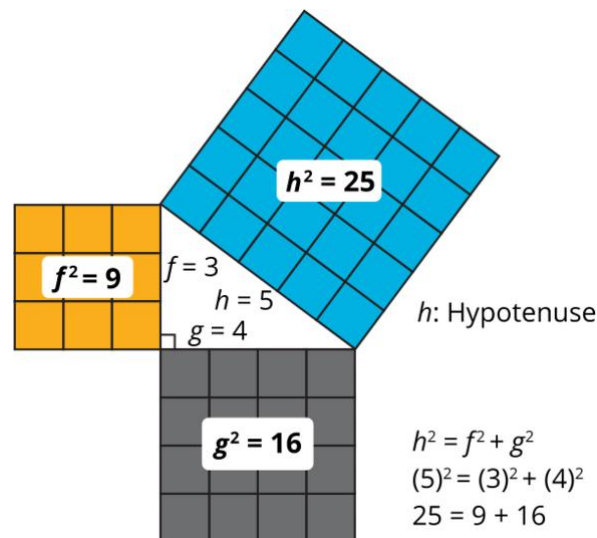

Pythagorean theorem

The conclusion that, in a right-angle triangle, the square of the length of the longest side is equal to the sum of the squares of the lengths of the other two sides. *See also* **Pythagorean relationship, right-angle triangle**.

quadrant

One of the four regions formed by the intersection of the x -axis and the y -axis in a Cartesian plane. *See also* **Cartesian plane**.

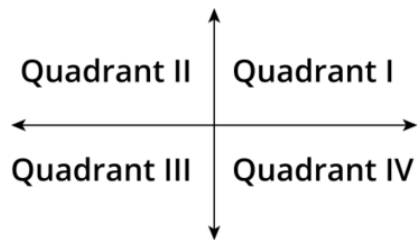

quadrilateral

A polygon with four sides. *See also* **polygon**.

qualitative data

Non-numerical data that can be organized by categories, such as type of pet, or eye colour. Also called *categorical data*.

quantitative data

Data that is numerical and acquired through counting (*see* **discrete data**) or measuring (*see* **continuous data**); for example, number of sides or amount of rainfall.

quantity

The “how muchness” of a number. An understanding of quantity helps students estimate and reason with numbers and is an important prerequisite to understanding place value, the operations, and fractions. *See also* **multiplicative relationship**.

question of interest

A question that is proposed to satisfy a curiosity or solve a problem and that requires the collection of data in order to answer.

quotative division

One of the two meanings of division: measurement. This involves dividing a number into a measured quantity. In quotative division, the whole amount is known and the number of items in each group is known, while the number of groups is unknown. For example, “Thomas is packaging 72 ears of corn into bags. If each bag contains 6 ears of corn, how many bags will Thomas need?” The “measured” quantity that the corn is being divided into is 6 ears. Also called *measurement division*. See also **division, partitive division**.

radius

A line segment whose endpoints are the centre of a circle and a point on the circle. The radius is half the diameter. See also **circle, diameter**.

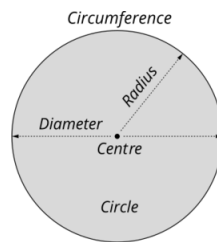

random sampling

A sampling technique in which each subject (e.g., individual, object, species) in a population has a possibility of being selected. See also **population, sampling, simple random sampling**.

range

The difference between the highest and lowest values in a set of data. The range is a measure of the dispersion of the data. For example, in the data set 8, 32, 15, 10, the range is 24, that is, 32–8.

rate

A comparison, or a type of ratio, of two measurements with different units, such as distance and time; for example, 100 km/h, 10 kg/m³, $\frac{20L}{100km}$. See also **ratio**.

rate of change

A change in one quantity relative to the change in another quantity. For example, for a 10 km walk completed in 2 h at a steady pace, the rate of change is $\frac{10km}{2h}$ or 5km/h. See also **quantity, rate**.

ratio

A comparison of quantities with the same units. A ratio can be expressed in ratio form or in fraction form, for example, 3 : 4 or $\frac{3}{4}$. *See also* **quantity**.

ratio table

A model that can be used to develop an understanding of multiplication, equivalent fractions, division, and proportional reasoning. For example, completing the ratio table below would help students solve the following problem: “A grocer sells flour by the kilogram. If a 4 kg bag costs \$6.60, how much would a 2 kg, a 3 kg, a 5 kg, and a 6 kg bag cost?” The students would start with what is known, i.e., 4 kg is \$6.60, and enter that in the ratio table. A possible next step would be to figure out how much half of that would cost, i.e., 2 kg is \$3.30. In order to figure out how much 3 kg cost, the student would have to halve that again, i.e., 1 kg is \$1.65 and then add that to the cost of 2 kg. Students would then use this information to calculate the cost of 5 kg (e.g., the costs of 3 kg + 2 kg or 1 kg × 5) and 6 kg (e.g., the costs of 3 kg + 3 kg or 1 kg × 6). *See also* **division, equivalent fractions, multiplication, proportional reasoning**.

Ratio Table

Bags of Flour	1	2	3	4	5	6
Cost	\$1.65	\$3.30	\$4.95	\$6.60	\$8.25	\$9.90

rational number

A number that can be expressed as a fraction in which the denominator is not 0. For example, the numbers 8, 1.75, 0.1, -0.01, and $\frac{5}{7}$ are rational numbers *See also* **denominator, fraction, irrational number**.

ray

A line that has a starting point but no endpoint. *See also* **line**.

real numbers

The set of all rational and irrational numbers. *See also* **integer, irrational number, natural numbers, rational number, real numbers, whole number**.

recall

Remember; bring to one's mind.

recomposition of numbers (recompose)

The putting back together of numbers that have been decomposed. For example, to solve $24 + 27$, a student might decompose the numbers as $24 + 24 + 3$, then recompose the numbers as $25 + 25 + 1$ to give the answer 51. *See also composition of numbers, decomposition of numbers.*

rectangle

A quadrilateral in which opposite sides are equal and all interior angles are right angles. A square is a rectangle with four equal sides. *See also angle, quadrilateral.*



rectangle-based prism (rectangular prism)

A three-dimensional object with two parallel and congruent rectangular faces. The four other faces are also rectangular. *See also congruent, face, parallel, rectangle, three-dimensional object.*

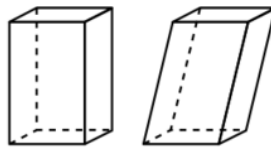

Rectangle-Based Prisms

recursive thinking

A type of thinking that focuses on the relationship between one term and the next.

Day	Money Earned (\$)
1	5
2	10
3	15
4	20

Diagram illustrating recursive thinking with a table showing the relationship between Day and Money Earned (\$). The table shows a constant increase of \$5 per day. Arrows and '+ 5' labels indicate the recursive relationship between consecutive days.

reduction

A transformation that shrinks a shape by a scale factor to form a similar shape. *See also* **dilation, enlargement, scale factor, transformation.**

reflection

A transformation that flips a shape over a line to form a congruent shape. A reflection image is the mirror image that results from a reflection. Also called *flip*. *See also* **congruent, transformation.**

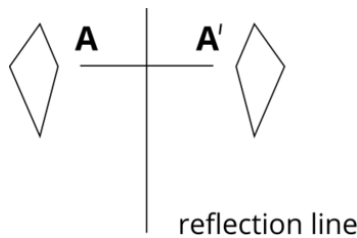

reflex angle

An angle that measures greater than 180° and less than 360° . *See also* **angle.**

regrouping

The process of making groups of ten when adding and subtracting. For example, when adding $17 + 25$ and adding from right to left, $7 + 5$ makes 12, which must be regrouped into 1 ten and 2 ones. The 10 from that step gets added onto the adding of the 10 and 20, resulting in 42. Also called *borrowing, carrying, trading*.

regular shape

A closed two-dimensional shape in which all sides and all angles are equal. *See also* **angle, two-dimensional shape.**

regularity

Sameness. In a repeating pattern, for example, the regularity is that the core keeps repeating. In a linear growing pattern, the regularity is that the pattern keeps going up by the same amount each time.

rekenrek

A manipulative that is like an abacus, but without any place-value columns. Each row is made up of five white and five red beads, with each bead representing or having the value of one.

This tool helps to show the relationship between a number and five and ten (e.g., 9 is 4 more than 5 and 1 less than 10, or 22 is 2 more than 20 or 8 less than 30).

relation

An identified relationship between variables that may be expressed as a table of values, a graph, or an equation.

relational operators (coding)

Symbols used in computer programming to test or define a relationship between two things (e.g., $>$, $<$, $>=$, $<=$, $==$ (equal to), $!=$ (not equal to)).

relational rods

Learning tools that can be used to represent, compare, order, and perform operations with whole numbers. They are usually found in a set of rectangular rods of different lengths, in which each length is a different colour. Also called *Cuisenaire rods*.

relationship

In mathematics, a connection between mathematical concepts, or between a mathematical concept and an idea in another subject or in real life. For example, decimal numbers are related to fractions because they are fractions with denominators that are powers of ten; measurements such as capacity and mass are important for carrying out science experiments and recording observations. As students connect ideas they already understand with new experiences and ideas, their understanding of mathematical relationships develops.

relative frequency

The frequency of a particular category, outcome, or event expressed as a percent of the total number of pieces of data or outcomes. *See also* **frequency**.

relative frequency table

A table in which data is organized into categories with corresponding frequencies, expressed as fractions, decimal amounts, or percentages of the whole data set. *See also* **frequency table**.

relative location

The position of something, such as a place, an object, or a point, in comparison to something else, either fixed or moving. Also called *relative position*.

relative position

The size or magnitude of a unit, number, or attribute in comparison to another – larger, smaller, or about the same. *See also relative location, relative size.*

relative size

The size or magnitude of a unit, number, or attribute in comparison to another – larger, smaller, or about the same.

remainder

The quantity left when an amount has been divided equally and only whole numbers are accepted in the answer. Often indicated by the use of “R” in a solution statement. (e.g., 11 divided by 4 is 2 with R3).

repeated addition

The process of adding the same number two or more times. Repeated addition can be expressed as multiplication (e.g., $3 + 3 + 3 + 3$ represents 4 groups of 3, or 4×3). *See also multiplication.*

repeated subtraction

The process of subtracting the same subtrahend from another number two or more times until 0 is reached. Repeated subtraction is related to division (e.g., $8 - 2 - 2 - 2 - 2 = 0$ and $8 \div 2 = 4$ express the notion that 8 can be partitioned into 4 groups of 2). *See also division, subtrahend.*

repeating decimal

A decimal number that has repeating digits or a repeating pattern of digits that go on indefinitely; for example, $\frac{2}{3} = 0.66666666\dots$ and $\frac{2}{7} = 0.285714285714285714\dots$

repeating event (coding)

Something that happens over and over again. In coding, loops are used to repeat instructions. *See also loop (coding).*

repeating pattern

A pattern in which a core repeats continuously (e.g., AAB, AAB, AAB, ...). *See also pattern core.*

represent

To show or convey mathematical thinking. *See also representation.*

representation

An illustration of mathematical ideas using manipulatives (concrete), sketches or diagrams (pictorial), graphs (graphic), numbers (numeric), or algebraic expressions and equations (algebraic). *See also algebraic expression, equation, manipulatives, mathematical model.*

reverse flow chart

A flow chart that shows how the sequence of operations in an equation can be reversed to determine the value of the variable. For example, the diagram below shows how a reverse flow chart could be used to solve $\frac{m}{4} - 2 = 10$. Here, the actions of the equation are mapped out in the top row and then reversed in the bottom row to arrive at the solution.

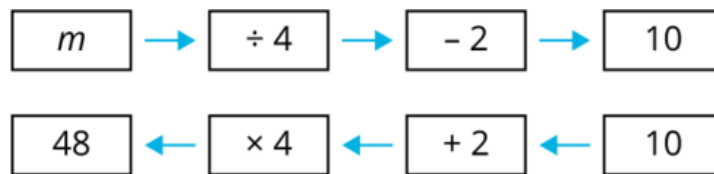

rhombus

A parallelogram with equal sides. Also called *diamond*. *See also parallelogram.*

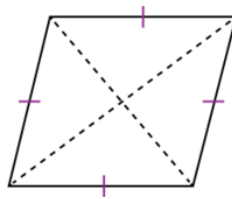

right angle

An angle that measures 90° . *See also angle.*

right-angle triangle

A triangle with a right angle. *See also angle, triangle.*

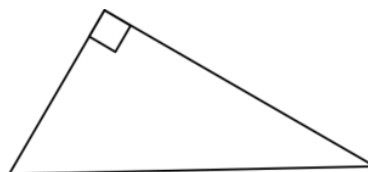

rotation

A transformation that turns a shape about a fixed point to form a congruent shape. A rotation image is the result of a rotation. Also called *turn*. *See also congruent, transformation.*

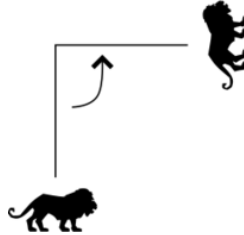

rotational symmetry

A geometric property of a shape whose position coincides with its original position after a rotation of less than 360° about its centre. For example, the position of a square coincides with its original position after a $\frac{1}{4}$, a $\frac{1}{2}$ turn, and a $\frac{3}{4}$ turn, as well as after a full turn, so a square has rotational symmetry of degree 4. *See also order of rotational symmetry, rotation, symmetry.*

round

To replace a number by an approximate value of that number. Rounding is used to assist in estimation. To estimate 5×27 , for example, 27 might be rounded to 30 (to give an estimate of $5 \times 30 = 150$), but 27 could also be rounded to 25 (to give an estimate of $5 \times 25 = 125$). *See also estimation.*

row and column structure

The spatial structure of an array. Objects are arranged in rows (going across) and columns (going down). *See also array.*

sample

See sampling.

sample space

In probability, the sample space is a list of all possible outcomes. *See also outcome (probability).*

sampling

Gathering information from a subset of a population (known as a *sample*). *See also population.*

saving

Putting money aside for future use, for example in a savings account or a pension account. Saving may also involve reducing expenditures.

savings account

A type of account held at a financial institution that pays interest. *See also* **chequing account**, **saving**.

scale (on a graph)

A sequence of numbers associated with marks that subdivide an axis. An appropriate scale is chosen to ensure that all data are represented on the graph. For example, if the range of a variable goes to 200, the scale for the axis showing the variable might go in increments of 10, instead of increments of 1, up to 200 or greater.

scale drawing

A drawing in which the lengths are proportionally reduced or enlarged from the actual lengths.

scale factor

The ratio by which a shape is dilated. *See also* **dilation**, **enlargement**, **ratio**, **reduction**, **transformation**.

scaled model

A three-dimensional structure that has been reduced or enlarged proportionally from its actual size. *See also* **three-dimensional object**.

scalene triangle

A triangle with three sides of different lengths. *See also* **triangle**

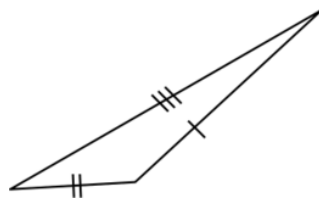

scaling

To reduce or increase in size according to a scale factor. Used in determining rates or ratios. For example, to scale a number up by 3 requires that it be multiplied by 3. *See also* **rate**, **ratio**.

scatter plot

A graph designed to show a relationship between corresponding numbers from two sets of data measurements associated with a single object or event; for example, a graph of data about marks and the corresponding amount of study time. Drawing a scatter plot involves plotting ordered pairs on a coordinate grid. Also called *scatter diagram*.

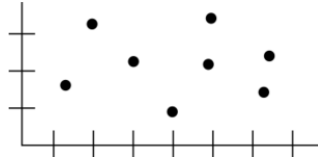

scientific notation

A way of expressing a very large or very small number in terms of a decimal number between 1 and 10 multiplied by a power of 10. For example, 69 890 000 000 is 6.989×10^{10} in scientific notation, and 0.000279 is 2.79×10^{-4} . See also **decimal number**.

secondary data

Information that is not collected firsthand; for example, data from a magazine, a newspaper, a government document, or a database. Also called *second-hand data* or *secondary-source data*. See also **primary data**.

secondary sources

Data that is analyzed and interpreted and that has been collected by someone else (e.g., data found in newspapers or encyclopedias). See also **primary data**.

separating problem

A problem that involves decreasing a quantity by removing or separating part of the amount. For example, there were 27 geese in the park and 9 flew away. How many geese are left in the park?

sequence (patterning)

In patterning, a pattern of numbers that are connected by some rule; for example, for the pattern 3, 5, 7, 9, ..., the rule is start at 3 and add 2 each time.

sequential events (coding)

A set of instructions carried out one after another, usually top to bottom or left to right on a screen. See also **concurrent events (coding)**.

set of data

See **data set**.

shape of data

The shape of a graph that represents the distribution of a set of data. See *also* **data set, distribution**.

shrinking pattern

A pattern that involves a regression (e.g., a decrease in the number of elements) from term to term (e.g., AAAA, AAA, AA, A). See *also* **growing pattern**.

side

An outer boundary (a straight line) of a two-dimensional shape. See *also* **two-dimensional shape**.

similar

Having the same shape but not always the same size. If one shape is similar to another shape, there exists a dilation that will transform the first shape into the second shape. See *also* **dilation, enlargement, reduction, scale factor, transformation**.

simple interest

Interest paid on the principal amount of a loan or deposit. Simple interest is calculated by multiplying the daily interest rate by the principal by the number of days that elapse between payments. For example, an automobile loan has a \$6000 principal balance with an annual 5% simple interest rate. When a payment is due on July 1, interest of \$24.66 is calculated on the 30 days since the last payment 30 days earlier on June 1. See *also* **compound interest, interest rate**.

simple random sampling

A method of obtaining a subset of a population such that each subject (e.g., individual, object, species) in the population has an equal chance of being selected. See *also* **population, random sampling, sampling**.

simplification

In division, the process of “reducing” or multiplying a given problem to make a friendlier problem. For example, $128 \div 32$ has the same quotient (result of dividing one number by

another) as $64 \div 16$ (halve both numbers), or $32 \div 8$ (halve both numbers again); $80 \div 5$ has the same quotient as $160 \div 10$ (multiply both numbers by 2).

simplify

To reduce a fraction to its lowest (simplest) terms by dividing the numerator and denominator by their greatest common factor, or to reduce an algebraic expression to its simplest form by grouping and combining like terms.

simulation

A probability experiment with the same number of outcomes and corresponding probabilities as the situation it represents. For example, tossing a coin could be a simulation of whether the next dog a person sees will be male or female.

skeleton

A model that shows only the edges and vertices of a three-dimensional object. *See also* **edge**, **three-dimensional object**, **vertex**.

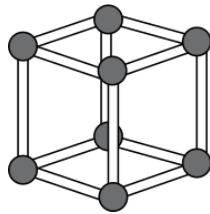

slide

See **translation**.

sort

Organize according to a particular criterion.

spending

Paying money to obtain goods or services. *See also* **goods and services**.

sphere

A perfectly round ball, such that every point on the surface of the sphere is the same distance from the centre of the sphere.

spiral pattern

A curve that starts from a centre point and moves outward as it grows.

square

A rectangle with four equal sides and four right angles. *See also* **rectangle, right angle**.

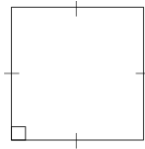

square centimetre (cm²)

A metric unit of area equal to a square that is one centimetre on each side. *See also* **square**.

square metre (m²)

A metric unit of area equal to a square that is one metre on each side. *See also* **square**.

square root (of a number)

A factor that, when multiplied by itself, equals the number. For example, 3 is a square root of 9, because $3 \times 3 = 9$. *See also* **factor, perfect square**.

square-based prism

A prism whose bases are squares. *See also* **base (shapes), cube, prism, square**.

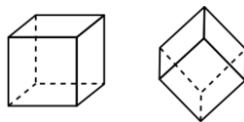

Cubes or Square-Based Prisms

stacked-bar graph

A graph that combines two or more bar graphs to proportionally compare two or more aspects of the data in related contexts.

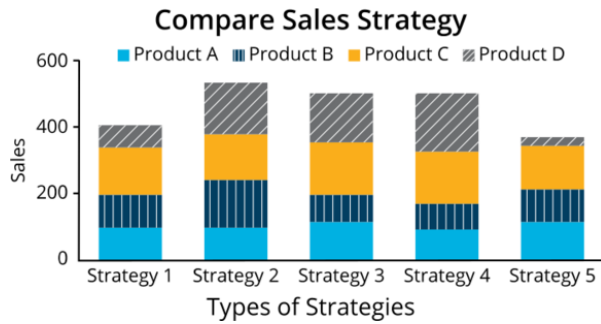

standard fractional notation

A fraction written in the form $\frac{a}{b}$.

stem-and-leaf plot

An organization of quantitative data where each data value is split into two components – a “stem” and a “leaf”. Stems are listed vertically, and their leaves are listed beside them. The following stem-and-leaf plot represents these test results: 72, 64, 68, 82, 75, 74, 68, 70, 92, 84, 77, 59, 77, 70, 85. The stem shows the first digit of the number (tens) and is written in the left column. The leaf is the last digit of the number (ones) and is listed in the right column. The leaves are listed in ascending order in the plot.

5	9
6	4, 8, 8
7	0, 0, 2, 4, 5, 7, 7
8	2, 4, 5
9	2

straight angle

An angle that measures 180°. *See also* **angle**.

stratified random sampling

A method of random sampling in which a population is subdivided into smaller subgroups based on common criteria (known as *strata*) and then a random sample is taken from each stratum. This ensures that each subgroup is represented in the sample. *See also* **population, sampling**.

subitizing

Being able to recognize the number of objects at a glance without having to count all the objects, such as recognizing the configuration of the five dots on a die representing 5.

subprogram (coding)

A small set of instructions for completing one small task. Subprograms can be combined in a main program to accomplish a large task using small steps.

substitute

To replace variables (letters) with numbers in order to solve an equation or set of equations.

subtraction

The operation that represents the difference between two numbers. The inverse operation of subtraction is addition. *See also* **addition**.

subtrahend

In a subtraction question, the number that is subtracted from another number. In the example $15 - 5 = 10$, 5 is the subtrahend.

sum

The total or whole amount resulting from the addition of two or more numbers or quantities.

supplementary angles

Two angles whose sum is 180° . *See also* **angle**.

surface area

The total area of the surface of a three-dimensional object. *See also* **three-dimensional object**.

survey

A method used to collect data in a systematic way. Surveys can be conducted in many ways, including through observations, interviews, and written questionnaires.

symmetry

The geometric property of being balanced about a point, a line, or a plane.

systematic counting

A process used as a check so that no event or outcome is counted twice.

systematic random sampling

A sampling technique in which the sample is taken in a systematic way once the starting point and the interval selection have been randomly chosen. For example, the letter “B” and the number “4” are randomly selected, so that every fourth student on the class list is selected for the sample, starting from the names (either first names or surnames) beginning with a “B” and rotating through until one is back to the starting point. *See also random sampling.*

table

An orderly arrangement of facts set out for easy reference; for example, an arrangement of numerical values in vertical columns and horizontal rows.

table of values

A table used to record the coordinates of points in a relation.

x	$y = 3x - 1$
-1	-4
0	-1
1	2
2	5

tally table

A table that uses tally marks to count data and record frequencies. Also known as a *t-chart*. *See also two-way tally table.*

Favourite Sport	
Sport	Tally
Hockey	NI II
Skiing	IIII
Swimming	NI III
Basketball	II

tangram

A Chinese puzzle made from a square cut into seven pieces: two large triangles, one medium-sized triangle, two small triangles, one square, and one parallelogram. *See also* **parallelogram, square, triangle**.

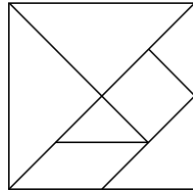

tax

A compulsory contribution that an individual or business pays to the government to finance government programs and services. Taxation may take a variety of forms, such as levies on income and on some kinds of goods and services. Some common types of taxes include income tax, property tax, and sales tax. *See also* **goods and services**.

tax revenue

The annual income that a government receives from taxation. *See also* **tax**.

tax system

The money collected by federal, provincial, and municipal governments from individuals and businesses to help finance government programs and services, such as national defense, provincial health care, and municipal garbage collection, respectively. *See also* **tax**.

T-chart

A type of graphic organizer consisting of two columns, used to organize information or ideas.

ten frame

A 2 by 5 array onto which counters or dots are placed to help students relate a given number to 10 (e.g., 7 is 3 less than 10) and recognize the importance of using 10 as an anchor when adding and subtracting. *See also* **five frame**.

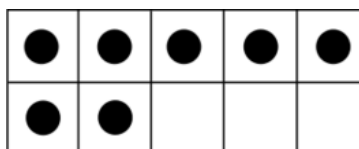

tera-

A unit prefix in the metric system denoting a factor of one trillion (10^{12} or 1 000 000 000 000).

term

Each of the quantities constituting a number in a sequence, a ratio, a sum or difference, or an algebraic expression. For example, in the ratio 3:5, 3 and 5 are both terms; in the algebraic expression $3x + 2y$, $3x$ and $2y$ are both terms. *See also algebraic expression.*

terminating decimal

A decimal number that has a finite number of digits; for example, 0.37 and 5.95479. *See also decimal number, repeating decimal.*

tessellation

A tiling pattern in which shapes are fitted together with no gaps or overlaps. A regular tessellation uses congruent shapes. *See also congruent, tile.*

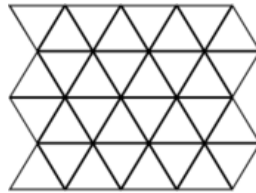

tetrahedron

A polyhedron with four faces. A regular tetrahedron is one of the Platonic solids and has faces that are equilateral triangles. *See also equilateral triangle, face, polyhedron.*

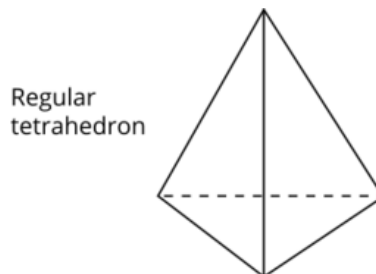

text-based programming (coding)

A way of programming a computer or electronic device that involves typing out programming code instructions in the specific syntax of the programming language being used. *See also block-based programming.*

theoretical probability

A mathematical calculation of the chances that an event will happen in theory; if all outcomes are equally likely, it is calculated as the number of favourable outcomes divided by the total number of possible outcomes. *See also* **experimental probability**.

three-dimensional object

An object that has the dimensions of length, width, and depth.

tile

To use repeated shapes, which may or may not be congruent, to cover a region completely. *See also* **congruent, tessellation**.

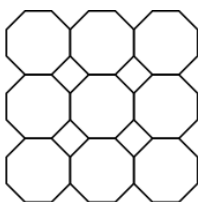
**time line**

A number line on which the numbers represent time values, such as numbers of days, months, or years.

tools

A variety of aids to support student learning of mathematical concepts, including concrete or digital manipulatives, models, and technological tools such as calculators and computers.

trade

The transfer of goods or services, often in exchange for money, from one individual or organization to another. *See also* **barter, goods and services**.

transaction

An agreement between a buyer and a seller to exchange goods or services, including for money. *See also* **goods and services**.

transferring money

Moving money electronically or physically from one account or person to another.

transformation

A change in a figure that results in a different position, orientation, or size. Transformations include translations (slides), reflections (flips), rotations (turns), and dilations (reductions or enlargements). *See also* **dilation, enlargement, reduction, reflection, rotation, translation.**

translate

In patterning, to transform one representation of a pattern into another representation. For example, the pattern “red, blue, red, blue, red, blue” could be translated to “clap, stomp, clap, stomp, clap, stomp”; both patterns show an AB structure.

translation

A transformation that moves every point on a shape the same distance, in the same direction, to form a congruent shape. A translation image is the result of a translation. Also called *slide*. *See also* **congruent.**

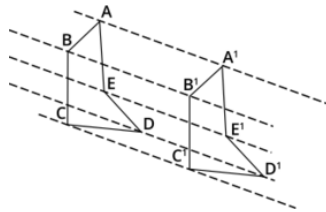

transversal

A line that intersects two or more other lines.

trapezoid

A quadrilateral with at least one pair of parallel sides. *See also* **parallel sides, quadrilateral.**

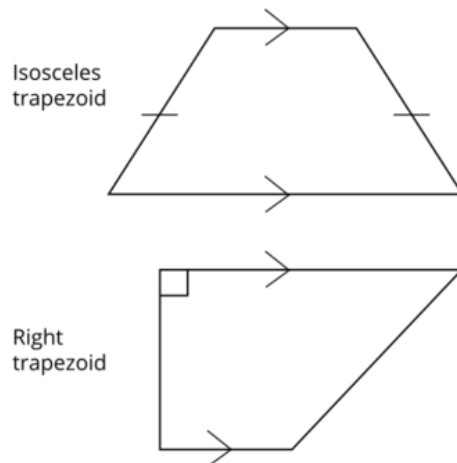

tree diagram

A branching diagram that shows all possible combinations or outcomes for two or more independent events. The following tree diagram shows the possible outcomes when a coin is tossed three times.

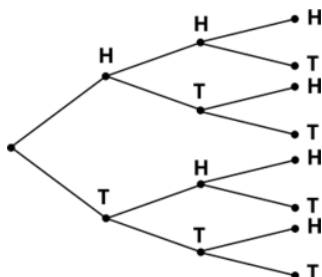

trial

A single iteration of an experiment. Each experiment usually involves a number of trials.

triangle

A polygon with three sides. *See also* **polygon**.

triangle-based prism (triangular prism)

A three-dimensional object with a triangular base and three rectangular faces. *See also* **prism**, **rectangle**, **three-dimensional object**, **triangle**.

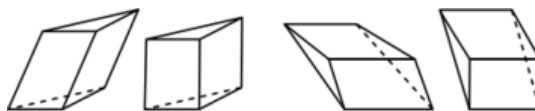

Triangle-Based Prisms

trinomial

An algebraic expression (polynomial) that consists of three terms; for example, $3x + 2y + 7n$. *See also* **algebraic expression**.

turn

See **rotation**.

two-dimensional shape

A shape that has the dimensions of length and width.

two-point perspective

A method of drawing in which the parallel lines of buildings and rectangular shapes or objects are drawn to converge at a point on the horizon or eye-level line called the vanishing point. There can be as many vanishing points in a drawing or painting as there are sets of converging parallel lines. In two-point linear perspective (see illustration below), parallel lines converge at two vanishing points on the horizon or eye-level line. *See also one-point perspective, parallel lines, perspective view, vanishing point.*

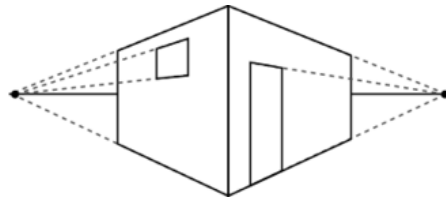

two-variable data

Two sets of data collected from the same subjects. For example, you might collect both the height and the arm span of a population to see if there is a relationship between those two variables.

two-way tally table

A table used to organize data into all the possible combinations involving two attributes. *See also tally table.*

unit

A countable quantity that can be repeated. In terms of measurement, a unit may more specifically refer to a quantity of time, area, length, volume, capacity, mass, angle, and so on. Units quantify comparisons.

unit fraction

Any fraction that has a numerator of 1; for example, $\frac{1}{2}$, $\frac{1}{3}$, or $\frac{1}{4}$. Every fraction can be decomposed into unit fractions; for example, $\frac{3}{4}$ is 3 one-fourth units, or $\frac{3}{4} = \frac{1}{4} + \frac{1}{4} + \frac{1}{4}$.

unit of time

A countable quantity of time that can be repeated. Standard units of time include seconds, minutes, hours, days, months, years, and so on. Non-standard units of time include drips of a water faucet, swings of a pendulum, beats of a metronome, and so. *See also unit.*

unit rate

A rate that, when expressed as a ratio, has a second term that is one unit. For example, the children's rate for a movie ticket is \$7.99; a bag of rice costs \$2.99 per kilogram.

unitizing

The ability to recognize that a group of objects can be considered as a single entity. For example, 10 objects can be considered as one group of 10.

unplugged code (coding)

A set of instructions that can be performed without the use of a computer or device. Usually used to support the learning of writing and executing code.

vanishing point

The point at which receding parallel lines viewed in perspective appear to converge. *See also parallel lines.*

variable

An unspecified value often represented using a letter or a symbol; for example, the number of students can be represented by the letter " n ". In coding, a variable is a temporary storage location for a piece of data; for example, a numerical value or a series of characters.

variable (data)

An attribute, number, or quantity that can be measured or counted.

vector

A quantity that has both direction and distance (magnitude). For example, a translation vector could be "right 4, down 3", or described on the Cartesian plane as $(+4, -3)$.

Venn diagram

A diagram consisting of overlapping and/or nested shapes used to show what two or more sets have and do not have in common.

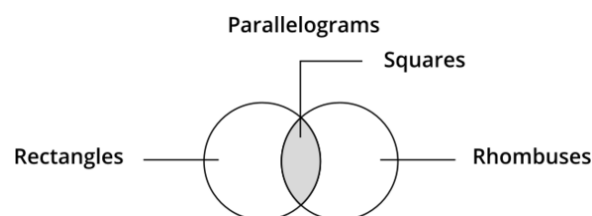

vertex (plural: vertices)

The common endpoint of the two line segments or rays of an angle. *See also* **angle**.

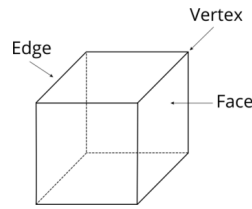

vertical

Perpendicular to the horizon; parallel to a wall or the sides of a page. *See also* **horizontal**, **parallel**.

vertical format

In written computation, a format in which numbers are arranged in columns to facilitate the application of standard algorithms. *See also* **horizontal format**.

$23 + 48 =$	$\begin{array}{r} 23 \\ + 48 \\ \hline \end{array}$
Horizontal format	Vertical format

vertices

See **vertex**.

volume

The amount of space occupied by an object; measured in cubic units, such as cubic centimetres.

whole number

A positive number, including zero, that has no decimal or fractional parts; for example, 0, 1, 2, 3, 4, 5,

whole number rods

See **relational rods**.

wire transfer

An electronic transfer of funds between accounts in financial institutions in Canada and around the world.

x-axis

The horizontal number line on the Cartesian plane. *See also* **Cartesian plane**.

x-intercept

The x -coordinate of a point at which a line or curve intersects the x -axis.

y-axis

The vertical number line on the Cartesian plane. *See also* **Cartesian plane**.

y-intercept

The y -coordinate of a point at which a line or curve intersects the y -axis.

zero property of addition and subtraction

The notion that 0 added to or subtracted from any number results in the same number, i.e., $n + 0 = n$ and $n - 0 = n$.

zero property of multiplication

The notion that the product of a number multiplied by 0 is 0, i.e., $n \times 0 = 0$.