

# CMS 356

Voltage and Current Amplifier



## Highly versatile and user friendly

The CMS 356 is a voltage and current amplifier for signals provided by any signal source, such as a digital real-time power system simulator, or a CMC test set. The high-amplitude and high-power current outputs make it suitable for testing modern numerical relays and high-burden electromechanical relays.

The outputs of the voltage amplifier and the current amplifier are galvanically separated from each other and also from the mains. Configuration and monitoring of the device status of the CMS 356 amplifier can be performed via the easy-to-use web interface.

6 Low level analog outputs

6 Low level analog inputs



Voltage outputs:  
4 x 300 V or 2 x 600 V

Current outputs:  
6 x 32 A / 6 x 430 VA or  
3 x 64 A / 3 x 860 VA or  
1 x 128 A / 1 x 1000 VA

Generator combination socket:  
3 x 300 V and 3 x 32 A

## Amplifier for power system simulations

For hardware-in-the-loop tests, the CMS 356 is the link between a real-time power system simulator and the protection relay. The signals received from the power system simulator are amplified and fed into voltage and current transformer inputs of the devices under test. The Sampled Values amplifier feature of the CMS 356 and its digital interface significantly increase test setup flexibility.

## Expansion of CMC test sets

When test requirements exceed the specifications of a CMC test set itself, the CMS 356 provides additional output channels or output channels with higher amplitudes and power (for example for testing busbar differential protection, transformer differential protection or synchronizer devices).

The CMS 356 is controlled through the low level interface of CMC test sets. With the LLO-2 option, the CMC test sets provide 12 low level output channels.



### Your benefits

- > Numerous output configurations (3 x 300 V + 3 x 64 A or 6 x 32 A, ...)
- > Parallel connection of several CMS 356 amplifiers for even higher current amplitudes
- > Digital connection to power system simulators using Sampled Values
- > Easy-to-use web interface

[www.omicronenergy.com/CMS356](http://www.omicronenergy.com/CMS356)



# Parallel connection of multiple CMS 356 amplifiers

For even higher current amplitudes (for example, greater than  $3 \times 64$  A), users can comfortably connect multiple CMS 356 amplifiers in parallel to the same device under test. For example, by connecting two CMS 356 units,  $3 \times 128$  A or  $6 \times 64$  A are possible; with three CMS 356 units,  $3 \times 192$  A. This makes it possible to meet the requirements of very demanding tasks such as the performance evaluation of protection devices according to IEC 60255 standards (-121, -187-1, ...).

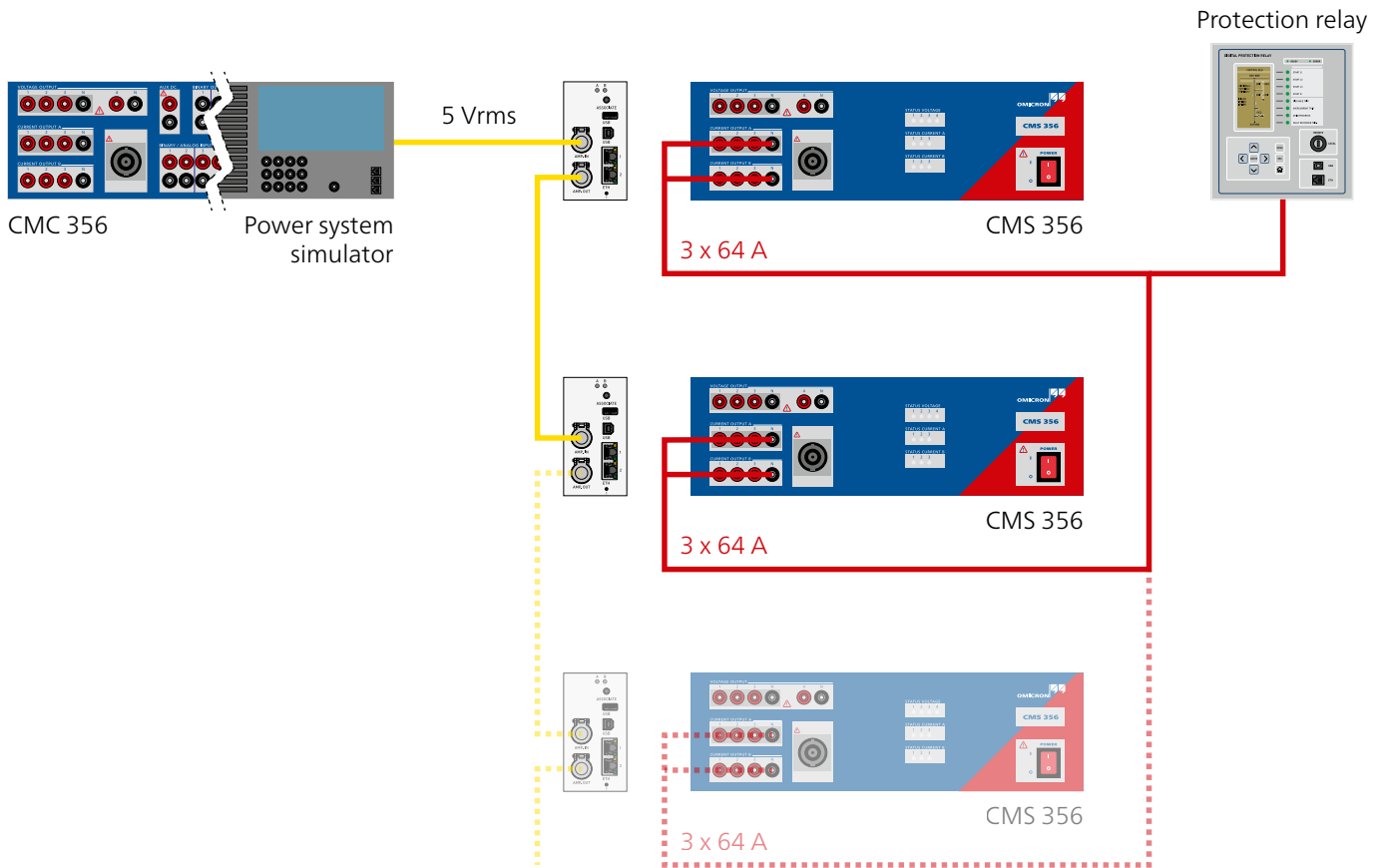

OMICRON offers a future-proof IEC 60255 testing solution for performance evaluation of your relays. It includes:

- > More than 200 000 predefined test shots for IEC 60255-121 and IEC 60255-187-1
- > Automated documentation, evaluation and display of test results

For more information, please visit:  
[www.omicron.energy/iec60255](http://www.omicron.energy/iec60255)

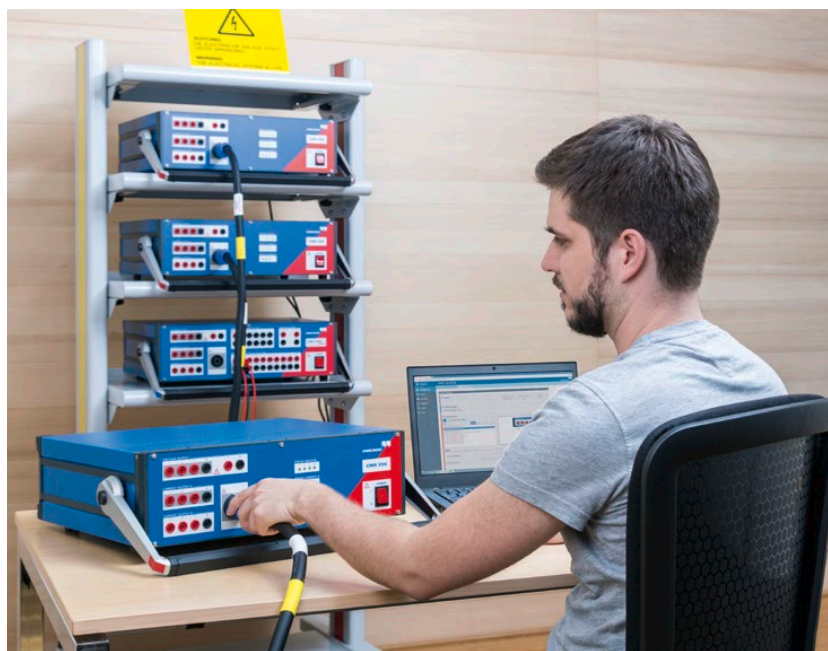

# Powerful link in power system simulations

The CMS 356 amplifier supports a digital connection via an Ethernet port to a real-time simulator for testing protection devices. The instantaneous digital values that are transmitted by the simulator as Sampled Values are amplified by the CMS 356 into analog voltage and current signals before being output to the protection device that needs to be tested.

The CMS 356's functionality as a Sampled Values amplifier outstandingly increases test setup flexibility: Usually, a CMS 356 is controlled via analog low-level signals (for example,  $\pm 10$  V). However, these signals require special cables, which are limited in length and must always be connected directly to the outputs of the simulator. Yet with the CMS 356's ability to act as a Sampled Value amplifier, these restrictions completely disappear.

The CMS 356 amplifier can process up to two streams of IEC 61850 Sampled Values via its Ethernet interface and it can be used to control the voltage and current outputs. The real-time simulator and amplifier are time synchronized with each other for the reliable and stable generation of output signals, which takes place via the Ethernet connection using the IEEE 1588 Precision Time Protocol (PTP).

## Closed-loop test setup with digital interface:

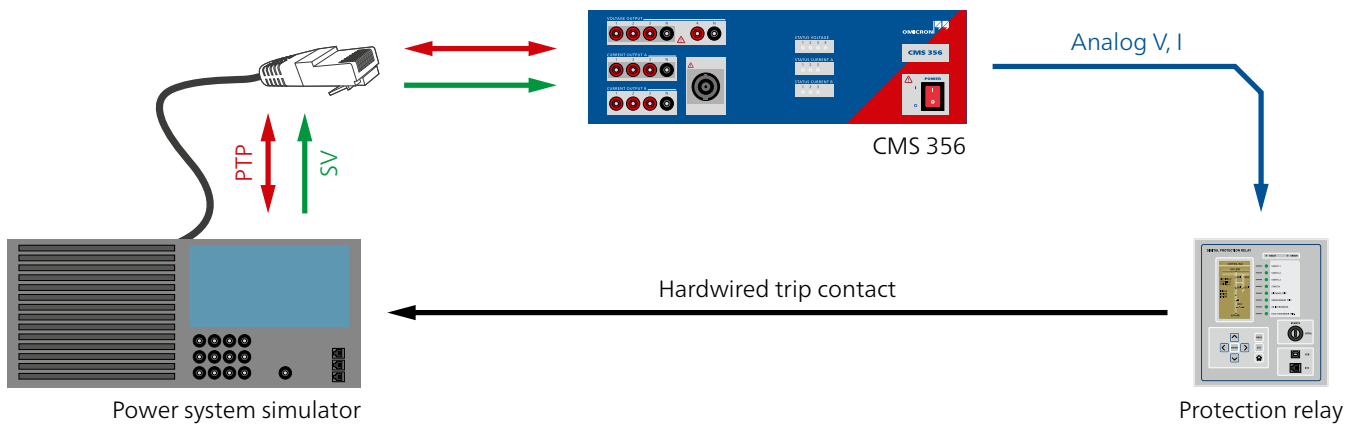

## Closed-loop test setup with low-level interface:

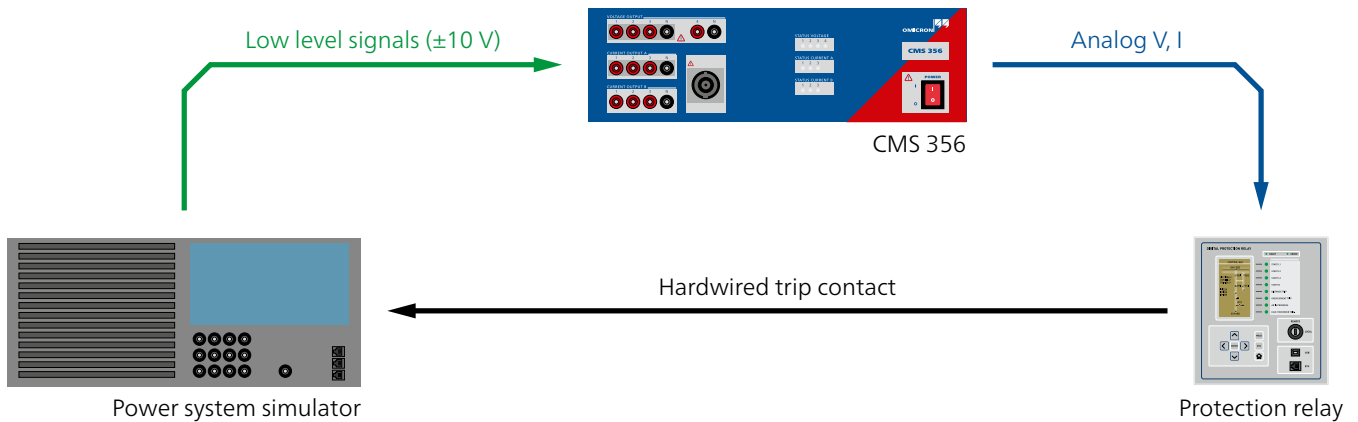

# Easy to use web interface

The operation, configuration and status monitoring of the CMS 356 are easily possible via the web interface with any standard web browser. The current states of the current and voltage outputs as shown on the front panel of the CMS 356 are visualized. In addition, the configuration settings and message history of the amplifier can be tracked. Thus, users are always up to date, even if the amplifier and the operating PC (or workstation) are physically separated.

**General**

Input type:  Analog  Sampled Values

Analog input range:  ±7.071 Vpeak (5 Vrms)  ±10 Vpeak (7.071 Vrms)

Overload sensitivity: Low

Overload indication: 5

Fan mode:  Auto  Max

**Voltage outputs**

3x300V, 85VA @ 85V, 1Arms

**Current outputs**

Enable current outputs

Filter: 32 A | 64 A | 128 A | None

6x32A, 430VA @ 25A, 25Vrms  
 3x32A, 430VA @ 25A, 25Vrms  
 3x32A, 430VA @ 25A, 25Vrms  
 3x32A, 430VA @ 25A, 25Vrms, IE automatically calculated  
 3x64A, 860VA @ 50A, 25Vrms  
 3x32A, 860VA @ 25A, 50Vrms  
 1x32A, 1740VA @ 25A, 100Vrms  
 1x64A, 1740VA @ 50A, 50Vrms  
 1x128A, 1000VA @ 80A, 25Vrms  
 2x64A, 500VA @ 40A, 25Vrms

Details

Limit current output: 64 Arms | 90.5 Apeak

Residual current factor: 1

**Mapping**

Inputs (AMP. IN)	Output signals					
	V1	V2	V3	I1	I2	I3
1	✓					
2		✓				
3			✓			
4				✓		
5					✓	
6						✓

**Easy and intuitive:** The “Configuration” page provides the interface to configure the CMS 356 amplifier. The panes can be simply collapsed and expanded. When collapsed, they provide a clear overview and summary of the settings. When expanded, they show detailed settings information, and changes can be made:

**General settings:** The input type (analog or Sampled Values) and range as well as the overload sensitivity are configured here.

**Voltage outputs/Current outputs:** All possible configurations for voltage/current outputs are shown here. To make wiring easier the output connections for the selected configuration are visualized in the figure.

**Mapping:** The Mapping table shows a list of available logical output signals according to the selected configurations. Each output signal can be mapped to an input by just checking the corresponding cell. Users only need to map the output signals required for the test.

**Configuration**

Please select a configuration from below.

**Default configurations**

Configuration	Input type	Voltage outputs	Current outputs	Mapped signals
Device Off	±7.071 Vpeak	Voltage outputs disabled	Current outputs disabled	No signals mapped
3x300V, 3x32A	±7.071 Vpeak	3x300V, 85VA @ 85V, 1Arms	3x32A, 430VA @ 25A, 25Vrms	6 signals mapped
6x32A	±7.071 Vpeak	Voltage outputs disabled	6x32A, 430VA @ 25A, 25Vrms	6 signals mapped

**User configurations**

No user configurations.





**Time-saving:** For frequent and recurring tasks, pre-configurations are already stored as standard. These configurations can, of course, be adapted to individual requirements and can be stored on the amplifier as well as shared with other users.

# CMS 356 accessories

The following accessories are included with the CMS 356 standard delivery but can also be ordered separately.

	Description	Order No.
	Country-specific power cord 3 m / 9.8 ft	
	Ethernet patch cable 1.5 m / 4.9 ft	VEHK0022
	Ethernet patch cable 3 m / 9.8 ft	VEHK0622
	USB connection cable 2 m / 6.6 ft	VEHK0025
	Leads with 4 mm safety plugs (6 x red, 6 x black) 2 m / 6.6 ft	VEHK0112
	Flexible terminal adapters (12 x black)	VEHS0009
	Flexible test lead adapters with retractable sleeve (6 x red, 6 x black)	VEHK0024
	Low-level connection cable CMC-CMS 356 1 m / 3.3 ft	VEHK0003
	Generator combination cable 3 m / 9.8 ft	VEHK0154
	Soft bag	VEHP0012

## Optional accessories<sup>1</sup>

	Description	Order No.
	<p><b>Wiring accessory package</b> For connecting test objects to CMS 356 amplifiers, consisting of:</p> <ul style="list-style-type: none"> <li>12 flexible test lead adapters with retractable sleeve for connections to non-safety sockets</li> <li>4 flexible jumpers for paralleling current outputs or shorting neutrals of binary inputs</li> <li>8 crocodile clips for contacting pins or screw bolts</li> <li>12 flexible terminal adapters for screw-type terminals</li> <li>20 cable lug adapters for M4 (0.15 in) screws</li> <li>10 cable lug adapters for M5 (0.2 in) screws</li> <li>10 cable ties 150 mm / 5.9 in long</li> <li>1 accessory bag</li> </ul>	VEHZ0060
	<p><b>Low level connection cable with open ends</b> To connect a third-party signal source to the low-level analog inputs ("AMP. IN") of a CMS 356 amplifier. 5 m (16.4 ft) long</p>	VEHK0312
	<p><b>Mounting kit for 19-inch rack</b> For integrating CMC test sets and CMS amplifiers in 19-inch racks.</p>	VEHZ0026
	<p><b>Mini Wi-Fi USB Adapter</b> For wireless control of the CMS 356.<sup>2</sup></p>	VEHZ0095
	<p><b>Transport case</b> Heavy-duty transport case with wheels and extendable handle.</p>	VEHP0021

<sup>1</sup> Non-exhaustive list. For the complete list please visit our website: [www.omicronenergy.com/cms356](http://www.omicronenergy.com/cms356)

<sup>2</sup> Wi-Fi is subjected to technical and legal constraints. For more information please contact your local OMICRON office or sales partner.

# Overview of technical specifications<sup>1</sup>

## CMS 356

### Current amplifier

Setting range	6-phase AC (L-N)	6 x 0 ... 32 A
	3-phase AC (L-N)	3 x 0 ... 64 A (Group A II B)
	1-phase AC (LL-LN)	1 x 0 ... 128 A (Group A II B)
	DC (LL-LN)	1 x 0 ... ±180 A (Group A II B)
Power	6-phase AC (L-N)	6 x 430 VA typ. at 25 A 6 x 250 W guar. at 20 A
	3-phase AC (L-N)	3 x 860 VA typ. at 50 A 3 x 500 W guar. at 40 A
	1-phase AC (L-L-L-L)	1 x 1740 VA typ. at 25 A 1 x 1100 W guar. at 20 A

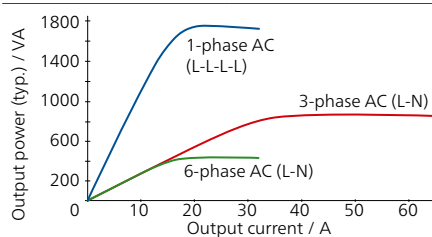

Accuracy	Error < 0.1 % rd. <sup>2</sup> + 0.04 % rg. <sup>2</sup> typ. Error < 0.3 % rd. + 0.1 % rg. guar.
Distortion (THD+N) <sup>3</sup>	< 0.1 % typ., < 0.3 % guar.
Resolution	1 mA
Max. compliance voltage (L-N)/(L-L)/(L-L-L-L)	35 Vpk / 70 Vpk / 140 Vpk

### Voltage amplifier

Setting range	4-phase AC (L-N)	4 x 0 ... 300 V
	2-phase AC (L-L)	2 x 0 ... 600 V
	DC (L-N)	4 x 0 ... ±300 V
Power	4-phase AC (L-N)	4 x 75 VA typ. at 100 ... 300 V 4 x 50 VA guar. at 85 ... 300 V
	3-phase AC (L-N)	3 x 100 VA typ. at 100 ... 300 V 3 x 85 VA guar. at 85 ... 300 V
	1-phase AC (L-L)	1 x 275 VA typ. at 200 ... 600 V 1 x 250 VA guar. at 200 ... 600 V

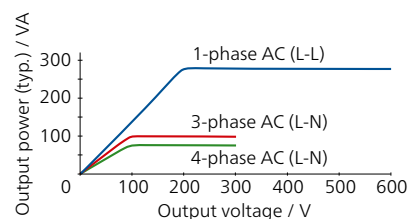

Accuracy	Error < 0.06 % rd. <sup>2</sup> + 0.02 % rg. <sup>2</sup> typ. (at 0 ... 300 V) Error < 0.16 % rd. + 0.04 % rg. guar.
Distortion (THD+N) <sup>3</sup>	0.03 % typ., < 0.1 % guar.
Ranges	150 V / 300 V
Resolution	5 mV / 10 mV in range 150 V / 300 V

### Amplifiers, general

Bandwidth (-3 dB)	> 2.5 kHz typ., > 1 kHz guar.
Propagation delay (with input type "analog")	500 μs (error < ±2 μs typ., ±5 μs guar.)
Output delay (with input type "Sampled Values")	Configurable, setting range: 1000 – 6000 μs

### Analog inputs

Number	6
Input impedance	47 kΩ
Input voltage range (selectable)	±10 Vpk (7.071 Vrms) ±7.071 Vpk (5 Vrms)
Amplification at 5 Vrms input range	Voltage output: 60 V/V Current output: 6.4 A/V
Galvanic isolation input/output	Yes

<sup>1</sup> The full technical specifications are available on request. All data specified are guaranteed, except where indicated otherwise. OMICRON guarantees the specified data for one year after factory calibration, within 23 °C ±5 °C / 73 °F ±10 °F in the frequency range from 10 to 100 Hz and after a warm-up phase > 25 minutes

<sup>2</sup> rd. = reading, rg. = range

<sup>3</sup> THD+N: at nominal values, 50/60 Hz and 20 kHz measurement bandwidth





## IEC 61850

### Subscribing

Sampled Values	IEC 61850-9-2 ("9-2LE") IEC 61869-9
Number of streams	2
Sampling frequency	4000 Hz – 1 sample per packet 4800 Hz – 1 sample per packet 5760 Hz – 1 sample per packet 12800 Hz – 8 samples per packet 15360 Hz – 8 samples per packet 4800 Hz – 2 samples per packet 14400 Hz – 6 samples per packet

### Time synchronization

#### CMS 356 to external reference

Precision Time Protocol (PTP)	IEEE 1588-2008 IEEE C37.238 (Power Profile) IEC 61850-9-3 (Utility Profile)
-------------------------------	---

#### Internal system clock

Frequency drift	< 0.37 ppm / 24 h < 4.6 ppm / 20 years
-----------------	---

### Power supply

Nominal input voltage	100 ... 240 VAC, 1-phase (50/60 Hz)
-----------------------	-------------------------------------

### Environmental conditions

Operation temperature <sup>1</sup>	0 ... +50 °C / +32 ... +122 °F
Storage temperature	-25 ... +70 °C / -13 ... +158 °F
Humidity range	Relative humidity 5 ... 95 %, non-condensing
Acoustics – noise emission	ISO 7779
Idle – full load	47 – 55 dB(A)

## Equipment reliability

### Electromagnetic interference (EMI)

International / Europe	IEC/EN 61326-1, IEC/EN 61000-6-4, IEC/EN 61000-3-2/3, CISPR 32 (Class A)/EN 55032 (Class A)
North America	47 CFR 15 Subpart B (Class A) of FCC

### Electromagnetic susceptibility (EMS)

International / Europe	IEC/EN 61326-1, IEC/EN 61000-6-2/5, IEC/EN 61000-4-2/3/4/5/6/8/11/16/18
------------------------	--

### Safety

International / Europe	IEC/EN 61010-1
North America	UL 61010-1, CAN/CSA-C22.2 No. 61010-1

### Mechanical tests

Vibration	IEC 60068-2-6
Shock	IEC 60068-2-27

## Miscellaneous

Weight	16.3 kg / 35.9 lbs
Dimensions (W x H x D, without handle)	450 x 145 x 390 mm / 17.7 x 5.7 x 15.4 in
PC connection	2 PoE (Power over Ethernet) ports USB Type-B port (PC) USB Type-A port (optional Wi-Fi adapter for wireless control)

## Certifications

Developed and manufactured under an ISO 9001 registered system

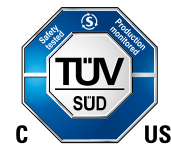

<sup>1</sup> For an operational temperature above +30 °C / +86 °F a duty cycle of down to 50 % may apply

We create customer value through ...

## Quality

You can rely on the highest safety and security standards



Superior reliability with up to

72

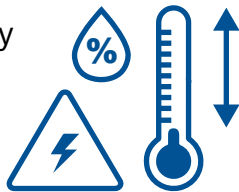

hours burn-in tests before delivery

100%

routine testing for all test set components

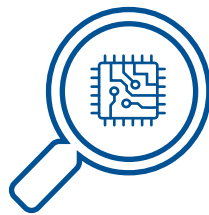

ISO 9001  
TÜV & EMAS  
ISO 4001  
OHSAS 18001



Compliance with international standards

## Innovation



... a product portfolio tailored to my needs

More than

200

developers

keep our solutions up-to-date

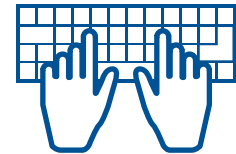

More than

15%

of our annual sales is reinvested in research and development

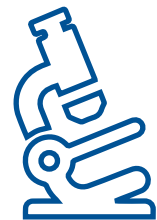

Save up to

70%

testing time through templates, and automation



— Support —



Professional technical support at any time

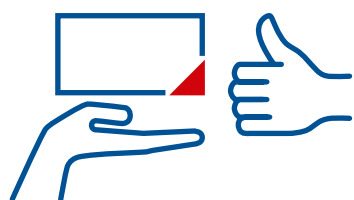

Loaner devices help to reduce downtime

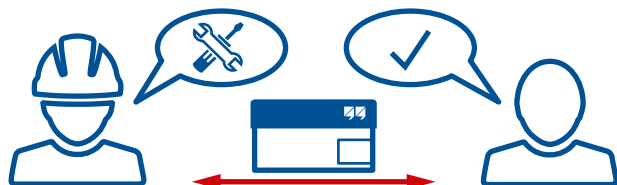

Cost-effective and straight-forward repair and calibration

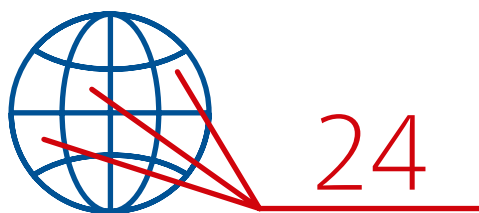

offices worldwide for local contact and support

— Knowledge —

More than

300



Academy and numerous hands-on trainings per year

Frequently OMICRON hosted user meetings, seminars and conferences



to thousands of technical papers and application notes

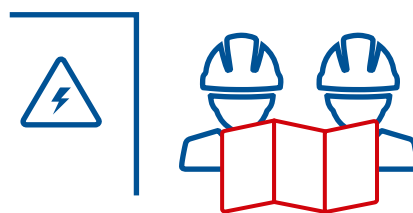

Extensive expertise in consulting, testing and diagnostics

OMICRON is an international company serving the electrical power industry with innovative testing and diagnostic solutions. The application of OMICRON products allows users to assess the condition of the primary and secondary equipment on their systems with complete confidence. Services offered in the area of consulting, commissioning, testing, diagnosis and training make the product range complete.

Customers in more than 160 countries rely on the company's ability to supply leading-edge technology of excellent quality. Service centers on all continents provide a broad base of knowledge and extraordinary customer support. All of this together with our strong network of sales partners is what has made our company a market leader in the electrical power industry.

The following publications provide further information on the solutions described in this brochure:



Product catalog

For more information, additional literature, and detailed contact information of our worldwide offices please visit our website.