

Selection Guide

# VI.AVI Data Center Use Case Test Guide

Data centers have become the epicenters of the digital world, and thus continue to grow in speed, complexity, and importance. Whether an efficiently-run data center is a means to deliver a service, e.g a Cloud Service Provider (CSP), or if the data center is the primary business, e.g. a multi-tenant/colocation data center (MTDC) – testing is a critical element in meeting customer SLAs and/or internal performance objectives.

In a modern data center, there are thousands of links, cables, transponders, and connections, or put frankly – potential points of failure. With limited resources, where do you test? The following is a brief list of key test use cases for data center operators grouped into two categories; external and internal test requirements. First, the external use cases;

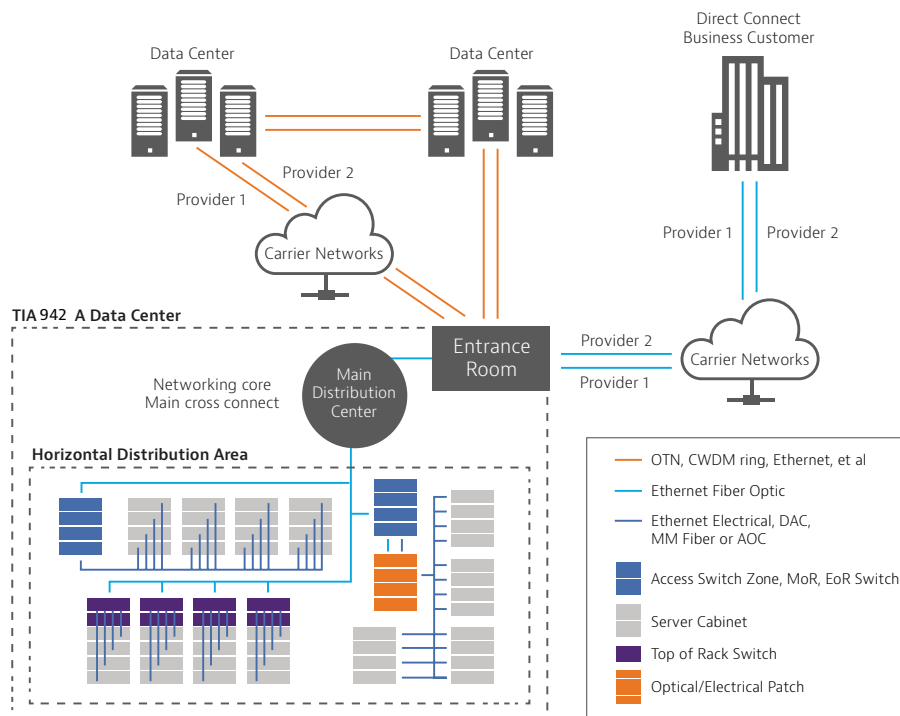

1486.900.0523

Typical Data Center Internal and External Connectivity

## (External) Use Case 1. Data Center to Data Center Interconnect (DCI) – Leased Connections

### Problem:

Due to the importance of the data stored in data centers, most data center operators (DCOs) back up data to yet another data center via high-capacity connections to ensure quick disaster recovery (DR). To maintain the integrity of those valuable connections and to verify SLAs, a DCO operations technician must perform tests on Ethernet

line rates up to 400G, as well as OTN, CWDM, or DWDM circuits. Similarly, DCOs must occasionally test circuits privately connected to an enterprise, usually via Ethernet, so isolate transmission problems.



### Solution:

The VIAVI T-BERD/MTS-5800-100G is the most versatile test platform in the industry, able to perform tests on OTN, CWDM/DWDM, and Ethernet up to 100G with dual ports. Tests can be performed with a T-BERD/MTS-5800-100G on both sides of the circuit, or with a T-BERD/MTS-5800-100G on one side, and a MAP-2100, which is a rack-mounted TBERD 5800-100G that can be controlled remotely (for unmanned locations), on the other.

Many data centers depend heavily on 400GE circuits for interconnect, a technology which employs a different modulation scheme (PAM-4) than lower line rates, and different transmission characteristics (i.e. error-free transmission is not possible). The VIAVI OneAdvisor 1000 and OneAdvisor 800 Transport are portable network testers designed to address the specific test challenges of 400GE transmission and are equipped to support the new interfaces such as ZR/ZR+.

Critical tests include industry-based:

- Enhanced RFC-2544
- Y.1564 SAMComplete
- RFC-6349 TrueSpeed

In addition, with such big and critical circuits connecting data centers, testing the underlying fiber integrity on those circuits is also prudent. With the same hand-held tester, techs can also do fiber testing with a 4100 Series OTDR, making the T-BERD/MTS-5800-100G, MAP-2100, and the OneAdvisor-1000 essential tools for today's modern data center.

## (External) Use Case 2. 200G Data Center Interconnect (DCI)

### Problem:

To address ever growing data loads, many DCOs are using higher order modulation to create 200G wavelengths over their DWDM systems, thereby doubling the capacity over the same fiber. While beneficial, the danger is not testing the system before adding live traffic to it. There may be limitations on a particular wavelength that prevent it from achieving a 200 Gbps transmission rate, limitations that cannot be known without stress testing the wavelength before putting it into service. Some DCOs don't test these new 200G links simply because they don't have the test capability, a challenge that extends from the data layer down to the optical transmission layer when validating Optical Signal to Noise Ratio (OSNR) and optimizing launch power levels for active EDFA and ROADM based DCI in order to minimize BER.

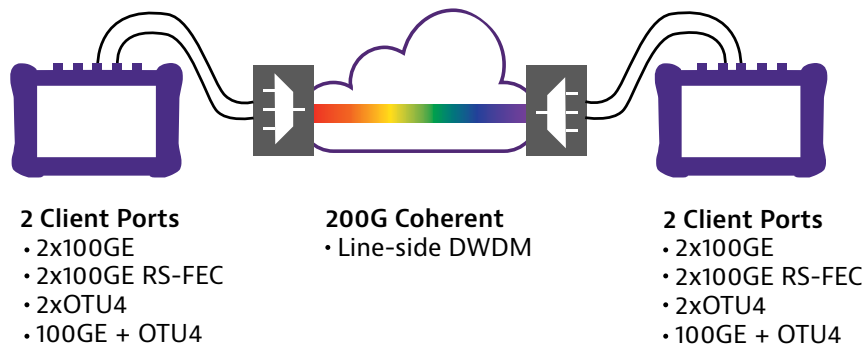

1485.900.0523

200G Coherent Data Center Interconnect Testing

### Solution:

With its two ports with test capacity up to 400GE, the OneAdvisor 800 stress test a data center's critical 200G WDM DCI link. An Optical Spectrum Analyzer (OSA) like the VIAVI OSA-110x or NanoOSA allows DCOs to perform DCI link commissioning and maintenance with in-band OSNR measurement of live channels, plus optimization of optical launch levels.

#### BER Tests

- QuickCheck
- Enhanced RFC-2544
- Y.1564 SAMComplete

#### Optical Spectrum and Correlation Analysis

- In-band OSNR
- Independent of traffic type or rate (100, 200, 400G)

## (External) Use Case 3. Dark Fiber DCI – Fiber Turn Up

### Problem:

Because of the criticality of DCI links, not to mention the expense, some DCOs are choosing to purchase or deploy their own dark fiber instead of leasing a managed service from a telco/MSO. Most likely the dark fiber was originally deployed to carry 10G services and fiber certification/qualification tests were probably not performed because 10G services are less sensitive to insertion loss, optic return loss, dispersion, etc. Testing was not necessary as a result. The challenge is that DCOs aren't lighting dark fiber to put 10G on them, it's now 100G and more. If the dark fibers were not proofed for 100G, then service turn-up and performance could be problematic. Although 100G Coherent transponders use PMD and CD compensation mechanisms, there are limits to what can corrected/tolerated which is becoming more apparent with 200G and 400G. Also, legacy fibers have more loss/attenuation variance from fiber to fiber, so a baseline is needed to ensure that the fiber and specific wavelengths can support the high speeds needed for DCI.



### Solution:

The VIAVI T-BERD/MTS with Fiber Complete PRO is a unique solution that enables bi-directional Insertion Loss (IL), Optical Return Loss (ORL) and OTDR testing, with real-time bidirectional OTDR event loss averaging (TrueBIDIR), from one optical port with a single press of a button. To complement Fiber Complete PRO, the Optical Dispersion Modules (ODM) allow full fiber characterization of Chromatic Dispersion (CD), Polarization Mode Dispersion (PMD) and Attenuation Profile (AP) in under two minutes. Both applications use fully automated test scripts allowing for a full suite of fiber characterization tests. Optical Spectrum Analyzers (OSA) then allow for measurement of OSNR.

- FiberComplete PRO for T-BERD/MTS-2000, -4000 V2, and OneAdvisor 800
- ODM for OneAdvisor 800
- OSA-110x for OneAdvisor 800

## (External) Use Case 4. DCI Fiber Monitoring

### Problem:

DCOs must constantly monitor the mission-critical fiber optic links between locations, and be quickly alerted to fiber cuts, degradation, or even intrusion. Without the proper technology and alarm system, it can take days to pinpoint the location of the cut, potentially triggering outage clauses in customer SLAs.

A second consideration, and potentially more important, is that tapping into a fiber network can't be detected by monitoring the data layer and these non-intrusive taps give access to 100% of data traversing a fiber link.

### Solution:

The VIAVI FTH-5000 is a rack-mounted OTDR that continuously monitors critical fiber connections. It can be run right out of the box with no training or IT configuration. When a fiber event occurs, it alerts users within minutes (email, SMS and SNMP) to lower MTTR by at least 30%, improve network security, and boost SLA performance.

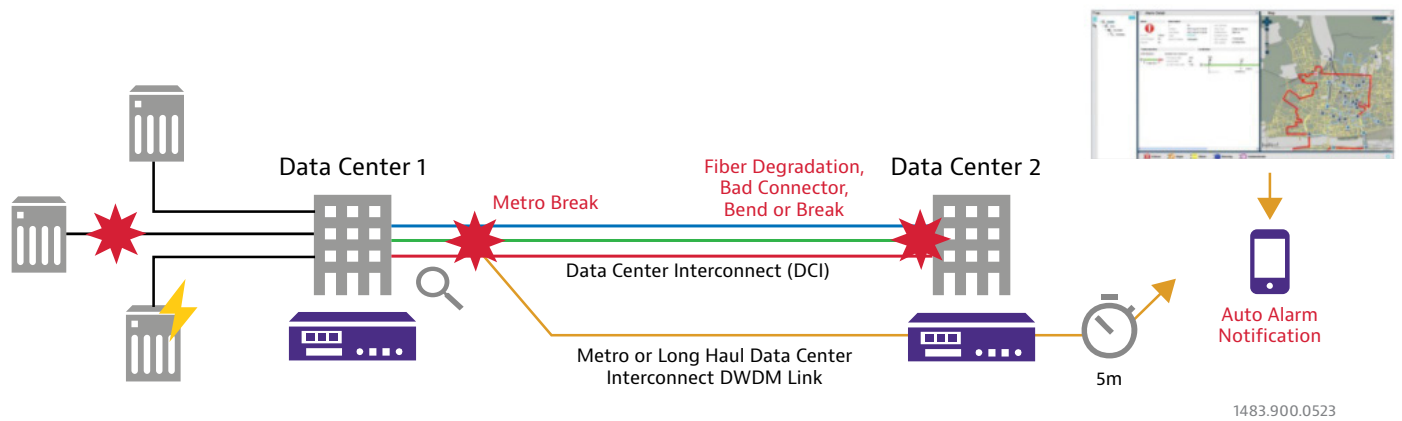

Auto Detect Vulnerabilities in a Data Center Network

## (External) Use Case 5: GPS Antenna Placement for Timing Applications

### Problem:

Many data centers host timing-sensitive applications, like financial trading, that are accessed by many end-users at different locations via a packet-network. These applications tolerate only tiny amounts of latency across the network links. To mitigate that, functionality such as NTP and/or PTP/1588, are added to networks, typically using GPS signals as a timing source. The challenge for the data center technician is where to position the roof-top antennas to maximize GPS signal strength and number of satellites tracked, while minimizing noise and interference.

In addition, even if the antenna is positioned in an optimal location, the cable connecting it on the roof through the data center is subjected to many sources of EMI which cause signal attenuation, leading to bad timing information.

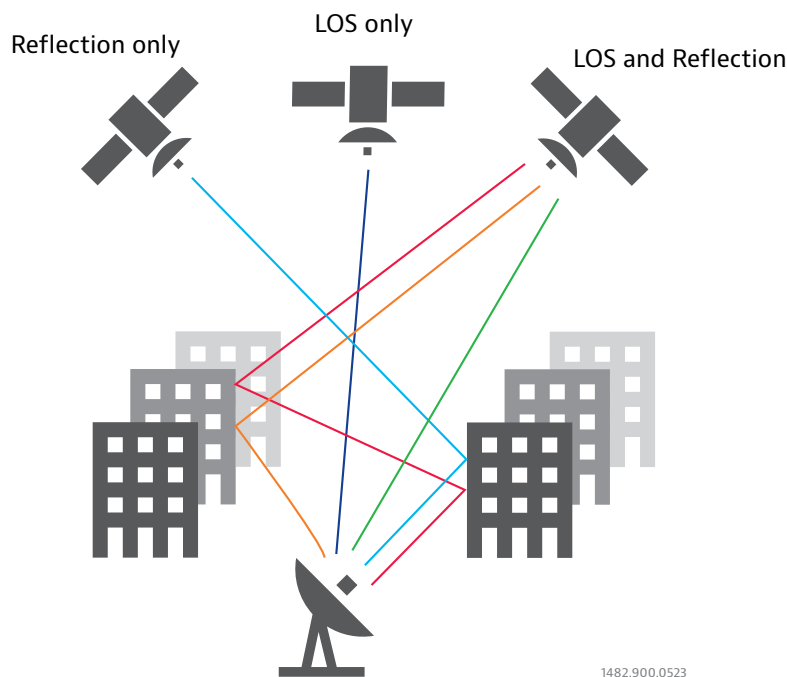

GPS Antenna Placement for Data Center Applications

### Solution:

The OneAdvisor 800 and the T-BERD/MTS-5800 family of network testers have GNSS receivers built-in as standard equipment (or can be paired with a timing expansion module). These portable network testers allow technicians to scout and test satellite reception and signal quality in multiple locations around a building or on rooftops to optimize antenna positioning. Once the optimal antenna location has been determined, the same hand-held device can verify cable integrity, signal quality and noise ratio prior to GPS receiver and Time Server activation.

## (External) Use Case 6. DCI Network Performance Monitoring

### Problem:

While network transmission quality is critical when a circuit is activated, it is equally important post turn-up, when live customer traffic is running on the network. After turn-up a DCO must focus on monitoring the availability of network, round the clock.

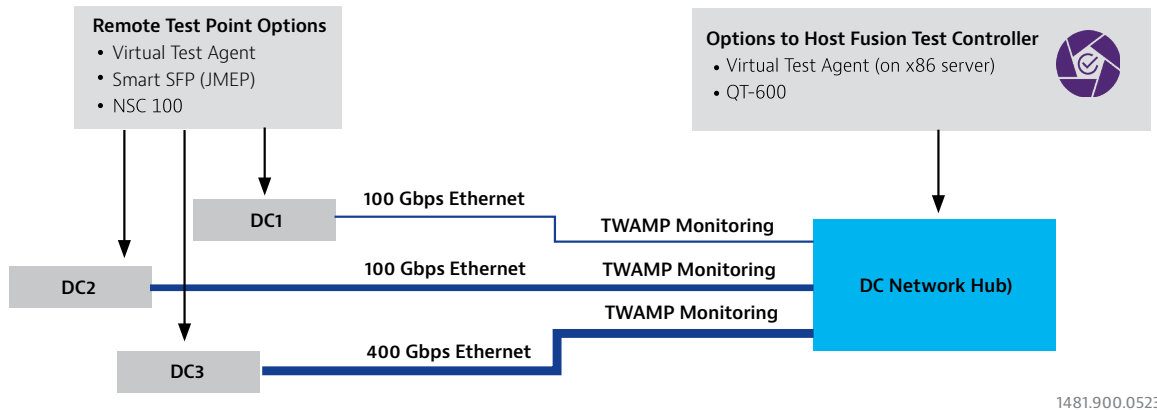

Performance Monitoring a Data Center Network with Fusion

### Solution:

VIAVI Fusion is a software-based test platform that can be hosted on generic servers (X86 servers) and can integrate multiple types of physical VIAVI devices and agents as test endpoints in almost any combination.

The Fusion controller can be deployed centrally for the pro-active monitoring of DCI links, continuously generating test packets between different test points in the network via TWAMP, or “two-way active monitoring protocol, alerting the DCO if latency spikes, for example.” The permanent surveillance of round-trip-times (RTT) and frame loss ratio (FLR) provides valuable insights into the availability and latency in a multi-data center network.

## (Internal) Use Case 7. Intra Data Center Bit Error Rate Testing

### Problem:

A DC tenant wants to know about the transmission performance within the data center, from Meet-me-Room (MMR) to the customer rack or cage, or from the rack to another service provider on another floor, etc. The transmission quality is likely very high, however the DCO has no way to provide the customer with a measurement and a report to verify the SLA.

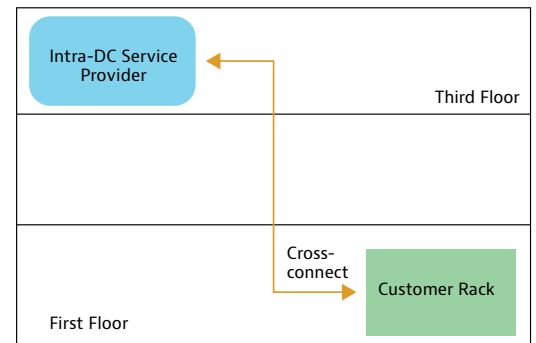

Intra Data Center BER Testing

1480.900.0523

### Solution:

The VIAVI OneAdvisor 1000 and 800 provide precise measurements of network KPIs (latency/packet delay, frame loss, jitter/inter-packet delay variation, and burstability) down to the nano second, which are required for such short network links. In addition, for every test conducted the OneAdvisors generate an easy to read report that can be printed out, e-mailed to the customer, or stored in the cloud via StrataSync.

## (Internal) Use Case 8. Ensuring Clean Fiber Connections

### Problem:

A fiber cross-connect cable must be run from the MMR inside the data center to the customer's extended demarc at their rack/cage, or between racks, which are patch panel-to-patch panel connections. These fiber connections have very strict loss budgets and are often the source of performance degradation. The addition of Multi-fiber Push On (MPO) connectors and ribbon fibers carrying 12 or 24 fibers in a single cable only complicates the situation.

Contaminated fiber connections are the #1 cause of troubleshooting and optical network downtime. Therefore, the most critical element to safeguarding quality fiber connections is ensuring a proper end-face condition. When working with fibers only a few microns wide, any contaminant can be catastrophic.

### Solution:

Proactively inspect all fiber connectors prior to ever connecting them. VIAVI fiber inspection solutions make it fast and easy to ensure that fiber inspection is performed when handling every fiber connector in the Data Center. Our FiberChek probe microscope and FiberChek Sidewinder (optimized for MPO) provide fast, intuitive and automated fiber inspection capabilities in a single handheld device for both simplex and MPO fiber connections.

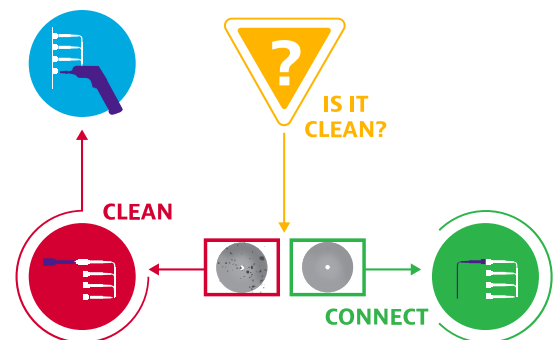



## (Internal) Use Case 9. Testing and Troubleshooting Physical Cabling Infrastructure

### Problem:

While the physical cabling is initially installed and certified to industry standards during network construction, several factors can change after installation (usually during moves, adds, and changes that cause network problems and downtime.

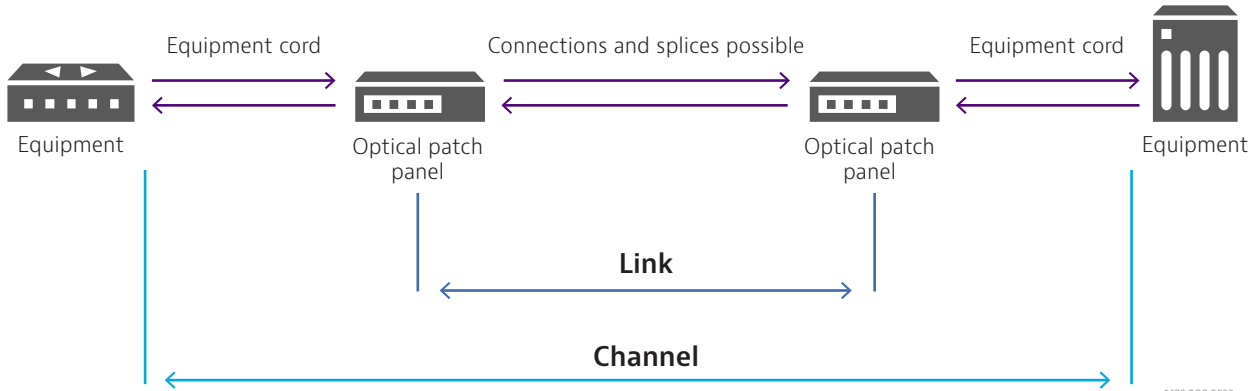

Typical Data Center Physical Cabling Infrastructure

### Solution:

Those cross-connect cables should be certified against industry standards. The VIAVI OLTS and MPOLx optic loss test sets provide the necessary tests for basic tier 1 fiber certification of length, optic loss and correct polarity (especially important with MPO) enabling fast and accurate testing for single and multi-mode fibers with generation of certification reports. Similarly, the VIAVI T-BERD/MTS-2000 or 4000 V2 with integrated OTDR and MPO switch modules provides an all-in-one solution to troubleshoot network issues by pinpointing the exact location of any event causing excessive loss. For copper testing, the Certifier10G gives technicians the ability to test for length, loss, and polarity, while the Certifier40G can test BOTH copper or fiber optic cables quickly and accurately. This insures that cables were terminated and installed properly and are capable of supporting the stringent demands of today's datacenters.

- Certifier40G
- MPOLx MPO Optic Loss Test Set
- OLTS-85 Optic Loss Test Set
- SmartPocket V2 OLS-35V2 (SM) and OLS-36V2 (SM + MM) Light Source
- SmartPocket V2 OLP-35V2 Broadband Power Meter
- T-BERD/MTS-2000 OTDR or SmartOTDR
- T-BERD/MTS-4000 V2 OTDR + MPO Switch + Enterprise-SLM
- FFL-050/-100 Visual Fault Locator
- FI-60 Live Fiber Identifier

## (Internal) Use Case 10. Active Optical Cable/Direct Attach Copper Test

### Problem:

Active optical cables (AOC) are widely used in DCs but they are difficult to test for errors because the optics are fused to each end. Direct Attach Copper (DAC) are copper cables but pose the same testing challenge. When a link will not come up, many DCOs will replace an AOC hoping that it was the root of the problem without knowing for sure. With a material cost and associated time and labor costs, a DCO wants to avoid mistakenly throwing away good AOC cables.

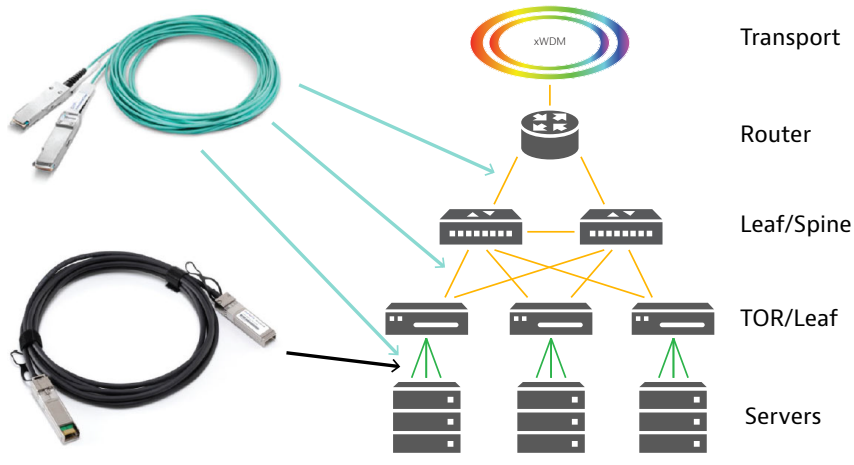

AOC/DAC Cable Applications

### Solution:

Such AOC/DAC cables and breakout cables should be tested against transmission defects with a Bit Error Rate test. The VIAVI OneAdvisor 1000 or 800 with the cable test script and report capabilities provides dual SFP28/QSFP+/QSFP28/QSFP-DD ports for quick and efficient testing of AOC/DAC cables.

## (Internal) Use Case 11. Optics Self-Test

### Problem:

The pluggable, optical transceiver modules (QSFP, CFPx and SFPx) on the ends of those cross-connect cables must also be checked to ensure they are working optimally.

### Solution:

The Optics Self-Test is a workflow tool on both the OneAdvisor 1000 and 800 to verify and troubleshoot performance issues related to high-speed optics. It is especially well suited to data center environments and helps isolate pluggable optics issues. This easy-to-use test integrates items such as a bit error theory algorithm, clock offset verification, and per-lambda power monitoring. For those Ethernet rates that use FEC, Optics Self-Test provides both pre-FEC and post-FEC results.

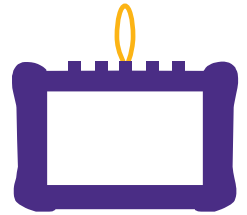

Optics Self-Test

Products	Associated Use Cases	Photo
<a href="#">OneAdvisor-800</a>	1,2,3,5,7,10,11	
<a href="#">OneAdvisor-1000</a>	1,2,3,5,7,10,11	
<a href="#">T-BERD/MTS-5800-100G</a>	1,2,10,11	
<a href="#">P5000i</a>	1,2,3,5,7	
<a href="#">MAP-2100</a>	1,2,10,11	
<a href="#">T-BERD/MTS-5800</a>	5,10,11	
<a href="#">FiberChek Probe</a>	8,9	
<a href="#">MPOLx</a>	8,9	
<a href="#">Fibercheck Sidewinder</a>	8,9	
<a href="#">Certifier 10G and 40G</a>	8,9	
<a href="#">Timing Expansion Module</a>	5	
<a href="#">TrueSpeed VNE</a>	1	
<a href="#">Fusion</a>	6	
<a href="#">Optical Dispersion Modules</a>	3	
<a href="#">OSA-110x module</a>	3	
<a href="#">OSA-500x module</a>	3	
<a href="#">SmartPocket V2</a>	9	
<a href="#">T-BERD/MTS-2000</a>	9	
<a href="#">T-BERD/MTS-4000 V2 &amp; MPO Switch Module</a>	9	
<a href="#">FTH-5000</a>	4	
<a href="#">ONMSi</a>	4	



Contact Us **+1 844 GO VIAVI**  
(+1 844 468 4284)

To reach the VIAVI office nearest you,  
visit [viavisolutions.com/contact](http://viavisolutions.com/contact).

© 2023 VIAVI Solutions Inc.  
Product specifications and descriptions in this  
document are subject to change without notice.  
Patented as described at [viavisolutions.com/patents](http://viavisolutions.com/patents)  
Dctg-sg-tfs-nse-ae  
30186101 908 0523