

J-BERT M8020A

High-Performance BERT

Master your next designs



Table of Contents

Introduction	3
J-BERT M8020A High-Performance BERT	5
Overview J-BERT M8020A High-Performance BERT.....	7
User Interface and Measurements	10
Specifications for J-BERT M8041A and M8051A High-Performance BERT Modules	14
Specifications Pattern Generator	15
Supplementary Inputs and Outputs of M8041A and M8051A.....	22
Supplementary Inputs and Outputs of M8041A and M8051A (Continued)	25
Jitter Tolerance Specifications	26
Pattern, Sequencer and Interactive Link Training	32
Specifications Analyzer (Error Detector).....	33
User Interface and Remote Control.....	38
System Software M8070B	39
General Characteristics and Physical Dimensions.....	43
Ordering Instructions	44
Recommended Accessories	45
Test Automation Software with Support of M8020A.....	45
Calibration and Productivity Services	45
Related Keysight Literature.....	46

Introduction

The high-performance Keysight Technologies J-BERT M8020A enables fast and accurate receiver characterization of single and multi-lane devices running up to 16 or 32 Gb/s.

The high-performance Keysight Technologies J-BERT M8020A enables fast and accurate receiver characterization of single and multi-lane devices running up to 16 or 32 Gb/s.

Key Features

- Data rates up to 8.5 and 16 Gb/s expandable to 32 Gb/s
- 1 to 4 BERT channels in a 5-slot AXIe chassis
- Integrated and calibrated jitter injection: RJ, PJ1, PJ2, SJ, BUJ, sinusoidal level interference (common-mode and differential-mode), SSC (triangular and arbitrary, residual) and Clock/2
- 8 tap de-emphasis, positive and negative
- Integrated and adjustable ISI
- Interactive link training for PCI Express 8 GT/s and 16 GT/s
- Interactive link training for USB 3.0 and USB 3.1
- DUT RX / BERT TX equalizer negotiation for 10GBASE-KR
- Built-in clock recovery and equalization
- All options and modules are upgradeable

Applications

The J-BERT M8020A is designed for R&D and test engineers who characterize and verify compliance of chips, devices, boards and systems with serial I/O ports up to 16 Gb/s and 32 Gb/s in the consumer, computer, mobile computing, datacenter and communications industry.

The J-BERT M8020A can be used to test popular serial bus standards, such as PCI Express®, SATA/SAS, DisplayPort, USB Super Speed, MIPI® M-PHY®, SD UHS-II, Fibre Channel, QPI, memory buses, backplanes, repeaters, active optical cables, Thunderbolt, 10/40 GbE/SFP+/QSFP, 100GbE/CFP2.

M8000 Series of BER Test Solutions

Simplified time-efficient testing is essential when you are developing next-generation computer, consumer, or communication devices.

The Keysight M8000 Series is a highly integrated BER test solution for physical layer characterization, validation, and compliance testing.

With support for a wide range of data rates and standards, the M8000 Series provides accurate, reliable results that accelerate your insight into the performance margins of high-speed digital devices.

Shift into high gear with the M8000 Series and take the design verification express lane.

M8000 Series of BER test solutions Highly integrated and scalable for simplified, time efficient testing



Figure 1 The M8000 Series BER Test Solution is highly integrated and scalable to address the test challenges of the next generation of high-speed digital receiver test.

- Multi-channel applications
- Interactive link training
- Analyzer equalization and clock recovery
- Expandable to higher data rates up to 32 Gb/s
- Higher integration: 16G BERT with 1-4 channels, jitter, de-emphasis

J-BERT M8020A High-Performance BERT

Enabling fast, accurate receiver characterization of single- and multi-lane devices running up to 16 or 32 Gb/s

Highest Level of Integration for Streamlined Test Setups

With J-BERT M8020A all receiver (RX) test capabilities are built-in: jitter sources, common and differential-mode level interference, and de-emphasis to emulate the transmitter (TX) of the device under test (DUT). In addition, M8020A provides a built-in reference clock multiplier for synchronization of the BERT pattern generator with the DUT's reference clock which can carry spread spectrum clocking (SSC). On the analyzer side, a built-in equalizer re-opens closed eyes and a clock recovery with adjustable loop bandwidth enables repeatable BER measurements.

With this high level of integration, a receiver test set-up with M8020A is now much easier to connect and more robust. Set up and debug time is shortened, calibration is simpler, and the frequency of recalibration is lower, resulting in more efficient use of overall test time.

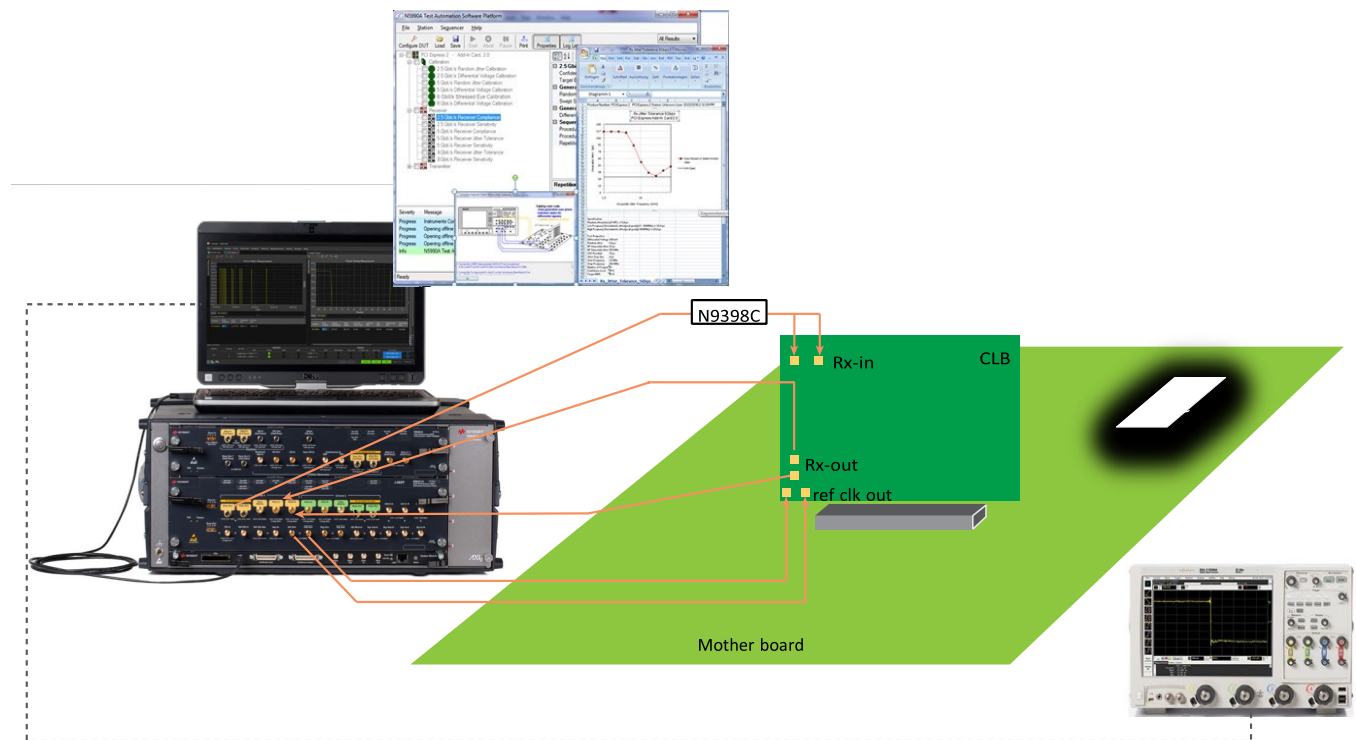

Figure 2 J-BERT M8020A streamlines complex receiver test setups. The example shows a PCIe 3 (8 GT/s) mother board RX test (CEM spec) with J-BERT M8020A connected via a compliance load board (CLB). J-BERT M8020A provides built-in de-emphasis, jitter sources, common-mode and differential mode interference (CMI, DMI), reference clock multiplier, clock recovery and continuous time linear equalizer (CTLE) – everything that is needed is built-in and calibrated.

Interactive Link Training to Fasten Loopback

The ever-increasing data rate of computer buses and datacom interfaces results in shrinking margins and the necessity to use equalization techniques in transmitters and receivers to compensate for the lossy channels caused by inexpensive PC board material or long cables. For the latest industry standards, such as PCI Express 3 or 4, SAS 12G, and backplanes such as 100GBASE-KR4, the link partners are required to optimize the TX de-emphasis and RX equalization combination. The RX takes the active part during this procedure. In order to do so, the BERT must be capable to understand the low-level protocol and to react accordingly, i.e. change its TX de-emphasis as requested. J-BERT M8020A can behave like a real link partner with its interactive link training capability. Currently supported are PCI Express in common reference clock architecture for 8 GT/s and 16 GT/s as well as USB 3.0 and USB 3.1.

J-BERT M8020A can act on TX equalization change requests from 10GBASE-KR, 25GBASE-KR and 100GBASE-KR4 device under tests, if timeouts can be disabled and the device under test's link training status state machine can be forced to bypass states preceding the TX equalization training. Support of 25GBASE-KR and 100GBASE-KR4 requires J-BERT M8020A configuration for 32 Gb/s.

See "pattern, sequencer and interactive link training" section for respective options.

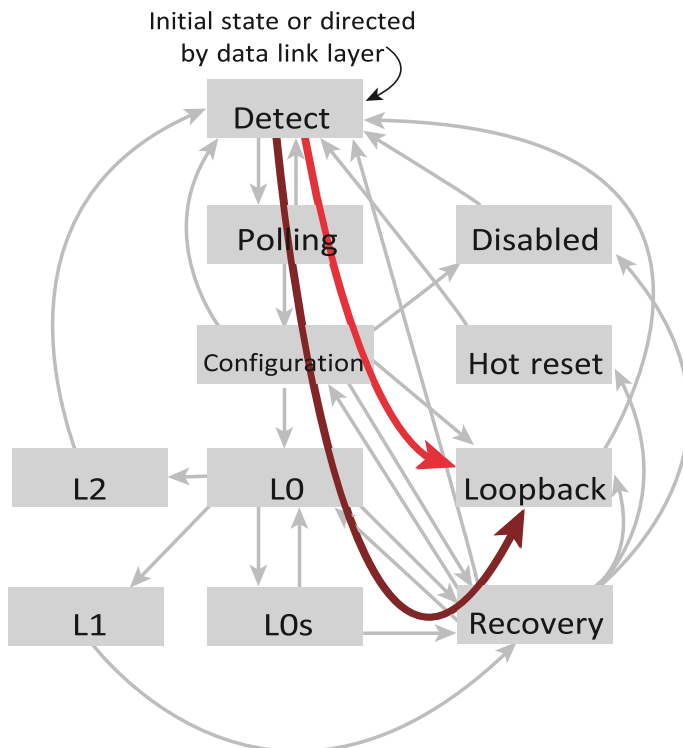

Figure 3 J-BERT M8020A can behave like a real link partner. Due to its interactive link training capability it can train the device into the loopback state via recovery state, as shown in this example for PCIe.

Overview J-BERT M8020A High-Performance BERT



Figure 5. J-BERT M8020A high-performance BERT for accelerated receiver characterization. The configuration shows a 4 channel 16 Gb/s BERT in a 5-slot AXIe chassis consisting of one M8041A module with two BERT channels and clock synthesizer and one M8051A extender module with two additional BERT channels.

Receiver Characterization and Compliance Test

Most multi-gigabit digital interfaces define a receiver tolerance test where the receiver must detect the incoming data bits properly while a certain amount of stress is applied. J-BERT M8020A provides calibrated and built-in jitter sources and automated jitter tolerance measurements. Users can define the modulation frequency range, the number of frequency steps, the min. and max. applied jitter, BER and confidence level and relax time. Results can be exported.



Figure 6. J-BERT M8020A provides automated jitter tolerance characterization and compliance measurements. A library of Jitter tolerance templates is available. To optimize test time, customized jitter tolerance templates can be created with a graphical jitter tolerance template editor. The red dots in the result screen show where the BER level was exceeded, the green dots show where the DUT tolerated the received jitter.

Emulate De-emphasis and Compensate for Channel Loss

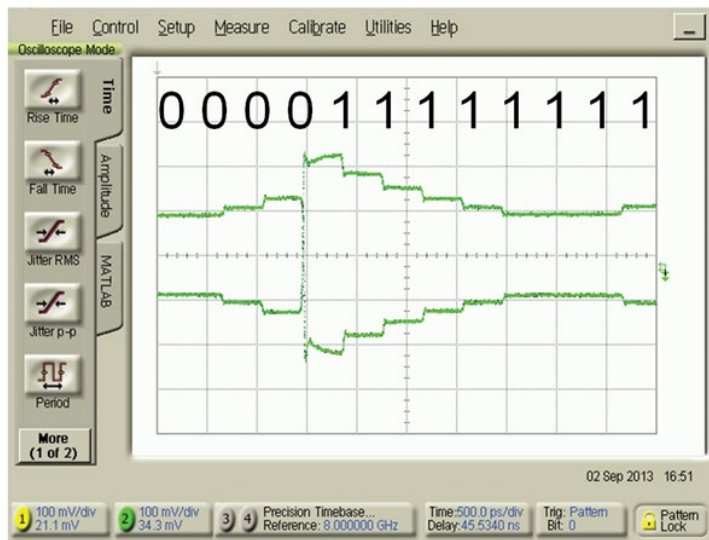

Figure 7 J-BERT M8020A provides built-in de-emphasis with up to 8 taps to emulate a transmitter de-emphasis and to compensate for channel loss. The example shows a bit sequence of eight “0”s and eight “1”s with two pre-cursors and 5 post-cursors that can be adjusted individually.

Emulate Channel Loss with Integrated and Adjustable ISI

With increasing data rates, the channel loss between transmitter and receiver in digital designs becomes more and more important. The loss is caused by printed circuit board traces, connectors and cables in the signal path. This channel loss results in inter-symbol interference (ISI) that depends on the channel material and dimensions, the data rate and the bit pattern. All high-speed digital receivers are specified to tolerate a certain amount of loss or ISI. J-BERT M8020A provides integrated and adjustable ISI to emulate channel loss on all channels during receiver characterization.



Figure 8. J-BERT M8020A offers integrated and adjustable ISI to emulate channel loss. ISI can be controlled for each channel independently via a graphical user interface. Frequency and loss points can be set. S-parameter files can be imported. The example shows a loss curve in blue for the imported S21 parameters for the 12.8 “trace of M8048A. The red line shows the loss parameter entry for M8020A.

J-BERT M8020A Configuration for 32 Gb/s

The J-BERT M8020A can be configured as a full 32 Gb/s BERT for accurate receiver characterization. It provides built-in jitter sources, up to 8-tap de-emphasis, and a clock recovery for full-sampling BER and jitter tolerance measurements up to 32 Gb/s. One common user interface allows controlling all parameters of the 32 Gb/s pattern generator and analyzer.

Key features of the 32 Gb/s BERT configuration:

- Excellent intrinsic jitter performance
- Calibrated jitter sources up to 1 UI eye closure for HF jitter, multi-UI LF jitter, BUJ and Clk/2 jitter
- No step increases when turning on jitter sources
- Built-in adjustable ISI
- 8 tap de-emphasis with positive and negative cursors
- Superposition of level interference avoids external adders
- Clock recovery with adjustable loop bandwidth
- Built-in Analyzer CTLE
- Interactive TX equalizer negotiation between DUT RX and BERT TX for 25GBASE-KR and 100GBASE-KR4
- Add-on to 16 Gb/s BERT configuration
- Common user interface



User Interface and Measurements

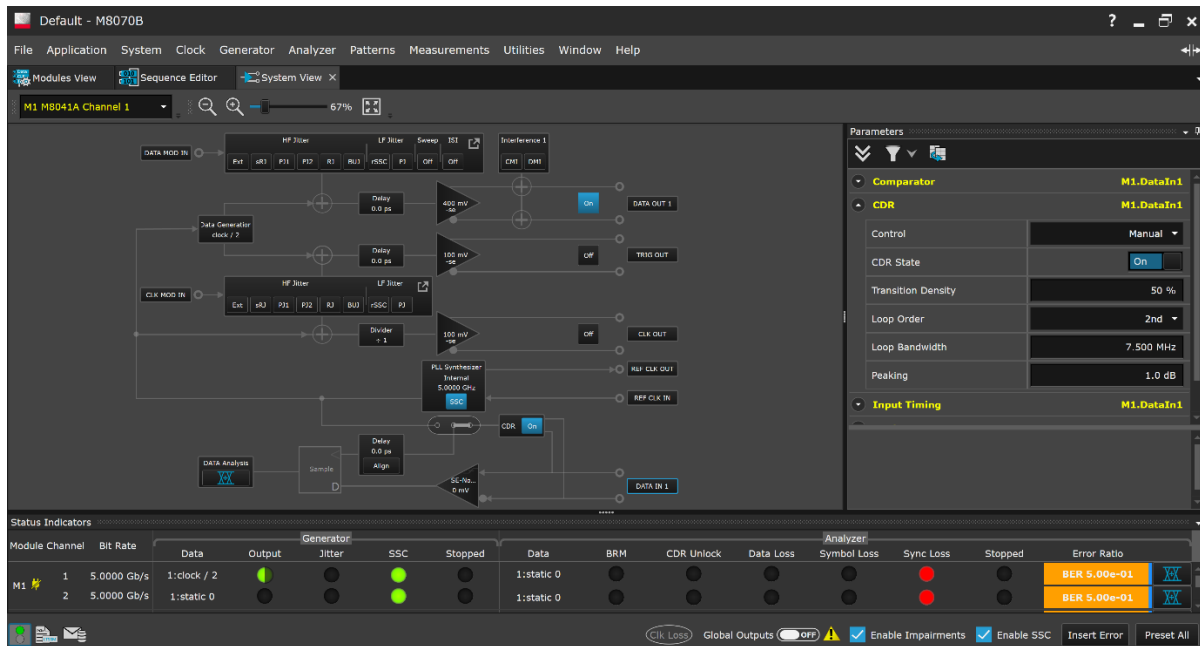

Figure 10. The graphical user interface for J-BERT M8020A offers multiple views that can be defined by the user. This example shows the system view on left side and the pattern generator data output parameters at the right.

The multi-channel BERT offers pattern generation and analysis of up to 10 channels in parallel. All impairments can be added to the data signal on each channel individually.

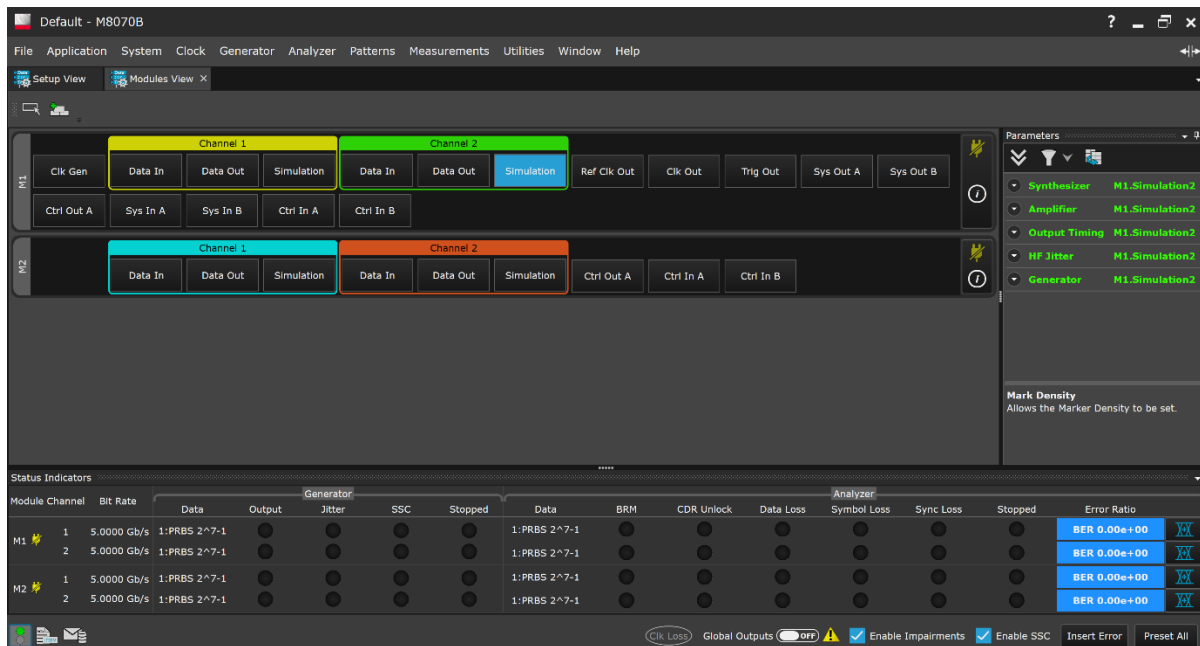

Figure 11. Multiple M8030A four channel module view

Eye Diagram Measurements

Eye diagram measurements are important to get a fast overview on the signal quality of the signal at the input of the Analyzer. This can be either the direct output of a transmitter or a distorted signal at the end of a cable or trace. Many signal parameters like rise/fall times, eye height and eye width, as just a few examples, are provided with this measurement tool.



Figure 12. Eye diagram measurement with J-BERT M8020A Analyzer

Pattern Sequencer, Coding and Interactive Link Training

To simplify test pattern creation, J-BERT M8020A provides unique tools such as an interactive link training status state machine, pattern sequencer with break and branch conditions, a real-time scrambler for coded patterns, masking, symbol filtering for meaningful BER measurements for retimed loop back, a library of pre-defined patterns and loop-back sequences, and a graphical pattern editor.

Pattern Sequencer, Coding and Interactive Link Training

To simplify test pattern creation, J-BERT M8020A provides unique tools such as an interactive link training status state machine, pattern sequencer with break and branch conditions, a real-time scrambler for coded patterns, masking, symbol filtering for meaningful BER measurements for retimed loop back, a library of pre-defined patterns and loop-back sequences, and a graphical pattern editor.

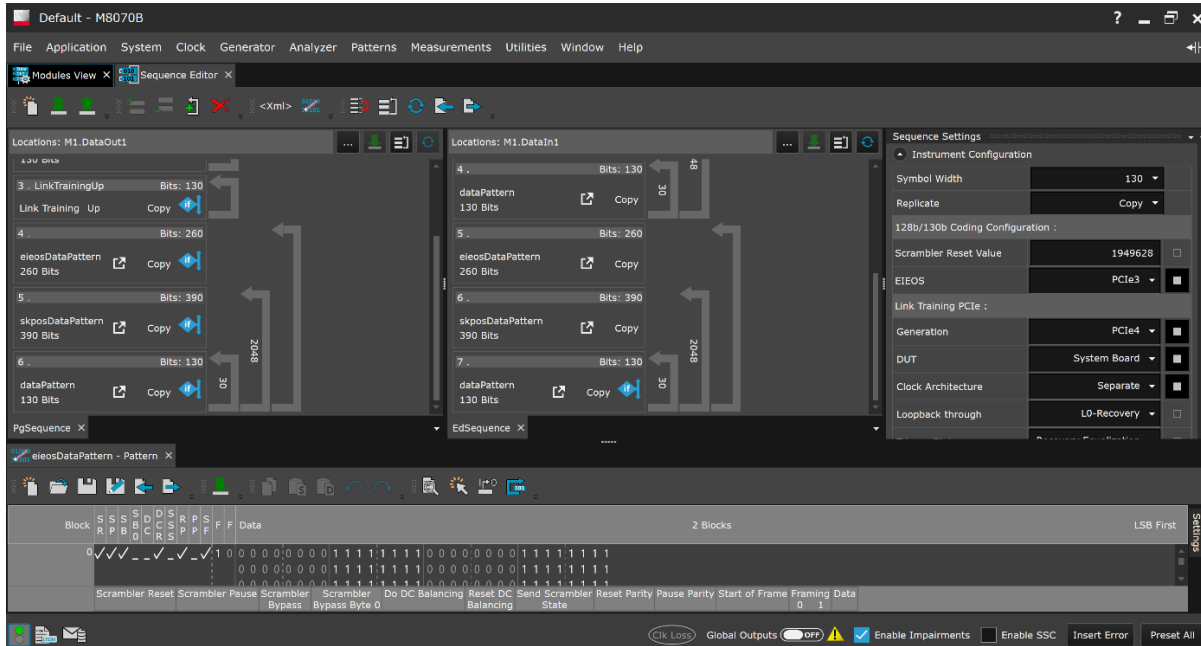

Figure 13. The J-BERT M8020A provides powerful pattern sequencing capabilities. For each pattern generator and analyzer channel a pattern sequence with multiple loop levels, breaks and block controls can be defined. A library of link training sequences for popular standards is available. The example shows a USB 3.1 link training sequence.

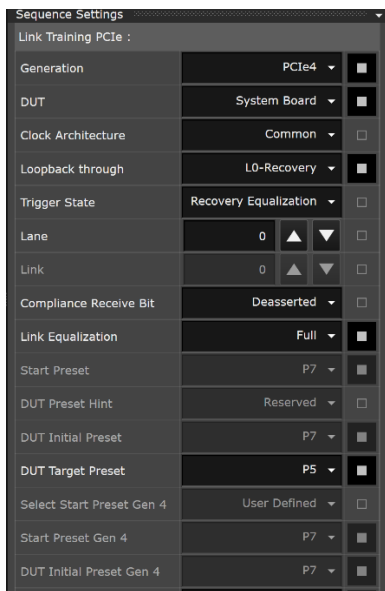

Figure 14. The interactive link training capability of J-BERT M8020A significantly reduces the effort to generate and tune a loopback sequence for your device under test. The example shows the properties you can choose for the PCIe 8 GT/s or 16 GT/s link training state machine.

Accuracy and Performance

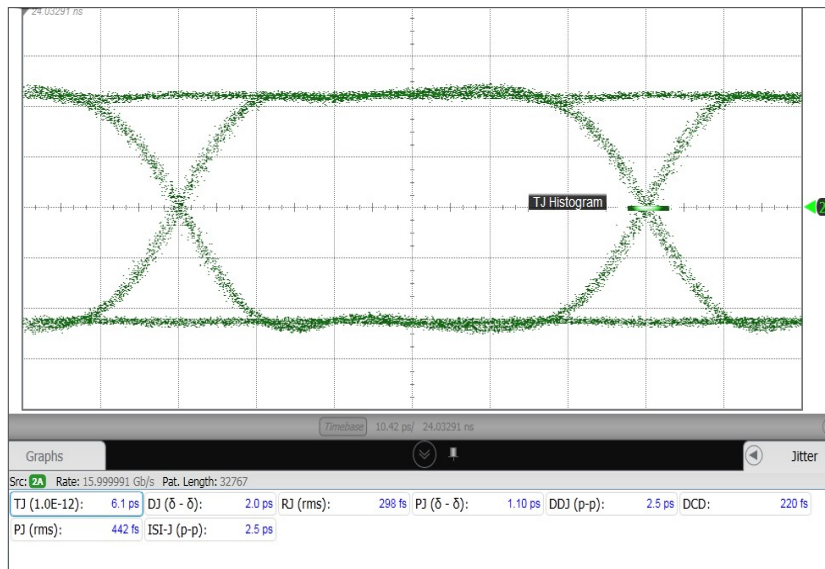

Figure 15. Clean 16.0 Gb/s output signal of J-BERT M8020A with M8041A BERT module using its internal clock source and PRBS 2 15-1 pattern.

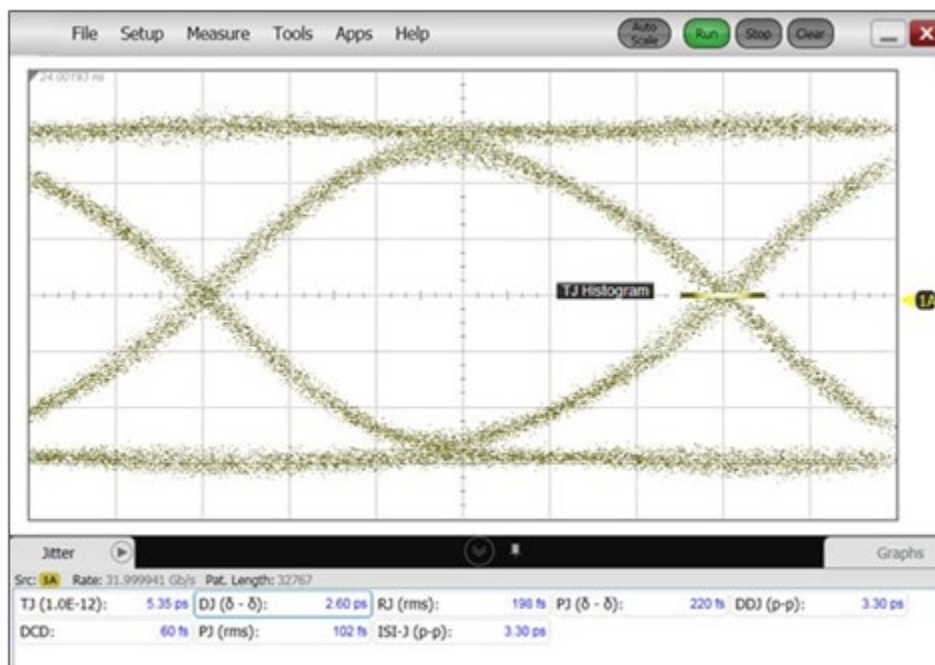

Figure 16. The 32 Gb/s output signal shows excellent intrinsic jitter. This shows the output signal when used with M8041A BERT module and its internal clock source and PRBS 2 15-1 pattern, and the band pass filter M8062A-803 in the clock path.

Specifications for J-BERT M8041A and M8051A High-Performance BERT Modules



Figure 17. Front panel view of M8041A module (bottom) and M8051A (top).

Specifications for M8062A 32Gb/s BERT Front-end

Figure 18. Front panel view of M8042A module.



Specifications Pattern Generator

Data output (DATA OUT 1, DATA OUT 2)

Table 1. Data output characteristics for M8041A and M8051A.

All timing parameters are measured @ 0.5 V into ground		M8041A	M8051A
Data rate	256 Mb/s to 8.50 Gb/s (option G08 or C08), 256 Mb/s to 16.20 Gb/s (option	x	x
Data format	NRZ	x	x
Channels per module	1 or 2 (second channel requires option (0G2)	x	x
Amplitude	50 mV to 1.2 Vpp single ended, 100 mV to 2.4 Vpp differential, 1 mV resolution;	x	x
Amplitude accuracy	5 % ± 5 mV typical (AC) ¹	x	x
Output voltage window	-1 V to +3.0 V	x	x
External termination voltage	-1 V to +3.0 V. For offset > 1.3 V the termination voltage should be ± 0.5 V of offset	x	x
Transition time	Steep: 12 ps typical (20%-80%) ² Moderate: 17 ps typical (20%-80%) Smooth: 20 ps typical (20%-80%)	x	x
Crossing point	Adjustable from 30% to 70%	x	x
Intrinsic total jitter ³	8 ps p-p typical	x	x
Intrinsic random jitter ⁴	300 fs rms typical	x	x
Data delay range	0 to 10 ns, resolution 100 fs	x	x
Data delay accuracy	±1% ±20 mUI typical ⁵	x	x
De-skew accuracy	±10 ps typical between data out 1 and 2 of the same module	x	x
Electrical idle transition time	Output transitions from full swing signal to 0 V amplitude and vice versa at constant offset within 4 ns typical. Electrical idle can be controlled from sequencer. Latency depends on selected coding (symbol width): Binary (1 bit) ±64 UI ± jitter amplitude /2 8B/10B (10 bit) ±80 UI ± jitter amplitude /2 128B/130B (130 bit) ±130 UI ± jitter amplitude /2 128B/132B (132 bit) ±132 UI ± jitter amplitude /2	x	x
Skew between normal and complement output	3 ps maximum at front panel, 8 ps maximum at the end of the recommended cable pair (M8041A-801)	x	x

Specifications Pattern Generator (Continued)

Table 1. Data output characteristics for M8041A and M8051A (continued).

Parameter	Specification	M8041A	M8051A
Termination impedance range	To protect the output stage, the output is disabled when an unexpected voltage or termination impedance is detected. DC output coupling mode: Termination range for devices connected to data out: Unbalanced 50 Ω +15 Ω /-10 Ω typical Balanced 100 Ω \pm 30 Ω typical Operation into open is possible for these ranges when “DC coupled” and “balanced” termination modes are selected: output amplitude max. 450 mV ⁶ offset 0 to 370mV	x	x
Termination modes	Balanced/unbalanced DC/AC coupling	x	x
Connectors	3.5 mm, female	x	x

1. At 256 Mb/s measured with DCA-X 86108B and clock pattern and in the middle of the eye.
2. Measured with DCA-X 86118A. For serial numbers below DE55300500 for M8041A or M8051A: 15 to 20 ps typical (20%-80%)
3. At 16.2 Gb/s PRBS 215-1, BER 10⁻¹², with internal clock.
4. At 16 Gb/s and clock pattern.
5. At constant temperature.
6. Per output when differentially terminated into 100 Ω . Results in doubled swing when driving into open.

Data Output (DATA OUT 1, DATA OUT 2)

Table 2. Data output amplitude maximum (single ended) in presence of DMI, CMI, offset voltage.

Offset \leq 1.9 V	Offset > 1.9 V	CMI	DMI
1.2 Vpp	0.9 Vpp	disabled	disabled
0.9 Vpp	0.675 Vpp	disabled	enabled
0.9 Vpp	0.75 Vpp	enabled	disabled
0.675 Vpp	0.562 Vpp	enabled	enabled
0.8 Vpp	0.666 Vpp	enabled	enabled ¹

1. For DMI < 12.5 % of amplitude

De-emphasis (DATA OUT)

M8020A provides built-in de-emphasis with positive and negative response (FIR) filter.

Table 3. Specifications for multi-tap de-emphasis (requires option 0G4).

		M8041A	M8051A
De-emphasis taps	8 (requires option 0G4) can be adjusted for each channel independently		
Pre-cursor 2	± 6.0 dB		
Pre-cursor 1	± 12.0 dB		
Post-cursor 1	± 20.0 dB		
Post-cursor 2	± 12.0 dB	Option 0G4	Option 0G4
Post-cursor 3	± 12.0 dB		
Post-cursor 4	± 6.0 dB		
Post-cursor 5	± 6.0 dB		
De-emphasis tap resolution	$\pm .1$ dB		
De-emphasis tap accuracy	± 1.0 dB ¹ typical		

1. Sum of all cursors may not exceed Vpp max. The tap accuracy applies for PCIe 3 presets for pre-cursor 1 and post-cursor 1 at 8 Gb/s.

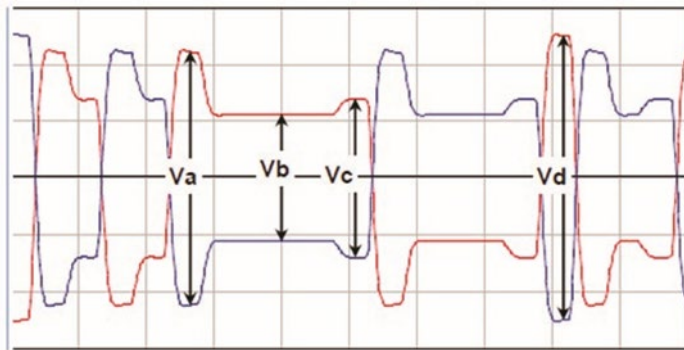

Post-cursor 1 = $20\log_{10} V_b/V_a$
 Pre-cursor = $20\log_{10} V_c/V_b V_{pp}$
 nominal = $20\log_{10} V_d$

Figure 18. Definition of nominal output amplitude and de-emphasis.

Specifications Pattern Generator (Continued)

Clock Output (CLK OUT)

Table 4. Clock output specifications

Parameter	Specification	M8041A	M8051A
Frequency range	256 MHz to 8.50 GHz (option G08 or C08), 256 MHz to 16.20 GHz (option G16 or C16)		
Frequency resolution	1 Hz		
Frequency accuracy	± 15 ppm		
Amplitude	0.1 to 1 V, 5 mV steps, single ended		
Output voltage window	-1 V to +3 V ¹		
External termination voltage	-1 V to +3.0 V		
Transition times	20 ps typical (20%-80%)		
Duty cycle	50%, accuracy ± 15%, typical		
Clock divider	1, 2, 4, 8, 10, 16, 20, 24, 30, 32, 40, 50, 64, 66, 80 For other dividers use TRG output	x	No clk
Clock modes	See table 5		
Intrinsic random jitter	300 fs rms typical at 16.2 GHz and clock divider = 1		
SSB phase noise ²	85 dBc/ Hz typical at 10 kHz offset and internal clock and 10/100MHz as external reference clock. 80 dBc/Hz typical with 10 kHz offset for reference clock multiplier bandwidth 0.1MHz		
Termination	50 Ω into GND or external termination voltage. Do not operate into open. Unused outputs must be terminated into termination voltage.		
Connectors	3.5 mm, female		

- If V_{term} is other than 0 V the following applies:
 High level voltage range = $(2/3 * V_{term} - 0.95 V) < HIL < V_{term} + 2 V$
 Low level voltage range = $(2/3 * V_{term} - 1 V) < LOL < V_{term} + 1.95 V$
- For reference clock multipliers < 400

Specifications Pattern Generator (Continued)

Table 5. Clock modes (M8041A only).

Clock mode	Clock generation	Input Frequency range		
		Option G08/ C08	Option G16/ C16	
Reference	PLL with bandwidth below 1 kHz	10/100 MHz	10/100 MHz	
Direct	No PLL	8.1 GHz to 8.5 GHz	8.1 GHz to 16.2 GHz	
Reference clock multiplying PLL with loop bandwidth 2 MHz	Integer PLL with loop bandwidth 2 MHz ¹	10 to 105 MHz	10 to 105 MHz	Option 0G6
Reference clock multiplying PLL with loop bandwidth 5 MHz	Integer PLL with loop bandwidth 5 MHz ¹	50 to 105 MHz	50 to 105 MHz	Option 0G6

1. Intended use with settings in Table 7 (other settings may be possible, contact factory)

Reference Clock Input (REF CLK IN)

This input on the M8041A module allows locking the system clock to an external reference clock of 10 or 100 MHz instead of the internal oscillator. It also allows to use an external clock, see clock modes.

Table 6. Reference clock input specifications (M8041A only).

Parameter	Specification	M8041A	M8051A
Input amplitude	0.2 V to 1.4 V _{pp}	x	no
Input frequency	-10 MHz to 16.5 GHz, depends on clock mode and maximum data rate option ¹	x	no
Interface	Single ended, 50 Ω	x	no
Connector	SMA, female	x	no

1. Note: a minimal slew rate of 0.3 V/ns at the REF CLK IN signal is required to ensure a proper frequency measurement. If this requirement can't be met the input frequency should be set manually.

Specifications Pattern Generator (Continued)

Table 7. Predefined settings for reference clock multiplier (M8041A with option 0G6 only).

Ref clock input	Standard	Target data rate	Multiplier	PLL loop BW	M8041A
100 MHz	PCIe 4	16 Gb/s	160	2 MHz	
100 MHz	PCIe 3	8 Gb/s	80	5 MHz	
100 MHz	PCIe 2	5 Gb/s	50	5 MHz	
100 MHz	PCIe 1	2.5 Gb/s	25	5 MHz	
26 MHz to 52 MHz	SD UHS-II	390 Mb/s to 780 Mb/s	15	2 MHz	
26 MHz to 52 MHz	SD UHS-II	780 MHz to 1.56 Gb/s	30	2 MHz	Option 0G6
52 MHz to 104 MHz	SD UHS-II Gen 2	1.56 Gb/s to 3.12 Gb/s	30	2 MHz	
52 MHz to 104 MHz	SD UHS-II Gen 2	3.12 Gb/s to 6.24 Gb/s	60	2 MHz	
19.2 MHz	MIPI M-PHY	1.248/ 1.4592/ 2.496/ 2.9184/ 4.992/ 5.8368/ 9.984/ 11.6736 Gb/s	65/ 76/ 130/ 152/ 260/ 304/ 520/ 608	2 MHz	
26 MHz	MIPI M-PHY	1.248/ 1.456/ 2.496/ 2.912/ 4.992/ 5.824/ 9.984/ 11.648 Gb/s	48/ 56/ 96/ 112/ 192/ 224/ 384/ 448	2 MHz	
38.4 MHz	MIPI M-PHY	1.248/ 1.4592/ 2.496/ 2.9184/ 4.992/ 5.8368/ 9.984/ 11.6736 Gb/s	65:2/ 38/ 65/ 76/ 130/ 152/ 260/ 304	2 MHz	
52 MHz	MIPI M-PHY	1.248/ 1.456/ 2.496/ 2.912/ 4.992/ 5.824/ 9.984/ 11.648 Gb/s	24/ 28/ 48/ 56/ 96/ 112/ 192/ 224	2 MHz	

1. Note: a minimal slew rate of 0.3 V/ns at the REF CLK IN signal is required to ensure a proper frequency measurement. If this requirement can't be met the input frequency should be set manually

Supplementary Inputs and Outputs of M8041A and M8051A

Trigger Output (TRG OUT)

The trigger output can be used in different modes:

1. Divided clock, dividers: 2 to 65535
2. Sequence block trigger with adjustable pulse width and offset
3. PRBS sequence trigger with adjustable pulse width

Table 8. Trigger output specifications (M8041A only).

		M8041A	M8051A
Amplitude	0.1 to 1 V _{pp} single ended; 0.2 to 2 V _{pp} differential		
Output voltage window	-1 to 3 V ¹		
External termination voltage	-1 to 3 V	x	No trg.
Interface	Differential, 50 Ω		
Connector	3.5 mm, female		

1. If V_{term} is other than 0 V the following applies:

$$\text{High level voltage range} = (2/3 * V_{\text{term}} - 0.95 \text{ V}) < \text{HIL} < V_{\text{term}} + 2 \text{ V}$$

$$\text{Low level voltage range} = (2/3 * V_{\text{term}} - 1 \text{ V}) < \text{LOL} < V_{\text{term}} + 1.95 \text{ V}$$

Reference Clock Output (REF CLK OUT)

Outputs a 10 and 100 MHz clock, 1 V_{pp} single ended into 50 Ω. M8041A only. Connector: SMA, female.

Clock Input (CLK IN)

For future use. For M8041A only. See reference clock input for direct clock mode.

Control Input A and B (CTRL IN A, CTRL IN B)

Functionality of each input can be selected as: sequence trigger, error add, and pattern capture event.

Table 9. Control input specifications (M8041A and M8051A).

		M8041A	M8051A
Input voltage	-1 V to +3 V		
Termination voltage	-1 V to +3 V		
Termination voltage accuracy	± (25 mV+1%)	x	x
Threshold voltage	-1 V to +3 V		
Delay to data output	See Figure 15		
Connector	SMA, female		

Supplementary Inputs and Outputs of M8041A and M8051A (Continued)

Control Output A (CTRL OUT A)

Outputs a pulse in case of an error. Generates a pulse or static high/low if used from sequencer. Note: Control output functionality is not available with M8062A, only Sync outputs are available.

Table 10. Control output specifications (M8041A and M8051A).

		M8041A	M8051A
Amplitude ¹	0.1 to 2 V		
Output voltage ¹	-0.5 to 1.75 V		
Delay to data output	CTRL Out to DATA Out alignment depends on the selected coding (symbol width):		
		x	x
	Binary (1 bit)		
	8B/10B (10 bit)		
	128B/130B (130 bit)		
	128B/132B (132 bit)		
Connector	SMA, female		

1. When terminated with 50Ω into GND. Doubles into open.

Synchronization Input and Output (SYNC IN, SYNC OUT)

The Sync output on M8041A: clock output to synchronize multiple modules to a common clock. The Sync input is a clock input on M8051A module to synchronize additional modules to a common clock. A sync cable is delivered with each M8051A module by default.

System Input A/B and Auxiliary Input (AUX IN)

Control inputs to synchronize events for the pattern sequencer. Auxiliary input: for future use. For M8041A only.

Table 11. System input and auxiliary input specifications (M8041A only)

		M8041A	M8051A
Input voltage	-1 V to +3 V	x	No
Termination voltage	-1 V to +3 V	x	No
Threshold voltage	-1 V to +3 V	x	No
Delay to data output	See Figure 15	x	No
Connector	SMA, female	x	No

Supplementary Inputs and Outputs of M8041A and M8051A (Continued)

System output A/B (SYS OUT A/B)

Generates a pulse or static high/low controlled by the pattern sequencer.

Note: Control output functionality is not available with M8062A, only Sync outputs are available.

Table 12. System output specifications (M8041A only).

		M8041A	M8051A
Amplitude ¹	0.1 to 2 V	x	No
Output voltage ¹	-0.5 to 1.75 V	x	No
Delay to data output	CTRL Out to DATA Out alignment depends on the selected coding (symbol width):	x	No
	Binary (1 bit)		
	8B/10B (10 bit)		
	128B/130B (130 bit)	x	No
	128B/132B (132 bit)		
Connector	SMA, female	x	No

1. When terminated with 50 Ω into GND. Doubles into open.

Supplementary Inputs and Outputs of M8041A and M8051A (Continued)

Delay of SYS IN and CTRL IN to the data outputs in
 $UI = \text{block length [UI]} + X \pm LFPJ [UI] * 0.5 \pm \text{SSC deviation [UI]}$

The SSC deviation can be calculated as:

down spread SSC deviation = (data rate * (deviation in %/100)) / (8*SSC modulation frequency)

center spread SSC deviation = (data rate * (deviation in %/100)) / (4*SSC modulation frequency)

Table 13. Supplementary information to calculate delay between SYS and CTRL

X in UI typical	Coding (symbol width)	binary (1 bit)	8B/10B (10 bit)	128B/130B (130 bit)	128B/132B (132 bit)
CTRL IN to DATA	256 to 506.25 Mb/s	4672	4800	5330	5280
	506.25 Mb/s to 1.0125 Gb/s	5568	5760	6240	6204
	1.0125 to 2.025 Gb/s	7680	7920	8450	8382
	2.025 to 4.05 Gb/s	11840	12064	12740	12805
	4.05 to 8.1 Gb/s	20013	20336	21321	21384
	8.1 to 16.2 Gb/s	36544	37098	38515	38664

X in UI typical	Coding (symbol width)	binary (1 bit)	8B/10B (10 bit)	128B/130B (130 bit)	128B/132B (132 bit)
SYS IN to DATA	256 to 506.25 Mb/s	4992	5120	5590	5676
	506.25 Mb/s to 1.0125 Gb/s	6208	6400	6903	6863
	1.0125 to 2.025 Gb/s	8896	9200	9880	9768
	2.025 to 4.05 Gb/s	14291	14584	15600	15629
	4.05 to 8.1 Gb/s	24896	25432	27040	27166
	8.1 to 16.2 Gb/s	46312	47294	49884	50171

Figure 19. This table shows typical values for X in unit intervals (UI) in order to calculate the delay between SYS Input and CTRL input to the data outputs of M8041A and M8051A. The X depends on data rate and the selected coding (symbol width).

Jitter Tolerance Specifications

M8020A provides built-in calibrated jitter sources designed to cover receiver test needs for most of the popular multi-gigabit standards such as: PCIe, USB, MIPI, SATA, DisplayPort, CPU frontside buses, CEI, 10GbE, 100GbE, SFP+, QSFP, CFP2/4, etc. M8020A provides automated jitter tolerance measurements. A library of pre-defined compliance curves is provided.

Table 14. Specifications for low frequency periodic jitter (requires option 0G3 advanced jitter sources).

De-emphasis taps		M8041A	M8051A
Low frequency periodic jitter (LF PJ) (generated by IQ modulator)	Amplitude range	0 to 123.5 UI x data rate (in Gb/s) for modulation frequencies of 100 Hz to 10 kHz, see table below: For modulation frequencies between 10 kHz and 10 MHz the maximum LF PJ $1.235 \text{ UI} * \text{data rate (Gb/s)} = \text{modulation frequency (MHz)}$	
	Frequency	100 Hz to 10 MHz, Sinusoidal modulation	
	Jitter amplitude accuracy	$\pm 2\% \pm 1 \text{ ps}$ typical	
	Adjustable	For each data channel independently, same LFPJ for clock and trigger	

Low frequency periodic jitter

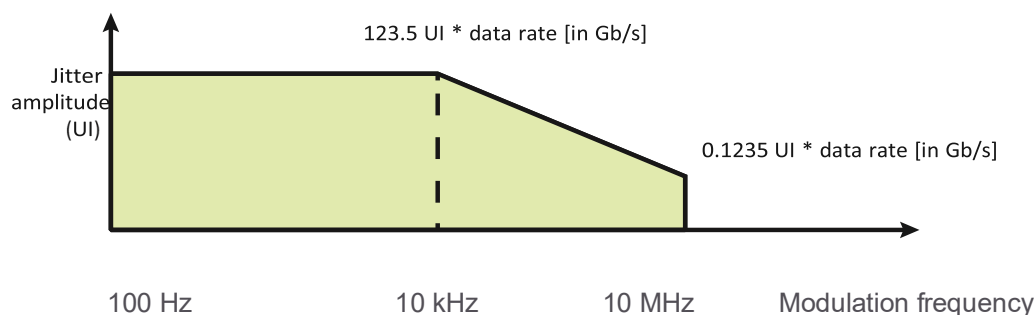

Figure 20. Low frequency periodic jitter maximum depends on data rate and modulation frequency.

Table 15. Maximum UI modulation depending on data rate

Data rate	Max UI at modulation frequency 100 Hz to 10 kHz	Max UI at modulation frequency 10 MHz
256.0 Mb/s to 506.25 Mb/s	31.6 to 62.5 UI	0.0317 to 0.0625 UI
506.25 Mb/s to 1.0125 Gb/s	62.5 to 125 UI	0.0625 to 0.125 UI
1.0125 Gb/s to 2.025 Gb/s	125 to 250 UI	0.125 to 0.25 UI
2.025 Gb/s to 4.05 Gb/s	250 to 500 UI	0.25 to 0.5 UI
4.05 Gb/s to 8.1 Gb/s	500 to 1000 UI	0.5 to 1 UI
8.1 Gb/s to 16.2 Gb/s	1000 to 2000 UI	1 to 2 UI

Jitter Tolerance Specifications (Continued)

Table 16. Specifications for high frequency periodic jitter, random jitter, spectrally distributed random jitter, bounded uncorrelated jitter, Clock/2 jitter (requires option 0G3 advanced jitter sources).

			M8041A	M8151A
High frequency jitter (generated by delay line)	Range ¹	1 UI p-p for data rates > 1 Gb/s note: this is max sum of RJ, HF-PJ1 and HF-PJ, spectral RJ, external delay modulation and BUJ.	Option 0G3	Option 0G3
High frequency periodic jitter (HF PJ1 and HF PJ2)	Range	See HF jitter above ²		
	Frequency	1 kHz to 500 MHz For data rates < 4 Gb/s the max modulation frequency is data rate / 8. Two tone possible. Sweep.	Option 0G3	Option 0G3
	Jitter amplitude accuracy Adjustable	± 3 ps ± 10 % typical		
Random jitter (RJ)	Range ¹	0 to 72 mUI rms (1 UI p-p max.) ²		
	Jitter amplitude accuracy	± 300 fs ± 10 % typical		
	Filters ¹	High-pass: 10 MHz and "off", Low-pass: 100 MHz, Low pass: 500 MHz (for data rates ≥ 3.75 Gb/s), Low pass: 1 GHz (for data rates ≥ 7.5 Gb/s)	Option 0G3	Option 0G3
	Adjustable	For each channel independently		
Spectrally distributed RJ according to PCIe 2 (sRJ) ³	Range	0 to 72 mUI rms (1 UI p-p) ²		
	Frequency	LF: 0.01 to 1.5 MHz, HF: 1.5 to 100 MHz		
	Jitter amplitude accuracy	± 300 fs ± 10 % typical	Option 0G3	Option 0G3
	Adjustable	For each channel independently		
Bounded correlated jitter (BUJ)	Range	See HF jitter above ²		
	PRBS polynomials	2n -1, n = 7, 8, 9, 10, 11, 15, 23, 31, 33, 39, 41, 45, 49, 51		
	Filters	50/100/200 MHz low pass 3rd order		
	Jitter amplitude accuracy	± 5 ps ± 10% typical for settings shown in table 15	Option 0G3	Option 0G3
	Adjustable	For each channel independently		
	Rate for PRBS generator	625 Mb/s, 1.25 Gb/s and 2.5 Gb/s		
Clock/2 jitter	Range	± 20 ps or ± 0.1 UI typical (whatever is less). Note: this means that first eye can be up to 20 ps longer or shorter than subsequent eye.	Option 0G3	Option 0G3
	Jitter amplitude accuracy	± 3 ps typical		
	Adjustable	For each channel independently		

1. If LP filter used below specified data rate the Jitter amplitude for all sources is uncalibrated and Jitter amplitude limited to 160ps max.
2. UI is the maximum sum of RJ, HF-PJ1 and HF-PJ2, spectral RJ, external delay modulation and BUJ.
3. Spectrally distributed random jitter is mutually exclusive with RJ and BUJ.

Jitter Tolerance Specifications (Continued)

Table 17. BUJ accuracy applies for these BUJ settings.

BUJ calibration settings ¹	Rate for PRBS generator	PRBS polynomial	Low pass filter
CEI 6G	1.25 Gb/s	PRBS 2 9-1	100 MHz
CEI 11G	2.5 Gb/s	PRBS 2 11-1	200 MHz
Gaussian	2.5 Gb/s	PRBS 2 31-1	100 MHz

1. Other settings are not calibrated and do not necessarily generate the desired jitter histograms for all data rates other PRBS generator.

Table 18. Specifications for Spread Spectrum Clocking (SSC) (requires option 0G3: advanced jitter sources).

			M8041A	M8151A
SSC (Spread Spectrum Clock)	Range	0 to 10,000 ppm (0 to 1%) peak-peak. Select center-spread, up-spread, and down-spread.		
	Frequency	100 Hz to 200 kHz		
	Modulation	Triangular and arbitrary modulation	Option 0G3	N/A
	SSC amplitude accuracy	± 0.025 % typical		
	Outputs	Can be turned on/off together for CLK OUT, DATA OUT 1, DATA OUT 2, TRG OUT		
Residual SSC (@ PCIe2)	Range	0 to 600 ps		
	Frequency	10 to 100 kHz	Option 0G3	Option 0G3
	Outputs	Can be turned on/off independently for DATA OUT 1, DATA OUT 2		
	Adjustable	For each channel independently		

Table 19. Specifications for external jitter modulation (DATA MOD IN 1 and 2, CLK MOD IN). M8041A allows individual jitter injection for data 1, data 2 and clock. M8051A for data 1 and data 2. The option 0G3 is not needed.

			M8041A	M8151A
External jitter data modulation input 1 and 2	Description	Input for delay modulation for each DATA OUT individually.		
	Range	Up to 1 UI ¹ , 0.8 V _{pp} max	x	x
	Frequency	Up to 1 GHz		
External jitter clock modulation input	Description	Input for delay modulation for the TRG OUT and CLK OUT. Affects both.		
	Range	Up to 1 UI, 0.8 V _{pp} max	x	N/A
	Frequency	Up to 1 GHz		
	Adjustable	For each channel independently		
Gain	1UI / 0.725 V ± 5%			
Linearity	50 mUI		x	x
Connectors	SMA, female			

1. UI is the maximum sum of RJ, HF-PJ1 and HF-PJ2, spectral RJ, external delay modulation and BUJ.

Jitter Tolerance Specifications (Continued)

Table 20. Specifications for adjustable Inter-Symbol-Interference (ISI). Adjustable ISI is offered for M8041A and M8051A and requires option 0G5 and serial number \geq DE55300500. For lower S/N an upgrade option UG5 is offered, that requires return-to-factory.

	1-point control (widest range)	2-point control (best adjust)	M8041A	M8151A	M8162A
Operating range	Description Emulates loss of real PCB traces for data rates > 5 Gb/s				
Frequency range	1 to 16 GHz, 1 MHz resolution				
Insertion loss (IL) range for upper point (P1)	No control	-1.5 to -25 dB ¹			
Insertion loss range for lower point (P2)	-0.5 to -25 dB ¹	-1.5 to -25 dB ¹			
Slope range	-0.5 to -6.0 dB/GHz @ IL offset 0 dB -1.5 to -6 dB/GHz @ IL offset max -2 dB				
Loss resolution	0.1 dB/GHz typical		Option 0G5	Option 0G5	See M8062A data sheet
Insertion loss accuracy	\pm (0.8 dB + 0.1 dB/GHz) typical	for loss range 0 to -20 dB: \pm (0.9 dB + 0.1 dB/GHz) typical			
Presets	M8048A ISI channel 7.7", 9.4", 11.1", 12.8", 14.4", 16.1", 24.4" PCIe3 short and long M-PHY G3A Ch1, G3A Ch2 M-PHY G3B Ch1, G3B Ch2 MIPI-Short, MIPI-Standard, MIPI-Long ² SAS-3				
Import of S-parameters	Yes, s2p and s4p				

1. Within slope range and IL offset range. Frequency of lower point (P2) must be > frequency of upper point (P1)
2. Requires either M8070B software or M8070A software revision 2.5.0.0 or later.

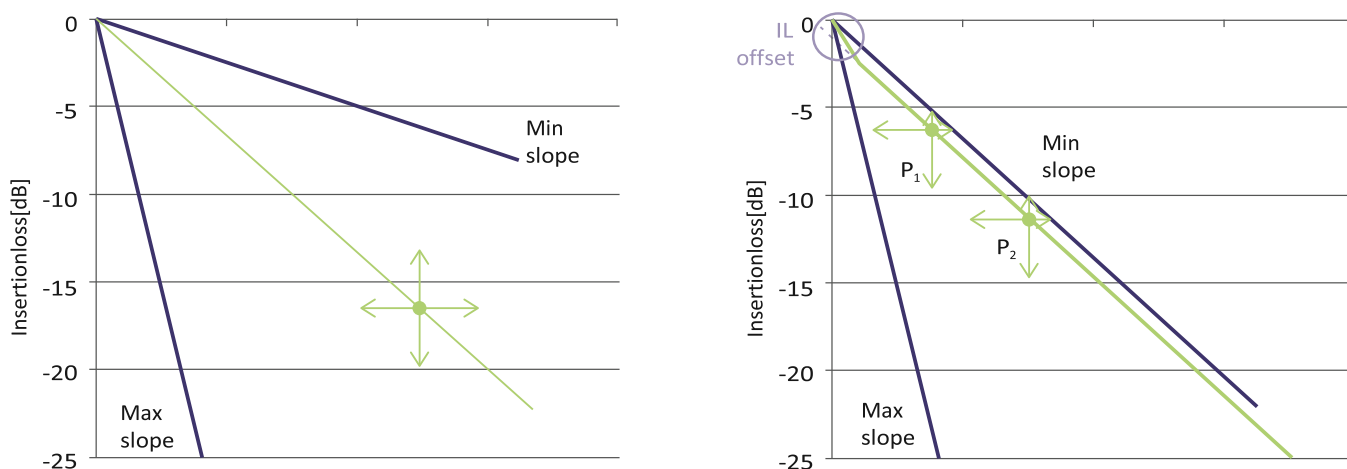

Figure 21. The adjustable ISI can be controlled over a wide range.

The chart on the left shows the range for 1-point control. The upper loss point P1 is fix, only the lower point P2 can be varied over a wide range within min and max slope. The chart on the right shows 2 point control which provides full flexibility to adjust the frequency and loss of the upper point 1 and the lower point 2 within the range between min and max slope.

Jitter Tolerance Specifications (Continued)

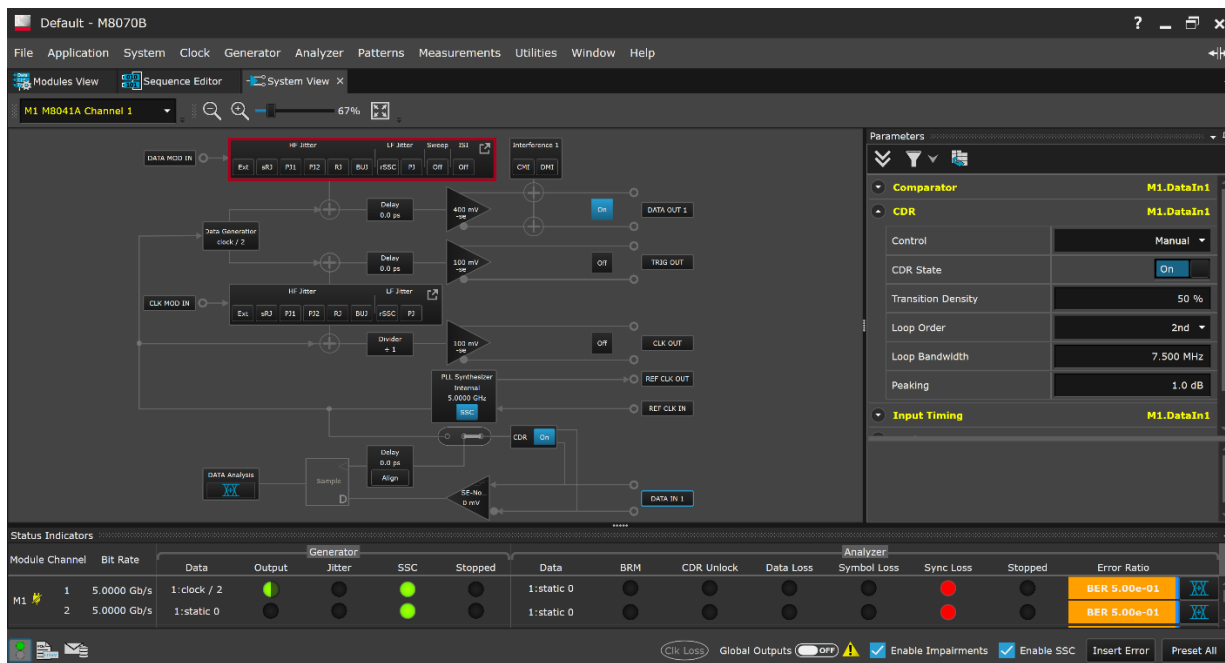

Figure 22. J-BERT M8020A system view for 1 channel.

ISI Channels

External ISI channels are available to emulate channel loss. Keysight offers dedicated compliant ISI channels for DisplayPort, PCIe3 (base spec) and SATA. M8048A is offered in addition. For detailed specifications see M8048A data sheet.



M8048A-001 ISI Channels provides four short traces:
 7.7" (196 mm), 9.4" (240 mm), 11.12" (282 mm), 12.8" (324 mm)
 M8048A-002 ISI Channels provides four long traces:
 14.4" (366 mm), 16.1" (408 mm), 24.4" (620 mm), 34.4" (874 mm)

Level Interference Injection

Common mode and differential mode level interference can be generated internally to test common mode rejection of a receiver and vertical eye closure tolerance. Simultaneous injection of CMI and DMI is possible. See M8062A data sheet for details on built-in level interference superposition and gain adjust parameters.

Jitter Tolerance Specifications (Continued)

Table 21. Specifications for sinusoidal level interference (CMI, DMI) (requires option 0G7).

	1-point control (widest range)	2-point control (best adjust)	M8041A	M8151A
Differential mode interference (DMI)	Amplitude ²	Up to 30% of maximum output amplitude when "auto range" is enabled. Up to 30% of selected output amplitude range 1 when "auto range" is disabled		
	Amplitude accuracy	±10 mV ±10% typ.		
Common mode interference (CMI)	Amplitude ^{2,3,4}	Up to 600 mV ¹ , for AC coupling, DC coupling & balanced termination model Up to 320 mV ¹ , for DC coupling & unbalanced termination model	Option 0G7	Option 0G7
	Amplitude accuracy	±10 mV ±10% typ.		
Modulation frequency	Ranges	LF: 10 MHz to 1 GHz, sinusoidal only HF: 1 GHz to 6 GHz, sinusoidal only		
Simultaneous injection of CMI and DMI		Yes. HF modulation cannot be used simultaneously for CMI and DMI. LF modulation cannot be used simultaneously for CMI and DMI. See figure below.		

1. The maximum output amplitude decreases when CMI or DMI is enabled. See table 2.
2. For each channel independently.
3. Up to 5 GHz.
4. For details on coupling and termination models see user guide, chapter 'Setting up Generator'

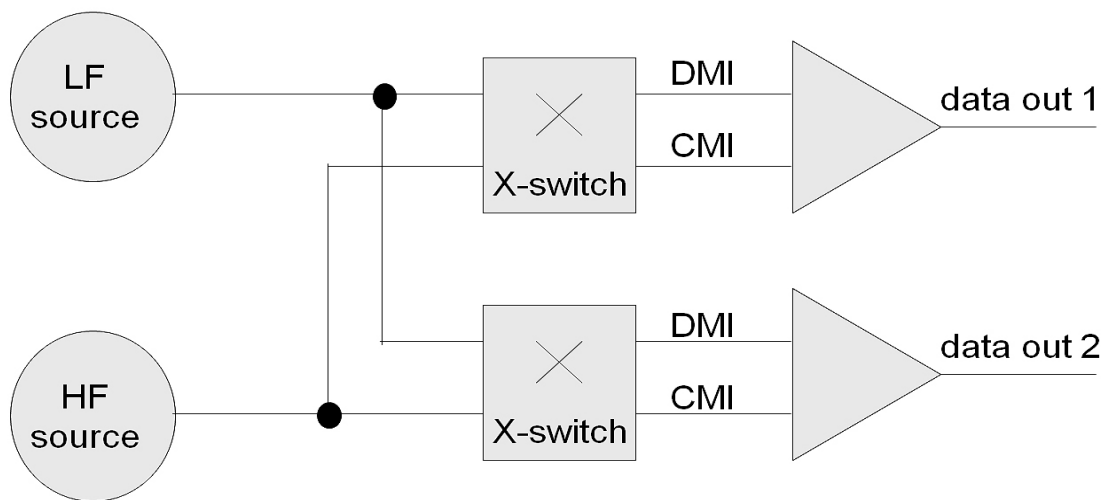

Figure 23. M8020A provides calibrated level interference sources for simultaneous injection of CMI (common mode interference) and DMI (differential mode interference).

Pattern, Sequencer and Interactive Link Training

Table 22. Specifications for pattern, sequencer and link training.

		M8041A	M8151A	M8162A
PRBS ¹	2 ⁿ -1, n= 7, 10, 11, 15, 23, 23p ³ , 31, 33, 35, 39, 41, 45, 49, 51			
PRBS	2 ⁿ -1, n= 7, 10, 11, 13, 15, 23			
Mark density	Mark density: PRBS 1/8 to 7/8			See M8062A data sheet
Zero substitution	Yes	Option 0G5	Option 0G5	
Export/Import	Patterns from N4900 series can be imported			
Pattern library	Yes			
User definable memory	2 Gbit/channel ⁴			
Interactive link training	Link training status state machine for PCIe common reference clock 8 GT/s. Is suitable to test root complex as well as endpoint. Supported channels: 1	Option 0S1	N/A	No
	Link training status state machine for PCIe common reference clock 8 GT/s as well as 16 GT/s. Is suitable to test root complex as well as endpoint. Supported channels: 1	Option 0S4 ⁵	N/A	No
	Link training status state machine for USB 3.0 and USB 3.1. Is suitable to test upstream as well as downstream ports. Supported channels: 1	Option 0S3 ⁵	N/A	No
	TX equalization negotiation between 10GBASE-KR DUT RX and BERT TX. Requires timeouts to be turned off. Supported channels: 1	Option 0SX ^{5,6}	N/A	No
	TX equalization between 25GBASE-KR or 100GBASE-KR4 DUT RX and BERT TX. Requires timeouts to be turned off.	No	No	OSC ⁵
Coding	8B/10B, 128B/130B, 128B/132B, binary, hex	x	x	No
Scrambler	PCIe, USB, SATA	x	x	No
Vector/sequence granularity	64/80/130/132 bit	x	x	*2
Pattern capture	Yes ⁴ , Capture on event. Capture n bit before/after event:			
	– User defined (minimum) amount of pre-event bits/symbols and minimum capture bit/symbols			
	– Events: error, CTRL IN A/B, immediate			
	– Max 2 Gbit/ch capture data			
	Save captured data:			
	– With errors			
	– As expected data (ignores error content)			
	– As PG data (ignores error content)	x	x	No
	– Export via pattern editor windows			
	– Export captured data, displays bit & symbol errors			
– Convert bits into all other coding and vice versa				
– Ability to mask error bits automatically				
Display of captured data:				
– Display errors with color coding				
– Navigate through error bits/symbols (find next/previous)				
Pattern sequencer	3 counted loop levels, 1 infinite loop, # of blocks: 500	x	x	x

Note: polarity is inverted compared to ParBERT and J-BERT N4903A/B and N49xx models.

1. For availability: contact factory.
2. Scrambler polynomial for PCI Express 128b/130b.
3. Requires M8070B or M8070A software revision 2.0.0.0 or later.
4. Requires M8070B. or M8070A software revision 3.5.0.0 or later.
5. Requires M8041A or M8051A serial number \geq DE55300500 or modules with option 0G5/UG5

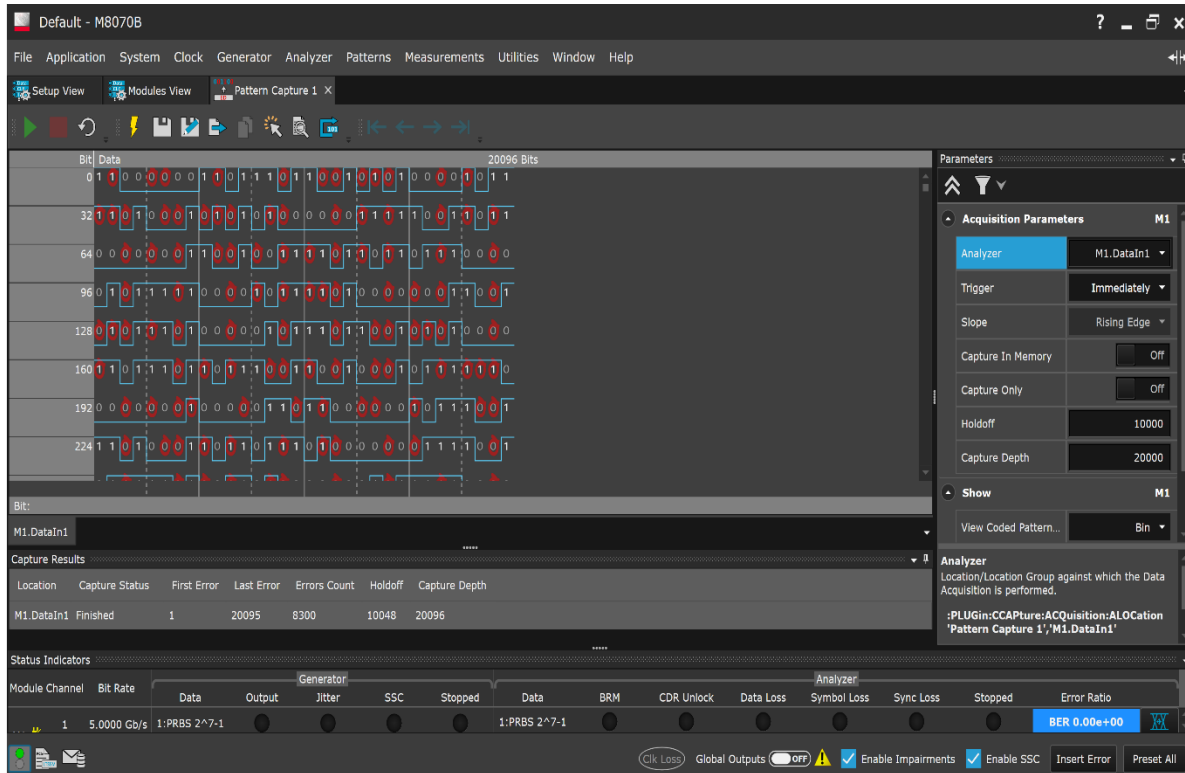

Figure 24. The J-BERT M8020A analyzer can capture up to 2 Gbit per channel. Capture events and depth can be defined. The captured pattern can be exported and loaded as generator pattern or as expected pattern for further error analysis. The example shows errored bits in red with navigation arrows.

Specifications Analyzer (Error Detector)

For the following functions a separate module option is required:

Equalizer CTLE option (option 0A3 for M8041A and M8051A).

- SER/BER analysis (option 0S2 is offered for M8041A only but applies for all analyzers channels in the same clock group): this option provides handling of 8B/10B coded, 128B/130B coded and 128B/132B coded patterns. 8B/10B coded patterns support automatic handling of running disparity changes, scrambling/descrambling and up to 4 filler primitives consisting of up to 4 symbols each. No dead time while filtering filler symbols. Supports changes of length of 128B/130B and 128B/132B coded Skip Ordered Sets for PCIe and USB 3.1.
- For 32 Gb/s setups using the M8062A 32 Gb/s front-end the CTLE of the M8041A and M8051A modules are not used. Instead the optional CTLE of the M8062A module can be used. See M8062A data sheet for more information. M8041A option 0S2 SER/BER is not supported when 32 Gb/s BERT configuration is activated.

Table 23. Specifications for analyzer / error detector (option C08 or C16).

		M8041A	M8151A
Data rate	256 Mb/s to 8.50 Gb/s (option C08), 256 Mb/s to 16.20 Gb/s (option C16)		
Channels per module	1 or 2 (option 0A2)		
Data format	NRZ, single ended and differential		
Input sensitivity ¹	50 mV typical @ normal sensitivity mode ² 40 mV typical @ high sensitivity mode ²		
Input voltage window	-1.0 V to + 3.3 V	x	x
Maximum voltage window	1.0 Vpp single ended @ normal sensitivity mode 0.50 Vpp single ended @ high-sensitivity mode		
Termination voltage	-1.0 V to + 3.3 V ³		
Timing resolution	1 mUI		
Input bandwidth	17.5 GHz typical		
CTLE	Yes. The following presets are available: PCIe 3.0 @ 8 Gb/s: -6.0 dB, -9 dB, -12 dB PCIe 4.0 @16 Gb/s: ⁴ -6 dB, -9 dB, -12 dB USB 3.0 @ 5 Gb/s USB 3.1 @ 10 Gb/s: ⁴ 0 dB, -3 dB, -6 dB	Option 0A3	Option 0A3
Clock data recovery	Yes, for each input channel. See table 21 for more details.		
Sampling point	Manual and automatic. Finds optimum voltage threshold and delay of the sampling point. Delay accuracy ± 30 mUI		
Decision threshold range	-1.0 V to + 3.3 V in 1 mV steps. Must be within ± 0.5 V range from common mode voltage. Threshold accuracy ± 25 mV typical	x	x
Phase margin	1 UI - 16 ps typical for PRBS 215- 1 1 UI - 7 ps typical for clock pattern		
Interface	Differential: 100 Ω , single ended: 50 Ω , DC coupled		
Data input connectors	3.5 mm, female	x	x

1. Measured with PRBS 2³¹ - 1 at 16 Gb/s, AC coupling mode, BER of 10⁻¹², CTLE disabled.

2. Eye height measured at input of reference cable M8041A-801 with DCA-X module 86117A.
Applies for single ended and differential input signals.

3. Termination voltage must be within a window of DC common mode voltage ± 1.7 V.

4. Requires M8070B or M8070A software revision 2.5.0.0. or later and a S/N of \geq DE55300700 or \geq MY55300800

Specifications Analyzer (Error Detector) (Continued)

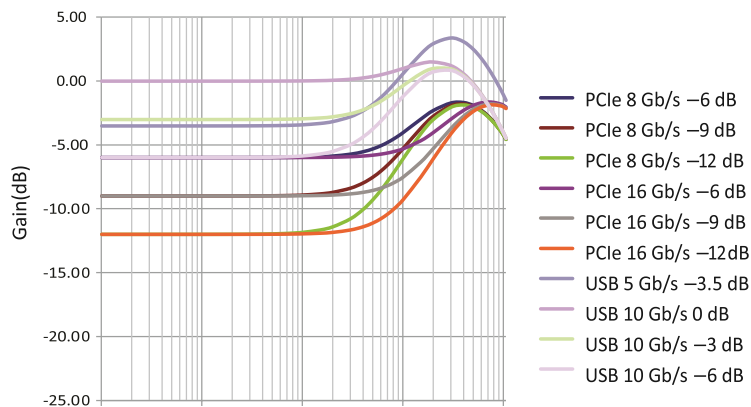

Figure 25. CTLE presets are available for each M8041A/51A analyzer input. This allows to make BER measurements even on closed eyes.

Table 24. Specifications for clock recovery.

		Condition	M8041A	M8151A
CDR data rate range	1.0125 to 16.2 Gb/s			
Selectable loop type	1st and 2nd order PLL - see figure below for description			
Tunable loop bandwidth	102 kHz to 20 MHz depends on data rate as shown in figure below.	Data rate from 1.0125 Gb/s to < 8.1 Gb/s, transition density of 50 %		
	Data rate/ 10000 to data rate/ 500	Data rate > 8.1 Gb/s, transition density of 50%		
	Data rate/ 10000 to data rate/ 660	1 MHz < loop BW < data rate/ 900, transition density of 50% and peaking ≤ 2 dB		
Loop bandwidth accuracy	$\pm 20\%$ typical	With type 2 second order loop selected		
Tunable peaking range	0.. 3 dB @loop BW \leq data rate/ 900	With type 2 second order loop selected	x	x
Transition density compensation	The user can set the expected transition density and the loop compensates the loop bandwidth accordingly			
Tracking range ¹ (maximum frequency deviation)	Frequency deviation [ppm]= $\pm(9000 - 350 \cdot \text{data rate [Gb/s]})$	With type 2 selected and loop BW \geq data rate / 800, Software revision 3.0.0.0 and higher ¹		
CDR freeze	After 256 consecutive bits without transition the CDR goes automatically into a freeze state. At every transition the CDR recovers from the freeze state.			

1. Tracking range for older software versions: Frequency deviation [ppm]= $\pm(9000 - 500 \cdot \text{data rate [Gb/s]})$

Specifications Analyzer (Error Detector) (Continued)

First order PLL (type 1)

- A type 1 is defined by bandwidth.
No peaking.
- JTF bandwidth = OJTF bandwidth.
- Used by some communication standards

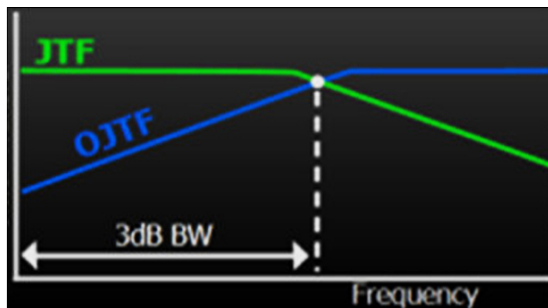

Second order PLL (type 2)

- This type 2 is defined by JTF loop bandwidth and peaking.
- JTF bandwidth > OJTF bandwidth.
- Used by some computing standards.



Figure 26. Each M8041A/51A analyzer has a built-in clock recovery. Choose between first and second order PLL.

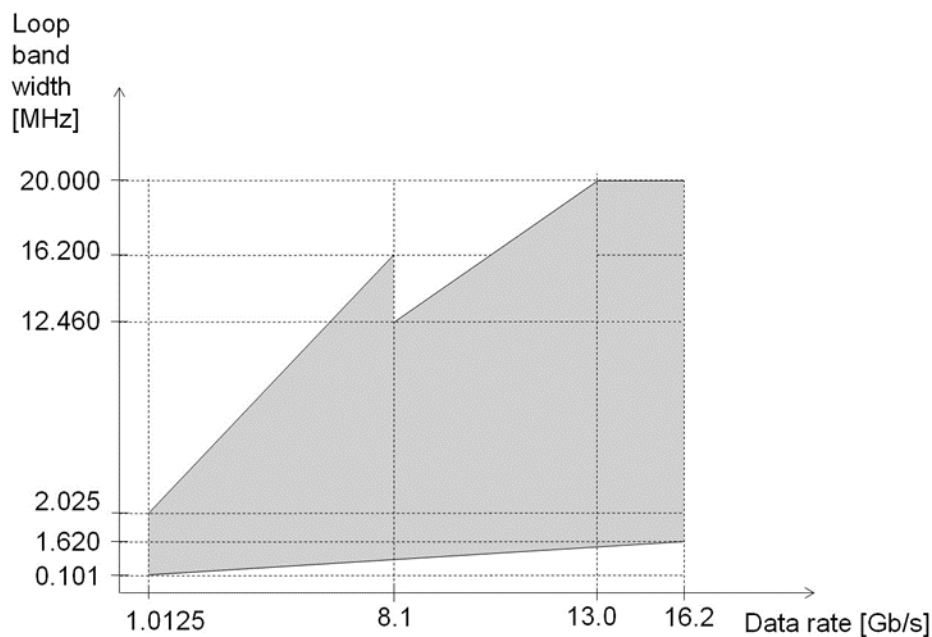

Figure 27. CDR loop bandwidth range for a transition density of 50%

Specifications Analyzer (Error Detector) (Continued)

Table 25. Measurement capabilities (option C08 or C16).

		M8041A	M8151A	M8162A
BER	Yes, up to 16.2 Gb/s and PRBS $2^{31} - 1$	x	x	x
BERT Scan with RJ, DJ separation	Yes	x	x	x ¹
Jitter tolerance	Yes ²	x	x	x
Eye contour	Yes ²	x	x	x
Eye diagram	Yes ³	x	x	Yes
Output level and Q factor	Yes ²	x	x	Yes
Bit recovery mode	Yes, up to 16.2 Gb/s and PRBS $2^{31} - 1$	x	x	No
Symbol/Frame error rate	8B/10B, 128B/130B, 128B/132B ⁴ coded and retimed patterns			
Filtering of filler symbols	Automatic removal of filler symbols. See also the description above.			
Counters	8B/10B: compared symbols, errored symbols, illegal symbols, filler symbols, wrong disparity, frames, errored frames 128B/130B: blocks, errored blocks, illegal sync headers, filler symbols, modified filler symbols 128B/132B ⁴ : blocks, errored blocks, illegal sync headers, filler symbols, modified filler symbols, corrected sync headers	Option 0S2	N/A	No

1. Only with external clock source
2. Requires software M8070B and M8070ADVB or M8070A revision 3.0.0.0 or higher.
3. Requires software M8070B or M8070A revision 2.0.0.0 or later.
4. 128B/132B SER/FER, filler symbol removal and counters are supported for data rates from 9 to 11 Gb/s (USB 3.1). Requires software M8070B or M8070A revision 1.5.0.0 or later.

User Interface and Remote Control

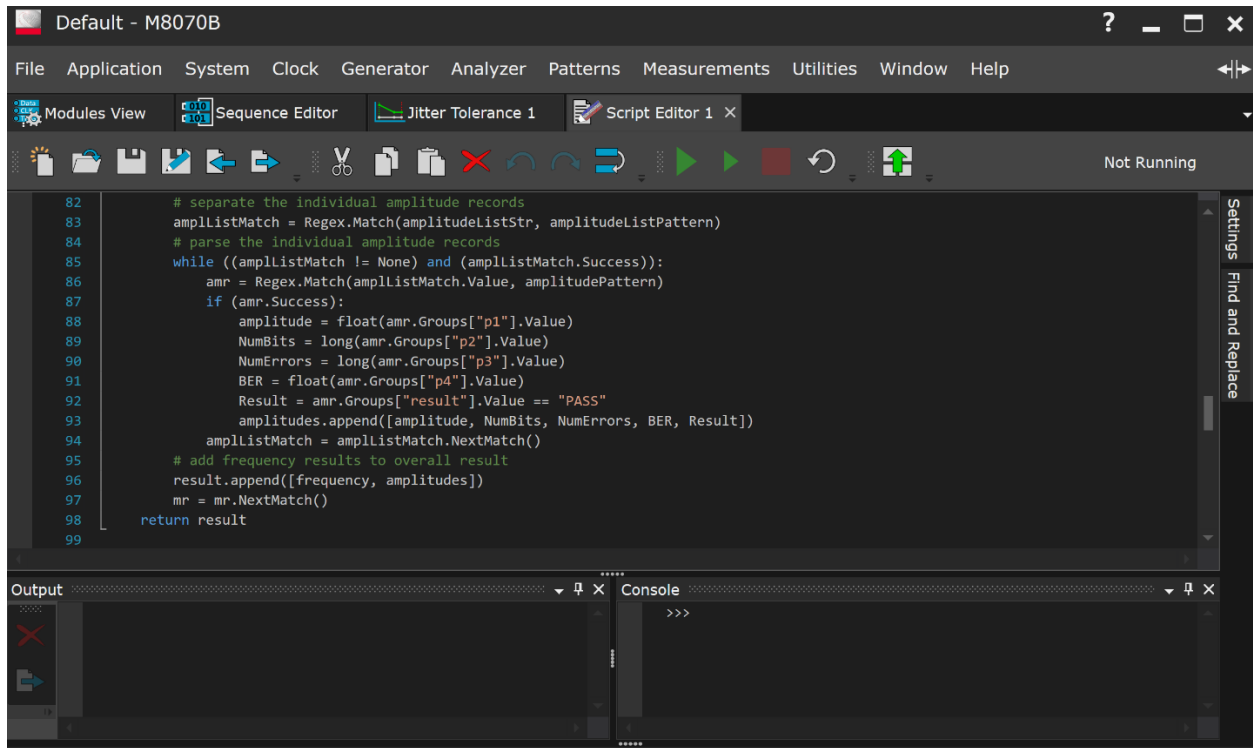

Figure 28. The built-in scripting engine of J-BERT M8020A allows to communicate with the DUT or other instruments. The scripting language is IronPython.

System Software M8070B

The M8070B system software for the M8000 Series of BER Test Solutions is required to control M8041A, M8051A, and M8062A.

Table 26. User interface and remote-control interface.

System software	M8070B
Software licensing	The M8070B is a system software required to control the M8000 BERTs and AWGs platforms. The M8070B is free and doesn't require a license. For extended applications M8070ADVB and M8070EDAB can be ordered. For detailed features of these software licenses see table 26.
Controller requirements	Embedded PC: Choose M8020A-BU3 with preinstalled Windows 10 on embedded controller M9537A including pre-installation of M8070B software and module licenses. Otherwise: M9537A 1-slot AXIe embedded controller, choose options 8 or 16 GB RAM and USB External PC: USB connection recommended between external PC and AXIe chassis. Minimum of 8 GB RAM recommended. For PCIe connectivity please refer to list of tested PCs for AXIe Technical Note, pub no. 5990-7632EN
Operating system	Microsoft Windows 10 Version 1607 (Anniversary Update) or newer, Windows 7 (64 bit) SP1, Windows 8 (64 bit) or Windows 8.1 (64 bit). For detailed requirements refer to M8070B release notes.
Controller connectivity with AXIe chassis	USB 2.0 (Mini-B) recommended, PCIe 2.0/8x (only for highest data throughput and desktop PC)
Programming language	SCPI. Not compatible with N4900 series and ParBERT 81250A
Remote control interface	Desktop or Laptop PC: LAN M9547A: LAN
Save/Recall	Yes
Display resolution	Minimum requirement 1024 x 768
Ivi.com driver	Yes
Command expert	Yes
Operating System	Microsoft Windows 10 (64 bit) Version 1607 (Anniversary Update) or newer, Windows 7 SP1 or 8 / 8.1 (all 64 bit),
Software pre-requisites	Keysight IO Library rev. 18.0.22209.2 or above AXIe Chassis Firmware (Embedded System Module (ESM) from Keysight Technologies) greater than or equal to version 1.3.42
Software details	See www.keysight.com/find/M8070B .

System Software M8070B (Continued)

The M8070B is a system software required to control the M8000 BERTs and AWGs platforms. The M8070B offers a graphical user interface and remote control for all parameters. Supports connectivity of the instruments and the controller via USB and PCIe. The functionalities of the M8070B software can be enhanced by addition with following software packages:

- M8070ADVB Advanced Measurement Package for M8000 Series BERT Test Solutions- This package offers advanced features like automated jitter tolerance test and parameter sweeps, eye diagram measurement or the integration of external equipment such as electrical clock recovery or a real-time scope as an error detector.
- M8070EDAB Error Distribution Analysis Package for M8000 Series BERT Test Solutions- this package enables a deep insight into error mechanisms such as error bursts, error distribution or deterministic error patterns. This information can be used to estimate the performance of FEC-based systems.

The M8070ADVB & M8070EDAB are a licensed software packages enabling advance measurement and error analysis capabilities in addition to the M8070B System Software version 6.0 and higher.

Table 27. Functions provides by M8070B, M8070ADVB and M8070EDAB software package

Feature	Feature Type	M8070B SW	M8041A/51A	M8062A
BER/SER measurement	Measurement	M8070B	Yes	Yes
BERT scan with RJ, DJ separation	Measurement	M8070ADVB	Yes	Yes
Counters	Measurement	M8070B	Yes	Yes
Sampling point & threshold setup	Measurement	M8070B	Yes	Yes
Output timing measurement	Measurement	M8070ADVB	Yes	Yes
Output level measurement	Measurement	M8070ADVB	Yes	Yes
NRZ eye contour	Measurement	M8070ADVB	Yes	No
Jitter tolerance measurement	Measurement	M8070ADVB	Yes	Yes
Automated parameter sweep	Measurement	M8070ADVB	Yes	Yes
Eye diagram measurement	Measurement	M8070ADVB	Yes	Yes
Frame Loss Ratio Estimation	Measurement	M8070EDAB	Yes	Yes
Error Map	Measurement	M8070EDAB	Yes	Yes
Error Distribution Analysis	Measurement	M8070EDAB	Yes	Yes
AWG control	HW control	M8070B	Yes	Yes
External CDR control	HW control	M8070ADVB	Yes	Yes
Error analysis using a real-time scope	HW control	M8070ADVB	Yes	Yes
DUT control interface	Utilities	M8070ADVB	Yes	Yes
SCPI editor	Utilities	M8070ADVB	Yes	Yes
SCPI recorder	Utilities	M8070ADVB	Yes	Yes
Script editor	Utilities	M8070ADVB	Yes	Yes

System Software M8070B (Continued)

Table 28. Functions provides by the advanced measurement software package M8070ADVB

Advanced measurement package	M8070ADVB
Measurements	See table 24 measurements
Export of measurement results	Jitter tolerance results as *.csv file
Controlling other instruments via M8070B	External clock recovery units, e.g. N1076A, N1076B, N1077A, N1078A Real-time oscilloscopes, e.g. DASZ634A, UXR0334A
DUT control interface	Enables access to built-in error counters and status registers of a device under test (BIST) for use with automated measurements like accumulated BER and jitter tolerance. Can also be used to customize the measurements to DUT specific needs. IronPython scripting and .net libraries are supported to interface with the DUT.
SCPI recorder	Allows recording of the SCPI commands that correspond to the interactive control in the GUI. This includes: <ul style="list-style-type: none"> • Parameter changes • Sequence and pattern configuration • Measurement creation, configuration and execution • Group configuration • Save and recall of settings The recorded SCPI commands can be copied to the clipboard or saved to a file for later playback.
Scripting interface	The built-in scripting engine is based on IronPython. It enables the control of the device under test as well as another test equipment. Function hooks are available to tailor your measurements, such as read-out of built-in error counters or initializing the device
Software license types	Choose between <ul style="list-style-type: none"> • node-locked, • transportable, • network, • USB-dongle license Each is available as perpetual or time-based with 6/12/24 month duration. The network license is only recommended when using multiple M8020A setups within one company
Software prerequisites	M8070B revision 6.0.210.6 or higher

Table 29. Functions provided by the Error Distribution Analysis software package M8070EDAB

Error Distribution Analysis Package	M8070EDAB
Measurements	See table measurements
Software license types	Choose between <ul style="list-style-type: none"> • node-locked, • transportable, • network, • USB-dongle license Each is available as perpetual or time-based with 6/12/24 month duration. The network license is only recommended when using multiple M8020A setups within one company
Software prerequisites	M8070B revision 6.0.210.6 or higher

General Characteristics and Physical Dimensions

Table 30. General characteristics

	M8041A	M8051A
Operating temperature	5 °C to 40 °C (41 °F to + 104 °F)	
Storage temperature	-40 °C to +70 °C (modules) (-40 °F to + 158 °F)	
Operating humidity	15% to 95% relative humidity at 40°C (non-condensing)	
Storage humidity	24% to 90% relative humidity at 65°C (non-condensing)	
Power requirements (module only)	350 W	250 W
Physical dimensions for modules (W x H x D)	3- slot AXIe module: 351 x 92 x 315 mm (13.8 x 3.6 x 12.4 inch)	2-slot AXIe module: 351 x 61 x 315 mm (13.8 x 2.4 x 12.4 inch)
Physical dimensions for M8020A-BU2/-BU3 (W x H x D)	Installed in 5-slot AXIe chassis: 463 x 194 x 446 mm (18.2 x 7.6 x 17.6 inch)	
Weight net	M8041A module: 6.6 kg (14.6 lb) With M8020A-BU3: 24 kg (53 lb) With M8020A-BU2: 19.9 kg (43.9 lb)	M8051A module: 5.0 kg (11.0 lb) In bundle with M8041A and in a 5-slot chassis: 24.9 kg (54.9 lb)
Weight shipping	With M8020A-BU3: 37 kg (82 lb) With M8020A-BU2: 32.5 kg (71.7 lb)	N/A
Recommended recalibration period	1 year	
Warm-up time	30 minutes	
Cooling requirements	Slot airflow direction is from right to left. When operating the M8041A/51A choose a location that provides at least 50 mm of clearance at each side. See also start-up guide for M9505A chassis.	
EMC	IEC 61326-1	
Safety	IEC 61010-1	
Quality management	ISO 9001, 14001	

Specification Assumptions

The specifications in this document describe the instruments' warranted performance. Preliminary values are written in *italic*. Non-warranted values are described as typical. All specifications are valid in the specified operating temperature range after the warm-up time and after auto-adjustment. If not otherwise stated all outputs need to be terminated with 50 Ω to GND. All M8041A and M8051A specifications if not otherwise stated are valid for transition times set to "steep" and using the recommended cable pair M8041A-801 (2.92 mm, 0.85 m, matched pair).

Ordering Instructions

Please refer to the J-BERT M8020A High-Performance BERT - Configuration Guide (5991-4032EN) for ordering details.



M8020A-BU2
16 Gb/s High-performance BERT,
1-2 channel with external PC



M8020A-BU3 (Windows 10 pre-installed)
with embedded PC



16 Gb/s High-performance BERT, 3-4 channel
(external PC not shown)



32 Gb/s High-performance BERT, 1 channel with M8062A
(external PC not shown).

Default Accessories Included with Shipment:

M8041A module: eight 50 Ω terminations, commercial calibration report (“UK6”), certificate of calibration, ESD protection kit.

M8051A module: four 50 Ω terminations, clock synchronization cable (M8051A-801), commercial calibration report (“UK6”), certificate of calibration.

M8062A module: see M8062A data sheet

M8020A-BU3: M9505A AXIe chassis with embedded controller, USB cable, getting started guide, AXIe filler panel, power cord.

M8020A-BU2: M9505A AXIe chassis, USB cable, getting started guide, AXIe filler panel, power cord.

M8070B: System software, basic software package.

Recommended Accessories

DC block, 26 GHz, 3.5 mm	N9398C
ISI channels, four short traces	M8048A-001
ISI channels, four long traces	M8048A-002
Short matched cable pair, SMA (m) to SMA (m) for cascading M8048A ISI channels	M8048A-801
Four SMA cables, unmatched	15442A
Rack-mount kit for AXIe 5-slot chassis M9505A	Y1226A

Test Automation Software with Support of M8020A

Test automation software, core	N5990A-010
Test automation software for PCIe receiver test	N5990A-101
Test automation software for USB receiver test	N5990A-102
Test automation software for SATA receiver test	N5990A-103
Test automation software for Thunderbolt receiver test	N5990A-104
Test automation software for SAS receiver test	N5990A-105
Test automation software for SD UHDS-II	N5990A-120
Test automation software for DisplayPort	N5990A-155
Test automation software for MIPI M-PHY	N5990A-165
PCI Express 3.0 link training suite	N5990A-301
USB link training suite	N5990A-302
SATA link training suite	N5990A-303
SAS link Training Suite	N5990A-305
MIPI M-PHY frame generator	N5990A-365
MIPI M-PHY/Unipro error counter and test script wizard	N5990A-367
MIPI M-PHY protocol-specific macros for LLI, SSIC and DigRF	N5990A-368
PCIe link equalization tests	N5990A-501
DDR5 Receiver Conformance and Characterization Test Application	M80885RCA

Calibration and Productivity Services

Calibration services (3 and 5 years)	R1282
Productivity assistance	R1380-8000

Related Keysight Literature

Data sheets and configuration guides:

J-BERT M8020A, Configuration Guide	5991-4032EN
M8062A 32Gb/s BERT Front-End, Data Sheet	5992-0987EN
M8030A Multi-channel BERT, Data Sheet	5992-1287EN
M8040A High-Performance BERT 64 GBaud, Data Sheet	5992-1525EN
N1076A/77A Electrical and Optical Clock Data Recovery Solutions, Data Sheet	5992-1620EN
M9505A AXIe Chassis 5-slot, Data Sheet	5990-6584EN

M8048A ISI Channels, Data Sheet	5991-3548EN
M8049A ISI Channel Boards, Data Sheet	5992-3617EN
M8062A 32Gb/s BERT Front-End, Data Sheet	5992-0987EN
M8030A Multi-channel BERT, Data Sheet	5992-1287EN
M8040A High-Performance BERT 64 GBaud, Data Sheet	5992-1525EN
N1076A/77A Electrical and Optical Clock Data Recovery Solutions, Data Sheet	5992-1620EN
M9505A AXIe Chassis 5-slot, Data Sheet	5990-6584EN

Application notes and white paper:

Master your MIPI M-PHY receiver test using J-BERT M8020A, Application Brief	5991-3959EN
How to pass receiver test according PCI Express CEM specification, Application Note	5990-9208EN
Accurate calibration of PCIe 3.0 receiver stress signals, Application Note	5990-6599EN
How to test a MIPI M-PHY high-speed receiver, Application Note	5991-2848EN
Master your next PCIe3 receiver test using J-BERT M8020A, Application Note	5991-4190EN
The Fast Track to PCIe 5.0, White Paper	5992-3461EN
Master your next USB 3.x designs with J-BERT M8020A, Application Note	5991-4357EN
Characterizing and verifying compliance of 100Gb Ethernet components and systems, Application Note	5992-0019EN

PCI-SIG®, PCIe® and PCI Express® are US registered trademarks and/or service marks of the PCI-SIG.

Learn more at: www.keysight.com

For more information on Keysight Technologies' products, applications or services, please contact your local Keysight office. The complete list is available at: www.keysight.com/find/contactus

