

FieldFox B-Series Handheld Analyzers

4/6.5/9/14/18/26.5/32/44/50/54 GHz

N9913B*	N9950B	N9933B*	N9960B
N9914B*	N9951B	N9934B*	N9961B
N9915B*	N9952B	N9935B*	N9962B
N9916B	N9953B	N9936B	N9963B
N9917B		N9937B	
N9918B		N9938B	

*: Discontinued and replaced by corresponding Keysight N99xxC Series FieldFox.



Table of Contents

Introduction	3
Definitions.....	3
Cable and Antenna Analyzer (CAT) and Vector Network Analyzer (VNA).....	4
Corrected Measurement Uncertainty	17
TDR Cable Measurements (Option 215)	37
VNA Time Domain (Option 010)	37
Mixed-Mode S-Parameters (Option 212).....	38
Vector Voltmeter (VVM) (Option 308).....	39
Spectrum Analyzer (Option 233 on Combination Analyzers)	40
Tracking Generator or Independent Source	54
Real-Time Spectrum Analyzer (RTSA) (Option 350).....	56
I/Q Analyzer (IQA) (Option 351).....	58
Noise Figure (NF) (Option 356)	65
Spectrum Analyzer IF Output.....	72
Preamplifier (Option 235).....	73
Interference Analyzer and Spectrogram (Option 236).....	73
Channel Scanner (Option 312)	73
89600 VSA Software.....	74
Over-the-Air (OTA) LTE FDD/TDD (Option 370/371).....	75
Over-the-Air (OTA) 5G TF (Option 377)	76
Over-the-Air (OTA) 5G NR (Option 378).....	78
Indoor and Outdoor Mapping (Option 352).....	81
EMF Measurements (Option 358).....	82
AM/FM Analog demodulation, Tune and Listen (Option 355).....	84
Reflection Measurements (RL, VSWR) (Option 320, applicable to SA only models).....	85
Extended Range Transmission Analysis (ERTA) (Option 209)	86
Built-in Power Meter (Option 310).....	92
External USB Power Sensor Support (Option 302).....	93
Pulse Measurements (Option 330)	94
USB Power Sensor Measurements versus Frequency (Option 208)	94
Built-In GNSS (GPS+) Receiver (Option 307)	96
DC Bias Variable-Voltage Source (Option 309).....	96
Remote Control Capability (Option 030).....	97
EMI measurements (Option 361).....	97
Pulse Generator (Option 357).....	98
General Information	100
FieldFox Physical Dimensions	104
Keysight Support Services	107
Carry Precision with You.....	108

Introduction

This data sheet provides the specified and typical performance of the FieldFox family of portable analyzers. This data sheet should be used in conjunction with the technical overviews and configuration guide, for a complete description of the analyzers.

The specifications for the 32, 44, or 50 GHz analyzers shown in this data sheet apply to the FieldFox analyzers with serial number prefix break \geq MY/US/SG6125, or with the RF board part number: N9960-63011 ¹. If your FieldFox analyzer (32, 44, or 50 GHz) is with the older RF board (part number of N9960-63001 ¹) and desire to obtain a copy of data sheet that includes specifications reflecting the previous version of hardware, you may contact Keysight technical support by creating a support case via <https://support.keysight.com/s/>.

The specifications and measurement capabilities listed in this document require certain options on the FieldFox analyzer. Refer to the FieldFox Configuration Guide to obtain option information. The configuration guide is the main resource for option/measurement capability information (<https://www.keysight.com/us/en/assets/7018-06515/configuration-guides/5992-3701.pdf>).

Definitions

Specification (spec)

Specifications include guard bands to account for the expected statistical performance distribution, measurement uncertainties, and changes in performance due to environmental conditions. Specifications are warranted performance. FieldFox must be within its calibration cycle. No warm-up required for the specifications listed on pages 40 through 98.

Typical

Describes additional product performance information not covered by the product warranty. It is performance beyond specifications that 80% of the units exhibit with a 90% confidence level over the temperature range of 23 ± 5 °C, unless otherwise noted. Typical performance does not include measurement uncertainty. FieldFox must be within its calibration cycle.

Nominal

A general, descriptive term or design parameter. It is not tested, and not covered by the product warranty. FieldFox must be within its calibration cycle.

¹ To find an analyzer's RF part number, press [System], {Service Diagnostics}, {System Information}. Here, "[]" denotes the hard-key, and "{ }" the soft-key.

Cable and Antenna Analyzer (CAT) and Vector Network Analyzer (VNA)

The performance listed in this section applies to the cable and antenna analyzer (referred to as CAT) and vector network analyzer (VNA) capabilities available in the following models:

Description	Model number
FieldFox RF & microwave (combination) analyzers	N9913B ¹ , N9914B ¹ , N9915B ¹ , N9916B, N9917B, N9918B, N9950B, N9951B, N9952B, N9953B

NOTE: Combination analyzers = Cable and antenna tester (CAT) + Vector network analyzer (VNA) + Spectrum analyzer (SA)

See [FieldFox Configuration Guide](#) for option information. Many capabilities listed in this Data Sheet require options.

Frequency specifications

Series	Model	Frequency range
N991xB	N9913B ¹	30 kHz to 4 GHz
	N9914B ¹	30 kHz to 6.5 GHz
	N9915B ¹	30 kHz to 9 GHz
	N9916B	30 kHz to 14 GHz
	N9917B	30 kHz to 18 GHz
	N9918B	30 kHz to 26.5 GHz
N995xB	N9950B	300 kHz to 32 GHz
	N9951B	300 kHz to 44 GHz
	N9952B	300 kHz to 50 GHz
	N9953B	300 kHz to 54 GHz

Frequency reference (-10 to 55 °C)

Accuracy	±0.9 ppm (spec) + aging
	±0.5 ppm (typical) + aging
Accuracy, when locked to GPS	±0.01 ppm (nominal)
Accuracy, when GPS antenna is disconnected	±0.4 ppm (nominal) ²
Aging rate	±1 ppm/yr for 20 years (spec), will not exceed ±3.5 ppm

¹ Discontinued and replaced by corresponding Keysight N99xxC Series FieldFox.

² The maximum drift expected in the frequency reference applicable when the ambient temperature changes ±5 °C from the temperature when the GPS signal was last connected.

Frequency resolution	Specification (Hz)	Model
30 kHz to 1.91211 GHz	0.67	N991xB, or N995xB (starting 300 kHz)
≥ 1.91211 to 3.82461 GHz	1.34	N991xB, or N995xB
≥ 3.82461 to 7.64961 GHz	2.68	N991xB, or N995xB
≥ 7.64961 to 15.29961 GHz	5.36	N991xB, or N995xB
≥ 15.29961 to 26.5 GHz	10.73	N991xB, or N995xB
≥ 26.5 to 45.8 GHz	16.09	N995xB
≥ 45.8 to 54 GHz	32.19	N995xB

Data points or resolution

101, 201, 401, 601, 801, 1001, 1601, 4001, 10,001
Arbitrary number of points settable through front panel and SCPI

IF bandwidth ¹

3 Hz, 10 Hz, 30 Hz, 100 Hz, 300 Hz, 1 kHz, 3 kHz, 10 kHz, 30 kHz, 100 kHz

System impedance

50 Ω (nominal), 75 Ω with appropriate adapter and calibration kit

Test port output specifications

High power in the N991xB and N995xB refers to the analyzer's target output power level when the Power Setting is High. Examples:

- N991xB: For a 5 to 10 GHz frequency sweep, the analyzer achieves a 7 dBm power level across the band.
- N995xB: For an 18 to 26.5 GHz frequency sweep, the analyzer achieves a 4 dBm power level across the band.

Low power level for N991xB and N995xB analyzers flattens at -50 dBm across the entire frequency band and is the analyzer's output when the Power Setting is Low.

Max leveled power in the N991xB and N995xB refers to the maximum leveled (flattened) power achieved across the designated frequency range. Examples:

- N991xB: For a 1 to 10 GHz frequency sweep with the analyzer configured to measure all four S-parameters, needing both ports 1 and 2, the maximum power the analyzer can be set to is 5 dBm.
- N995xB: For an 18 to 26.5 GHz frequency sweep with the analyzer configured to measure all four S-parameters, needing both ports 1 and 2, the maximum power the analyzer can be set to is 3 dBm.

¹ VNA mode only. Recommend using averaging in CAT mode.

Test port output power (dBm), high power	Typical	Typical
N991xB	Port 1	Port 2
30 kHz to 500 kHz	-9	-7
> 500 kHz to 10 MHz	-1	-1
> 10 MHz to 1 GHz	9	8
> 1 to 5 GHz	8	7
> 5 to 10 GHz	7	7
> 10 to 18 GHz	6	5
> 18 to 26.5 GHz	3	2
N995xB	Port 1	Port 2
300 kHz to 1 MHz	-5	-4
> 1 MHz to 10 MHz	-1	-1
> 10 MHz to 6 GHz	5	5
> 6 to 18 GHz	6	5
> 18 to 26.5 GHz	4	4
> 26.5 to 32 GHz	2	1
> 32 to 40 GHz	2	-1
> 40 to 44 GHz	-3	-2
> 44 to 50 GHz	-4	-5
> 50 to 54 GHz	-8	-8

Test port output power (dBm), low power	Typical
N991xB	Port 1 or Port 2
30 kHz to 26.5 GHz	-50 dBm (flattened) ± 0.5 dB
N995xB	Port 1 or Port 2
300 kHz to 54 GHz	-50 dBm (flattened) ± 0.5 dB

Max leveled output power (dBm)	Nominal	Nominal
N991xB	Port 1	Port 2
> 10 MHz to 1 GHz	6	6
> 1 to 10 GHz	6	5
> 10 to 18 GHz	4	3
> 18 to 26.5 GHz	2	0
N995xB	Port 1	Port 2
> 300 kHz to 1 MHz	-4	-4
> 1 MHz to 10 MHz	7	6
> 10 MHz to 6 GHz	8	7
> 6 to 18 GHz	5	4
> 18 to 26.5 GHz	3	3
> 26.5 to 32 GHz	2	1
> 32 to 44 GHz	1	-2
> 44 to 50 GHz	-5	-6
> 50 to 54 GHz	-9	-9

Output power range	
CAT	High, low, and manual. Default (preset) power is manual, -15 dBm.
VNA	Manual power is flattened.
Power step size	
	Power settable in 1 dB steps across power range. Flat power, in 1 dB steps, is available across the whole frequency span, nominal.
Power level accuracy ¹	Typical
N991xB	Port 1 or Port 2 at -15 dBm
30 kHz to 10 MHz	±0.7 dB
> 10 MHz to 26.5 GHz	±0.5 dB
N995xB	Port 1 or Port 2 at -15 dBm
300 kHz to 54 GHz	±0.5 dB
Power level linearity	Nominal
N991xB	Port 1 or Port 2, -50 dBm ≤ P < max leveled power
> 10 MHz to 26.5 GHz	±0.5 dB
N995xB	Port 1 or Port 2, -60 dBm ≤ P < max leveled power
> 300 kHz to 54 GHz	±0.5 dB

¹ N995xB power levels are calibrated based on PNA-X tuned receiver for the entire frequency range.

System performance specifications

System dynamic range ^{1, 2} (dB), high power, 300 Hz IFBW, 100-point average, Port 1 or Port 2 (-10 to 55 °C)

N991xB	S12 spec	S12 typical	S21 spec	S21 typical
30 kHz to 1 MHz	—	114 (nominal)	—	113 (nominal)
> 1 to 6.34 MHz	105	114	104	111
> 6.34 MHz to 16 GHz	108	114	106	116
> 16 to 18 GHz	109	117	104	114
> 18 to 24 GHz	105	115	102	113
> 24 to 26.5 GHz	102	113	97	109
N995xB	S12 spec	S12 typical	S21 spec	S21 typical
300 kHz to 1 MHz	—	105 (nominal)	—	104 (nominal)
> 1 to 10 MHz	102	113	100	111
> 10 MHz to 6 GHz	109	121	107	120
> 6 to 16 GHz	106	117	105	118
> 16 to 18 GHz	107	119	104	117
> 18 to 24 GHz	106	117	102	116
> 24 to 26.5 GHz	102	115	100	115
> 26.5 to 32 GHz	97	111	98	111
> 32 to 39 GHz	92	107	96	110
> 39 to 46 GHz	89	101	86	103
> 46 to 50 GHz	85	99	85	98
> 50 to 54 GHz	80	94	79	95

Measurement stability over temperature

	Frequency	Nominal	
		Magnitude (dB/°C)	Phase (deg/°C)
N991xB	≤ 6 GHz	±0.010	±0.15
	> 6 to 15 GHz	±0.025	±0.5
	> 15 to 26.5 GHz	±0.035	±0.5
N995xB	300 kHz to 2 MHz	±0.018	±0.88
	2 MHz to 6 GHz	±0.008	±0.12
	6 to 15 GHz	±0.016	±0.32
	15 to 26.5 GHz	±0.025	±0.55
	26.5 to 40 GHz	±0.033	±0.85
	40 to 50 GHz	±0.06	±1.4
	50 to 54 GHz	±0.05	±1.5

1 System dynamic range is measured in the factory with loads on the test ports after a thru normalization.

2 For CAT mode, "Insertion loss (2-port)", decrease listed dynamic range specifications by 20 dB, as CAT mode IFBW is fixed at 10 kHz. Can obtain full dynamic range by using S21 measurement in VNA mode with 100 Hz IFBW.

Measurement speed (Sweep time)	Nominal	
	N991xB	N995xB
CAT		
Return loss, 30 kHz to 26.5 GHz, 1-port cal, 1001 points	409 μ s/pt	—
Return loss, 300 kHz to 54 GHz, 1-port cal 1001 points	—	457 μ s/pt
Distance-to-fault, 100-meter cable, 1-port cal, 1001 points	470 μ s /pt	506 μ s/pt
VNA	N991xB	N995xB
S11 and S21, 30 kHz to 26.5 GHz, enhanced response cal, 100 kHz IF bandwidth, 1001 points	171 μ s/pt	—
S11 and S21, 300 kHz to 54 GHz, enhanced response cal, 100 kHz IF bandwidth, 1001 points	—	196 μ s/pt

Test port input specifications

Trace noise ¹, high power, 300 Hz IFBW, Port 1 or Port 2

Specifications (-10 to 55 °C)

	Frequency	Magnitude (dB rms)	Phase (deg rms)
N991xB	30 kHz to 100 kHz	0.0008 (nominal)	0.007 (nominal)
	≥ 100 kHz to 5 GHz	0.0010	0.005
	> 5 to 15 GHz	0.0014	0.014
	> 15 to 26.5 GHz	0.0020	0.027
N995xB	≥ 300 kHz to 34 MHz ²	0.0010	0.0070
	> 34 MHz to 5 GHz	0.0010	0.0070
	> 5 to 15 GHz	0.0014	0.0140
	> 15 to 26.5 GHz	0.0020	0.0270
	> 26.5 to 32 GHz	0.0030	0.0500
	> 32 to 44 GHz	0.0040	0.0600
	> 44 to 50 GHz	0.0040	0.1200
	> 50 to 54 GHz	0.05 (nominal)	0.75 (nominal)

Receiver compression

Typical

	Frequency	Port 1 or Port 2
N991xB	250 kHz to 2 GHz	+7 dBm, 0.20 dB compression
	> 2 to 5 GHz	+8 dBm, 0.15 dB compression
	> 5 to 26.5 GHz	+8 dBm, 0.10 dB compression
N995xB	300 kHz to 7 MHz	+5 dBm, 0.20 dB compression
	> 7 MHz to 26.5 GHz	+5 dBm, 0.10 dB compression
	> 26.5 to 54 GHz	+5 dBm, 0.15 dB compression

Maximum input level

Port 1 or Port 2

	Average CW power	DC
N991xB	+27 dBm, 0.5 watts	±50 VDC
N995xB	+25 dBm, 0.3 watts	±40 VDC

Immunity to interfering signals (nominal)

N991xB

N995xB

		N991xB	N995xB
On carrier frequency		+10 dBm	+9 dBm
Offset from carrier frequency	> 1 MHz	+13 dBm	+8 dBm
	> 10 MHz	+18 dBm	+12 dBm

¹ For CAT mode, increase trace noise by a factor of 5.7, as CAT mode IFBW is fixed at 10 kHz. Can use averaging in CAT mode to reduce trace noise or use VNA mode with 300 Hz IFBW.

² Excludes multiples of 65 kHz, and 7.792198 MHz, 8.190585 MHz, and 8.954400 MHz.

CAT and VNA measurements

CAT mode

CAT measurements	Distance-to-fault (dB) Return loss (dB) Return loss & DTF (dB) VSWR Distance-to-fault (VSWR) Cable loss (1-port) Insertion loss (2-port) (requires option 211) Distance-to-fault (Lin) TDR (Lin rho) (requires option 215) TDR (ohm) (requires option 215) TDR & DTF (requires option 215)
Distance-to-Fault (DTF) settings	
Frequency/distance	Start distance, stop distance
Sweep time	Units: meters or feet (Can also be set as Preferences)
Frequency mode	Bandpass, lowpass
CAT mode averaging	Set sweep time in seconds
Distance-to-Fault	Available in CAT mode. Standard on N991xB analyzers. Range = velocity factor x speed of light x (number of points - 1) / frequency span x 2; number of points auto coupled according to start and stop distance entered. Resolution = range / (number of points - 1) Transform modes: Bandpass, low-pass Window types: Maximum, medium, and minimum Alias free range indicator: On/Off Dispersion compensation for waveguide: Yes
Return loss, log magnitude	-500 to 500 dB
Log magnitude resolution	0.01 dB
VSWR	1.01 to 1000
VSWR resolution	0.01

VNA mode	
VNA Transmission/Reflection (T/R)	S11, S21 magnitude and phase (requires Option 210)
VNA S-parameters	S11, S21, S22, S12 magnitude and phase (requires Options 210 and 211)
Number of traces	Four traces available: Tr1, Tr2, Tr3, Tr4
Display formats	Single-trace Dual-trace split (each trace on separate graticule) Dual-trace overlay (both traces on one graticule) Three-trace split (each trace on separate graticule) Three-trace overlay (all three traces on one graticule) Quad-trace split (each trace on separate graticule) Quad-trace overlay (all four traces on one graticule)
VNA trace formats	Log magnitude, linear magnitude, VSWR, phase, Smith chart, polar, group delay, unwrapped phase, real impedance, imaginary impedance, Z magnitude
Frequency settings	Start, stop, center, span
Frequency sweep type	Linear
Sweep type trigger	Continuous, single
Sweep trigger source	Internal, external, point (point trigger applies to 1-port cal only)
Sweep trigger slope	Positive, negative
Sweep trigger delay	0 to 10 seconds
Averaging	Sweep: 2 to 1000; Point: 2 to 500
Smoothing	Computes the moving average of adjacent data points. Smoothing aperture defines the trace width (number of points) to be averaged. Minimum aperture: 0.05% of frequency span Maximum aperture: 25% of frequency span
Scale	Autoscale, scale, reference level, reference position Autoscale: Automatically selects scale resolution and reference value to center the trace. Autoscale all: Scales all visible traces.
S11, log magnitude	-500 to 500 dB
Log magnitude resolution	0.01 dB
VSWR	1.01 to 1000
VSWR resolution	0.01
Phase	-180 to +180 degrees (unwrapped phase can show larger values)
Phase resolution	0.01 degrees
Phase offset	-360 to +360 degrees
Magnitude offset	-100 to +100 dB
Trace math	Vector division or subtraction of current linear measurement values and memory data
Port extension	For both port 1 and port 2, delay settings. Port extensions apply to all measurements.
Marker formats	Default marker format is the trace format. Other formats: R + jX Z magnitude Phase Real Imaginary Mag & Phase dB Angle

General CAT / VNA modes	
Marker functions	Peak, Next Peak, Peak Left, Peak Right, Mkr→Center, Mkr→Delay, Min Search, Peak Excursion, Peak Threshold, Target, Bandwidth (BW, Q, Loss), Tracking CAT mode only: Tracking 3 peaks (CAT mode), Mkr→Start distance, Mkr→Stop distance
Marker table	On/Off
Marker types	Normal, delta, data trace and memory trace markers
Marker coupling	On/Off (coupling between traces)
Frequency blanking	Security level: none, high. If high, all frequency information is blanked out. An instrument preset is required to re-enable the frequency information.
Display data	Display data, memory, data and memory, or data math
Trace math	One memory trace per data trace.

CAT and VNA mode calibrations

FieldFox analyzers offer three tiers of calibrations, thus providing users with different levels of calibration effort and accuracy.

CalReady

CalReady is the most basic calibration and is sufficient for a quick pass/fail or go/no go verification. Every FieldFox is calibrated at the factory, at test ports 1 and 2, at room temperature. CalReady can be applied either as an “enhanced response CalReady” or a “2-port CalReady.” The default setting is 2-port CalReady, so correction is applied to both ports. A user preference allows user to change the CalReady methodology to enhanced response CalReady.

A 30-minute warm-up period is recommended for a quick test. A 60-minute warm-up is necessary for more stringent test requirements.

If CalReady is the basis for most measurements, the annual cal cycle must be followed, as the CalReady calibration will be updated during the annual cal cycle.

Standard calibrations

Standard calibrations are the most accurate calibrations offered in FieldFox. FieldFox's calibration engine is based on Keysight's flagship PNA calibration engine, and as such, offers many of the standard calibrations. FieldFox supports both coaxial and waveguide calibrations. The table below lists the commonly used calibrations.

Keysight recommends a 30-minute warm-up period for standard calibrations. For ultimate in stability and accuracy, a 90-minute warm-up period is necessary.

Frequency response

Open response Short response Thru response With and without isolation	Simultaneous magnitude and phase correction of frequency response errors for either reflection or transmission measurements. Isolation corrects for crosstalk errors.
1-port OSL (Port 1)	Open, short, and load
1-port OSL (Port 2)	Traditional 1-port calibration for reflection measurements. Corrects for directivity, source match, and frequency response errors.
SSL (for waveguide)	For waveguide calibrations, depending on the calibration kit definition, this is presented as a short, offset short and load calibration.
Enhanced response (also known as one-path, two-port) Forward enhanced response Reverse enhanced response	Corrects for frequency response and source match. Partial correction for load match for low-loss reciprocal devices.
QSOLT (2-port)	QSOLT or Quick short-open-load-thru is FieldFox's default recommended calibration for insertable devices. Full 12-term error correction. Requires fewer connections, compared to traditional SOLT (4 compared to 7). Corrects for directivity, source match, reflection frequency response, load match, and transmission frequency response.
Full 2-port (unknown thru calibration)	FieldFox's default recommended calibration for non-insertable devices. Full 12-term error correction. Beneficial for characterizing non-insertable devices such as Type-N to 3.5 mm, or female-female devices. Corrects for directivity, source match, reflection frequency response, load match, and transmission frequency response.
TRL	TRL or thru-reflect-line compensates for directivity, reflection, and transmission frequency response in both the forward and reverse directions.

Note: FieldFox does not offer the traditional SOLT calibration. Instead, it offers the more accurate Full 2-port (unknown thru), and also QSOLT.

ECal

FieldFox supports all Keysight USB ECal modules, both standard and value-line ECals.

FieldFox's guided calibration wizard

FieldFox's calibration wizard recommends a calibration type and calibration kit based on selected parameters and connector types. Alternatively, users can select their own calibration type and calibration kit. FieldFox's calibration wizard ensures a valid calibration selection.

Interpolation error correction

With any type of accuracy enhancement applied, interpolated mode recalculates the error coefficients when the test frequencies are changed. The number of points can be increased or decreased, and the start/stop frequencies can be changed, but the resulting frequency span must be a subset of the original calibration frequency span.

Connectors

The FieldFox firmware supports the following connector types by default. Add other connector types with a calibration kit that contains the connector type.

Coaxial	Waveguide	
Type-N 50 ohm	WR-10	WR-90
Type-N 75 ohm	WR-15	WR-112
7/16	WR-22	WR-137
TNC	WR-28	WR-187
Type-F	WR-42	WR-284
7 mm	WR-62	WR-650
3.5 mm	WR-75	
2.92 mm		
2.4 mm		
1.85 mm		

FieldFox S-parameter measurement uncertainties

The configurations listed below include measurement uncertainties based on ISO GUM methodology calculations.

FieldFox model	Calibration kit	Calibration type	DUT connector	Uncertainty
N991xB, N995xB	85518A or 85519A	Full 2-port calibration	Type-N	Spec
N991xB, N995xB	85054D	Full 2-port calibration	Type-N	Spec
N991xB, N995xB	85520A or 85521A	Full 2-port calibration	3.5 mm	Spec
N991xB, N995xB	85052D	Full 2-port calibration	3.5 mm	Spec
N991xB, N995xB	N7554A	Full 2-port calibration	Type-N	Spec
N991xB, N995xB	N7555A	Full 2-port calibration	3.5 mm	Spec
N991xB, N995xB	N4690D	Full 2-port calibration	Type-N	Spec
N991xB, N995xB	N4691D	Full 2-port calibration	3.5 mm	Spec
N995xB	85561A or 85562A	Full 2-port calibration	2.92 mm	Spec
N995xB	BN 534913 or BN934914	Full 2-port calibration	2.92 mm	Spec
N995xB	N4692D	Full 2-port calibration	2.92 mm	Spec
N995xB	85563A or 85564A	Full 2-port calibration	2.4 mm	Spec
N995xB	85056D	Full 2-port calibration	2.4 mm	Spec
N995xB	N4693D ECal	Full 2-port calibration	2.4 mm	Spec
N995xB	85058E	Full 2-port calibration	1.85 mm	Spec
N995xB	N4694A/D ECal	Full 2-port calibration	1.85 mm	Spec

Corrected Measurement Uncertainty

N9913/4/5/6/7/8B, 85518A or 85519A, full 2-port Cal, DUT: Type-N, spec

Corrected performance table calculated using uncertainties with a coverage factor of 2.

Corrected performance (dB)	0.2 to 500 MHz	0.5 to 6 GHz	6 to 9 GHz	9 to 18 GHz
Directivity	40	39	32	29
Source match	38	31	29	26
Load match	38	33	28	26
Reflection tracking	± 0.00011	± 0.033	± 0.014	± 0.043
Transmission tracking ¹	± 0.062	± 0.17	± 0.29	± 0.32

Uncertainty plots: power level of -15 dBm, 10 Hz IF bandwidth, no averaging, battery saver off, and 60-minutes warm-up time. Includes uncertainties due to drift, noise, compression, and dynamic accuracy. Coverage factor of 1 applied to uncertainties, for ease of comparison with other industry handheld analyzers.

Transmission uncertainty (S21, S12)

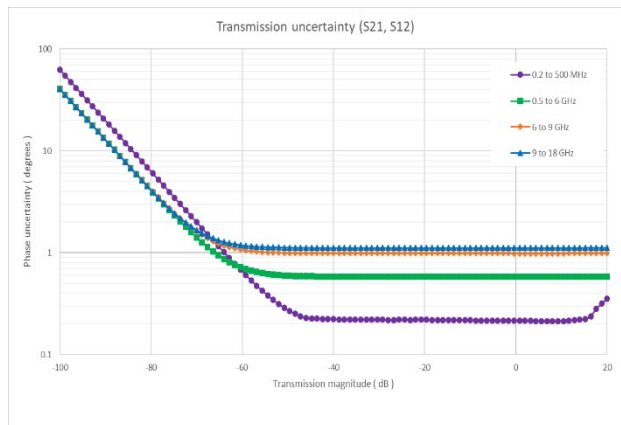
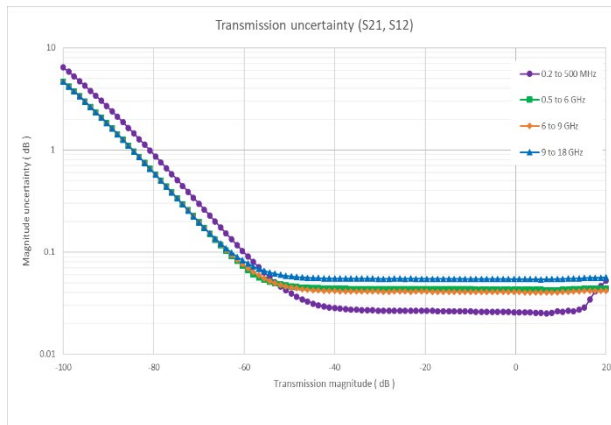

Reflection uncertainty (S11, S22)

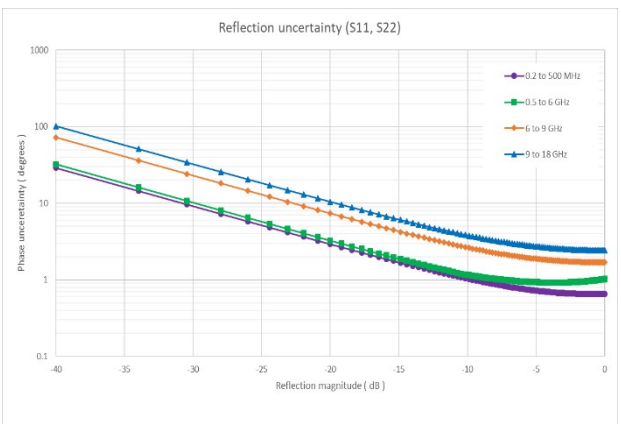
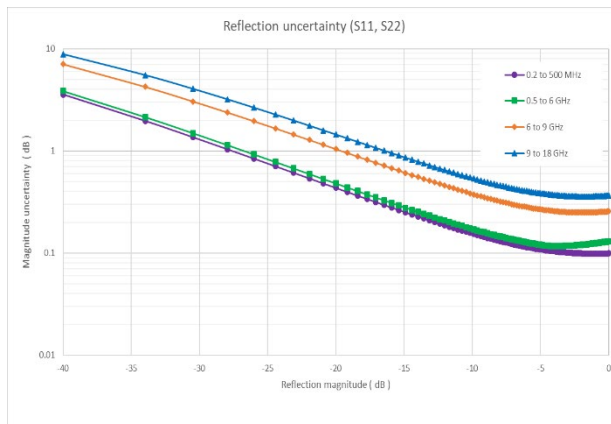

¹ Load match and transmission tracking are typical values

N9913/4/5/6/7/8B, 85054D, full 2-port Cal, DUT: Type-N, spec

Corrected performance table calculated using uncertainties with a coverage factor of 2.

Corrected performance (dB)	0.2 to 500 MHz	0.5 to 2 GHz	2 to 8 GHz	8 to 18 GHz
Directivity	37	37	33	31
Source match	37	37	33	30
Load match ¹	37	37	33	30
Reflection tracking	±0.00068	±0.0019	±0.0053	±0.026
Transmission tracking ¹	±0.0057	±0.017	±0.053	±0.12

Uncertainty plots: power level of -15 dBm, 10 Hz IF bandwidth, no averaging, battery saver off, and 60-minutes warm-up time. Includes uncertainties due to drift, noise, compression, and dynamic accuracy. Coverage factor of 1 applied to uncertainties, for ease of comparison with other industry handheld analyzers.

Transmission uncertainty (S21, S12)

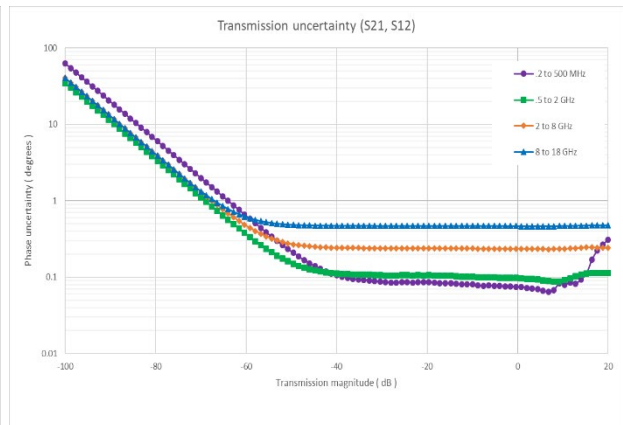
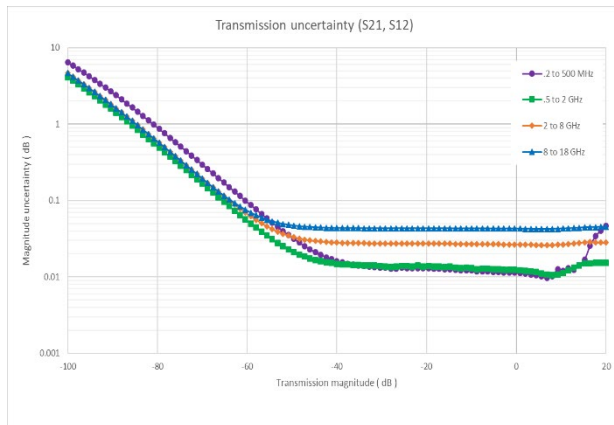

Reflection uncertainty (S11, S22)

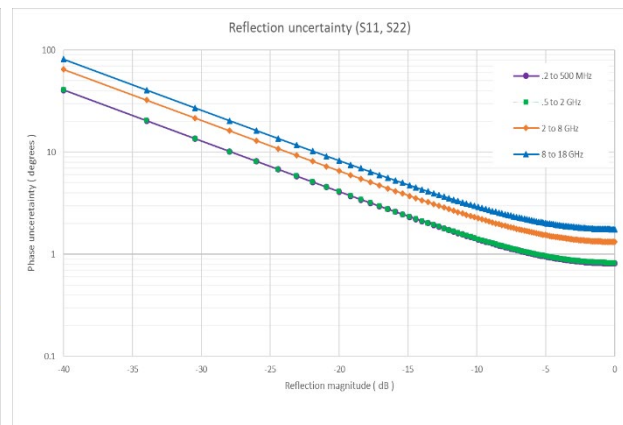
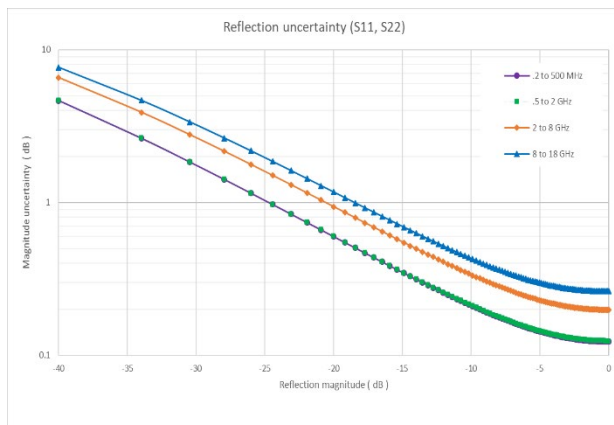

¹ Load match and transmission tracking are typical values

N9913/4/5/6/7/8B, 85520A or 85521A, full 2-port Cal, DUT: 3.5 mm, spec

Corrected performance table calculated using uncertainties with a coverage factor of 2.

Corrected performance (dB)	0.2 to 500 MHz	0.5 to 5 GHz	5 to 15 GHz	15 to 26.5 GHz
Directivity	41	39	33	29
Source match	34	33	29	25
Load match ¹	35	32	28	24
Reflection tracking	±0.0078	±0.022	±0.024	±0.060
Transmission tracking ¹	±0.13	±0.18	±0.29	±0.45

Uncertainty plots: power level of -15 dBm, 10 Hz IF bandwidth, no averaging, battery saver off, and 60-minutes warm-up time. Includes uncertainties due to drift, noise, compression, and dynamic accuracy. Coverage factor of 1 applied to uncertainties, for ease of comparison with other industry handheld analyzers.

Transmission uncertainty (S21, S12)

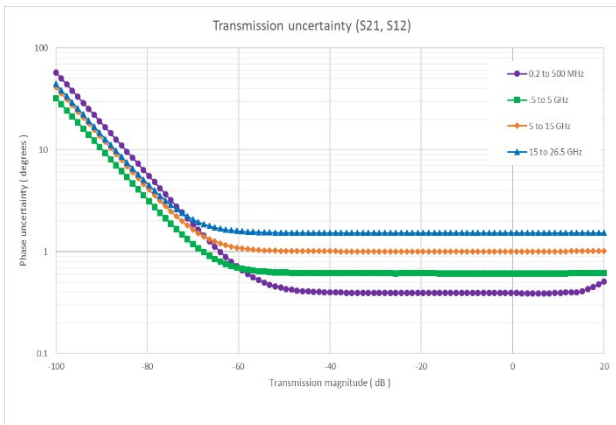
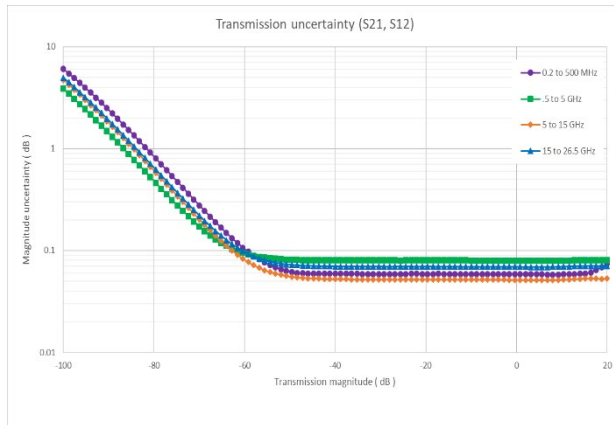

Reflection uncertainty (S11, S22)

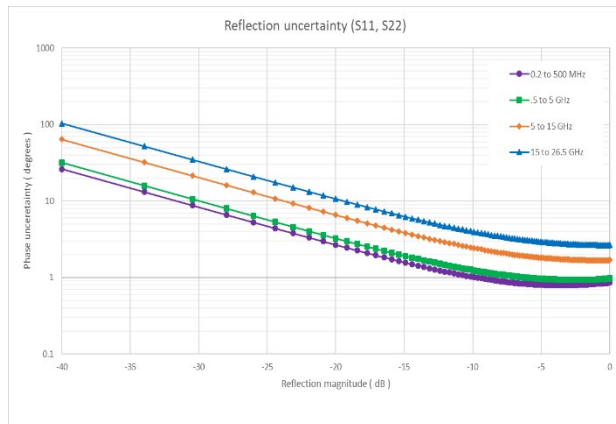
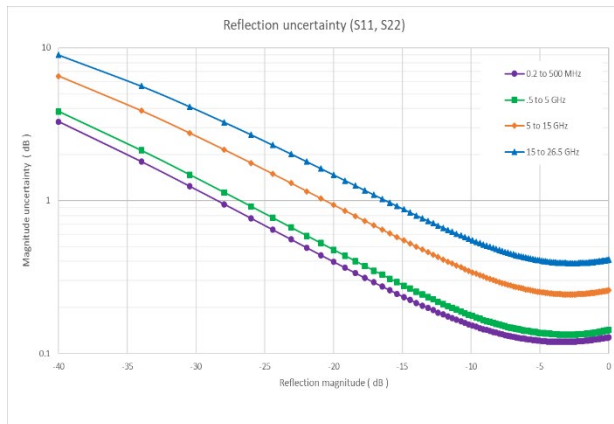

¹ Load match and transmission tracking are typical values

N9913/4/5/6/7/8B, 85052D, full 2-port Cal, DUT: 3.5 mm, spec

Corrected performance table calculated using uncertainties with a coverage factor of 2.

Corrected performance (dB)	0.2 MHz to 3 GHz	3 to 8 GHz	8 to 20 GHz	20 to 26.5 GHz
Directivity	41	35	33	31
Source match	40	34	31	30
Load match ¹	40	33	30	29
Reflection tracking	±0.0019	±0.0085	±0.021	±0.019
Transmission tracking ¹	±0.053	±0.12	±0.20	±0.20

Uncertainty plots: power level of -15 dBm, 10 Hz IF bandwidth, no averaging, battery saver off, and 60-minutes warm-up time. Includes uncertainties due to drift, noise, compression, and dynamic accuracy. Coverage factor of 1 applied to uncertainties, for ease of comparison with other industry handheld analyzers.

Transmission uncertainty (S21, S12)

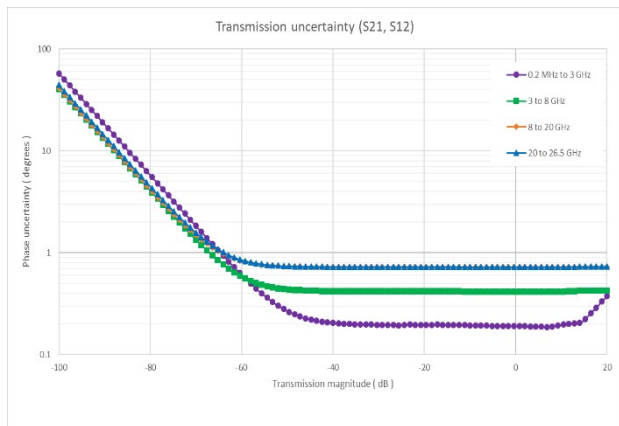
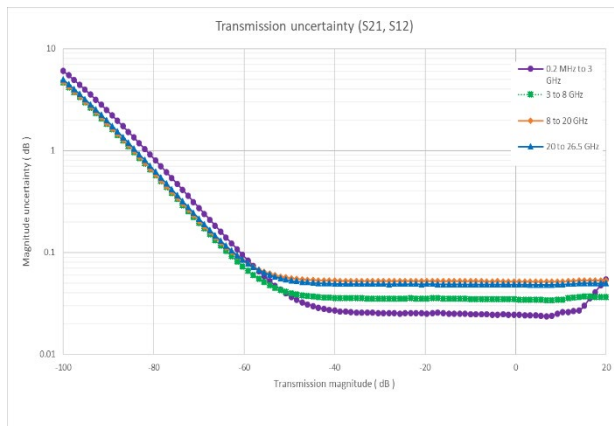

Reflection uncertainty (S11, S22)

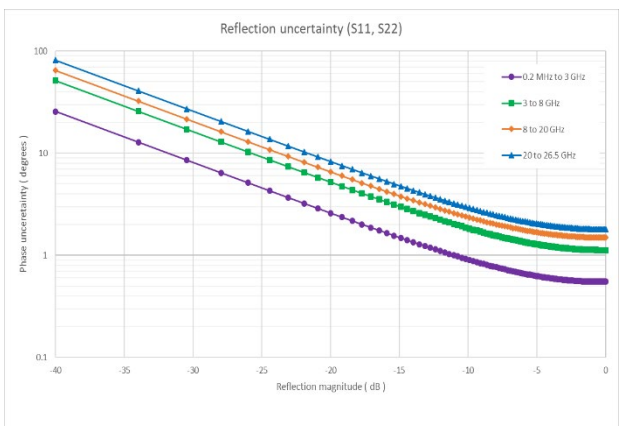
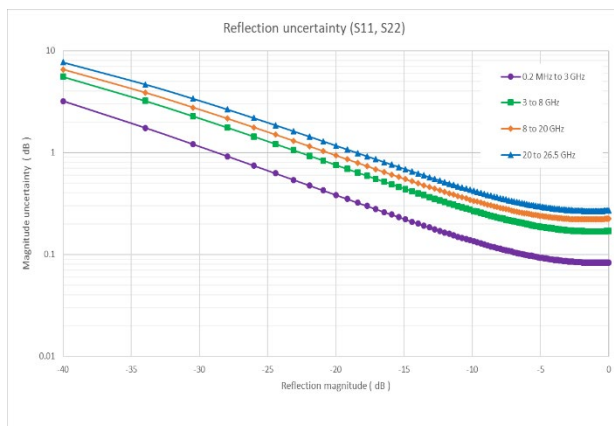

¹ Load match and transmission tracking are typical values

N9913/4/5/6/7/8B, N7554A ECal, full 2-port Cal, DUT: Type-N, spec

Corrected performance table calculated using uncertainties with a coverage factor of 2.

Corrected performance (dB) ¹	0.2 MHz to 0.5 GHz	0.5 to 4 GHz	4 to 9 GHz	9 to 18 GHz
Directivity	42	36	36	36
Source match	37	30	30	28
Load match ²	37	30	30	28
Reflection tracking	±0.13	±0.13	±0.18	±0.25
Transmission tracking ²	±0.13	±0.13	±0.18	±0.25

Uncertainty plots: power level of -15 dBm, 10 Hz IF bandwidth, no averaging, battery saver off, and 60-minutes warm-up time. Includes uncertainties due to drift, noise, compression, and dynamic accuracy. Coverage factor of 1 applied to uncertainties, for ease of comparison with other industry handheld analyzers.

Transmission uncertainty (S21, S12)

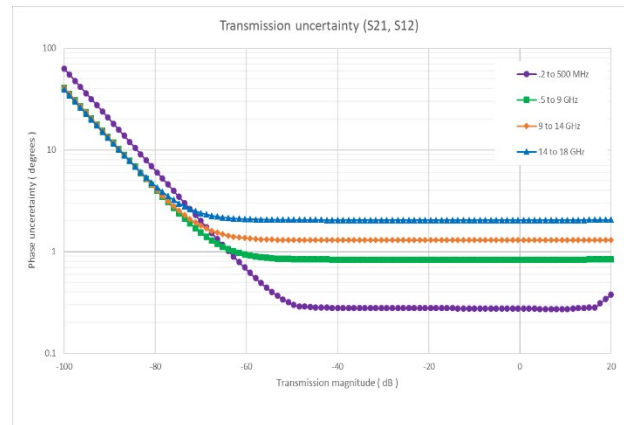
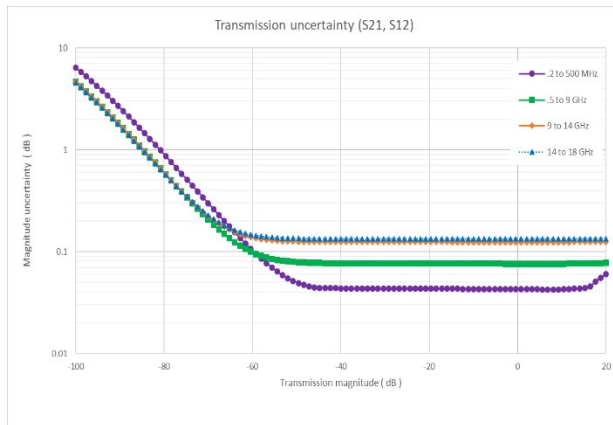

Reflection uncertainty (S11, S22)

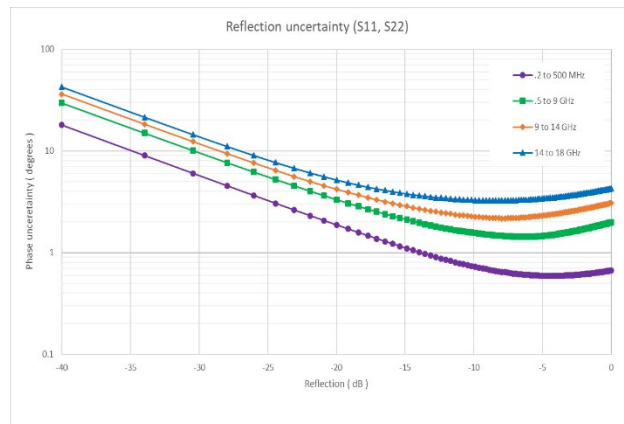
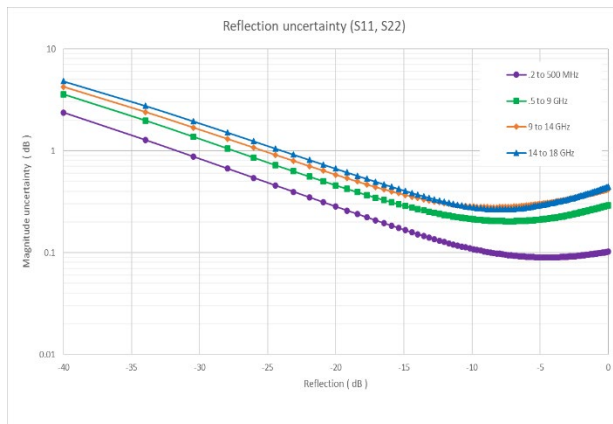

1 When applied power exceeds -10 dBm, calibration results will be degraded from the performance indicated in this table.
 2 Load match and transmission tracking are typical values

N9913/4/5/6/7/8B, N7555A ECal, Full 2-port Cal, DUT: 3.5 mm, spec

Corrected performance table calculated using uncertainties with a coverage factor of 2.

Corrected performance (dB) ¹	0.2 MHz to 0.5 GHz	0.5 to 4 GHz	4 to 9 GHz	9 to 18 GHz	18 to 26.5 GHz
Directivity	42	36	36	36	36
Source match	37	30	30	28	27
Load match ²	37	30	30	28	27
Reflection tracking	±0.13	±0.13	±0.18	±0.25	±0.30
Transmission tracking ²	±0.13	±0.13	±0.18	±0.25	±0.30

Uncertainty plots: power level of -15 dBm, 10 Hz IF bandwidth, no averaging, battery saver off, and 60-minutes warm-up time. Includes uncertainties due to drift, noise, compression, and dynamic accuracy. Coverage factor of 1 applied to uncertainties, for ease of comparison with other industry handheld analyzers.

Transmission uncertainty (S21, S12)

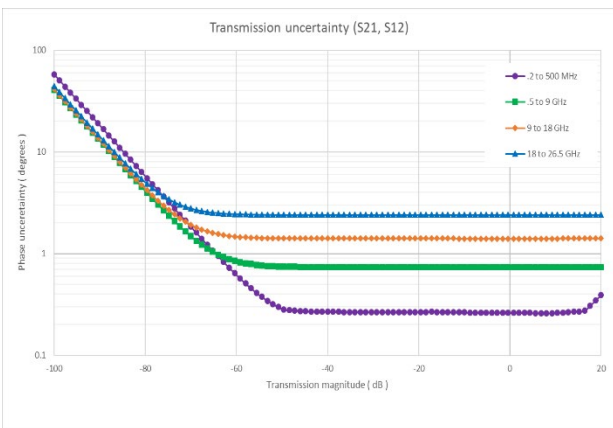
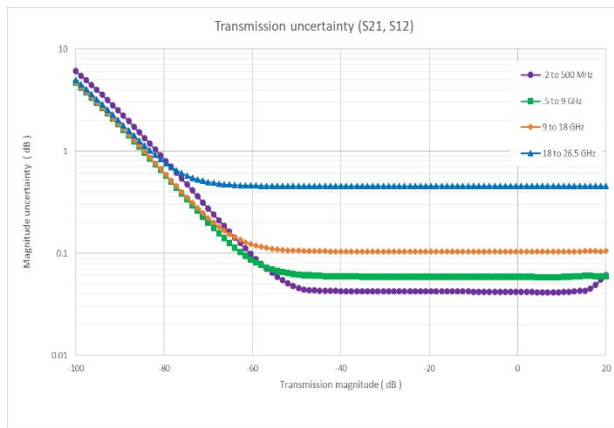

Reflection uncertainty (S11, S22)

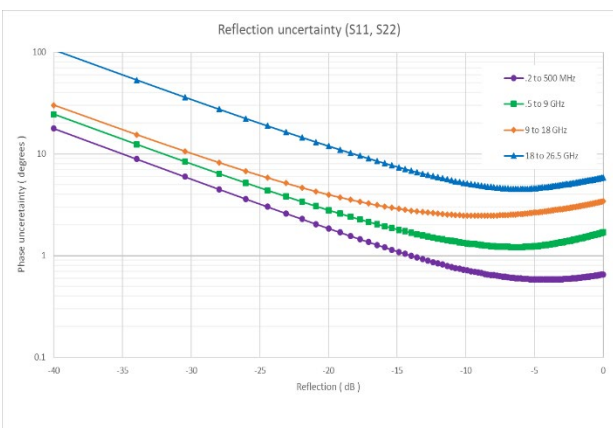
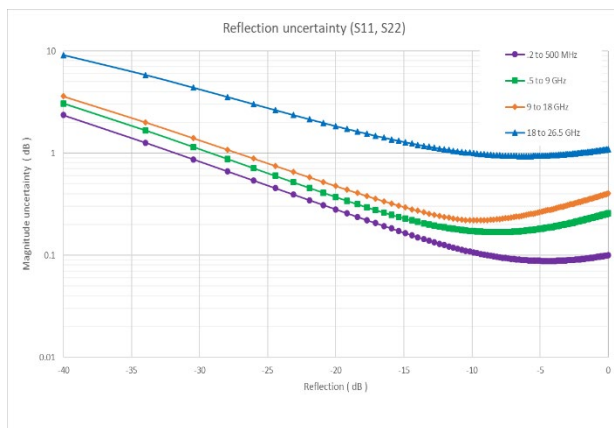

1 When applied power exceeds -10 dBm, calibration results will be degraded from the performance indicated in this table.
 2 Load match and transmission tracking are typical values

N9913/4/5/6/7/8B, N4690D ECal, full 2-port Cal, DUT: Type-N, spec

Corrected performance table calculated using uncertainties with a coverage factor of 2.

Corrected performance (dB) ¹	0.2 to 10 MHz ²	0.3 to 2 MHz ³	2 to 10 MHz ³	10 to 500 MHz	0.5 to 2 GHz	2 to 10 GHz	10 to 18 GHz
Directivity	45	30	40	45	45	40	38
Source match	40	28	35	40	43	40	35
Load match ⁴	40	28	35	40	43	40	35
Reflection tracking	±0.05	±0.12	±0.07	±0.05	±0.03	±0.03	±0.05
Transmission tracking ⁴	±0.05	±0.12	±0.07	±0.05	±0.03	±0.03	±0.05

Uncertainty plots ⁵: power level of -15 dBm, 10 Hz IF bandwidth, no averaging, battery saver off, and 60-minutes warm-up time. Includes uncertainties due to drift, noise, compression, and dynamic accuracy. Coverage factor of 1 applied to uncertainties, for ease of comparison with other industry handheld analyzers.

Transmission uncertainty (S21, S12)

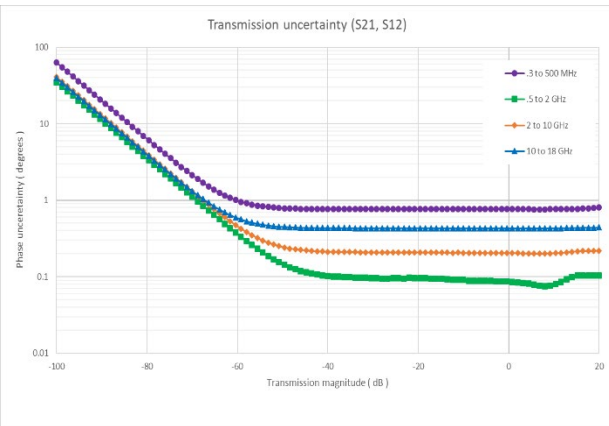
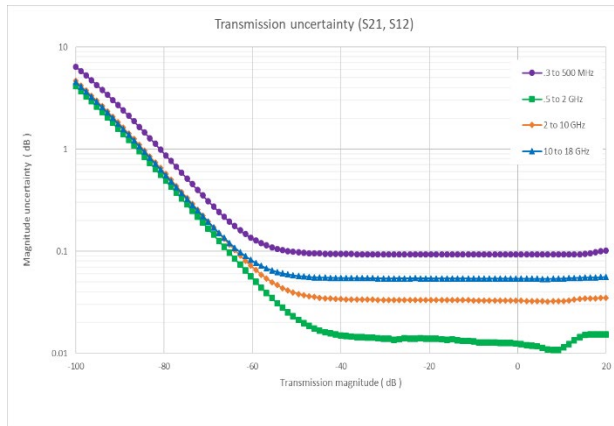

Reflection uncertainty (S11, S22)

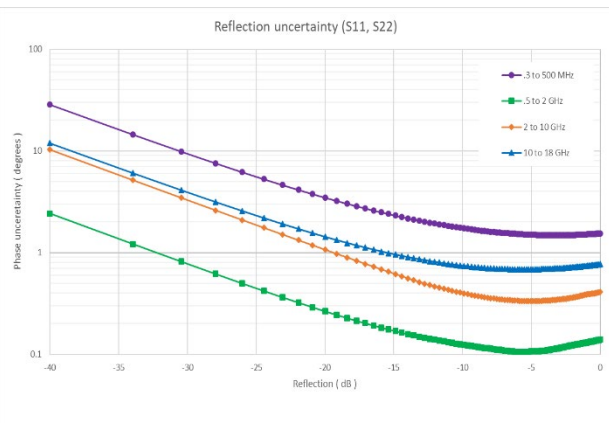
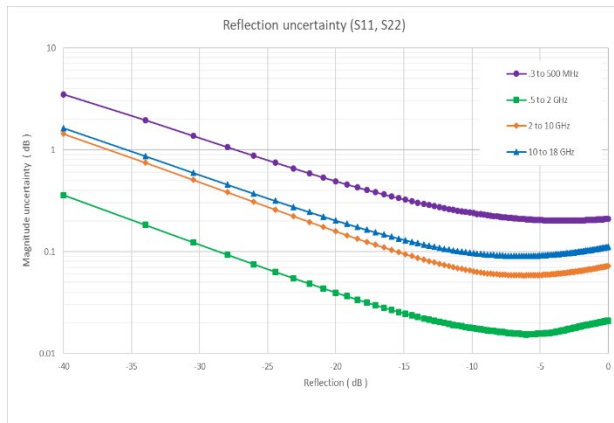

1 When applied power exceeds -10 dBm, calibration results will be degraded from the performance indicated in this table.

2 For N4690D ECal Option 0DC

3 For N4690D ECal Option 003

4 Load match and transmission tracking are typical values

5 Uncertainty plots generated with data from N4691B ECal modules

N9913/4/5/6/7/8B, N4691D ECal, full 2-port Cal, DUT: 3.5 mm, spec

Corrected performance table calculated using uncertainties with a coverage factor of 2.

Corrected performance (dB) ¹	0.2 to 10 MHz ²	300 kHz to 2 MHz ³	2 to 10 MHz ³	10 to 500 MHz	0.5 to 2 GHz	2 to 10 GHz	10 to 20 GHz	20 to 26.5 GHz
Directivity	46	31	41	46	47	46	43	41
Source match	41	29	36	41	47	45	42	40
Load match ⁴	41	29	36	41	47	45	42	40
Reflection tracking	±0.05	±0.11	±0.06	±0.05	±0.02	±0.03	±0.04	±0.05
Transmission tracking ⁴	±0.05	±0.11	±0.06	±0.05	±0.02	±0.03	±0.04	±0.05

Uncertainty plots ⁵: power level of -15 dBm, 10 Hz IF bandwidth, no averaging, battery saver off, and 60-minutes warm-up time. Includes uncertainties due to drift, noise, compression, and dynamic accuracy. Coverage factor of 1 applied to uncertainties, for ease of comparison with other industry handheld analyzers.

Transmission uncertainty (S21, S12)

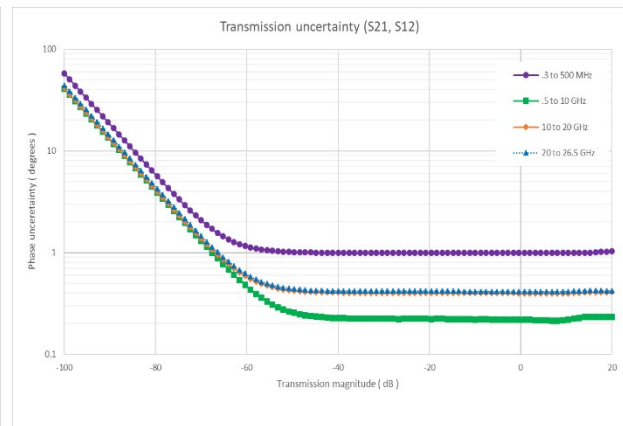
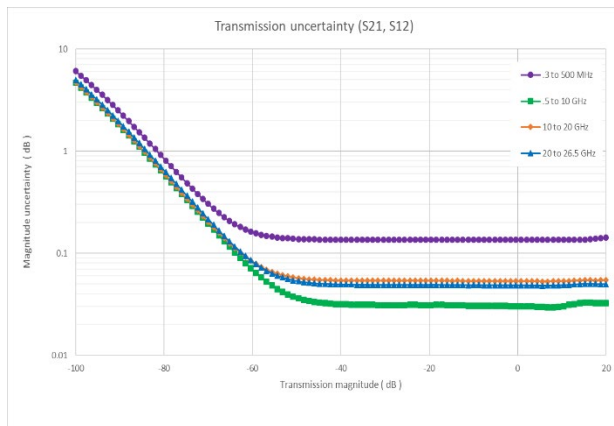

Reflection uncertainty (S11, S22)

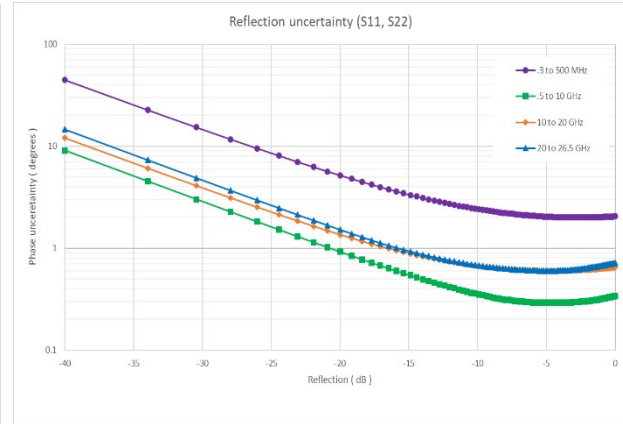
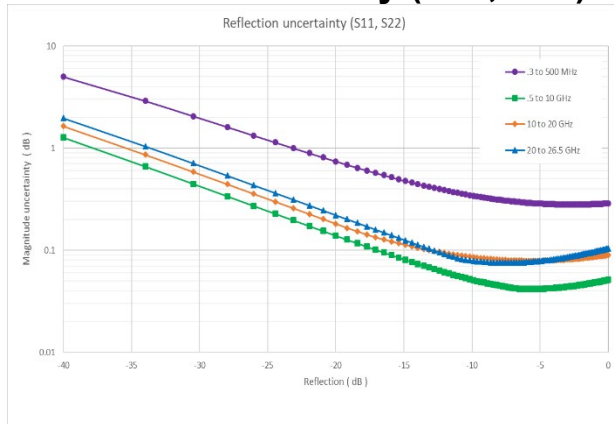

- 1 When applied power exceeds -10 dBm, calibration results will be degraded from the performance indicated in this table.
- 2 For N4691D ECal Option ODC
- 3 For N4691D ECal Option 003
- 4 Load match and transmission tracking are typical values
- 5 Uncertainty plots generated with data from N4691B ECal modules

N9950/1/2B, 85056D, 85563A, or 85564A, full 2-port Cal, DUT: 2.4 mm, spec

Corrected performance table calculated using uncertainties with a coverage factor of 2.

Corrected performance (dB)	0.3 MHz to 4 GHz	4 to 20 GHz	20 to 26.5 GHz	26.5 to 50 GHz
Directivity	42	34	26	26
Source match	40	30	24	23
Load match ¹	38	29	26	22
Reflection tracking	±0.029	±0.029	±0.080	±0.075
Transmission tracking ¹	±0.033	±0.086	±0.084	±0.153

Uncertainty plots: power level of -15 dBm, 10 Hz IF bandwidth, no averaging, battery saver off, and 60-minutes warm-up time. Includes uncertainties due to drift, noise, compression, and dynamic accuracy. Coverage factor of 1 applied to uncertainties, for ease of comparison with other industry handheld analyzers.

Transmission uncertainty (S21, S12)

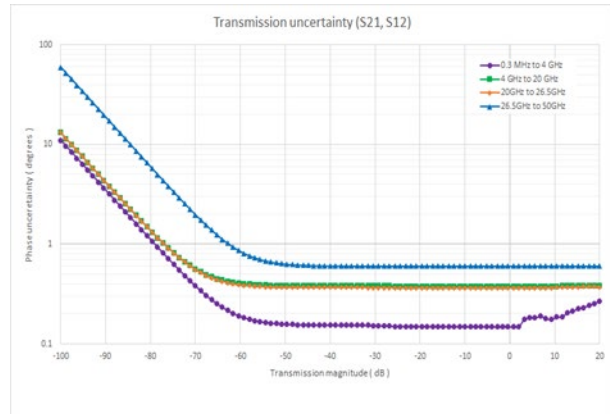
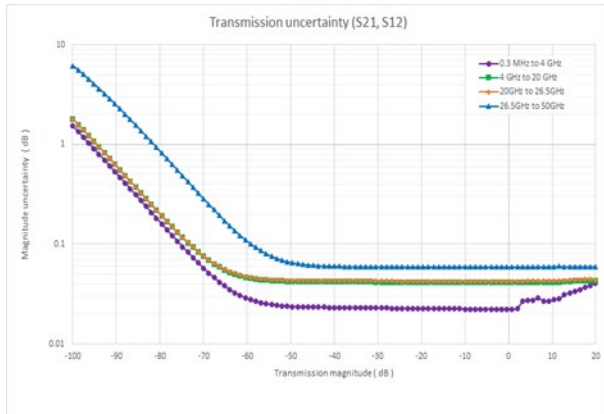

Reflection uncertainty (S11, S22)

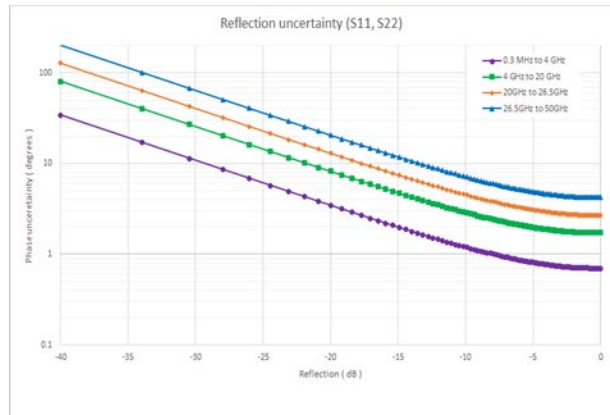
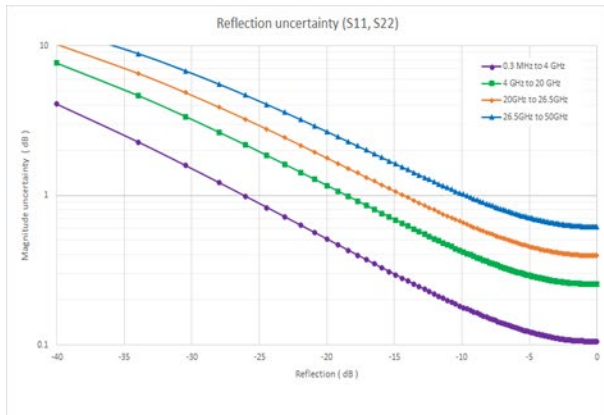

¹ Load match and transmission tracking are typical values

N9950/1/2B, 85561A, full 2-port Cal, DUT: 2.92 mm, spec

Corrected performance table calculated using uncertainties with a coverage factor of 2.

Corrected performance (dB)	0.3 MHz to 4 GHz	4 to 20 GHz	20 to 26.5 GHz	26.5 to 40 GHz
Directivity	36	26	24	20
Source match	31	25	23	19
Load match ¹	32	24	22	19
Reflection tracking	±0.001	±0.041	±0.049	±0.11
Transmission tracking ¹	±0.16	±0.30	±0.43	±0.52

Uncertainty plots: power level of -15 dBm, 10 Hz IF bandwidth, no averaging, battery saver off, and 60-minutes warm-up time. Includes uncertainties due to drift, noise, compression, and dynamic accuracy. Coverage factor of 1 applied to uncertainties, for ease of comparison with other industry handheld analyzers.

Transmission uncertainty (S21, S12)

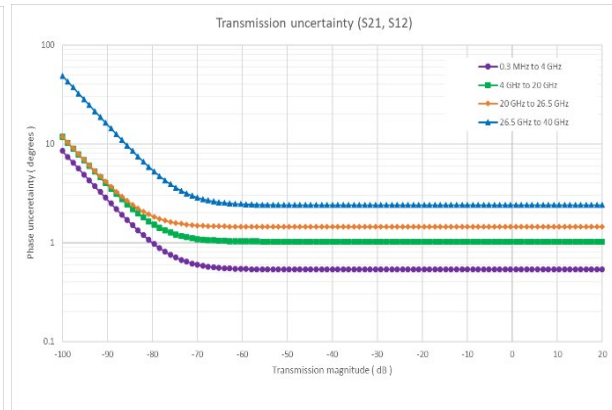
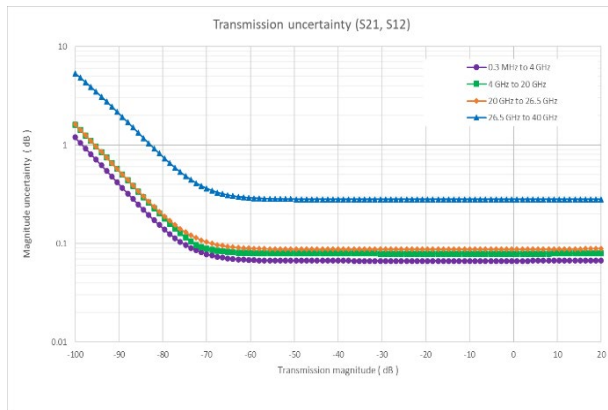

Reflection uncertainty (S11, S22)

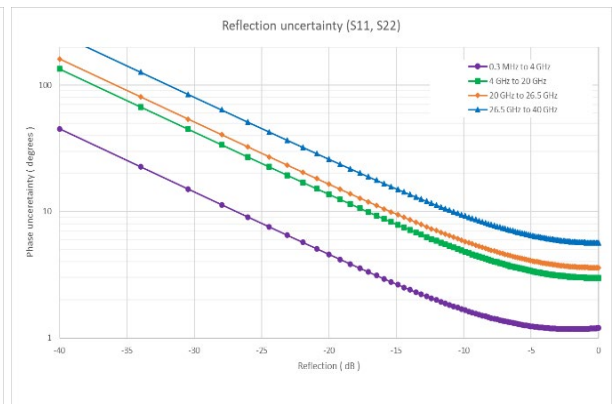
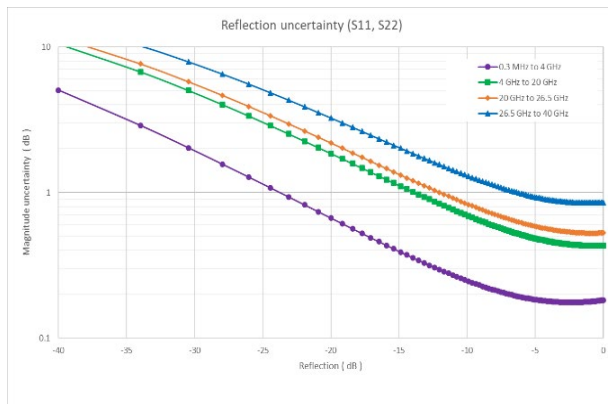

¹ Load match and transmission tracking are typical values

N9950/1/2B, 85562A, full 2-port Cal, DUT: 2.92 mm, spec

Corrected performance table calculated using uncertainties with a coverage factor of 2.

Corrected performance (dB)	0.3 MHz to 4 GHz	4 to 20 GHz	20 to 26.5 GHz	26.5 to 40 GHz
Directivity	36	28	28	25
Source match	34	27	25	23
Load match ¹	32	26	23	22
Reflection tracking	±0.006	±0.026	±0.062	±0.13
Transmission tracking ¹	±0.16	±0.24	±0.42	±0.48

Uncertainty plots: power level of -15 dBm, 10 Hz IF bandwidth, no averaging, battery saver off, and 60-minutes warm-up time. Includes uncertainties due to drift, noise, compression, and dynamic accuracy. Coverage factor of 1 applied to uncertainties, for ease of comparison with other industry handheld analyzers.

Transmission uncertainty (S21, S12)

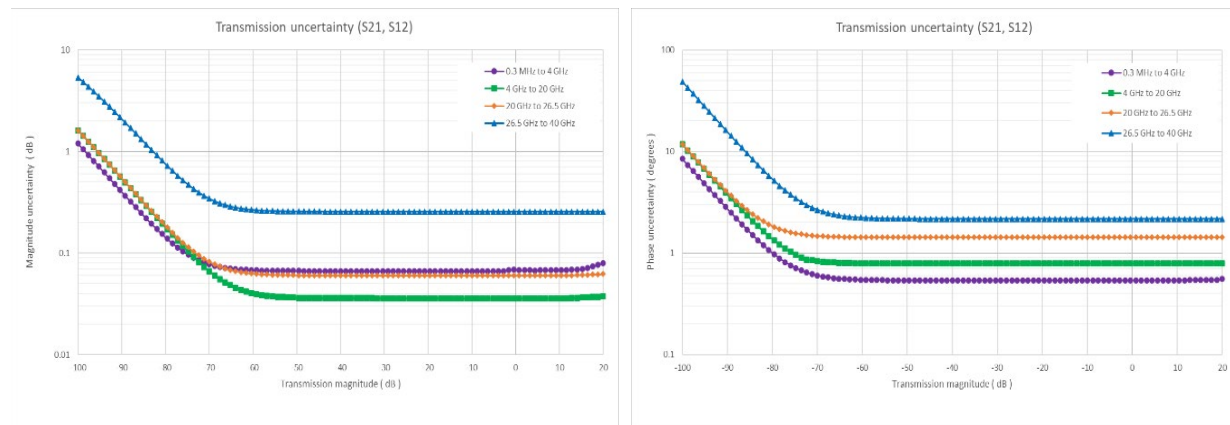

Reflection uncertainty (S11, S22)

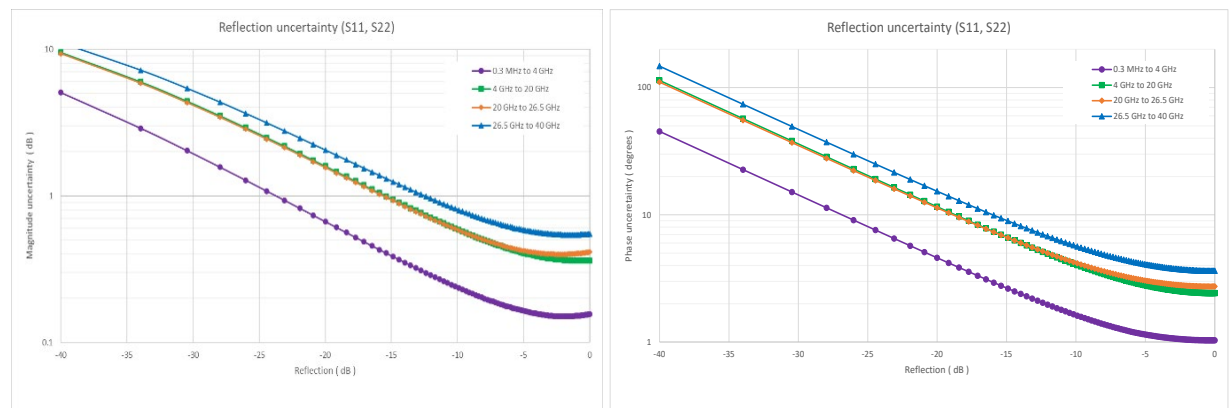

¹ Load match and transmission tracking are typical values

N9950/1/2B, BN 534913, full 2-port Cal, DUT: 2.92 mm, spec

Corrected performance table calculated using uncertainties with a coverage factor of 2.

Corrected performance (dB)	0.3 MHz to 4 GHz	4 to 20 GHz	20 to 26.5 GHz	26.5 to 44 GHz
Directivity	34	30	25	19
Source match	34	26	23	18
Load match ¹	31	26	22	17
Reflection tracking	±0.006	±0.026	±0.086	±0.25
Transmission tracking ¹	±0.22	±0.33	±0.41	±0.54

Uncertainty plots: power level of -15 dBm, 10 Hz IF bandwidth, no averaging, battery saver off, and 60-minutes warm-up time. Includes uncertainties due to drift, noise, compression, and dynamic accuracy. Coverage factor of 1 applied to uncertainties, for ease of comparison with other industry handheld analyzers.

Transmission uncertainty (S21, S12)

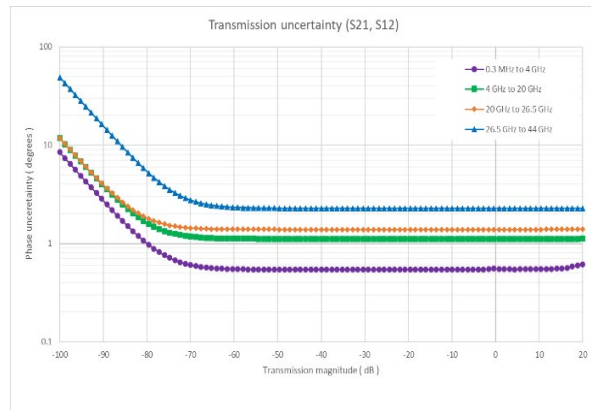
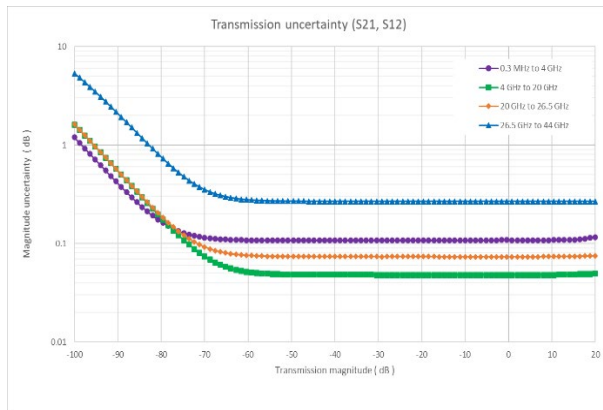

Reflection uncertainty (S11, S22)

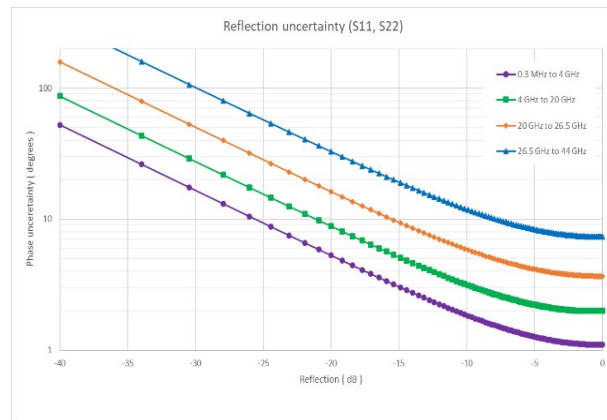
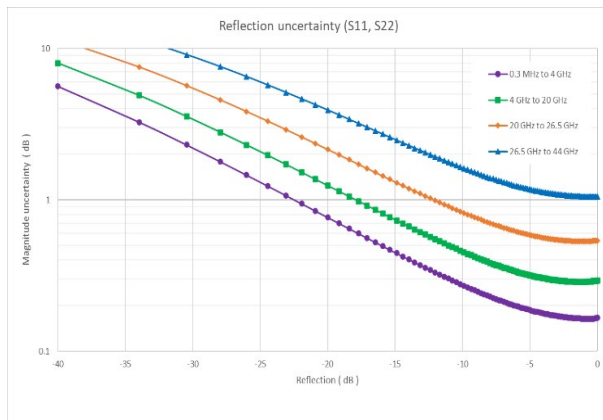

¹ Load match and transmission tracking are typical values

N9950/1/2B, BN 534914, full 2-port Cal, DUT: 2.92 mm, spec

Corrected performance table calculated using uncertainties with a coverage factor of 2.

Corrected performance (dB)	0.3 MHz to 4 GHz	4 to 20 GHz	20 to 26.5 GHz	26.5 to 44 GHz
Directivity	30	29	25	18
Source match	29	28	23	18
Load match ¹	29	25	22	18
Reflection tracking	±0.005	±0.042	±0.072	±0.24
Transmission tracking ¹	±0.18	±0.37	±0.43	±0.47

Uncertainty plots: power level of -15 dBm, 10 Hz IF bandwidth, no averaging, battery saver off, and 60-minutes warm-up time. Includes uncertainties due to drift, noise, compression, and dynamic accuracy. Coverage factor of 1 applied to uncertainties, for ease of comparison with other industry handheld analyzers.

Transmission uncertainty (S21, S12)

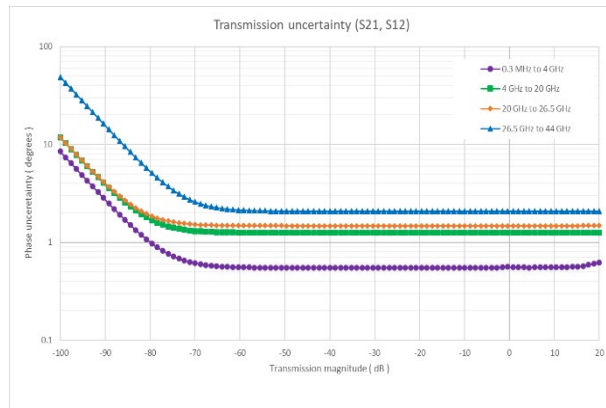
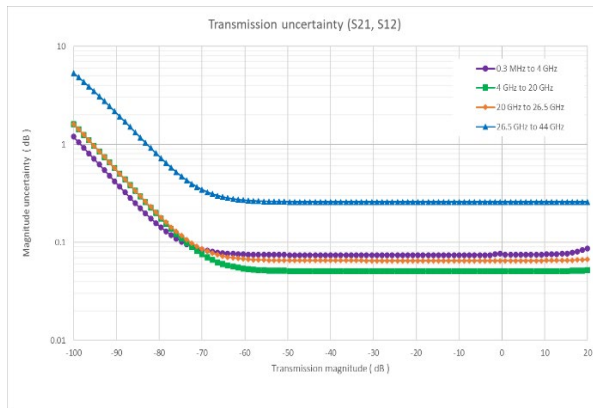

Reflection uncertainty (S11, S22)

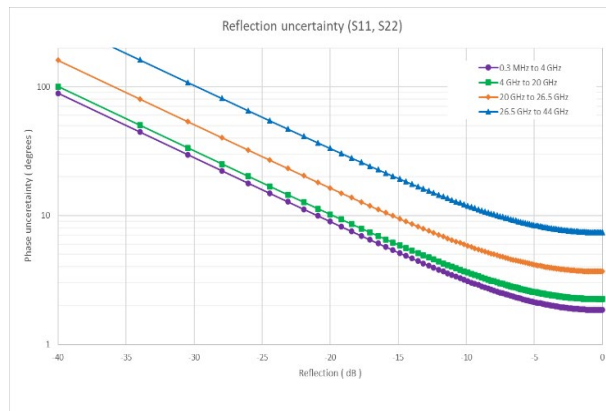
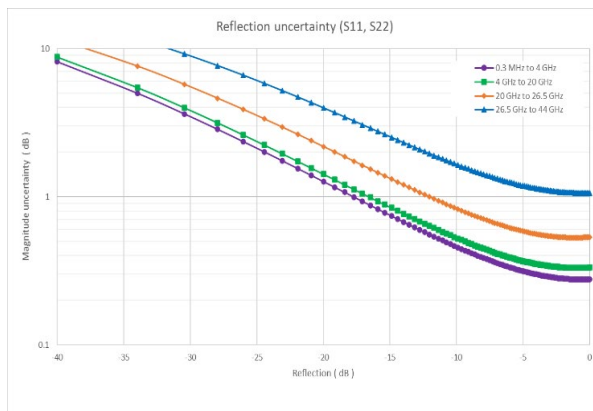

¹ Load match and transmission tracking are typical values

N9950/1/2B, N4692D ECal Option 0DC, full 2-port Cal, DUT: 2.92 mm, spec

Corrected performance table calculated using uncertainties with a coverage factor of 2.

Corrected performance (dB) ¹	0.3 MHz to 4 GHz	4 to 20 GHz	20 to 26.5 GHz	26.5 to 40 GHz
Directivity	40	38	35	32
Source match	38	35	30	29
Load match ²	30	27	27	26
Reflection tracking	±0.1	±0.1	±0.10	±0.12
Transmission tracking ²	±0.2	±0.25	±0.25	±0.29

Uncertainty plots: power level of -15 dBm, 10 Hz IF bandwidth, no averaging, battery saver off, and 60-minutes warm-up time. Includes uncertainties due to drift, noise, compression, and dynamic accuracy. Coverage factor of 1 applied to uncertainties, for ease of comparison with other industry handheld analyzers.

Transmission uncertainty (S₂₁, S₁₂) – N4692D ECal Option 0DC

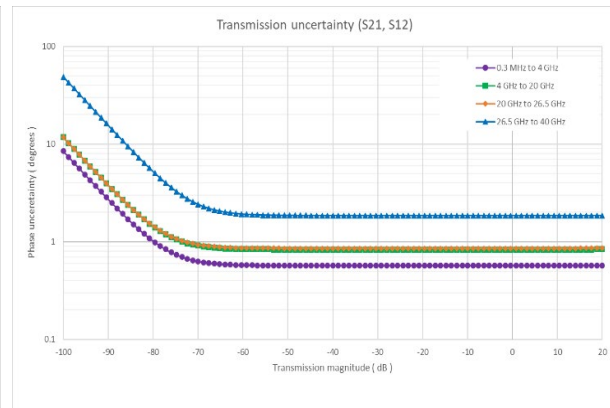
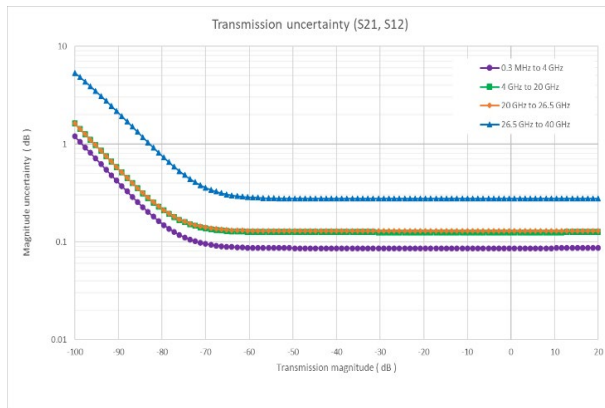

Reflection uncertainty (S₁₁, S₂₂) – N4692D ECal Option 0DC

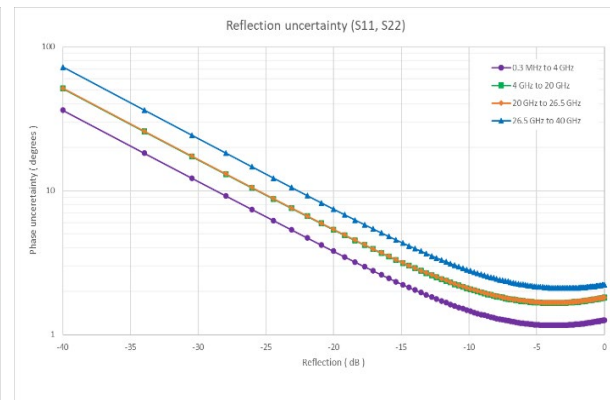
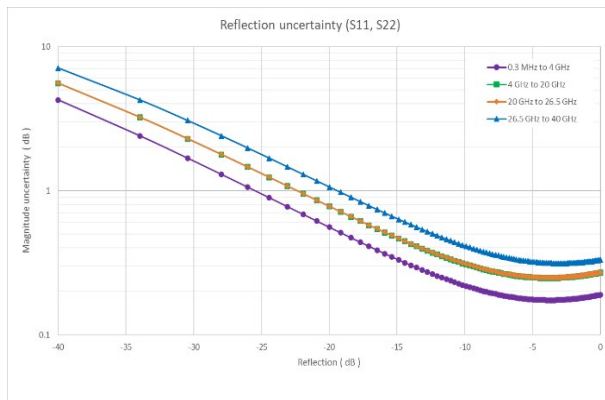

1 When applied power exceeds -10 dBm, calibration results will be degraded from the performance indicated in this table
 2 Load match and transmission tracking are typical values

N9950/1/2B, N4692D ECal Option 010, full 2-port Cal, DUT: 2.92 mm, spec

Corrected performance table calculated using uncertainties with a coverage factor of 2.

Corrected performance (dB) ¹	10 MHz to 4 GHz	4 to 20 GHz	20 to 26.5 GHz	26.5 to 40 GHz
Directivity	29	38	35	32
Source match	29	35	30	29
Load match ²	24	27	27	26
Reflection tracking	±0.18	±0.1	±0.10	±0.12
Transmission tracking ²	±0.34	±0.25	±0.25	±0.29

Uncertainty plots: power level of -15 dBm, 10 Hz IF bandwidth, no averaging, battery saver off, and 60-minutes warm-up time. Includes uncertainties due to drift, noise, compression, and dynamic accuracy. Coverage factor of 1 applied to uncertainties, for ease of comparison with other industry handheld analyzers.

Transmission uncertainty (S₂₁, S₁₂) – N4692D ECal Option 010

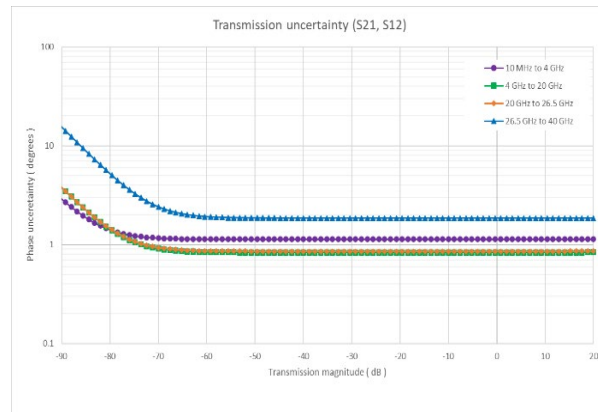
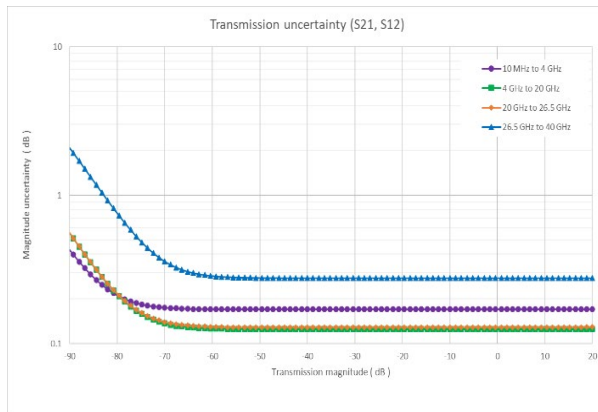

Reflection uncertainty (S₁₁, S₂₂) – N4692D ECal Option 010

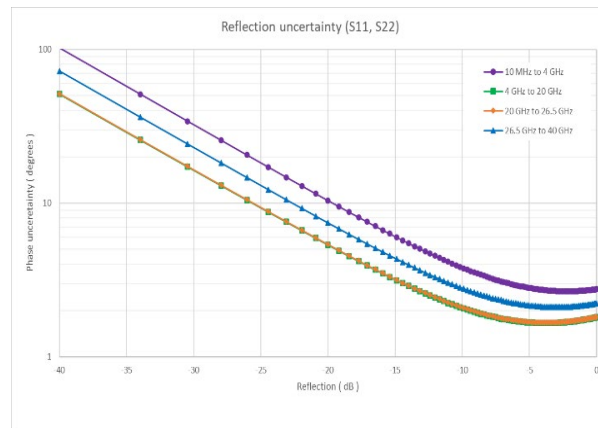
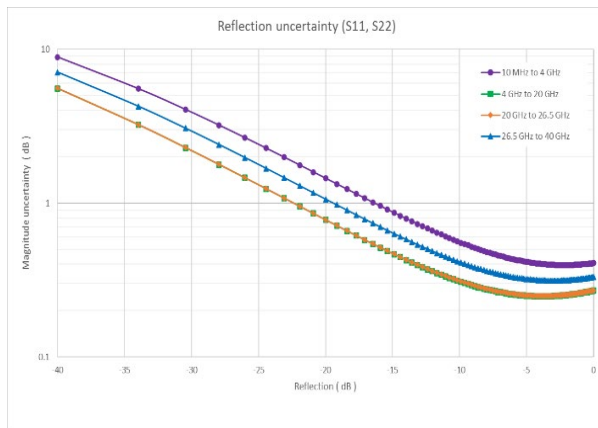

¹ When applied power exceeds -10 dBm, calibration results will be degraded from the performance indicated in this table
² Load match and transmission tracking are typical values

N9950/1/2B, N4693D ECal Option 0DC, full 2-port Cal, DUT: 2.4 mm, spec

Corrected performance table calculated using uncertainties with a coverage factor of 2.

Corrected performance (dB) ¹	0.3 MHz to 4 GHz	4 to 20 GHz	20 to 26.5 GHz	26.5 to 50 GHz
Directivity	40	44	38	34
Source match	38	37	35	32
Load match ²	34	32	32	29
Reflection tracking	±0.05	±0.05	±0.06	±0.08
Transmission tracking ²	±0.077	±0.102	±0.102	±0.162

Uncertainty plots: power level of -15 dBm, 10 Hz IF bandwidth, no averaging, battery saver off, and 60-minutes warm-up time. Includes uncertainties due to drift, noise, compression, and dynamic accuracy. Coverage factor of 1 applied to uncertainties, for ease of comparison with other industry handheld analyzers.

Transmission uncertainty (S₂₁, S₁₂) – N4693D ECal Option 0DC

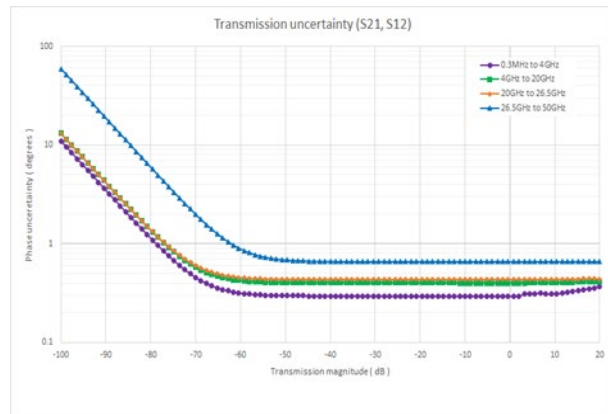
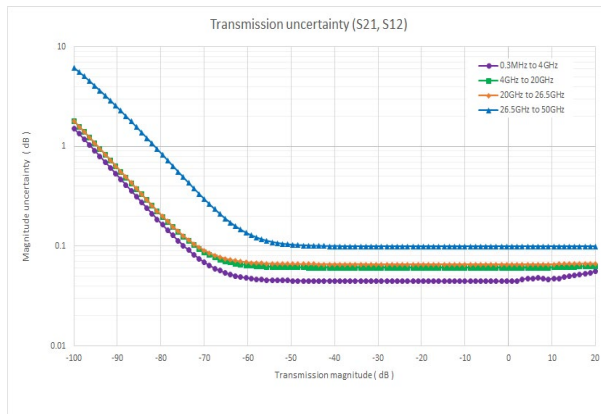

Reflection uncertainty (S₁₁, S₂₂) – N4693D ECal Option 0DC

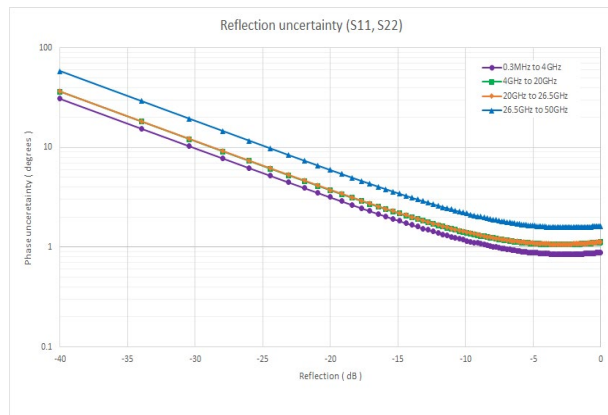
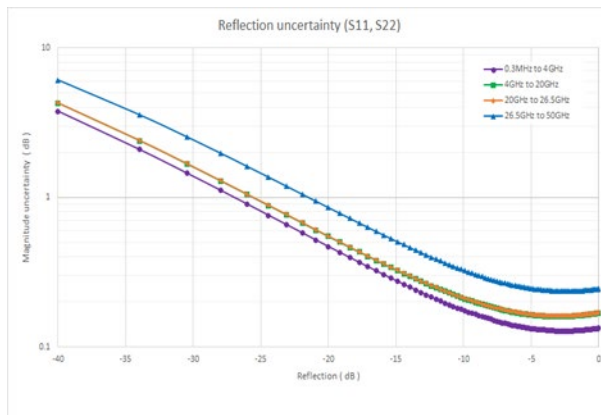

1 When applied power exceeds -10 dBm, calibration results will be degraded from the performance indicated in this table
 2 Load match and transmission tracking are typical values

N9950/1/2B, N4693D ECal Option 010, full 2-port Cal, DUT: 2.4 mm, spec

Corrected performance table calculated using uncertainties with a coverage factor of 2.

Corrected performance (dB) ¹	10 MHz to 4 GHz	4 to 20 GHz	20 to 26.5 GHz	26.5 to 50 GHz
Directivity	27	44	38	34
Source match	25	37	35	32
Load match ²	23	32	32	29
Reflection tracking	±0.05	±0.05	±0.06	±0.08
Transmission tracking ²	±0.307	±0.102	±0.102	±0.162

Uncertainty plots: power level of -15 dBm, 10 Hz IF bandwidth, no averaging, battery saver off, and 60-minutes warm-up time. Includes uncertainties due to drift, noise, compression, and dynamic accuracy. Coverage factor of 1 applied to uncertainties, for ease of comparison with other industry handheld analyzers.

Transmission uncertainty (S21, S12) – N4693D ECal Option 010

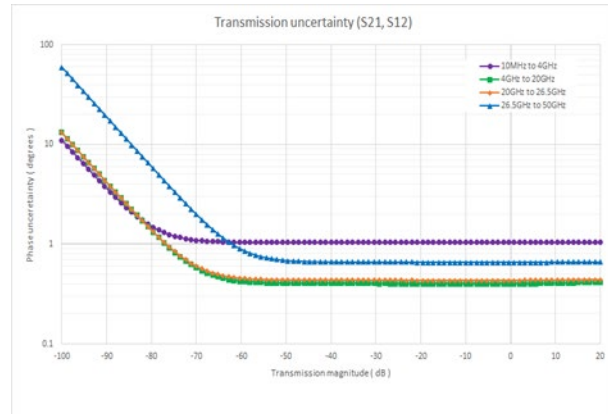
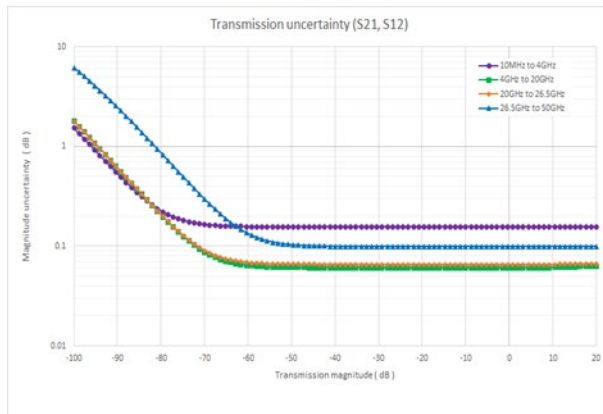

Reflection uncertainty (S11, S22) – N4693D ECal Option 010

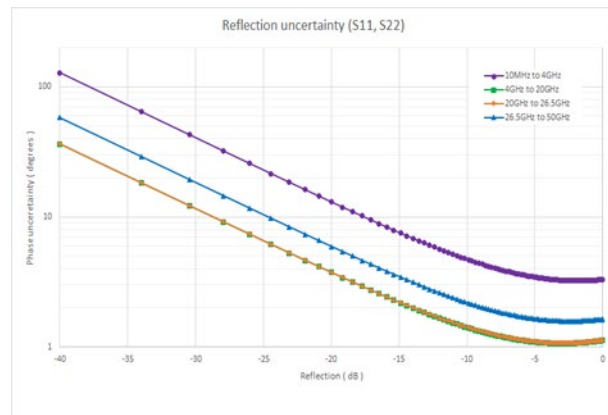
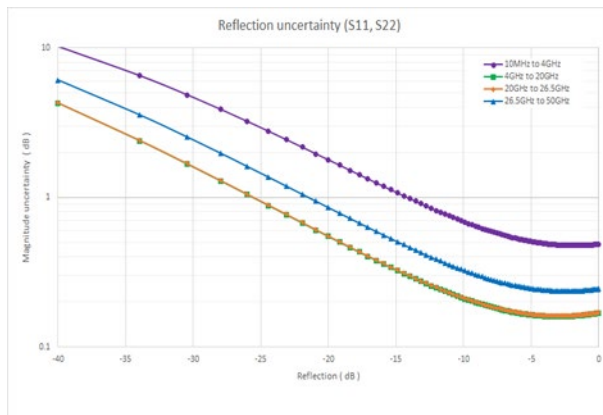

1 When applied power exceeds -10 dBm, calibration results will be degraded from the performance indicated in this table
 2 Load match and transmission tracking are typical values

N9953B, 85058E, full 2-port Cal, DUT: 1.85 mm, spec

Corrected performance table calculated using uncertainties with a coverage factor of 2.

Corrected performance (dB)	0.3 MHz to 4 GHz	4 to 26.5 GHz	26.5 to 50 GHz	50 to 54 GHz
Directivity	30	30	28	28
Source match	28	26	24	24
Load match ¹	30	27	23	23
Reflection tracking	±0.021	±0.028	±0.052	±0.052
Transmission tracking ¹	±0.155	±0.177	±0.291	±0.310

Uncertainty plots: power level of -15 dBm, 10 Hz IF bandwidth, no averaging, battery saver off, and 60-minutes warm-up time. Includes uncertainties due to drift, noise, compression, and dynamic accuracy. Coverage factor of 1 applied to uncertainties, for ease of comparison with other industry handheld analyzers.

Transmission uncertainty (S21, S12)

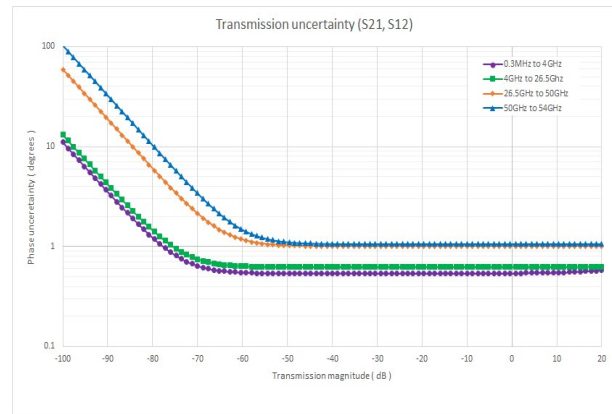
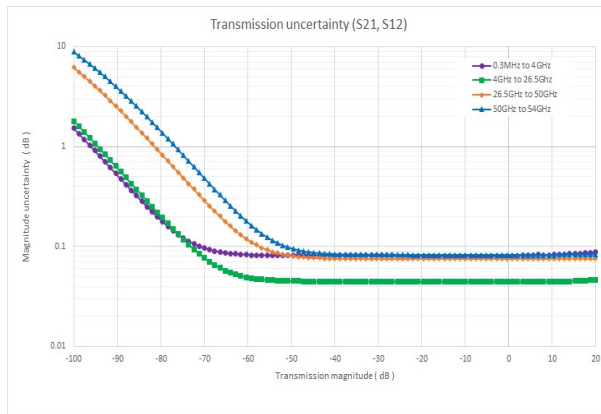

Reflection uncertainty (S11, S22)

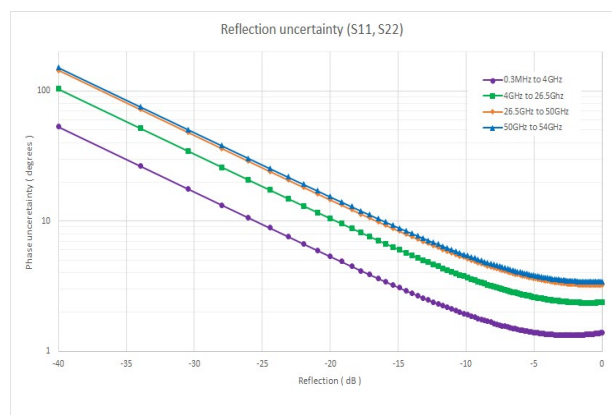
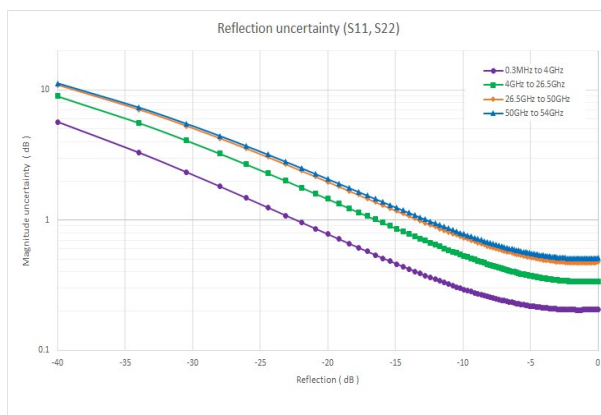

¹ Load match and transmission tracking are typical values

N9953B, N4694D 0DC ECal, full 2-port Cal, DUT: 1.85 mm, spec

Corrected performance table calculated using uncertainties with a coverage factor of 2.

Corrected performance (dB) ¹	0.3 MHz to 4 GHz	4 to 26.5 GHz	26.5 to 50 GHz	50 to 54 GHz
Directivity	27	41	38	35
Source match	23	38	33	26
Load match ²	38	29	26	22
Reflection tracking	±0.080	±0.040	±0.080	±0.120
Transmission tracking ¹	±0.092	±0.094	±0.141	±0.184

Uncertainty plots: power level of -15 dBm, 10 Hz IF bandwidth, no averaging, battery saver off, and 60-minutes warm-up time. Includes uncertainties due to drift, noise, compression, and dynamic accuracy. Coverage factor of 1 applied to uncertainties, for ease of comparison with other industry handheld analyzers.

Transmission uncertainty (S21, S12) – N4694D ECal Option 0DC

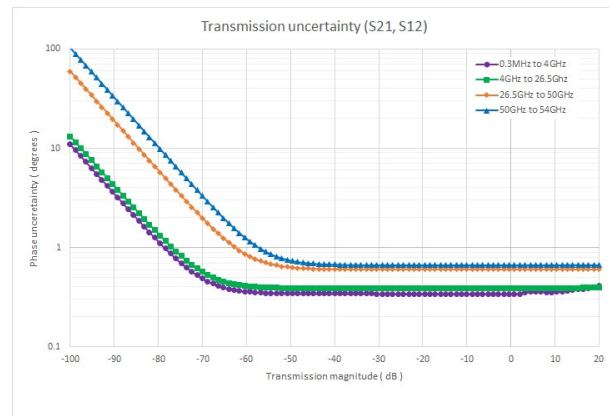
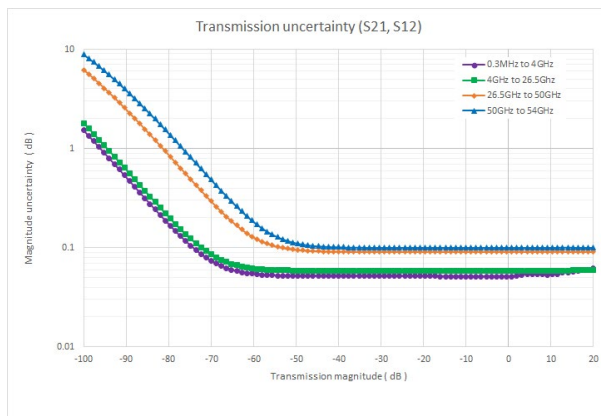

Reflection uncertainty (S11, S22) – N4693D ECal Option 0DC

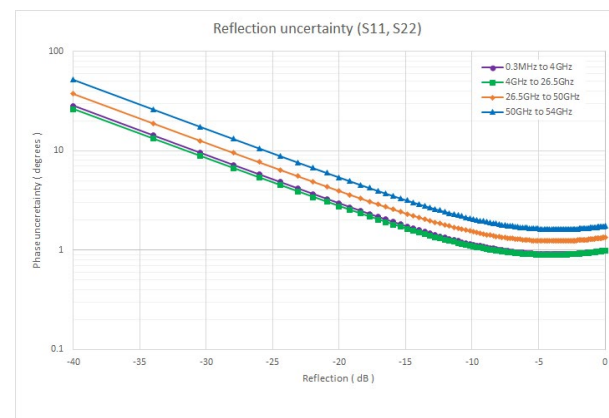
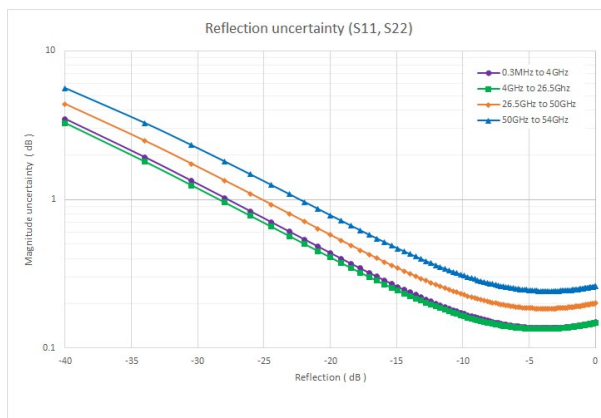

1 When applied power exceeds -10 dBm, calibration results will be degraded from the performance indicated in this table.
 2 Load match and transmission tracking are typical values

N9953B, N4694D 010 ECal, full 2-port Cal, DUT: 1.85 mm, spec

Corrected performance table calculated using uncertainties with a coverage factor of 2.

Corrected performance (dB) ¹	10 MHz to 4 GHz	4 to 26.5 GHz	26.5 to 50 GHz	50 to 54 GHz
Directivity	27	41	38	35
Source match	23	38	33	26
Load match ²	22	33	30	28
Reflection tracking	±0.080	±0.040	±0.080	±0.120
Transmission tracking ²	±0.354	±0.094	±0.141	±0.184

Uncertainty plots: power level of -15 dBm, 10 Hz IF bandwidth, no averaging, battery saver off, and 60-minutes warm-up time. Includes uncertainties due to drift, noise, compression, and dynamic accuracy. Coverage factor of 1 applied to uncertainties, for ease of comparison with other industry handheld analyzers.

Transmission uncertainty (S21, S12) – N4694D ECal Option 010

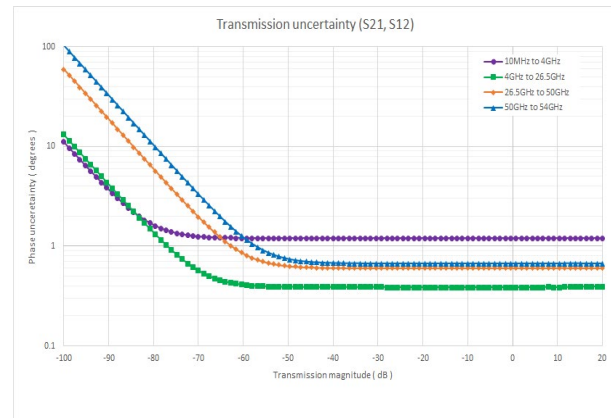
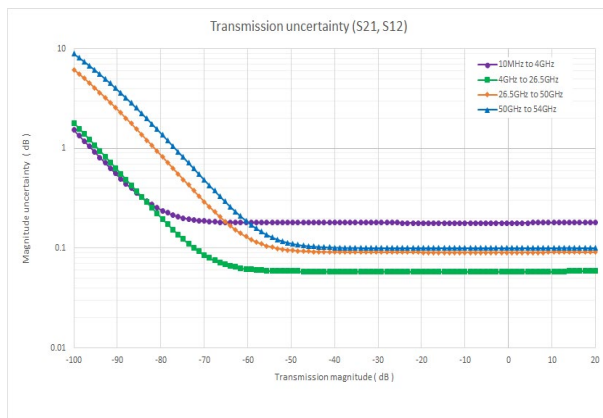

Reflection uncertainty (S11, S22) – N4693D ECal Option 010

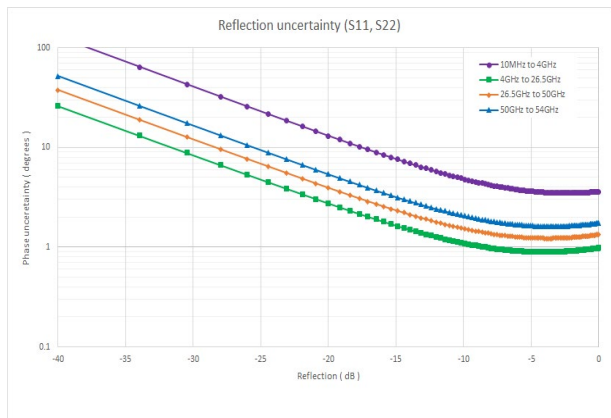
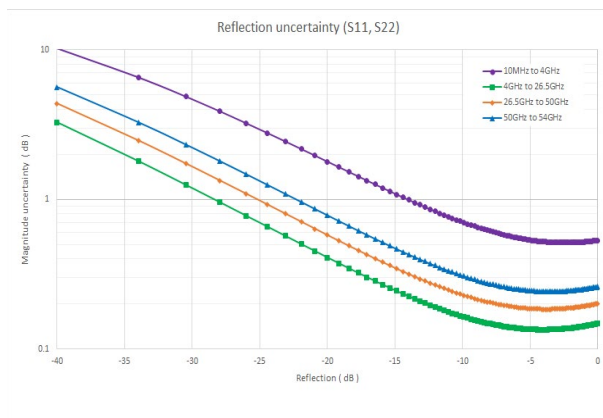

1 When applied power exceeds -10 dBm, calibration results will be degraded from the performance indicated in this table.
 2 Load match and transmission tracking are typical values

TDR Cable Measurements (Option 215)

The performance listed in TDR cable measurements, VNA time domain, mixed-mode S-parameters and vector voltmeter sections apply to the capabilities available in the following models:

Description	Model number
FieldFox RF & microwave (combination) analyzers	N9913B ¹ , N9914B ¹ , N9915B ¹ , N9916B, N9917B, N9918B, N9950B, N9951B, N9952B, N9953B

See [FieldFox Configuration Guide](#) for option information. Many capabilities listed in this Data Sheet require options.

The TDR cable option adds time domain reflectometry (TDR) measurements to FieldFox's CAT mode. FieldFox's TDR measurements are based on an inverse Fourier transform of the frequency-domain data. TDR measurements are useful in not only identifying the location of faults along cables, but also the nature of the fault. Resistive, inductive and capacitive faults will each have a different response. These differences help engineers and technicians' trouble-shoot line faults.

Measurements: TDR (linear rho), TDR (ohm), TDR & DTF

Y-axis: linear (rho) or impedance (ohm)

X-axis: distance (meters or feet)

VNA Time Domain (Option 010)

In time-domain mode, FieldFox computes the inverse Fourier transform of the frequency-domain data to display reflection or transmission coefficients versus time.

Setup parameters

Time	Start, stop, center, span
Gating	Start, stop, center, span, and on/off
Numbers of points, velocity vector, line loss, window shape, independent control for all four traces	

Time stimulus modes

Low-pass step	Low-pass step is similar to a traditional time domain reflectometer (TDR) stimulus waveform. It is used to measure low-pass devices. The frequency-domain data should extend from DC (extrapolated value) to a higher value.
Low-pass impulse	Low-pass impulse response is used to measure low-pass devices.
Bandpass impulse	The bandpass impulse simulates a pulsed RF signal and is used to measure the time domain response of band-limited devices.

¹ Discontinued and replaced by corresponding Keysight N99xxC Series FieldFox.

Windows

The windowing function can be used to filter the frequency domain data and thereby reduce overshoot and ringing in the time domain response.

Windows	Minimum, medium and maximum, manual entry of Kaiser Beta and impulse width.
---------	---

Gating

The gating function can be used to selectively remove reflection or transmission time domain responses. In converting back to the frequency domain, the effects of the responses outside the gate are removed. The results can be viewed with gating on and off, using two traces.

Gate types	Notch, bandpass
Gate shapes	Maximum, wide, normal, minimum

Mixed-Mode S-Parameters (Option 212)

Mixed-mode S-parameters are also known as balanced measurements.

Measurements

Sc _c 11	Common mode reflection
S _d d11	Differential mode reflection
Sc _d 11	Differential mode stimulus, common mode response
S _d c11	Common mode stimulus, differential mode response

FieldFox's mixed-mode S-parameter measurements require the use of the default factory calibration or a user 2-port calibration. So, the FieldFox analyzer must be equipped with 2-port measurement functionality to measure mixed-mode S-parameters. Mixed-mode S-parameters are an extension of the VNA capabilities.

Vector Voltmeter (VVM) (Option 308)

With vector voltmeter mode, you can characterize the difference between two measurements easily. The zeroing function allows you to create a reference signal and characterize the difference between two device measurements. The results are shown on a large display in digital format.

Series	Models	Frequency range
N991xB	N9913B ¹	30 kHz to 4 GHz
	N9914B ¹	30 kHz to 6.5 GHz
	N9915B ¹	30 kHz to 9 GHz
	N9916B	30 kHz to 14 GHz
	N9917B	30 kHz to 18 GHz
	N9918B	30 kHz to 26.5 GHz
N995xB	N9950B	300 kHz to 32 GHz
	N9951B	300 kHz to 44 GHz
	N9952B	300 kHz to 50 GHz
	N9953B	300 kHz to 54 GHz

Setup parameters

1-port cable trimming	Reflection (S11 or S22 measurement), magnitude and phase
2-port transmission	Transmission or S21 measurement, magnitude, and phase
A/B and B/A	Ratio of two receivers or channels, magnitude, and phase – Need an external signal generator for the A/B or B/A measurement
	Frequency (one CW frequency point)
	IF bandwidth: 10 Hz to 100 kHz or 3 Hz to 30 kHz
	Output power: Low, high, manual

Ratio accuracy (A/B and B/A)

Must zero before measuring DUT. Recommend using a high-quality power splitter or 6 dB attenuators to minimize uncertainty due to mismatch.

Models	Frequency	Nominal (dB)
N991xB	100 kHz to 2 GHz	±0.2
N995xB	300 kHz to 2 GHz	±0.2

¹ Discontinued and replaced by corresponding Keysight N99xxC Series FieldFox.

Spectrum Analyzer (Option 233 on Combination Analyzers)

The performance listed in this section applies to the spectrum analyzer capabilities available in the following models:

Description	Model number
FieldFox RF & microwave (combination) analyzers:	N9913B ¹ , N9914B ¹ , N9915B ¹ , N9916B, N9917B, N9918B
FieldFox RF & microwave signal analyzers:	N9933B ¹ , N9934B ¹ , N9935B ¹ , N9936B, N9937B, N9938B
FieldFox microwave (combination) analyzers:	N9950B, N9951B, N9952B, N9953B
FieldFox microwave signal analyzers:	N9960B, N9961B, N9962B, N9963B

See [FieldFox Configuration Guide](#) for option information. Many capabilities listed in this Data Sheet require options.

Frequency and time specifications

	Models	Frequency range ²	Supplemental information
N991xB, N993xB	N9913B ¹ , N9933B ¹	9 kHz to 4 GHz	Usable to 5 kHz
	N9914B ¹ , N9934B ¹	9 kHz to 6.5 GHz	Usable to 5 kHz
	N9915B ¹ , N9935B ¹	9 kHz to 9 GHz	Usable to 5 kHz
	N9916B, N9936B	9 kHz to 14 GHz	Usable to 5 kHz
	N9917B, N9937B	9 kHz to 18 GHz	Usable to 5 kHz
	N9918B, N9938B	9 kHz to 26.5 GHz	Usable to 5 kHz
N995xB, N996xB	N9950B, N9960B	9 kHz to 32 GHz	Usable to 5 kHz
	N9951B, N9961B	9 kHz to 44 GHz	Usable to 5 kHz
	N9952B, N9962B	9 kHz to 50 GHz	Usable to 5 kHz
	N9953B, N9963B	9 kHz to 54 GHz	Usable to 5 kHz

Frequency reference, -10 to 55 °C

Accuracy	±0.9 ppm (spec) + aging
	±0.5 ppm (typical) + aging
Accuracy, when locked to GPS	±0.01 ppm (nominal)
Accuracy, when GPS antenna is disconnected	±0.4 ppm (nominal) ³
Aging rate	±1 ppm/yr for 20 years (spec), will not exceed ±3.5 ppm

Frequency readout accuracy (start, stop, center, marker)

± (readout frequency x frequency reference accuracy + RBW centering + 0.5 x horizontal resolution)	Horizontal resolution = frequency span/(trace points – 1) <ul style="list-style-type: none"> • 5% x RBW, FFT mode (nominal) • 16% x RBW, step mode (nominal)
--	--

¹ Discontinued and replaced by corresponding Keysight N99xxC Series FieldFox.

² The spectrum analyzer is tunable to 0 Hz or DC.

³ The maximum drift expected in the frequency reference applicable when the ambient temperature changes ±5 °C from the temperature when the GPS signal was last connected.

Marker frequency counter

Accuracy	\pm (marker frequency x frequency reference accuracy + counter resolution)	
Resolution	0.1, 1, 10 Hz	
Frequency span	Spec	
Range	0 Hz (zero span), 10 Hz to maximum frequency range of instrument	
Resolution	1 Hz	
Accuracy	\pm (2 x RBW centering + horizontal resolution) for detector = Normal	
Sweep time readout	Measured value of the time required to complete a sweep from start to finish, including time to tune receiver, acquire data, and process trace.	
Trace update	N991xB, N993xB, N995xB, N996xB (nominal)	
Span = 20 MHz, RBW, VBW = 3 kHz	9 updates per second	
Span = 100 MHz, RBW, VBW autocoupled	25 updates per second	
Center frequency tune and transfer ¹	N991xB, N993xB (nominal)	N995xB, N996xB (nominal)
101 points, zero span	58 ms	83 ms
101 points, 1 MHz span	52 ms	78 ms
101 points, 100 MHz span	56 ms	84 ms
Sweep time, zero span	N991xB, N993xB, N995xB, N996xB (nominal)	
Range	1 μ s to 6000 s	
Resolution	100 ns	
Readout	Entered value representing trace horizontal scale range	
Trigger (for zero span and FFT sweeps)		
Trigger type	Free run, external, video, RF burst, periodic	
Trigger slope	Positive edge, negative edge	
Trigger delay	Range: -150 ms to 10 s Resolution: 100 ns	
Auto trigger	Forces a periodic acquisition in the absence of a trigger event Range: 0 (off) to 30 s	
Trigger position (zero span)	Controls horizontal position of the pulse edge; use sweep time to zoom into pulse edge Range: 0 to 10, integer steps; 0 is left edge of graticule, 10 is right edge of graticule	
RF burst trigger	Nominal	
Dynamic range	40 dB	
Bandwidth	20 MHz	
Operating frequency range	20 MHz to maximum instrument frequency	
Sweep (trace) point range		
All spans	101, 201, 401, 601, 801, 1001 (defaults to 401) Arbitrary 2 to 20,001 settable through soft key "# Points" or SCPI	

¹ Within full frequency range of instrument, not band dependent.

Resolution Bandwidth (RBW)		Nominal
Range (-3 dB bandwidth)		
Zero span	10 Hz to 5 MHz	1, 3, 10 sequence
Non-zero span	1 Hz to 5 MHz	1, 1.5, 2, 3, 5, 7.5, 10 sequence < 300 kHz, 300 kHz, 1 MHz, 3 MHz, 5 MHz (Other RBWs may be set depending on settings)
		Step keys change RBW in 1, 3, 10 sequence
Selectivity (-60 dB / -3 dB)	4:1	
Bandwidth accuracy		Nominal
	10 Hz to 1 MHz	±5%
Zero span	3 MHz	±10%
	5 MHz	±15%
	1 Hz to 100 kHz	±1%
Non-zero span	300 kHz to 1 MHz	±5%
	3 MHz	±10%
	5 MHz	±15%
Video Bandwidth (VBW)		
	1 Hz to 5 MHz	1, 1.5, 2, 3, 5, 7.5, 10 sequence

Amplitude accuracy and range specifications

Amplitude range		
Measurement range	DANL to +20 dBm	
Input attenuator range	0 to 40 dB, in 5 dB steps	
Preamplifier		Nominal
Frequency range	Full band (9 kHz to maximum frequency of instrument)	
Gain	N991xB, N993xB	+20 dB, 9 kHz to 26.5 GHz
	N995xB, N996xB	+15 dB, 9 kHz to 54 GHz
Max safe input level	Average CW power	DC
N991xB, N993xB	+27 dBm, 0.5 watts	±50 VDC
N995xB, N996xB	+25 dBm, 0.3 watts	±40 VDC
Display range		
Log scale	10 divisions 0.01 to 100 dB/division in 0.01 dB steps	
Linear scale	10 divisions	
Scale units	dBm, dBmV, dBμV, dBmA, dBμA, W, V, A, dBμV/m, dBμA/m, dBG, dBV	

50 MHz absolute amplitude accuracy (dB)

10 dB attenuation, input signal -40 to -5 dBm, peak detector, preamplifier off ¹, 300 Hz RBW, all settings auto-coupled. No warm-up required.

	Spec (-10 to 55 °C)	Typical (-10 to 55 °C)
N991xB, N993xB, N995xB, N996xB	±0.60	±0.20

Total absolute amplitude accuracy (dB) with preamp off

10 dB attenuation, input signal -15 to -5 dBm, peak detector, 300 Hz RBW, all settings auto-coupled, includes frequency response uncertainties. No warm-up required.

		Spec (-10 to 55 °C)	Typical (-10 to 55 °C)
N991xB, N993xB with preamp off	9 kHz to 100 kHz	±2.00	±0.25
	> 100 kHz to 500 MHz	±0.80	±0.20
	> 500 MHz to 16.3 GHz	±1.00	±0.20
	> 16.3 to 18 GHz	±1.00	±0.30
	> 18 to 26.5 GHz ²	±1.10	±0.35
N995xB, N996xB with preamp off	9 kHz to 500 kHz	±2.50	±0.79
	≥ 500 kHz to 15 MHz	±1.10	±0.38
	≥ 15 MHz to 18 GHz	±1.10	±0.18
	≥ 18 to 26.5 GHz	±1.20	±0.21
	≥ 26.5 to 32 GHz	±1.50	±0.30
	≥ 32 to 36 GHz	±1.90	±0.33
	≥ 36 to 44 GHz	±1.90	±0.34
≥ 44 to 50 GHz	±1.90	±0.35	
	≥ 50 to 54 GHz	–	±1.5 (nominal)

Total absolute amplitude accuracy (dB) with preamp on (Option 235 required and turned on)

20 dB attenuation, input signal -25 to -15 dBm for N991xB/3xB or -20 dBm for N995xB/6xB, peak detector, 300 Hz RBW, all settings auto-coupled, includes frequency response uncertainties. No warm-up required.

		Spec (-10 to 55 °C)	Typical (-10 to 55 °C)
N991xB, N993xB with preamp on	9 kHz to 300 kHz	–	±0.80
	> 300 kHz to 500 MHz	±0.80	±0.20
	> 500 MHz to 16.3 GHz	±1.00	±0.20
	> 16.3 to 18 GHz	±1.00	±0.30
	> 18 to 26.5 GHz ²	±1.20	±0.35
N995xB, N996xB with preamp on	9 kHz to 500 kHz	–	±0.90
	≥ 500 kHz to 15 MHz	±1.10	±0.25
	≥ 15 MHz to 18 GHz	±1.10	±0.23
	≥ 18 to 26.5 GHz	±1.20	±0.27
	≥ 26.5 to 32 GHz	±1.50	±0.36
	≥ 32 to 36 GHz	±1.90	±0.36
	≥ 36 to 44 GHz	±1.90	±0.38
≥ 44 to 50 GHz	±1.90	±0.41	
	≥ 50 to 54 GHz	–	±1.0 (nominal)

¹ The spec and typical values, with preamp on, are identical to that with preamp off, but the input signal levels are -40 to -20 dBm.

² N9938B units with Type-N connectors are tested using a system calibrated in 3.5 mm, with a precision 3.5 mm to Type-N adapter. With this adapter, there are nominally four modes between 18 GHz and 26.5 GHz. The effect of these modes is included within these specifications.

Resolution bandwidth switching uncertainty	Nominal
RBW < 5 MHz	0.0 dB
For signals not at center frequency	0.7 dB peak-to-peak

RF input VSWR	Frequency range	Nominal
N991xB, N993xB (0 dB attenuation)	10 MHz to 2.7 GHz	1.7 : 1
	> 2.7 to 7.5 GHz	1.5 : 1
	> 7.5 to 26.5 GHz	2.0 : 1
N995xB, N996xB (0 dB attenuation)	10 MHz to 2.7 GHz	1.7 : 1
	> 2.7 to 7.5 GHz	1.6 : 1
	> 7.5 to 26.5 GHz	2.0 : 1
	> 26.5 to 40 GHz	2.1 : 1
	> 40 to 50 GHz	2.7 : 1
	> 50 to 54 GHz	2.3 : 1

Reference level	
Range	-210 to +90 dBm

Traces	
Detectors	Normal, positive peak, negative peak, sample, average (RMS)
States	Clear/write, max hold, min hold, average, view, blank
Number	Number of averages: 1 to 10,001 4: all four can be active simultaneously and in different states

Markers	
Number of markers	6
Type	Normal, delta, marker table
Marker functions	Noise, band power, frequency counter
Audio beep	Volume and tone change with signal strength
Marker table	Display 6 markers
Marker→	Peak, next peak, peak left, peak right, center frequency, reference level, minimum Tune frequency, for AM/FM tune and listen
Marker properties	Peak criteria: peak excursion, peak threshold Delta reference fixed: Off or On Time zero fixed: Off or On

Dynamic range specifications

Displayed average noise level (DANL) in dBm

Input terminated, RMS detection, log averaging, 0 dB input attenuation, reference level of -20 dBm, normalized to 1 Hz RBW, measured at non-zero frequency span

	Preamp OFF		Preamp ON	
	Spec (-10 to 55 °C)	Typical (-10 to 55 °C)	Spec (-10 to 55 °C)	Typical (-10 to 55 °C)
N991xB, N993xB				
9 kHz to 2 MHz	-122	-134	-129	-148
> 2 MHz to 2.1 GHz	-137	-147	-156	-163
> 2.1 to 2.6 GHz	-136	-143	-155	-160
> 2.6 to 4.5 GHz	-141	-147	-156	-162
> 4.5 to 7.5 GHz	-134	-144	-152	-160
> 7.5 to 13 GHz	-138	-143	-156	-161
> 13 to 18 GHz	-134	-139	-153	-158
> 18 to 22 GHz	-132	-138	-152	-157
> 22 to 25 GHz	-128	-136	-149	-155
> 25 to 26.5 GHz	-126	-132	-146	-152
N995xB, N996xB				
9 kHz to 2 MHz	-94	-129	-98	-143
≥ 2 MHz to 2.1 GHz	-137	-148	-155	-163
≥ 2.1 to 7.5 GHz	-138	-148	-155	-161
≥ 7.5 to 13 GHz	-141	-147	-155	-161
≥ 13 to 26.5 GHz	-132	-142	-145	-155
≥ 26.5 to 32 GHz	-143	-150	-154	-160
≥ 32 to 40 GHz	-133	-144	-147	-156
≥ 40 to 44 GHz	-129	-138	-142	-151
≥ 44 to 50 GHz	-118	-133	-131	-144
≥ 50 to 54 GHz	-113	-126	-126	-139
Residual responses (dBm)	Nominal			
Input terminated preamp off, 0 dB attenuation				
N991xB, N993xB	9 kHz to 10 MHz ¹	-90		
	≥ 10 MHz to 10 GHz	-105		
	≥ 10 GHz to 15 GHz	-100		
	≥ 15 GHz to 26.5 GHz ²	-115		
N995xB, N996xB	9 kHz to 9 MHz	-90		
	≥ 9 MHz to 54 GHz ²	-110		

¹ Excludes 5.625 MHz at -85 dBm
² Excludes 18 GHz at -90 dBm

Input related responses (dBc)

Nominal

N991xB, N993xB			
-30 dBm signal at mixer input (excludes frequencies listed below)			-80
Tuned frequency (f)	Excitation frequency	Spur frequency	Nominal
$f \geq 2.6 \text{ GHz to } 4 \text{ GHz}$	$f + 9.93375 \text{ GHz} / 2$	f	-65
$f > 6 \text{ GHz to } 7.5 \text{ GHz}$	$f + 2 * 9.93375 \text{ GHz}$	f	-65
$f > 12 \text{ GHz to } 14 \text{ GHz}$	$f + 2 * 3.56625 \text{ GHz}$	f	-70
$f \geq 19.5 \text{ GHz to } 23 \text{ GHz}$	$f - 2 * 3.56625 \text{ GHz}$	f	-75
$f \geq 23 \text{ GHz to } 26.5 \text{ GHz}$	$f - 2 * 3.56625 \text{ GHz}$	f	-55
$f > 4 \text{ GHz to } 12 \text{ GHz}$	$f + 2 * 9.933.75 \text{ GHz}$	f	-65
fOffset = frequency offset of excitation frequency from tuned frequency (f)			
$f < 2.6 \text{ GHz}, f > 7.5 \text{ GHz to } 19.5 \text{ GHz}$	$f + \text{fOffset}$	$f - n * \text{fOffset}, (n = 1, 2, 3, \dots)$	-75
	$f + \text{fOffset}$	$f - 2 * (5.625 \text{ MHz} +/- \text{fOffset})$	-70
$f > 2.6 \text{ GHz to } 7.5 \text{ GHz}, f > 19.5 \text{ GHz}$	$f + \text{fOffset}$	$f - n * \text{fOffset}, (n = 1, 2, 3, \dots)$	-75
	$f + \text{fOffset}$	$f + 2 * (5.625 \text{ MHz} +/- \text{fOffset})$	-70
N995xB, N996xB			
-30 dBm signal at mixer input (excludes frequencies listed below)			-85
Tuned frequency (f)	Excitation frequency	Spur frequency	Nominal
$f \geq 12.3 \text{ to } 15.7 \text{ GHz}$	$f + 2 * 3.56625 \text{ GHz}$	f	-75
$f \geq 19.5 \text{ to } 26.5 \text{ GHz}$	$f - 2 * 3.56625 \text{ GHz}$	f	-55
$f \geq 26.5 \text{ to } 32.5 \text{ GHz}$	$f + 2 * 3.56625 \text{ GHz}$	f	-70
$f \geq 32.5 \text{ to } 39.5 \text{ GHz}$	$f - 2 * 3.56625 \text{ GHz}$	f	-55
$f \geq 39.5 \text{ to } 43 \text{ GHz}$	$f - 2 * 3.56625 \text{ GHz}$	f	-50
$f \geq 43 \text{ to } 46.2 \text{ GHz}$	$f + 2 * 3.56625 \text{ GHz}$	f	-45
$f \geq 46.2 \text{ to } 50 \text{ GHz}$	$f - 2 * 3.56625 \text{ GHz}$	f	-45
$f \geq 50 \text{ to } 54 \text{ GHz}$	$f - 2 * 3.56625 \text{ GHz}$	f	-45
$f \geq 2.6 \text{ to } 9.5 \text{ GHz}$	$f + 9.93375\text{GHz} / 2$	f	-75
$f \geq 9.5 \text{ to } 15.7 \text{ GHz}$	$f + 3.56625 \text{ GHz} / 2$	f	-80
$f \geq 26.5 \text{ to } 29 \text{ GHz}$	$f + 3.56625 \text{ GHz} / 2$	f	-60
$f \geq 29 \text{ to } 32.5 \text{ GHz}$	$f + 3.56625 \text{ GHz} / 2$	f	-65
$f \geq 32.5 \text{ to } 39.5 \text{ GHz}$	$f - 3.56625 \text{ GHz} / 2$	f	-60
$f \geq 39.5 \text{ to } 43 \text{ GHz}$	$f - 3.56625 \text{ GHz} / 2$	f	-70
$f \geq 43 \text{ to } 46.2 \text{ GHz}$	$f + 3.56625 \text{ GHz} / 2$	f	-75
$f \geq 46.2 \text{ to } 50 \text{ GHz}$	$f - 3.56625 \text{ GHz} / 2$	f	-75
$f \geq 50 \text{ to } 54 \text{ GHz}$	$f - 3.56625 \text{ GHz} / 2$	f	-80

Input related responses (dBc)

N995xB, N996xB			
Tuned frequency (f)	Excitation frequency	Spur frequency	Nominal
fOffset = frequency offset of excitation frequency from tuned frequency (f)			-80
f < 2.6 GHz, f > 7.5 GHz to 19.5 GHz, f > 26.5 GHz to 32.5 GHz, f > 43 GHz to 46.2 GHz	f + fOffset	f - n * fOffset, (n = 1, 2, 3, ...)	-75
f > 2.6 GHz to 7.5 GHz, f > 19.5 GHz to 26.5 GHz, f > 32.5 GHz to 43 GHz, f > 46.2 GHz	f + fOffset	f - 2 * (5.625 MHz +/- fOffset)	-70
f > 2.6 GHz to 7.5 GHz, f > 19.5 GHz to 26.5 GHz, f > 32.5 GHz to 43 GHz, f > 46.2 GHz	f + fOffset	f - n * fOffset, (n = 1, 2, 3, ...)	-75
f > 2.6 GHz to 7.5 GHz, f > 19.5 GHz to 26.5 GHz, f > 32.5 GHz to 43 GHz, f > 46.2 GHz	f + fOffset	f + 2 * (5.625 MHz +/- fOffset)	-70

Other spurious responses (dBc)		Nominal	Nominal
		N991xB, N993xB	N995xB, N996xB
LO related spurs	9 kHz to 13 GHz	-75	-75
	≥13 to 26.5 GHz	-70	-70
	≥ 26.5 to 54 GHz	—	-64
Sideband		-80	-80
Battery charging sideband ¹		-70	-70
Second harmonic distortion		Nominal	Nominal
-30 dBm signal at mixer input	Frequency	SHI (dBm)	Distortion (dBc)
N991xB, N993xB	10 to 50 MHz	+35	-65
	> 50 MHz to 1.3 GHz	+50	-80
	≥ 1.3 to 3.75 GHz	+35	-65
	≥ 3.75 to 13.25 GHz	+50	-80
N995xB, N996xB	10 to 100 MHz	+35	-65
	> 100 MHz to 1.3 GHz	+50	-80
	≥ 1.3 to 3.75 GHz	+35	-65
	≥ 3.75 to 20 GHz	+25	-55
	≥ 20 to 25 GHz	+20	-50
	≥ 25 to 27 GHz	+15	-45

¹ Charging sidebands will only occur when battery is being charged. The charging sidebands will have an offset between 50 kHz and 350 kHz and they may have harmonics.

Third Order Intermodulation distortion (TOI) in dBm

Two -15 dBm signals, 100 kHz spacing at mixer input (-10 to 55 °C)		Typical
N991xB, N993xB	50 MHz to 500 MHz	+8.5
	≥ 500 MHz to 2 GHz	+11
	≥ 2 to 2.4 GHz	+13
	≥ 2.4 to 2.5 GHz	+13.5
	≥ 2.5 to 7.5 GHz	+9.5
	≥ 7.5 to 10 GHz	+11
	≥ 10 to 20 GHz	+13
	≥ 20 to 26.5 GHz	+15
Two -15 dBm signals, 100 kHz spacing, Ref. level = -10 dBm		Nominal
N995xB, N996xB	50 MHz to 500 MHz	+13
	≥ 500 MHz to 1.4 GHz	+11.5
	≥ 1.4 to 2.4 GHz	+15.5
	≥ 2.4 to 2.42 GHz	+16
	≥ 2.42 to 2.6 GHz	+17
	≥ 2.6 to 7.5 GHz	+13
	≥ 7.5 to 9.5 GHz	+10.5
	≥ 9.5 to 16.3 GHz	+11.5
	≥ 16.3 to 19.5 GHz	+13.5
	≥ 19.5 to 23 GHz	+14.5
	≥ 23 to 26.5 GHz (all >23 GHz tested with 2 MHz spacing)	+16.5
	≥ 26.5 to 32 GHz	+11
	≥ 32 to 36 GHz	+11.5
	≥ 36 to 39.5 GHz	+12
	≥ 39.5 to 43 GHz	+17.5
≥ 43 to 46.2 GHz	+22	
≥ 46.2 to 50 GHz	+22	
≥ 50 to 54 GHz	+21	
Spur free dynamic range (dB) at 2.4 GHz 2/3 (TOI – DANL)		Nominal
N991xB, N993xB, N995xB, N996xB		> 104

Distortion and noise limited (10 Hz RBW) dynamic range (nominal)

Applies to N991xB and N993xB

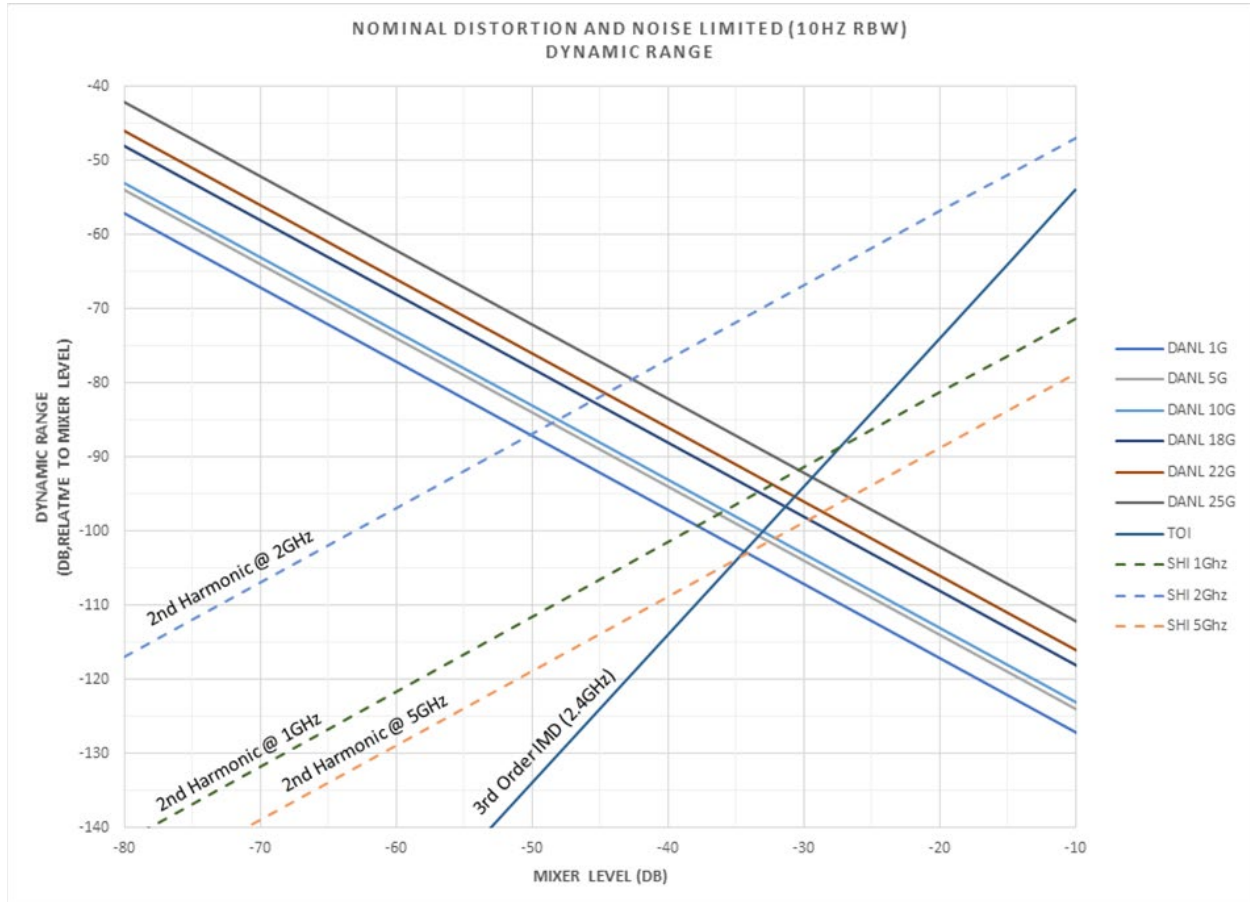

Distortion and noise limited (10 Hz RBW) dynamic range (nominal)

Applies to N995xB and N996xB

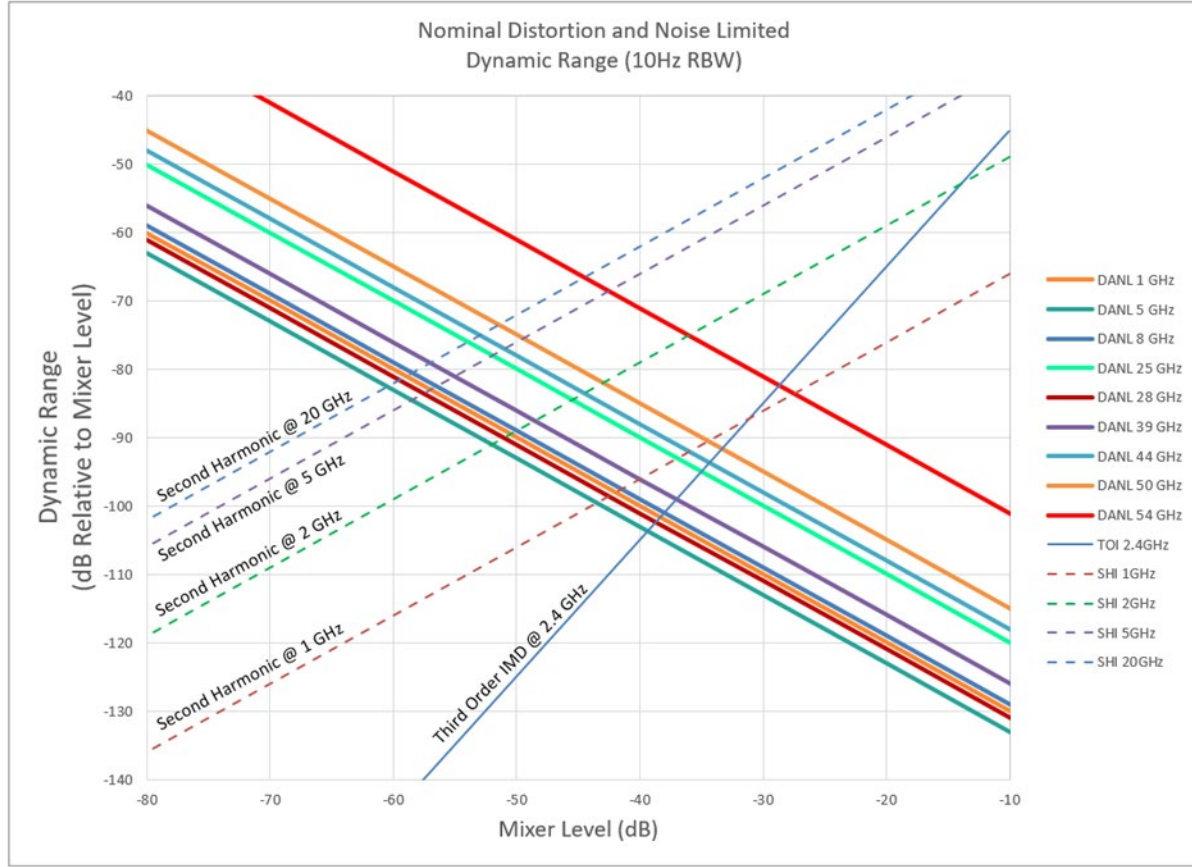

SSB phase noise at 1 GHz center frequency

Phase noise (dBc/Hz)

SSB phase noise at 1 GHz				
Offset	N991xB, N993xB		N995xB, N996xB	
	Spec (-10 to 55 °C)	Typical (-10 to 55 °C)	Spec (-10 to 55 °C)	Typical (-10 to 55 °C)
10 kHz	-111	-117	-109	-113
30 kHz	-110	-115	-110	-114
100 kHz	-105	-111	-105	-111
1 MHz	-119	-124	-119	-124
3 MHz ¹	-123	-128	-125	-130
5 MHz	-124	-129	-126	-130

Phase noise at different center frequencies (nominal)

Applies to N991xB and N993xB

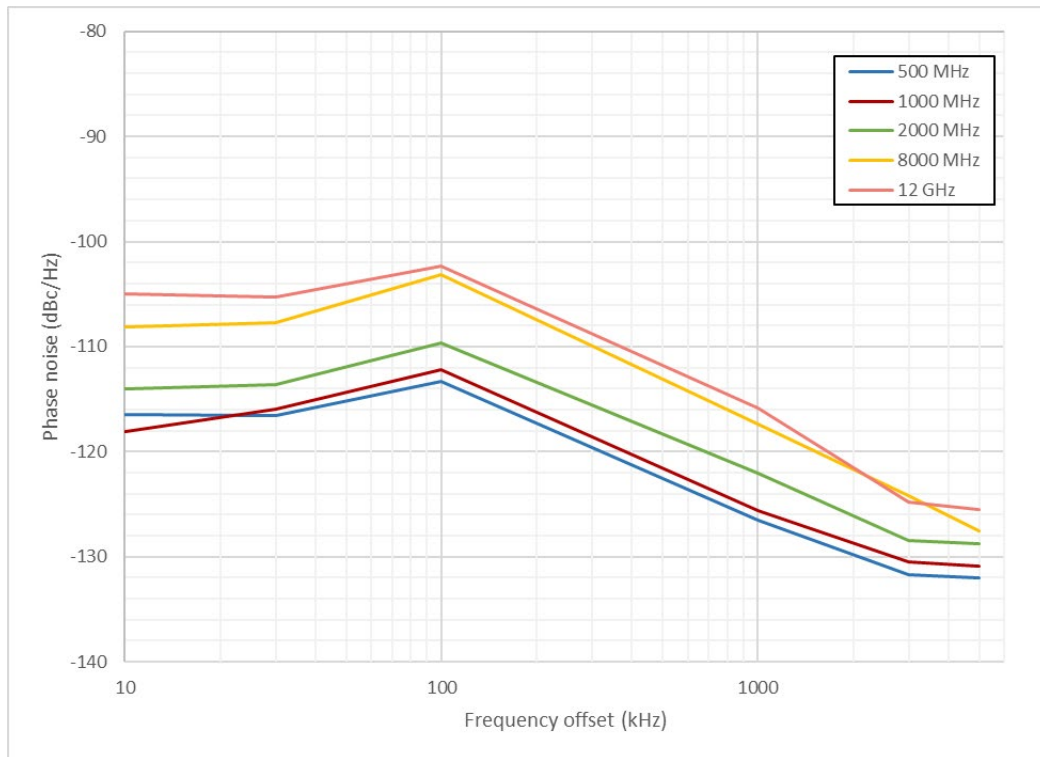

¹ Tested at 2.99 MHz.

Phase noise at different center frequencies (nominal)

Applies to N995xB and N996xB

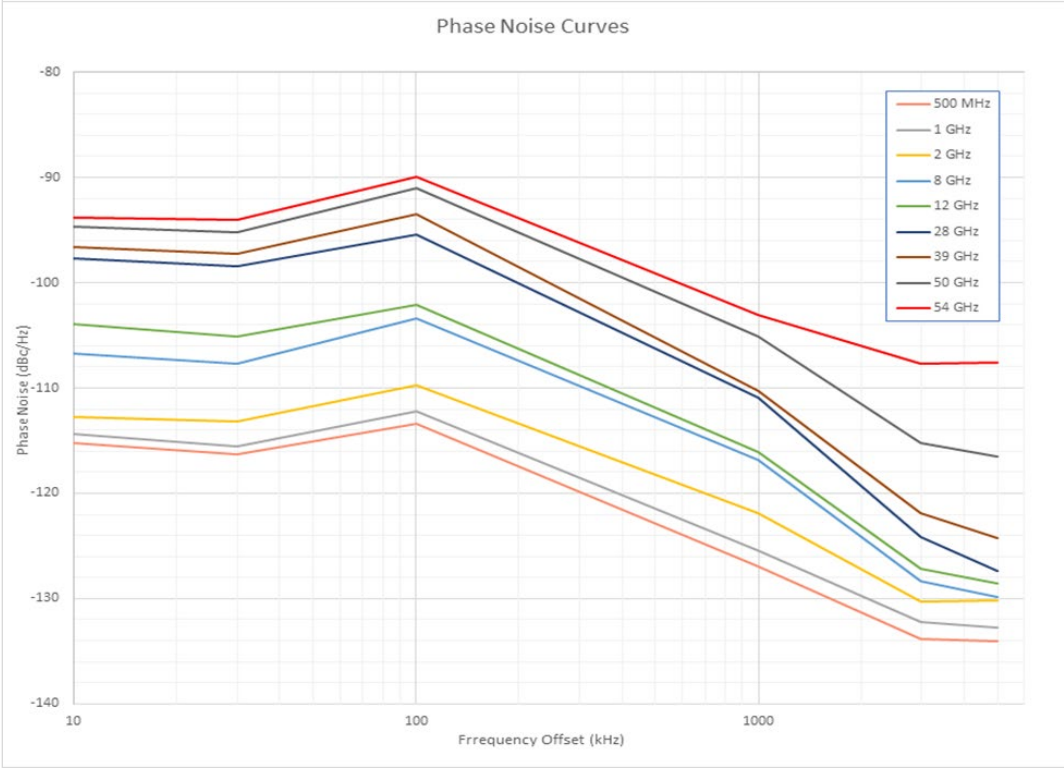

Dynamic range versus offset frequency versus RBW (nominal) ¹

Applies to N991xB, N993xB, N995xB and N996xB

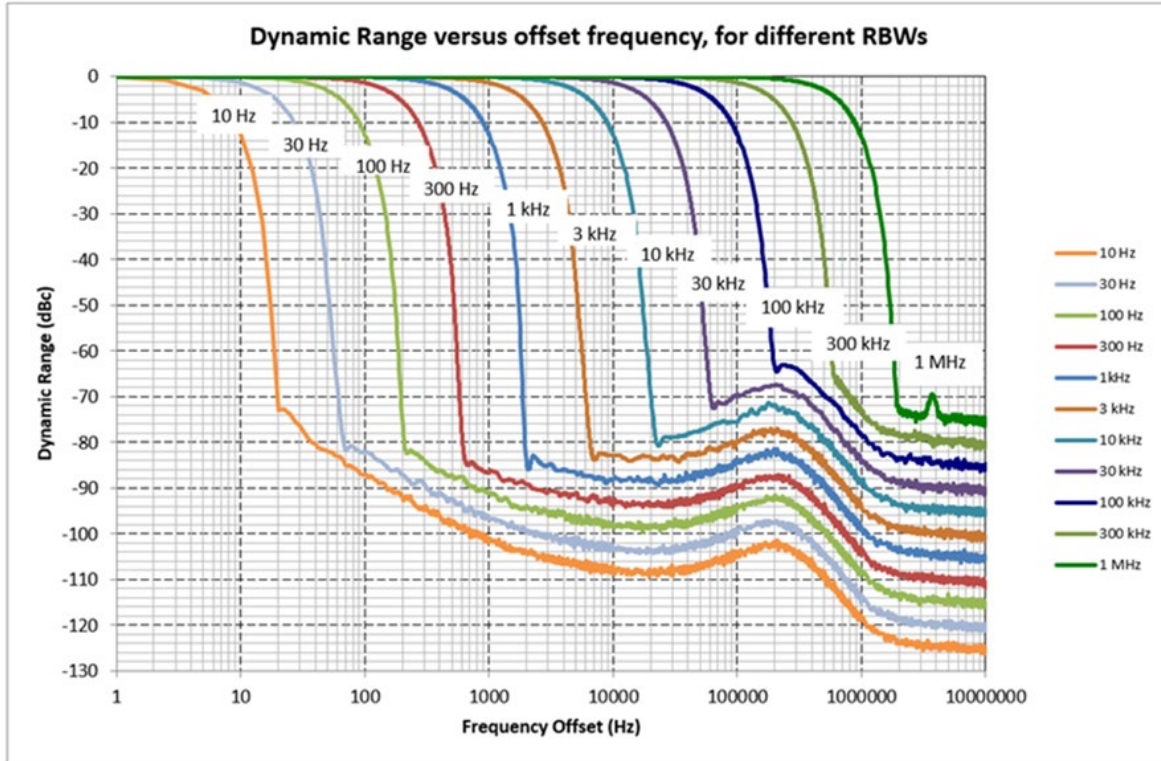

¹ For 1 MHz RBW, the sideband observed may degrade the dynamic range to -70 dBc.

Tracking Generator or Independent Source

The performance listed in this section applies to the tracking generator and independent source capabilities available in the following models:

Description	Model number
FieldFox RF & microwave (combination) analyzers:	N9913B ¹ , N9914B ¹ , N9915B ¹ , N9916B, N9917B, N9918B
FieldFox RF & microwave signal analyzers:	N9933B ¹ , N9934B ¹ , N9935B ¹ , N9936B, N9937B, N9938B
FieldFox microwave (combination) analyzers:	N9950B, N9951B, N9952B, N9953B
FieldFox microwave signal analyzers:	N9960B, N9961B, N9962B, N9963B

See [FieldFox Configuration Guide](#) for option information. Many capabilities listed in this Data Sheet require options.

Note: Traditional tracking generators track the receiver frequency only. In FieldFox analyzers, the tracking generator frequency can be set to either track the receiver frequency, or act as an independent CW source.

	Models	Tracking generator or independent source frequency range
N991xB, N993xB	N9913B ¹ , N9933B ¹	30 kHz to 4 GHz
	N9914B ¹ , N9934B ¹	30 kHz to 6.5 GHz
	N9915B ¹ , N9935B ¹	30 kHz to 9 GHz
	N9916B, N9936B	30 kHz to 14 GHz
	N9917B, N9937B	30 kHz to 18 GHz
	N9918B, N9938B	30 kHz to 26.5 GHz
N995xB, N996xB	N9950B, N9960B	300 kHz to 32 GHz
	N9951B, N9961B	300 kHz to 44 GHz
	N9952B, N9962B	300 kHz to 50 GHz
	N9953B, N9963B	300 kHz to 54 GHz
Power step size	Power settable in 1 dB steps across power range	
Functions		
Mode	Continuous Wave (CW), CW coupled, tracking (swept frequency)	
Operations	Normalization, frequency offset, spectral reversal	

¹ Discontinued and replaced by corresponding Keysight N99xxC Series FieldFox.

Output power (high) (dBm)	Frequency	Typical
N991xB, N993xB	30 kHz to 500 kHz	-9
	> 500 kHz to 10 MHz	-1
	> 10 MHz to 1 GHz	9
	> 1 to 5 GHz	8
	> 5 to 10 GHz	7
	> 10 to 18 GHz	6
	> 18 to 26.5 GHz	3
N995xB, N996xB	300 kHz to 1 MHz	-5
	> 1 to 10 MHz	-1
	> 10 MHz to 6 GHz	5
	> 6 to 18 GHz	6
	> 18 to 26.5 GHz	4
	> 26.5 to 32 GHz	2
	> 32 to 40 GHz	2
	> 40 to 44 GHz	-3
	> 44 to 50 GHz	-4
> 50 to 54 GHz	-8	
Power level accuracy 1	Frequency	Port 1 at -15 dBm (nominal)
N991xB, N993xB	> 500 kHz to 10 MHz	±1 dB
	> 10 MHz to 26.5 GHz	±0.5 dB
N995xB, N996xB ²	300 kHz to 54 GHz	±0.5 dB

1 N991xB power levels are calibrated based on PNA-X's tuned receiver, which means primarily the fundamental is included (for frequencies ≥ 10 MHz). For frequencies < 10 MHz, power levels are calibrated in the factory using a broadband power sensor.

2 N995xB power levels are calibrated based on PNA-X's tuned receiver for the entire frequency range

Dynamic range (dB)	Frequency	Typical (-10 to 55 °C)	
		Preamp OFF	Preamp ON
N991xB, N993xB	300 kHz to 2 MHz	84	100
	> 2 MHz to 2.6 GHz	99	112
	> 2.6 to 7 GHz	98	112
	> 7 to 7.5 GHz	94	112
	> 7.5 to 11 GHz	96	112
	> 11 to 16 GHz	81	95
	> 16 to 18 GHz	86	95
	> 18 to 21 GHz	90	95
	> 21 to 23 GHz	88	95
	> 23 to 25 GHz	78	90
	> 25 to 26.5 GHz	79	90
	N995xB, N996xB	500 kHz to 2 MHz	84
> 2 to 100 MHz		90	106
> 100 MHz to 17.5 GHz		97	114
> 17.5 to 21 GHz		86	102
> 21 to 23.8 GHz		83	99
> 23.8 to 26.6 GHz		73	91
> 26.6 to 37.5 GHz		96	107
> 37.5 to 41.5 GHz		90	103
> 41.5 to 46 GHz		84	99
> 46 to 50 GHz		80	97
> 50 to 54 GHz	73	90	

Real-Time Spectrum Analyzer (RTSA) (Option 350)

The performance listed in this section applies to the real-time spectrum analyzer capabilities available in the following models:

Description	Model number
FieldFox RF & microwave (combination) analyzers:	N9913B ¹ , N9914B ¹ , N9915B ¹ , N9916B, N9917B, N9918B
FieldFox RF & microwave signal analyzers:	N9933B ¹ , N9934B ¹ , N9935B ¹ , N9936B, N9937B, N9938B
FieldFox microwave (combination) analyzers:	N9950B, N9951B, N9952B, N9953B
FieldFox microwave signal analyzers:	N9960B, N9961B, N9962B, N9963B

See [FieldFox Configuration Guide](#) for option information. Many capabilities listed in this Data Sheet require options.

¹ Discontinued and replaced by corresponding Keysight N99xxC Series FieldFox.

	Models	Real-time analysis frequency range ¹	
N991xB, N993xB	N9913B ² , N9933B ²	9 kHz to 4 GHz	Usable to 5 kHz
	N9914B ² , N9934B ²	9 kHz to 6.5 GHz	Usable to 5 kHz
	N9915B ² , N9935B ²	9 kHz to 9 GHz	Usable to 5 kHz
	N9916B, N9936B	9 kHz to 14 GHz	Usable to 5 kHz
	N9917B, N9937B	9 kHz to 18 GHz	Usable to 5 kHz
	N9918B, N9938B	9 kHz to 26.5 GHz	Usable to 5 kHz
N995xB, N996xB	N9950B, N9960B	9 kHz to 32 GHz	Usable to 5 kHz
	N9951B, N9961B	9 kHz to 44 GHz	Usable to 5 kHz
	N9952B, N9962B	9 kHz to 50 GHz	Usable to 5 kHz
	N9953B, N9963B	9 kHz to 54 GHz	Usable to 5 kHz

Real-time analysis

Measurements	Density spectrum, spectrogram, real-time spectrum		
Maximum real-time bandwidth	10 MHz (standard)	40 MHz (Option B04)	100/120 MHz (Option B10)
Resolution bandwidth (Span dependent, $20 \leq \text{Span}/\text{RBW} \leq 280$)	1 Hz to 500 kHz	1 Hz to 2 MHz	1 Hz to 5 MHz
Minimum signal duration with 100% Probability Of Intercept (POI) at full amplitude accuracy	9.13 us	6.13 us	5.52 us
Minimum detectable signal ³	11 ns	11 ns	47 ns
Min. acquisition time (density spectrum)	20 ms	20 ms	20 ms
Min. acquisition time (spectrogram)	500 us/div	500 us/div	500 us/div
Max. acquisition time (density spectrum)	540 ms	337 ms	336 ms
Max. acquisition time (spectrogram)	10 s/div	10 s/div	10 s/div
Spurious-free dynamic range	69 dB	65 dB	63/62 dB
IF flatness (for carrier frequency ≥ 1 MHz)	0.1 dB (typical)	0.1 dB (typical)	0.1 dB (typical)
FFT rate	190,000 FFT/s		
Number of display points	821		

Traces

Number of traces	4: all four can be active simultaneously and in different states
Detectors	Normal, positive peak, negative peak, sample, average (RMS)
States	Clear/write, max. hold, min. hold, average, view, blank

Markers

Number of markers	6
Type	Normal, delta, peak
Mkr →	Peak, next peak, center frequency, reference level

Trigger

Trigger type	Free run, external, video, RF burst, periodic
--------------	---

¹ Performance specified above 1 MHz. Usable down to 5 kHz.

² Discontinued and replaced by corresponding Keysight N99xxC Series FieldFox.

³ Minimum detectable pulse width is the shortest pulse width of a pulsed CW signal that will display a peak amplitude that is no worse than 60 dB below the peak amplitude of a CW signal of the same power level for a defined span and auto-coupled RBW.

I/Q Analyzer (IQA) (Option 351)

The specifications in this section apply to the I/Q analyzer capabilities available in the following models:

Description	Model number
FieldFox RF & microwave (combination) analyzers:	N9913B ¹ , N9914B ¹ , N9915B ¹ , N9916B, N9917B, N9918B
FieldFox RF & microwave signal analyzers:	N9933B ¹ , N9934B ¹ , N9935B ¹ , N9936B, N9937B, N9938B
FieldFox microwave (combination) analyzers:	N9950B, N9951B, N9952B, N9953B
FieldFox microwave signal analyzers:	N9960B, N9961B, N9962B, N9963B

See [FieldFox Configuration Guide](#) for option information. Many capabilities listed in this Data Sheet require options.

	Models	I/Q analysis frequency range ²
N991xB, N993xB	N9913B ¹ , N9933B ¹	9 kHz to 4 GHz
	N9914B ¹ , N9934B ¹	9 kHz to 6.5 GHz
	N9915B ¹ , N9935B ¹	9 kHz to 9 GHz
	N9916B, N9936B	9 kHz to 14 GHz
	N9917B, N9937B	9 kHz to 18 GHz
	N9918B, N9938B	9 kHz to 26.5 GHz
N995xB, N996xB	N9950B, N9960B	9 kHz to 32 GHz
	N9951B, N9961B	9 kHz to 44 GHz
	N9952B, N9962B	9 kHz to 50 GHz
	N9953B, N9963B	9 kHz to 54 GHz

Measurements

Spectrum (frequency domain)	Magnitude spectrum
Waveform (time domain)	RF envelope I/Q waveform (Dual simultaneous top and bottom windows: I vs. time and Q vs. time)

Display (multi-domain) user defined

Set up and display up to 4 simultaneous and multi-domain measurements with any combination of the following:

- Frequency domain: Magnitude spectrum
- Time domain: RF envelope, Q vs. I (polar plot), Phase vs. time, Unwrapped phase vs. time, I vs. time, Q vs. time
- Time summary table showing I/Q capture settings: I/Q capture time, waveform start/stop, Spectrum FFT time

Measurement setup

I/Q capture parameters	Capture time, sample rate, sample period, capture samples
I/Q streaming (requires option 353)	Provides continuous streaming of IQ data up to 1.25 MSamples/sec (or maximum BW of 1 MHz) over the Ethernet port in either VITA49A or Decodio formats

¹ Discontinued and replaced by corresponding Keysight N99xxC Series FieldFox.

² Performance specified above 1 MHz. Usable down to 5 kHz.

Bandwidth options	10 MHz (standard)	40 MHz (Option B04)	120 MHz (Option B10)
Frequency span	10 Hz to 10 MHz	10 Hz to 40 MHz	10 Hz to 120 MHz
Bandwidth options	10 MHz (standard) Typical (-10 to 55 °C)	40 MHz (Option B04) Typical (-10 to 55 °C)	100/120 MHz (Option B10) Typical (-10 to 55 °C)
N991xB, N993xB			
IF flatness			
Magnitude	±0.07 dB	±0.06 dB	±0.11 dB/±0.13 dB
Phase deviation from linearity ¹	0.43° peak-to-peak 0.15° rms	1.4° peak-to-peak 0.6° rms	12.1° peak-to-peak 2°/5° rms
Group delay flatness (peak-to-peak) ¹	1.35 ns	0.9 ns	2.2 ns/3 ns
N995xB, N996xB			
IF flatness			
Magnitude	±0.08 dB	±0.11 dB	±0.19 dB/±0.21 dB
Phase deviation from linearity ¹	0.5° peak-to-peak 0.14° rms	1.52° peak-to-peak 0.69° rms	8.52°/11.32° peak-to-peak 3.88°/5.0° rms
Group delay flatness (peak-to-peak) ¹	1.6 ns	0.96 ns	2.84 ns/3.25 ns
EVM accuracy			
N991xB, N993xB	Nominal	Nominal	Nominal ²
EVM (at center frequency 1 GHz)			
5G NR 64 QAM	—	—	0.70%
LTE-A FDD TM3.1 (10 MHz)	0.50%	0.50%	0.50%
LTE-A FDD TM3.1 (20 MHz)	—	0.40%	0.40%
WCDMA TM4 (5 MHz)	0.70%	0.70%	0.70%
EVM (at center frequency 2.1 GHz)			
LTE-A FDD TM3.1 (10 MHz)	0.70%	0.70%	0.70%
LTE-A FDD TM3.1 (20 MHz)	—	0.50%	0.50%
WCDMA TM4 (5 MHz)	0.75%	0.75%	0.75%
EVM (at center frequency 3.5 GHz)			
5G NR 64 QAM	—	—	0.85%
LTE-A FDD TM3.1 (20 MHz)	—	0.80%	0.80%
EVM (at center frequency 5.8 GHz)			
5G NR 64 QAM	—	—	1%
EVM (at center frequency 24 GHz)			
5G NR 64 QAM	—	—	2%
N995xB, N996xB	Nominal	Nominal	Nominal
EVM (at center frequency 1 GHz)			
5G NR 64 QAM	—	—	0.70%
LTE-A FDD TM3.1 (10 MHz)	0.50%	0.50%	0.50%
LTE-A FDD TM3.1 (20 MHz)	—	0.60%	0.40%
WCDMA TM4 (5 MHz)	0.64%	0.70%	0.70%
EVM (at center frequency 2.1 GHz)			
LTE-A FDD TM3.1 (10 MHz)	0.65%	0.65%	0.65%

¹ Not guaranteed below 50 MHz

² Applies when fast channel equalization (default) is OFF

LTE-A FDD TM3.1 (20 MHz)	—	0.60%	0.50%
WCDMA TM4 (5 MHz)	0.87%	0.75%	0.75%
EVM (at center frequency 3.5 GHz)			
5G NR 64 QAM	—	—	0.80%
LTE-A FDD TM3.1 (20 MHz)	—	0.80%	0.80%
EVM (at center frequency 5.8 GHz)			
5G NR 64 QAM	—	—	1%
EVM (at center frequency 24 GHz)			
5G NR 64 QAM	—	—	2.2%
EVM (at center frequency 28 GHz)			
5G NR 64 QAM	—	—	2.1%
EVM (at center frequency 39 GHz)			
5G NR 64 QAM	—	—	2.3%

Data acquisition

Total capture memory	1024 MB
Length single I/Q capture	8 bytes/sample
Maximum length I/Q capture	128 MSa
Sample rate (I/Q pairs)	1.25 x span
ADC resolution	14 bits

Maximum I/Q capture time

120 MHz span	0.89 s
100 MHz span	1 s
40 MHz span	2.6 s
10 MHz span	10.7 s
1 MHz span	107 s
100 kHz span	1073 s
10 kHz span	10737 s

Dynamic range specifications (wideband path)

Displayed Average Noise Level (DANL) in dBm

Input terminated, RMS detection, log averaging, 0 dB input attenuation, reference level of -20 dBm, normalized to 1 Hz RBW, measured at non-zero frequency span

N991xB, N993xB	Preamp OFF typical (-10 to 55 °C)	Preamp ON typical (-10 to 55 °C)
9 kHz to 2 MHz	-136	-151
≥ 2 MHz to 120 MHz	-151	-165
≥ 120 MHz to 2.6 GHz	-152	-165
≥ 2.6 to 4.5 GHz	-153	-164
≥ 4.5 to 6.5 GHz	-150	-163
≥ 6.5 to 7.5 GHz	-148	-161
≥ 7.5 to 9 GHz	-147	-163
≥ 9 to 14 GHz	-146	-161
≥ 14 to 16.3 GHz	-143	-159
≥ 16.3 to 18 GHz	-141	-159
≥ 18 to 23 GHz	-141	-158
≥ 23 to 26.5 GHz	-137	-155

Displayed Average Noise Level (DANL) in dBm

Input terminated, RMS detection, log averaging, 0 dB input attenuation, reference level of -20 dBm, normalized to 1 Hz RBW, measured at non-zero frequency span

N995xB, N996xB	Preamp OFF typical (-10 to 55 °C)	Preamp ON typical (-10 to 55 °C)
9 kHz to 2 MHz	-130	-143
≥ 2 MHz to 2.1 GHz	-153	-165
≥ 2.1 to 7.5 GHz	-153	-163
≥ 7.5 to 13 GHz	-151	-162
≥ 13 to 26.5 GHz	-145	-157
≥ 26.5 to 32 GHz	-155	-160
≥ 32 to 40 GHz	-150	-157
≥ 40 to 44 GHz	-143	-153
≥ 44 to 50 GHz	-136	-147
≥ 50 to 54 GHz	-130	-142

Input related responses (dBc)			Nominal
-30 dBm signal at mixer input (excludes frequencies listed below)			-75
Tuned frequency (f)	Excitation frequency	Spur frequency	N991xB, N993xB (nominal)
f = tuned frequency			
$f \geq 2.6 \text{ GHz to } 4 \text{ GHz}$	$f + 10.125 \text{ GHz} / 2$	f	-65
$f > 6 \text{ GHz to } 7.5 \text{ GHz}$	$f + 2 * 10.125 \text{ GHz}$	f	-65
$f \geq 7.5 \text{ GHz to } 16 \text{ GHz}$	$f + 2 * 3.375 \text{ GHz}$	f	-70
$f \geq 23 \text{ GHz to } 26.5 \text{ GHz}$	$f - 2 * 3.375 \text{ GHz}$	f	-50
fOffset = frequency offset of excitation frequency from tuned frequency (f)			
$f < 2.6 \text{ GHz}, f > 7.5 \text{ GHz to } 19.5 \text{ GHz}$	$f + \text{fOffset}$	$f - \text{fOffset}$	-70
	$f + \text{fOffset}$	$f - 2 * (37.5 \text{ MHz} - \text{fOffset})$	-65
	$f + \text{fOffset}$	$f + 2 * (112.5 \text{ MHz} + \text{fOffset})$	-60
	$f + \text{fOffset}, (\text{fOffset} < 0)$	$f - 6 * (37.5 \text{ MHz} - \text{fOffset})$	-75
	$f + \text{fOffset}, (\text{fOffset} > 0)$	$f - 6 * (12.5 \text{ MHz} + \text{fOffset})$	-75
$f > 2.6 \text{ GHz to } 7.5 \text{ GHz}, f > 19.5 \text{ GHz}$	$f + \text{fOffset}$	$f - \text{fOffset}$	-70
	$f + \text{fOffset}$	$f + 2 * (37.5 \text{ MHz} - \text{fOffset})$	-65
	$f + \text{fOffset}$	$f - 2 * (112.5 \text{ MHz} + \text{fOffset})$	-65
	$f + \text{fOffset}, (\text{fOffset} > 0)$	$f + 6 * (37.5 \text{ MHz} - \text{fOffset})$	-75
	$f + \text{fOffset}, (\text{fOffset} < 0)$	$f + 6 * (12.5 \text{ MHz} + \text{fOffset})$	-75

Input related responses (dBc)

Nominal

-30 dBm signal at mixer input (excludes frequencies listed below)			-80
Tuned frequency (f)	Excitation frequency	Spur frequency	N995xB, N996xB (nominal)
$f \geq 15.7$ to 19.5 GHz	$f + 2 * 3.375$ GHz	f	-70
$f \geq 19.5$ to 26.5 GHz	$f - 2 * 3.375$ GHz	f	-50
$f \geq 26.5$ to 29 GHz	$f + 2 * 3.375$ GHz	f	-70
$f \geq 29$ to 32.5 GHz	$f + 2 * 3.375$ GHz	f	-55
$f \geq 32.5$ to 36 GHz	$f - 2 * 3.375$ GHz	f	-55
$f \geq 36$ to 43 GHz	$f - 2 * 3.375$ GHz	f	-50
$f \geq 43$ to 46.2 GHz	$f + 2 * 3.375$ GHz	f	-40
$f \geq 46.2$ to 50 GHz	$f - 2 * 3.375$ GHz	f	-40
$f \geq 50$ GHz	$f - 2 * 3.375$ GHz	f	-40
$f \geq 2.6$ to 7.5 GHz	$f + 10.125$ GHz / 2	f	-65
$f \geq 9.5$ to 15.7 GHz	$f + 3.375$ GHz / 2	f	-75
$f \geq 26.5$ to 29 GHz	$f + 3.375$ GHz / 2	f	-60
$f \geq 29$ to 32.5 GHz	$f + 3.375$ GHz / 2	f	-65
$f \geq 32.5$ to 36 GHz	$f - 3.375$ GHz / 2	f	-55
$f \geq 36$ to 39.5 GHz	$f - 3.375$ GHz / 2	f	-60
$f \geq 39.5$ to 43 GHz	$f - 3.375$ GHz / 2	f	-65
$f \geq 43$ to 46.2 GHz	$f + 3.375$ GHz / 2	f	-70
$f \geq 46.2$ to 50 GHz	$f - 3.375$ GHz / 2	f	-70
$f \geq 50$ GHz	$f - 3.375$ GHz / 2	f	-75
fOffset = frequency offset of excitation frequency from tuned frequency (f)			
	$f + f\text{Offset}$	$f - f\text{Offset}$	-70
$f < 2.6$ GHz,	$f + f\text{Offset}$	$f - 2 * (37.5 \text{ MHz} - f\text{Offset})$	-65
$f > 7.5$ GHz to 19.5 GHz,	$f + f\text{Offset}$	$f + 2 * (112.5 \text{ MHz} + f\text{Offset})$	-60
$f > 26.5$ GHz to 32.5 GHz,	$f + f\text{Offset}, (f\text{Offset} < 0)$	$f - 6 * (37.5 \text{ MHz} - f\text{Offset})$	-75
$f > 43$ GHz to 46.2 GHz	$f + f\text{Offset}, (f\text{Offset} > 0)$	$f - 6 * (12.5 \text{ MHz} + f\text{Offset})$	-75
	$f + f\text{Offset}$	$f - f\text{Offset}$	-70
$f > 2.6$ GHz to 7.5 GHz,	$f + f\text{Offset}$	$f + 2 * (37.5 \text{ MHz} - f\text{Offset})$	-65
$f > 19.5$ GHz to 26.5 GHz,	$f + f\text{Offset}$	$f - 2 * (112.5 \text{ MHz} + f\text{Offset})$	-65
$f > 32.5$ GHz to 43 GHz,	$f + f\text{Offset}, (f\text{Offset} > 0)$	$f + 6 * (37.5 \text{ MHz} - f\text{Offset})$	-75
$f > 46.2$ GHz	$f + f\text{Offset}, (f\text{Offset} < 0)$	$f + 6 * (12.5 \text{ MHz} + f\text{Offset})$	-75
$f < 2.6$ GHz,	$f + f\text{Offset}$	$f - n * f\text{Offset}, (n = 1, 2, 3, \dots)$	-75
$f > 7.5$ GHz to 19.5 GHz,			
$f > 26.5$ GHz to 32.5 GHz,	$f + f\text{Offset}$	$f - 2 * (5.625 \text{ MHz} \pm f\text{Offset})$	-70
$f > 43$ GHz to 46.2 GHz			
$f > 2.6$ GHz to 7.5 GHz,	$f + f\text{Offset}$	$f - n * f\text{Offset}, (n = 1, 2, 3, \dots)$	-75
$f > 19.5$ GHz to 26.5 GHz,			
$f > 32.5$ GHz to 43 GHz,	$f + f\text{Offset}$	$f + 2 * (5.625 \text{ MHz} \pm f\text{Offset})$	-70
$f > 46.2$ GHz			

Spur free dynamic range (dB) at 2.4 GHz 2/3 (TOI - DANL)		Nominal
N991xB, N993xB, N995xB, N996xB		> 106
Third Order Intermodulation distortion (TOI) in dBm		Typical
Two -20 dBm signals, 100 kHz spacing at mixer input (-10 to 55 °C)		
N991xB, N993xB	50 MHz to 500 MHz	+5.8
	≥ 500 to 2 GHz	+7.8
	≥ 2 to 2.4 GHz	+9.8
	≥ 2.4 to 2.6 GHz	+8.3
	≥ 2.6 to 5 GHz	+6.3
	≥ 5 to 7.5 GHz	+7
	≥ 7.5 to 10 GHz	+6.8
	≥ 10 to 18 GHz	+8.5
	≥ 18 to 26.5 GHz	+11.4
		Nominal
Two -20 dBm signals, 100 kHz spacing at mixer input, Ref. level = -10 dBm		
N995xB, N996xB	50 to 500 MHz	+10
	≥ 500 MHz to 1.4 GHz	+9.5
	≥ 1.4 to 2.4 GHz	+13
	≥ 2.4 to 2.42 GHz	+13.5
	≥ 2.42 to 2.6 GHz	+13
	≥ 2.6 to 7.5 GHz	+10.5
	≥ 7.5 to 9.5 GHz	+10
	≥ 9.5 to 16.3 GHz	+10.5
	≥ 16.3 to 19.5 GHz	+10.5
	≥ 19.5 to 23 GHz	+12
	≥ 23 to 26.5 GHz (all >23 GHz tested with 2 MHz spacing)	+14
	≥ 26.5 to 32 GHz	+8
	≥ 32 to 36 GHz	+7.5
≥ 36 to 40 GHz	+11	
≥ 40 to 44 GHz	+17	
≥ 44 to 54 GHz	+20	

Traces

Number of windows & layout	1, 2 (top & bottom), 3 (one top, two bottom), or 4 (quad display)
Number of traces	4, all four traces can be active simultaneously in all windows
States	Clear/write, max hold, min hold, average, view, blank

Markers

Number of markers	6 normal + delta pairs
Type	Normal, delta, peak, marker table (up to 6 markers)
Couple markers	On/off (couple markers between traces in different windows)
Mkr →	Peak, next peak, center frequency, reference level

Trigger

Trigger type	Free run, external, video, RF burst, periodic
Trigger slope	Positive edge, negative edge
Trigger delay	Range: -150 ms to 500 ms Resolution: 100 ns
Auto trigger	Forces a periodic acquisition in the absence of a trigger event Range: 0 (off) to 30 s

Data storage

Data types	Trace, Trace+state, picture (PNG)
I/Q capture data file types	CSV, text (TXT), SDF (compatible with 89600 VSA software), Matlab (MAT)
I/Q data formats via SCPI	Raw binary interleaved I/Q data recording, REAL32 (ASCII is default)

Noise Figure (NF) (Option 356)

The specifications in this section apply to the noise figure measurement capabilities available in the following models:

Description	Model number
FieldFox RF & microwave (combination) analyzers:	N9913B ¹ , N9914B ¹ , N9915B ¹ , N9916B, N9917B, N9918B
FieldFox RF & microwave signal analyzers:	N9933B ¹ , N9934B ¹ , N9935B ¹ , N9936B, N9937B, N9938B
FieldFox microwave (combination) analyzers:	N9950B, N9951B, N9952B, N9953B
FieldFox microwave signal analyzers:	N9960B, N9961B, N9962B, N9963B

See [FieldFox Configuration Guide](#) for option information. Many capabilities listed in this Data Sheet require options.

¹ Discontinued and replaced by corresponding Keysight N99xxC Series FieldFox.

No warm-up is required for the instrument specifications.

	Models	Noise figure analysis frequency range
N991xB, N993xB	N9913B ¹ , N9933B ¹	10 MHz to 4 GHz
	N9914B ¹ , N9934B ¹	10 MHz to 6.5 GHz
	N9915B ¹ , N9935B ¹	10 MHz to 9 GHz
	N9916B, N9936B	10 MHz to 14 GHz
	N9917B, N9937B	10 MHz to 18 GHz
	N9918B, N9938B	10 MHz to 26.5 GHz
N995xB, N996xB	N9950B, N9960B	10 MHz to 32 GHz
	N9951B, N9961B	10 MHz to 44 GHz
	N9952B, N9962B	10 MHz to 50 GHz
	N9953B, N9963B	10 MHz to 54 GHz
Measurements		
Noise figure	Noise figure (F dB)	
Noise factor	Noise figure as a ratio (F)	
Gain	Gain (G dB)	
Noise temperature	Noise temperature in Kelvin (K)	
Y-factor	Y-factor (Y dB)	
Setup parameters		Supplemental information
Noise source		Load ENR value(s)
DUT type	Amplifier, downconverter, upconverter, multi-stage converter	
Integration	Mode	Auto Fixed
	Jitter goal	Auto Integration: optimizes gain to avoid compression, and measurement time to achieve jitter goal Fixed Integration: the time per point over which the measurement is averaged is fixed
	Max time / point	Sets measurement jitter performance target Allows user to trade-off jitter vs. measurement time
	Jitter warning	On: displays circles on trace data if jitter goal is exceeded
	Loss compensation	Before DUT, After DUT
Measurement bandwidth (nominal)		
Range	5 MHz (default), 3 MHz, 1 MHz, 300 kHz	
Frequency reference	Refer to spectrum analyzer specifications	

¹ Discontinued and replaced by corresponding Keysight N99xxC Series FieldFox.

Noise figure uncertainty calculator ¹		Supplemental information
		Built-in Based on data from measurement
DUT	Mode	Spot Applies single values uniformly across frequency: Input $ \Gamma $ and Output $ \Gamma $ Γ specification style: Maximum, 95th percentile, 80th percentile, Median, Mean, Fixed Γ distribution: Rayleigh, Fixed, Uniform in Circle
		Table Applies a table of values vs. frequency: Input $ \Gamma $ and Output $ \Gamma $
Preamplifier	Mode	Spot Applies single values uniformly across frequency Input $ \Gamma $ and Output $ \Gamma $ Γ specification style: Maximum, 95th percentile, 80th percentile, Median, Mean, Fixed
		Table Applies a table of values vs. frequency: Input $ \Gamma $ and Output $ \Gamma $ Γ specification style: Maximum, 95th percentile, 80th percentile, Median, Mean, Fixed
Noise source	ENR Mode	Spot Applies single values uniformly across frequency: ENR (dB), ENR Uncertainty (dB), On $ \Gamma $, Off $ \Gamma $, ENR Uncertainty Confidence (SD)
		Table Applies a table of values vs. frequency: ENR (dB), ENR Uncertainty (dB), On $ \Gamma $, Off $ \Gamma $, ENR Uncertainty Confidence (SD)
	Smart (auto) ² For U183x USB smart noise sources (SNS) only. When connected with a USB SNS, FieldFox automatically downloads the ENR table data from the SNS and applies a table of values vs. frequency: ENR (dB), ENR Uncertainty (dB), On $ \Gamma $, Off $ \Gamma $, ENR Uncertainty Confidence (SD)	
Uncertainty contributions	Jitter Random independent events (fluctuations) within the bandwidth occurring during the noise measurement	
	ENR Excess noise ratio of the hot noise source connected to the DUT during the measurement	
	Mismatch Errors resulting from reflections due to impedance differences between components	
	User calibration Errors due to the optional user calibration which is performed with a defined noise standard (ENR source) connected to the input of an LNA, and fixturing/cables used in the DUT measurement, and port 2 of the FieldFox	
Uncertainty coverage	User settable, uncertainty coverage can be set to 1σ (80%), 2σ (95% default), 3σ (99.5%)	
Uncertainty bars	Displays vertical bars representing the calculated measurement uncertainty overlaid on the trace data	
Loss compensation	Before DUT User definable, single value, compensates measurement for insertion loss (dB) before DUT	
	After DUT User definable, single value, compensates measurement for loss (dB) after DUT	
Instrument match	VSWR values are preloaded and automatically applied for instrument and U7227A/C/F or U7228A/C/F preamplifiers	
Calibration options		
Receiver calibration	Uses noise source to calibrate FieldFox receiver gain bandwidth	
User calibration with external U7227A/C/F or U7228A/C/F preamplifier	Optional calibration performs hot/cold measurement with external preamplifier; applies receiver and user calibrations	

¹ Keysight provides an on-line NF uncertainty calculator for the FieldFox at <https://www.keysight.com/us/en/assets/9921-01574>
² Requires FieldFox firmware rev. A. 12.53 or later

Noise figure ¹		Internal preamplifier ON	Internal preamplifier ON + U7227/8A	Internal preamplifier ON + U7227/8C
	Frequency	(dB)	(dB)	(dB)
N991xB, N993xB	10 to 100 MHz	13.5	6.1	—
	≥ 100 MHz to 2.1 GHz	13.5	5.6	6.6
	≥ 2.1 to 2.6 GHz	16.5	5.9	6.9
	≥ 2.6 to 4 GHz	14.5	5.5	6.6
	≥ 4 to 4.5 GHz	14.5	—	5.7
	≥ 4.5 to 6 GHz	16.5	—	6.0
	≥ 6 to 7.5 GHz	16.5	—	5.2
	≥ 7.5 to 13 GHz	15.5	—	4.9
	≥ 13 to 18 GHz	18.5	—	5.2
	≥ 18 to 22 GHz	19.5	—	5.9
	≥ 22 to 25 GHz	21.5	—	6.1
	≥ 25 to 26.5 GHz	24.5	—	6.7
		Internal preamplifier ON	Internal preamplifier ON + U7227/8F ²	
	Frequency	(dB)	(dB)	
N991xB, N993xB	≥ 2.1 to 2.6 GHz	16.5	10.4	
	≥ 2.6 to 4 GHz	14.5	8.4	
	≥ 4 to 4.5 GHz	14.5	8.3	
	≥ 4.5 to 7.5 GHz	16.5	8.5	
	≥ 7.5 to 13 GHz	15.5	8.4	
	≥ 13 to 18 GHz	18.5	8.5	
	≥ 18 to 22 GHz	19.5	8.5	
	≥ 22 to 25 GHz	21.5	8.6	
≥ 25 to 26.5 GHz	24.5	9.0		

¹ Noise figure (NF) = DANL - (-173.98 - 2.51) dB

Nominal calculation is based on spectrum analyzer (SA) displayed average noise level (DANL) specification (dBm) stated as input terminated, RMS detection, log averaging, 0 dB input attenuation, reference level of -20 dBm, normalized to 1 Hz RBW. Noise figure (NF) = D - (K - L), where D is the DANL (displayed average noise level) specification, K is kTB (-173.98 dBm in a 1 Hz bandwidth at 290 K), and L is 2.51 dB (the effect of log averaging used in DANL verifications).

² U7227/8F maximum frequency is 50 GHz; can be used with N991xB or N993xB up to maximum frequency of 26.5 GHz.

Noise figure ¹	Frequency	Internal preamplifier ON	Internal preamplifier ON + U7227/8A	Internal preamplifier ON + U7227/8C
		(dB)	(dB)	(dB)
N995xB, N996xB	10 to 100 MHz	13.5	6.1	—
	≥ 100 MHz to 2.1 GHz	13.5	5.5	6.5
	≥ 2.1 to 4 GHz	15.5	5.9	6.8
	≥ 4 to 6 GHz	15.5	—	5.9
	≥ 6 to 7.5 GHz	15.5	—	4.9
	≥ 7.5 to 13 GHz	15.5	—	4.9
	≥ 13 to 18 GHz	21.5	—	7.0
	≥ 18 to 26.5 GHz	21.5	—	6.4
	≥ 26.5 to 32 GHz	16.5	—	—
	≥ 32 to 40 GHz	20.5	—	—
	≥ 40 to 44 GHz	25.5	—	—
	≥ 44 to 50 GHz	32.5	—	—
	≥ 50 to 54 GHz	37.5	—	—
N995xB, N996xB	Frequency	Internal preamplifier ON (dB)	Internal preamplifier ON + U7227/8F (dB)	
	≥ 2.1 to 4 GHz	15.5	10.3	
	≥ 4 to 6 GHz	15.5	8.4	
	≥ 6 to 7.5 GHz	15.5	8.4	
	≥ 7.5 to 13 GHz	15.5	8.4	
	≥ 13 to 18 GHz	21.5	9.4	
	≥ 18 to 26.5 GHz	21.5	9.4	
	≥ 26.5 to 32 GHz	16.5	8.5	
	≥ 32 to 40 GHz	20.5	9.2	
	≥ 40 to 44 GHz	25.5	9.5	
≥ 44 to 50 GHz	32.5	11.3		
≥ 50 to 54 GHz	37.5	—		

¹ Noise figure (NF) = DANL - (-173.98 - 2.51) dB

Nominal calculation is based on spectrum analyzer (SA) displayed average noise level (DANL) specification (dBm) stated as input terminated, RMS detection, log averaging, 0 dB input attenuation, reference level of -20 dBm, normalized to 1 Hz RBW. Noise figure (NF) = D - (K - L), where D is the DANL (displayed average noise level) specification, K is kTB (-173.98 dBm in a 1 Hz bandwidth at 290 K), and L is 2.51 dB (the effect of log averaging used in DANL verifications).

External preamplifier

Specification	U7227/8A	U7227/8C	U7227/8F
Frequency	10 MHz to 4 GHz	100 MHz to 26.5 GHz	2 GHz to 50 GHz
	10 MHz to 100 MHz: < 5.5	100 MHz to 4 GHz: < 6	2 to 4 GHz: < 10
Noise figure (dB)	100 MHz to 4 GHz: < 5	4 to 6 GHz: < 5 6 to 18 GHz: < 4 18 to 26.5 GHz: < 5	4 to 40 GHz: < 8 40 to 44 GHz: < 9 44 to 50 GHz: < 10
Gain (dB)	10 to 100 MHz: > 16 100 MHz to 4 GHz: > 0.5F ¹ + 17	100 MHz to 26.5 GHz: > 16.1 + 0.26F ¹	2 GHz to 50 GHz: > 16.5 + 0.23F ¹
RF connector	3.5 mm (m)	3.5 mm (m)	2.4 mm (m)

Noise source

Model	Frequency range	ENR
Keysight 346 noise source family		
346A	10 MHz to 18 GHz	5 to 7 dB
346B	10 MHz to 18 GHz	14 to 16 dB
346C	10 MHz to 26.5 GHz	12 to 17 dB
346CK40	1 GHz to 40 GHz	3 to 14 dB
346CK01	1 GHz to 50 GHz	7 to 20 dB
Keysight USB smart noise source (SNS) family ²		
U1832A	10 MHz to 18 GHz	4.5 to 6.5 dB
U1832B	10 MHz to 26.5 GHz	4 to 7 dB
U1833A	10 MHz to 18 GHz	14 to 16 dB
U1833B	10 MHz to 26.5 GHz	12 to 17 dB
U1832C	500 MHz to 50 GHz	3.5 to 8.5 dB
U1833C	500 MHz to 50 GHz	10 to 21 dB
U1833D	500 MHz to 60 GHz	6 to 21 dB

Noise source setup		Supplemental info
ENR mode	Spot	Single ENR value (not frequency dependent) (default: 15 dB)
	Table	Applies table of ENR values vs. frequency
	Smart ² (auto)	Create, save, recall, edit ENR tables; File type: ENR
T cold	Auto (default) or manual	Noise temperature of cold noise standard connected to DUT during the measurement
Connector type	SMB (m)	DC bias requires accessory N9910X-713 BNC to SMB cable, for 346 noise source only
	USB 3.0 (Type C)	For U183x USB SNS only
Control voltage drive level	28 ± 1 V	For 346 noise source only, no need for U183x USB SNS
Operating temperature	0 to 55 °C	

¹ F signifies frequency in GHz

² Requires FieldFox firmware rev. A.12.53 or later

Sweep

Number of points	11 (default), 21, 51, 101, 201, 401, 601, 801, 1001
Sweep mode	Continuous or single

DUT profiles available (built-in GUI wizard aids DUT measurement setup)

Amplifier	Includes any non-frequency-converting device
Downconverter	Frequency context can be set to RF or IF; sideband can be set to LSB, USB, DSB
Upconverter	Frequency context can be set to RF or IF; sideband can be set to LSB, USB, DSB
Multi-stage converter	Frequency context can be set to RF or IF

Display formats

Number of traces	Two traces available
	Single-trace
Display formats	Dual-trace overlay (both traces on one graticule)
	Dual-trace split (each trace on separate top and bottom graticules)
Display data	Display data, memory, data and memory
Trace memory	One memory trace per data trace, total of 2 memory traces
Limit lines	Upper and lower for each trace

Markers

Number of markers	6
Type	Normal, Delta, Marker Table
Marker table	Display 6 markers
Mkr →	Peak, Next Peak, Peak Left, Peak Right, Center Frequency, Reference Level, Minimum, Target

Data storage

Data types	Trace, Trace+State, Picture (PNG), CSV
------------	--

The performance listed in these sections below applies to the spectrum analyzer IF output, preamplifier, interference analyzer and spectrogram, channel scanner and 89600 VSA software capabilities available in the following models:

Description	Model number
FieldFox RF & microwave (combination) analyzers:	N9913B ¹ , N9914B ¹ , N9915B ¹ , N9916B, N9917B, N9918B
FieldFox RF & microwave signal analyzers:	N9933B ¹ , N9934B ¹ , N9935B ¹ , N9936B, N9937B, N9938B
FieldFox microwave (combination) analyzers:	N9950B, N9951B, N9952B, N9953B
FieldFox microwave signal analyzers:	N9960B, N9961B, N9962B, N9963B

See [FieldFox Configuration Guide](#) for option information. Many capabilities listed in this Data Sheet require options.

Spectrum Analyzer IF Output

Spectrum analyzer mode, zero span, IF output settings ²

Bandwidth options	10 MHz (standard)	40 MHz (Option B04)	120 MHz (Option B10)
IF output mode (narrow)			
Center frequency	33.75 MHz	33.75 MHz	33.75 MHz
IF bandwidth	10 MHz	10 MHz	10 MHz
IF output mode (wide)			
Center frequency	—	225 MHz	225 MHz
IF bandwidth	—	100 MHz	100 MHz
Conversion gain ³	Center frequency	Narrowband path	Wideband path
N991xB, N993xB	< 120 MHz	2 dB to -1 dB	6 dB to 3 dB
	≥ 120 MHz to 7.5 GHz	6 dB to -6 dB	13 dB to 4 dB
	≥ 7.5 GHz to 26.5 GHz	6 dB to -6 dB	13 dB to 0 dB
N995xB, N996xB	< 120 MHz	7 dB to -5 dB	16 dB to 0 dB
	≥ 120 MHz to 7.5 GHz	6 dB to -6 dB	13 dB to 3 dB
	≥ 7.5 GHz to 26.5 GHz	10 dB to -9 dB	17 dB to 4 dB
	≥ 26.5 GHz to 40 GHz	10 dB to -9 dB	18 dB to 2 dB
	≥ 40 GHz to 54 GHz	3 dB to -24 dB	10 dB to -12 dB
Connector	SMB male		

¹ Discontinued and replaced by corresponding Keysight N99xxC Series FieldFox.

² Measurements are uncalibrated in IF output mode

³ RF input to SA output with -20 dBm input power, 0 dB attenuation, and preamp off.

Preamplifier (Option 235)

		Nominal
Frequency range		Full band (9 kHz to maximum frequency of instrument)
Gain	N991xB, N993xB	+20 dB, 9 kHz to 26.5 GHz
	N995xB, N996xB	+15 dB, 9 kHz to 54 GHz

Interference Analyzer and Spectrogram (Option 236)

	Description
Spectrogram display	Overlay, full screen, top, or bottom with active trace
Waterfall angle	Moderate, steep, gradual, wide angle
Markers	Time, delta time
Trace playback and recording	<ul style="list-style-type: none"> Record all spectrum analyzer measurements Playback recorded data using FieldFox Frequency mask trigger allows recording to occur upon trigger Store data internally or USB or SD card

Channel Scanner (Option 312)

	Description
Scan Mode	Range or custom list
Display Type	Bar chart vertical, bar chart horizontal, channel power, strip chart, chart overlay, scan & listen
Data logging mode	Time with geo tagging
Trace playback and recording	<ul style="list-style-type: none"> Record channel power measurement Playback recorded data using FieldFox Store data internally or USB or SD card in .csv or .kml format Data in .kml format can be exported to Google Earth

89600 VSA Software

EVM accuracy

Bandwidth options	10 MHz (standard) nominal	40 MHz (Option B04) nominal ¹	120 MHz (Option B10) Nominal ¹
N991xB, N993xB			
EVM (at center frequency 1 GHz)			
5G NR 64 QAM	—	—	0.70%
LTE-A FDD TM3.1 (10 MHz)	0.50%	0.50%	0.50%
LTE-A FDD TM3.1 (20 MHz)	—	0.40%	0.40%
WCDMA TM4 (5 MHz)	0.70%	0.70%	0.70%
EVM (at center frequency 2.1 GHz)			
LTE-A FDD TM3.1 (10 MHz)	0.70%	0.70%	0.70%
LTE-A FDD TM3.1 (20 MHz)	—	0.50%	0.50%
WCDMA TM4 (5 MHz)	0.75%	0.75%	0.75%
EVM (at center frequency 3.5 GHz)			
5G NR 64 QAM	—	—	0.85%
LTE-A FDD TM3.1 (20 MHz)	—	0.80%	0.80%
EVM (at center frequency 5.8 GHz)			
5G NR 64 QAM	—	—	1%
EVM (at center frequency 24 GHz)			
5G NR 64 QAM	—	—	2%
N995xB, N996xB			
EVM (at center frequency 1 GHz)			
5G NR 64 QAM	—	—	0.70%
LTE-A FDD TM3.1 (10 MHz)	0.50%	0.50%	0.50%
LTE-A FDD TM3.1 (20 MHz)	—	0.60%	0.40%
WCDMA TM4 (5 MHz)	0.64%	0.70%	0.70%
EVM (at center frequency 2.1 GHz)			
LTE-A FDD TM3.1 (10 MHz)	0.65%	0.65%	0.65%
LTE-A FDD TM3.1 (20 MHz)	—	0.60%	0.50%
WCDMA TM4 (5 MHz)	0.87%	0.75%	0.75%
EVM (at center frequency 3.5 GHz)			
5G NR 64 QAM	—	—	0.80%
LTE-A FDD TM3.1 (20 MHz)	—	0.80%	0.80%
EVM (at center frequency 5.8 GHz)			
5G NR 64 QAM	—	—	1%
EVM (at center frequency 24 GHz)			
5G NR 64 QAM	—	—	2.2%
EVM (at center frequency 28 GHz)			
5G NR 64 QAM	—	—	2.1%
EVM (at center frequency 39 GHz)			
5G NR 64 QAM	—	—	2.3%

¹ Applies when fast channel equalization (default) is OFF

Over-the-Air (OTA) LTE FDD/TDD (Option 370/371)

The performance listed in this section applies to the OTA analyzer capabilities available in the following models:

Description	Model number
FieldFox RF & microwave (combination) analyzers:	N9913B ¹ , N9914B ¹ , N9915B ¹ , N9916B, N9917B, N9918B
FieldFox RF & microwave signal analyzers:	N9933B ¹ , N9934B ¹ , N9935B ¹ , N9936B, N9937B, N9938B
FieldFox microwave (combination) analyzers:	N9950B, N9951B, N9952B, N9953B
FieldFox microwave signal analyzers:	N9960B, N9961B, N9962B, N9963B

See [FieldFox Configuration Guide](#) for option information. Many capabilities listed in this Data Sheet require options.

	Models	OTA analysis frequency range ²
N991xB, N993xB	N9913B ¹ , N9933B ¹	1 MHz to 4 GHz
	N9914B ¹ , N9934B ¹	1 MHz to 6.5 GHz
	N9915B ¹ , N9935B ¹	1 MHz to 9 GHz
	N9916B, N9936B	1 MHz to 14 GHz
	N9917B, N9937B	1 MHz to 18 GHz
	N9918B, N9938B	1 MHz to 26.5 GHz
N995xB, N996xB	N9950B, N9960B	1 MHz to 32 GHz
	N9951B, N9961B	1 MHz to 44 GHz
	N9952B, N9962B	1 MHz to 50 GHz
	N9953B, N9963B	1 MHz to 54 GHz

LTE FDD/TDD Over-the-Air (OTA) measurements ³

Cell scan results	Frequency PCI (Physical Cell Identifier) (C/S/G) RSRP (Reference Signal Received Power) (dBm) RSRQ (Reference Signal Received Quality) (dB) RSSI (Reference Signal Strength Indicator) (dBm) PSS (Primary Synchronization Signal) (dBm) SSS (Secondary Synchronization Signal) (dBm) SINR (Signal to Interference & Noise Ratio) (dB) Freq Err (Frequency Error) (Hz)
Data formats	User can set up and display 1, 2, 3 or 4 simultaneous measurements of key performance indicators (KPI's) for any component carrier (CC0 through CC4), up to 5 carriers, in any combination of the following:

¹ Discontinued and replaced by corresponding Keysight N99xxC Series FieldFox.

² Performance specified above 1 MHz. Usable down to 5 kHz.

³ For center frequency signals above 1 GHz, the built-in GPS receiver (Option 307) is highly recommended or locking to any 10 MHz frequency reference. When locked to GPS as the frequency reference, this provides accuracy of ± 0.01 ppm (spec).

	Table	Cell scan numeric results (for up to 6 cell sites (ID's) including PCI (C/S/G), RSRP, RSRQ, RSSI, PSS, SSS, SINR, Freq Err
	Bar chart	Vertical power bar graph of selectable cell scan results for up to 6 cell sites with adjustable color "heat" amplitude scale
	Spectrum	Magnitude spectrum frequency domain (fixed span)
	Strip chart	Magnitude of selectable cell scan results graphed over time
Signal bandwidth	Up to 20 MHz	
Setup parameters		
Component carrier	CC0 to CC4	
Channel table	Sets frequency based on band and channels	
Favorites list	Save up to 6 favorite cellular bands/channels	
Window configuration	Any combination of 1, 2, 3, or all 4 windows can be displayed simultaneously: 1, 2 (top & bottom), 3 (one top, two bottom), or 4 (quad display)	
Trigger		
Trigger type	Free run, external	
Record/Playback		
Data logging	Record, recall and playback data for all component carrier(s)	
Record settings	Meas Interval, Interval type (time or distance), time interval, distance interval	
Supported file types	CSV, KML	
Saving data	Save/recall recorded data logs to/from internal memory or external USB or SD card	

Over-the-Air (OTA) 5G TF (Option 377)

The performance listed in this section applies to the OTA analyzer capabilities available in the following models:

Description	Model number
FieldFox RF & microwave (combination) analyzers:	N9913B ¹ , N9914B ¹ , N9915B ¹ , N9916B, N9917B, N9918B
FieldFox RF & microwave signal analyzers:	N9933B ¹ , N9934B ¹ , N9935B ¹ , N9936B, N9937B, N9938B
FieldFox microwave (combination) analyzers:	N9950B, N9951B, N9952B, N9953B
FieldFox microwave signal analyzers:	N9960B, N9961B, N9962B, N9963B

See [FieldFox Configuration Guide](#) for option information. Many capabilities listed in this Data Sheet require options.

¹ Discontinued and replaced by corresponding Keysight N99xxC Series FieldFox.

	Models	OTA analysis frequency range ¹
N991xB, N993xB ²	N9913B ³ , N9933B ³	1 MHz to 4 GHz
	N9914B ³ , N9934B ³	1 MHz to 6.5 GHz
	N9915B ³ , N9935B ³	1 MHz to 9 GHz
	N9916B, N9936B	1 MHz to 14 GHz
	N9917B, N9937B	1 MHz to 18 GHz
	N9918B, N9938B	1 MHz to 26.5 GHz
N995xB, N996xB	N9950B, N9960B	1 MHz to 32 GHz
	N9951B, N9961B	1 MHz to 44 GHz
	N9952B, N9962B	1 MHz to 50 GHz
	N9953B, N9963B	1 MHz to 54 GHz

5G TF Over-the-Air (OTA) measurements ⁴

Cell scan results	Center frequency PCI (Physical Cell Identifier) Power (Channel Power) (dBm) PSS (Primary Synchronization Signal) (dBm) SSS (Secondary Synchronization Signal) (dBm) Sync Corr (Sync Correlation) (%)
Data formats	User can setup and display 1, 2, 3 or 4 simultaneous measurements of key performance indicators (KPI's) for any component carrier (CC0 through CC7), up to 8 carriers, in any combination of the following:
Table	Cell scan numeric results (for up to 6 cell sites (ID's) including Cell ID, Channel Power, PSS, SSS, Sync Corr
Bar chart	Vertical power bar graph of selectable cell scan results for up to 8 cell sites with adjustable color "heat" amplitude scale
Spectrum	Magnitude spectrum frequency domain (fixed span)
Strip chart	Magnitude of selectable cell scan results graphed over time
Signal bandwidth	Up to 10 MHz

Setup parameters

Component carrier	CC0 to CC7
Channel table	Sets frequency based on band and channel
Window configuration	Any combination of 1, 2, 3, or all 4 windows can be displayed simultaneously: 1, 2 (top & bottom), 3 (one top, two bottom), or 4 (quad display)

Trigger

Trigger type	Free run, external
--------------	--------------------

Record/Playback

Data logging	Record, recall and playback data for all component carrier(s)
Record settings	Meas Interval, Interval type (time or distance), time interval, distance interval
Supported file types	CSV, KML
Saving data	Save/recall recorded data logs to/from internal memory or external USB or SD card

¹ Performance specified above 1 MHz. Usable down to 5 kHz.

² Requires external mixer to down convert millimeter wave frequency to intermediate frequency (IF)

³ Discontinued and replaced by corresponding Keysight N99xxC Series FieldFox.

⁴ For center frequency signals above 1 GHz, the built-in GPS receiver (Option 307) is highly recommended or locking to any 10 MHz frequency reference. When locked to GPS as the frequency reference, this provides accuracy of ± 0.01 ppm (spec).

Over-the-Air (OTA) 5G NR (Option 378)

The performance listed in this section applies to the OTA analyzer capabilities available in the following models:

Description	Model number
FieldFox RF & microwave (combination) analyzers:	N9913B ¹ , N9914B ¹ , N9915B ¹ , N9916B, N9917B, N9918B
FieldFox RF & microwave signal analyzers:	N9933B ¹ , N9934B ¹ , N9935B ¹ , N9936B, N9937B, N9938B
FieldFox microwave (combination) analyzers:	N9950B, N9951B, N9952B, N9953B
FieldFox microwave signal analyzers:	N9960B, N9961B, N9962B, N9963B

See [FieldFox Configuration Guide](#) for option information. Many capabilities listed in this Data Sheet require options.

	Models	OTA analysis frequency range ²
N991xB, N993xB	N9913B ¹ , N9933B ¹	1 MHz to 4 GHz
	N9914B ¹ , N9934B ¹	1 MHz to 6.5 GHz
	N9915B ¹ , N9935B ¹	1 MHz to 9 GHz
	N9916B, N9936B	1 MHz to 14 GHz
	N9917B, N9937B	1 MHz to 18 GHz
	N9918B, N9938B	1 MHz to 26.5 GHz
N995xB, N996xB	N9950B, N9960B	1 MHz to 32 GHz
	N9951B, N9961B	1 MHz to 44 GHz
	N9952B, N9962B	1 MHz to 50 MHz
	N9953B, N9963B	1 MHz to 54 MHz

5G NR measurements³

5G NR Over-the-Air (OTA)

Cell scan results	Frequency PCI (Physical Cell Identifier) (C-S-G) (Cell ID-Sector ID-Group ID) SSB Index (Synchronization Signal Block Index) SS-RSRP (Synchronization Signal Reference Signal Received Power) (dBm) SS-RSRQ (Synchronization Signal Reference Signal Received Quality) (dB) RSSI (Received Signal Strength Indicator) (dBm) SS-SINR (Synchronization Signal Signal-to-Noise and Interference Ratio) (dB) PSS (Primary Synchronization Signal) (dBm) SSS (Secondary Synchronization Signal) (dBm) PBCH DMRS (Physical Broadcast Channel Demodulation Reference Signal) (dBm) Freq Err (Frequency Error) (Hz)
-------------------	---

¹ Discontinued and replaced by corresponding Keysight N99xxC Series FieldFox.

² Performance specified above 1 MHz. Usable down to 5 kHz.

³ For center frequency signals above 1 GHz, the built-in GPS receiver (Option 307) is highly recommended or locking to any 10 MHz frequency reference. When locked to GPS as the frequency reference, this provides accuracy of ± 0.01 ppm (spec).

5G NR EVM conducted		
Cell scan results	Frequency PCI (Physical Cell Identifier) SSB Numerology (Synchronization Signal Block Numerology) SSB Case (Synchronization Signal Block Case) SSB Lmax (Maximum Number SSB's within SSB Set, Lmax = 4, 8 or 64) SSB Periodicity (ms) SSB RB Offset (Synchronization Signal Block Resource Block Offset) SSB SC Offset (Synchronization Signal Block Subcarrier Offset) SSB Delta Center (Synchronization Signal Block Delta Center) (kHz) Sync Corr (Synchronization Correlation) (%) Channel Power (dBm) Freq Err (Frequency Error) (Hz) Time Offset (ms) PSS EVM (Primary Synchronization Signal EVM) (%rms) SSS EVM (Secondary Synchronization Signal EVM) (%rms) PBCH EVM (Physical Broadcast Channel EVM) (%rms) PBCH DMRS EVM (Physical Broadcast Channel Demodulation Reference Signal EVM) (%rms) Composite EVM (%rms) SS-RSRP (Synchronization Signal Reference Signal Received Power) (dBm) SS-RSRQ (Synchronization Signal Reference Signal Received Quality) (dB) RSSI (Reference Signal Strength Indicator) (dBm) PSS Power (Primary Synchronization Signal Power) (dBm) SSS Power (Secondary Synchronization Signal Power) (dBm) PBCH Power (Physical Broadcast Channel Power) (dBm) PCBCH DMRS Power (Physical Broadcast Channel Demodulation Reference Signal Power) (dBm)	
Signal bandwidth	Up to 100 MHz (Requires Option B10)	
Component carrier	CC0 to CC7 (5G NR Over-the-Air (OTA) measurements) CC0 to CC4 (5G NR conducted EVM measurements)	
Data formats	User can set up and display 1, 2, 3 or 4 simultaneous measurements of key performance indicators (KPI's) for any component carrier, in any combination of the following ¹ :	
	Table	Cell scan numeric results (for up to 6 cell sites (ID's))
	Bar chart	Vertical power bar graph of selectable cell scan results for up to 6 cell sites with adjustable color "heat" amplitude scale
	Spectrum	Magnitude spectrum frequency domain (fixed span)
	Strip chart	Magnitude of selectable cell scan results graphed over time
Window configuration	Any combination of 1, 2, 3, or all 4 windows can be displayed simultaneously: 1, 2 (top & bottom), 3 (one top, two bottom), or 4 (quad display)	

¹ You can also display the results from multiple component carriers on the table, bar chart, and strip chart displays.

Setup parameters

5G NR Over-the-Air (OTA)	
Frequency error threshold	0 Hz to 7.5 kHz ¹
Subcarrier spacing	15 kHz, 30 kHz, 120 kHz, 240 kHz
SSB case	Auto, A, B, C, D, E
Lmax	Auto, 4, 8, 64
Capture length	4, 8, 16, 24, 32 or 40 frames
Drive speed	Low, medium, high
SS Meas DMRS	Off, On
Phase compensation	Off, On
EMF Measurement	Off, On
EMF Units	dB μ V/m, V/m
5G NR Conducted EVM	
Cell ID	Auto, Manual
Bandwidth	FR1: 5, 10, 15, 20, 25, 30, 40, 50, 60, 70, 80, 90, 100 MHz FR2: 50, 100 MHz
Subcarrier spacing	15 kHz, 30 kHz, 120 kHz, 240 kHz
Export results	Exports SSB center frequency, SSB subcarrier spacing, SSB Case and SSB Lmax to 5G NR OTA setup
Trigger	
Trigger type	Free run, external, periodic trigger
Record/Playback	
Data logging	Record, recall and playback data for all component carrier(s)
Record settings	Meas Interval, Interval type (time or distance), time interval, distance interval
Supported file types	CSV, KML
Saving data	Save/recall recorded data logs to/from internal memory or external USB or SD card

¹ The frequency error threshold is dependent on the SCS - freq err threshold = +/- 1/4 * SCS (e.g. for 15 kHz, freq err threshold = 3.75 kHz).

Indoor and Outdoor Mapping (Option 352)

The performance listed in this section applies to the indoor and outdoor mapping capabilities available in the following models:

Description	Model number
FieldFox RF & microwave (combination) analyzers:	N9913B ¹ , N9914B ¹ , N9915B ¹ , N9916B, N9917B, N9918B
FieldFox RF & microwave signal analyzers:	N9933B ¹ , N9934B ¹ , N9935B ¹ , N9936B, N9937B, N9938B
FieldFox microwave (combination) analyzers:	N9950B, N9951B, N9952B, N9953B
FieldFox microwave signal analyzers:	N9960B, N9961B, N9962B, N9963B

See [FieldFox Configuration Guide](#) for option information. Many capabilities listed in this Data Sheet require options.

Option 352 adds indoor and outdoor mapping capability to FieldFox analyzers, so that FieldFox can import maps from OpenStreetMap (OSM) for data collection and data plotting to the map directly on the FieldFox instrument display. The FieldFox indoor and outdoor mapping feature resides at the System level and the mapping capability can be enabled within the following modes:

- Channel Scanner (Option 312)
- Phased Array Antenna Support (Option 360)
- Over-the-Air (OTA) LTE FDD/TDD (Option 370/371)
- Over-the-Air (OTA) 5GTF (Option 377)
- Over-the-Air (OTA) 5G NR (Option 378)
- Indoor and outdoor mapping (Option 352) requirements:
- Spectrum analyzer mode (Option 233 on N991xB/N995xB, default mode on N993xB/N996xB)
- GPS receiver (Option 307), required for outdoor mapping
- OSM maps can be saved to the FieldFox internal memory, SD card or USB drive. This can be done via a direct wired LAN connection or OSM maps can be downloaded and saved to FieldFox using the [FieldFox Map Support Tool](#).

	Description
Map coordinates	Latitude, longitude
Map zoom levels	4 to 17
Map icons	Flag, point, line
Map labels	On, Off
Map panorama	North, South, East, West
Data logging	Record, recall and playback
Indoor map file type	PNG

Using a direct wired LAN connection, FieldFox will automatically access OSM once location coordinates (latitude and longitude) and zoom levels are entered the Map Explorer menu. If using the FieldFox Map Support Tool, OSM map files can be downloaded to a .zip file and imported to FieldFox internal memory.

¹ Discontinued and replaced by corresponding Keysight N99xxC Series FieldFox.

If the FieldFox GPS receiver is enabled and OSM maps have been previously saved to FieldFox with those GPS coordinates, FieldFox can automatically load the corresponding map to match the GPS coordinates.

EMF Measurements (Option 358)

Description	Model number
FieldFox RF & microwave (combination) analyzers:	N9913B ¹ , N9914B ¹ , N9915B ¹ , N9916B, N9917B, N9918B
FieldFox RF & microwave signal analyzers:	N9933B ¹ , N9934B ¹ , N9935B ¹ , N9936B, N9937B, N9938B
FieldFox microwave (combination) analyzers:	N9950B, N9951B, N9952B, N9953B
FieldFox microwave signal analyzers:	N9960B, N9961B, N9962B, N9963B

	Description
Supported antenna	AGOS Advanced Technologies, Triaxial Isotropic Antenna Model: SDIA-6000 (or, 85572A-006 if ordered directly from Keysight) Frequency coverage: 30 MHz to 6 GHz Schwarzbeck, Triaxial antenna Model: FSH3D Frequency Range: 9 kHz-200 MHz
Supported operating modes	Spectrum analyzer: 4 traces (active, min, max and average) and standard (limit) Channel scanner: average table view: average, min, max, standard Over-the-Air (OTA) 5G NR, LTE FDD/TDD 89601C VSA
Antenna axis	Average all (Isotropic), X-axis, Y-axis, Z-axis
Measurement	Field Strength, Power Flux Density, Spectrum View (spectrum analyzer mode) EMF total value EMF values reported As % of limit line (linear unit) EMF Table View (Segmented Spectrum Table) EMF values reported by segment (% of total) EMF values reported as % of reference channel (total band) Pass/Fail testing according to user defined limits
Units	Spectrum analyzer mode: dBuV/m, dBm/m ² , V/m, Watt/cm ² , W/m ² , dBµA/m, dBG, dBpT Over-the-Air (OTA) 5G NR, LTE FDD/TDD mode: V/m, dBµV/m
Measurement time	Live Continuous User Defined Time Average User Defined Spatial Average
Channel and band configuration	Support for user defined band configuration (segmented spectrum) Start/Stop Frequency, RBW, Display Units Averaging Method: time, spatial (number of averages) Support for user defined limit lines All configuration files are stored internally or uploaded from external PC
Data logging	Record, recall and playback data, save trace and state, GPS
Limit line	Name, start/stop frequencies for each segment, upper and lower limits, unit (E field and H field), range in % (actual value to limit ratio at each frequency point or channel or band), limit line saved as csv format. Multiple limits (csv files) can be uploaded.

¹ Discontinued and replaced by corresponding Keysight N99xxC Series FieldFox.

Average	Duration in time and spatial in number of average points / captures or manual incremental mode using single sweep
Supported file types	Spectrum analyzer mode: CSV Limit Lines: CSV Channel scanner and table view: CSV Over-the-Air (OTA) 5G NR, LTE FDD/TDD mode: CSV, KML
Saving data	Save/recall recorded data logs to/from internal memory or external USB or SD card Upload/download logs, CSV, screen capture with FieldFox DataLink Software

Measurement uncertainty ^{1,2}	
Frequency range	Amplitude uncertainty (-10 ⁰ to +55 ⁰ C)
9 kHz – 100 kHz ³	± 2.86 dB
100 kHz – 30 MHz ³	± 2.71 dB
30 MHz – 500 MHz ⁴	± 2.71 dB
500 MHz – 6 GHz ⁴	± 2.73 dB

¹ Uncertainty values are stated for conditions where FieldFox pre-amp is either enabled or disabled.

² Total uncertainty includes FieldFox, antenna, 1m RF cable and associated connectors.

³ Schwarzbeck FSH3D antenna utilized 9 kHz to 30 MHz.

⁴ Keysight 85572A antenna utilized 30 MHz to 6 GHz.

AM/FM Analog demodulation, Tune and Listen (Option 355)

The performance listed in this section applies to the AM/FM analog demodulation, tune and listen capabilities available in the following models:

Description	Model number
FieldFox RF & microwave (combination) analyzers:	N9913B ¹ , N9914B ¹ , N9915B ¹ , N9916B, N9917B, N9918B
FieldFox RF & microwave signal analyzers:	N9933B ¹ , N9934B ¹ , N9935B ¹ , N9936B, N9937B, N9938B
FieldFox microwave (combination) analyzers:	N9950B, N9951B, N9952B, N9953B
FieldFox microwave signal analyzers:	N9960B, N9961B, N9962B, N9963B

See [FieldFox Configuration Guide](#) for option information. Many capabilities listed in this Data Sheet require options.

	Description
Display type	RF spectrum view, demodulated waveform, including peak+ and peak- traces
Audio demodulation type	AM, FM narrow, FM wide, SSB and CW (Morse code), listen to the tones using FieldFox's built-in speaker or headphones
Audio bandwidth	16 kHz
Measurement type	RF carrier power (dBm), RF carrier frequency (Hz), modulation rate (Hz), SINAD (dB), THD (%)
AM & FM metrics	Nominal
SINAD	2.5 dB to 65 dB
THD	0 to 75%
AM measurements	Nominal
Maximum modulation rate	5 kHz, demod sweep time: 50 μ s to 50 ms
Depth	(peak-to-peak/2) (%), \pm peak depth (%)
Depth accuracy	\pm 2%
Depth range	Modulation: 0.1% to 99%
FM measurements	Nominal
Maximum modulation rate	5 kHz, demod sweep time: 50 μ s to 50 ms
Frequency deviation	(Hz), \pm peak deviation (Hz)
Maximum deviation	5 MHz (nominal)
Audio record/playback	
	Record audio into WAV file with time stamp and geo tag and playback on PC

Radio standards

With a radio standard applied, pre-defined frequency bands, channel numbers or uplink / downlink selections can be used instead of manual frequency entry. The pre-defined FieldFox radio standards include bands such as W-CDMA, LTE, and GSM. Alternately, users can create custom standards and import them into FieldFox analyzers.

¹ Discontinued and replaced by corresponding Keysight N99xxC Series FieldFox.

Spectrum Analyzer Time Gating (Option 238)

With time gating, you can measure the spectrum of a periodic signal during a specified time interval. Pulsed-RF signals are an example of a periodic signal that can be measured with time gating. For example, you can measure the pulse during the on period, not the transition or the off period. Or you can exclude interfering signals such as a periodic transient. Time gating allows you to view spectral components that would otherwise be hidden. FieldFox's time gating method is a Gated FFT.

	Description
Gate method	Gated FFT
Span range	Any span
RBW range	1 Hz to 300 kHz (derived from gate width)
Gate delay range	-150 ms to 10 s
Gate width (length) range	6 μ s to 1.8 s
Gate sources	External, RF burst, Video

Reflection Measurements (RL, VSWR) (Option 320, applicable to SA only models)

The performance listed in this section applies to the reflection measurements capabilities available in the following models:

Description	Model number
FieldFox RF & microwave spectrum analyzers:	N9933B ¹ , N9934B ¹ , N9935B ¹ , N9936B, N9937B, N9938B
FieldFox microwave signal analyzers	N9960B, N9961B, N9962B, N9963B

See [FieldFox Configuration Guide](#) for option information. Many capabilities listed in this Data Sheet require options.

	Models	Reflection measurements
N993xB	N9933B ¹	30 kHz to 4 GHz
	N9934B ¹	30 kHz to 6.5 GHz
	N9935B ¹	30 kHz to 9 GHz
	N9936B	30 kHz to 14 GHz
	N9937B	30 kHz to 18 GHz
	N9938B ²	30 kHz to 26.5 GHz
N996xB	N9960B	300 kHz to 32 GHz
	N9961B	300 kHz to 44 GHz
	N9962B	300 kHz to 50 GHz
	N9963B	300 kHz to 54 GHz
Measurements		
Return loss, VSWR normalization using data/memory (requires Option 220 tracking generator)		

¹ Discontinued and replaced by corresponding Keysight N99xxC Series FieldFox.

² Reflection measurements in N9938B specifically require 3.5 mm (m) test ports (Option 100) instead of the standard Type-N (f)

Extended Range Transmission Analysis (ERTA) (Option 209)

ERTA specifications apply to the following FieldFox models. The RF & microwave analyzers must be equipped with the spectrum analyzer option.

Description	Model number
FieldFox RF & microwave (combination) analyzers:	N9913B ¹ , N9914B ¹ , N9915B ¹ , N9916B, N9917B, N9918B
FieldFox RF & microwave signal analyzers:	N9933B ¹ , N9934B ¹ , N9935B ¹ , N9936B, N9937B, N9938B
FieldFox microwave (combination) analyzers:	N9950B, N9951B, N9952B, N9953B
FieldFox microwave signal analyzers:	N9960B, N9961B, N9962B, N9963B

ERTA operation requires two FieldFox units, each one configured with specific options, and certain accessories. See [FieldFox Configuration Guide](#) for option information. Many capabilities listed in this Data Sheet require options.

System description

ERTA can be used to measure the scalar transmission gain or loss of an RF system. It is useful when measuring long lossy cables where the two ends cannot easily be brought together, such as those bolted in on ships or aircrafts. It is also useful in measuring the insertion loss of waveguide systems, or using the frequency-offset feature, devices such as mixers and converters.

ERTA measurements are based on two FieldFox units; one at each end of the measured DUT. One FieldFox is the source and reference receiver (R), while the other is the measurement receiver (B). The two FieldFox units are synchronized using hardware triggering. By taking advantage of FieldFox's InstAlign technique, ERTA can be used to make accurate gain or loss measurements.

¹ Discontinued and replaced by corresponding Keysight N99xxC Series FieldFox.

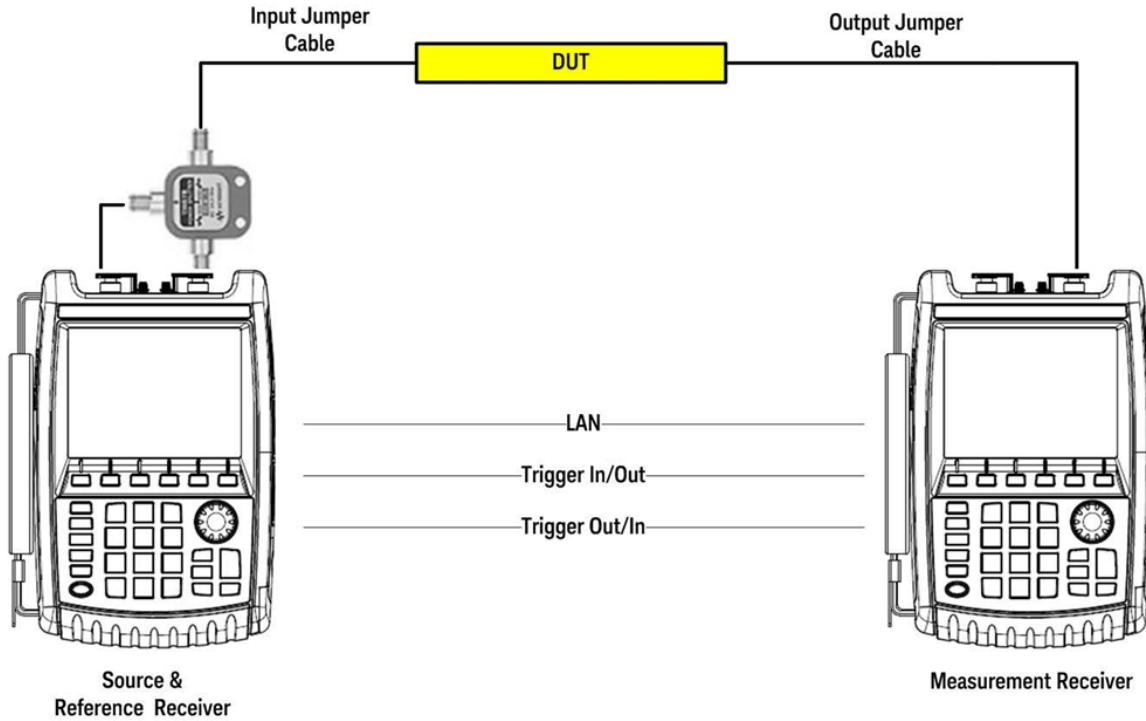

Frequency specifications

The ERTA frequency range is limited by each individual analyzer's frequency range.

	Models	Source frequency range	Receiver frequency range ¹
N991xB, N993xB	N9913B ² , N9933B ²	30 kHz to 4 GHz	9 kHz to 4 GHz
	N9914B ² , N9934B ²	30 kHz to 6.5 GHz	9 kHz to 6.5 GHz
	N9915B ² , N9935B ²	30 kHz to 9 GHz	9 kHz to 9 GHz
	N9916B, N9936B	30 kHz to 14 GHz	9 kHz to 14 GHz
	N9917B, N9937B	30 kHz to 18 GHz	9 kHz to 18 GHz
N995xB, N996xB	N9918B, N9938B	30 kHz to 26.5 GHz	9 kHz to 26.5 GHz
	N9950B, N9960B	300 kHz to 32 GHz	9 kHz to 32 GHz
	N9951B, N9961B	300 kHz to 44 GHz	9 kHz to 44 GHz
	N9952B, N9962B	300 kHz to 50 GHz	9 kHz to 50 GHz
	N9953B, N9963B	300 kHz to 54 GHz	9 kHz to 54 GHz

Frequency reference

Refer to the frequency accuracy specifications

Source output power

Refer to the test port output power typical data

¹ The receiver (spectrum analyzer) is usable to 5 kHz, though only specified to 9 kHz.

² Discontinued and replaced by corresponding Keysight N99xxC Series FieldFox.

Frequency setup parameters

Receiver frequency	Center/span or start/stop (standard spectrum analyzer settings). Reverse receiver sweep direction (default direction is forward, but can be set to reverse).
Source frequency [Remote]	[Tracking] – FieldFox source tracks the receiver by default. The frequencies are identical. [CW] – FieldFox's source can be set to a CW frequency independent of FieldFox's receiver frequency. FieldFox's source is at a single CW frequency; FieldFox's receiver is swept. [Coupled CW] – FieldFox's source CW frequency is auto-coupled to FieldFox's receiver [Center Frequency] setting.

Frequency-offset capability

This feature allows the FieldFox's source frequency to be offset from FieldFox's receiver frequency. The offset frequency can be negative, zero, or positive. The frequency-offset capability is useful when characterizing the scalar transmission response of devices such as mixers and converters.

Frequency-offset setup parameters

Receiver frequency	Center/span or start/stop (standard spectrum analyzer settings) Reverse receiver sweep direction (default direction is forward, but can be set to reverse)
Frequency tracking offset	On/Off Offset values: 0, > 0, < 0
Receiver sweep direction	Reversal: Off Default setting Both source and receiver sweep in the forward direction. Receiver stop frequency > Receiver start frequency Source frequency = Offset + Receiver frequency Reversal: On Source and receiver sweep in opposite directions. Source frequency = Offset – Receiver frequency Offset > receiver frequency

Dynamic range and maximum attenuation

Dynamic range is the difference between the maximum output power available from FieldFox's source and the noise floor of the second FieldFox, while ensuring that neither FieldFox's ADC goes into over-range. Dynamic range also accounts for the loss of the power splitter. Dynamic range is applicable when testing devices such as filters, where there is low loss in the passband, and significant loss in the stopband, and both passband and stopband need to be on the display at the same time (same sweep).

Maximum attenuation is the difference between maximum output power available from FieldFox's source and the noise floor of FieldFox. It also accounts for the loss of power splitter. Maximum attenuation is applicable when testing devices such as cables, which have relatively uniform loss over the swept frequency range.

The values shown are based on the recommended minimum RBW of 3 kHz when the frequency references are locked via GPS, and 300 kHz when the frequency references are unlocked. Locking the frequency references to GPS allows for greater frequency accuracy of the FieldFox units and use of a

narrower RBW, which in turn results in a lower DANL, and hence a wider measurement range. When the GPS signals cannot be present at all times, the GPS hold-over mode can be used.

Dynamic range (dB)	Typical			
	N991xB, N993xB		N995xB, N996xB	
	Preamp OFF	Preamp ON	Preamp OFF	Preamp ON
	Frequency references locked to GPS, RBW 3 kHz	Frequency references locked to GPS, RBW 3 kHz	Frequency references unlocked, RBW 300 kHz	Frequency references unlocked, RBW 300 kHz
> 2 MHz ¹ to 6 GHz	88	83	68	63
> 6 to 13 GHz	86	83	66	63
> 13 to 22 GHz	70	86	50	66
> 22 to 25 GHz	63	83	43	63
> 25 to 26.5 GHz	58	77	38	57
Maximum attenuation (dB)				
	Preamp OFF	Preamp ON	Preamp OFF	Preamp ON
	Frequency references locked to GPS, RBW 3 kHz	Frequency references locked to GPS, RBW 3 kHz	Frequency references unlocked, RBW 300 kHz	Frequency references unlocked, RBW 300 kHz
> 2 MHz to 6 GHz	93	108	73	88
> 6 to 13 GHz	86	103	66	83
> 13 to 22 GHz	70	91	50	71
> 22 to 25 GHz	63	83	43	63
> 25 to 26.5 GHz	58	77	38	57
	Preamp OFF	Preamp ON	Preamp OFF	Preamp ON
	Frequency references locked to GPS, RBW 3 kHz	Frequency references locked to GPS, RBW 3 kHz	Frequency references unlocked, RBW 300 kHz	Frequency references unlocked, RBW 300 kHz
> 2 to 5 MHz	83	87	62	58
> 5 MHz to 11 GHz	93	97	69	68
> 11 to 19 GHz	95	96	71	70
> 19 to 22 GHz	93	94	69	68
> 22 to 40 GHz	88	90	63	65
> 40 to 43 GHz	82	89	57	64
> 43 to 46 GHz	81	93	56	68
> 46 to 50 GHz	77	88	52	63

¹ Dynamic range is decreased from 3 to 9 dB at 2 MHz

Dynamic range (dB)	Typical				
	N995xB, N996xB	Preamp OFF	Preamp ON	Preamp OFF	Preamp ON
		Frequency references locked to GPS, RBW 3 kHz	Frequency references locked to GPS, RBW 3 kHz	Frequency references unlocked, RBW 300 kHz	Frequency references unlocked, RBW 300 kHz
> 2 MHz to 13 GHz		100	113	74	88
> 13 to 18 GHz		101	110	76	85
> 18 to 22 GHz		99	108	74	83
> 22 to 35 GHz		95	105	70	80
> 35 to 40 GHz		88	100	63	75
> 40 to 46 GHz		81	93	56	63
> 46 to 50 GHz		77	88	52	63

Absolute power and gain measurement uncertainties

Verified with input level of -10 dBm, peak detector, 10 dB attenuation, preamplifier off, all settings auto-coupled, no warm-up required. Includes frequency response uncertainties. Assumes an ERTA system using a Keysight 11667A, 11667B, or 11667C power splitter.

Input power (R) measurements uncertainty, 30 kHz RBW (dB)

N991xB and N993xB	Spec (23 ± 5 °C)	Spec (-10 to 55 °C)	Spec (23 ± 5 °C)	Spec (-10 to 55 °C)
100 kHz to 18 GHz	±1.10	±1.30	±0.40	±0.50
> 18 to 26.5 GHz	±1.40	±1.50	±0.50	±0.60

Output power (B) measurement uncertainty, frequency references locked to GPS, RBW ≥ 3 kHz (dB)

100 kHz to 18 GHz	±1.00	±1.20	±0.40	±0.50
> 18 to 26.5 GHz	±1.20	±1.40	±0.50	±0.60

Output power (B) measurement uncertainty, frequency references unlocked, RBW ≥ 300 kHz (dB)

100 kHz to 18 GHz	±1.00	±1.30	±0.40	±0.50
> 18 to 26.5 GHz	±1.40	±1.60	±0.50	±0.60

Gain/Loss (B/R) measurement uncertainty, frequency references locked to GPS, RBW ≥ 3 kHz (dB)

100 kHz to 18 GHz	±1.30	±1.70	±0.60	±0.70
> 18 to 26.5 GHz	±1.70	±2.10	±0.70	±0.90

Gain/Loss (B/R) measurement uncertainty, frequency references unlocked, RBW ≥ 300 kHz (dB)

100 kHz to 18 GHz	±1.40	±1.70	±0.70	±0.70
> 18 to 26.5 GHz	±2.00	±2.10	±0.90	±1.00

Input power (R) measurements uncertainty, 30 kHz RBW (dB)

N995xB and N996xB	Spec (23 ± 5 °C)	Spec (-10 to 55 °C)	Spec (23 ± 5 °C)	Spec (-10 to 55 °C)
2 MHz to 18 GHz	±1.10	±1.30	±0.50	±0.60
> 18 to 32 GHz	±1.20	±1.50	±0.50	±0.70
> 32 to 40 GHz	±1.30	±1.80	±0.60	±0.80
> 40 to 43 GHz	±1.60	±2.30	±0.70	±1.10
> 43 to 50 GHz	±1.70	±3.20	±0.80	±1.40

Output power (B) measurement uncertainty, frequency references locked to GPS, RBW ≥ 3 kHz (dB)

2 MHz to 18 GHz	±0.40	±1.00	±0.40	±0.50
> 18 to 32 GHz	±0.45	±1.30	±0.40	±0.60
> 32 to 40 GHz	±0.50	±1.50	±0.50	±0.70
> 40 to 43 GHz	±0.80	±2.30	±0.70	±1.00
> 43 to 50 GHz	±0.90	±3.00	±0.80	±1.40

Output power (B) measurement uncertainty, frequency references unlocked, RBW ≥ 300 kHz (dB)

2 MHz to 18 GHz	±1.00	±1.10	±0.40	±0.50
> 18 to 32 GHz	±1.20	±1.50	±0.50	±0.60
> 32 to 40 GHz	±1.60	±1.90	±0.60	±0.80
> 40 to 43 GHz	±2.10	±2.50	±0.70	±1.30
> 43 to 50 GHz	±2.60	±3.60	±1.00	±1.00

Gain/Loss (B/R) measurement uncertainty, frequency references locked to GPS, RBW ≥ 3 kHz (dB)

2 MHz to 18 GHz	±1.40	±1.70	±0.60	±0.70
> 18 to 32 GHz	±1.50	±2.00	±0.70	±0.90
> 32 to 40 GHz	±1.60	±2.30	±0.80	±1.00
> 40 to 43 GHz	±2.20	±3.10	±1.00	±1.40
> 43 to 50 GHz	±2.40	±4.00	±1.20	±1.90

Gain/Loss (B/R) measurement uncertainty, frequency references unlocked, RBW ≥ 300 kHz (dB)

2 MHz to 18 GHz	±1.40	±1.70	±0.70	±0.70
> 18 to 32 GHz	±1.80	±2.10	±0.80	±1.00
> 32 to 40 GHz	±2.10	±2.80	±1.00	±1.30
> 40 to 43 GHz	±2.70	±3.50	±1.40	±1.70
> 43 to 50 GHz	±3.00	±4.80	±1.60	±2.40

Cable correction

Input and output jumper cable losses can be accounted for using ERTA's cable correction wizard.

The performance listed in built-on power meter, external USB power sensor support, pulse measurements, USB power sensor measurements versus frequency sections applies to the capabilities available in the following models:

Description	Model number
FieldFox RF & microwave (combination) analyzers:	N9913B ¹ , N9914B ¹ , N9915B ¹ , N9916B, N9917B, N9918B
FieldFox RF & microwave signal analyzers:	N9933B ¹ , N9934B ¹ , N9935B ¹ , N9936B, N9937B, N9938B
FieldFox microwave (combination) analyzers:	N9950B, N9951B, N9952B, N9953B
FieldFox microwave signal analyzers:	N9960B, N9961B, N9962B, N9963B

See [FieldFox Configuration Guide](#) for option information. Many capabilities listed in this Data Sheet require options.

Built-in Power Meter (Option 310)

Using the built-in power meter, FieldFox is able to make very accurate channel power measurements. The channel bandwidth can be set wide to simulate average power meter measurements. This measurement function provides the flexibility to make user definable channel power measurements.

	Description		
Setup parameters	Center frequency, including selection of radio standards and channel selection, span or channel width		
Functions	Relative/absolute measurements, offsets, units of dBm or Watts, or dB or %, minimum and maximum limits		
	Models	Frequency range	
N991xB, N993xB	N9913B ¹ N9933B ¹	9 kHz to 4 GHz	Usable to 5 kHz
	N9914B ¹ , N9934B ¹	9 kHz to 6.5 GHz	Usable to 5 kHz
	N9915B ¹ , N9935B ¹	9 kHz to 9 GHz	Usable to 5 kHz
	N9916B, N9936B	9 kHz to 14 GHz	Usable to 5 kHz
	N9917B, N9937B	9 kHz to 18 GHz	Usable to 5 kHz
	N9918B, N9938B	9 kHz to 26.5 GHz	Usable to 5 kHz
N995xB, N996xB	N9950B, N9960B	9 kHz to 32 GHz	Usable to 5 kHz
	N9951B, N9961B	9 kHz to 44 GHz	Usable to 5 kHz
	N9952B, N9962B	9 kHz to 50 GHz	Usable to 5 kHz
	N9953B, N9963B	9 kHz to 54 GHz	Usable to 5 kHz

¹ Discontinued and replaced by corresponding Keysight N99xxC Series FieldFox.

Total absolute amplitude accuracy (dB)

10 dB attenuation, input signal -15 to -5 dBm, peak detector, 300 Hz RBW, all settings auto-coupled, includes frequency response uncertainties. No warm-up required.

N991xB, N993xB		Spec (-10 to 55 °C)	Typical (-10 to 55 °C)
	9 kHz to 100 kHz	±2.00	±0.25
> 100 kHz to 500 MHz	±0.80	±0.20	
> 500 MHz to 16.3 GHz	±1.00	±0.20	
> 16.3 to 18 GHz	±1.00	±0.30	
> 18 GHz to 26.5 GHz	±1.10	±0.35	

N995xB, N996xB		Spec (-10 to 55 °C)	Typical (-10 to 55 °C)
	9 to 500 kHz	±2.50	±0.79
> 500 kHz to 15 MHz	±1.10	±0.38	
> 15 MHz to 18 GHz	±1.10	±0.18	
> 18 to 26.5 GHz	±1.20	±0.21	
> 26.5 to 32 GHz	±1.50	±0.30	
> 32 to 36 GHz	±1.90	±0.33	
> 36 to 44 GHz	±1.90	±0.34	
> 44 to 50 GHz	±1.90	±0.35	
> 50 to 54 GHz	±3.50	±0.73	

External USB Power Sensor Support (Option 302)

The external USB power sensor option supports various Keysight USB power sensors. For an up-to-date listing of the supported power sensors, visit <http://www.keysight.com/find/fieldfoxsupport>

	Description
Setup parameters	Frequency
Functions	Relative/absolute measurements, offsets, units of dBm or Watts, or dB or %, minimum and maximum limits.
Internal source	FieldFox's internal source can be turned on in the USB power sensor mode. CW frequency and nominal power level control are available.

Pulse Measurements (Option 330)

FieldFox's pulse measurement option can be used to characterize RF pulses such as those used in radar and electronic warfare systems. Measurements are made using FieldFox and Keysight's USB peak power sensors.

Performance specifications such as frequency, dynamic range and minimum pulse width depend on the peak power sensor. Supported peak power sensors: <http://www.keysight.com/find/fieldfoxsupport>

	Description
Setup parameters	Frequency, time (center), time/division, gating, triggering, video bandwidth, averaging Average power, peak power, and peak to average ratio Analog gauge display and digital display, dBm and Watts
Functions	Relative/absolute measurements, offset, dB or %, minimum and maximum limits Trace graph for pulse profiling with gating Rise time, fall time, pulse width, pulse period, pulse repetition frequency

USB Power Sensor Measurements versus Frequency (Option 208)

This feature allows FieldFox's source frequency to be set independently from the power sensor (receiver) frequency. With frequency-offset using power sensor (FOPS), the frequency of both the source and receiver are swept, and the two track each other. The offset frequency can be negative, zero, or positive.

FOPS can be used to characterize the scalar transmission response of devices such as mixers and converters. This frequency-offset capability is necessary for conversion loss/gain measurements on frequency-translating devices, since, by definition, the input and output frequencies of the DUT are different. The FieldFox source stimulates the DUT and the power sensor is used as the measurement receiver.

Since power sensors are inherently broadband devices (not frequency-selective), the user should ensure that only the signal of interest is present at the power sensor input and that all other signals are filtered appropriately.

Setup parameters

Source frequency	Center/span or start/stop
Receiver frequency	Range determined by power sensor range
Frequency offset	Positive offset or negative offset
Frequency step size	30 kHz minimum
Number of points	2 to 1601 (Combination of number of points and frequency step size limited by span.)
Dwell time/point	0 to 1.0 sec

Source frequency span must be equal to receiver frequency span.

Receiver sweep direction: forward (default setting) or reverse.

For some DUTs, the output frequency may sweep in a reverse direction, as compared to the source frequency. The basic relationships between the source, receiver and offset frequencies are shown in the table below. The FieldFox analyzer includes an offset calculator that ensures a fast measurement setup.

Src sweep direction	Rx sweep direction	Frequency calculations
Forward $f_{2src} > f_{1src}$	Forward $f_{2rx} > f_{1rx}$	Receiver frequency = Source frequency \pm Offset
Forward $f_{2src} > f_{1src}$	Reverse $f_{2rx} > f_{1rx}$	Receiver frequency = Offset - Source Frequency Offset > Source frequency

	Description
Measurements	Source power, gain/loss and receiver (Rx) power Gain = Rx power / source power (memory). Source power (memory) is measured during setup.
Output power	Refer to the test port output power typical data on page 5.
Dynamic range	The dynamic range with FOPS is dependent on FieldFox's output power and the power sensor's dynamic range. Supported USB power sensors: www.keysight.com/find/fieldfoxsupport

The graph below shows a filter measurement using two different power sensors, the U2002A (- 60 to +20 dBm) and the U2021XA (- 45 to +20 dBm). While a filter is not commonly measured using FOPS, it is a useful device for demonstrating dynamic range.

For both measurements, the FieldFox source power was set to - 1 dBm, the maximum available in the selected frequency range of 7.25 to 13.25 GHz. An external amplifier was not used in this case, but one can be added to increase the source power and hence dynamic range.

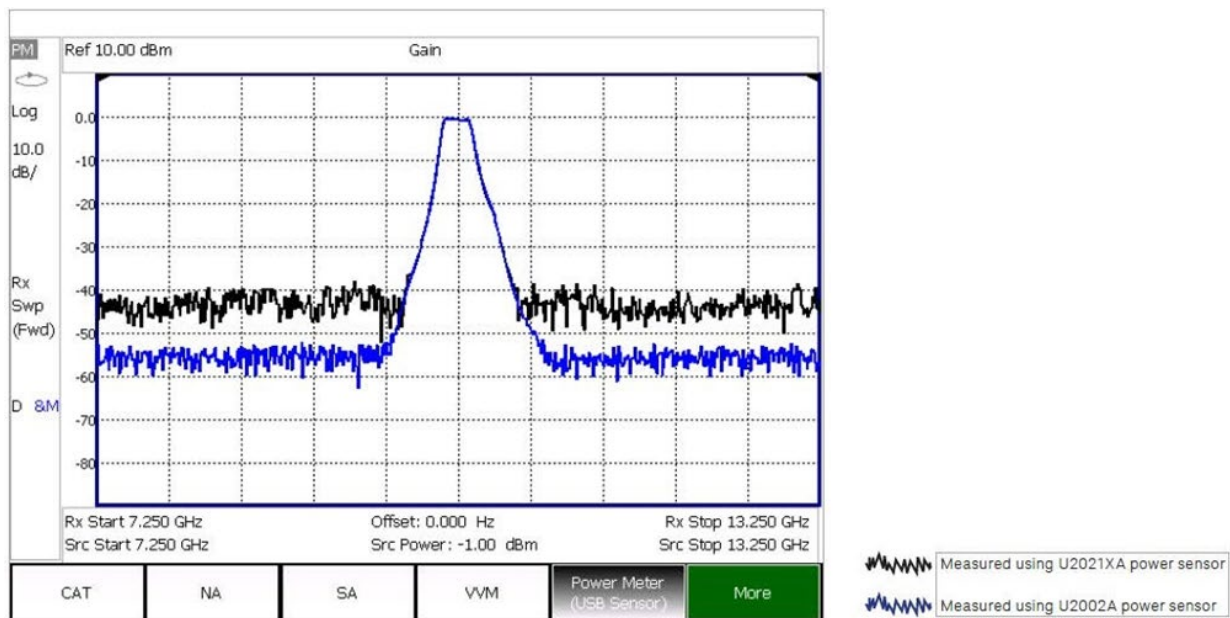

Figure 1. Example showing typical dynamic range of FOPS

Built-In GNSS (GPS+) Receiver (Option 307)

	Description
GNSS (GPS+) receiver	The internal GNSS/GPS receiver can be used as a frequency reference. ¹
Supported systems	GPS, GLONASS, BeiDou and Galileo
Modes	Off, internal, external
Sync clock	On, off
Functionality	Geo-location: latitude, longitude, altitude (elevation), time, sync time/date Requires external GNSS/GPS antenna (can use N9910X-825, GPS active antenna)
Connector for antenna	SMA (f), 3.3 or 5 V
Maximum DC current	20 mA

DC Bias Variable-Voltage Source (Option 309)

	Description
Connector	SMB (m)
Voltage	+1 to +32 V (nominal)
Resolution	0.1 V (nominal)
Maximum current	0.65 A (nominal)
DC current readout resolution	0.01 (nominal)A
Maximum power ²	7 watts (nominal)
Display read out	Voltage, current
Overload trip protection	Automatically engages when voltage source is on. The trip circuit can be reset from front panel without pre-setting or power cycling the analyzer.

¹ External GPS USB receivers can be used to provide geo-location data. However, they cannot be used for frequency reference locking.

² Battery life will be reduced when DC source is used. A trip function turns off the power supply when the rated current or power is exceeded.

Remote Control Capability (Option 030)

Option 030 adds remote control capability to FieldFox analyzers, so that FieldFox can be controlled via an iOS device, or an Android device. The FieldFox app, running on the iOS/Android device, combined with Option 030 on the FieldFox analyzer provides full control of the instrument from a remote location. The app emulates the front panel of FieldFox, so users can press the FieldFox hard keys or softkeys using their iPhone/iPad, or Android mobile device and make measurements remotely. For example, a tower climber can be on the tower with a FieldFox analyzer, while the technician controls and makes the measurements down below, using an iPad. The iPad and FieldFox communicate via a network connection.

iOS device requirements	Android device requirements
iPad, iPhone, or iPod Touch	Android phone, tablet PC
iOs of 6.1 or higher	Android OS of 9.0 or higher
A WiFi or cellular network connection	A WiFi or cellular network connection

The FieldFox app communicates with FieldFox via a network connection, so both the iOS/Android device and FieldFox need to be on a network where both devices can reach the other. For example, a company intranet or a site installation using a wireless router. FieldFox can directly be connected to a LAN cable, or if wired LAN is not available, a user supplied wireless router can be configured to work with FieldFox. FieldFox does not include a wireless router.

FieldFox app without Option 030

The FieldFox app can be installed on an iOS or an Android device independent of the presence of Option 030 on the analyzer. Without Option 030, users can view the live display screen of their FieldFox remotely but cannot control the instrument. With 030 purchased and installed on their FieldFox, users can both view and control their FieldFox. Control refers to the ability to press hard keys, softkeys, make or change measurements, etc. Option 030 does not include the iOS or the Android device itself. Users must supply their own iOS or Android device. Option 030 is a license on the FieldFox analyzer. Option 030 and the FieldFox app are not applicable to BlackBerry, or Windows phone/tablet devices. FieldFox can be remotely controlled via PC software using a wireless or wired LAN connection. FieldFox Data Link software provides a remote display tool with a virtual keypad that allows remote access to the FieldFox display (Option 030 not required).

EMI measurements (Option 361)

	Description
Frequency range	Same as spectrum analyzer frequency range
Number of traces	4, each trace can be configured with individual trace mode and detector type
Trace mode	Max hold, Min, Clear/Write, View and blank. (Average is implemented as EMI average detector)
Detector	Positive Peak, Quasi-Peak, EMI average
CISPR bandwidth	200 Hz, 9 kHz, 120 kHz, 1MHz
Measurements	Frequency scan, CISPR 16-1-1 Amplitude probability distribution (APD)

Pulse Generator (Option 357)

Using the built-in pulse generator, FieldFox is transformed into a handheld signal generator which generates a variety of user-definable pulse sequences and continuous-wave signals with or without analog modulation up to 54 GHz.

Description	Model number
FieldFox RF & microwave (combination) analyzers:	N9913B ¹ , N9914B ¹ , N9915B ¹ , N9916B, N9917B, N9918B
FieldFox RF & microwave signal analyzers:	N9933B ¹ , N9934B ¹ , N9935B ¹ , N9936B, N9937B, N9938B
FieldFox microwave (combination) analyzers:	N9950B, N9951B, N9952B, N9953B
FieldFox microwave signal analyzers:	N9960B, N9961B, N9962B, N9963B

See [FieldFox Configuration Guide](#) for option information. Many capabilities listed in this Data Sheet require options.

	Models	Signal source output frequency range ²
N991xB, N993xB	N9913B ¹ , N9933B ¹	30 kHz to 4 GHz
	N9914B ¹ , N9934B ¹	30 kHz to 6.5 GHz
	N9915B ¹ , N9935B ¹	30 kHz to 9 GHz
	N9916B, N9936B	30 kHz to 14 GHz
	N9917B, N9937B	30 kHz to 18 GHz
	N9918B, N9938B	30 kHz to 26.5 GHz
N995xB, N996xB	N9950B, N9960B	300 kHz to 32 GHz
	N9951B, N9961B	300 kHz to 44 GHz
	N9952B, N9962B	300 kHz to 50 GHz
	N9953B, N9963B	300 kHz to 54 GHz

Output signal formats

Continuous Wave (CW)	AM: AM triangle, AM sine
	FM: Sawtooth, FM triangle, FM sine, FSK, BPSK
Pulse	Standard pulse, FM chirp, FM triangle, AM pulse, User-definable sequences

Minimum output frequency

Output signal formats	Models	Minimum frequency
CW, AM triangle, AM sine, BPSK, standard pulse, AM pulse	N991xB, N993xB	30 kHz
	N995xB, N996xB	300 kHz
FM sawtooth, FM triangle, FM sine, FSK, FM chirp, FM triangle	N991xB, N993xB, N995xB, N996xB	1.87 MHz

¹ Discontinued and replaced by corresponding Keysight N99xxC Series FieldFox.

² The starting frequency applies specifically to CW and certain signal formats. Refer to "Minimum output frequency" subsection below for the starting frequency related to other signal formats.

Frequency resolution

Frequency range	Specification	Models
30 kHz ¹ to 1.91211 GHz	0.67 Hz	N991xB/N993xB, or N995xB/N996xB
> 1.91211 to 3.82461 GHz	1.34 Hz	N991xB/N993xB, or N995xB/N996xB
> 3.82461 to 7.64961 GHz	2.68 Hz	N991xB/N993xB, or N995xB/N996xB
> 7.64961 to 15.29961 GHz	5.36 Hz	N991xB/N993xB, or N995xB/N996xB
> 15.29961 to 26.5 GHz	10.73 Hz	N991xB/N993xB, or N995xB/N996xB
> 26.5 to 45.8 GHz	16.09 Hz	N995xB/N996xB
> 45.8 to 54 GHz	32.19 Hz	N995xB/N996xB

Frequency reference, -10 to 55 °C

Accuracy	±0.9 ppm (spec) + aging
	±0.5 ppm (typical) + aging
Accuracy, when locked to GPS	±0.01 ppm (nominal)
Accuracy, when GPS antenna is disconnected	±0.4 ppm (nominal) ²
Aging rate	±1 ppm/yr for 20 years (spec), will not exceed ±3.5 ppm

Maximum output power vs. frequency (nominal)³

Nominally equivalent to typical values in the subsection of “Output power (high)” stated in the chapter of “Tracking generator and independent source”.

Maximum output power⁴

Frequency range	Nominal
30 kHz ¹ to 54 GHz	+10 dBm

Minimum output power⁴

Output signal format	Frequency range	Minimum power
CW, AM triangle, AM sine, BPSK, standard pulse, AM pulse	30 kHz ¹ to 1 MHz	-60 dBm
	1 MHz to 54 GHz	-110 dBm
All other formats	1.87 MHz up to 54 GHz	-110 dBm

Output power tuning step

0.1 dB

Output power accuracy⁵

±1 dB (nominal)

Reference out/trigger out

Connector	SMB (m), 50 Ω
Output amplitude	≥ 0 dBm
Frequency	10 MHz (1 + frequency reference accuracy)

Reference in/trigger in

Connector	SMA (f), 50 Ω
Reference input	10 MHz, -5 to +10 dBm
Trigger in	Reserved for future use

¹ 300 kHz for N995xB or N996xB

² The maximum drift expected in the frequency reference applicable when the ambient temperature changes ±5°C from the temperature when the GPS signal was last connected.

³ Output power at port 1 connector

⁴ Settable through UI

⁵ Calibrate Pulse Generator prior to implementation using two resistor power splitter and load. Accuracy set by SA's total absolute amplitude accuracy for frequencies above 1 MHz.

General Information

N991xB, N993xB, N995xB, N996xB

Calibration cycle	1 year
Weight	3.34 kg or 7.35 lb. including battery (approx.)
Dimensions: H x W x D	292 x 188 x 82 mm (11.5 in x 7.4 in x 3.2 in) (approx.)

Environmental

Samples of this product have been type tested in accordance with the Keysight Environmental Test Manual and verified to be robust against the environmental stresses of Storage, Transportation and End-use; those stresses include but are not limited to temperature, humidity, shock, vibration, altitude and power line conditions. Test Methods are aligned with IEC 60068-2 and levels meet or exceed MIL-PRF-28800F Class 2.

Maximum humidity	Maximum relative humidity (non-condensing): 95% relative humidity up to 40 °C, decreases linearly to 45% relative humidity at 55 °C ¹
Altitude – operating	9,144 m or 30,000 ft (using battery)
Altitude – non-operating	15,240 m or 50,000 ft
Altitude – AC to DC adapter	3,000 m or 9,840 ft

Ingress protection

This product has been type tested to meet the requirements for ingress protection IP53 in accordance with IEC/EN 60529 (IP rating for instrument by itself, with no cover).

Temperature range

Operating, AC power, spec ²	-10 to 55 °C (14 to 131 °F) (-10 to 45 °C/14 to 113 °F in RTSA mode)
Operating, battery, spec	-10 to 50 °C (14 to 122 °F)
Operating, battery, typical	-10 to 55 °C (14 to 131 °F)
Storage, spec ^{3, 4}	-51 to 71 °C (-60 to 160 °F)

EMC: Complies with the essential requirements of the European Radio Equipment Directive as well as current editions of the following standards (dates and editions are cited in the Declaration of Conformity):

IEC/EN 61326-1
 EN 301 489-1, EN 301 489-19
 CISPR Pub 11 Group 1, Class B
 AS/NZS CISPR 11
 ICES/NMB-001(B)

This ISM device complies with Canadian ICES-001
 Cet appareil ISM est conforme a la norme NMB-001 du Canada.

¹ From 40 °C to 55 °C, the maximum % relative humidity follows the line of constant dew point.

² Power supply: 0 to 40 °C at 90 W output rating, derate linearly at 3 watts per degree C, to 45 W at 55 °C, 30 W at -20 °C.

³ The battery packs should be stored in an environment with low humidity. Extended exposure to temperature above 45 °C could degrade battery performance and life.

⁴ Power supply: -40 °C to 85 °C (-40 °F to 185 °F).

South Korean Class A EMC declaration

This equipment has been conformity assessed for use in business environments. In a residential environment this equipment may cause radio interference.

사용자 안내문
이 기기는 업무용 환경에서 사용할 목적으로 적합성평가를 받은 기기로서 가정용 환경에서 사용하는 경우 전파간섭의 우려가 있습니다.

※ 사용자 안내문은 "업무용 방송통신기자재"에만 적용한다.

Radio equipment (GNSS): Complies with the essential requirements of the European Radio Equipment Directive:

EN 303 413

Acoustic statement (European Machinery Directive):

Acoustic noise emission

LpA < 70 dB

Operator position

Normal operation mode per ISO 7779

SAFETY: Complies with the essential requirements of the European Low Voltage Directive as well as current editions of the following standards (dates and editions are cited in the Declaration of Conformity):

IEC/EN 61010-1

Canada: CSA C22.2 No. 61010-1

USA: UL std no. 61010-1

To find a current Declaration of Conformity for a specific Keysight product, go to:

<http://www.keysight.com/go/conformity>

Explosive environment

This product has been type tested to meet the requirements for operation in explosive environments in accordance with MIL-STD-810G, Method 511.5, Procedure I.

Power supply

External DC input	15 to 19 VDC, 4 amps maximum when battery charging
External AC power adapter	Efficiency level VI
Input	100 to 240 VAC, 50 to 60 Hz, 1.5 to 0.75 A
Output	15 VDC, 6 A
Power consumption	16 to 30 watts (typical) Battery consumption depends on battery saver selection, measurement mode and temperature.

Battery

Lithium ion	10.8 V, 6.4 A-h, 70 Wh
Operating time	4 hours (typical), mode dependent
Charge time	A fully discharged battery takes about 1.5 hours to recharge to 80%. Four hours to 100%.
Discharge temperature limits	-10 to 60 °C, ≤ 85% RH
Charge temperature limits	0 to 45 °C, ≤ 85% RH
Storage temperature limits	-20 to 50 °C, ≤ 85 % RH The battery packs should be stored in an environment with low humidity. Extended exposure to temperatures above 45 °C could degrade battery performance and life.

Test port connectors

Input impedance	50 Ω
-----------------	------

Connector type

≤ 18 GHz models	Type-N (f)
26.5 GHz models	3.5 mm (m) for FieldFox microwave analyzer, N9918B. On FieldFox SA N9938B, you may choose 3.5 mm (m) by ordering option N9938B-100 or Type-N (f) by default. Type-N (f) port connector is not available for the 26.5 GHz microwave analyzer, N9918B.
32, 44, 50 GHz models	NMD 2.4 mm (m), torque 0.90 Nm or 8 in-lb, use torque wrench N9910X-886
54 GHz models	NMD 1.85 mm (m), torque 0.90 Nm or 8 in-lb, use torque wrench N9910X-886

Display

Headphone jack connector	6.5" transfective color LCD-LED backlit
--------------------------	---

Headphone jack connector

USB-A, 2-ports	3.5 mm (1/8 inch) miniature audio jack
----------------	--

USB-A, 2-ports

Mini USB, 1 port	Hi-speed USB 2.0
------------------	------------------

Mini USB, 1 port

Keyboard	Hi-speed USB 2.0; used for SCPI programming; USBTMC (USB IEEE488)
----------	---

Keyboard

LAN	USB keyboards are supported (user must supply their own keyboard)
-----	---

LAN

Connector	RJ-45 Used for programming, data saving, remote control, and connection to DataLink software
-----------	---

N991xB, N993xB, N995xB, N996xB	1000/100/10 base-T (auto switching) SCPI over LAN using sockets and VX11 (LAN IEEE488); HTTP
--------------------------------	---

Programming

Languages	SCPI, using the built-in LAN interface, PathWave BenchVue
-----------	---

Languages

Preset	English, Spanish, German, Italian, French, Russian, Japanese, Chinese, Turkish, Korean, and Portuguese
--------	--

Preset

	User preset for both mode preset and complete system preset
--	---

Limit lines

The limit line capabilities listed in this section apply to the cable and antenna analyzer, network analyzer and spectrum analyzer modes in all FieldFox analyzers.

- Limit lines can be a combination of horizontal lines, sloping lines, or discrete data points
- Limit types: Fixed or relative
- Each trace can have its own limit line
- Limit lines can be built from a current trace
- Limit segments > 100, limited by memory size
- Max limit line number of points: 10,001
- Beep: Beep off, Beep on fail, Beep on pass
- Pass/fail warning: on/off
- Offset and margin: An increase or decrease in the limit line
- Save/recall limit lines

Data storage

Internal	Internal Minimum: 4 GB Minimum states and traces: 1000
External	Supports USB 2.0 compatible memory devices and SD/SDHC memory cards with FAT and exFAT format
Data types	Trace, trace+state, picture (png), data (csv), S1P, S2P

Secure operation

Frequency blanking	For protection of sensitive data all frequency information can be turned off.
Erase user data	All user data can be erased on a FieldFox analyzer. For more information visit: http://www.keysight.com/find/securefieldfox

Reference OUT/trigger OUT

Connector	SMB (m), 50 Ω
Output amplitude	≥ 0 dBm
Frequency	10 MHz (1 + frequency reference accuracy)
Trigger out	Reserved for future use; currently only used for ERTA 2-box handshaking

Reference IN/trigger IN

Connector	SMA (f), 50 Ω
Reference input	10 MHz, -5 to +10 dBm
Trigger input	3.3 or 5 V TTL logic levels

FieldFox Physical Dimensions

FieldFox models with Type-N test port connectors

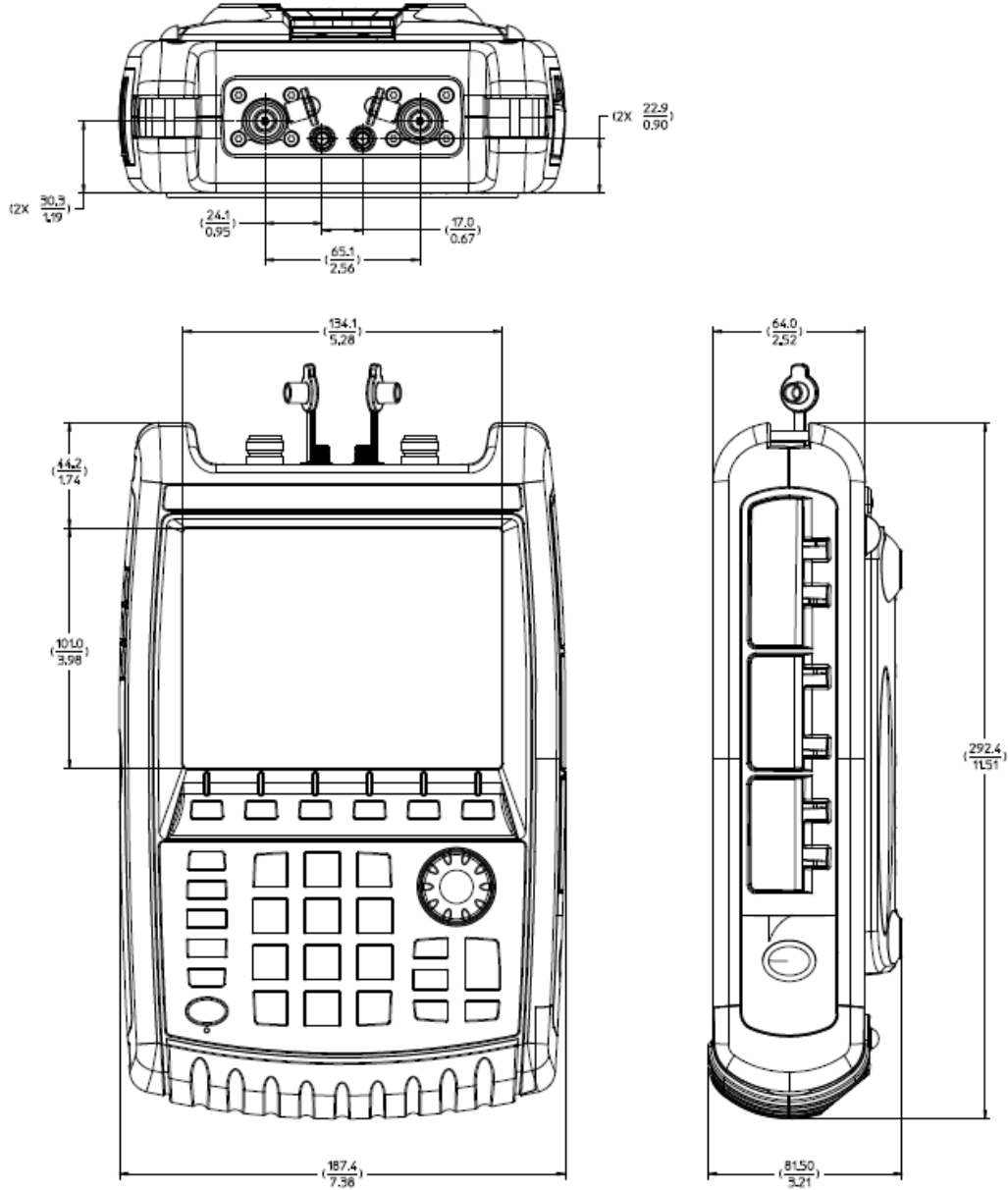

FieldFox models with 3.5 mm test port connectors

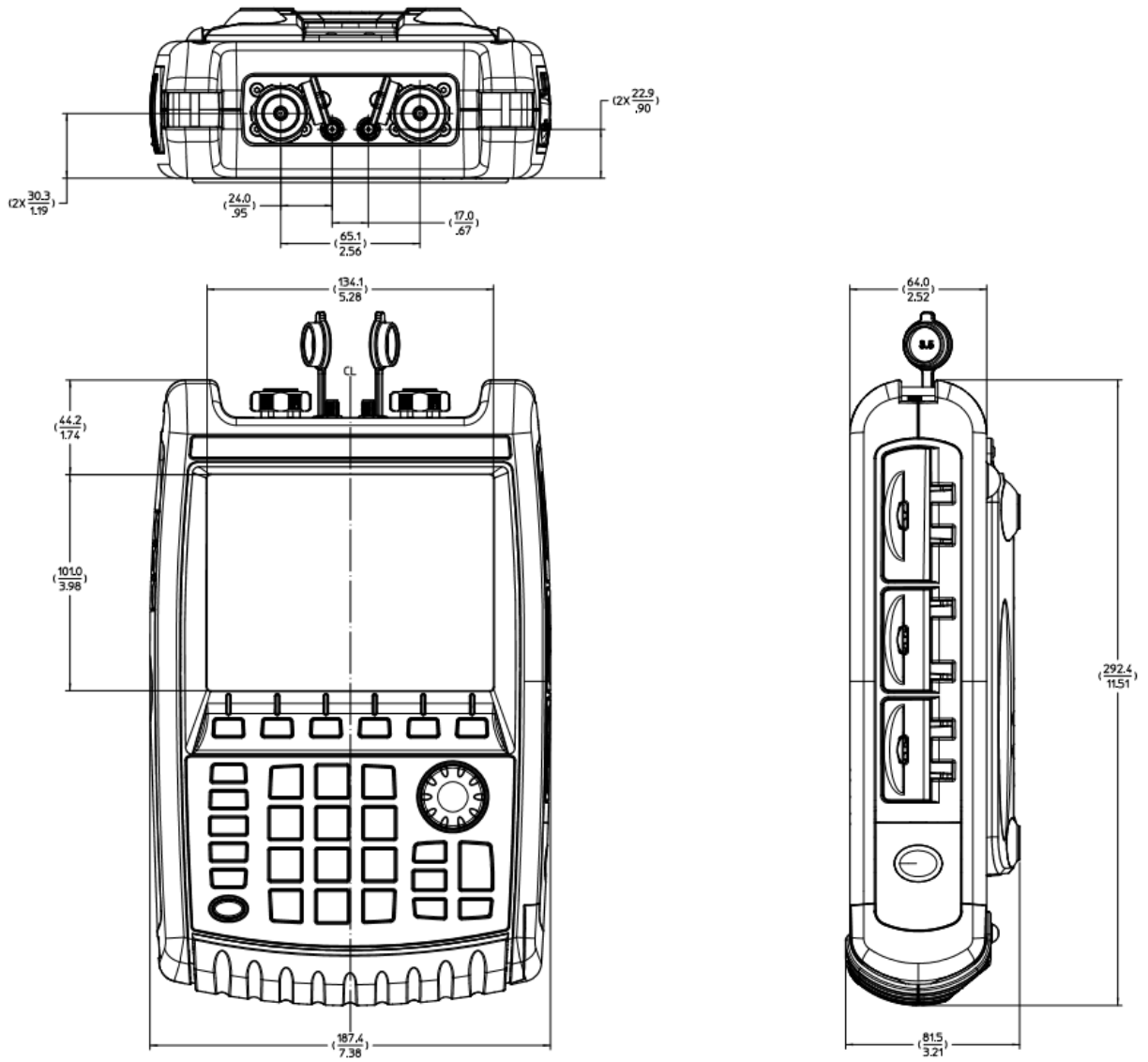

FieldFox models with 2.4 mm test port connectors ¹

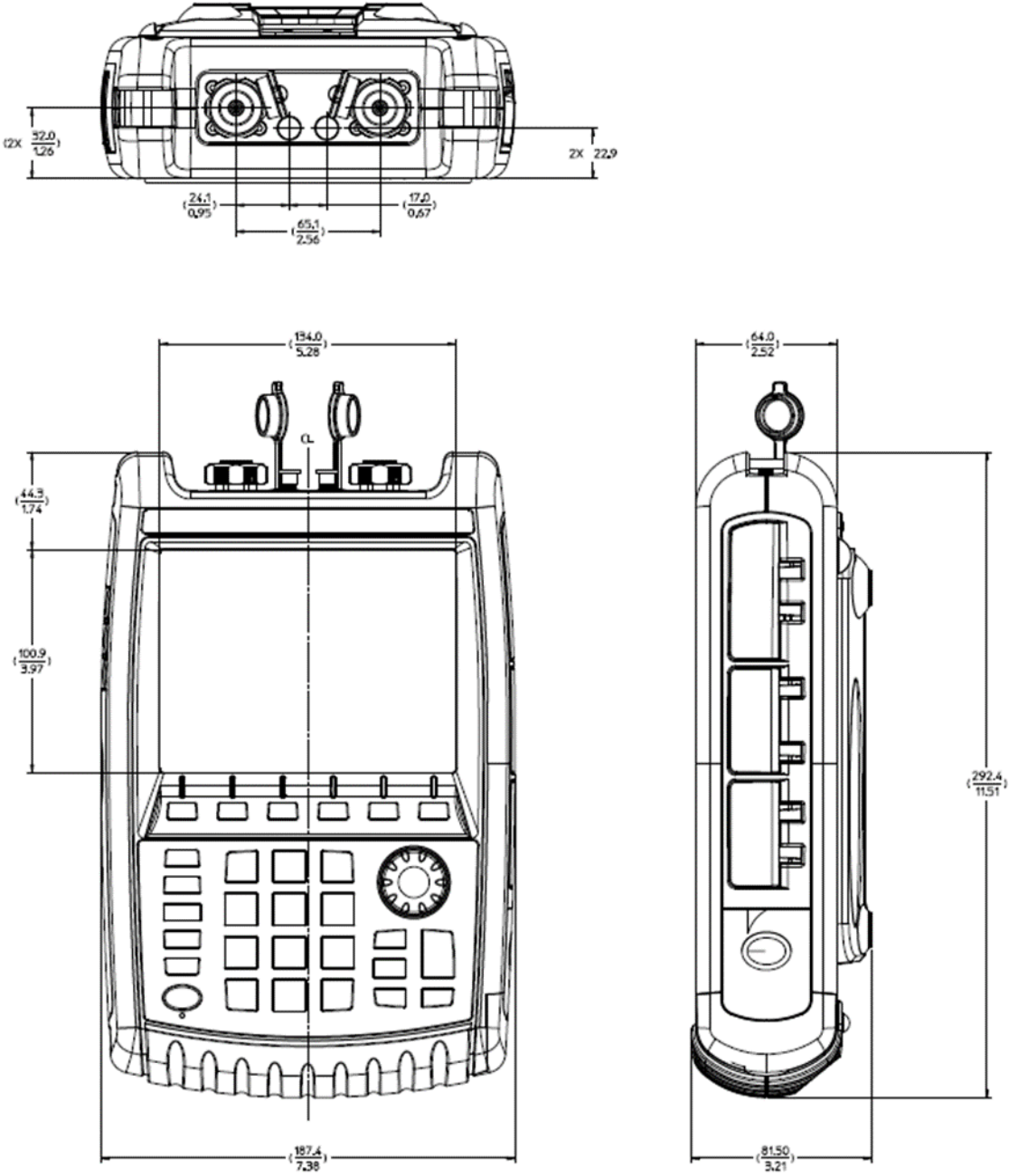

¹ Physical dimension measures shown in this drawing are also applicable to the FieldFox models with test port connectors of 1.85 mm (N9953B/N9963B).

Keysight Support Services

Accelerate your learning curve, enhance your test uptime, and confidently guarantee your instrument accuracy with Keysight Support Services. Keysight Services are here to support your test needs with expert technical support, instrument repair and calibration, training, alternative acquisition program options, and more.

A KeysightCare agreement provides dedicated, proactive support through a single point of contact for an extensive group of instruments, software, and solutions to ensure optimal uptime, with fast response times and resolution. Explore the services that are right for you.

Keysight Services

Offering	Benefits
KeysightCare 	KeysightCare provides elevated support for Keysight instruments and software, with access to technical support experts who respond within a specified time and ensure committed repair and calibration turnaround times (TAT). KeysightCare offers multiple service agreement tiers, including KeysightCare Assured, Enhanced, and Application Software Support. See the KeysightCare data sheet for details.
KeysightCare Assured	KeysightCare Assured provides a commitment to respond to your engineer's technical needs quickly. When unexpected repairs are necessary, you can count on a committed repair service turnaround time to get you back up and running.
KeysightCare Enhanced	KeysightCare Enhanced includes all the benefits of KeysightCare Assured plus Keysight's accurate and reliable Calibration Services , accelerated and committed TAT, and technical response.
Keysight Support Portal & Knowledge Center	All KeysightCare tiers include access to the Keysight Support Portal, where you can manage support and service resources related to your assets, such as service requests and status, or browse the Knowledge Center.
Education Services	Build confidence and gain new skills to make accurate measurements, with flexible Education Services developed by Keysight experts. Including Start-up Assistance.
Alternative acquisition options	
KeysightAccess	Reduce budget challenges with a lease-based subscription service that offers low monthly payments, enabling you to get the instruments, software, and technical support you want for your test needs.

Recommended services

Maximize your instrument uptime and confidently make accurate measurements by securing technical support, repair, and calibration services with committed response and turnaround times. High-performance instruments include 1 year of KeysightCare Assured. Obtain multi-year KeysightCare upfront to eliminate the need for lengthy and tedious paperwork and yearly requests for maintenance budget. Plus, you benefit from secured service for 2, 3, or 5 years.

Service	Function
KeysightCare Enhanced*	Includes tech support, warranty and calibration
R-55B-001-1	KeysightCare Enhanced – Upgrade 1 year
R-55B-001-2	KeysightCare Enhanced – Extend to 2 years
R-55B-001-3	KeysightCare Enhanced – Extend to 3 years (Recommended)
R-55B-001-5	KeysightCare Enhanced – Extend to 5 years (Recommended)
KeysightCare Assured	Includes tech support and warranty
R-55A-001-2	KeysightCare Assured – Extend to 2 years
R-55A-001-3	KeysightCare Assured – Extend to 3 years
R-55A-001-5	KeysightCare Assured – Extend to 5 years
Start-Up Assistance	
PS-S40-01	Included – instrument fundamentals and operations starter
PS-S40-04	Recommended – instrument fundamentals and operations starter
PS-S40-02	Optional, technology & measurement science standard learning

* Available in select countries. For details, please view the [datasheet](#). R-55B-001-2/3/5 must be ordered with R-55B-001-1.

Carry Precision with You

Every piece of gear in your field kit had to prove its worth. Measuring up and earning a spot is the driving idea behind Keysight's FieldFox analyzers. They're equipped to handle routine maintenance, in-depth troubleshooting, and anything in between. Better yet, FieldFox delivers precise microwave measurements—wherever you need to go. Add FieldFox to your kit and carry precision with you.

Related literature	Publication number
FieldFox Handheld Analyzers, Configuration Guide	5992-3701EN
FieldFox Handheld Analyzers, Technical Overview	5992-3703EN

Download application notes, watch videos, and learn more: www.keysight.com/find/fieldfox

Keysight enables innovators to push the boundaries of engineering by quickly solving design, emulation, and test challenges to create the best product experiences. Start your innovation journey at www.keysight.com.



This information is subject to change without notice. © Keysight Technologies, 2020 – 2026, Published in USA, March 27, 2026, 5992-3702EN