



Version
02.01

February
2009

R&S® SMF100A Microwave Signal Generator

Signal generation redefined

- ◆ Max. frequency range from 100 kHz to 43.5 GHz
- ◆ Excellent SSB phase noise of typ. -120 dBc (at 10 GHz; 10 kHz carrier offset)
- ◆ Very high output power of typ. $+25$ dBm
- ◆ Ideal in all areas
 - R & D
 - Production
 - Service as well as maintenance and repair
- ◆ Remote control via GPIB, Ethernet or USB
- ◆ Innovative block diagram operation



ROHDE & SCHWARZ

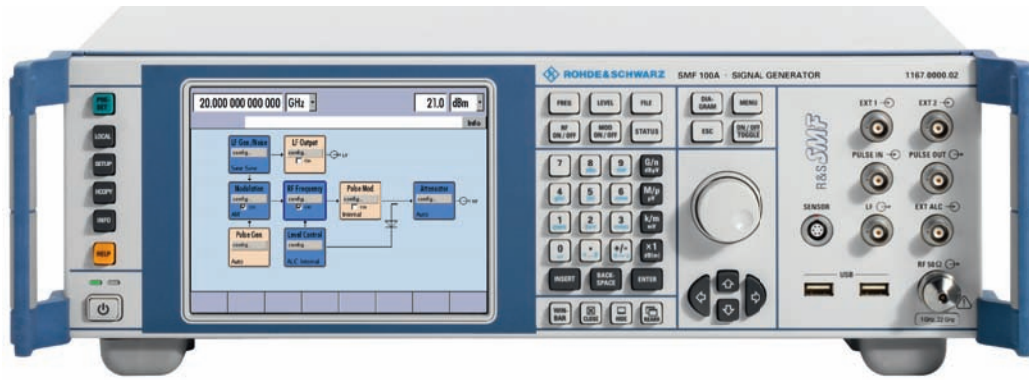

At a glance

Signal quality, speed, and flexibility – these are decisive properties for a signal generator in the microwave range.

To meet even the highest of requirements, the R&S®SMF100A microwave signal generator was completely redesigned and newly developed. The result is a first-rate, state-of-the-art microwave signal generator that sets new standards. It thus covers the numerous fields of application encountered in R&D, production, service, maintenance, and repair.

The R&S®SMF100A operates in the wide frequency range from 100 kHz to 43.5 GHz with specific configurations. In addition to CW signals, all common types of analog modulation (AM, FM, ϕ M, pulse modulation) or combinations thereof can be generated.

For just one example among many, take the following application: What can you do when cable loss at high frequencies starts becoming a larger and larger problem? Subsequent amplifiers represent one solution – or you can simply use the R&S®SMF100A equipped with the R&S®SMF-B32 or R&S®SMF-B34 option that supplies a high output power of typ. +25 dBm at 20 GHz.

The R&S®SMF100A signal generator offers a modern graphical user interface for fast and intuitive operation. The settings – which, for the first time in

a microwave signal generator, can be controlled via a block diagram – and the signal flow can be seen at a glance.

Special features

Excellent signal quality

- ◆ Exceptionally low single sideband phase noise:
typ. –120 dBc
(at 10 GHz; 10 kHz carrier offset; 1 Hz measurement bandwidth)
- ◆ Very low wideband noise:
typ. <–148 dBc at 10 GHz
(>10 MHz carrier offset; 1 Hz measurement bandwidth; at +10 dBm)
- ◆ Very low harmonics:
typ. <–55 dBc at 10 GHz
(at +10 dBm)
- ◆ High suppression of nonharmonics:
typ. <–62 dBc at 10 GHz
(>3 kHz carrier offset; at +10 dBm)

Ideal for use in production

- ◆ Very short level and frequency setting times across entire level and frequency range:
<4 ms (frequency), <3 ms (level), <700 μ s (List mode; frequency and level)
- ◆ Very high output power of up to
typ. +25 dBm
- ◆ Outstanding absolute level accuracy and level repeatability
- ◆ Selection of interfaces for remote control
- ◆ Low space requirement in rack: only three height units

Aerospace & defense applications

- ◆ Optional pulse modulator with excellent data:
>80 dB on/off ratio
<10 ns rise/fall time
<20 ns pulse width
- ◆ Optional pulse generator
- ◆ Optional pulse train
- ◆ Optional removable compact flash disk to meet high security requirements

All-purpose applications

- ◆ Frequency range 100 kHz to 43.5 GHz
- ◆ Frequency, level, and LF sweeps
- ◆ AM, broadband FM, ϕ M, pulse modulation
- ◆ Two multifunction generators up to 10 MHz
- ◆ Usable for scalar network analysis with R&S®-NRP-Zx power sensor connected

Intuitive operating concept

- ◆ Intuitive operating interface with graphical representation of the signal flow (block diagram)
- ◆ Operation with rotary knob on instrument or with USB mouse
- ◆ VGA color display with 640 pixels \times 480 pixels

Selection of interfaces

- ◆ Remote control via GPIB, Ethernet or USB
- ◆ USB ports for keyboard, mouse, and memory stick
- ◆ Connector for R&S®NRP-Zx power sensors for precise power measurement
- ◆ Control via remote operation tool (e.g. VNC)

Everything in one instrument

The R&S®SMF100A base unit with frequency option included already offers the essential functions and interfaces. This basic configuration can be adapted to meet the requirements of further applications by adding specific options.

The R&S®SMF100A has outstanding specifications. Additional options for improving performance are not needed. This gives you a decisive advantage as the user. You no longer need to carry out tedious option configurations in order to increase performance.

The base unit with frequency options included consists of the following:

- ◆ R&S®SMF100A base unit plus R&S®SMF-B122 frequency option (1 GHz to 22 GHz)
- ◆ R&S®SMF100A base unit plus R&S®SMF-B144 frequency option (1 GHz to 43.5 GHz)
- ◆ With the optional R&S®SMF-B2 frequency extension plus one of the frequency options, the frequency range starts at 100 kHz

This package contains the following as standard:

Excellent spectral purity

Absolutely no compromises have been made here. Everything technically feasible has been implemented. Both the SSB phase noise and the outstanding suppression of harmonics and nonharmonics earn top grades. This is a must for anyone working in the area of scalar network analysis, for example.

Precise output level

Precise and stable output levels are essential in a microwave signal generator. Furthermore, high resolution is required when calibrating levels in measuring receivers. Therefore, the R&S®SMF100A offers high-precision, frequency-response-corrected level control across the entire level range.

Of course, the R&S®SMF100A includes outstanding absolute level accuracy. But even more important is its level repeatability, since absolute errors can be compensated for by means of the appropriate corrections. Particularly in the case of repeatability, the R&S®SMF100A sets new standards as shown in the figure below.

High frequency resolution

To meet the high requirements of many applications in research and science, the frequency options offer a frequency resolution of one-thousandth of a hertz (0.001 Hz) as standard.

Digital frequency and level sweep

The digital frequency sweep makes it possible to perform frequency response measurements of microwave applications. Start and stop frequencies as well as step times are user-selectable. A trigger input enables synchronized operation with external equipment.

The level sweep across any level range makes it possible, for example, to measure the compression characteristic of amplifiers or mixers.

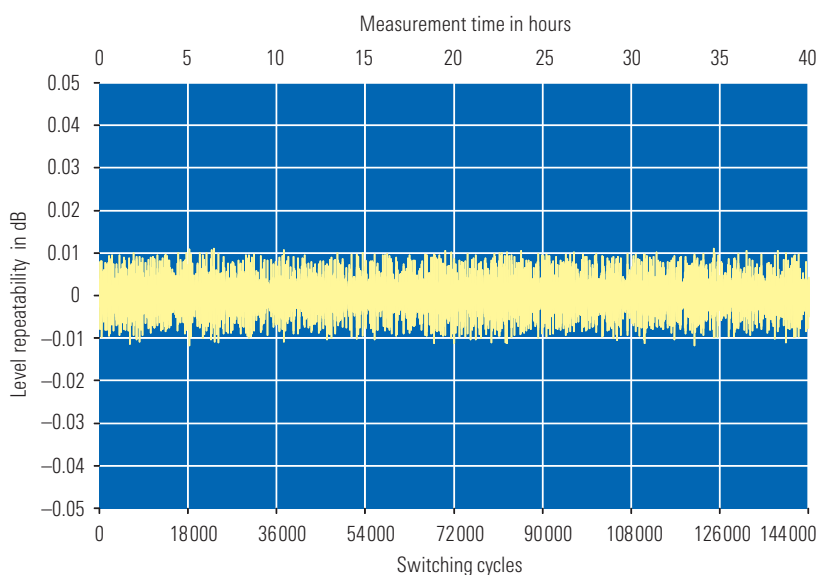

Level repeatability over time (with random frequency and level changes between measurements)

Additional options

The R&S®SMF100A can be expanded with the following options in order to further adapt it to a wide variety of applications:

Expanded level range

For sensitivity measurements on receivers, very low levels are needed. With the optional R&S®SMF-B26 or R&S®SMF-B27 step attenuator, the lower level limit is shifted from -20 dBm without attenuator down to -130 dBm with attenuator.

High output level

In many microwave test setups, various equipment such as long cables, power splitters, directional couplers, or RF relays cause high loss. One possible solution here is an expensive exter-

	FM	ϕ M	AM	Log AM	PM	FSK	PSK	ASK
FM	✓	–	✓	✓	✓	–	–	✓
ϕ M	–	✓	✓	✓	✓	–	–	✓
AM	✓	✓	✓	–	•	✓	✓	–
Log AM	✓	✓	–	✓	•	✓	✓	–
PM	✓	✓	•	•	–	✓	✓	•
FSK	–	–	✓	✓	✓	–	–	✓
PSK	–	–	✓	✓	✓	–	–	✓
ASK	✓	✓	–	–	•	✓	✓	–

- ✓ possible with no restrictions
- possible with restrictions
- not feasible

Modulation matrix

nal microwave amplifier. But you can avoid this budget-consuming component by using the R&S®SMF-B32 or R&S®SMF-B34 high output power option with up to typ. +25 dBm at 20 GHz.

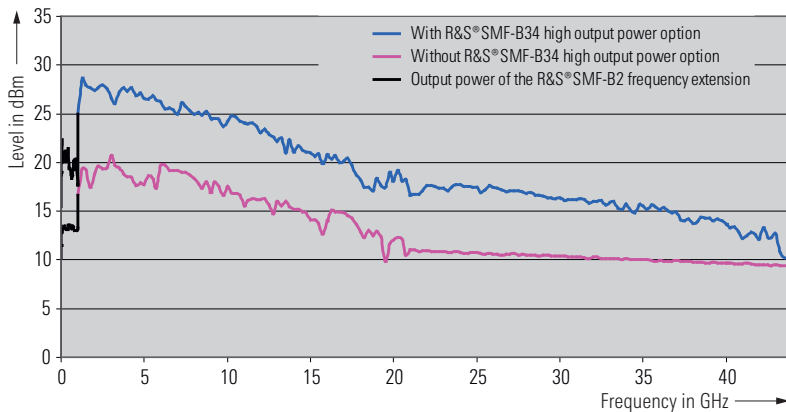

Maximum output power with and without the R&S®SMF-B34 high output power option in the frequency range 100 kHz to 43.5 GHz (R&S®SMF-B144 and R&S®SMF-B2; with the R&S®SMF-B27 step attenuator option); the lower curve in the frequency range 100 kHz to 1 GHz is with activated pulse modulator of the R&S®SMF-B2 frequency extension

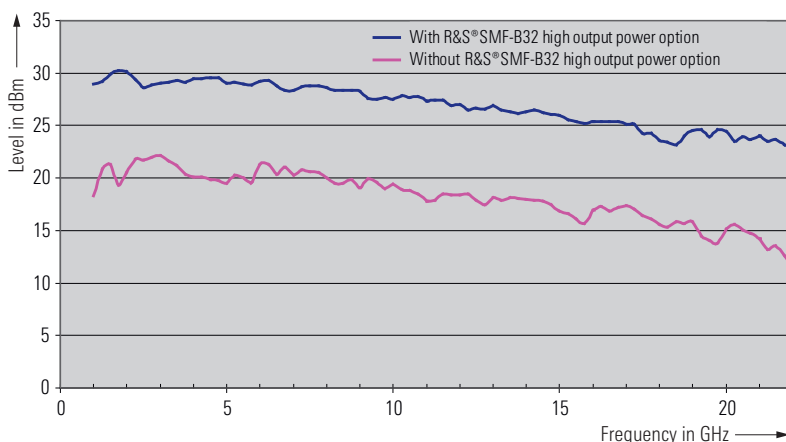

Maximum output power with and without the R&S®SMF-B32 high output power option in the frequency range 1 GHz to 22 GHz (R&S®SMF-B122; in both cases with the R&S®SMF-B26 step attenuator option)

AM, FM, ϕ M, and Log AM including LF generators and noise generator

The R&S®SMF-B20 AM/FM/ ϕ M/LOG AM option complements the R&S®SMF100A microwave signal generator. This expansion also includes two LF generators and a noise generator, making any combination of modulation modes possible. The table above provides an overview.

Analog ramp sweep mode

The analog ramp sweep mode (provided by the R&S®SMF-K4 option) corresponds to the analog sweep of classic sweep generators except that the sweep is fully synchronized over the complete range. In this way, the excellent frequency accuracy of digital step sweeps is achieved on the whole, and this at much higher sweep rates of min. 700 MHz/ms at frequencies ≥ 3 GHz.

High-end pulse modulation

The R&S®SMF100A can additionally be equipped with the R&S®SMF-K3 pulse modulation option. Even high requirements are exceeded by an ON/OFF ratio of >80 dB, a rise/fall time of <10 ns, and a minimum pulse width of <20 ns.

High-quality pulse generator

In the case of pulsed signals, the combination of the R&S®SMF-K3 pulse modulator option and the internal R&S®SMF-K23 pulse generator option offers the ideal solution – particularly

if you do not have a high-quality pulse generator for testing. However, the internal pulse generator can also be used by itself in external applications via designated outputs.

One new optional feature of the built-in pulse generator is the alternative to generate "pulse trains" (R&S®SMF-K27 option), which are commonly used for radar applications. An example of a pulse train is shown in the figure on the right. In contrast to single or double pulses, "pulse trains" are a combination of different pulses, which can be a periodical or non-periodical set of pulses.

Highly stable output frequency

The integrated reference oscillator included as standard keeps the output frequency precise and low in drift. To meet the highest of requirements in precision and aging, you can add the R&S®SMF-B1 OCXO reference oscillator option to the R&S®SMF100A.

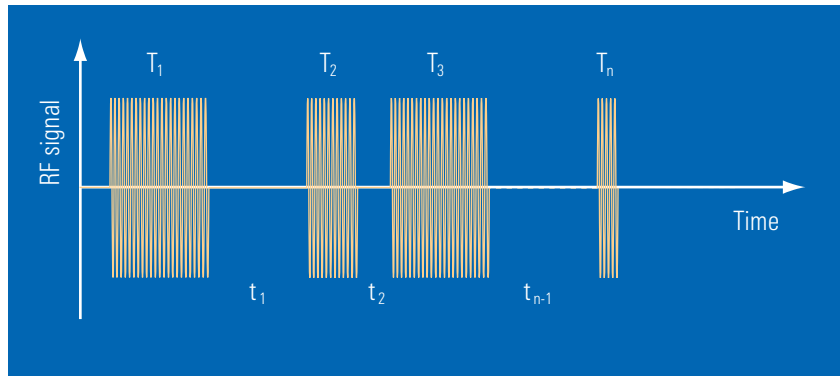

Pulse train: combination of pulses with different pulse widths and pauses

Excellent signal quality

Due to an innovative synthesizer concept, the R&S®SMF100A offers excellent values in terms of SSB phase noise, wideband noise, and nonharmonics suppression. It is the ideal solution for all measurement applications in which the very high spectral purity of typ. -120 dBc (10 GHz; 10 kHz carrier offset; 1 Hz measurement bandwidth) is needed. For example, it can be used in communications systems as an IF or LO substitute for adjacent channel or phase noise mea-

surements or in low-noise radar as an ultra-pure signal source.

The R&S®SMF100A offers this outstanding signal quality because it includes an integrated reference oscillator as standard. You can improve this quality even further very near the carrier by adding the R&S®SMF-B22 enhanced phase noise option.

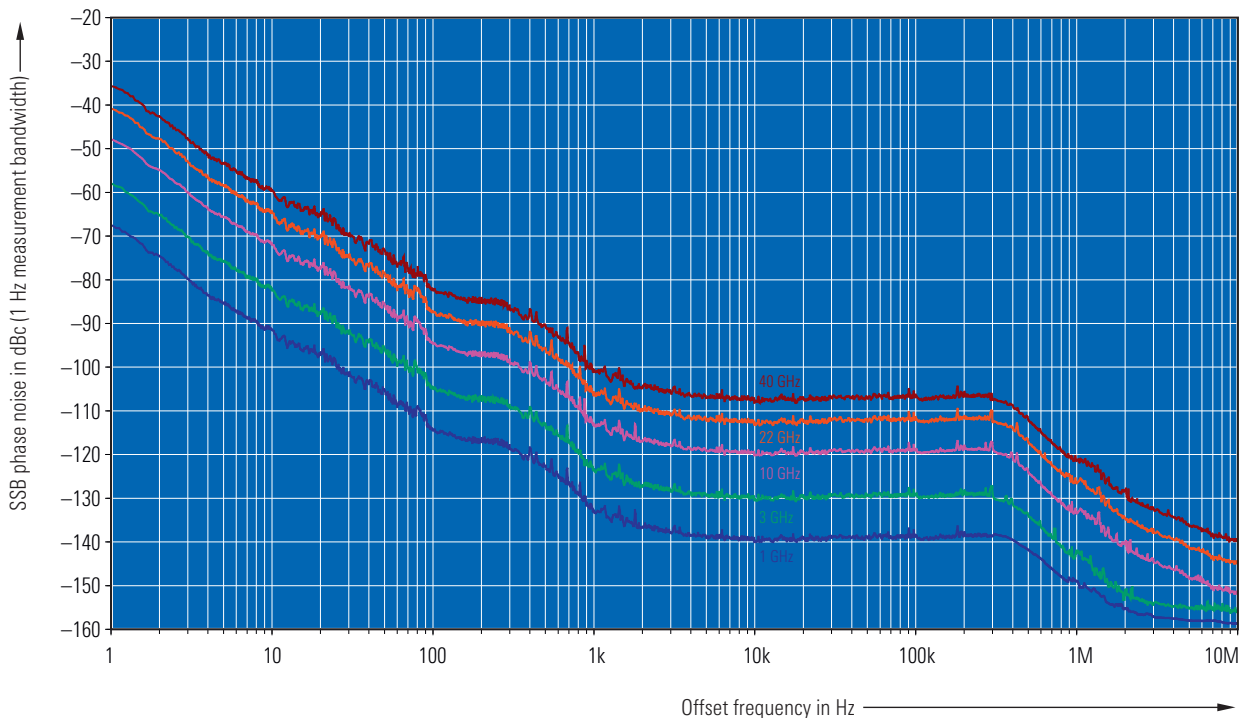

Single sideband phase noise for various frequencies with the R&S®SMF-B22 enhanced phase noise performance option

Ideal for use in production

In production, high throughput and low test costs are the benchmarks by which a state-of-the-art microwave signal generator must be measured. The R&S®SMF100A excels in this area by continuing the long tradition of very short level and frequency setting times in signal generators from Rohde & Schwarz. These very short setting times in the millisecond range can be significantly reduced even further in the List mode. Here, the use of frequency and level pairs stored in a list brings setting times down to less than 700 μ s when changing from one frequency and level pair to the next.

In addition to very short setting times, a wide level range is also required. There are two reasons for this. First, sensitivity measurements demand very low levels, which can be set with the optional attenuators. Second, the microwave signal generator must compensate for loss in the test setup by means of correspondingly high output power. This must be done without having to rely on external amplifiers.

The R&S®SMF-B32 or R&S®SMF-B34 high output power option, which has output power of typ. +25 dBm at 20 GHz, will meet your needs with power to spare.

Furthermore, the production environment demands that measuring equipment be small in size. Occupying only three height units, the R&S®SMF100A leaves ample space for other equipment in a rack.

Aerospace & defense

The high requirements encountered in the aerospace & defense industry are met by the combination of the R&S®SMF-K3 pulse modulator option and the R&S®SMF-K23 pulse generator option. For example, both single and double pulses can be generated with a delay. In addition, the pulse generator can generate pulse trains (R&S®SMF-K27 option), which are a combination of pulses with different widths and spacings between the pulses.

To meet the high security requirements demanded in aerospace & defense applications, the internal memory (compact flash disk containing all stored settings) can be shifted to the rear of the instrument (R&S®SMF-B85 option). The flash disk is then located in a slot and can be removed whenever necessary. Thus, sensitive data can always remain in a secured area.

Intuitive operating concept

State-of-the-art microwave signal generators offer a wealth of functions, internal boards, modules, and interfaces. When working with the instrument, you will especially appreciate its intuitive and fast operation as well as its straightforward display of the settings that have been made. In the R&S®SMF100A, this is implemented by means of an easy-to-read block diagram.

You can immediately see which blocks can be called up for modulation or frequency settings, or which inputs and outputs have been enabled. Plus, your colleagues will benefit as well: All of them can see at a glance how the R&S®SMF100A microwave signal generator is configured.

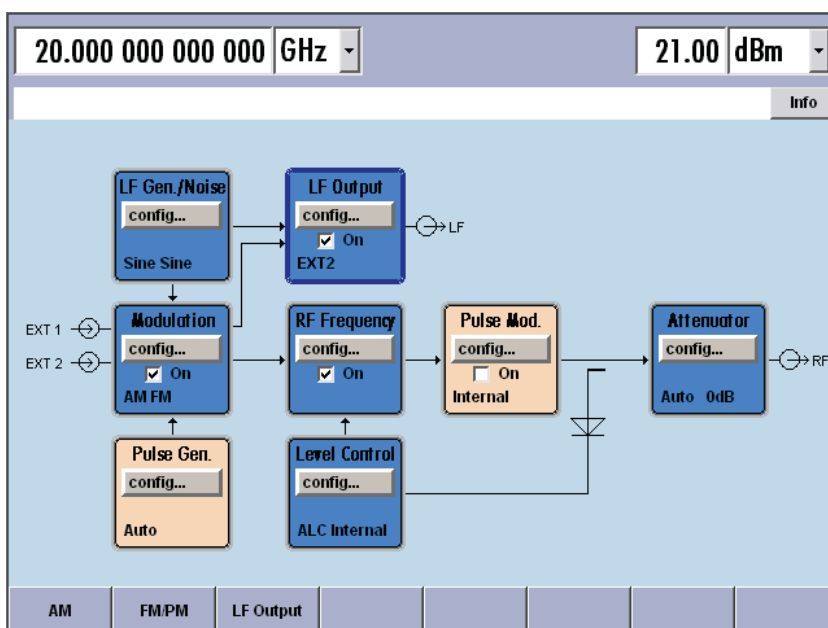

The R&S®SMF100A block diagram shows numerous settings, the signal flow, as well as active inputs and outputs in a straightforward manner

Selection of interfaces

The R&S®SMF100A microwave signal generator can be remote-controlled via GPIB, LAN, or USB (LAN is part of the base unit). Slots are provided for the GPIB and USB options.

The two spare slots can be used for a maximum of two of the following three options: R&S®SMF-B83 removable GPIB, R&S®SMF-B84 removable USB, or R&S®SMF-B85 removable flash disk.

For operating the instrument outside the security area, an optional spare CompactFlash™ memory card (R&S®SMF-Z10) is available on which no security-relevant data is stored. You can insert this spare card in the slot, switch on the signal generator, and then perform an internal instrument adjustment. The instrument is now ready for operation, calibration, or repair.



Optional flash disk plug-in module, open (top) and closed



Rear view of the R&S®SMF100A with optional GPIB and USB (master and slave) interfaces

Suitable for all applications

Scalar network analysis

A common task in R&D or production is the adjustment of filters or the characterization of components. With its integrated List mode or its optional analog ramp sweep, the R&S®SMF100A directly offers two ways of performing the measurements quickly and accurately. A major advantage in both modes is that frequency and linearity errors can be eliminated, as frequency generation is implemented in a synthesized (digital) manner.

A third brand-new approach to scalar network analysis is provided by the power sensor connectivity of the R&S®SMF100A plus the R&S®SMF-K28 power analysis option.

List mode

Especially when the R&S®SMF100A microwave signal generator is used together with a Rohde&Schwarz spectrum analyzer (R&S®FSP-B10 option), scalar network analysis can be performed selectively and very quickly. The distinguishing aspect is a large dynamic range with which, for example, filters in the passband and stopband can be measured even at small

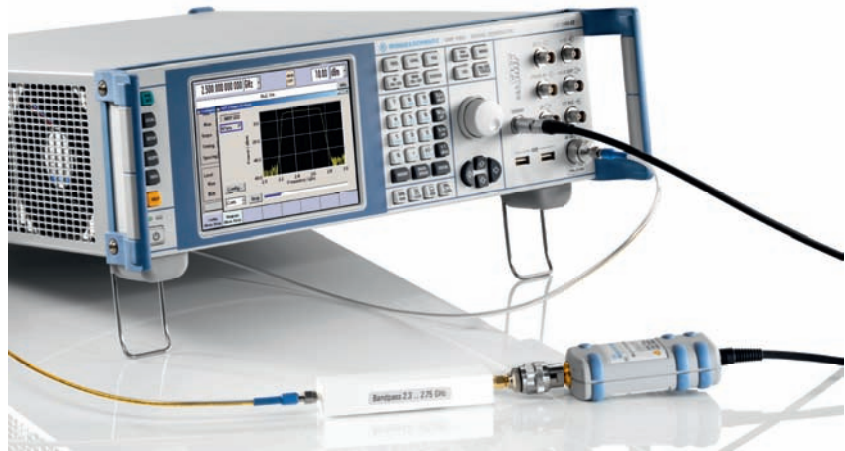

Scalar network analysis on an external bandpass filter (with R&S®SMF-K28 power analysis option plus R&S®NRP-Zx power sensor)

levels. An adjustable frequency offset is also available for measuring frequency-converting DUTs. (Note: The List mode in combination with the R&S®FSP-B10 option requires that the R&S®SMF-B83 removable GPIB option be installed.)

Analog ramp sweep

For the "realtime adjustment" of filters or components, very high sweep speed and sweep accuracy are required. The R&S®SMF100A meets this requirement by means of the optional R&S®SMF-K4 analog ramp sweep. This solution furthermore offers a higher frequency

resolution than the List mode mentioned earlier.

Scalar network analysis with an R&S®NRP-Zx power sensor

In the absence of spectrum or network analyzers scalar network analysis can be performed by means of the R&S®SMF100A microwave signal generator with the R&S®SMF-K28 power analysis option plus an R&S®NRP-Zx power sensor. One example is to measure the passband characteristic of a bandpass filter.

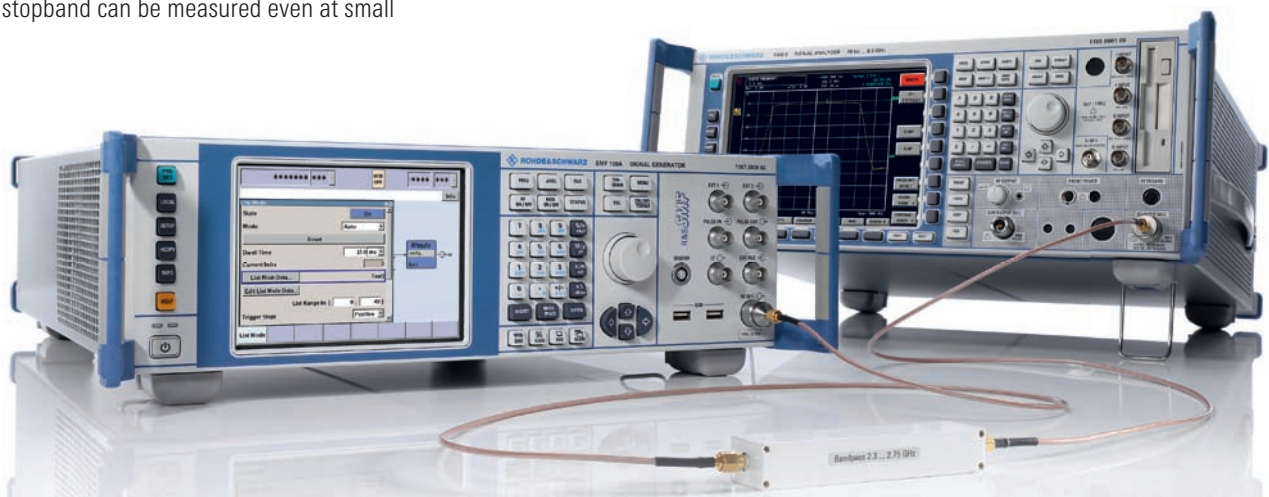

Scalar network analysis with the R&S®SMF100A microwave signal generator and the R&S®FSP-B10 spectrum analyzer with the R&S®FSP-B10 option installed

The input of this filter is connected to the RF output whereas the output is connected to an R&S®NRP-Zx power sensor. The power sensor itself is plugged to

the sensor input of the R&S®SMF100A. Based on the entered frequency range the R&S®SMF100A performs the measurement and displays the passband of

this bandpass filter. The filter can now be manually tuned and the adjustments can be directly controlled on the R&S®SMF100A display.

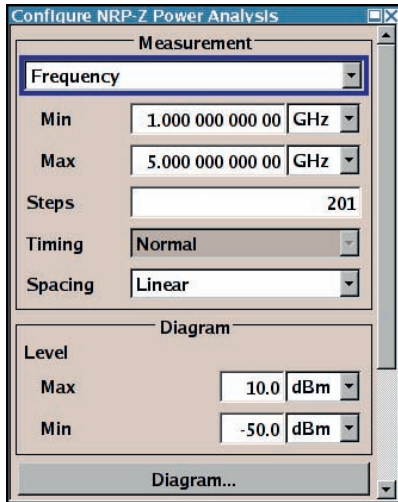

Setup on the R&S®SMF100A

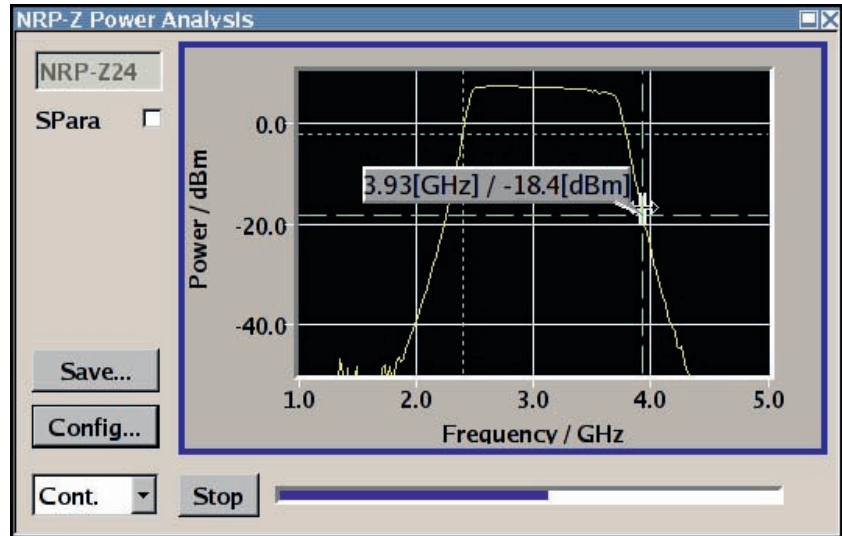

Characteristic of a bandpass filter displayed by the R&S®SMF100A (with the R&S®SMF-K28 power analysis option installed)

User-defined correction of external frequency responses

DUTs such as power amplifiers always have frequency responses. In these cases, the signal generator needs to compensate for the frequency response. The R&S®SMF100A offers the User Correction function for precisely this purpose. For

a known frequency response that needs to be corrected, you can enter the level correction values as a function of the frequency. Automatic interpolation of the correction values is performed between these frequency points.

To simplify this, the R&S®SMF100A can also automatically include the level correction values at the press of a button by using external Rohde & Schwarz power sensors.

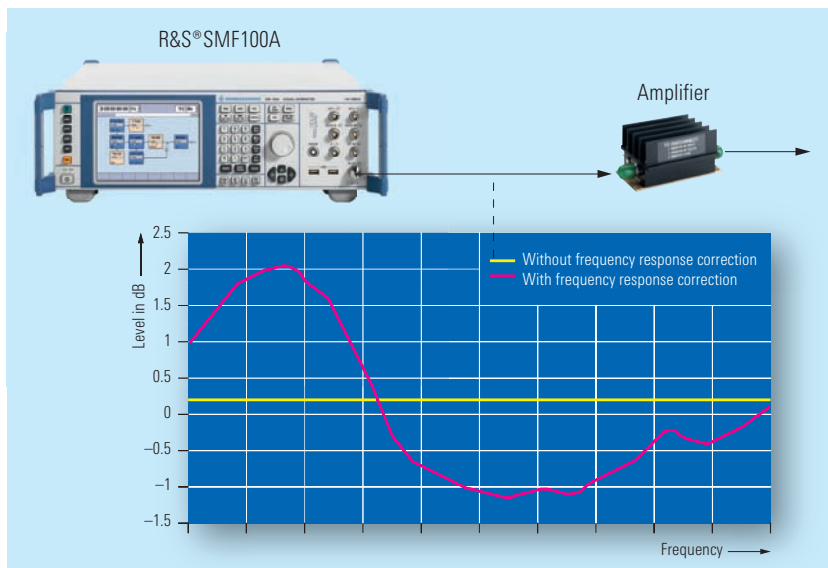

Output level of the R&S®SMF100A microwave signal generator with (red) and without (yellow) frequency response correction

Edit User Correction Data: Amplifier		
	Frequency/Hz	Power/dB
1	2 500 000 000.00	3.14
2	2 505 000 000.00	3.06
3	2 510 000 000.00	3.02
4	2 515 000 000.00	2.98
5	2 520 000 000.00	2.95
6	2 525 000 000.00	2.92
7	2 530 000 000.00	2.90
8	2 535 000 000.00	2.88
9	2 540 000 000.00	2.88
10	2 545 000 000.00	2.87
11	2 550 000 000.00	2.88
12	2 555 000 000.00	2.90

User correction table with frequency and level correction entries in Hz and dB, respectively

The figure on the right shows the compensated frequency response of the amplifier with activated "User correction" (straight line at 5.7 dBm starting at 2.5 GHz up to 3.5 GHz). This procedure ensures that only the frequency response of a bandpass filter is measured, for example, but not the combined frequency response of amplifier and bandpass.

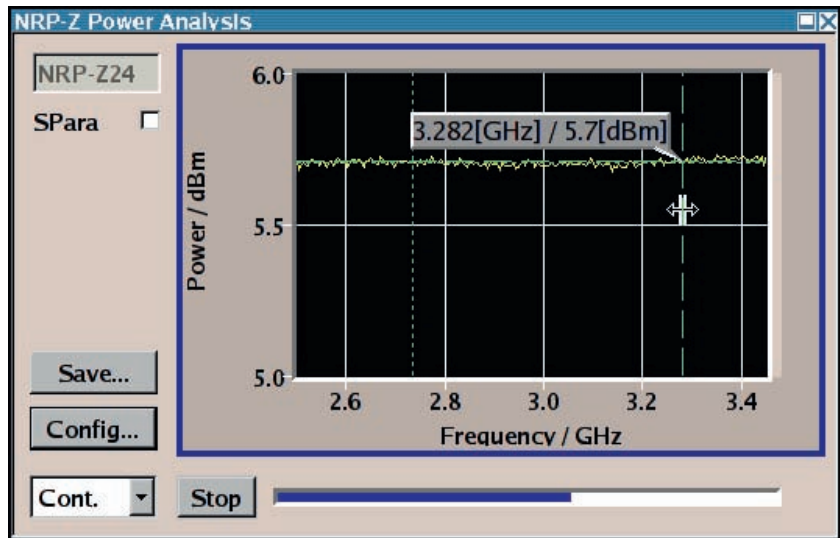

Output characteristic of an amplifier obtained by applying "User Correction", with the R&S®SMF-K28 power analysis option installed.

LO with exceptionally low SSB phase noise

Because of its very low SSB phase noise, the R&S®SMF100A can be used for a wide variety of applications. However, there are applications that require "worse" SSB phase noise for testing.

For these cases, the R&S®SMF100A offers a unique function: FM-modulated noise enables you to artificially degrade the instrument's low SSB phase noise in order to test the response of an oscillator or synthesizer, for example.

The figure shows an unmodulated CW signal and a signal that is FM-modulated with noise. By varying the FM deviation, you can degrade the SSB phase noise.

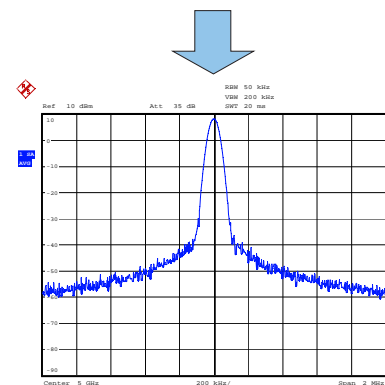
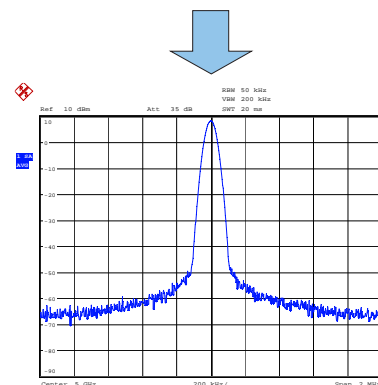
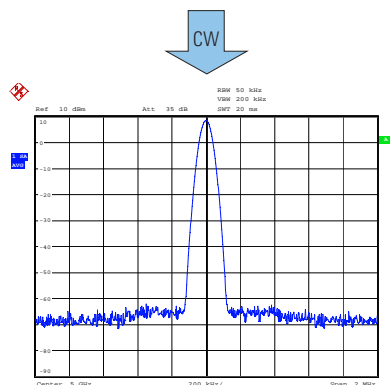
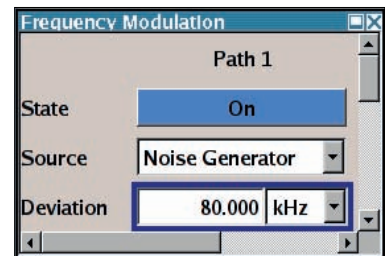
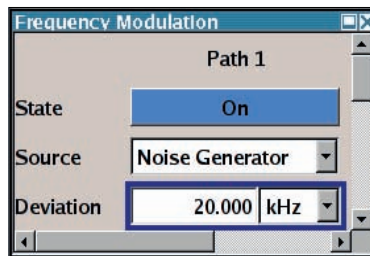
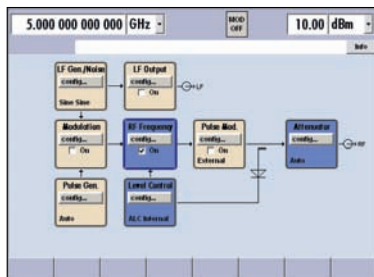

The R&S®SMF100A in the "FM-modulated noise" application

Aerospace & defense applications

The R&S®SMF100A can also be used in pulse radar applications with a rotating antenna. In the example (see figure), the external pulse from the pulse generator is applied to the external pulse input of the R&S®SMF100A and used as a trigger for the internal pulse generator and modulator. You can delay this trigger in order to perform distance and direction simulations and check them on the radar equipment's display.

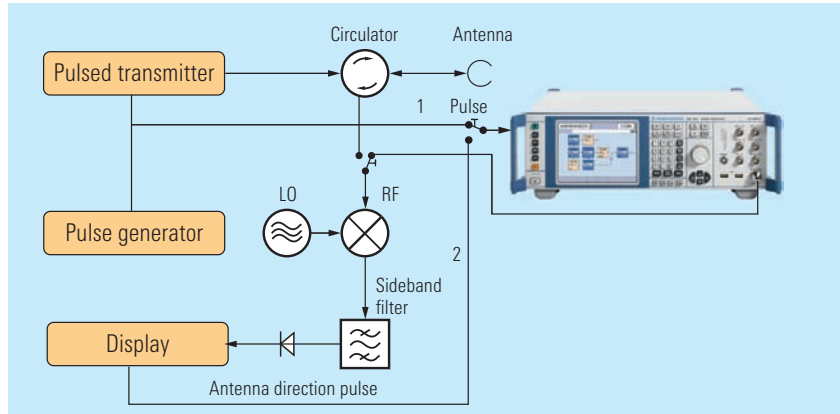

Testing of the distance and antenna direction display of the radar equipment

For generating more complex pulse scenarios, the R&S®SMF100A offers a new feature – based on its pulse modulator and pulse generator concept – using the R&S®SMF-K27 pulse train option. In contrast to single or double pulses, "pulse trains" are a combination of different pulses, which can be a periodical or non-periodical set of pulses. The built-in optional pulse generator makes it now possible to generate these "pulse trains", which are commonly used for radar applications. Pulse width as well as pulse pause can be set independently and separately for each pulse. This makes it possible to generate staggered pulses or to apply jitter to pulse width as well as pulse pause.

In contrast to ARB solutions, the greatest advantage is the much better performance of the pulse modulator with respect to ON/OFF ratio, rise and fall time, etc.

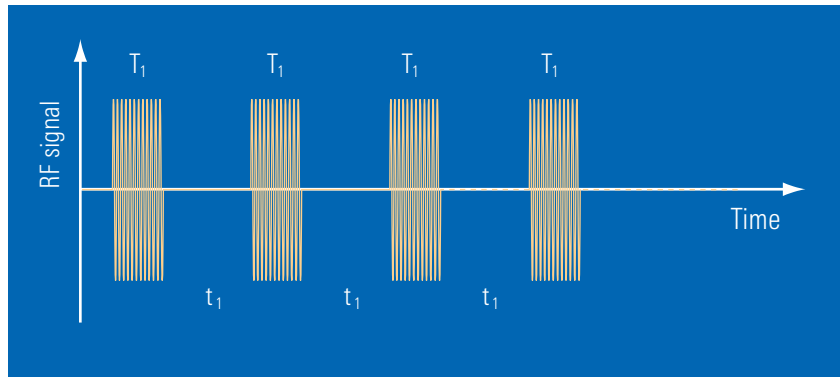

Single pulses

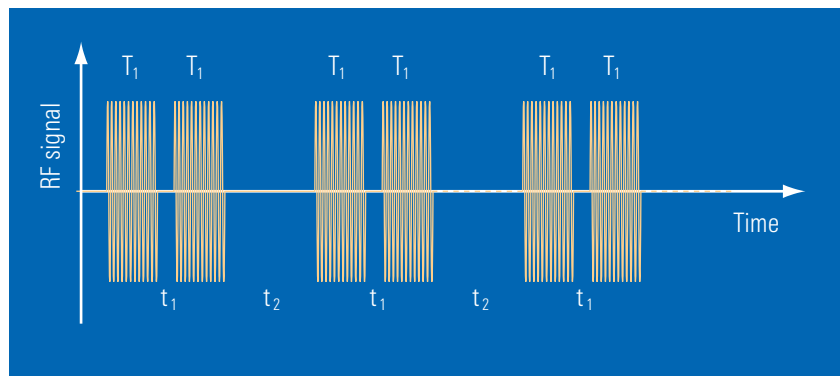

Double pulses

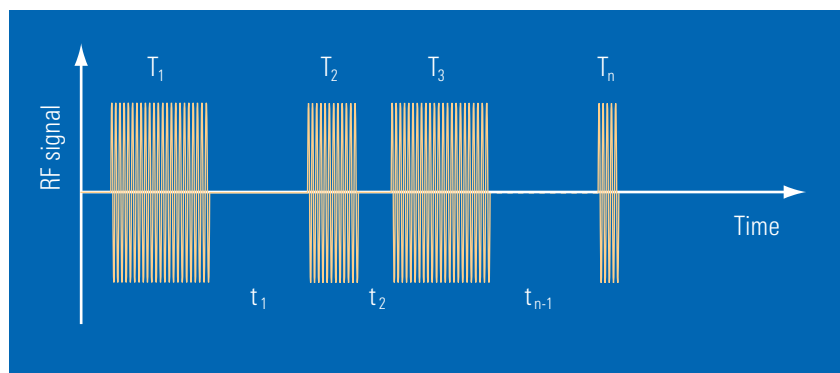

Pulse train (with the R&S®SMF-K27 pulse train option)

Special features

A unique feature of this microwave signal generator is that it allows you to directly connect an R&S®NRP-Zx power sensor. This has its advantages. The power sensor enables you to measure the power directly before the DUT and display it on the R&S®SMF100A. Irrespective of cable loss values or any components connected between the DUT and signal generator, you can thus set the desired power on the DUT by using the R&S®SMF100A microwave signal generator.

Another advantage becomes evident in the case of applications that require very high absolute level accuracy: The R&S®SMF100A can measure its own output power via an attached power sensor. Manual adjustment capability allows you to increase the instrument's exceptional absolute level accuracy even further.

You can operate the instrument both via the front-panel control elements or via a USB keyboard and USB mouse. To permit this, the front panel of the instrument provides two USB interfaces. In addition, an extra USB port is available on the rear panel (R&S®SMF-B84 option, master and slave USB).

The following question arises in many applications: How can I transfer instrument settings from one instrument to the other quickly and without errors? The solution is to use a memory stick. You merely need to use Save/Recall to quickly transfer instrument settings to a different R&S®SMF100A.



An R&S®NRP-Zx power sensor attached at the sensor connector

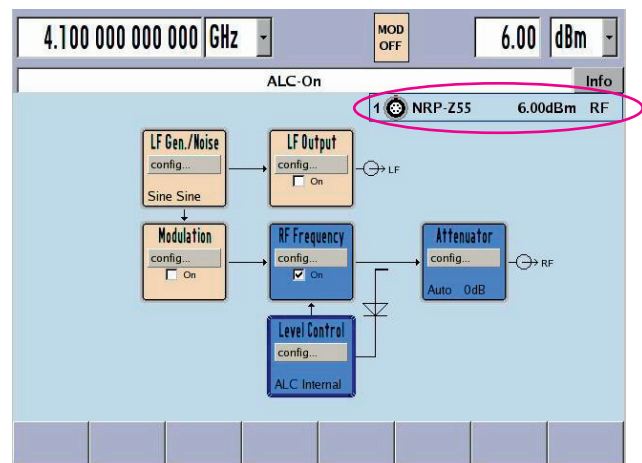

R&S®NRP-Z55 power sensor connected to the R&S®SMF100A RF output: The measurement result is displayed in the upper right of the block diagram



The R&S®SMF100A with USB mouse and keyboard attached

Specifications in brief

Frequency	
Frequency range	100 kHz to 43.5 GHz
Setting time	<4 ms
Setting time in List mode	typ. <700 μ s
Level	
Setting range	-130 dBm to +30 dBm
Setting time	<3 ms
Setting time in List mode	<700 μ s
Spectral purity	
SSB phase noise (at f = 10 GHz; 10 kHz carrier offset; 1 Hz measurement bandwidth)	<-115 dBc (typ. -120 dBc)
Supported modulation types with R&S®SMF-B20 option	AM/FM/ ϕ M/LOG AM
Interfaces	
Standard	LAN (100BaseT), 2 \times USB
With R&S®SMF-B83 option	IEEE 488.2
With R&S®SMF-B84 option	1 \times USB, 1 \times USB slave
With R&S®SMF-B85 option	removable flash disk

Ordering information

Designation	Type	Order No.
Microwave Signal Generator ¹⁾ Including power cable, Quick Start Guide, and CD-ROM (with operating and service manual)	R&S®SMF100A	1167.0000.02
Options		
Frequency Range 1 GHz to 22 GHz ²⁾ (3.5 mm female adapter included)	R&S®SMF-B122	1167.7004.03
Frequency Range 1 GHz to 43.5 GHz ²⁾ (2.4 mm female and 2.9 mm female adapter included)	R&S®SMF-B144	1167.7204.03
OCXO Reference Oscillator ^{3) 4)}	R&S®SMF-B1	1167.9159.02
Frequency Extension 100 kHz to 1 GHz ³⁾	R&S®SMF-B2	1167.4005.02
AM/FM/φM/LOG AM Modulator ³⁾	R&S®SMF-B20	1167.9594.02
Enhanced Phase Noise Performance ³⁾	R&S®SMF-B22	1415.2204.02
Step Attenuator 100 kHz to 22 GHz ³⁾	R&S®SMF-B26	1167.5553.02
Step Attenuator 100 kHz to 43.5 GHz ³⁾	R&S®SMF-B27	1167.5776.02
High Output Power (not in combination with R&S®SMF-B2) ³⁾	R&S®SMF-B32	1415.2304.02
High Output Power (in combination with R&S®SMF-B2) ³⁾	R&S®SMF-B34	1415.2404.02
Rear Connectors 22 GHz ³⁾	R&S®SMF-B81	1167.5999.02
Rear Connectors 43.5 GHz ³⁾	R&S®SMF-B82	1167.6208.02
Removable GPIB ⁵⁾	R&S®SMF-B83	1167.6408.02
Removable USB ⁵⁾	R&S®SMF-B84	1167.6608.02
Removable Flash Disk ^{3) 5)}	R&S®SMF-B85	1167.6808.02
Narrow Pulse Modulation	R&S®SMF-K3	1167.7804.02
Ramp Sweep	R&S®SMF-K4	1167.7604.02
Pulse Generator	R&S®SMF-K23	1167.7704.02
Pulse Train	R&S®SMF-K27	1415.2004.02
Power Analysis	R&S®SMF-K28	1415.2104.02
Service options		
Two-year Calibration Option	R&S®CO2SMF100A	1167.0000S15
Three-year Calibration Option	R&S®CO3SMF100A	1167.0000S11
Five-year Calibration Option	R&S®CO5SMF100A	1167.0000S13
Two-year Repair Option	R&S®RO2SMF100A	1167.0000S16
Three-year Repair Option	R&S®RO3SMF100A	1167.0000S12
Five-year Repair Option	R&S®RO5SMF100A	1167.0000S14
Documentation of Calibration Values	R&S®DCV-2	0240.2193.19
DKD (ISO 17025) Calibration including ISO 9000 calibration (can only be ordered with the instrument)	R&S®SMF22-DKD	1161.3594.00
DKD (ISO 17025) Calibration including ISO 9000 calibration (can only be ordered with the instrument)	R&S®SMF44-DKD	1161.3620.00

Designation	Type	Order No.
Recommended extras		
Wideband Power Sensor (for use with R&S®SMF-K28)	R&S®NRP-Z81	1137.9009.02
Hardcopy manuals (in English, UK)		1167.2319.32
Hardcopy manuals (in English, US)		1167.2319.39
Spare CompactFlash™ memory card (R&S®SMF-B85 required)	R&S®SMF-Z10	1167.8100.02
19" Rack Adapter	R&S®ZZA-311	1096.3277.00
Keyboard with USB Interface (US character set)	R&S®PSL-Z2	1157.6870.04
Mouse with USB Interface, optical	R&S®PSL-Z10	1157.7060.03
External USB DVD Drive	R&S®PSP-B6	1134.8201.22
Adapters for the R&S®SMF100A with the R&S®SMF-B122 frequency option		
3.5 mm female		1021.0512.00
3.5 mm male		1021.0529.00
N female		1021.0535.00
N male		1021.0541.00
Adapters for the R&S®SMF100A with the R&S®SMF-B144 frequency option		
2.4 mm female		1088.1627.02
2.9 mm female		1036.4790.00
2.9 mm male		1036.4802.00
N female		1036.4777.00
N male		1036.4783.00

¹⁾ The base unit can only be ordered together with the R&S®SMF-B122 or R&S®SMF-B144 frequency option.

²⁾ Option fitted by factory.

³⁾ Option fitted by factory or especially equipped Rohde & Schwarz service department.

⁴⁾ Option cannot be installed with an R&S®SMF-B22 enhanced phase noise performance option (not required).

⁵⁾ Only two of the three options R&S®SMF-B83, R&S®SMF-B84, and R&S®SMF-B85 can be installed simultaneously.



For data sheet, see PD 5213.7660.22
and www.rohde-schwarz.com



ROHDE & SCHWARZ

www.rohde-schwarz.com

Europe, Africa, Middle East +49 1805 12 42 42* or +49 89 4129 137 74 customersupport@rohde-schwarz.com

North America +1-888-TEST-RSA (1-888-837-8772) customer.support@rsa.rohde-schwarz.com

Latin America +1-410-910-7988 customersupport.la@rohde-schwarz.com

Asia/Pacific +65 65 13 04 88 customersupport.asia@rohde-schwarz.com