

## 7 Series DPO

### Digital Phosphor Oscilloscope Datasheet



#### Performance oscilloscope with low noise and high fidelity signal acquisition

With up to 25 GHz analog bandwidth, the 7 Series DPO provides the most accurate real time performance in its class:

- Low vertical (random) noise with high ENOB
- Fast throughput with 10 Gb Ethernet LAN SFP+ port
- Delightful, yet familiar built-for-touch UI and TekScope™ software, available with either embedded (Linux) or Windows OS

The 7 Series' low noise, high fidelity signal acquisition is critical for high bandwidth applications such as:

- Advanced research & investigation of transient phenomena
- Digital design & validation including signal integrity, jitter, and timing analysis
- Memory bus analysis and debug
- Compliance testing and debug of high speed serial interfaces for industry standards
- Analysis of signal integrity and power integrity in artificial intelligence data center development
- Spectral analysis of transient or wide-bandwidth RF

#### Key performance specifications

##### Input channels

- 4 TekConnect® each with TCA292D 50 Ω 2.92 mm input adapter
- 1 Aux In (TekConnect) with TCA292D 50 Ω 2.92 mm input adapter

##### Bandwidth (all analog channels)

- 8 GHz, 10 GHz, 13 GHz, 16 GHz, 20 GHz, 25 GHz (upgradable)

##### Sample rate (all analog channels)

- Real-time: 125 GS/s
- Interpolated: 12.5 TS/s

##### Record length (all analog channels)

- 500 Mpoints standard
- 1 or 2 Gpoints optional

##### Vertical resolution

- 10-bit ADC with high ENOB

##### Noise Reduction

- QuietChannel™ technology with Active CTLE (Continuous Time Linear Equalization) with 7 boost settings and one-button optimization routine which selects the optimal setting for the input signal to compensate for high-frequency signal channel loss.

##### Horizontal

Precision timebase with low intrinsic jitter.

##### Pinpoint® digital triggering to full bandwidth

- Allows selection of virtually all trigger types on both A and B trigger events delivering the full suite of advanced trigger types for finding sequential trigger events
- Edge, Pulse width, Timeout, Runt, Window, Cycle, Rise/Fall Time, Visual Trigger

##### Low-latency Aux In analog triggering

<20 ns from trigger in on Aux In and Ch1 to Aux Out BNC on rear panel.

### Probing

- P7700 & P7600 TriMode™ probing system – perfectly matched signal connectivity, with calibration to the probe tip
- TCA292D TekConnect™ Adapter

### Standard analysis

- Cursors: Waveform, V Bars, H Bars, V&H Bars
- Measurements: 36
- Plots: Time Trend, Histogram, Spectrum, and Phase Noise
- Math: Basic waveform arithmetic, FFT, and advanced equation editor
- Search: Search on any trigger criteria
- Jitter: TIE and Phase Noise

### Optional analysis

- Advanced Jitter and Eye Diagram Analysis (Opt 7-DJA)
- Signal Integrity Modeling for Embedding/De-embedding and Equalization (Opt 7-SIM, Opt 7-SIMA)
- User-defined filtering (Opt 7-UDFLT)
- Mask/Limit Testing (Opt 7-MTM)
- Time Domain Reflectometry (Opt 7-TDR)
- Advanced Vector Signal Analysis (SignalVu-PC)

### Optional compliance, protocol trigger, decode, and search

- PCIe, USB, DisplayPort, DDR and many other supports – refer to Ordering Information for complete list of supports

### Arbitrary Function Generator (Opt 7-AFG)

- 100 MHz waveform generation
- Waveform Types: Arbitrary, Sine, Square, Pulse, Ramp, Triangle, DC Level, Gaussian, Lorentz, Exponential Rise/Decay, Sin(x)/x, Random Noise, Haversine, Cardiac

### Trigger frequency counter (free with product registration)

- 11-digit

### Display

- 15.6 inch (396 mm) TFT color
- High Definition (1,920 x 1,080) resolution
- Capacitive (multi-touch) touchscreen

### Compute and storage

- 12-core processor, 96 GB System RAM
- ≥ 1.6 TB removable NVMe SSD (solid state drive)
- Std SSD: Closed Embedded OS, Opt SSD: Windows 10

### Connectivity

- LAN (10G Ethernet on SFP+ and 10/100/1000 Base-T Ethernet on RJ-45)
- USB 3.0 Host (3 front & 4 rear), USB 3.0 Device (1 port rear)
- DisplayPort, HDMI
- Sample Clock In/Out, Ext Ref In, Ref Clock Out, Sync In/Out, Aux Out

### e\*Scope®

- Remotely view and control the oscilloscope over a network connection through a standard web browser

### Dimensions

- 12.9 in (327 mm) x 22.1 in (560 mm) x 24.4 in (620 mm) (HxWxD with handles)
- 12.9 in (327 mm) x 17.9 in (454 mm) x 24.4 in (620 mm) (HxWxD without handles)

### Weight

- DPO714AX: 84 lbs. (38.1 kg)

### Warranty

- 1 year standard

### 7 Series Investment Protection Program (IPP)

As signals get faster and new standards are developed, your investment in a 7 Series oscilloscope can evolve with your needs. You can upgrade the bandwidth of the oscilloscope you own today. You can take advantage of 7 Series performance improvements by upgrading your existing MSO/DPO70000DX or DPO70000SX oscilloscope to a new 7 Series oscilloscope. Contact your local Tektronix representative to discuss the full range of options available with the 7 Series Investment Protection Program (IPP) to ensure you have the best tools you need for your next project.

## Low Noise, High ENOB - Unmatched Measurement Results

Maximize test margins with the low noise and high effective number of bits (ENOB) of the 7 Series DPO. Superior measurement accuracy, sensitivity and precision are enabled with our proprietary Tek85 low noise preamp, Tek79 10-bit ADC and advanced DSP algorithms providing more accurate capture and measurement of the signals of interest.

A practical way to demonstrate the innovation of the 7 Series DPO, especially in the effective number of bits (ENOB) and resultant signal-to-noise ratio (SNR), is to visually show the performance of the new signal path. In this image, the Gray Ref 1 waveform or “Ideal” signal at the top of the display is a sine wave that has been averaged 10,000 times to remove most of the

random noise. The blue Ref 2 sine wave shown on the bottom of the display is a single-shot acquisition using a 25 GHz, 8-bit oscilloscope that was previously captured and imported into the 7 Series DPO as a reference waveform. Next, Math 2 was defined to be the Ideal or Ref 1 minus Ref 2 resulting in a residual or difference waveform from the 8-bit scope, indicated by the green Math 2 waveform on the bottom of the display. In a perfectly noiseless system, this would be a flat line. Then we acquire a single shot on Channel 1 of the 7 Series DPO. Performing the same calculation as before on Ref 1 – Ch 1 results in a residual or difference waveform from the 7 Series DPO, shown here as the orange Math 1 waveform in the middle of the display. It is very easy to see that this results in a substantially smaller deviation from the ideal waveform compared to the 8-bit oscilloscope, showing the superior performance of the new front-end design of the 7 Series DPO.

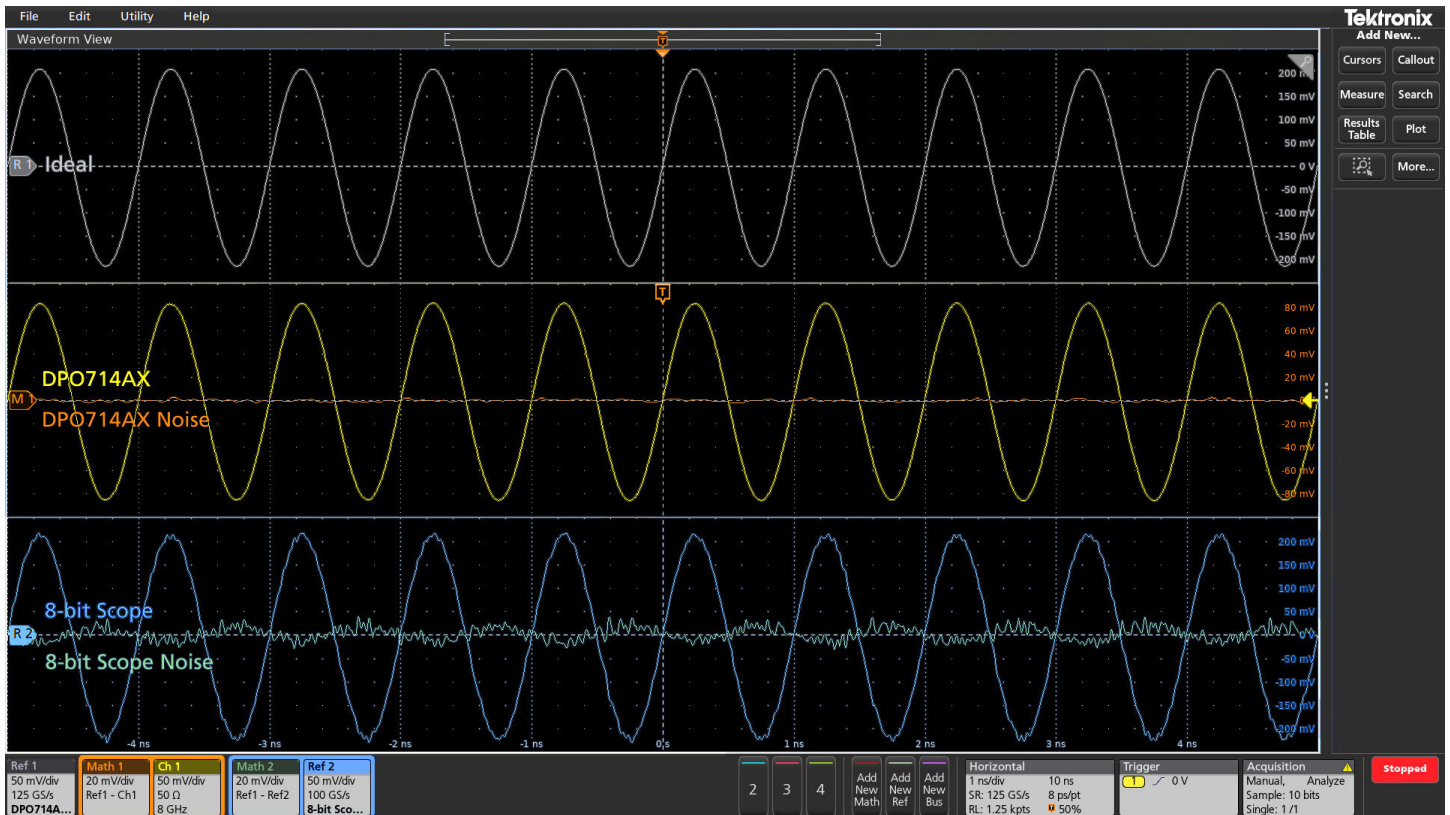

Visually show the performance of the new 7 Series DPO signal path.

### Highlights

- Resolve and measure low amplitude signals with low noise
- High Effective Number Of Bits (ENOB) enables high resolution signal digitization
- QuietChannel™ Technology further minimizes the noise from the oscilloscope signal path
- Fully automatic, built-in Signal Path Compensation (SPC) requires no user intervention to ensure optimal measurement accuracy by adjusting internal gain, offset, and frequency response to ensure precise signal capture and high effective number of bits (ENOB)

## Minimize test times with 10x throughput

With the built-in 10G SFP+ port and the TekHSI™ technology, the 7 Series DPO allows for up to 10x throughput of large waveform datasets to a PC enabling acquisition and analysis to be performed in parallel for faster workflows.

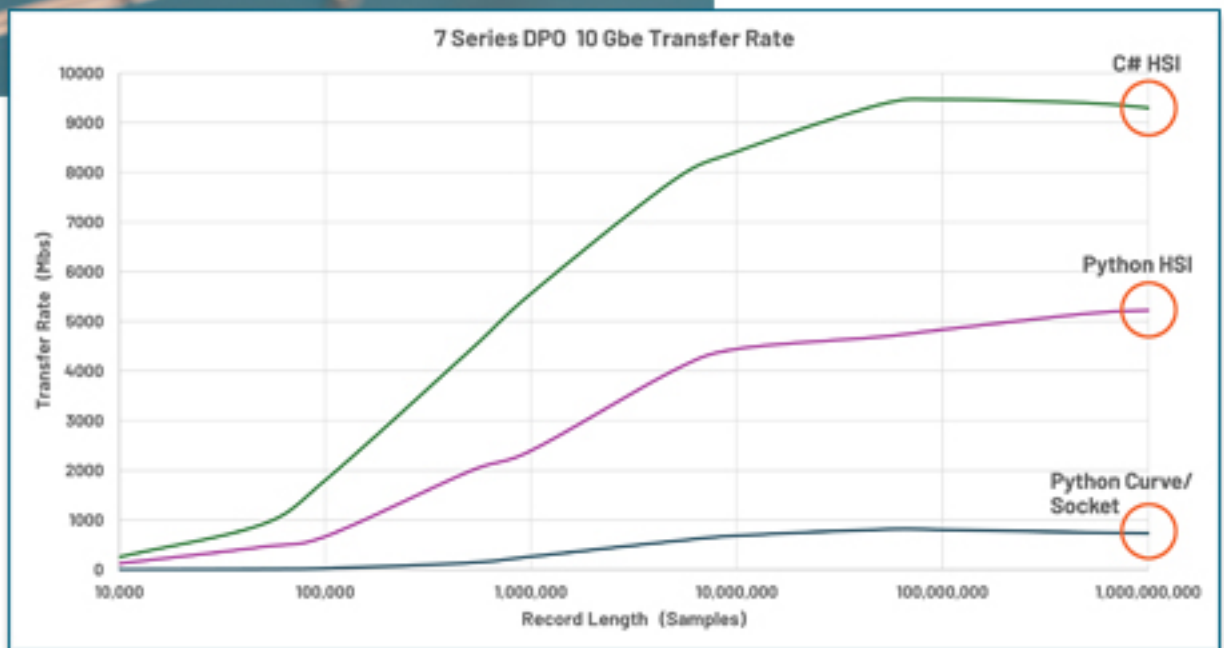

*Up to 10x throughput of large waveform datasets with 10G SFP+ port.*

### Highlights

- TekHSI technology is based on gRPC low latency framework to enable fetch and streaming data transfer almost as fast as the physical bandwidth of the link. Use with available C# and Python libraries
- 10G SFP+ port accepts choice of RJ-45 electrical, fiber optic, or direct attach transceiver modules
- TekScope™ PC natively supports the high-speed interface along with offline and remote oscilloscope-like analysis capabilities

## Get to results faster with award-winning, intuitive User Interface

A 15.6-inch display, with full 1080p resolution, and an award-winning, intuitive user interface that works the way you expect and gets you to test results faster.

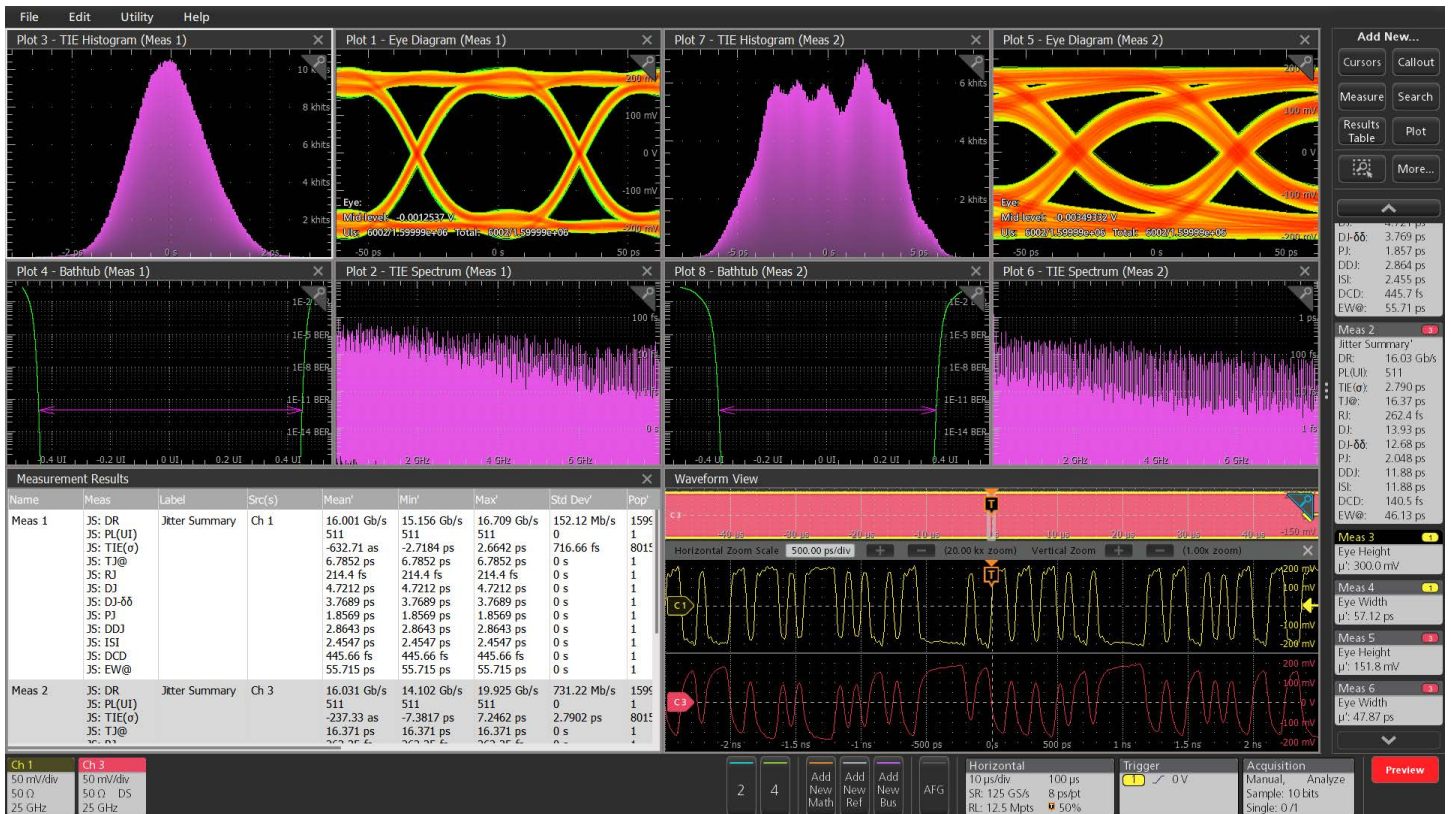

View multiple jitter measurement summaries on the large 15.6-inch 1080p display.

## Highlights

- Delightful user experience with the built for touch UI, and the same TekScope™ user interface found on the 2, 3, 4, 5 and 6 Series MSOs delivers quick insights
- Streamlines complex tasks with well-organized menu structure with minimal layers to quickly navigate settings, setup the instrument, configure measurements, and effortlessly move through acquired data
- Responsive touchscreen, optimized for multi-touch gestures, allows precise control over waveform analysis - quickly zoom into picosecond glitches or adjust measurement parameters for eye diagram analysis, ensuring accurate results
- Easy one button Jitter Measurement Summary provides comprehensive data including key plots, diagrams and measurements quickly on one channel or multiple channels at the same time
- Available with either embedded (Linux) or Windows OS

### Advanced Research Applications

The ideal companion tool for high energy physics, particle accelerators, beam diagnostic instrumentation, astrophysics radio detection, plasma/fusion research, and more.

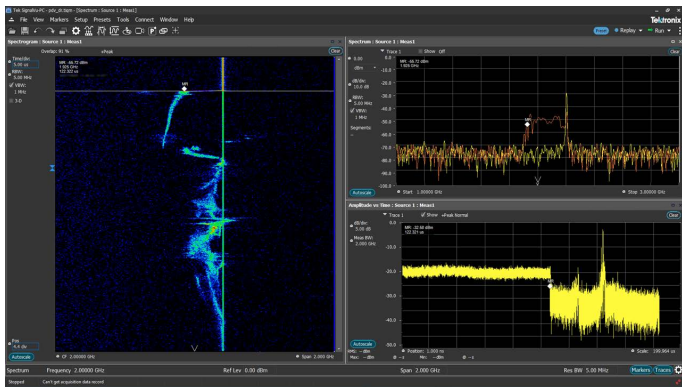

**Quickly display fast events using SignalVu-PC's spectrogram display, now available with Dark Mode.**

### Highlights

- 125 GS/s sampling rates with low noise and high ENOB to ensure capture of fast transient events with high signal fidelity combined with deep record lengths up to 2G for long-duration signal capture
- Precise channel-to-channel timing stability to ensure accurate multi-channel measurements
- Transfer data up to 10x faster to an external computer using the high-speed interface and 10 Gbps SFP+ port. Data is immediately pushed to connected clients ensuring data is off-loaded as quickly as possible
- Tightly synchronize the 7 Series DPO with other equipment using the oscilloscope's low-latency (<20 ns) trigger in-to-out capability
- SignalVu-PC's spectrograms, spectra and amplitude quickly provide other views of critical experiment data for specific applications such as PDV and others

## High Speed Serial Compliance Testing and Debug

Test to current and emerging standards and reduce your time to market.

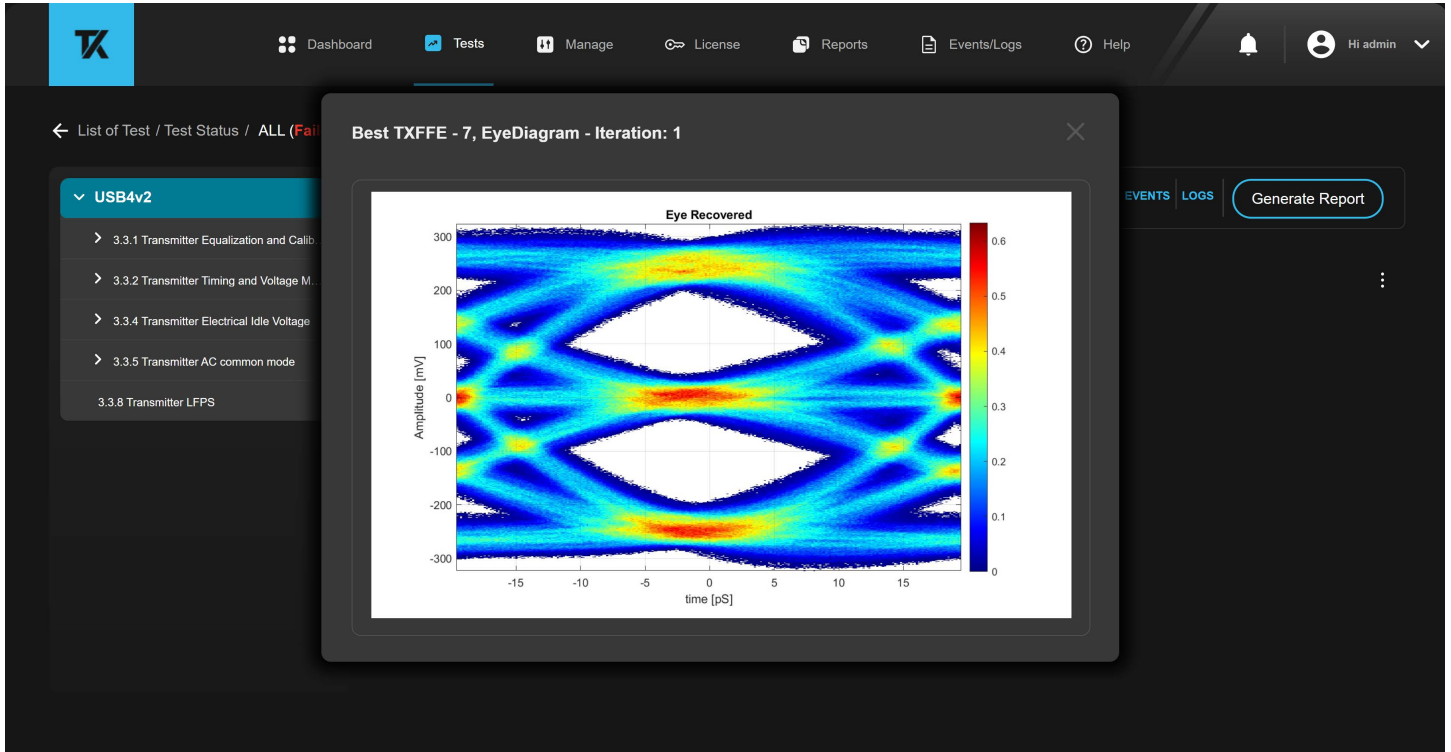

*Automated compliance testing software for USB4v2 manages the whole testing process.*

### Highlights

- Save time with fast automated compliance testing software (various options) for PCIe, USB, DisplayPort, HDMI, DDR, LPDDR and MIPI
- Gain enhanced insight with comprehensive Jitter and Eye-Diagram Analysis (option DJA) featuring detailed jitter breakdown, unmatched flexibility, and visualization
- Maximize test margins with the low noise and low intrinsic jitter
- Reveal true DUT behavior with de-embedding, embedding, and equalization using Signal Integrity Modeling software (option SIM)

Automated compliance testing software manages the whole testing process – set-up, making measurements, checking against limits, and generating detailed reports.

## Wideband Radio Frequency Systems

With its low noise and flat frequency response, the 7 Series DPO can perform the measurement and analysis of wideband RF signals in electronic warfare, spectrum monitoring, SIGINT, 5G networks, mmWave RF bands, and Ultra-wideband (UWB) communications applications and more. Gather data faster for wideband RF research with ultra-wide bandwidths, easier signal connectivity and the flexibility to perform online and offline analysis of RF signal behavior.



Simultaneously analyze multiple channels using SignalVu-PC, now available in Dark Mode.

### Highlights

- A 4 channel, 25 GHz bandwidth multi-channel, multi-domain Vector Signal Analysis (VSA) solution when paired with SignalVu-PC software
- Enables in-depth transient RF signal analysis, detailed RF pulse characterization, and comprehensive analog and digital RF modulation analysis
- Simultaneously acquire, independently configure settings on each channel and analyze signals on all channels
- Time-correlated measurements between channels can be made across the frequency, phase, amplitude, and modulation domains

## Experience the performance difference

With up to 25 GHz analog bandwidth, 125 GS/s sample rates, standard 500 Mpts record length and a low-noise, 10-bit analog to digital converter (ADC) signal path, the 7 Series DPO has the performance you need to capture waveforms with the best possible signal fidelity and resolution for seeing small waveform details.

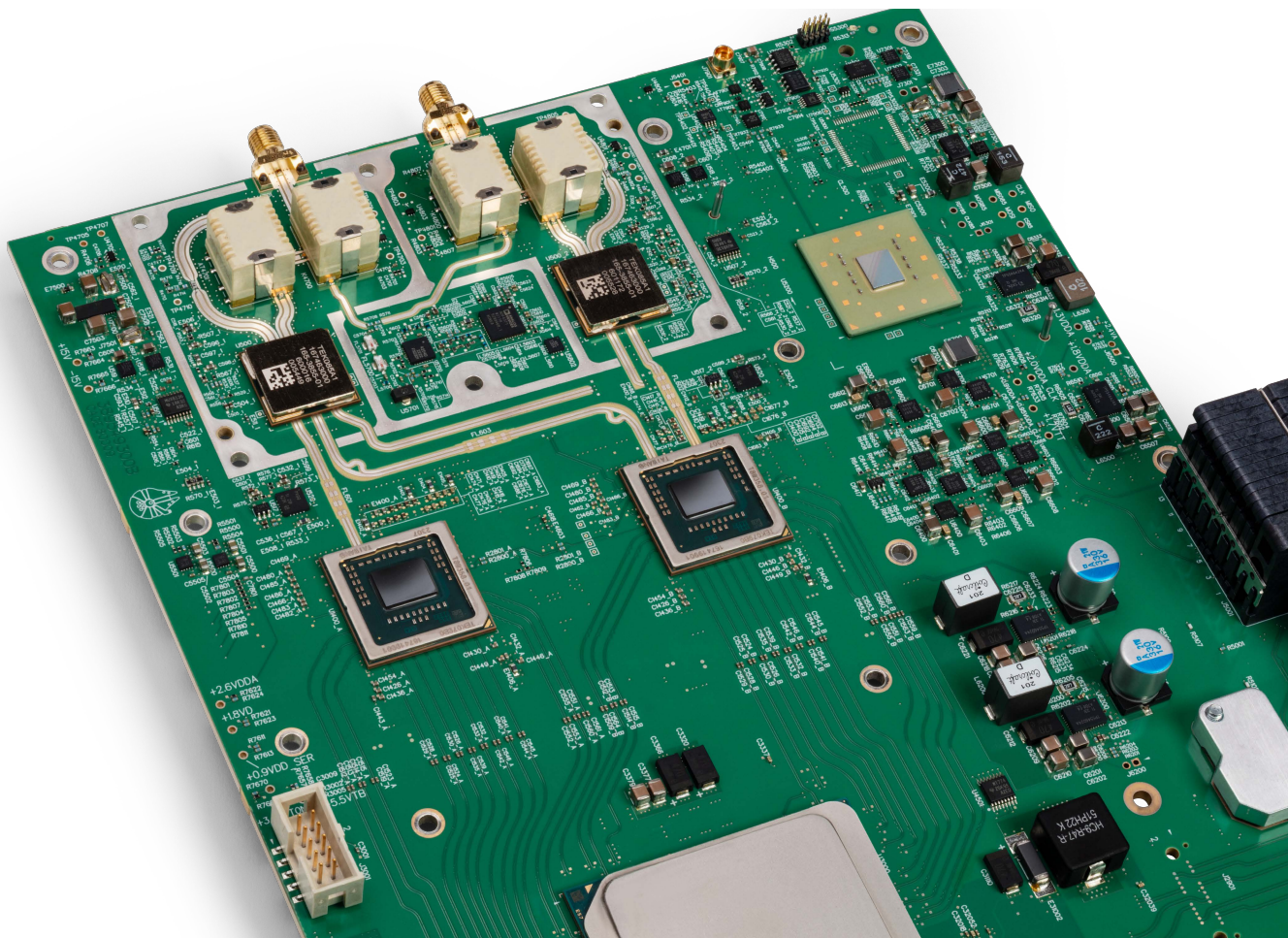

*New high-performance signal path utilizing custom ASIC technology.*

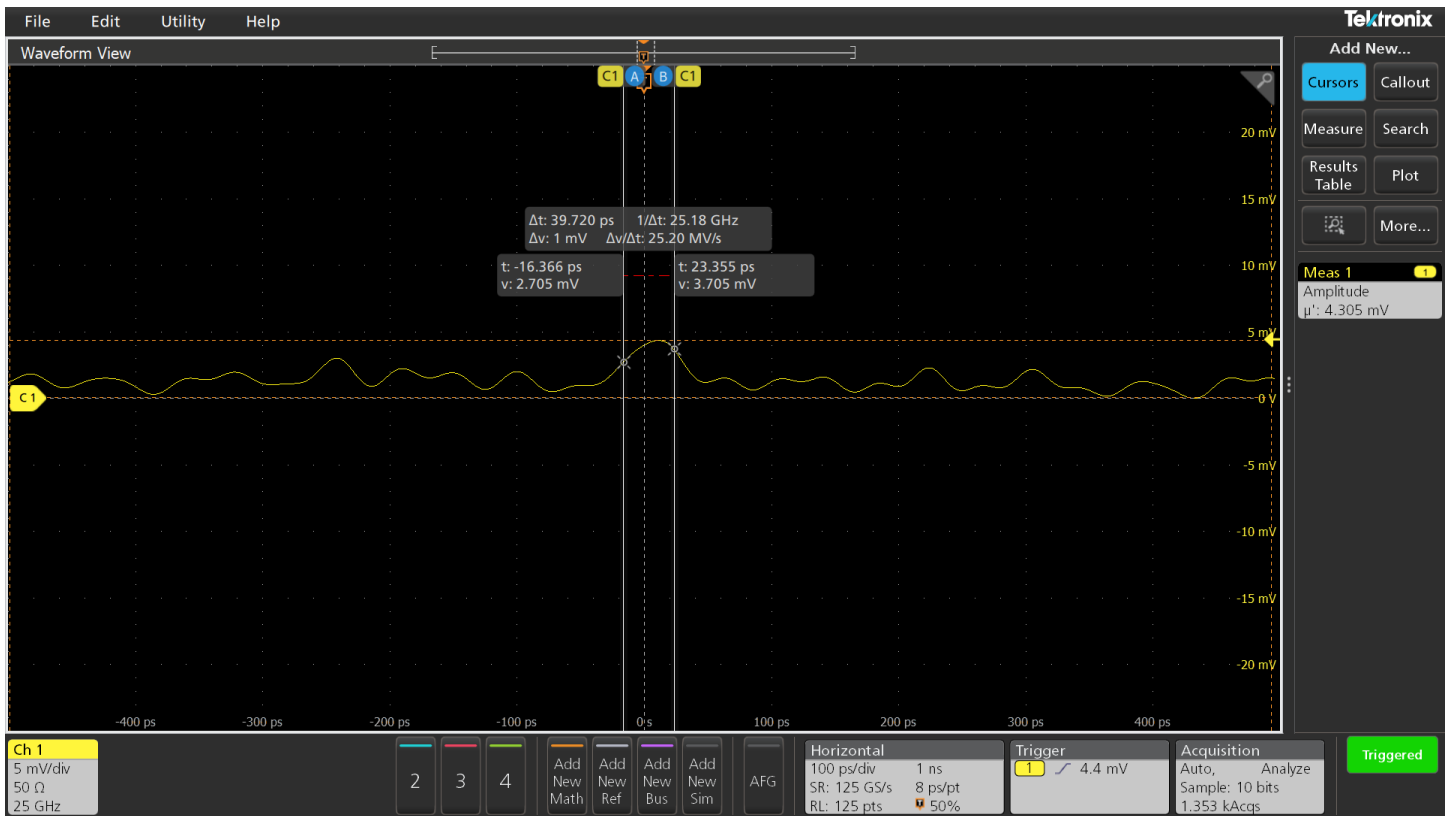

**7 Series DPO can trigger on pulses as narrow as 32 ps and as low as 1 division, enabling capture of elusive events.**

### Industry leading vertical resolution and low noise

The 7 Series DPO provides the performance to capture the signals of interest while minimizing the effects of unwanted noise when you need to capture high-amplitude signals while seeing smaller signal details. At the heart of the instrument are precision 10-bit analog-to-digital converters (ADCs) that provide 4 times the vertical resolution of traditional 8-bit ADCs.

### QuietChannel™ technology

Active devices in oscilloscopes add noise to the measured signal. The added noise is amplified by compensation for loss in the scope and DUT:

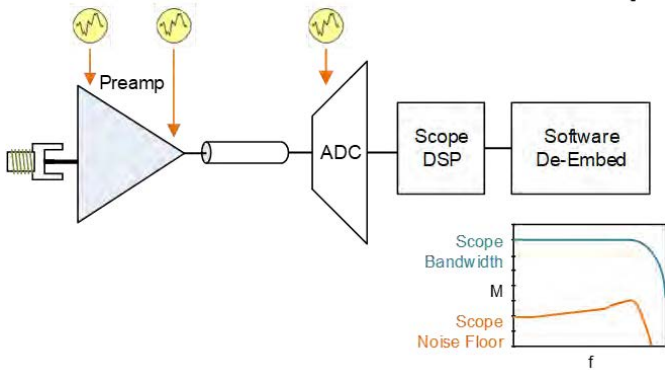

QuietChannel™ technology peaks the high frequency response of the oscilloscope ahead of ADC noise. HW DSP then cancels out the peaking, resulting in a well-shaped noise floor:

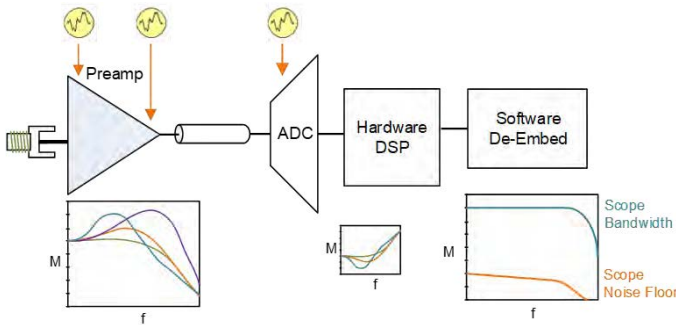

The 7 Series DPO has seven QuietChannel™ technology settings. These settings target different center frequencies and amounts of loss.

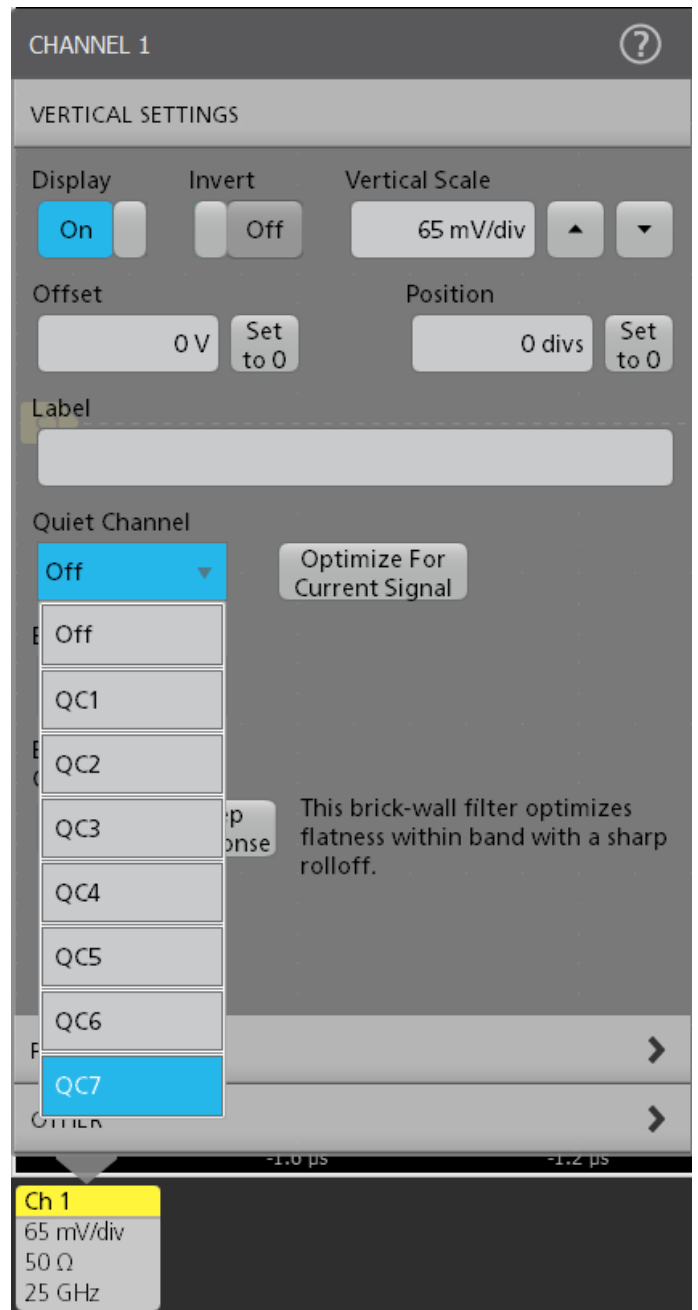

Using QuietChannel™ technology is straightforward. Connect the 7 Series to your DUT, then press the Autoset button to configure the oscilloscope to acquire and display the signal. From the Vertical Settings menu, press the Optimize For Current Signal button to determine the best settings given the characteristics of the signal.

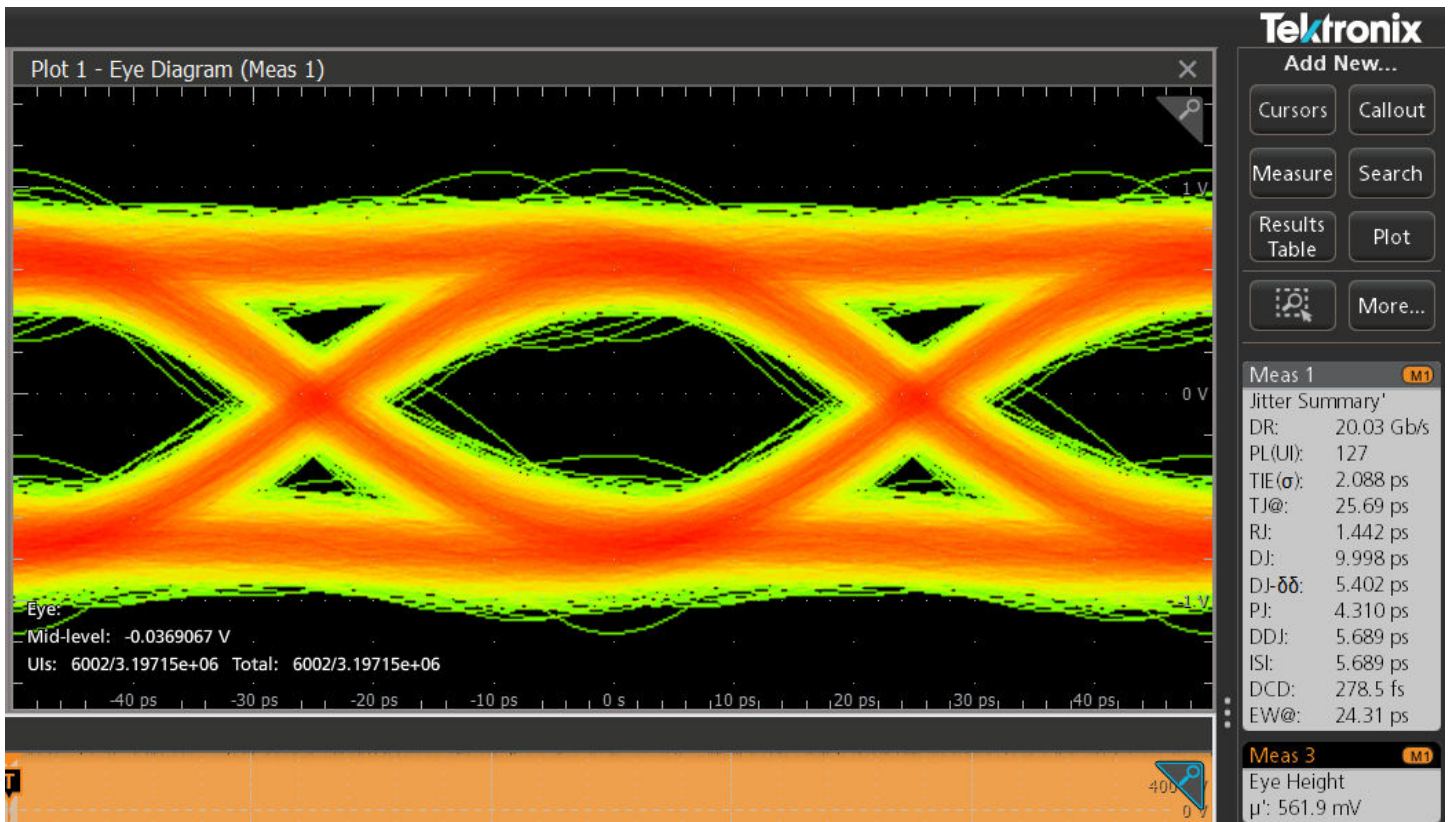

*This eye diagram above of a 20 Gb/s signal at the end of a 24-inch trace shows an eye width of 24.31 ps and eye height of 561.9 mV before applying QuietChannel™ technology.*

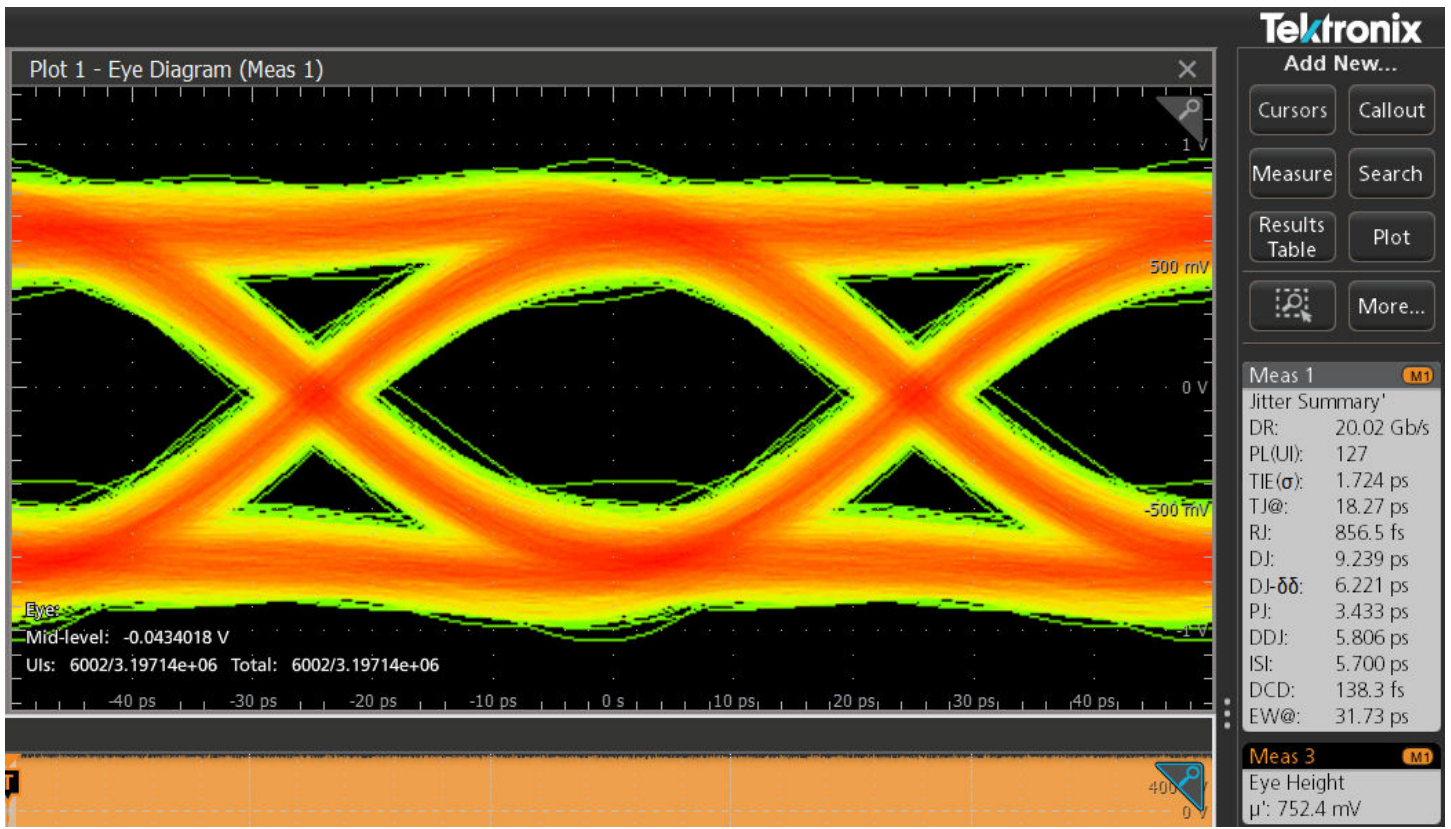

**Applying QuietChannel™ technology now shows an eye width of 31.73 ps (30% improvement) and an eye height of 752.4 mV (34% improvement).**

## TekConnect™ Probe Interface

The TekConnect probe interface sets the standard for ease of use in probing. In addition to the secure, reliable connection that the interface provides, many TekConnect probes feature status indicators and controls, as well as a probe menu button right on the comp box itself. This button brings up a probe menu on the oscilloscope display with all relevant settings and controls for the probe. The TekConnect interface enables direct attachment of current probes without requiring a separate power supply. TekConnect probes can be controlled remotely through USB or LAN, enabling more versatile solutions in ATE environments. The 7 Series DPO provides plenty of power to the front panel connectors, sufficient to power all connected TekConnect probes without the need for an additional probe power supply.



The P7700 and P7600 TriMode probes allow you to switch among differential, single ended, and common-mode measurements without moving the probe from its connection points. The P7700 Series TriMode probes with low noise provide connectivity innovations such as solder down tips with the probe's input buffer mounted only a few millimeters from the end of the tip. The P7600 Series combines low noise, 33 GHz bandwidth in a remote head form factor with the convenience of Trimode probing.

The TCA292D allows you to use  $\geq 25$  GHz 2.92 mm coax cables and connectors.

## Pinpoint® digital triggering to full bandwidth - Ultimate flexibility with Sequential AB Triggering

Whether you're trying to find a problem signal or need to isolate a section of a complex signal for further analysis, Tektronix Pinpoint® digital triggering to the full bandwidth of the instrument provides the solution.

Discovering a device fault is only the first step. Next, you must capture the event of interest to identify root cause. The 7 Series DPO provides a complete set of advanced triggers, including:

- Edge
- Pulse width
- Timeout
- Runt
- Window
- Cycle
- Rise / Fall Time
- Visual Trigger

With up to a 2 Gpoint record length and up to 25 GHz trigger bandwidth on all trigger types, not just edge triggers, you can capture many events of interest, even thousands of serial packets in a single acquisition, providing high-resolution to zoom in on fine signal details and record reliable measurements.

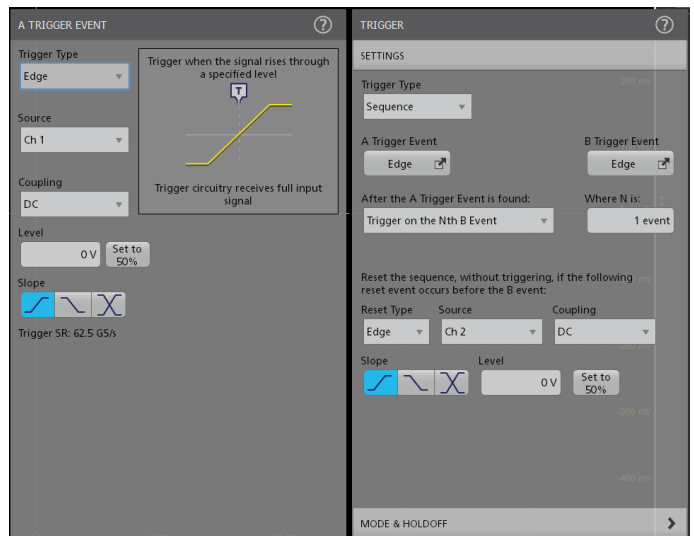

*The wide variety of trigger types and context-sensitive help in the trigger menu make it easier than ever to isolate the event of interest.*

Pinpoint® triggering allows selection of virtually all trigger types on both A and B trigger events delivering the full suite of advanced trigger types for finding sequential trigger events. Pinpoint® triggers provide trigger reset capabilities that begin the trigger sequence again after a specified time, state, or transition so that even events in the most complex signals can be captured. Pinpoint® triggering offers over 1400 combinations, all that operate at the full acquisition analog bandwidth. Visual Trigger extends the Pinpoint Triggering's capabilities, adding another level of trigger qualification to find important events in a wide variety of complex signals.

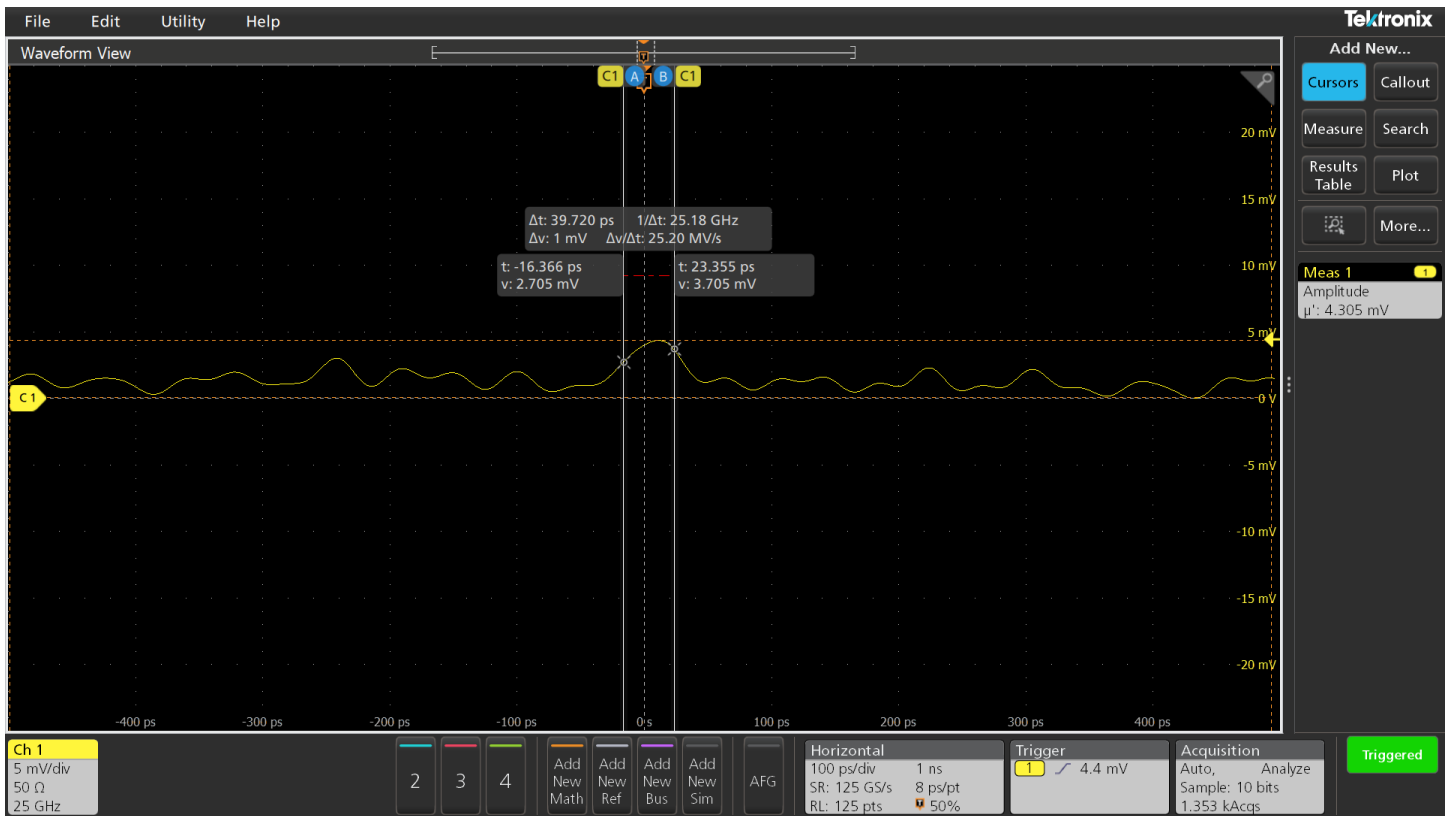

**7 Series DPO can trigger on pulses as narrow as 32 ps and as low as 1 division, enabling capture of elusive events.**

With the 7 Series DPO's enhanced triggering capability, trigger jitter is reduced to <10 fs. With this stability at the trigger point, the trigger point can be used as a measurement reference.

**B scan event trigger**

Users who wish to create eye diagrams from data bursts synchronized or initiated by an A event will find the B Event Scan trigger function especially useful. B Event Scan is an A to B trigger sequence that will trigger and capture burst event data of interest defined by the B Event setup menu. Captured bits can be scanned in a sequential or randomized fashion, alternatively the trigger can toggle between two successive B trigger events.

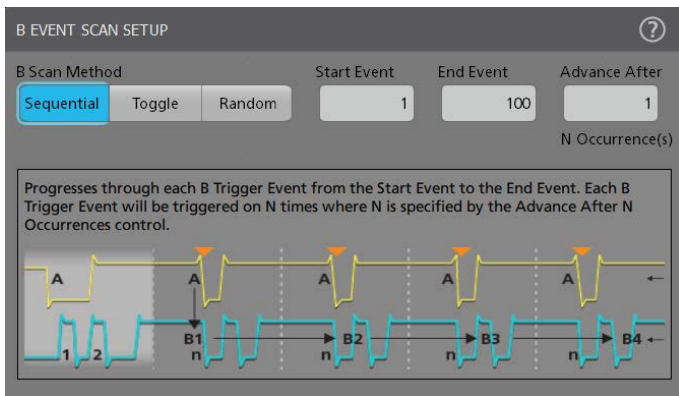

## Low-latency trigger mode

While there are many advantages to these advanced or digital triggers that operate at the full acquisition analog bandwidth, one drawback is the latency or time it takes for an event to propagate from the input channel and/or Aux In on the front of the oscilloscope to the Aux Out connector on the rear of the oscilloscope. This latency can often exceed 1  $\mu$ S. For many applications, this is not an issue, but for certain applications where cross-triggering other instrumentation within tens of nanoseconds of the event appearing at the input channel and/or Aux In on the front is a requirement which digital triggers cannot satisfy. Fortunately, the 7 Series DPO contains a low-latency trigger mode for Channel 1 and/or Aux In which has a delay of < 20 ns.

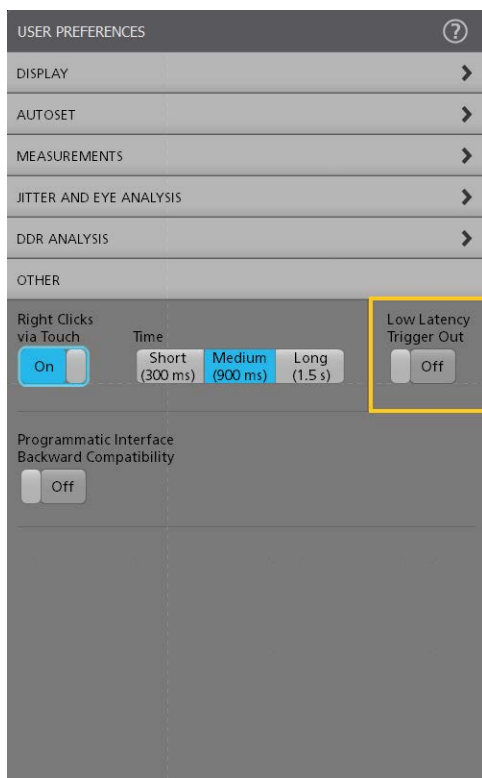

***The low-latency trigger mode for Channel 1 and/or Aux In is available in the User Preferences menu with a message in the trigger menu that it is active.***

## 7 Series DPO Digital Phosphor Oscilloscope Datasheet

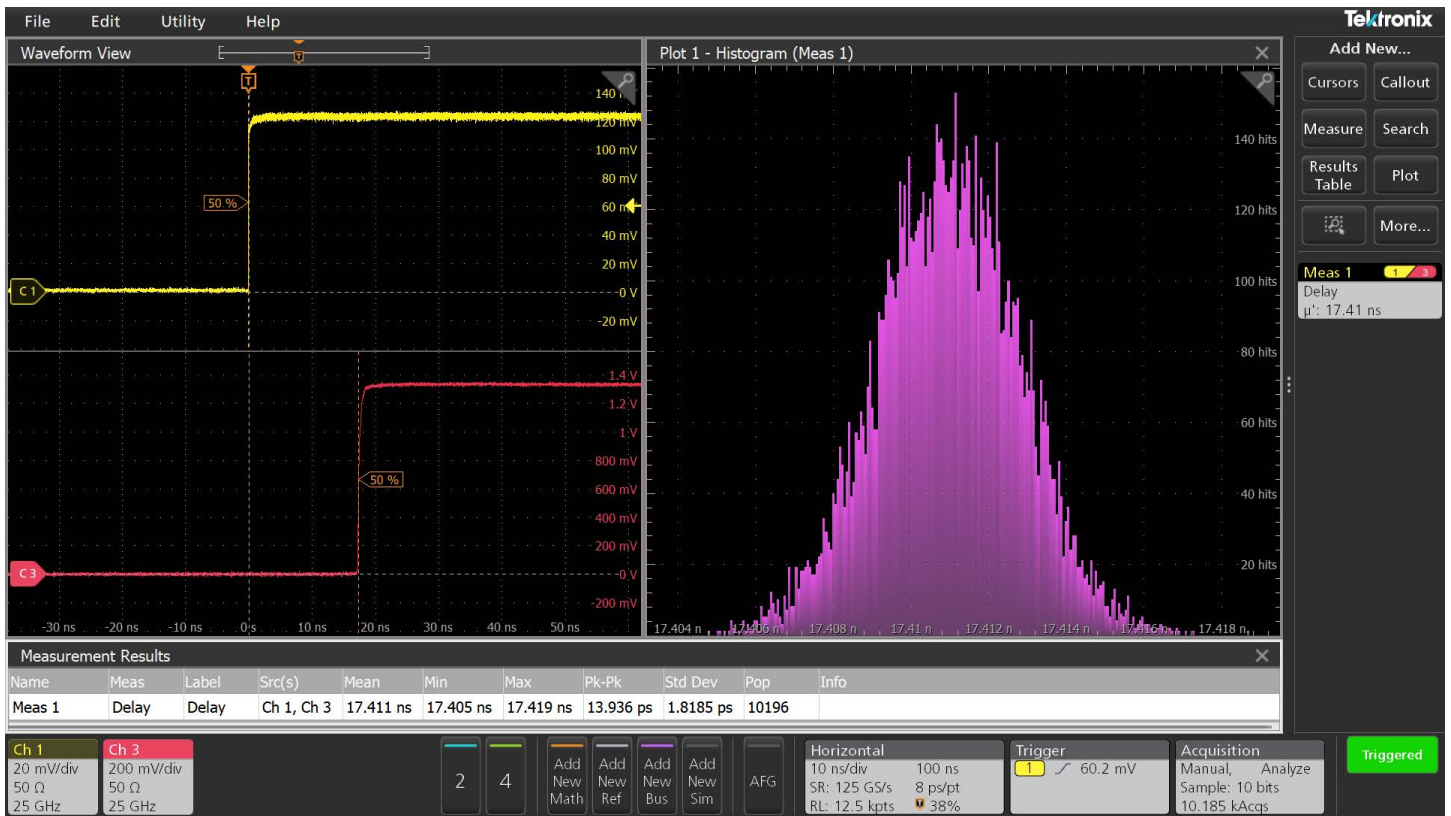

**Measuring the latency of a trigger on Channel 1 to Aux Out is <20 ns.**

### Visual trigger - Finding the signal of interest quickly

Finding the right cycle of a complex bus can require hours of collecting and sorting through thousands of acquisitions for an event of interest. Defining a trigger that isolates the desired event speeds up debug and analysis efforts.

Visual Trigger extends the 7 Series Pinpoint® triggering capabilities by scanning through all waveform acquisitions and comparing them to on-screen areas (geometric shapes). An unlimited number of areas can be created using a mouse or touchscreen, and a variety of shapes (triangles, rectangles, hexagons, or trapezoids) can be used to specify the desired trigger behavior. Once shapes are created, they can be edited interactively to create custom shapes and ideal trigger conditions.

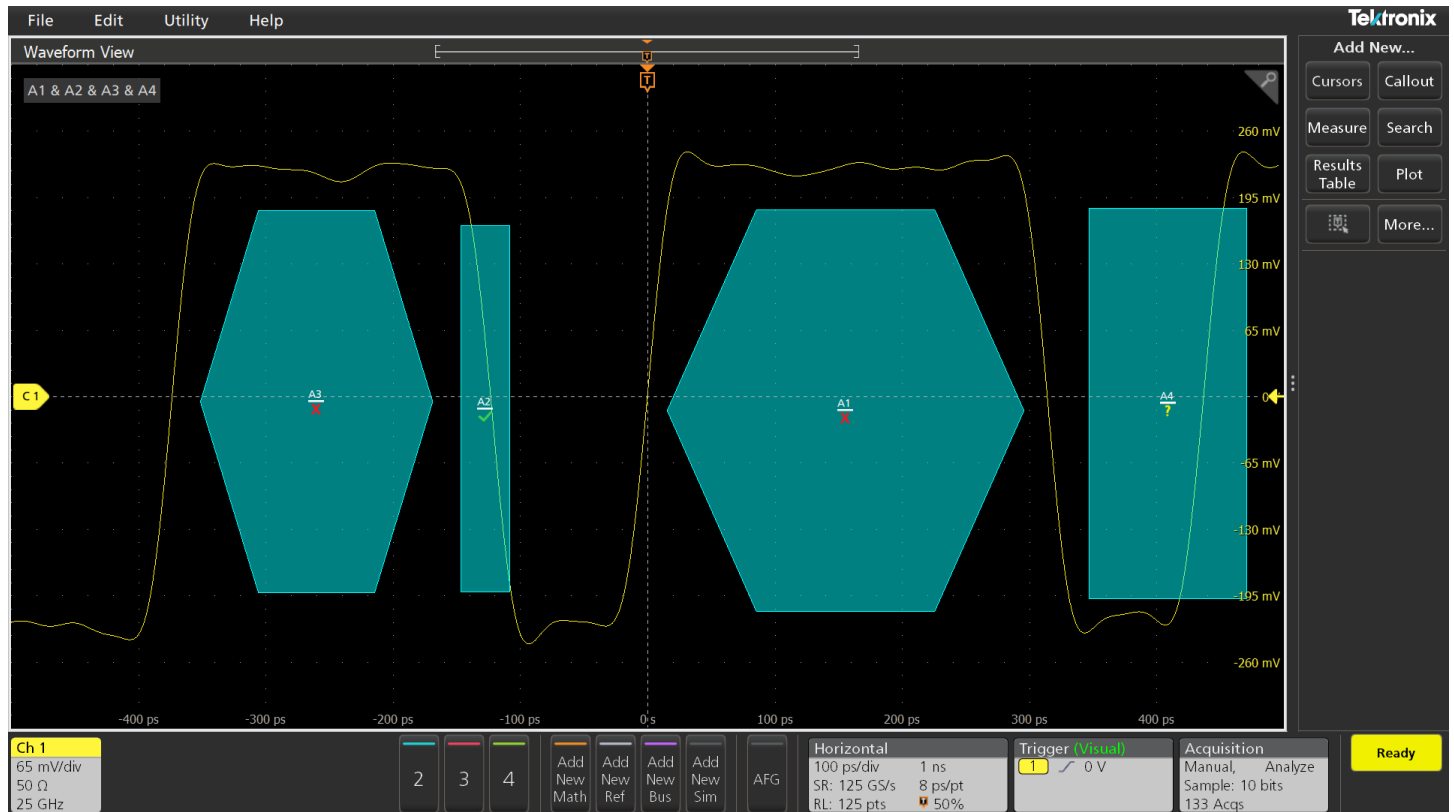

**Visual Trigger areas isolate an event of interest, saving time by only capturing the events you want to see.**

By triggering only on the most important signal events, Visual Trigger can save hours of capturing and manually searching through acquisitions. In seconds or minutes, you can find the critical events and complete your debug and analysis efforts. Visual Trigger even works across multiple channels, extending its usefulness to complex system troubleshooting and debug tasks.

## 7 Series DPO Digital Phosphor Oscilloscope Datasheet



**Multiple channel triggering. Visual Trigger areas can be associated with events spanning multiple channels such as packets transmitted on two bus signals simultaneously.**

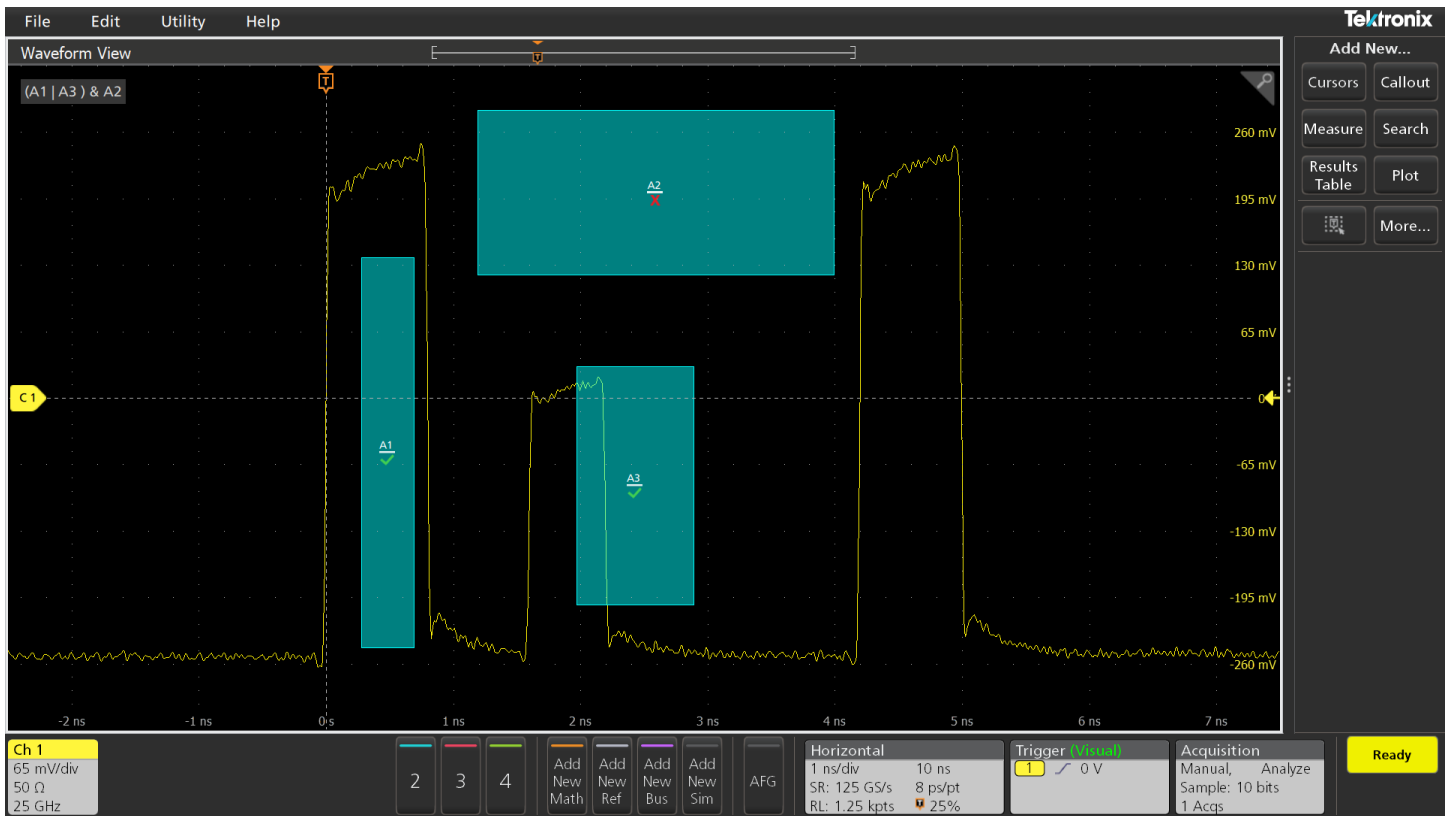

**Boolean logic trigger qualification. Boolean logic using logical OR allows triggering on a specific anomaly in the signal.**

## Unprecedented signal viewing capability

Leveraging the same user interface from our 2 Series through 6 Series B, the stunning 15.6 inch (396 mm) display with full HD resolution (1,920 x 1,080), enables you to see many signals at once with ample room for critical readouts and analysis.

The viewing area is optimized to ensure that the maximum vertical space is available for waveforms. The Results Bar on the right can be hidden, enabling the waveform view to use the full width of the display.

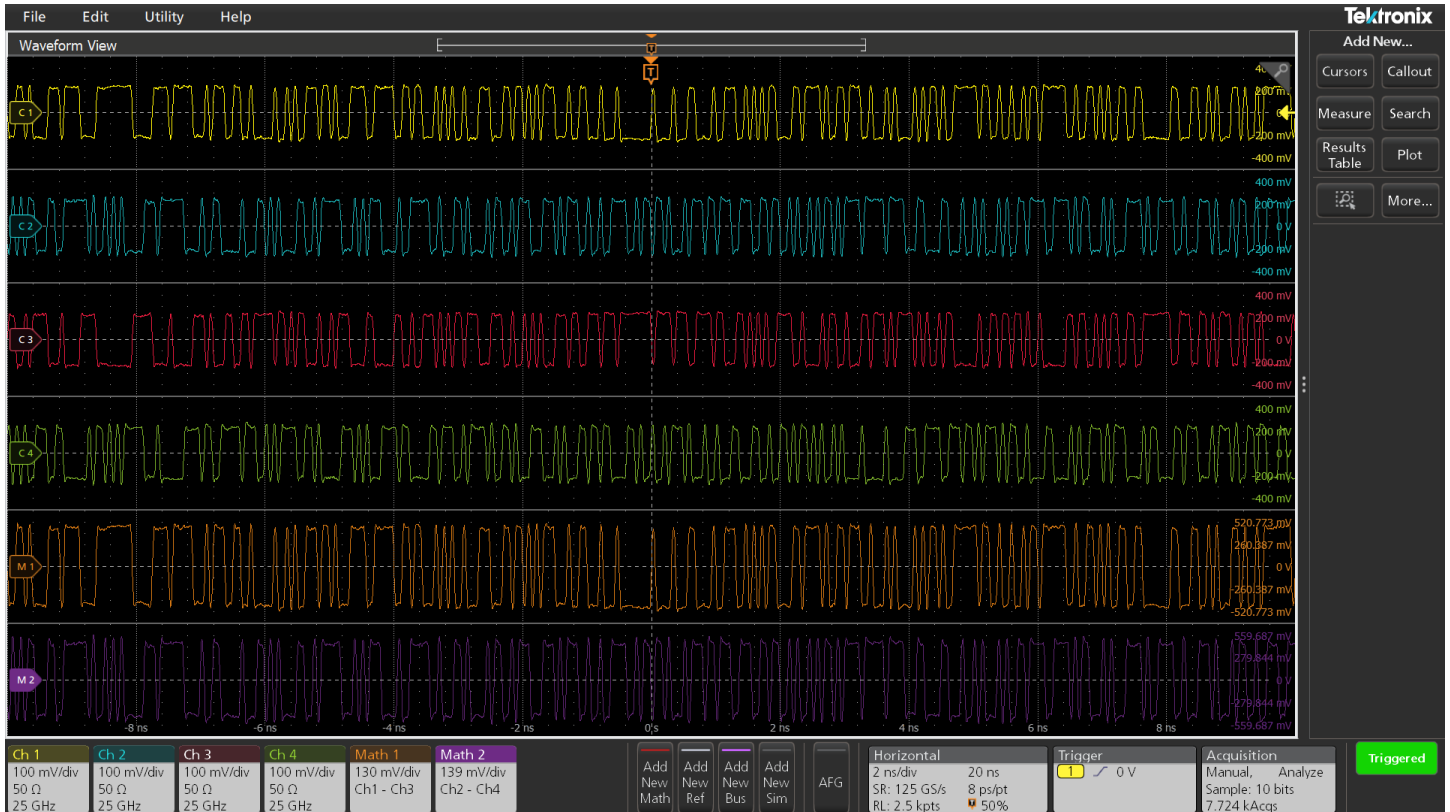

### Stacked display mode enables easy visibility of all waveforms while maintaining maximum ADC resolution on each input for the most accurate measurements.

The 7 Series DPO offers a revolutionary Stacked display mode. Historically, scopes have overlaid all waveforms in the same graticule, forcing difficult tradeoffs:

- To make each waveform visible, you vertically scale and position each waveform so that they don't overlap. Each waveform uses a small percentage of the available ADC range, leading to less accurate measurements.
- For measurement accuracy, you vertically scale and position each waveform to cover the entire display. The waveforms overlap each other, making it hard to distinguish signal details on individual waveforms.

The Stacked display eliminates this tradeoff. It automatically adds and removes additional horizontal waveform 'slices' (additional graticules) as waveforms are created and removed. Each slice helps you get the most out of the newly developed custom 10-bit

analog-to-digital converters by allocating separate full-resolution graticules for each waveform. Each graticule represents the full dynamic range of the ADC while maintaining the often-preferred view where the waveforms are separated and compared.

And it is all done automatically as waveforms are added or removed. Channels can easily be reordered in stacked display mode by dragging and dropping the channel and waveform badges in the Settings bar at the bottom of the display. Groups of channels can also be overlaid within a slice to simplify visual comparison of signals.

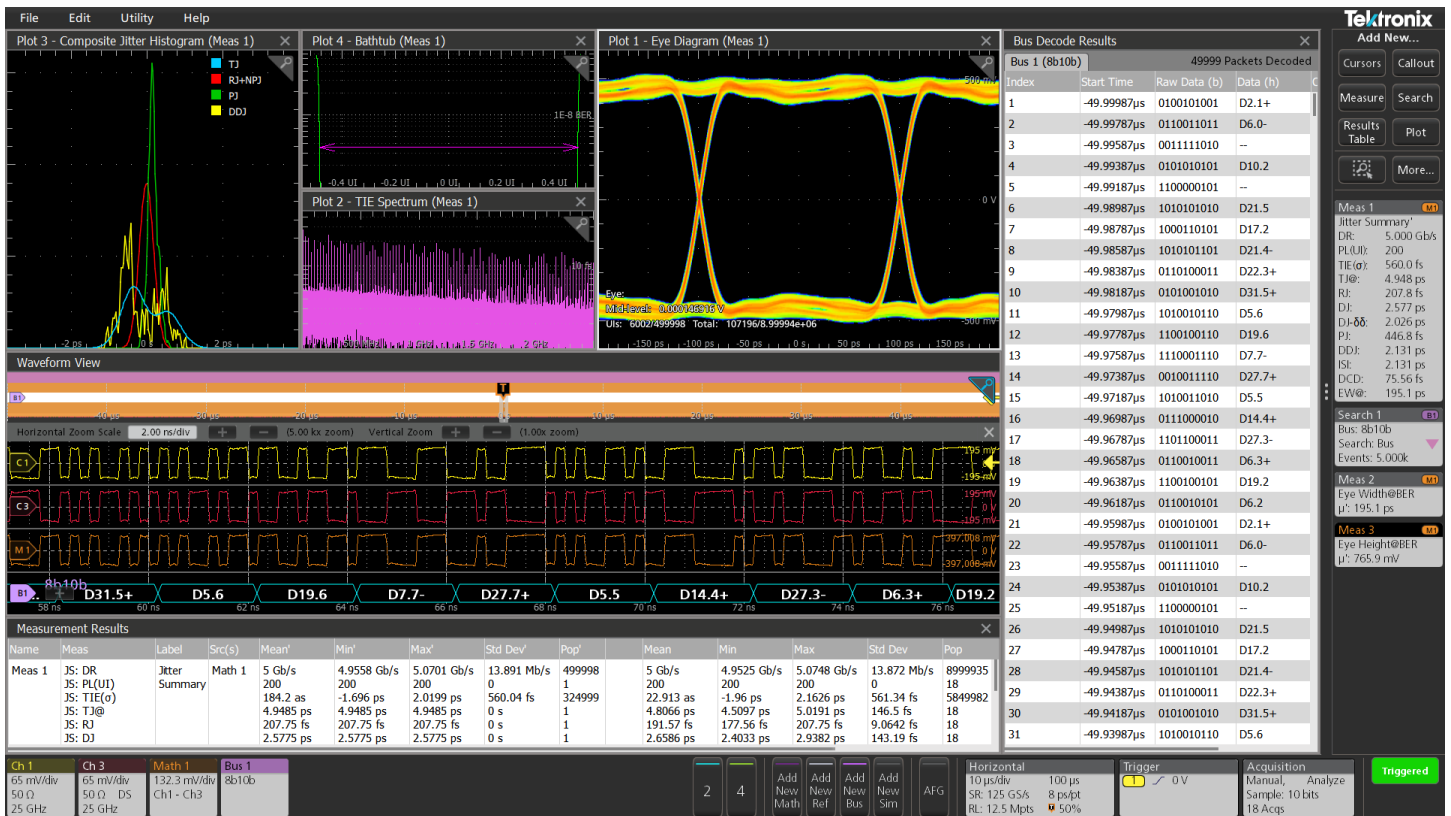

**View all aspects of your signal simultaneously!**

The massive 15.6 inch display provides plenty of viewing area not only for signals, but also for plots, measurement results tables, bus decode tables and more. By bringing every perspective together in one place, it simplifies analysis, speeds up debug, and gives engineers a clearer picture of overall system behavior.

**Exceptionally easy-to-use user interface lets you focus on the task at hand**

**The Settings Bar - key parameters and waveform management**

Waveform and scope operating parameters are displayed in a series of “badges” in the Settings Bar that runs along the bottom of the display. The Settings Bar provides Immediate access for the most common waveform management tasks. With a single tap, you can:

- Turn on channels
- Add math waveforms
- Add reference waveforms
- Add bus waveforms
- Enable the optional integrated Arbitrary Function generator (AFG)

**The Results Bar - analysis and measurements**

The Results Bar on the right side of the display includes immediate, one-tap access to the most common analytical tools such as cursors, measurements, searches, measurement and bus decode results tables, plots, and callouts.

Measurement and search results badges are displayed in the Results Bar without sacrificing any waveform viewing area. For additional waveform viewing area, the Results Bar can be dismissed and brought back at any time.

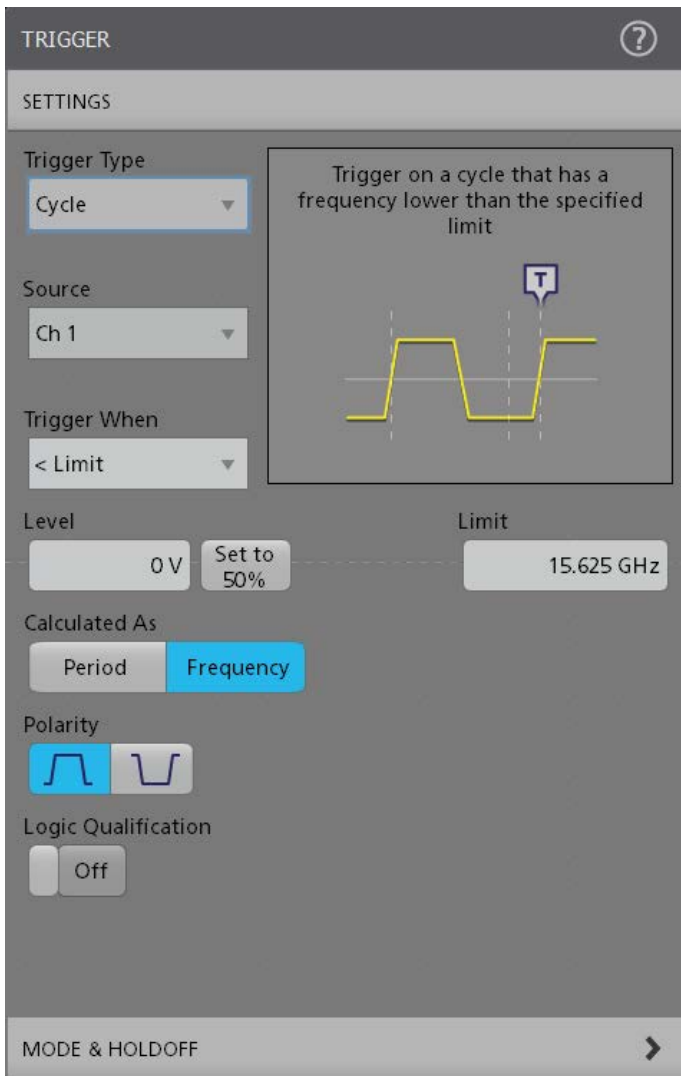

**Configuration menus are accessed by simply double-tapping on the item of interest on the display. In this case, the Trigger badge was double-tapped to open the Trigger configuration menu.**

### Touch interaction finally done right

Oscilloscopes have included touch screens for years, but the touch interface has been an afterthought. The 7 Series DPO 15.6" display includes a capacitive touchscreen and provides the industry's first oscilloscope user interface truly designed for touch.

The touch interactions that you use with phones and tablets, and expect in a touch enabled device, are supported.

- Drag waveforms left/right or up/down to adjust horizontal and vertical position or to pan a zoomed view
- Pinch and expand to change scale or zoom in/out in either horizontal or vertical directions
- Flick items off the edge of the screen to delete them
- Swipe in from the right to reveal the Results Bar or down from the top to access the menus in the upper left corner of the display

Smooth, responsive front panel controls allow you to make adjustments with familiar knobs and buttons, and you can add a mouse or keyboard as a third interaction method.



**Interact with the capacitive touch display in the same way you do on your phones and tablets.**

### Attention to detail in the front-panel controls

Traditionally, the front face of a scope has been roughly 50% display and 50% controls. The 7 Series DPO display fills about 85% of the face of the instrument. To achieve this, it has a streamlined front panel that retains critical controls for simple intuitive operation, but with a reduced number of menu buttons for functions directly accessed via objects on the display.

Color-coded LED light rings indicate trigger source and vertical scale/ position knob assignments. Large, dedicated Run/ Stop and Single Sequence buttons are placed prominently in the upper right, and other functions like Force Trigger, Trigger Slope, Trigger Mode, Default Setup, Auto-set and Quick-save functions are all available using dedicated front panel buttons.

With increasing acquisition durations, the 7 Series DPO helps with navigating through your deep record to quickly move to areas of interest. You can simply zoom in on the waveform with the integrated Wave Inspector controls, then either use the spring-loaded panning control of Wave Inspector or grab the zoom window and move it forward or backward in the record quickly and easily.



***Efficient and intuitive front panel (DPO714AX shown) provides critical controls while still leaving room for the massive 15.6" high definition display.***

### Windows or not - you choose

The 7 Series DPO offers you the choice of whether to include a Microsoft Windows™ operating system.

The 7 Series DPO comes with a standard removable SSD that contains a closed embedded operating system (Linux) that will boot as a dedicated scope with no ability to run or install other programs. An optional SSD with Windows 10 operating system is

available that will boot to an open Windows 10 configuration, so you can minimize the oscilloscope application and access a Windows desktop where you can install and run additional applications on the oscilloscope or you can connect additional monitors and extend your desktop. Simply swap the drives as needed on the rear of the instrument.

Whether you run Windows or not, the oscilloscope operates in exactly the same way with the same look and feel and UI interaction.

### Comprehensive analysis for fast insight

#### Basic waveform analysis

Verifying that your prototype's performance matches simulations and meets the project's design goals requires careful analysis, ranging from simple checks of rise times and pulse widths to sophisticated power loss analysis, characterization of system clocks, and investigation of noise sources.

The 7 Series DPO offers a comprehensive set of standard analysis tools including:

- Waveform- and screen-based cursors
- 36 automated measurements. Measurement results include all instances in the record, the ability to navigate from one occurrence to the next, and immediate viewing of the minimum or maximum result found in the record
- Basic waveform math
- Basic FFT analysis
- Advanced waveform math including arbitrary equation editing with filters and variables

Standard amplitude and time measurements annotate the waveform display with visual bars and markers to indicate relative information. Measurement results tables provide comprehensive statistical views of measurement results with statistics across both the current acquisition and all acquisitions.



**Using measurements to characterize burst width and Frequency.**

**Callouts**

1. **Note:** Write and position a text box on the screen.
2. **Arrow:** Write and position a text box, then add an arrow to a specific location on the screen.
3. **Rectangle:** Write text and outline a specific region on the screen indicated by a resizable box.
4. **Bookmark:** Create a dynamic readout at a specific time relevant to a trigger point. This readout includes text, magnitude of the signal, signal units, as well as a line and target indicating the bookmark reference point.

Documenting test results and methods is critical when sharing data across a team, recreating a measurement at a later date, or delivering a customer report. With a few taps on the screen, you can create as many custom callouts as needed; enabling you to document the specific details of your test results. With each callout, you can customize the text, location, color, font size, and font.

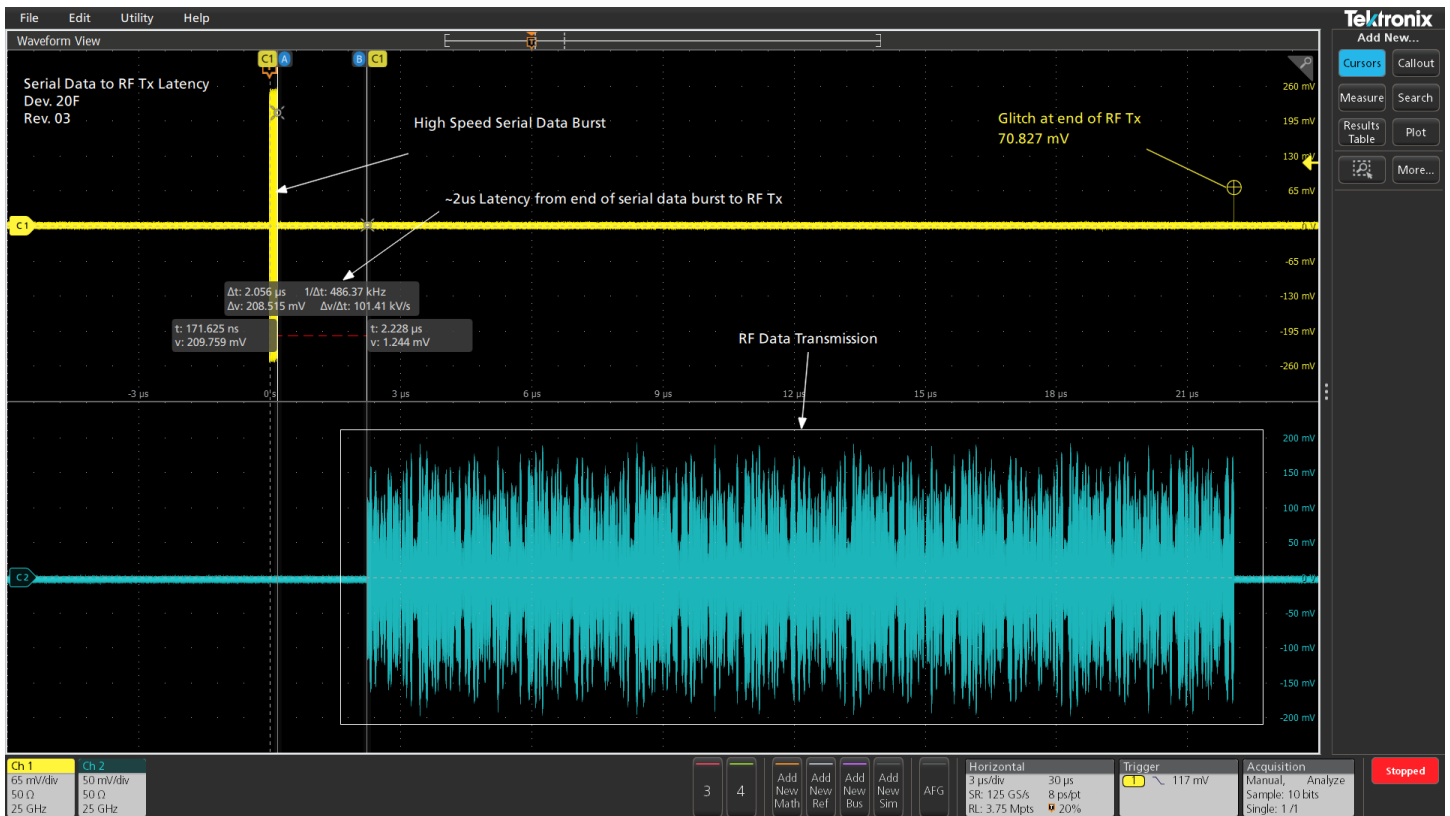

**Easy to use callouts (Note, Arrow, Rectangle, Bookmark) that are detailing the specifics of this test setup and corresponding results.**

### Navigation and search

Finding your event of interest in a long waveform record can be time consuming without the right search tools. With today's record lengths of many millions of data points, locating your event can mean scrolling through literally thousands of screens of signal activity.

The 7 Series DPO offers the industry's most comprehensive search and waveform navigation with its innovative Wave Inspector® controls. These controls speed panning and zooming through your record. With a unique force-feedback system, you can move from one end of your record to the other in just seconds. Or, use intuitive drag and pinch/ expand gestures on the display itself to investigate areas of interest in a long record.

The Search feature allows you to automatically search through your long acquisition looking for user-defined events. All occurrences of the event are highlighted with search marks and are easily navigated to, using the Previous (←) and Next (→) buttons found on the front panel or on the Search badge on the display. Search types include edge, pulse width, timeout, runt, window, logic, setup and hold, rise/fall time and parallel/serial bus packet content. You can define as many unique searches as you like.

You can also quickly jump to the minimum and maximum value of search results by using the Min and Max buttons on the Search badge.

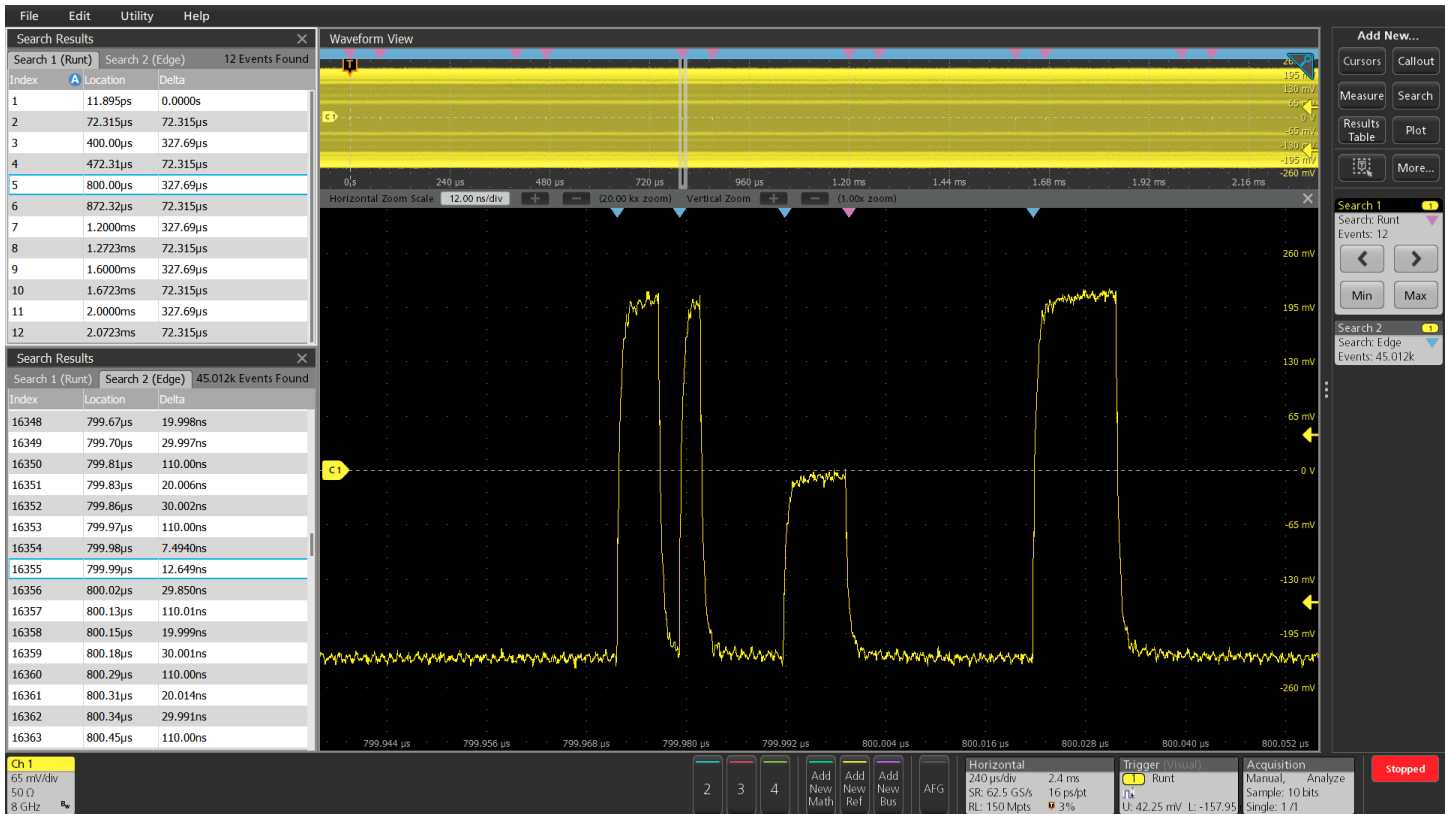

**Earlier, Pinpoint Digital Triggering revealed the presence of a runt pulse in a digital data stream prompting further investigation.**

### Mask and limit testing(optional)

Whether you are focused on signal integrity or setting up pass/ fail conditions for production, mask testing is an efficient tool to characterize the behavior of certain signals in a system. Quickly create custom masks by drawing mask segments on the screen. Tailor a test to your specific requirements and set actions to take when a mask hit is registered, or when a complete test passes or fails.

Limit testing is an insightful way to monitor the long-term behavior of signals, helping you characterize a new design or confirm hardware performance during production line testing. Limit tests compare your live signal to an ideal, or golden version of the same signal with user-defined vertical and horizontal tolerances.

You can easily tailor a mask or limit test to your specific requirements by:

- Defining test duration in number of waveforms
- Setting a violation threshold that must be met before considering a test a failure
- Counting violations/failures and reporting statistical information
- Setting actions upon violations, test failure, and test complete

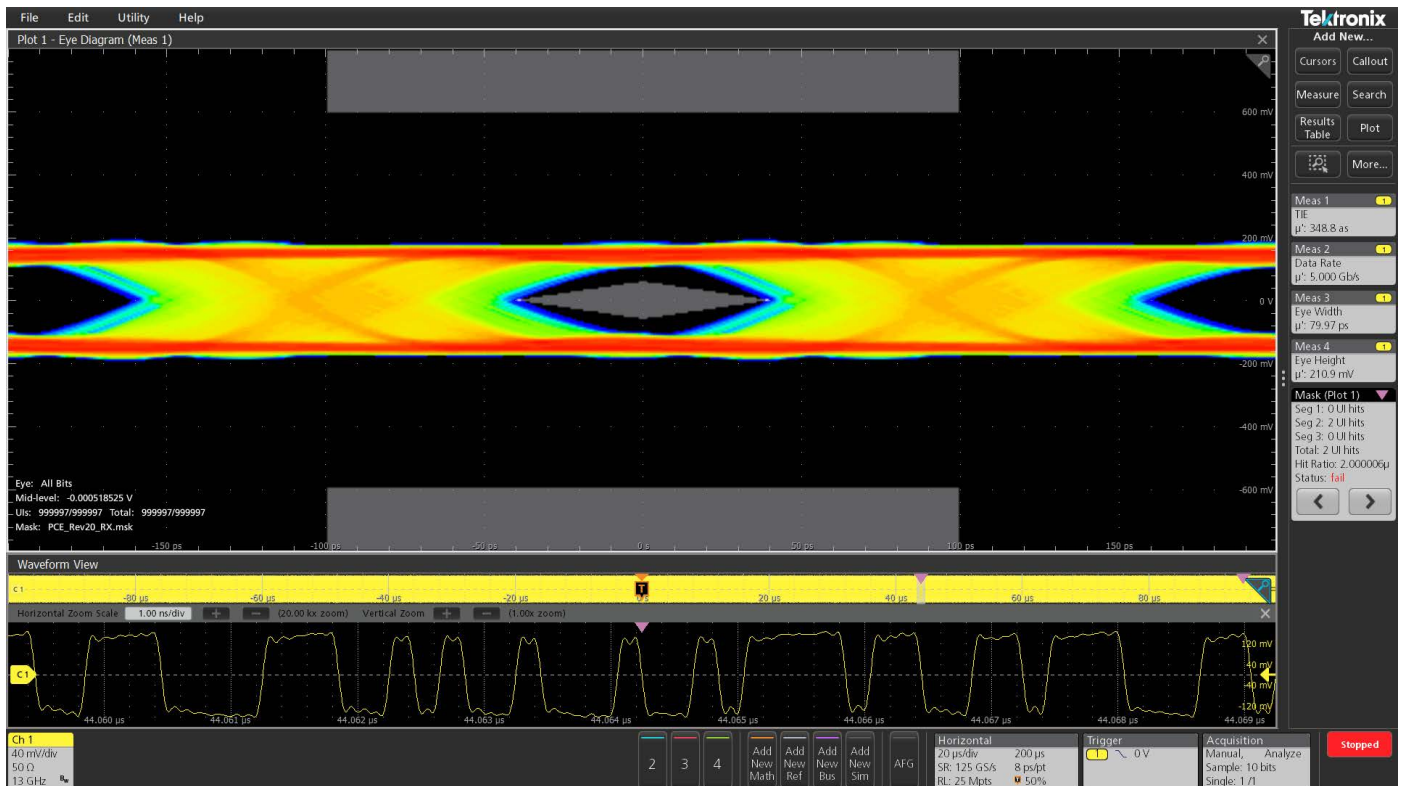

**Custom, multiple segment mask capturing the presence of a signal glitch and runt pulse in a waveform.**

### User-defined filtering (optional)

In the broad sense, any system that processes a signal can be thought of as a filter. For example, an oscilloscope channel operates as a low pass filter where its 3 dB down point is referred to as its bandwidth. Given a waveform of any shape, a filter can be designed that can transform it into a defined shape within the context of some basic rules, assumptions, and limitations.

Digital filters have some significant advantages over analog filters. For example, the tolerance values of analog filter circuit components are high enough that high order filters are difficult or even impossible to implement. High order filters are easily implemented as digital filters. Digital filters can be implemented as Infinite Impulse Response (IIR) or Finite Impulse Response (FIR). The choice of IIR or FIR filters are based upon design requirements and application.

The 7 Series DPO has the ability to apply designated filters to math waveforms through a MATH arbitrary function. Option 7-UDFLT takes this functionality a level deeper, providing more than MATH arbitrary basic functions and adds flexibility to support standard filters and can be used for application centric filter designs.



**Filters can be created through the Math dialog. Once a filter is edited, it can be easily applied, saved, and recalled for use or modification later.**

Filter types supported on the 7 Series DPO include:

- Low pass
- High pass
- Band pass
- Band stop
- All pass
- Hilbert
- Differentiator



**Filter creation dialog showing selection for Filter Type, Filter Response, Cutoff Frequency, Filter Order, and a graphical representation of Magnitude/Phase, Impulse Response, and Step Response.**

Filter response types supported on the 7 Series DPO include:

- Butterworth
- Chebyshev I
- Chebyshev II
- Elliptical
- Gaussian
- Bessel-Thomson
- Custom

The Filter Response control is available for all Filter Types except All-pass, Hilbert, or Differentiator.

Filter designs can be saved, recalled, and applied once any editing has been completed.

### Protocol decode and analysis (optional)

During debugging, it can be invaluable to trace the flow of activity through a system by observing the traffic on one or more serial buses. It could take many minutes to manually decode a single serial packet, much less the thousands of packets that may be present in a long acquisition.

And if you know the event of interest that you are attempting to capture occurs when a particular command is sent across a serial bus, wouldn't it be nice if you could trigger on that event? Unfortunately, it's not as easy as simply specifying an edge or a pulse width trigger.

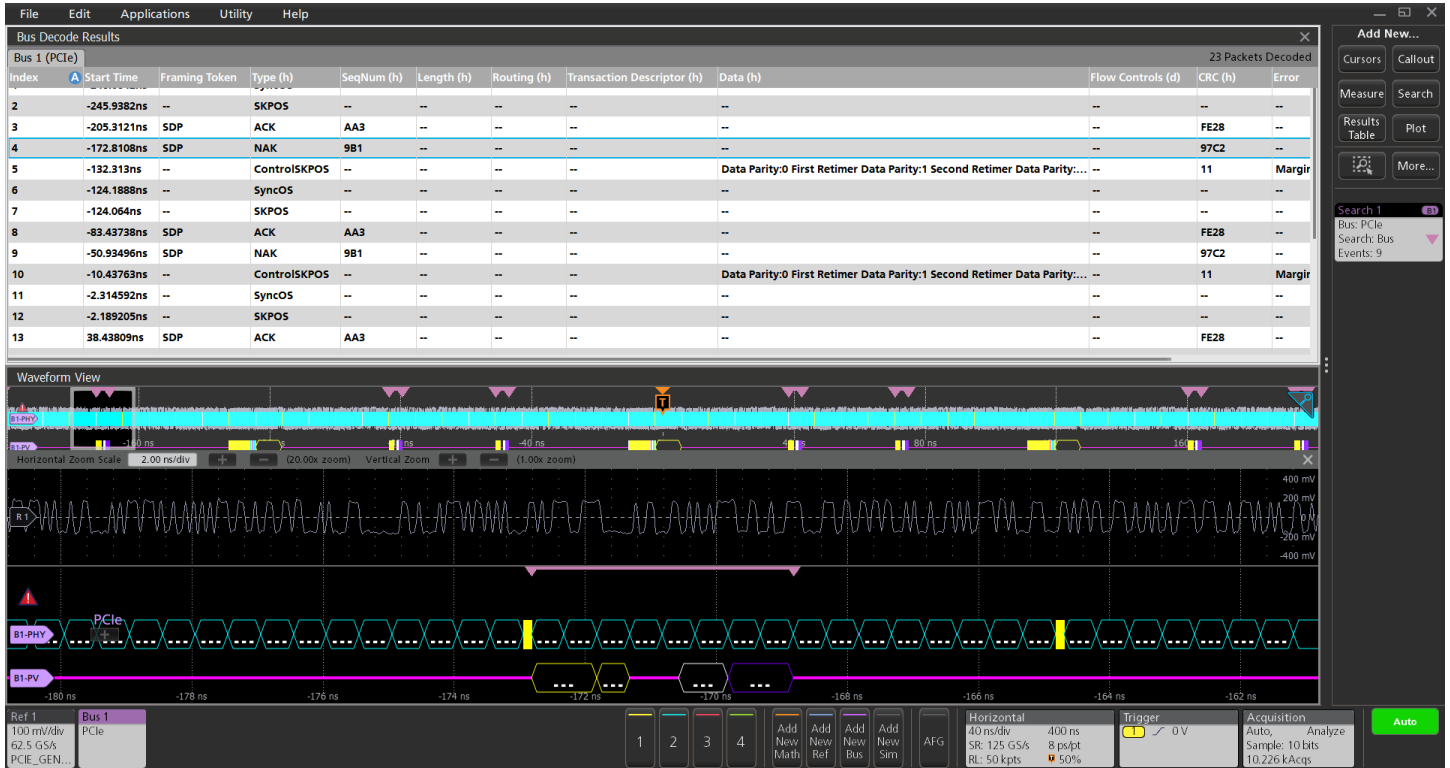

### Triggering on a PCIe Gen4 high-speed serial bus with decoded packet display.

The 7 Series DPO offers a robust set of tools for working with the most common buses such as PCIe, USB, DisplayPort, DDR and dozens of others supports – refer to Ordering Information for complete list of supports.

Protocol search enables you to search through a long acquisition of serial packets and find the ones that contain the specific packet content you specify. Each occurrence is highlighted by a search mark. Rapid navigation between marks is as simple as pressing the Previous (←) and Next (→) buttons on the front panel or in the Search badge that appears in the Results Bar.

The tools described for serial buses also work on parallel buses. Support for parallel buses is standard in the instrument. Parallel buses can be up to 64 bits wide and can include a combination of analog and digital channels.

- Serial protocol triggering lets you trigger on specific packet content including start of packet, specific addresses, specific data content, unique identifiers, and errors.
- Bus waveforms provide a higher-level, combined view of the individual signals (clock, data, chip enable, and so on) that make up your bus, making it easy to identify where packets begin and end, and identifying sub-packet components such as address, data, identifier, CRC, and so on.
- The bus waveform is time aligned with all other displayed signals, making it easy to measure timing relationships across various parts of the system under test.
- Bus decode tables provide a tabular view of all decoded packets in an acquisition much like you would see in a software listing. Packets are time stamped and listed consecutively with columns for each component (Address, Data, and so on).

### Jitter and Eye Diagram Analysis (standard)

The 7 Series DPO comes with integrated jitter and eye diagram analysis, leveraging Tektronix' proven DPOJET engine. With just a few clicks, engineers can measure and view key parameters such as Time Interval Error and Phase Noise. Analysis tools including histograms, time-trend plots, and spectrum views provide quick visibility into how timing varies over time and where jitter or modulation sources originate.

Real-time eye diagram rendering, combined with advanced visualization tools such as composite jitter histograms, bathtub curves, SSC profiles, and spectrum plots, provides immediate feedback and deeper insight into signal behavior. Automated eye diagram mask testing with margin analysis not only delivers clear pass/fail results but also quantifies design robustness.

These capabilities make DJA an essential tool for uncovering hidden jitter sources, accelerating debug, and ensuring confidence in today's high-speed serial, digital, and communication designs.

### Advanced Jitter and Eye Diagram Analysis (optional)

Option 7-DJA adds more than 30 additional measurements and advanced decomposition algorithms. It separates random, deterministic, periodic, and data-dependent jitter components with precision, giving engineers clear visibility into root causes.

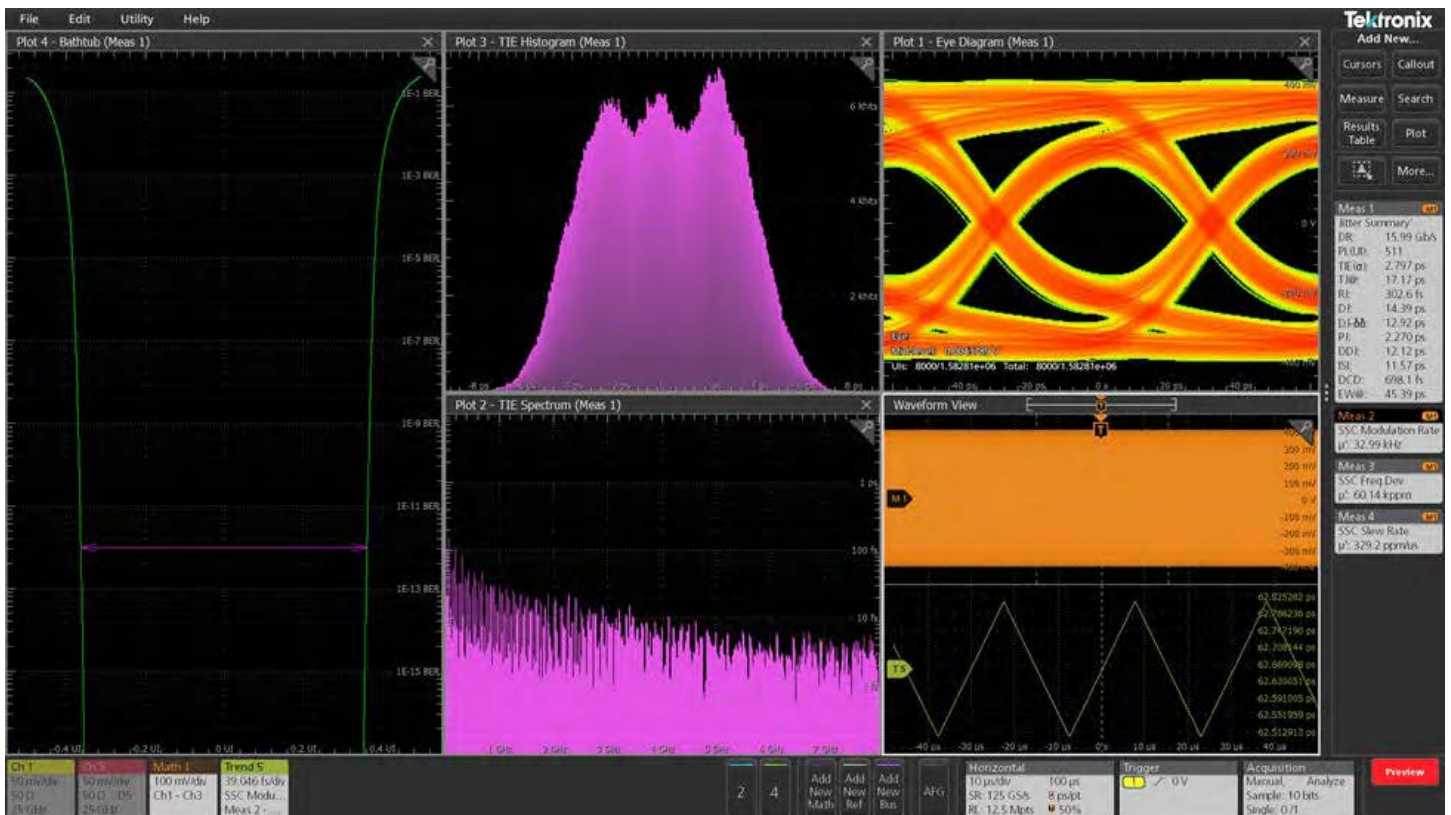

The Jitter Summary along with a spread spectrum clock (SSC) measurement provides a comprehensive view of your device's performance in a matter of seconds.

## 7 Series DPO Digital Phosphor Oscilloscope Datasheet

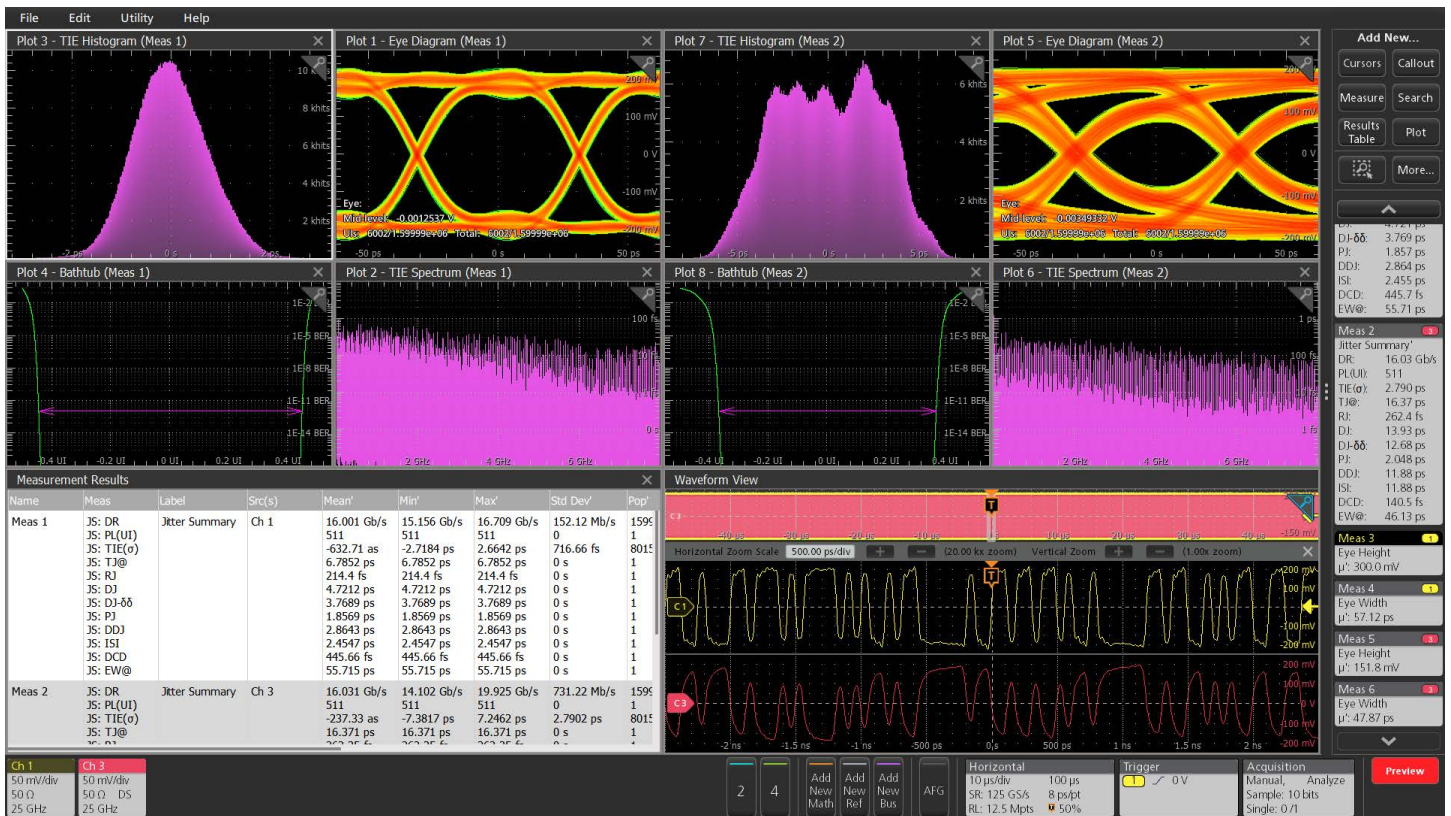

**View multiple jitter measurement summaries on the large 15.6-inch 1080p display.**

Tektronix uniquely supports virtually unlimited parallel measurements and plots—each with independent clock recovery settings—for rapid side-by-side comparisons of equalization strategies, margin sensitivity, or configuration changes. With DJA, engineers can extend this capability to jitter summaries and eye diagrams across two or more signals from a system. Full jitter measurements, plots, and eye diagrams can be displayed simultaneously for direct comparison, and windows can be easily rearranged to customize the workflow.

## Signal Integrity Modeling (Base) (optional)

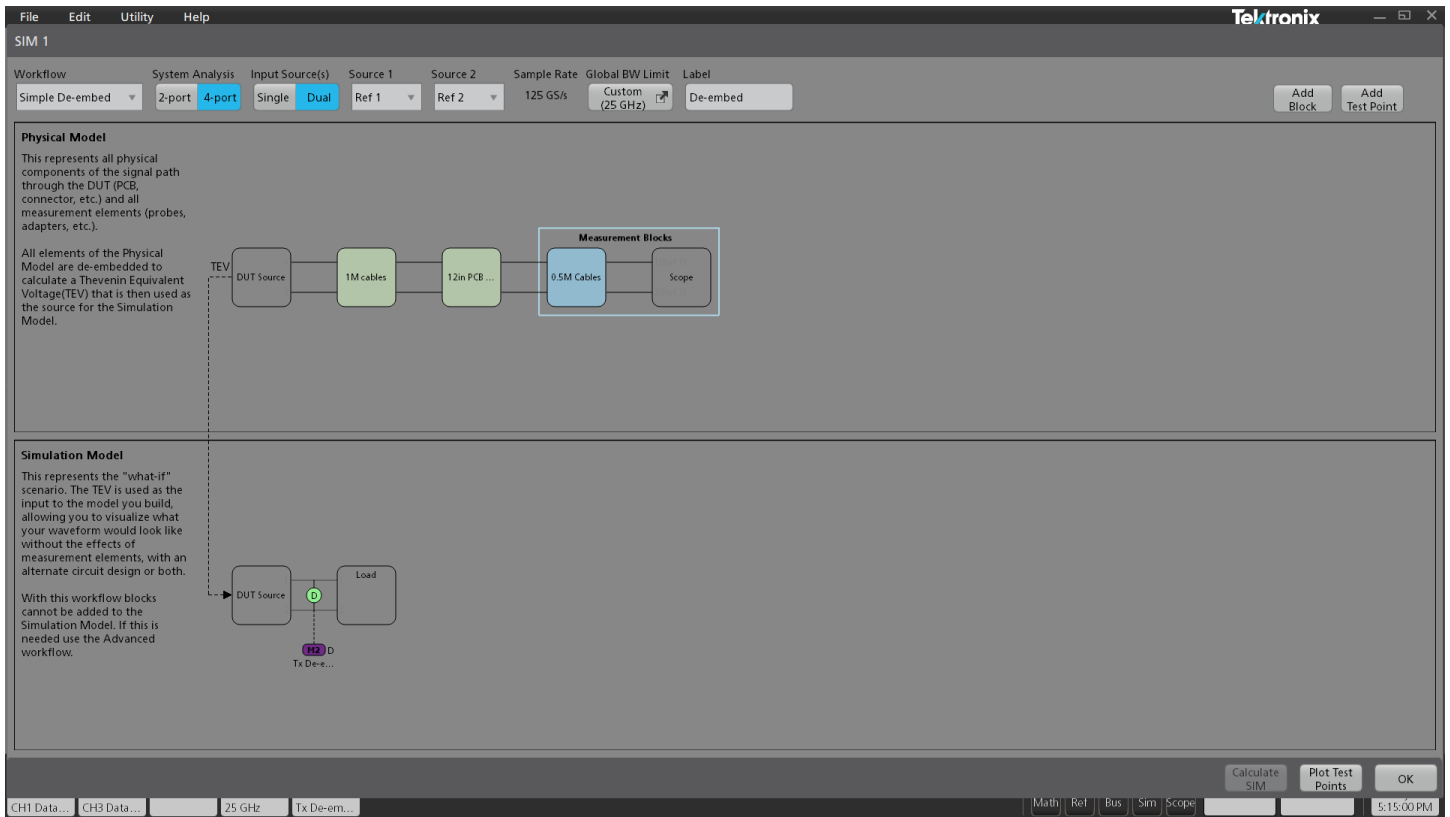

**The new SIM tool provides an intuitive, interactive modeling environment for on-scope de-embedding and embedding of signals.**

Modern high-speed designs all face the same challenge: measurement and interconnect impairments that obscure the true performance of the device. Cables, probes, fixtures, and channel elements introduce reflections, loss, and delay that can dominate over the DUT's actual behavior. This creates two traps in validation: false failures, where the device appears broken but the issue is the measurement path, and false confidence, where the device looks fine in the lab but collapses in the real system. Addressing these impairments is essential for accurate measurement, meaningful simulation, and reliable system validation.

SIM addresses these challenges by enabling precise de-embedding of the measurement circuit—including probes, fixtures, and cables—while accurately accounting for source and load impedances at the transmitter and receiver. SIM allows users to define a variety of models, such as S-parameter, transmission line, and RLC models, to remove loss and delay from the setup. This level of correction improves measurement fidelity and can be the difference between passing and failing compliance tests.

Once the measurement circuit is de-embedded, engineers can explore “what-if” scenarios by embedding a simulation circuit. This may range from a simple 50 Ω termination for transmitter characterization, to a worst-case cable added at the end of a signal path, to a complete backplane or interconnect modeled

using S-parameters. These simulations provide valuable insight into system behavior under real-world conditions – helping teams validate design robustness and avoid costly hardware iterations.

## Signal Integrity Modeling (Advanced) (optional)

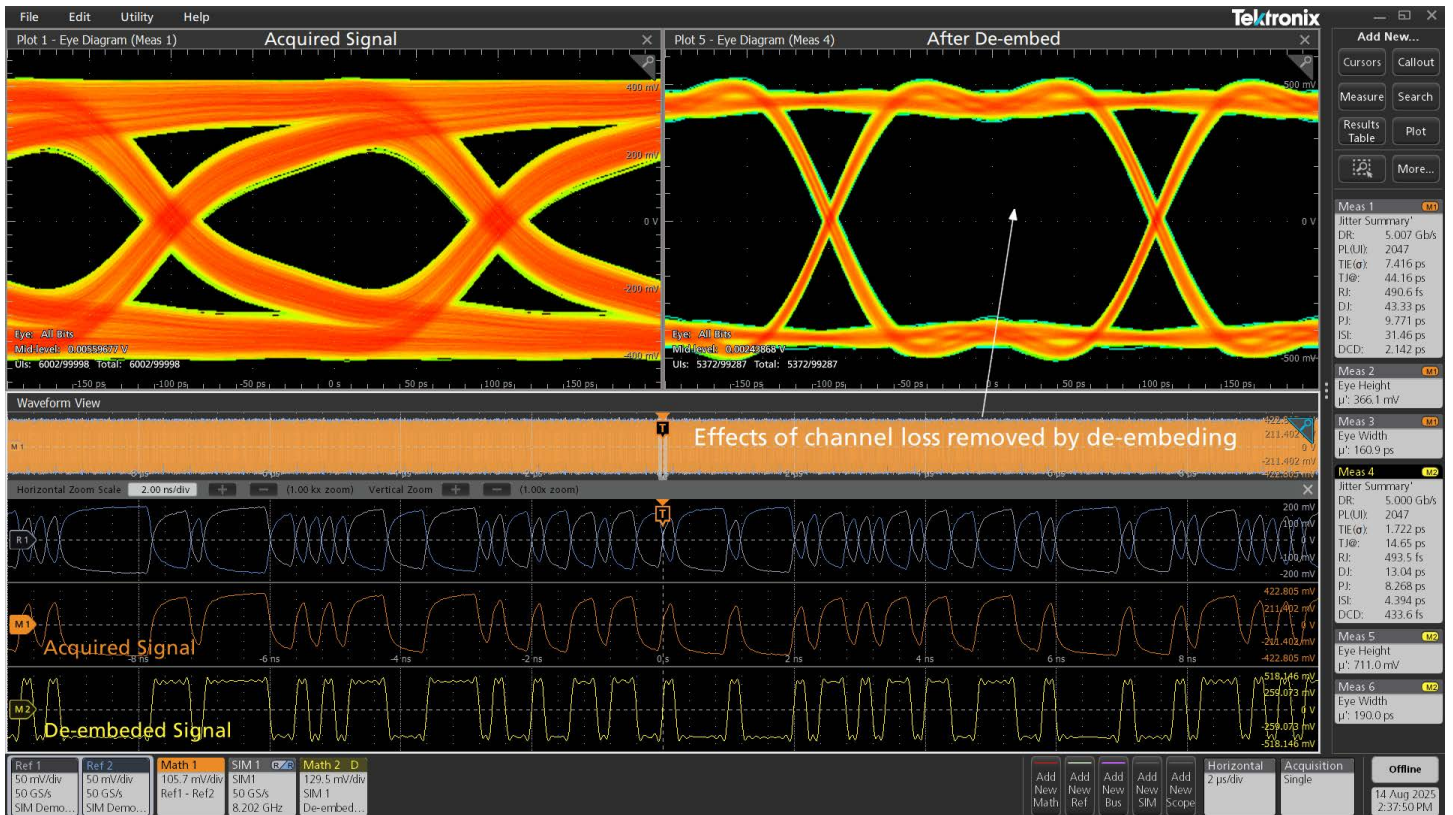

**Compare signals before and after de-embedding, or across multiple modeling scenarios, in a single view. Example shown using a 7 Series DPO; UI and workflows are representative.**

Designers increasingly rely on advanced equalization techniques at the receiver to compensate for loss and distortion in high-speed channels. In many cases, channel loss can cause eye diagrams to close, masking the true performance of the system.

SIM Advanced (SIMA) helps overcome this by providing receiver equalization tools including CTLE, FFE, and DFE that reduce inter-symbol interference (ISI), open closed eyes, and deliver a more accurate view of receiver performance under realistic operating conditions.

Finally, as transmitter waveforms evolve beyond simple NRZ signaling—toward higher-order schemes and tighter margins—evaluating the impact of transmitter equalization becomes critical. SIMA enables users to apply pre-emphasis or de-emphasis to simulate real-world behavior and optimize system performance across challenging channels.

SIMA builds on SIM capabilities, providing a complete signal integrity modeling environment that supports de-embedding, embedding, and advanced equalization for high-speed serial links. Whether validating digital interfaces like DDR, PCIe, or Ethernet, or modeling RF, analog, or fast-switching power systems, SIM and SIMA help ensure robust performance and reduces costly hardware iterations.

## TekExpress® Compliance test (optional)

A key focus area for embedded designers is testing various embedded and interface technologies for compliance. This ensures the device passes the logo certification at plugfests and achieves successful interoperability when working with other compliant devices.

The compliance test specifications for high speed serial standards like USB, Ethernet, Memory, Display and MIPI are developed by the respective consortiums, or governing bodies. Working closely with these consortiums, Tektronix has developed oscilloscope-based compliance applications that not only focus on providing pass/fail results but also provide deeper insight into any failures by providing relevant measurement tools such as jitter and timing analysis to debug failing designs.

These automated compliance applications are built on a framework that provides:

- Complete test coverage per the specification.
- Fast test times with optimized acquisitions and test sequencing based on customized settings.
- Analysis based on previously-acquired signals, allowing the device under test (DUT) to be disconnected from the setup once all acquisitions are completed. This also allows analysis of waveforms acquired on a different oscilloscope or captured at a remote lab, facilitating a very collaborative test environment.
- Signal validation during acquisition to ensure the right signals are being captured.
- Additional parametric measurements for design debug.
- Custom eye diagram mask testing for insight into design margin.
- Detailed reports in multiple formats with setup information, results, margins, waveform screenshots and plot images.

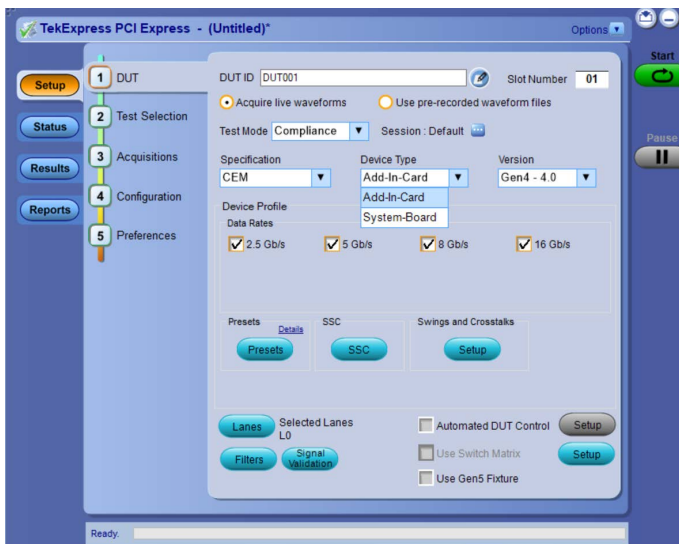

**TekExpress® PCI Express Gen 1/2/3/4 Automated Test Software (Option 7CMPCIE1234)** - Provides the most comprehensive solution for PCI Express transmitter compliance testing from Gen1 to Gen4. Covering troubleshooting and validation of PCI Express devices corresponding to the PCI-SIG specifications. The application automates selection of appropriate fixture de-embed, reference channel emulation filters, and measurement selections based on test type, device data rate, transmitter equalization, link width, and selected probes. TekExpress includes compliance automation solution that integrates the PCI-SIG's SigTest test software with Tektronix DPOJET-based PCI Express Jitter and Eye Diagram, SIM/SIMA Signal Integrity Modeling analysis tools. Results are presented in a comprehensive HTML format for engineering test documentation.

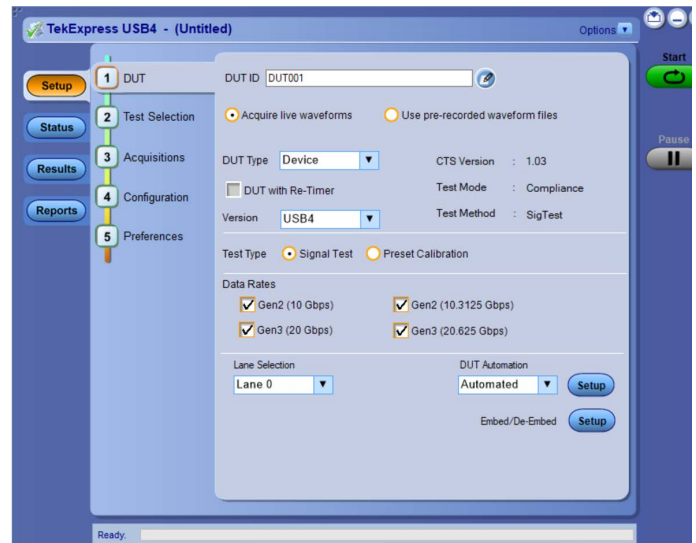

**TekExpress USB4v1 Automated Test Software (Option 7-CMUSB4V1)** - The TekExpress® USB4 Compliance and Debug solutions provide an easy way to validate and characterize the emerging USB4 Router-Host, USB4 Router-Device, and USB4 Hubs as per the USB4 Electrical Compliance Test Specification (CTS).

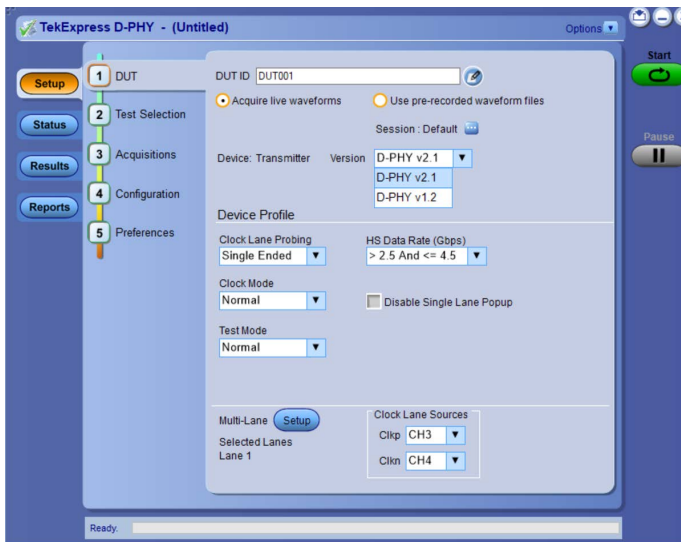

**TekExpress D-PHY (Option 7-CMDPHY21) -TekExpress® D-PHY application offers a complete physical layer test solution for transmitter conformance and characterization as defined in the MIPI D-PHY version 1.2 and version 2.1 specifications. The automated test solution provides an easy way to test, debug and characterize the electrical and timing measurements of D-PHY data links.**

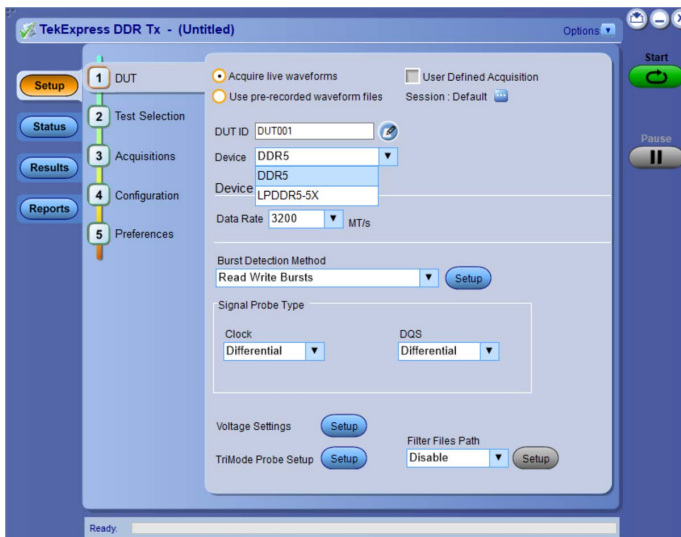

**TekExpress (Options 7-CMDDR5SYS, 7-CMLPDDR5SYS) – The DDR (Dual DataRate) is a dominant and fast-growing memory technology. It offers high data transfer rates required for virtually computing applications, from consumer products to the most powerful servers. The high speed of these signals requires high-performance measurement tools. The Tektronix TekExpress DDR Tx is an automated test**

application used to validate and debug the DDR5 designs of the DUT as per the JEDEC specifications. The solution enables you to achieve new levels of productivity, efficiency, and measurement reliability.

### SignalVu-PC® vector signal analysis (optional)

The 7 Series DPO offers a high-performance hardware platform designed for demanding RF signal analysis. With a low noise floor, high SFDR, and wide bandwidth supporting multi-channel phase synchronous acquisition, the 7 Series DPO is ideal for capturing and analyzing complex RF environments across broad frequency ranges.

Integrated with the SignalVu-PC vector signal analysis software, the 7 Series DPO becomes a complete solution for advanced RF diagnostics. SignalVu-PC enables rich, synchronized insights across time, frequency, and modulation domains. All measurements in SignalVu-PC are fully time-correlated, allowing users to view how modulation events align with frequency content and time-domain changes. Linked markers across domains provide interactive, synchronized navigation—ideal for analyzing frequency hopping, modulation switching, bandwidth shifts, and transient anomalies.

A key advantage of this solution is the tight integration between software and hardware. SignalVu-PC can directly control scope parameters such as vertical, horizontal scale and triggering. This seamless interaction simplifies setup and ensures consistent signal acquisition and analysis.

The 7 Series DPO supports acquisition of RF, IQ, and differential IQ signals. This allows engineers to examine baseband, IF, and RF signals at various stages of the signal chain.

Data transfer between the 7 Series DPO and SignalVu-PC uses a high-speed serial interface, significantly faster than traditional VISA communication. This results in faster throughput, lower latency, and a more responsive analysis experience, especially when handling large datasets.

### Multi-Channel RF Analysis

The 7 Series DPO with SignalVu-PC supports multi-channel acquisition and analysis, enabling simultaneous, phase-synchronous signal analysis across all available channels. Each channel can capture and process wide-bandwidth signals in real time, making the solution ideal for advanced applications such as multi-emitter radar testing, phased-array systems, and electronic warfare analysis.

SignalVu-PC's general purpose analysis functions—such as spectrum, spectrogram, phase versus time, and amplitude versus time, Pulse radar analysis and General-purpose modulation analysis—are fully available on all channels. This allows not only parallel measurement across multiple channels, but also precise

## 7 Series DPO Digital Phosphor Oscilloscope Datasheet

correlation between them. Engineers can analyze amplitude and phase differences between channels to characterize beamforming behavior, signal alignment, or channel-specific anomalies.

For example, SignalVu-PC's spectrograms, spectra and amplitude quickly provide other views of critical experiment data for specific applications such as Photon Doppler Velocimetry (PDV).

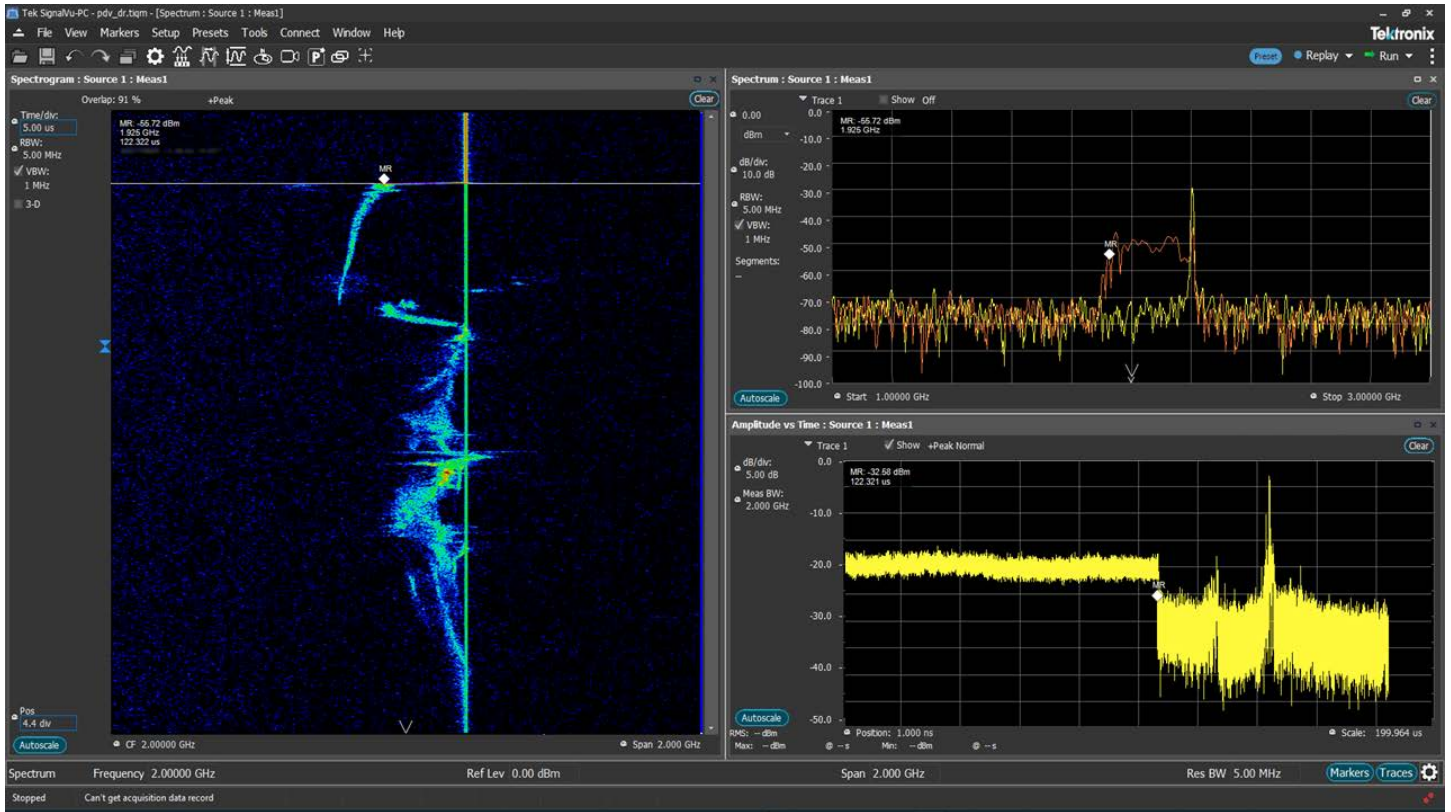

**Quickly display fast events using SignalVu-PC's spectrogram display, now available with Dark Mode.**

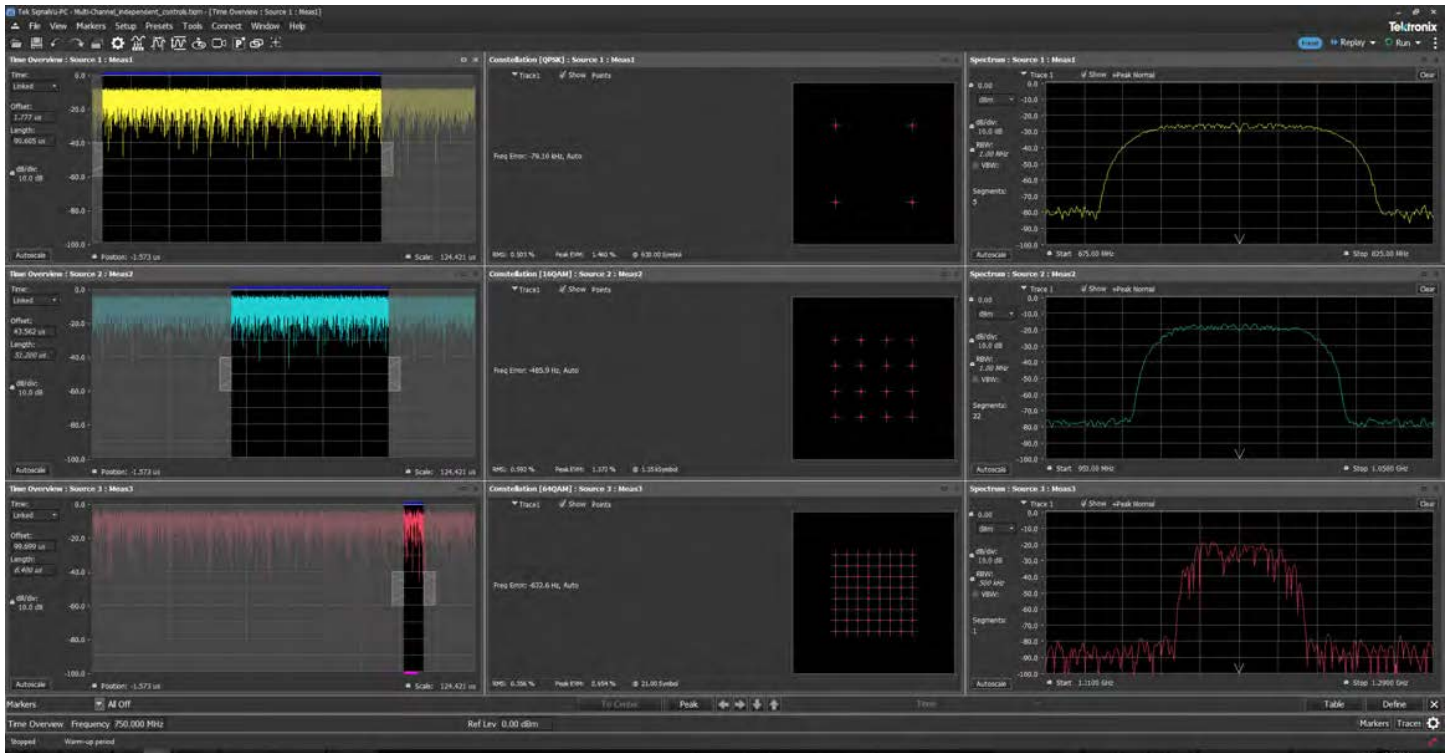

**Simultaneously view multiple RF channels with SignalVu-PC.**

Each channel can be configured independently with its own center frequency, span, resolution bandwidth (RBW), reference level, and time gating. At the same time, global settings allow users to quickly apply the same configuration across all channels when uniformity is required. This flexible setup ensures the system can adapt to both synchronized and independent channel analysis scenarios.

For example as shown above, engineers can simultaneously analyze three different signals—each at a distinct frequency, span, and RBW with different modulation schemes. Each signal can be demodulated at different points in the analysis time, demonstrating the full control and independence available per channel. This capability makes the system an ideal tool for evaluating signal environments with varying modulation formats and time-domain behaviors.

**Shared acquisition multi-signal support**

The 7 Series DPO with SignalVu-PC enables advanced analysis of multiple signals captured on a same input channel, an essential capability for environments such as wireless coexistence testing, satcom monitoring and electronic warfare, where emitters of varying types and behaviors may overlap in time or frequency. Each signal within the channel can be isolated, time-gated, and analyzed with its own unique settings—just as in a multi channel configuration.

In the example below, both Source 1 and Source 2 are connected to the same channel. Within Source 1, the spectrum reveals two signals: a modulated communication signal centered at 2.4000 GHz, and a radar pulse centered at 3.5000 GHz. Despite sharing the same acquisition channel, these signals are independently channelized and analyzed. This enables investigation of the phase relationships, timing offsets, or interaction patterns between signals in the same channel—critical in applications involving multi-emitter detection, signal deconvolution.

### Shared acquisition multi-signal support

The 7 Series DPO with SignalVu-PC enables advanced analysis of multiple signals captured on a same input channel, an essential capability for environments such as wireless coexistence testing, satcom monitoring and electronic warfare, where emitters of varying types and behaviors may overlap in time or frequency. Each signal within the channel can be isolated, time-gated, and analyzed with its own unique settings—just as in a multi channel configuration.

In the example below, both Source 1 and Source 2 are connected to the same channel. Within Source 1, the spectrum reveals two signals: a modulated communication signal centered at 2.4000 GHz, and a radar pulse centered at 3.5000 GHz. Despite sharing the same acquisition channel, these signals are independently channelized and analyzed. This enables investigation of the phase relationships, timing offsets, or interaction patterns between signals in the same channel—critical in applications involving multi-emitter detection, signal deconvolution.

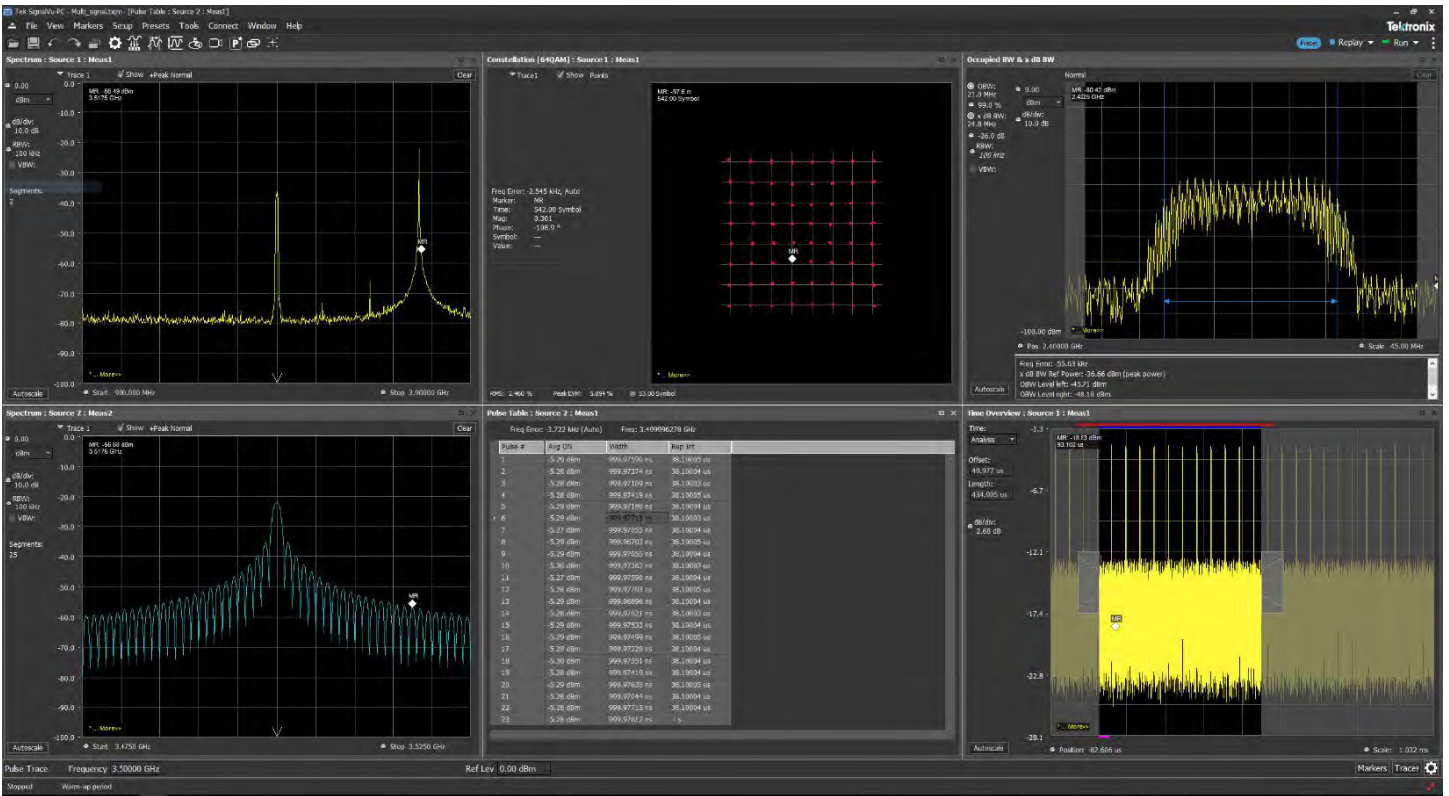

Simultaneously view multiple RF signal sources on the same channel with SignalVu-PC.

### Advanced pulse analysis (optional)

The Advanced Pulse Analysis package (Opt. SVP) provides 31 individual measurements to automatically characterize long pulse trains.

## Designed with your needs in mind

### LXI Class C Version 1.6

Using the LXI Web Interface, you can connect to the 7 Series through a standard web browser by simply entering the oscilloscope's IP address in the address bar of the browser. The web interface enables viewing of instrument status and configuration, as well as status and modification of network settings. All web interaction conforms to the LXI Class C Version 1.6 specification for Windows OS or LXI Class C Version 1.5 specification for Embedded (Linux) OS.

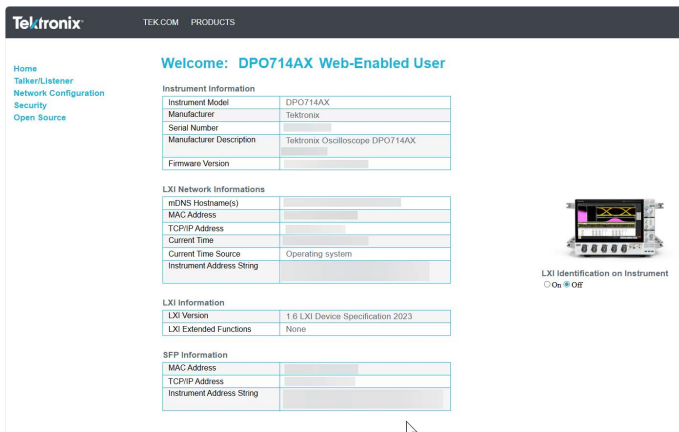

[7 Series LXI web page.](#)

## Upgrade Automated Test Equipment (ATE) systems quickly and smoothly

Anyone working closely with automated test systems knows that moving to a new model or platform can be painful. Modifying an existing codebase for a new product can be prohibitively expensive and complicated. Now there's a solution.

All 7 Series DPO's include a Programmatic Interface (PI) Translator. When enabled, the PI Translator acts as an intermediate layer between your test application and the oscilloscope. It recognizes a subset of legacy commands from the popular DPO70000C/DX/SX platforms and translates them on the fly into supported commands for the 7 Series DPO. The Translator interface is designed to be human-readable and easily extensible, which means that you can customize its behavior to minimize the amount of effort required when transitioning to your new oscilloscope.

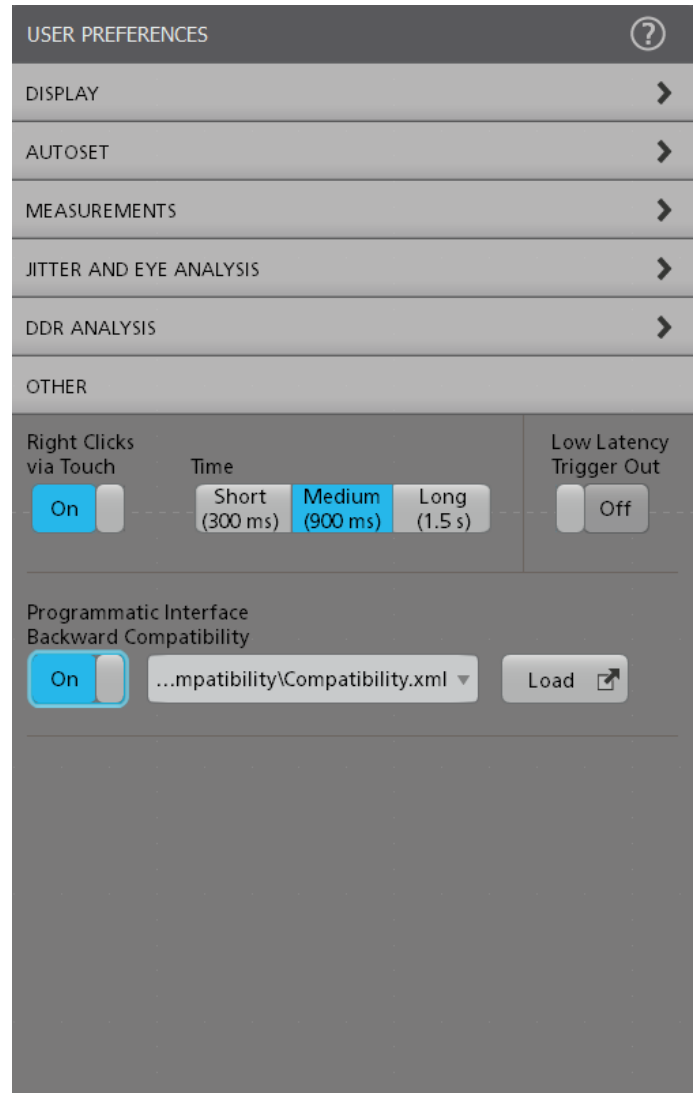

[7 Series Programmatic Interface \(PI\) Translator.](#)

## Remote operation to improve collaboration

Want to collaborate with a design team on the other side of the world?

The included e\*Scope® capability enables fast control of an oscilloscope running the Embedded Operating System over a network connection. This can be viewed from any PC or device through a standard web browser.

Simply enter the IP address or network name of the oscilloscope and a web page will be served to the browser. Control the oscilloscope remotely in the exact same way that you do in-person using the built-in touchscreen. Alternatively for oscilloscopes with the Microsoft Windows 10 Operating System, you can use Windows Remote Desktop™ to connect directly to the instrument and control it remotely.

## 7 Series DPO Digital Phosphor Oscilloscope Datasheet

The TekVISA™ I/O library is included for using and enhancing Windows applications for data analysis and documentation.IVI-COM instrument drivers are included to enable easy communication with the oscilloscope using LAN or USBTMC connections from an external PC.

Utilize TekHSI(tm) framework to dramatically speed up data transfer from the 7 Series DPO to an external PC.

With a programmer's manual and a GitHub site, you have many commands and examples to help you get started.

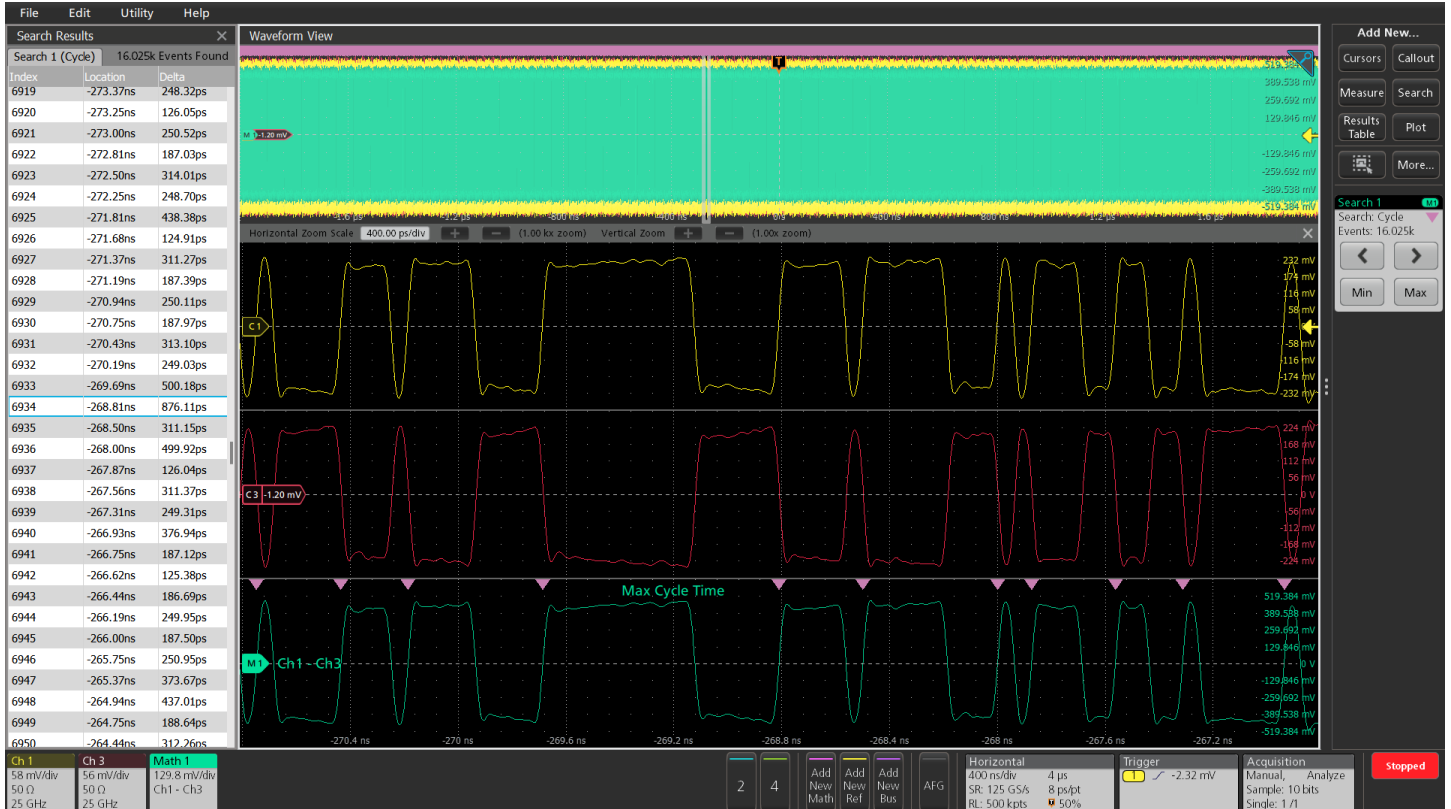

*e\*Scope provides simple remote viewing and control using common web browsers.*

### PC-based analysis and remote connection to your oscilloscope

Get the analysis capability of an award-winning oscilloscope on your PC. Analyze waveforms anywhere, anytime. The basic license lets you view and analyze waveforms, perform many types of measurements and decode the most common serial buses - all while remotely accessing your oscilloscope. Advanced license options add capabilities such as jitter analysis and more serial bus decoding options.



**TekScope PC analysis software runs on a Windows computer with the same award-winning user experience as the 4, 5, 6 and 7 Series.**

Key features of the TekScope PC analysis software for the 7 Series DPO include:

## 7 Series DPO Digital Phosphor Oscilloscope Datasheet

Key features of the TekScope PC analysis software for the 7 Series DPO include:

- Recall Tektronix oscilloscope sessions and waveform files from the equipment made by Tektronix and other vendors
- Waveform file formats supported include .wfm, .isf, .csv, .h5, .tr0, .trc, and .bin
- Remotely connect to the Tektronix 4/5/6/7 Series to acquire data in real-time
- Share data remotely with your colleagues so that they can perform analysis and make measurements as if they were sitting in front of the oscilloscope
- Synchronize waveforms from the multiple oscilloscopes in real-time
- Perform advanced analysis even if your oscilloscope isn't equipped with TekScope PC analysis software

### TekDrive collaborative test and measurement workspace

Using TekDrive, you can upload, store, organize, search, download, and share any file type from any connected device. TekDrive is natively integrated into the instrument for seamless sharing and recalling of files - no USB stick is required. Analyze and explore standard files like .wfm, .isf, .tss, and .csv, directly in a browser with smooth interactive waveform viewers. TekDrive is purpose built for integration, automation, and security.

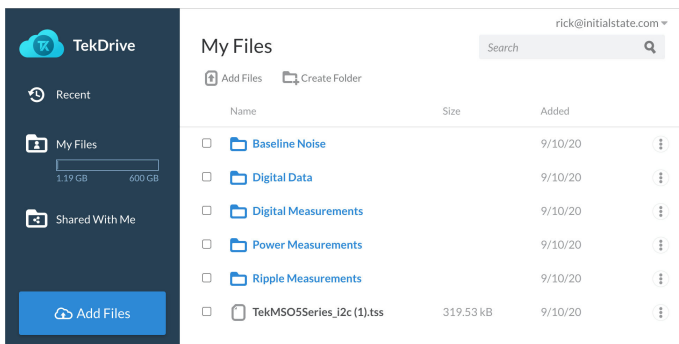

**TekDrive collaborative workspace - save files directly from your instrument and share across your team.**

### Arbitrary Function Generator (AFG)

The instrument contains an optional integrated arbitrary function generator, perfect for simulating sensor signals within a design or adding noise to signals to perform margin testing. The integrated function generator provides output of predefined waveforms for sine, square, pulse, ramp/triangle, DC, noise,  $\sin(x)/x$  (Sinc), Gaussian, Lorentz, exponential rise/decay, Haversine and cardiac. The AFG can load waveform records up to 128 k points in size from an internal file location or a USB mass storage device.

The AFG feature is compatible with Tektronix' ArbExpress PC-based waveform creation and editing software, making creation of complex waveforms fast and easy.

### Trigger Frequency Counter

The instrument contains an integrated 11-digit trigger frequency counter. The trigger frequency counter provides a very precise readout of the frequency of the trigger event on which you're triggering.

The trigger frequency counter is available for free and is activated when you register your 7 Series oscilloscope.

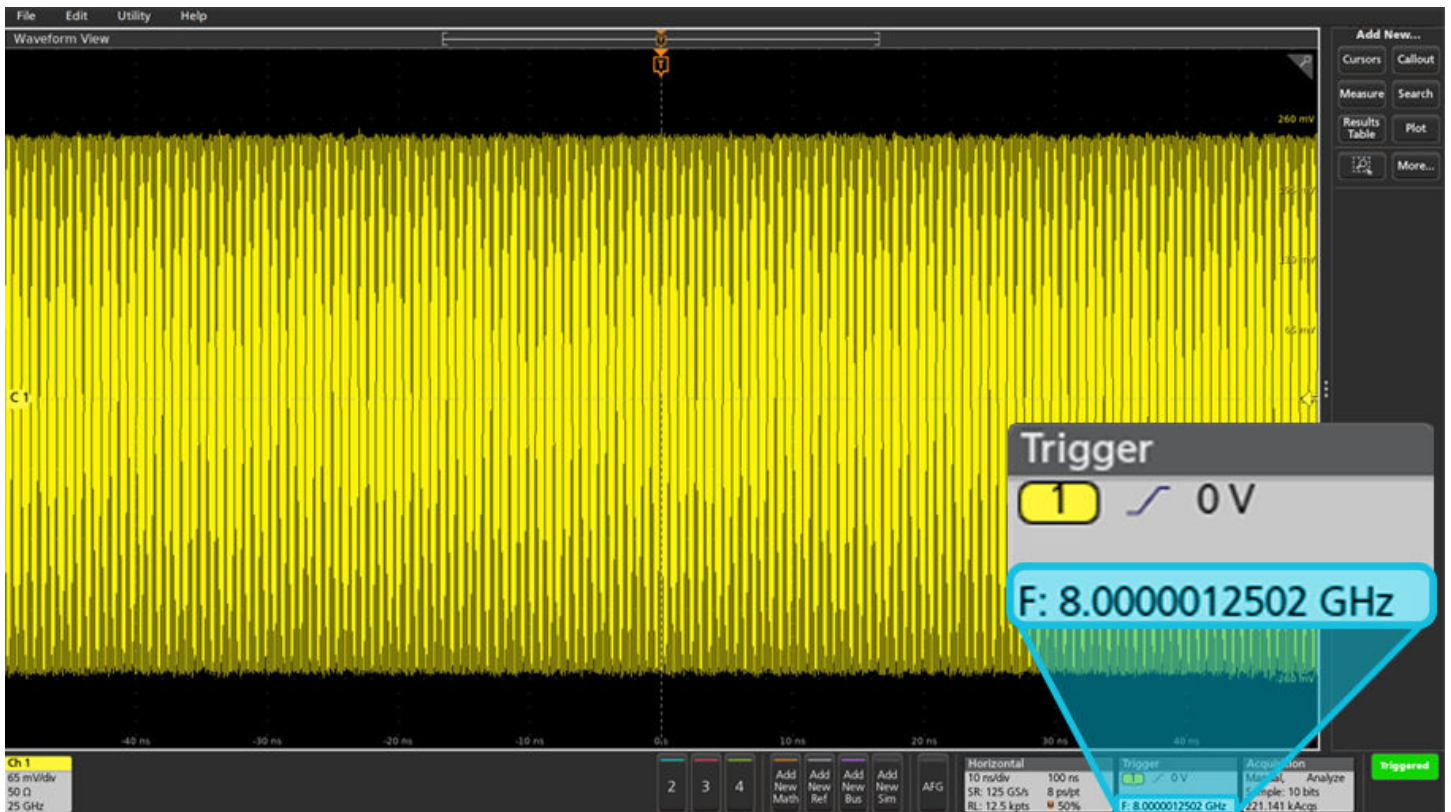

**Free 11-digit trigger frequency counter when registering your 7 Series oscilloscope.**

### Enhanced security

The 7 Series DPO provides you with the option to protect company data through the Security menu. This includes the option to restrict access to the instrument by password-protecting remote network access, I/O ports, and firmware updates to ensure the security of the data. By default, the oscilloscope disables remote access on initial use and gives you the option to enable remote access with or without a password.

To clear user data, run TekSecure from the menu. Sanitize the oscilloscope by removing the SSD from the rear of the instrument and removing power to the instrument for 30 seconds.

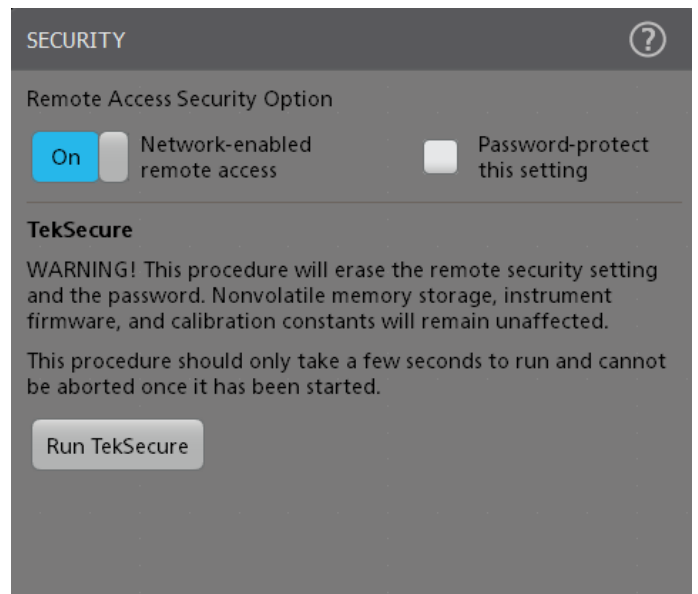

## Help when you need it

Several helpful resources are included so you can get your questions answered rapidly without having to find a manual or go to a website:

## Option Asset Management

Option asset management: floating or node-locked (fixed)

Many Tektronix application solutions and hardware options are enabled with an encrypted license key that is entered through the oscilloscope's Utilities menu. You now have two options:

- The first option is a node-locked license applied to a specific scope serial number and is permanently enabled. A node-locked license cannot be moved from one oscilloscope to another.
  - The second option is a floating license. Floating licenses provide the capability to move a license-key enabled option from one oscilloscope to another. This capability helps users with distributed teams and several Tektronix 7 Series oscilloscopes to better manage their assets and deploy applications or other options such as extended memory to the oscilloscope where it is needed.
- Managing and deploying floating licenses uses an easy online licensing management system. All floating license management functions are maintained on Tektronix secure servers and no infrastructure or your company IT department involvement is necessary. Simply utilize your tek.com account to access, track, and deploy your oscilloscope floating-license enabled options.

- Graphical images and explanatory text are used in numerous menus to provide quick feature overviews.
- All menus include a question mark icon in the upper right that takes you directly to the portion of the integrated help system that applies to that menu.

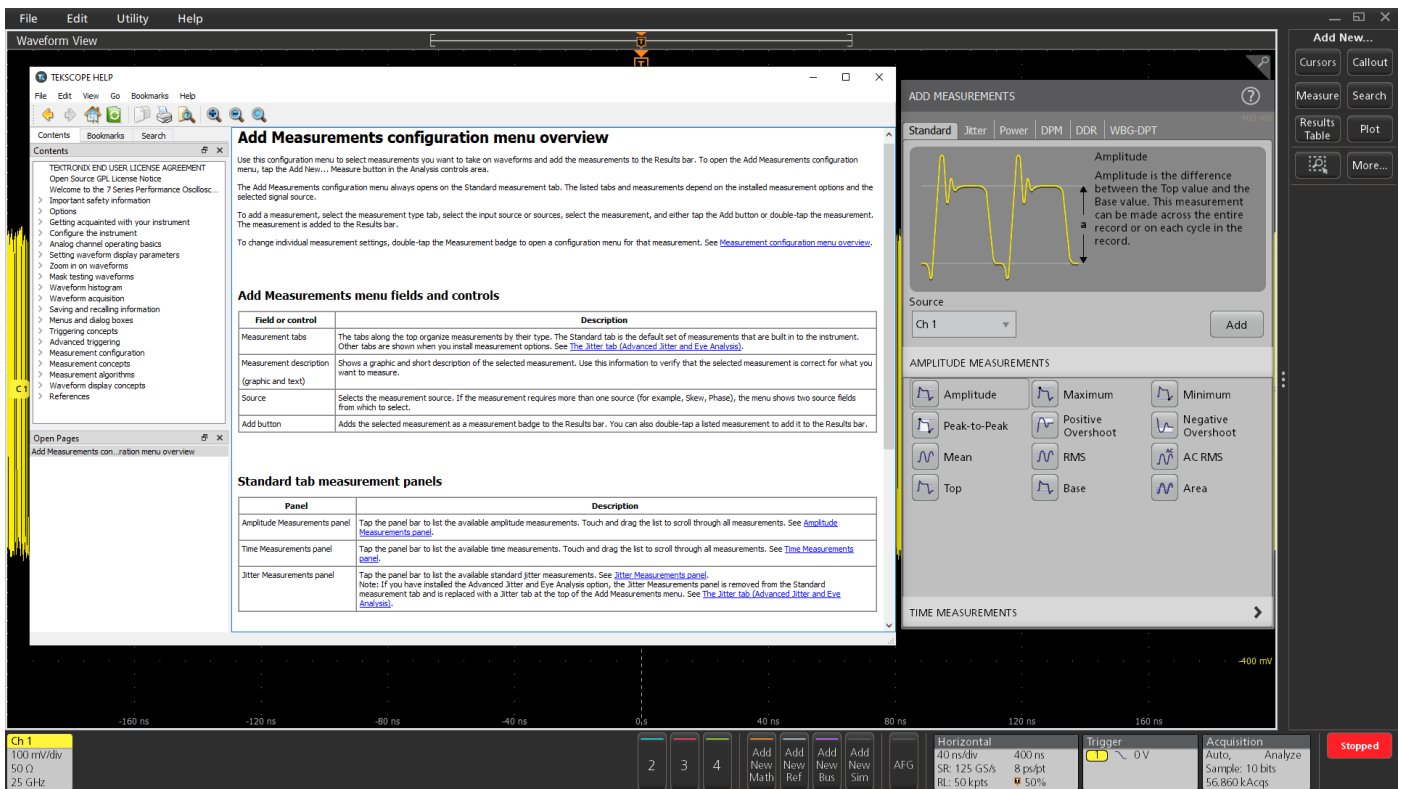

*Integrated help answers your questions rapidly without having to find a manual or go to the internet.*

## RM7 Custom rackmount kit for your 7 Series

Tektronix has developed the RM7, a custom-engineered, 1U rack mount that enables installation of any 7 Series DPO instrument into a standard 19-inch wide equipment rack.



- Slides fit racks of 20-36 inch depth
- Draws air from front grill (behind rack handle) and exhausts to rear in 7 Series DPO instrument
- Only need to remove and store 4 handles (provision to store all 4 handles on bottom of rack tray) – no need to remove instrument covers
- Rack slides enable pulling 7 Series DPO from rack to access rear of instrument (e.g., access removable SSD or install/remove cables)
- Comes with M5 screws and rack nuts

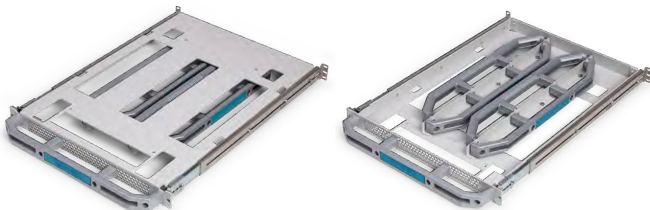

## HC7 Custom transit case to safely transport and protect your 7 Series

Tektronix has developed the HC7, a custom transit case to safely transport and protect the 7 Series DPO instrument from shock, vibration, and moisture. Based on the SKB rSeries 3426-19 case ([rSeries 3426-19 Case](#)), Tektronix developed a custom-engineered, multi-layer, foam insert to ensure maximum protection, with cutouts in the foam for the standard accessories including five (5) TCA292D TekConnect adapters, the instrument power cord, and the front-panel cover installed on the instrument to ensure a secure fit in the foam cutout. Other features include a retractable carrying handle, wheels, automatic air pressure equalization control valve for use during air transport, security rings for use with lock (lock not included), and a flat plate for attaching the shipping label.





The case with any 7 Series DPO instrument and standard accessories installed was designed to weigh less than 150 lbs (68.04 kg) shipping weight to ensure pallet-free shipping.

Specification	Description
Material	Case: Impact-resistant/UV stabilized LLDPE Polyethylene  Interior: Layers of Polyethylene foam, Polyurethane foam, and Crosslink polyethylene foam
Exterior Dimensions	Refer to Physical Characteristics in the Specifications section for exterior dimensions
Shipping Weight (with foam insert)	Refer to Physical Characteristics in the Specifications section for shipping weights

## Specifications

All specifications are typical unless noted. Specifications marked with the ✓ symbol are guaranteed and can be checked using procedures in the 7 Series DPO Specifications and Performance Verification technical reference manual available on [tek.com](http://tek.com).

### Model overview

Specification	DP0714AX	
Maximum analog channels	4	
TekConnect inputs	4	
Analog bandwidth	8 GHz, 10 GHz, 13 GHz, 16 GHz, 20 GHz, 25 GHz	
Rise Time (calculated, typical)	10% to 90%: 8 GHz (50 ps), 10 GHz (40 ps), 13 GHz (30.8 ps), 16 GHz (25 ps), 20 GHz (20 ps), 25 GHz (16 ps) 20% to 80%: 8 GHz (37.5 ps), 10 GHz (30 ps), 13 GHz (23.1 ps), 16 GHz (18.8 ps), 20 GHz (15 ps), 25 GHz (12 ps)	
DC gain accuracy	±2.0% <sup>1</sup> at >20 mV full scale ±2.0% <sup>1</sup> at 20 mV full scale, typical ±1.0% <sup>2</sup> of full scale at ≥40 mV full scale ±1.0% <sup>2</sup> of full scale from 20 mV full scale to <40 mV full scale, typical	
Vertical resolution	10 bits	
Number of digitized bits	10 bits at all sample rates	
Noise reduction	QuietChannel™ technology with Active CTLE (Continuous Time Linear Equalization) with 7 boost setting and one-button optimization routine which selects the optimal setting for the input signal to compensate for high-frequency signal channel loss.	
Sample rate (resolution)	125 GS/s on 4 channels (8 ps)	
Record length	500 Mpoints on all channels standard 1 Gpoints, 2 Gpoints on all channels optional	
Acquisition time at maximum sample rate	500 Mpoints	4 ms
	1 GPoints	8 ms
	2 GPoints	16 ms
Arbitrary Function Generator (optional)	13 predefined waveform types with up to 100 MHz output, both single-ended and differential	
Trigger Frequency Counter	11-digit frequency counter (free with product registration)	
Network interfaces	10 Gbps SFP+ port and 1 Gbps RJ-45	
TekHSI® technology	Provides fast data offload, enabling saturation of the 10 Gbps SFP+ network interface Available with Python and C# libraries	

<b>Specification</b>	<b>DP0714AX</b>
<sup>1</sup> Immediately following SPC, add 1% for every 5 °C change in ambient temperature. <sup>2</sup> Immediately following SPC, add 0.5% for every 5 °C change in ambient temperature.	

## Vertical system - analog channels

### Number of analog input channels

4

### DC Input Resistance ✓

#### Vertical scale < 100 mV/div:

50 Ω ± 1.5 Ω from 18 °C to 28 °C

50 Ω ± 2 Ω from 5 °C to 40 °C

#### Vertical scale ≥ 100 mV/div:

50 Ω ± 1.65 Ω from 18 °C to 28 °C

50 Ω ± 2.2 Ω from 5 °C to 40 °C

### Input sensitivity range

**Coarse:** 1 mV/div to 500 mV/div in a 1-2-5 sequence

**Fine:** Allows continuous adjustment from 1 mV/div to 500 mV/div

Magnification is used below 4 mV/div.

### Maximum input voltage

Overvoltage trip is intended to protect against overloads that may damage termination resistors. A sufficiently large impulse may cause damage regardless of the overvoltage protection circuitry because of the finite time required to detect and respond.

### Standard analog channels:

2.3 V<sub>RMS</sub>, at <100 mV/div, -20 V ≤ peak ≤ +20 V (Pulse Width ≤1 μs)

5.5 V<sub>RMS</sub>, at ≥100 mV/div, -20 V ≤ peak ≤ +20 V (Pulse Width ≤100 μs)

### Aux In:

-5 V ≤ peak ≤ +5 V

### Input termination voltage range

±4.0 V with P7600 and P7700 probes

### Vertical resolution

10 bits

### Number of digitized bits

## 7 Series DPO Digital Phosphor Oscilloscope Datasheet

10 bits at all sample rates

For 10-bit mode, there are 1023 DL's (digitizing levels) in a captured waveform. In an un-zoomed time-domain waveform plot, the full vertical scale of the plot (in 10-bit mode) is 1000 DL's. There may be digitizing levels "offscreen", but are still available for measurement, analysis, download, etc.

In Sample mode, the channel bandwidth is allowed to be above the Nyquist frequency.

### DC gain accuracy

±2.0% at >20 mV full scale

±2.0% at 20 mV full scale, typical

Immediately following SPC, add 1% for every 5 °C change in ambient temperature.

±1.0% of full scale at ≥40 mV full scale

±1.0% of full scale from 20 mV full scale to <40 mV full scale, typical

Immediately following SPC, add 0.5% for every 5 °C change in ambient temperature.

### Effective bits (ENOB)

Specification applies to 50 mV/div, 50 kS record length, Quiet Channel is OFF.

Vertical scale = 50 mV/div; Sample rate = 125 GS/s; Signal amplitude = 90% full scale										
Frequency (GHz)	Effective Number of Bits (bit) Greater Than									
	Channel bandwidth (GHz), BW Filter Optimized for Flatness									
	25	20	16	13	10	8	6	4	2	1
<b>Average:</b>	6.5	6.9	7.1	7.2	7.4	7.5	7.5	7.6	7.6	7.6

### Bandwidth selections

1 GHz starting bandwidth to the instrument bandwidth in 1 GHz increments

### Bandwidth filtering optimization

Optimized for Flatness or Step response

### Random noise, RMS

125 GS/s, QuietChannel Setting = Off <sup>2, 3, 4</sup>						
Vertical scale (mV/div)	Channel bandwidth (GHz), BW Filter Optimized for Flatness					
	25	20	16	13	10	8
<b>1</b>	309 μV	261 μV	222 μV	195 μV	174 μV	155 μV
<b>2</b>	309 μV	261 μV	222 μV	195 μV	174 μV	155 μV

7 Series DPO Digital Phosphor Oscilloscope Datasheet

125 GS/s, QuietChannel Setting = Off <sup>2, 3, 4</sup>						
5	329 μV	267 μV	232 μV	200 μV	174 μV	157 μV
10	365 μV	279 μV	244 μV	220 μV	191 μV	171 μV
20	550 μV	418 μV	377 μV	320 μV	279 μV	254 μV
50	1.13 mV	864 μV	743 μV	680 μV	595 μV	523 μV
100	2.97 mV	2.29 mV	1.97 mV	1.67 mV	1.45 mV	1.32 mV
500	10.3 mV	8.53 mV	7.55 mV	6.48 mV	5.5 mV	5.01 mV
125 GS/s, QuietChannel Setting = QC7 <sup>2, 3, 4</sup>						
Vertical scale (mV/ div)	Channel bandwidth (GHz), BW Filter Optimized for Flatness					
	25	20	16	13	10	8
1	321 μV	257 μV	218 μV	193 μV	172 μV	153 μV
2	321 μV	257 μV	218 μV	193 μV	172 μV	153 μV
5	321 μV	262 μV	218 μV	195 μV	170 μV	154 μV
10	324 μV	270 μV	231 μV	197 μV	171 μV	155 μV
20	445 μV	361 μV	309 μV	277 μV	231 μV	213 μV
50	767 μV	615 μV	534 μV	488 μV	438 μV	396 μV
100	2.35 mV	1.89 mV	1.63 mV	1.41 mV	1.23 mV	1.13 mV
500	6.54 mV	5.78 mV	5.25 mV	4.58 mV	4 mV	3.75 mV
125 GS/s, Quiet Channel = QC4 <sup>1, 2, 3, 4</sup>						
Vertical scale (mV/ div)	Channel bandwidth (GHz), BW Filter Optimized for Flatness					
	25	20	16	13	10	8
1	-	267 μV	225 μV	199 μV	177 μV	158 μV

125 GS/s, QuietChannel Setting = Off <sup>2, 3, 4</sup>						
<b>2</b>	-	267 μV	225 μV	199 μV	177 μV	158 μV
<b>5</b>	-	262 μV	225 μV	201 μV	175 μV	159 μV
<b>10</b>	-	282 μV	232 μV	207 μV	181 μV	164 μV
<b>20</b>	-	411 μV	333 μV	291 μV	246 μV	229 μV
<b>50</b>	-	808 μV	631 μV	536 μV	480 μV	438 μV
<b>100</b>	-	2.18 mV	1.76 mV	1.48 mV	1.3 mV	1.21 mV
<b>500</b>	-	7.33 mV	5.92 mV	5.02 mV	4.38 mV	4.14 mV

<sup>1</sup> Bandwidth is automatically limited to 20 GHz for QC settings 1-4.  
<sup>2</sup> Full scale vertical settings from 10 mV to 999.9 mV use 1x input path (0 dB attenuation).  
<sup>3</sup> Full scale vertical settings from 1 V to 5 V use 5x input path (14 dB attenuation).  
<sup>4</sup> Full scale is defined as 10 divisions.

**Channel-to-channel isolation**

>70 dB up to 25 GHz for all channel combinations

Assumes two channels with the same bandwidth setting and set to 20 mV/div. The limits apply up to the bandwidth of the particular instrument.

Channel-to-channel isolation is measured with QuietChannel in the off state.

**Analog DC**

**Offset range**

Input signal cannot exceed maximum input voltage.

Vertical scale (mV/div)	Offset range (V)
1 to <100	±1
100 to 500	±5

**Position range**

±5 divisions

**Offset accuracy**

Vertical scale	Offset accuracy
<4 mV/div	± (0.003 ×  offset – position  + 0.7 mV + 0.13 div × vertical scale)

## 7 Series DPO Digital Phosphor Oscilloscope Datasheet

Vertical scale	Offset accuracy
4 mV/div to <100 mV/div	$\pm (0.003 \times  \text{offset} - \text{position}  + 0.7 \text{ mV} + 0.087 \text{ div} \times \text{vertical scale})$
$\geq 100 \text{ mV/div}$	$\pm (0.005 \times  \text{offset} - \text{position}  + 3.5 \text{ mV} + 0.087 \text{ div} \times \text{vertical scale})$

### DC voltage measurement accuracy ✓

Average acquisition mode.

Measurement type	DC accuracy
Average of $\geq 16$ waveforms	$\pm((\text{DC Gain Accuracy}) \times  \text{reading} - (\text{offset} - \text{position})  + \text{Offset Accuracy} + \text{digitizer nonlinearity} + \text{CVR nonlinearity})$
Delta volts between any two averages of $\geq 16$ waveforms acquired with the same oscilloscope setup and ambient conditions	$\pm(\text{DC Gain Accuracy} \times  \text{reading}  + 2 \times (\text{digitizer nonlinearity} + \text{CVR nonlinearity}))$

Calibrated Voltage Reference (CVR) nonlinearity is assumed to be negligible (zero) since it is factory calibrated across the full CVR range. CVR nonlinearity term is left in the equation for completeness but it has negligible effect on this specification.

Offset, position, and the constant offset term must be converted to volts by multiplying by the appropriate vertical setting.

### Digitizer nonlinearity

**Integral nonlinearity (INL) at  $\geq 15 \text{ mV/div}$ :**  $\pm 3$  DLs (10-bit reference)

**Integral nonlinearity (INL) at  $< 15 \text{ mV/div}$ :**  $\pm 4$  DLs (10-bit reference)

**Differential nonlinearity (DNL):**  $\pm 1.0$  DLs (10-bit digitizing scale)

Derate all specifications above by  $0.1 \text{ DL}/^\circ\text{C}$ .

### Analog AC

#### Analog bandwidth

Bandwidth option	Maximum analog bandwidth
BW-25000	25 GHz
BW-20000	20 GHz
BW-16000	16 GHz
BW-13000	13 GHz
BW-10000	10 GHz
BW-8000	8 GHz

**Frequency response tolerance (flatness)**

±0.6 dB from DC to ≤ 65% of rated bandwidth for all acquisition modes except peak detect

±1.0 dB from 65% to 90% of rated bandwidth for all acquisition modes except peak detect

Valid for all QuietChannel settings. If the QuietChannel setting is QC1, QC2, QC3 or QC4, the bandwidth will be limited to ≤ 20 GHz.

Gain tolerance temperature is derated from factory adjust temperature.

Frequency (GHz)	Gain tolerance derating (dB/°C)
25	±0.08
20	±0.06
16	±0.04
13	±0.03
10	±0.02
8	±0.02

**Frequency response tolerance (flatness) with P7625 Probe**

±0.9 dB from DC to 80% of rated bandwidth when used with P76CA-292 (2.92 mm TriMode tip)

Not valid while using peak detect or envelope mode. Valid for probe modes A, B, and D.

**Frequency response tolerance (flatness) with P7720 Probe**

±0.9 dB from DC to 80% of rated bandwidth when used with P77C292MM (SMA probe tip)

Not valid while using peak detect or envelope mode. Valid for probe modes A, B, and D.

**Phase flatness**

<3° within any 10 GHz span up to 70% of bandwidth setting.

<5° from DC to 70% of bandwidth setting.

**QuietChannel settings**

Each setting from QC1 to QC7 provides specific frequency response.

**Off:** QuietChannel disabled

**QC1, QC2, QC3, QC4** boosting peaks in the 9 GHz to 12 GHz range. However, these settings create additional loss above 20 GHz. If the oscilloscope bandwidth is set to a value > 20 GHz and QC1 to QC4 are selected, the oscilloscope bandwidth will automatically be limited to a maximum of 20 GHz.

**QC5, QC6, QC7** boosting peaks in the 16 GHz to 20 GHz range.

**Calculated transition time**

10% to 90% transition time = 0.4/(rated bandwidth)

20% to 80% transition time = 0.3/(rated bandwidth)

Bandwidth option	Calculated transition time 10% to 90% (ps)	Calculated transition time 20% to 80% (ps)
BW-25000	16.0	12.0
BW-20000	20.0	15.0
BW-16000	25.0	18.8
BW-13000	30.8	23.1
BW-10000	40.0	30.0
BW-8000	50.0	37.5

### Step response settling errors

This specification does not apply to QuietChannel™ settings. Percentages are relative to step amplitude.

Vertical scale (mV/div)	Step amplitude	Settling error after 150 ps	Settling error after 400 ps	Settling error after 3 ns	Settling error after 1 μs	Settling error after 1 ms
5	≤5 div	<3.5%	<2.5%	<1.5%	<0.75%	<0.25%
20						
50						
100						
200						

### RF characteristics

#### Sensitivity (noise density)

-164 dBm/Hz at or below 20 GHz

-161 dBm/Hz above 20 GHz

#### Displayed Average Noise Level (DANL)

Frequency range	Vertical scale (mV/div)	DANL (dBm/Hz)
10 MHz to <3 GHz	4	< -164
3 GHz to <8 GHz		< -165
8 GHz to <12 GHz		< -165
12 GHz to <18 GHz		< -163
18 GHz to 25 GHz		< -161

**Noise figure**

Frequency range	Vertical scale (mV/div)	Noise figure (dB)
10 MHz to <3 GHz	4	≤10
3 GHz to <8 GHz		≤9
8 GHz to <12 GHz		≤9
12 GHz to <18 GHz		≤11
18 GHz to 25 GHz		≤13

**Signal-to-noise ratio (SNR) (dynamic range)**

Center frequency (GHz)	SNR (dB)	Details
1	≥111	0 dBm instrument input range, 100 MHz span, 1 kHz RBW, measured ±20 MHz from center
10	≥106	

**Phase noise**

Frequency offset	Phase noise at 1 GHz (dBc/Hz)	Phase noise at 10 GHz (dBc/Hz)
10 kHz	≤-118	≤-102
100 kHz	≤-124	≤-109
1 MHz	≤-134	≤-119
10 MHz	≤-142	≤-131

**Error Vector Magnitude (EVM)**

Conditions	EVM (relative to reference vector power)	
	RMS normalization	Peak normalization
10 GHz, 256 QAM, 100 MHz BW	≤1.06%	≤0.66%
7 GHz, 256 QAM, 7 GHz BW	≤1.61%	≤0.99%

**Spurious Free Dynamic Range (SFDR)**

Conditions	SFDR (dBc)
2.35 GHz sine, -4 dBm, 2.35 GHz CF, 1.5 GHz span, ≤100 kHz RBW	≤-80
3 GHz sine, -4 dBm, 3 GHz CF, 5 GHz span, ≤100 kHz RBW	≤-63

**S<sub>11</sub> Return Loss and Voltage Standing Wave Ratio (VSWR)**

Vertical scale (mV/div)	Frequency range	S <sub>11</sub>   (dB)	VSWR
<100	≤9 GHz	≤14	1.50
	>9 GHz to ≤15 GHz	≤11	1.79
	>15 GHz to ≤25 GHz	≤9	2.10
≥100	≤9 GHz	≤14	1.50
	>9 GHz to ≤25 GHz	≤10	1.93

**2<sup>nd</sup> and 3<sup>rd</sup> harmonic distortion**

Fundamental frequency (GHz)	2 <sup>nd</sup> harmonic (dBc)	3 <sup>rd</sup> harmonic (dBc)
1	≤-60	≤-60
10	≤-60	-

For 2nd and 3rd harmonic distortion tests: 50 mV full scale (5 mV/div), -28 dBm input signal (~50% of full scale) at 100 kHz RBW

**2<sup>nd</sup> and 3<sup>rd</sup> order intermodulation distortion**

Frequency (tone 1)(GHz)	2 <sup>nd</sup> order intermodulation (IM2) (dBc)	3 <sup>rd</sup> order intermodulation (IM3) (dBc)
3.5	≤-50	≤-60
10	≤-50	≤-62
18	≤-50 (single sided)	≤-45
23	≤-50 (single sided)	≤-45

For 2nd and 3rd order intermodulation tests: Two sine waves, 10 MHz spacing, 5 mV/div, -29 dBm/tone

**Horizontal system**

**Record length range**

**Minimum:** 50 points

**Maximum:** 500 Mpoints (1 Gpoints, 2 Gpoints optional)

**Increment:** 1 point

**Horizontal scale range**

400 fs/div to 1000 s/div (auto-mode)

Record length	Horizontal scale range
50 points	400 fs/div to 8 ms/div

## 7 Series DPO Digital Phosphor Oscilloscope Datasheet

Record length	Horizontal scale range
1 kpoints	8 ps/div to 160 ms/div
10 kpoints	80 ps/div to 1.6 s/div
100 kpoints	800 ps/div to 16 s/div
1 Mpoints	8 ns/div to 160 s/div
10 Mpoints	80 ns/div to 1000 s/div
100 Mpoints	800 ns/div to 1000 s/div
500 Mpoints	4 $\mu$ s/div to 1000 s/div
1 Gpoints (optional)	8 $\mu$ s/div to 1000 s/div
2 Gpoints (optional)	16 $\mu$ s/div to 1000 s/div

### Aperture uncertainty (sample jitter)

Time duration	Aperture uncertainty RMS (mean + 3 $\sigma$ ) (fs)			
	Internal reference <sup>1</sup>	External reference stable 15 ppm <sup>1</sup>	External reference tracking 1000 ppm <sup>1</sup>	External sample clock <sup>1,2</sup>
<100 ns	$\leq 50$	$\leq 50$	$\leq 50$	$\leq 40$
1 $\mu$ s	$\leq 60$	$\leq 60$	$\leq 100$	Follows jitter of 7.8125 GHz source with floor at $\leq 40$ fs
10 $\mu$ s	$\leq 70$	$\leq 70$	$\leq 200$	
100 $\mu$ s	$\leq 70$	$\leq 70$	$\leq 400$	
1 ms	$\leq 70$	$\leq 70$	$\leq 600$	
<sup>1</sup> Values are mean + 3 $\sigma$ computed on 50 consecutive acquisitions. <sup>2</sup> Assumes the source 7.8125 GHz clock has much lower short term jitter than 35 fs.				

### Timebase accuracy

Description	Specification
Factory tolerance	$\leq 12$ ppb initial accuracy
Temperature stability	$\pm 20$ ppb across the full operating range of 5 °C to 40 °C, after a sufficient soak time at temperature; tested at operating temperatures
Aging	$\leq 2$ ppb daily aging $\leq 300$ ppb within first year aging $\leq 100$ ppb for each year thereafter

The instrument needs to soak at a fixed temperature for an extended period of time to ensure the timebase frequency is stable. The following is a worst case estimation for the frequency error versus the amount of time the instrument has been soaking at a temperature.

## 7 Series DPO Digital Phosphor Oscilloscope Datasheet

Max error (in ppb) =  $\pm 10^{\lceil \log[100/\text{soak time(in hours)}] \rceil}$

For example, a 1-hour soak will have a max frequency error of  $\pm 100$  ppb, but a 10-hour soak will have a max frequency error of  $\pm 10$  ppb.

### Delta-time measurement accuracy

#### Specification:

$$DTA_{rms} = \sqrt{\left(\frac{N_{rms}}{Slew_1}\right)^2 + \left(\frac{N_{rms}}{Slew_2}\right)^2 + t_j^2 + TBA \times t_p}$$

#### Where:

Slew<sub>1</sub> = Slew Rate (1<sup>st</sup> Edge) around 1<sup>st</sup> point in measurement, s

Slew<sub>2</sub> = Slew Rate (2<sup>nd</sup> Edge) around 2<sup>nd</sup> point in measurement, s

t<sub>j</sub> = Aperture uncertainty or sample jitter (RMS), s (see Aperture uncertainty specification)

TBA = Timebase accuracy including appropriate aging, fraction (see Timebase accuracy specification)

t<sub>p</sub> = Delta time measurement duration, s

N<sub>rms</sub> = Noise estimate (rms), V, given by:

$$N_{rms} = \sqrt{RN_{rms}^2 + DNE^2}$$

#### Where:

RN<sub>rms</sub> = Random noise (rms), V (see Random noise specification)

DNE = Dynamic noise estimate, V, given by:

$$DNE = \frac{BW}{25 \text{ GHz}} \times DNF \times VS$$

#### Where:

BW = Selected bandwidth for acquisition, Hz

VS = Selected vertical scale (one division), V

DNF = Dynamic noise factor, no units (see following table)

Sample rate (GS/s)	Bandwidth setting (GHz)	DNF (unitless)
125	<25	0.01971
	25	0.01759
62.5	<25	0.02481
	25	0.02215

**Example:**

For this example, we calculate the accuracy of a period measurement of one cycle of a 100 MHz PCIe timing clock generator (single ended). As this is a measurement of the time difference between 2 waveform events, the Delta Time measurement Accuracy (DTA) specification applies. For timebase accuracy, we will assume that the scope is 1 year past its previous factory adjust event.

**Signal characteristics:**

- Frequency = 100 MHz
- Period = 10 ns ( $t_p$ )
- Slew Rate = 3.0 V/ns =  $3 \times 10^9$  V/s (Slew1 and Slew2)
- Amplitude (single ended) = 300 mV

**Oscilloscope settings:**

- Bandwidth setting = 10 GHz (BW)
- BW Filter = Optimized for Flatness
- Vertical scale = 50 mV/div (VS)
- Vertical offset = 125 mV
- Sample Rate = 125 GS/s
- Quiet Channel = Off
- Timebase reference = Internal

First, identify the additional terms needed from specifications based on the specific oscilloscope settings:

- Random noise (125 GS/s, Optimized for Flatness, 50 mV/div, 10 GHz) = 595  $\mu$ V ( $RN_{rms}$ )
- Timebase accuracy (1 year) = 300 ppb ( $300 \times 10^{-9}$ ) (TBA)
- Aperture Uncertainty (<100 ns time period, Internal timebase) = 50 fs ( $t_j$ )

Next, we find the Dynamic Noise actor (DNF) from the supplied table:

- DNF (125 GS/s, <25 GHz) = 0.01971

## 7 Series DPO Digital Phosphor Oscilloscope Datasheet

Calculate Dynamic noise estimate (DNE) and Noise estimate (Nrms):

$$DNE = \frac{BW}{25 \text{ GHz}} \times DNF \times VS$$

$$DNE = \frac{(10 \text{ GHz})}{25 \text{ GHz}} \times (0.01971) \times (0.050 \text{ V}) = 394.2 \times 10^{-6} \text{ V}$$

$$N_{rms} = \sqrt{RN_{rms}^2 + DNE^2}$$

$$N_{rms} = \sqrt{(595 \times 10^{-6} \text{ V})^2 + (394.2 \times 10^{-6} \text{ V})^2} = 713.7 \times 10^{-6} \text{ V}$$

Finally, calculate Delta time measurement accuracy (DTA):

$$DTA_{rms} = \sqrt{\left(\frac{N_{rms}}{Slew_1}\right)^2 + \left(\frac{N_{rms}}{Slew_2}\right)^2 + t_j^2 + TBA \times t_p}$$

$$DTA_{rms} = \sqrt{\left(\frac{(713.7 \times 10^{-6} \text{ V})}{(3 \times 10^9 \text{ V/s})}\right)^2 + \left(\frac{(713.7 \times 10^{-6} \text{ V})}{(3 \times 10^9 \text{ V/s})}\right)^2 + (50 \times 10^{-15} \text{ s})^2 + (300 \times 10^{-9}) \times (10 \times 10^{-9} \text{ s})}$$

$$DTA_{rms} = 343.1 \times 10^{-15} \text{ s} = 343.1 \text{ fs}$$

**Timebase delay range**

-10 divisions to 5000 s

**Deskew range**

-125 ns to +125 ns

**Deskew resolution**

10 fs

**Skew between analog channels**

≤2 ps for any two channels with the following conditions on the two channels:

Channels on the same instrument; signal amplitude at least 5 divisions; same bandwidth setting; QuietChannel setting = Off

**Trigger system**

**Trigger sources**

All analog channel inputs, Aux input, AC line

**Trigger modes**

Auto, Normal

**Trigger coupling**

DC, noise reject (reduces sensitivity)

**Trigger holdoff range**

0 ns to 20 s

**Trigger holdoff resolution**

2.048 ns

**Trigger bandwidth**

Trigger type	Trigger bandwidth
Edge, Pulse (analog channels)	Bandwidth setting
Edge (Aux In)	8 GHz

**Edge-type trigger sensitivity**

Trigger source	Vertical scale (mV/div)	Minimum sensitivity (peak-to-peak)
Analog channels	1 to <5	≤10 mV
	5 to <10	≤2 divisions
	10 to 500	≤1 division
Aux In		100 mV from DC to <1 GHz 175 mV from 1 GHz to <4 GHz 300 mV from 4 GHz to ≤8 GHz

Trigger level may need to be adjusted to account for trigger hysteresis.

### AC Line trigger

**Line voltage (AC RMS):** 90 V to 264 V

**Line frequency:** 50 Hz to 60 Hz

### Aux Out trigger latency

The delay from the trigger event to trigger signal output.

**Normal:**  $\leq 1.85 \mu\text{s}$

**Low-latency:**  $\leq 20 \text{ ns}$ , Channel 1 and Aux In only, accessible from the User Preferences menu

### Trigger jitter

#### Analog channels (RMS)

$\leq 10 \text{ fs}$

#### Conditions:

Vertical scale: 50 mV/div

Sample rate: 125 GS/s

Horizontal trigger position: 50%

Trigger mode: Edge

Trigger level: 0 V

Input signal: 3 division peak-to-peak sine wave  $> 1 \text{ GHz}$

#### Aux In (peak-to-peak)

$\leq 80 \text{ ps}$

### Trigger level ranges

Trigger source	Trigger level range
Analog channels	$\pm 5$ divisions from center of screen
AC Line	Fixed near 50% of the line voltage
Aux In	$\pm 5 \text{ V}$

### Trigger types

#### Edge:

Positive, negative, or either slope on any channel. Coupling includes DC and noise reject.

#### Pulse Width:

Trigger on width of positive or negative pulses. Event can be time- or logic-qualified.

**Cycle:**

Trigger on signals of specified frequency/period.

**Dual Edge:**

Trigger on width of positive or negative pulses. Event can be time- or logic-qualified.

**Timeout:**

Trigger on an event which remains high, low, or either, for a specified time period. Event can be logic-qualified.

**Runt:**

Trigger on a pulse that crosses one threshold but fails to cross a second threshold before crossing the first again. Event can be time- or logic-qualified.

**Window:**

Trigger on an event that enters, exits, stays inside, or stays outside of a window defined by two user-adjustable thresholds. Event can be time- or logic-qualified.

**Rise / Fall Time:**

Trigger on pulse edge rates that are faster or slower than specified. Slope may be positive, negative, or either. Event can be logic-qualified.

**Sequence:**

Trigger on B event after a user specified time delay or N events after A trigger with a reset on C event. In general, A and B trigger events can be set to any trigger type with a few exceptions: logic qualification is not supported.

**Visual:**

Qualifies standard triggers by scanning all waveform acquisitions and comparing them to on-screen areas (geometric shapes). An unlimited number of areas can be defined with In, Out, or Don't Care as the qualifier for each area. A boolean expression can be defined using any combination of visual trigger areas to further qualify the events that get stored into acquisition memory. Shapes include rectangle, triangle, trapezoid, hexagon and user-defined.

**Time Range for time qualified triggers**

The minimum to maximum time, in seconds, to which the instrument can be set for discriminating Pulse Widths, Timeout, Time-qualified Runt, Time-qualified Window, and Transition Time Trigger.

Trigger type	Triggers condition	Minimum time	Maximum time
Pulse Width, Runt, Rise/Fall time	< Limit, > Limit	32 ps	20 s
	= Limit, ≠ Limit	320 ps	
Pulse Width	Inside range, Outside range	32 ps	
Cycle	< Limit, > Limit, Inside range, Outside range	64 ps	
	= Limit, ≠ Limit	640 ps	
Timeout	Stays high, Stays low, Either	32 ps	
Window	Inside > Limit, Outside > Limit	32 ps	

### Trigger level accuracy

For signals having rise and fall times  $\geq 10$  ns and using a single trigger level, the limits are as follows:

Source	Range
Any input channel	$\pm 0.20$ div $\pm (10\% \times   \text{trigger threshold level} - \text{offset}  ) + (3.5\% \times \text{full scale}) + \text{offset accuracy}$ <sup>1</sup>
Aux In	Not specified
<sup>1</sup> Channel 1, Edge type, Low Latency Trigger Out = On	

### Time accuracy for pulse width and timeout triggering

$$\pm (16 \text{ ps} + (\text{Timebase Accuracy} \times \text{Setting}))$$

Timebase Accuracy when locked to an external source is equivalent to the accuracy of the external source.

### Pulse-type Trigger, Minimum Pulse, Re-arm Time, Transition Time

Pulse class	Minimum pulse width	Minimum rearm time
Runt	32 ps	32 ps
Time-qualified runt		
Width		

Trigger Time	Minimum transition time	Minimum rearm time
Rise/Fall Time	32 ps	32 ps

### Pulse-type runt trigger sensitivities

$\geq 2.0$  division, at vertical scale  $\geq 5$  mV/div

### Pulse-type trigger width sensitivities

$\geq 2.0$  division, at vertical scale  $\geq 5$  mV/div

### B Trigger after events, minimum pulse width, and maximum event frequency

**Minimum pulse width:** 32 ps between threshold + hysteresis crossings

**Maximum frequency of B-events counted:** 62.5 Gevents/s (static event count to full sample rate, AC events are limited by instrument bandwidth)

### B Trigger, minimum time arm and trigger

32 ps

For trigger after time, this is the time between the end of the time period and the B trigger event.

For trigger after events, this is the time between the last A trigger event and the first B trigger event.

### B Trigger after time

**Time range:** 32 ps to 100 s

**Time accuracy:**  $\pm(16 \text{ ps} + (\text{Timebase error} \times \text{Setting}))$

### B Trigger after events, event range

1 event to 20 Gevents

### Lowest frequency for successful operation of “Set Level to 50%” function

45 Hz

### Triggered acquisition rate

For record/segment length = 1000 points, input frequency = 100 MHz

>550 per second

## Acquisition system

### Acquisition Modes

Acquisition mode	Description
Sample	Acquires sampled values
Peak Detect	Captures glitches as narrow as 32 ps at all sweep speeds
Envelope	Min-max envelope reflecting Peak Detect data over multiple acquisitions
Average	From 2 to 10,240 waveforms, default 16 waveforms

### Peak Detect or Envelope Mode Minimum Detectable Pulse

$\leq 16 \text{ ps}$

### Sample rate range

**Interpolated:** 250 GS/s to 12.5 TS/s

**Real-time:** 625 S/s to 125 GS/s

## Waveform measurements

### Cursor types

Waveform, Vertical (V) Bars, Horizontal (H) Bars, V&H Bars, and Polar (XY/XYZ plots only)

### Automatic measurements

36 types of time and amplitude measurements. An unlimited number can be displayed as either individual measurement badges or collectively in a measurement results table.

### Amplitude measurements

Amplitude, Maximum, Minimum, Peak-to-Peak, Positive Overshoot, Negative Overshoot, Mean, RMS, AC RMS, Top, Base, and Area

### Timing measurements

## 7 Series DPO Digital Phosphor Oscilloscope Datasheet

Period, Frequency, Unit Interval, Data Rate, Positive Pulse Width, Negative Pulse Width, Skew, Delay, Rise Time, Fall Time, Phase, Rising Slew Rate, Falling Slew Rate, Burst Width, Positive Duty Cycle, Negative Duty Cycle, Time Outside Level, Setup Time, Hold Time, Duration N-Periods, High Time, Low Time, Time to Minimum, and Time to Maximum

### Jitter measurements (standard)

TIE and Phase Noise

### Measurement statistics

Mean, Standard Deviation, Maximum, Minimum, Peak-to-Peak, and Population. Statistics are available on both the current acquisition and all acquisitions.

### Reference levels

User-definable reference levels for automatic measurements can be specified in either percent or units. Reference levels can be set to global for all measurements, per source channel or signal, or unique for each measurement.

### Gating

Screen, Cursors, Logic, Search, or Time. Specifies the region of an acquisition in which to take measurements. Gating can be set to Global (affects all measurements set to Global) or Local (all measurements can have a unique Time gate setting; only one Local gate is available for Screen, Cursors, Logic, and Search actions).

### Measurement plots

Histogram, Time Trend, Spectrum, Eye Diagram (TIE measurement only), Phase Noise (Phase Noise measurement only)

### Measurement limits

Pass/fail testing for user-definable limits on measurement values. Act on event for measurement value failures include Save Screen Capture, Save Waveform, System Request (SRQ), and Stop Acquisitions

### Advanced Jitter Analysis (optional):

#### Measurements

Jitter measurements (Jitter Summary, TIE, Phase, Noise, TJ@BER, RJ-  $\delta\delta$ , DJ-  $\delta\delta$ , PJ, RJ, DJ, DDJ, ISI, DCD, SRJ, J2, J9, NPJ, F/2, F/4, F/8, CC-Jitter)

Eye Measurements (Eye Height, Eye Height@BER, Eye Width, Eye Width@BER, Eye High, Eye Low, Q-Factor)

Amplitude Measurements (Bit High, Bit Low, Bit Amplitude, DC Common Mode, AC Common Mode (Pk-Pk), Differential Crossover, T/nT Ratio)

Time Measurements (Data Rate, Pattern Length, SSC Freq Dev, SSC Modulation Rate, SSC Slew Rate)

#### Measurement plots

Eye Diagram, Composite Jitter Histogram, and Jitter Bathtub

Fast eye rendering: Shows the Unit Intervals (UIs) that define the boundaries of the eye along with a user specified number of surrounding UIs for added visual context

Complete eye rendering: Shows all valid Unit Intervals (UIs)

#### Measurement limits

Pass/fail testing for user-definable limits on measurement values. Act on event for measurement value failures include Save Screen Capture, Save Waveform, System Request (SRQ), and Stop Acquisitions

### Eye diagram mask testing

Automated mask pass/fail testing with mask autofit and mask hit ratio

### Waveform math

#### Number of math waveforms

Unlimited

#### Arithmetic

Add, subtract, multiply, and divide waveforms and scalars

#### Algebraic expressions

Define extensive algebraic expressions including waveforms, scalars, user-adjustable variables, and results of parametric measurements. Performs math on math waveforms using advanced equations. For example  $(\text{Integral}(\text{CH1} - \text{LOG}(\text{CH1})) \times \text{SQRT}(2) \times \text{VAR1})$

#### Math functions

Invert, Integrate, Differentiate, Square Root, Exponential, Log 10, Log e, Absolute value, Ceiling, Floor, Minimum, Maximum, Degrees, Radians, Sin, Cos, Tan,  $\text{Sin}^{-1}$ ,  $\text{Cos}^{-1}$ , and  $\text{Tan}^{-1}$

#### Relational

Boolean result of comparison  $>$ ,  $<$ ,  $\geq$ ,  $\leq$ ,  $=$ , and  $\neq$

#### Logic

AND, OR, NAND, NOR, XOR, and EQV

#### User definable filters (standard)

Loading of user definable filters. Users specify a file containing the coefficients of the filter.

#### User definable filters (optional)

##### Filter types

Low pass, High pass, Band pass, Band stop, All pass, Hilbert, Differentiator, Raised-Cosine, Root-Raised-Cosine

##### Filter response types

Butterworth, Chebyshev I, Chebyshev II, Elliptical, Gaussian, Bessel-Thomson, and Custom

##### FFT functions

Spectral Magnitude and Phase, and Real and Imaginary Spectra

##### FFT vertical units

Magnitude: Linear (RMS voltage) and Log (dBm)

Phase: Degrees, Radians, and Group Delay

##### FFT window functions

Hanning, Rectangular, Hamming, Blackman-Harris, Kaiser-Bessel, Flattop2, Gaussian, and TekExp

### Search

#### Search types

Search through long records to find all occurrences of user specified criteria including edges, pulse widths, cycles, timeouts, runt pulses, window violations, rise/fall times, and bus protocol events. Search results can be viewed in the Waveform View or in the Results table.

#### Number of searches

Unlimited

### Save

#### Save

Save files directly to the oscilloscope or USB media, to a remote network drive, or to your TekDrive collaboration workspace.

#### Waveform type

Tektronix Waveform Data (.wfm), Comma Separated Values (.csv), MATLAB (.mat)

#### Waveform gating

Cursors, Screen, Resample (save every nth sample)

#### Screen capture type

Portable Network Graphic (\*.png), 24-bit Bitmap (\*.bmp), JPEG (\*.jpg)

#### Setup type

Tektronix Setup (.set)

#### Report type

Adobe Portable Documents (.pdf)

#### Session type

Tektronix Session Setup (.tss)

### Display

#### Display type

15.6 in. (395 mm) liquid-crystal TFT color display

#### Display resolution

1920 horizontal × 1080 vertical pixels (High Definition)

#### Display modes

Overlay: traditional oscilloscope display where traces overlay each other

Stacked: display mode where each waveform is placed in its own slice and can take advantage of the full ADC range while still being visually separated from other waveforms. Groups of channels can also be overlaid within a slice to simplify visual comparison of signals.

#### Zoom

Horizontal and vertical zooming is supported in all waveform and plot views.

#### Interpolation

Sin(x)/x and Linear

### Waveform styles

Vectors, dots, variable persistence, and infinite persistence

### Graticules

Movable and fixed graticules, selectable between Grid, Time, Full, and None

### Color palettes

Normal and inverted for screen captures

Individual waveform colors are user-selectable

### Fonts

Font size is user selectable from 12 to 20 (default is 15)

### Format

YT, XY, and XYZ

### Inverted display

Windows OS only

### Local Language User Interface

English, Japanese, Simplified Chinese, Traditional Chinese, French, German, Italian, Spanish, Portuguese, Russian, Korean

### Local Language Help

English, Japanese, Simplified Chinese

### Arbitrary Function Generator (optional)

All of the specifications in this section apply to the AFG Out BNC connector on the rear panel. This output is only functional with the Arbitrary Functional Generator (AFG) option.

### Modes of operation

Off, Continuous, Burst

### Function types

Arbitrary, Sine, Square, Pulse, Ramp, DC Level, Gaussian, Lorentz, Exponential Rise, Exponential Decay, Sine(x)/x, Random Noise, Haversine, Cardiac

### Output

Waveforms available on rear-panel AFG Out output

### Amplitude range

Waveform	Amplitude range (peak-to-peak)	
	Load impedance = 50 $\Omega$	Load impedance = High Z
Sine, Square, Pulse, Ramp, Noise, Haversine, Cardiac, Arbitrary	10 mV to 2.5 V	20 mV to 5.0 V

## 7 Series DPO Digital Phosphor Oscilloscope Datasheet

Gaussian, Exponential rise, Exponential delay	10 mV to 1.25 V	20 mV to 2.5 V
Lorentz	10 mV to 1.2 V	20 mV to 2.4 V
Sin(x)/x	10 mV to 1.5 V	20 mV to 3.0 V
DC	-	-

### Frequency range

Waveform	Frequency range
Sine	0.1 Hz to 100 MHz
Square, Pulse, Arbitrary	0.1 Hz to 50 MHz
Ramp, Cardiac	0.1 Hz to 1 MHz
Sin(x)/x	0.1 Hz to 4 MHz
Gaussian, Haversine, Lorentz, Exponential rise, Exponential delay	0.1 Hz to 10 MHz
Noise, DC	-

### Frequency resolution

0.1 Hz

### Frequency accuracy

±130 ppm (frequency ≤ 10 kHz), ±50 ppm (frequency > 10 kHz)

Guaranteed for Sine and Ramp waveforms. Typical for Square and Pulse waveforms.

### Sine waveform

#### Amplitude flatness

±0.5 dB (relative to 1 kHz level) at 30 MHz

±1.0 dB (relative to 1 kHz level) at 50 MHz

±1.5 dB (relative to 1 kHz level) at 100 MHz

±1.5 dB (relative to 1 kHz level) for amplitude (peak-to-peak) <20 mV at 30 MHz

±1.5 dB (relative to 1 kHz level) for amplitude (peak-to-peak) <20 mV at 50 MHz

±2.0 dB (relative to 1 kHz level) for amplitude (peak-to-peak) <20 mV at 100 MHz

### Spurious free dynamic range

Frequency range	Amplitude range peak-to-peak	
	20 mV to < 100 mV, Offset = 0 V	100 mV to ≤ 2.5 V, Offset = 0 V
> DC to < 50 MHz	-30 dBc	-40 dBc

## 7 Series DPO Digital Phosphor Oscilloscope Datasheet

50 MHz to 100 MHz	-25 dBc	-30 dBc
-------------------	---------	---------

### Total harmonic distortion

Specified values are percent of fundamental signal amplitude.

Frequency range	Amplitude range <sub>peak-to-peak</sub>	
	0.05 V to < 0.2 V	0.2 V to ≤ 2.5 V
> DC to ≤ 25 MHz	≤2.5%	≤3%
25 MHz to < 50 MHz	≤3%	≤4%
50 MHz to 100 MHz	≤5.5%	≤4%

### Square and Pulse waveform

#### Duty cycle range

10% to 90% or 5 ns minimum pulse, whichever is larger

Minimum pulse time applies to both on and off time, so maximum duty cycle will reduce at higher frequencies to maintain 5 ns off time

#### Duty cycle resolution

0.1%

#### Minimum pulse width, typical

5 ns. This is the minimum time for either on or off duration.

#### Rise/Fall time

≤5 ns, 10% to 90%

#### Pulse width resolution

100 ps

#### Overshoot

<6 % of the signal amplitude (peak-to-peak) for signal steps greater than 100 mV

This applies to overshoot of the positive-going transition (+overshoot) and of the negative-going (-overshoot) transition

#### Asymmetry (duty cycle accuracy)

±(1% + 5 ns × frequency × 100%) at 50% duty cycle

#### Jitter

TIE<sub>RMS</sub> <60 ps

For amplitude<sub>p-p</sub> ≥ 100 mV and duty cycle, 40% to 60%. Square and Pulse waveforms, 5 GHz measurement bandwidth.

#### Ramp waveform

#### Symmetry range

0% to 100%

**Symmetry resolution**

0.1%

**Arbitrary**

**Memory depth**

1 to 128 kS

**Sample rate**

250 MS/s

**Amplitude accuracy**

$\pm [ (1.5\% \times \text{peak-to-peak amplitude setting}) + (1.5\% \times | \text{DC offset setting} |) + 1 \text{ mV} ]$  at frequency = 1 kHz

**Amplitude resolution**

**50  $\Omega$ :** 500  $\mu\text{V}$

**High Z:** 1 mV

**DC offset range**

**50  $\Omega$ :**  $\pm 1.25$

**High Z:**  $\pm 2.5 \text{ V}$

**DC offset resolution**

**50  $\Omega$ :** 500  $\mu\text{V}$

**High Z:** 1 mV

**DC offset accuracy**

**50  $\Omega$ :**  $\pm [ (1.5\% \times | \text{offset voltage setting} |) + 1 \text{ mV} ]$

Add 1.5 mV of uncertainty per 10 °C change from 25 °C ambient.

**High Z:**  $\pm [ (1.5\% \text{ of } | \text{offset voltage setting} |) + 2 \text{ mV} ]$

Add 3 mV of uncertainty per 10 °C change from 25 °C ambient.

**AFG Trigger Aux Out Frequency**

The divided output frequency is dependent on the frequency of the AFG signal:

AFG signal frequency	Aux Out AFG trigger frequency
$\leq 4.9 \text{ MHz}$	Signal frequency
$>4.9 \text{ MHz to } 14.7 \text{ MHz}$	Signal frequency / 3
$>14.7 \text{ MHz to } 24.5 \text{ MHz}$	Signal frequency / 5
$>24.5 \text{ MHz to } 34.3 \text{ MHz}$	Signal frequency / 7

>34.3 MHz to 44.1 MHz	Signal frequency / 9
>44.1 MHz to 53.9 MHz	Signal frequency / 11
>53.9 MHz to 63.7 MHz	Signal frequency / 13
>63.7 MHz to 73.5 MHz	Signal frequency / 15
>73.5 MHz to 83.3 MHz	Signal frequency / 17
>83.3 MHz to 93.1 MHz	Signal frequency / 19
>93.1 MHz to 100 MHz	Signal frequency / 21

### Trigger frequency counter (optional)

#### Resolution

11 digits

#### Accuracy

± (20 ppb + timebase accuracy)

From 10 Hz to channel bandwidth for analog channels.

From 10 Hz to 6.25 GHz for Aux In.

#### Frequency range

10 Hz to (2 × maximum channel bandwidth)

Amplitude (peak-to-peak) of the signal must be at least 8 mV or 3 div, whichever is greater.

(2 × maximum channel bandwidth) can be obtained by setting the trigger condition to either Rising or Falling.

### Processor system

#### Host processor

AMD EPYC Embedded 3351 @ 3 GHz, 64-bit, 12-core processor, 96 GB System RAM

#### GPU

NVIDIA T1000

#### Operating system

Closed Embedded OS (Linux)

Microsoft Windows 10 LTSC 2021 (initial purchase option)

#### Solid State Drive (SSD)

≥1.6 TB removable NVMe SSD

#### Additional SSD (optional)

Option 7-LNX-UP: Removeable SSD with closed Embedded OS (Linux)

Option 7-WIN-UP: Removeable SSD with Microsoft Windows 10 LTSC 2021 (64-bit) operating system

## Input and output ports (front panel)

### Analog inputs

TekConnect interface

### Auxiliary input

TekConnect interface

### DC probe calibration output

BNC connector for DC probe calibration (signal available only during probe calibration)

### Differential Fast Edge output

Two 2.92 mm connectors

**Frequency:** 1 kHz  $\pm$  20%

**Amplitude (peak-to-peak):** 1200 mV differential into a 100  $\Omega$  load

**Common mode:** -300 mV

**Skew:**  $\leq$ 0.8 ps

**Rise time:** < 40 ps (20% to 80% measurement) directly into an analog input channel

**Aberrations:** Within  $\pm$ 1% of the final step amplitude after the first 500 ns following the edge transition

For probe deskewing, it is recommended that a 50  $\Omega$  terminator be used in series with the deskew fixture to minimize high frequency aberrations

Unused differential output needs to be terminated with a 50  $\Omega$  resistive terminator cap or the used output will have significant aberrations and overshoot

### Antistatic ground

Banana jack, 1 M $\Omega$  resistor to ground

### Chassis ground

Banana jack, direct to chassis ground

### USB interface

Three Type-A USB 3.0 SuperSpeed host ports

## Input and output ports (rear panel)

### LAN SFP+ 10G network interface

SFP+ (Enhanced Small Form Factor Pluggable) port, 10G Ethernet

### LAN 1G RJ-45 network interface

8-pin, 10/100/1000BASE-T(X) Ethernet

### USB interface

Four Type-A USB 3.0 SuperSpeed host ports

## 7 Series DPO Digital Phosphor Oscilloscope Datasheet

One Type-B USB 3.0 SuperSpeed device port providing USBTMC support

### DisplayPort connector

20-pin DisplayPort connector maximum supported resolution:

**Windows:** 2560 x 1440 @ 60 Hz

**Linux:** 1920 x 1080 @ 60 Hz

### HDMI connector

29-pin HDMI connector, maximum supported resolution:

**Windows:** 1920 x 1200 @ 60 Hz

**Linux:** 1920 x 1080 @ 60 Hz

### Simultaneous displays

Up to 3 displays (including the internal display) with a maximum of 1 display per port.

### Sample clock out

**Connector:** SMA

**Termination:** 50  $\Omega$

**Frequency:** 7.8125 GHz  $\pm$  7.9 MHz

Amplitude<sub>p-p</sub>: 1.3 V (6 dBm)

### Sample clock in

**Connector:** SMA

**Termination:** 50  $\Omega$

**Frequency:** 7.8125 GHz  $\pm$  7.9 MHz

Amplitude<sub>p-p</sub>: 632 mV to 2 V (0 dBm to +10 dBm)

### Sync out and Sync in

Reserved for future use.

### External reference input

External oscilloscope reference clock input.

**Connector:** BNC

**Termination:** 50  $\Omega$

**High accuracy reference clock:** 10 MHz  $\pm$  0.00015 MHz ( $\pm$ 15 ppm)

**Low accuracy reference clock:** 10 MHz  $\pm$  0.01 MHz ( $\pm$ 1000 ppm)

### External reference output

Internal oscilloscope reference clock output.

**Connector:** BNC

**Termination:** 50  $\Omega$

**Frequency:** 10 MHz

Amplitude<sub>p-p</sub>:  $\geq 1.0$  V (+4 dBm)

### Auxiliary output

Acquisition Trigger Out and AFG Trigger Out.

**Connector:** BNC

**Voltage thresholds** are listed in the following table:

Characteristic	Limits
V <sub>out</sub> (HI)	$\geq 2.5$ V open circuit; $\geq 1.0$ V into a 50 $\Omega$ load to ground
V <sub>out</sub> (LO)	$\leq 0.7$ V into a load of $\leq 4$ mA; $\leq 0.25$ V into a 50 $\Omega$ load to ground

### AFG output

**Connector:** BNC

Amplitude range<sub>p-p</sub>:  $\pm 5$  V

### AFG+ and AFG- outputs

AFG+ and AFG- outputs are AC coupled differential. The single ended amplitudes are approximately 13 dB down from AFG amplitude setting.

Maximum amplitude<sub>p-p</sub>:  $\geq 300$  mV (each single ended output)

**AFG settings:** Waveform type = sine, Frequency = 100 MHz, Amplitude = 2.5 V, Load impedance = 50  $\Omega$

### Kensington-style security slot

Security slot connects to standard Kensington-style lock.

### Power source

#### Power consumption

1600 W maximum

#### Source voltage

100 V to 240 V at 50 Hz to 60 Hz

#### Power input

IEC C20 inlet

Compatible with IEC C19 Connector, 20 Amp power cords

## Physical characteristics

### Dimensions

#### Instrument

**Height:** 327 mm (12.9 in)

**Width:** 560 mm (22.1 in) handle to handle; 454 mm (17.9 in) without handles

**Depth:** 620 mm (24.4 in) from back of rear protector to TCA292D

#### Palletized shipping box

**Height:** 712 mm (28.0 in)

**Width:** 851 mm (33.5 in)

**Depth:** 794 mm (31.3 in)

#### HC7 transit case

**Height:** 610 mm (24 in)

**Width:** 762 mm (30 in)

**Depth:** 965 mm (38 in)

### Weights

#### Instrument only

38.0 kg (83.7 lbs)

#### Instrument and palletized shipping box

58.5 kg (129 lbs)

#### HC7 only

28.7 kg (63.3 lbs)

#### Instrument and HC7

66.7 kg (147 lbs)

### Clearance requirements

51 mm (2.0 in) of clearance on the left and right side from the handles

102 mm (4.0 in) of clearance on the rear of the instrument

0 mm (0.0 in) of clearance on bottom with feet installed

20 mm (0.8 in) of clearance on the bottom with feet removed

### Rackmount configuration

8U (7U instrument plus 1U with optional RM7 rackmount kit)

## Environmental

### Temperature

**Operating:** +5 °C to +40 °C (+41 °F to +104 °F)

**Non-operating:** -20 °C to +60 °C (-4 °F to +140 °F)

### Humidity

**Operating:** 5% to 90% relative humidity at temperatures up to +40°C

**Non-operating:** 5% to 90% relative humidity at temperatures up to +60°C, non-condensing, and as limited by a maximum wet-bulb temperature of +39°C

### Altitude

**Operating:** Up to 3000 meters (9800 feet)

**Non-operating:** Up to 12,000 meters (39,300 feet)

## Compliance, environmental, and safety

### Product related safety and compliance

For complete safety, environmental, and compliance statements for this product, see the Safety Information section in the 7 Series DPO Performance Oscilloscope DPO714AX Help manual, available online at <https://tek.com/docs/7-series>.

## Software

### IVI driver

Provides a standard instrument programming interface for common applications such as LabVIEW, LabWindows/CVI, Microsoft .NET, and MATLAB. Compatible with Python, C/C++/C# and many other languages through VISA.

### e\*Scope®

Enables control of the oscilloscope over a network connection through a standard web browser. Simply enter the IP address or network name of the oscilloscope and a web page will be served to the browser. Transfer and save settings, waveforms, measurements, and screen images or make live control changes to settings on the oscilloscope directly from the web browser. Optionally configure e\*Scope authentication to password protect access to control and view the oscilloscope. Embedded OS (Linux) only.

### TekHSI™

A high-speed interface (HSI) framework, based on the gRPC framework, that allows data movement from the oscilloscope to the PC at speeds up to 20x faster when compared to current VXI-11 ethernet (VISA) connections. TekHSI™ technology is especially useful when acquiring large quantities of large waveform sizes, like pulse trains or other repetitive signal types. When enabled, the oscilloscope hosts itself as a high-speed interface server allowing remote clients (PCs) to connect via TekScope PC software or programmatically.

### TekDrive

Upload, store, organize, search, download, and share any file type from any connected device. TekDrive is natively integrated into the instrument for seamless sharing and recalling of files - no USB stick is required. Analyze and explore standard files like .wfm, .isf, .tss, and .csv, directly in a browser. Visit <http://www.tek.com/software/tekdrive> to learn more.

### SignalVu-PC

Advanced vector signal analysis software that can run directly on your 7 Series DPO or on a separate Windows PC. Requires Connect license (CON7xx-SVPC) installed on SignalVu-PC. xx represents NL for Node Locked license or FL for Floating License.

### LXI

**Embedded OS (Linux) SSD:** Class: LXI Core 2011,Version: 1.5

**Windows OS SSD:** Class: LXI Core 2022,Version: 1.6

### LXI Web interface

Connect to the oscilloscope through a standard Web browser by simply entering the oscilloscope's IP address or network name in the address bar of the browser. The Web interface enables viewing of instrument status and configuration, status and modification of network settings, and instrument control through the e\*Scope web-based remote control.

### Programming Examples

Programming with the 7 Series platform has never been easier. With a programmers manual and a GitHub site you have many commands and examples to help you get started remotely automating your instrument. See <https://github.com/tektronix/programmatic-control-examples>.

## Ordering information

Use the following steps to select the appropriate instrument and options for your measurement needs.

### Step 1

Start by selecting a model.

Model	TekConnect inputs
DPO714AX	4

Each model includes:

Accessory	Tektronix part number
Five (5) TCA292D TekConnect to 2.92 mm Adapters	TCA292D
Five (5) backing wrench card tools for coax cables	003-1972-xx
50 $\Omega$ terminator with chain (2x) on Fast Edge (front)	131-9650-xx
50 $\Omega$ terminator with chain (2x) on Sample Clock (rear)	131-9650-xx
50 $\Omega$ terminator with chain (2x) on Sync In/Out (rear)	131-9650-xx
Static protection wrist strap, adjustable, 6 ft coiled cord	006-3415-xx
Safety & Compliance Information, multi-language	071-3807-xx
Removable SSD with embedded OS (7-LNX)	-
AOMEI OneKey Recovery Professional License	-
Embedded Help (this operating manual also available as a downloadable PDF on tek.com)	077-1859-xx
Front cover	200-5406-xx
Power cord	Depends on power option selected
Calibration certificate documenting traceability to National Metrology Institute(s) and ISO9001/ISO17025 quality system registration	-
One-year warranty covering all parts and labor on the instrument and included accessories.	-

## Step 2

### Configure your oscilloscope by selecting the analog channel bandwidth you need

Choose the bandwidth you need today by choosing one of these bandwidth options. You can upgrade it later by purchasing a bandwidth option with greater bandwidth.

Bandwidth option	Bandwidth
7-BW-8000	8 GHz
7-BW-10000	10 GHz
7-BW-13000	13 GHz
7-BW-16000	16 GHz
7-BW-20000	20 GHz
7-BW-25000	25 GHz

### Step 3

#### Add instrument functionality

This can be ordered as an option with the instrument (factory installed) or separately (field upgrade), unless otherwise noted.

#### Example

Factory-installed on an instrument that is on same order (only node-locked can be factory installed), order:	DPO714AX 7- AFG
Not factory-installed on the instrument that is on the same order (both node-locked and floating available), order:	7-AFG
For later installation on an existing instrument (field upgrade) (both node-locked and floating available), order:	7-AFG-FL

Each option in the table below is permanently licensed and available in either node-locked or floating, unless otherwise noted:

Instrument option	Built-in instrument functionality	Node-locked (no suffix)	Floating (-FL suffix)
7-RL-1	Extend record length from 500 Mpts/channel to 1 Gpts/channel	✓	✓
7-RL-2	Extend record length from 500 Mpts/channel to 2 Gpts/channel	✓	✓
7-RL-1T2	Extend record length from 1 Gpts/ch to 2 Gpts/ch	✓	✓
7-AFG	Add Arbitrary Function Generator	✓	✓
7-WIN	Add optional removable SSD with Microsoft Windows 10 operating system license (initial purchase)		
7-LNX-UP	Add additional removable SSD with embedded OS (one included standard with instrument) (field upgrade)		
7-WIN-UP	Add optional removable SSD with Microsoft Windows 10 operating system license (field upgrade)		

## Step 4

### Add optional measurement analysis capabilities

This can be ordered as an option with the instrument (factory installed) or separately (field upgrade), unless otherwise noted.

#### Example

Factory-installed on an instrument that is on same order (only node-locked can be factory installed), order:	DPO714AX 7- DJA
Not factory-installed on the instrument that is on the same order (both node-locked and floating available), order:	7-DJA
For later installation on an existing instrument (field upgrade) (both node-locked and floating available), order:	7-DJA-FL

Each option in the table below is permanently licensed and available in either node-locked or floating, unless otherwise noted:

Instrument option	Optional measurement analysis capabilities	Node-locked (no suffix)	Floating (-FL suffix)
7-DJA	Advanced jitter and eye analysis	✓	✓
7-SIM	Signal Integrity Modeling; Base License; includes de-embedding, embedding, and core analysis tools	✓	✓
7-SIMA	Signal Integrity Modeling; Advanced License; includes de-embedding, embedding, Tx/Rx equalization modeling (pre-emphasis, de-emphasis, CTLE, FFE, DFE), and clock data recovery (CDR)	✓	✓
7-SIM-UP	Signal Integrity Modeling; Upgrade License from SIM to SIMA to Enable Equalization and CDR; requires existing SIM license	✓	✓
7-MTM	Mask and limit testing	✓	✓
7-UDFLT	User defined filter creation tool	✓	✓
7-TDR	Time Domain Reflectometry (TDR) Analysis	✓	✓

### Add RF vector signal analysis

SignalVu-PC is a stand-alone application that can be run on a 7 Series oscilloscope or on a separate Windows PC to provide advanced RF vector signal analysis. In order to run SignalVu-PC on your 7 Series, the following options are required.

1. To run the application on the instrument, the Windows SSD (option 7-WIN) needs to be installed in the 7 Series oscilloscope.
2. To run the application on the instrument or on a separate PC, the Connect (CON7NL-SVPC or CON7FL-SVPC) license needs to be installed in SignalVu-PC to enable base features of the application, which includes 16+ RF measurements and displays.

## Step 5

### Add compliance automation test software

#### Clarius compliance

These are not options to the instrument (not factory installed); only available as a standalone product to install on either an existing instrument or a networked Windows 10 or Windows 11 PC, unless otherwise noted. If installed on an existing instrument, these standalone products require a 7-WIN (SSD with Microsoft Windows 10 operating system) installed in the instrument.

Standalone product	Clarius compliance automation test software
AT-DP14-TX	DisplayPort 1.4 Tx Automation Test Software
AT-DP21-TX	DisplayPort 2.1 Tx Automation Test Software
AT-USB4-TX	USB4 and Thunderbolt Generation 3/4 Tx Automation Test Software
AT-USB42-TX	USB4v2 Tx Automation Test Software

#### TekExpress compliance

This can be ordered as an option with the instrument (factory installed) or separately (field upgrade), unless otherwise noted.

#### Example

Factory-installed on an instrument that is on same order (only node-locked can be factory installed), order:	DPO714AX 7-CMPCIE1234
Not factory-installed on the instrument that is on the same order (both node-locked and floating available), order:	7-CMPCIE1234
For later installation on an existing instrument (field upgrade) (both node-locked and floating available), order:	7-CMPCIE1234-FL

Each option in the table below is permanently licensed and available in either node-locked or floating, unless otherwise noted:

Instrument option	Optional protocol triggering, decode, and search capabilities	Node-locked (no suffix)	Floating (-FL suffix)
7-CMCPHY20	MIPI C-PHY 1.0 C-PHY 1.1 C-PHY 2.0 Transmitter Test(Tx) Automated Compliance Solution using TekExpress Framework; Requires options 7-DJA and 7-WIN	✓	✓
7-CMDDR5SYS	DDR5 System Transmitter Test (Tx) Automated Compliance Solution using TekExpress Framework; Requires options 7-DJA and 7-WIN	✓	✓
7-CMDPHY21	MIPI D-PHY 1.2 and D-PHY 2.1 Transmitter Test (Tx) Automated Compliance Solution using TekExpress Framework; Requires options 7-DJA and 7-WIN	✓	✓
7-CMLPDDR5SYS	LPDDR5 and 5x System Transmitter Test (Tx) Automated Compliance Solution using TekExpress Framework; Requires options 7-DJA and 7-WIN	✓	✓

## 7 Series DPO Digital Phosphor Oscilloscope Datasheet

Instrument option	Optional protocol triggering, decode, and search capabilities	Node-locked (no suffix)	Floating (-FL suffix)
7-CMPCIE1234	PCIe Gen1 Gen2 Gen3 Gen4 Tx Automated Compliance Solution using TekExpress Framework; Requires option 7-WIN	✓	✓
7-CMUSB3	USB 3.2 Thunderbolt 3 and 4 Transmitter Test (Tx) Automated Compliance Solution using TekExpress Framework; Requires option 7-WIN	✓	✓
7-CMUSB4V1	USB4V1 Tx Automated Compliance Solution using TekExpress Framework; Requires option 7-WIN	✓	✓
7-SWX-PCIE	Switch Matrix support for PCIe Tx; requires option 7-CMPCIE1234	✓	✓

## Step 6

### Add optional protocol triggering, decode, and search capabilities

Can be ordered as an option with the instrument (factory installed) or separately (field upgrade), unless otherwise noted.

#### Example

Factory-installed on an instrument that is on same order (only node-locked can be factory installed), order:	DPO714AX 7-SRPCIE4
Not factory-installed on the instrument that is on the same order (both node-locked and floating available), order:	7- SRPCIE4
For later installation on an existing instrument (field upgrade) (both node-locked and floating available), order:	7- SRPCIE4-FL

Each option in the table below is permanently licensed and available in either node-locked or floating, unless otherwise noted:

Instrument option	Optional protocol triggering, decode, and search capabilities	Node-locked (no suffix)	Floating (-FL suffix)
7-SRNRZ	NRZ protocol decode and search	✓	✓
7-SR128B132B	128b132b protocol decode and search	✓	✓
7-SR64B66B	64b66b protocol decode and search	✓	✓
7-SR8B10B	8b10b protocol decode and search	✓	✓
7-SRAERO	Aerospace protocol hardware triggering and analysis (MIL-STD-1553, ARINC429)	✓	✓
7-SRAUDIO	Audio protocol hardware triggering and analysis (I2S, LJ, RJ, TDM)	✓	✓
7-SRAUTO	Automotive protocol hardware triggering and analysis (CAN, LIN, FlexRay)	✓	✓
7-AUTOEN-SS	Automotive Ethernet Signal Separation	✓	✓
7-SRAUTOEN1	Automotive Ethernet protocol decode and search (100Base-T1)	✓	✓
7-SRAUTOSEN	Automotive sensor protocol hardware triggering and analysis (SENT)	✓	✓
7-SRCOMP	Computer protocol hardware triggering and analysis (RS-232/422/485/UART)	✓	✓
7-SRCPHY	MIPI C-PHY CSI/DSI protocol decode and search (Version 2.0/1.1/1.0)	✓	✓
7-SRCXPI	CXPI protocol decode and search	✓	✓
7-SRDPHY	DPHY CSI/DSI protocol decode and search (Version 2.0/1.2)	✓	✓

## 7 Series DPO Digital Phosphor Oscilloscope Datasheet

Instrument option	Optional protocol triggering, decode, and search capabilities	Node-locked (no suffix)	Floating (-FL suffix)
7-SREMBD	Embedded protocol hardware triggering and analysis (I2C, SPI)	✓	✓
7-SRENET	Ethernet protocol hardware triggering and analysis (10BASE-T, 100BASE-TX)	✓	✓
7-SRESPI	eSPI protocol decode and search	✓	✓
7-SRETHERCAT	Ethercat protocol decode and search	✓	✓
7-SREUSB2	eUSB2 protocol decode and search	✓	✓
7-SRI3C	I3C protocol decode and search (I3C)	✓	✓
7-SRMANCH	Manchester protocol decode and search	✓	✓
7-SRMDIO	MDIO protocol decode and search, No Hardware Trigger	✓	✓
7-SRONEWIRE	One Wire (1-Wire) protocol decode and search	✓	✓
7-SRPCIE321	PCIe Gen1 Gen2 Gen3 protocol decode and search and trigger	✓	✓
7-SRPCIE4	PCIe Gen 4 protocol decode and search and trigger	✓	✓
7-SRPM	Power management protocol hardware triggering and analysis (SPMI)	✓	✓
7-SRPSI5	PSI5 protocol decode and search, No Hardware Trigger	✓	✓
7-SRSDLC	Synchronous Data Link Control protocol decode and search	✓	✓
7-SRSMBUS	SMBUS protocol decode and search	✓	✓
7-SRSPACEWIRE	SPACEWIRE protocol decode and search	✓	✓
7-SRSVID	SVID protocol decode and search	✓	✓
7-SRUSB2	USB2 protocol hardware triggering and analysis (USB 2.0 LS, FS, HS)	✓	✓
7-SRUSB3	USB3.2 protocol hardware triggering and analysis (USB 3.0, 3.1 Gen 1, 2, 3.2 Gen 1,2 )	✓	✓

### Add third party serial bus decode and analysis capabilities

Third-party applications are available that provide serial bus decode and analysis capabilities for use on the 7 Series. Use of the third-party applications require a Windows 10 SSD (option 7-WIN).

## 7 Series DPO Digital Phosphor Oscilloscope Datasheet

Serial bus	Third party contact information
Embedded Multi-media Controller (eMMC) memory	 <p data-bbox="683 405 902 432">Prodigy Technovations</p> <p data-bbox="683 445 987 472"><a href="https://www.prodigytechno.com/">https://www.prodigytechno.com/</a></p>
Quad Serial Peripheral Interface (QSPI) - 2 enhanced IO lines for SPI	
Secure Digital Input Output (SDIO)	

**Step 7****Add analog probes, adapters, and coax cables**

Add additional recommended probes and adapters:

Recommended probe / adapter	Interface	Description
P7720	TekConnect	20 GHz TriMode differential probe
P7716	TekConnect	16 GHz TriMode differential probe
P7713	TekConnect	13 GHz TriMode differential probe
P7708	TekConnect	8 GHz TriMode differential probe
P7633	TekConnect	33 GHz TriMode differential probe
P7630	TekConnect	30 GHz TriMode differential probe
P7625	TekConnect	25 GHz TriMode differential probe
TCA292D	TekConnect	TekConnect to 2.92 mm 50 Ω, 33 GHz adapter

Looking for other probes? Check out the probe selector tool at <https://www.tek.com/en/tools/probe-selector>

Add additional recommended coax cables:

Recommended coax cable	Description
PMCABLE1M	2.92-to-2.92 mm cable pair, straight, 1.5 ps phase-matched, 1 m, 40 GHz
174-6658-01	SMP-to-SMP cable pair, right-angle, 2.5 ps phase-matched, 300 mm, 20 GHz
174-6659-01	SMP-to-SMP cable pair, right-angle, 2.5 ps phase-matched, 1000 mm, 20 GHz
174-6663-01	2.92-to-2.92 mm cable pair, straight, 1.5 ps phase-matched, 500 mm, 40 GHz
174-6664-01	SMA-to-SMA cable pair, straight, 1.5 ps phase-matched, 200 mm, 20 GHz
174-6665-01	SMA-to-SMA, single cable, right-angle, 300 mm, 20 GHz
174-6666-01	SMA-to-SMA, single cable, right-angle, 500 mm, 20 GHz
174-6667-01	SMA-to-SMA, single cable, right-angle, 1.829 m, 20 GHz
174-6978-00	2.92-to-2.92 mm cable pair, straight, 1.5 ps phase-matched, 2 m, 40 GHz

For custom coax cable cables:



<https://www.swiftbridgetechnologies.com/>

## Step 8

### Add accessories

Optional accessory	Description
HC7	Hard carrying case for 7 Series
RM7	Rackmount kit for 7 Series
GPIB to Ethernet adapter	Order model 4865B (GPIB to Ethernet to Instrument Interface) directly from ICS Electronics <a href="https://www.icselect.com/gpib_instrument_intfc.html">https://www.icselect.com/gpib_instrument_intfc.html</a>

## Step 9

Select power cord option.

Optional accessories	Description
A0	North America power plug (115 V, 60 Hz)
A1	Universal Euro power plug (220 V, 50 Hz)
A2	United Kingdom power plug (240 V, 50 Hz)
A3	Australia power plug (240 V, 50 Hz)
A4	North America power plug (240 V, 60 Hz)
A5	Switzerland power plug (220 V, 50 Hz)
A6	Japan power plug (100 V, 50/60 Hz)
A10	China power plug (50 Hz)
A11	India power plug (50 Hz)
A12	Brazil power plug (60 Hz)
A99	No power cord

## Step 10

Protect your investment and your uptime with a service package for your instrument.

Optimize the lifetime value of your purchase and lower your total cost of ownership with a calibration and extended warranty plan for your instrument. Plans range from standard warranty extensions covering parts, labor, and 2-day shipping to Total Product Protection with repair or replacement coverage from wear and tear, accidental damage, ESD or EOS. See the below table for specific service options available on the 7 Series family of products. Compare factory service plans <https://www.tek.com/en/services/factory-service-plans>.

Additionally, Tektronix is a leading accredited calibration services provider for all brands of electronic test and measurement equipment, servicing more than 140,000 models from 9,000 manufacturers. With 100+ labs worldwide, Tektronix serves as a global partner, delivering tailored whole-site calibration programs with OEM quality at a market price. View whole site calibration service capabilities <https://www.tek.com/en/services/calibration-services>.

### Add extended service and calibration options

Service options	Description
R4	Standard Warranty Extended to 4 Years. Covers parts, labor and 2-day return shipping within country. All repairs include calibration and firmware updates.
R6	Standard Warranty Extended to 6 Years. Covers parts, labor and 2-day return shipping within country. All repairs include calibration and firmware updates.
T4PLUS	Four (4) Year Total Protection Plan, includes all features of Extended Warranty Plan plus complete coverage against accidental damage (including electrostatic discharge and overstress), 4 calibration events, 5-day calibration and 10-day-repair turnarounds, and Tektronix-engineered HC7 transit case.
T6PLUS	Six (6) Year Total Protection Plan, includes all features of Extended Warranty Plan plus complete coverage against accidental damage (including electrostatic discharge and overstress), 6 calibration events, 5-day calibration and 10-day-repair turnarounds, and Tektronix-engineered HC7 transit case.
CD1	Calibration with full data report service 1 year. Includes traceable calibration where applicable with full data report, for recommended calibrations. Coverage includes 1 calibration events over 1 year.
CD3	Calibration with full data report service 3 years. Includes traceable calibration where applicable with full data report, for recommended calibrations. Coverage includes 3 calibration events over 3 years.
CD5	Calibration with full data report service 5 years. Includes traceable calibration where applicable with full data report, for recommended calibrations. Coverage includes five calibration events over five years.
D1	Calibration data report.

## Bandwidth upgrades after purchase

### Add bandwidth upgrades in the future

The analog bandwidth of 7 Series instruments can be upgraded after initial purchase. Bandwidth upgrades are purchased based on the current bandwidth and the desired bandwidth. All bandwidth upgrades can be performed in the field by installing a software license and a new front panel label.

Oscilloscope model owned	Bandwidth upgrade product	Upgrade option	Upgrade option description
DPO714AX	7-BWAX4	7-BW80T100-AX4	Upgrade from 8 GHz to 10 GHz bandwidth on a (4) Channel AX model
		7-BW80T130-AX4	Upgrade from 8 GHz to 13 GHz bandwidth on a (4) Channel AX model
		7-BW80T160-AX4	Upgrade from 8 GHz to 16 GHz bandwidth on a (4) Channel AX model
		7-BW80T200-AX4	Upgrade from 8 GHz to 20 GHz bandwidth on a (4) Channel AX model
		7-BW80T250-AX4	Upgrade from 8 GHz to 25 GHz bandwidth on a (4) Channel AX model
		7-BW100T130-AX4	Upgrade from 10 GHz to 13 GHz bandwidth on a (4) Channel AX model
		7-BW100T160-AX4	Upgrade from 10 GHz to 16 GHz bandwidth on a (4) Channel AX model
		7-BW100T200-AX4	Upgrade from 10 GHz to 20 GHz bandwidth on a (4) Channel AX model
		7-BW100T250-AX4	Upgrade from 10 GHz to 25 GHz bandwidth on a (4) Channel AX model
		7-BW130T160-AX4	Upgrade from 13 GHz to 16 GHz bandwidth on a (4) Channel AX model
		7-BW130T200-AX4	Upgrade from 13 GHz to 20 GHz bandwidth on a (4) Channel AX model
		7-BW130T250-AX4	Upgrade from 13 GHz to 25 GHz bandwidth on a (4) Channel AX model
		7-BW160T200-AX4	Upgrade from 16 GHz to 20 GHz bandwidth on a (4) Channel AX model
		7-BW160T250-AX4	Upgrade from 16 GHz to 25 GHz bandwidth on a (4) Channel AX model
7-BW200T250-AX4	Upgrade from 20 GHz to 25 GHz bandwidth on a (4) Channel AX model		

## 7 Series Investment Protection Program (IPP)

As signals get faster and new standards are developed, your investment in a 7 Series oscilloscope can evolve with your needs. You can upgrade the bandwidth of the oscilloscope you own today. You can take advantage of 7 Series performance improvements by upgrading your existing MSO/DPO70000DX or DPO70000SX oscilloscope to a new 7 Series oscilloscope. Contact your local Tektronix representative to discuss the full range of options available with the 7 Series Investment Protection Program (IPP) to ensure you have the best tools you need for your next project.

## Certifications

Tektronix is registered to ISO 9001:2015 and ISO 14001:2015.

## Contact Information:

**Australia** 1 800 709 465  
**Austria\*** 00800 2255 4835  
**Balkans, Israel, South Africa and other ISE Countries** +41 52 675 3777  
**Belgium\*** 00800 2255 4835  
**Brazil** +55 (11) 3530-8901  
**Canada** 1 800 833 9200  
**Central East Europe / Baltics** +41 52 675 3777  
**Central Europe / Greece** +41 52 675 3777  
**Denmark** +45 80 88 1401  
**Finland** +41 52 675 3777  
**France\*** 00800 2255 4835  
**Germany\*** 00800 2255 4835  
**Hong Kong** 400 820 5835  
**India** 000 800 650 1835  
**Indonesia** 007 803 601 5249  
**Italy** 00800 2255 4835  
**Japan** 81(3) 6714 3086  
**Luxembourg** +41 52 675 3777  
**Malaysia** 1 800 22 55835  
**Mexico, Central/South America and Caribbean** 52 (55) 88 69 35 25  
**Middle East, Asia, and North Africa** +41 52 675 3777  
**The Netherlands\*** 00800 2255 4835  
**New Zealand** 0800 800 238  
**Norway** 800 16098  
**People's Republic of China** 400 820 5835  
**Philippines** 1 800 1601 0077  
**Poland** +41 52 675 3777  
**Portugal** 80 08 12370  
**Republic of Korea** +82 2 565 1455  
**Russia / CIS** +7 (495) 6647564  
**Singapore** 800 6011 473  
**South Africa** +41 52 675 3777  
**Spain\*** 00800 2255 4835  
**Sweden\*** 00800 2255 4835  
**Switzerland\*** 00800 2255 4835  
**Taiwan** 886 (2) 2656 6688  
**Thailand** 1 800 011 931  
**United Kingdom / Ireland\*** 00800 2255 4835  
**USA** 1 800 833 9200  
**Vietnam** 12060128  
**\* European toll-free number. If not accessible, call:** +41 52 675 3777

Find more valuable resources at [TEK.COM](https://www.tek.com)

**Tektronix**<sup>®</sup>

Copyright © Tektronix. All rights reserved. Tektronix products are covered by U.S. and foreign patents, issued and pending. Information in this publication supersedes that in all previously published material. Specification and price change privileges reserved. TEKTRONIX and TEK are registered trademarks of Tektronix, Inc. All other trade names referenced are the service marks, trademarks or registered trademarks of their respective companies.

55W-74139-2 2 April 2026