

Agilent 86100C Infiniium DCA-J

The *fastest* way to the *right* answer



The multi-functional analysis tool



Time domain reflectometer

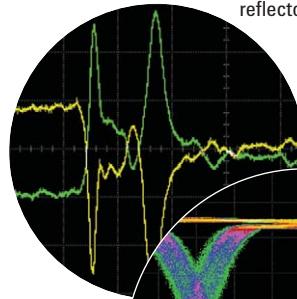

Digital communications analyzer

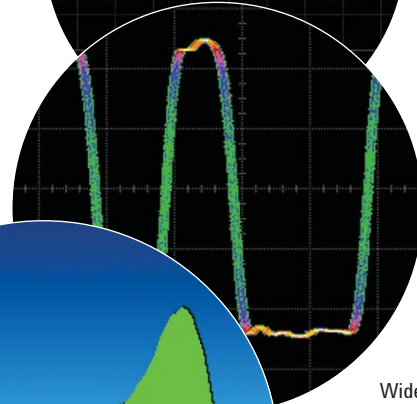
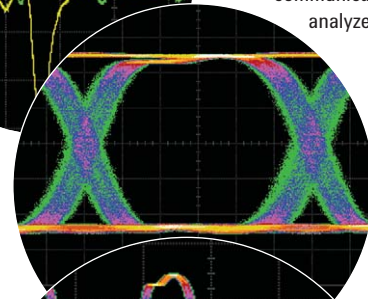

Wide band oscilloscope



One button – many insights

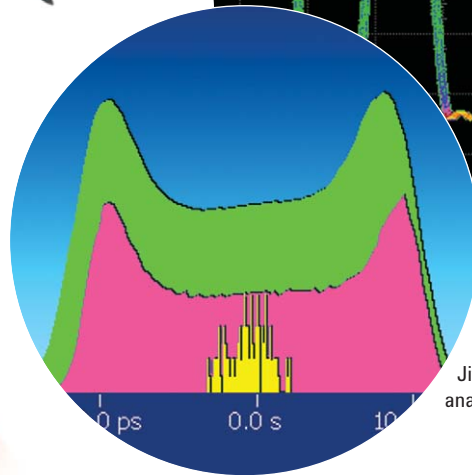

Jitter analyzer



Agilent Technologies

New Enhancements

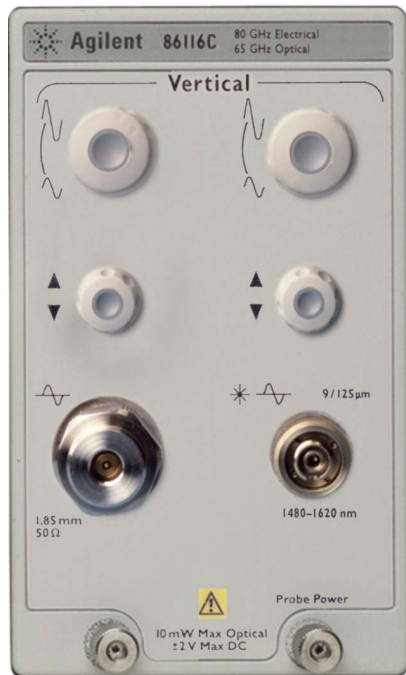

Reference receiver for 39-43 Gb/s systems

In 2002 Agilent was the first to provide an oscilloscope with the low intrinsic jitter necessary to accurately view 40 Gb/s signals. The 86100 in conjunction with the 86107A Precision Timebase became the de facto standard for 40 Gb/s R&D. As such systems are now beginning to make their way from the lab to production; the new 86116C performs as a reference receiver that allows designers, manufacturers and their customers to reliably verify component and system specifications.

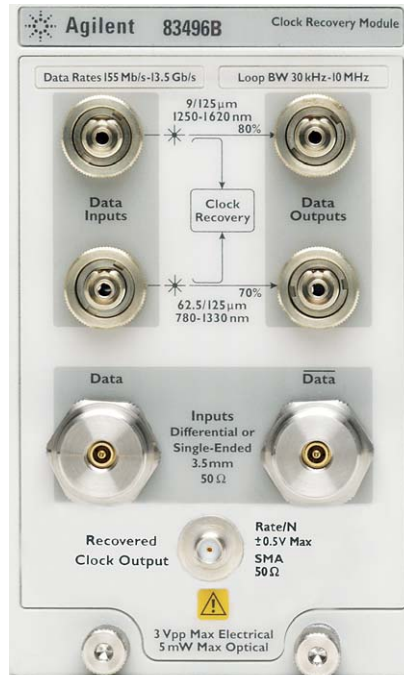

Variable loop bandwidth clock recovery suited for spread-spectrum clocking

The 83496B multi-rate optical/electrical clock recovery module performs clock extraction for waveform analysis with continuous, unbanded tuning from 50 Mb/s to 13.5 Gb/s, ultra-low residual jitter and Golden PLL (phase locked loop) operation. It tolerates large periodic jitter from Spread Spectrum Clocking (SSC), and can tune its loop bandwidth between 15 kHz and 10 MHz. Internally the recovered clock signal is a substrate (1:8) and routed to the mainframe. The front panel provides the recovered clock at a user-selectable rate (1:1¹, 1:2, 1:4, 1:8, 1:16).

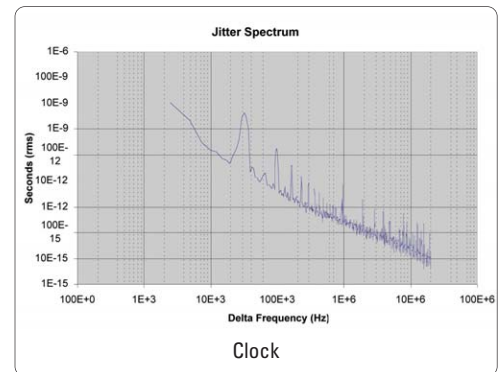
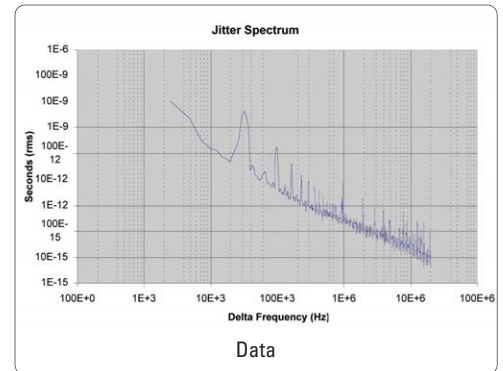

Solving jitter problems through phase/frequency domain analysis

The 83496B can be used as a phase noise analysis system. Phase noise based measurements can be achieved on both clock and data signals at rates from 25 MHz to 6.75 GHz and 50 Mb/s to 13.5 Gb/s respectively. The examples above show frequency resolved jitter for the clock and data lines of a PCI-Express system, indicating how the jitter from the reference clock is translated to the data line. With high dynamic range, low level random jitter spectra can be observed at the same time as large spread spectrum clocking jitter and harmonics. The ability to observe specific jitter tones as well as the broad noise spectra provides important insights into the root causes of jitter. The measurement range is from 300 Hz to 20 MHz. Since jitter is obtained in an analog technique, results are obtained in a matter of seconds. Virtual PLL responses can be built in to emulate system level performance.

¹ The 1:1 choice works up to 7.1Gb/s, all other up to 13.5 Gb/s.

Get Deep Insights To Address Root Causes

Amplitude analysis

The 86100C Infiniium DCA-J can now decompose amplitude interference (Option 300) and timing jitter (Option 200) so that designers can accurately see interference and jitter contributions, and get a full picture to get to the root cause.

Signal/modulation impairments

Large separation between 'one' and 'zero' levels is essential for error-free communications. This type of signal strength is commonly determined with standard 86100C automatic measurements like "eye-amplitude" or OMA (optical modulation amplitude). Option 300 provides an advanced technique for determining signal amplitude. The user can isolate specific bit sequences to compose a signal amplitude measurement. The impact of various data patterns can be examined. Standards based OMA test, usually requiring a square wave pattern, can now be derived from virtually any data pattern. Option 300 also separates out the various mechanisms that cause eye amplitude closure similar to timing closure (jitter) examined using option 200.

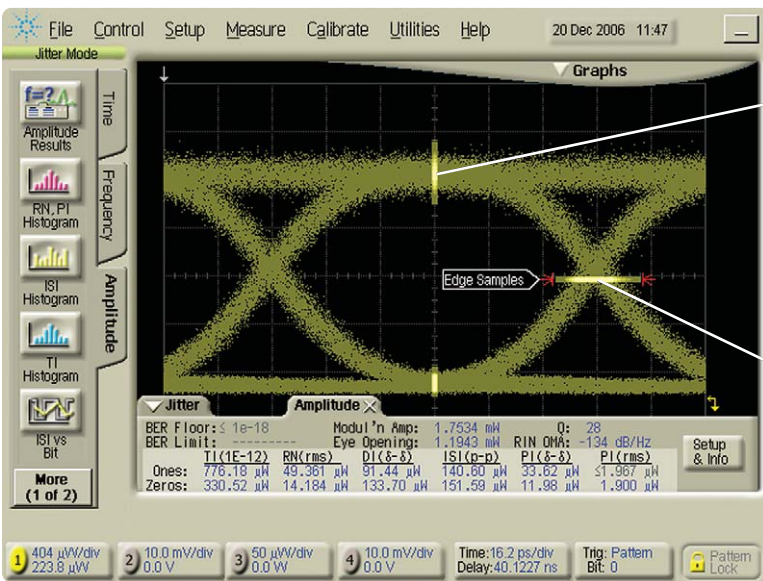
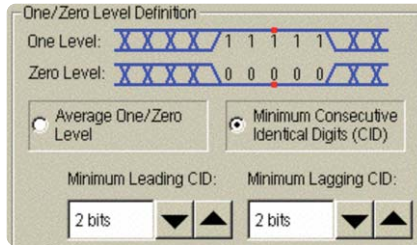

Interference decomposition tree

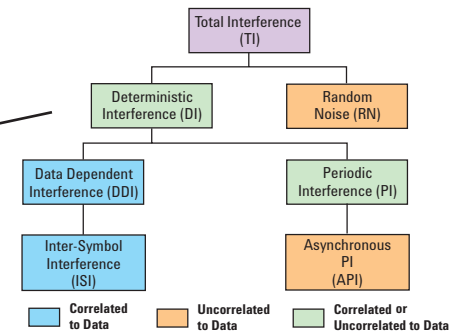

Jitter decomposition tree

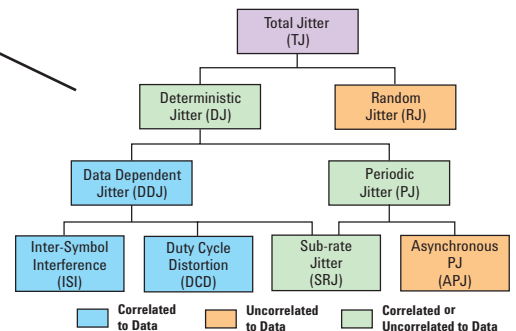

Relative intensity noise (RIN)

RIN is a random noise contribution caused by the spontaneous emission background of lasers. Excessive RIN can limit the power budget in an optical system. Option 300 measures RIN either based on the "1" power level or on OMA. Combined with automatic normalization to 1 Hz, the DCA-J's results compare easily and directly with those recommended by standards (e.g., IEEE 802.3ae).



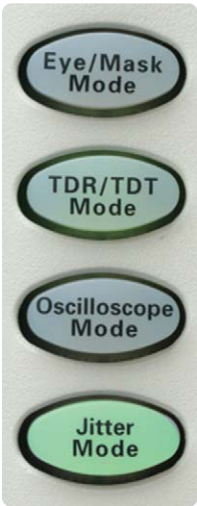

DCA-J: Expect More

The ultimate flexible tool—the 86100C digital communications analyzer with advanced jitter analysis (DCA-J). Four instruments in one – a digital communications analyzer with automated eye measurements; a full-

function time domain reflectometer (TDR) for impedance analysis; a full function oscilloscope with bandwidth in excess of 80 GHz; an innovative and accurate jitter analyzer for electrical and optical signals.

With the ability to accept plug-in modules that you already own from the 83480A/54750A and 86100A/B, the DCA-J also protects your investment.

Essential tools for the high speed digital designer...

- Wide bandwidth oscilloscope
- Signal integrity analyzer
- Communications analyzer
- Interference and jitter analyzer

...all in *one* instrument!

Advantages

- Interference and jitter measurements at any rate, even beyond 40 Gb/s
- No need for an external pattern trigger
- Stable, accurate measurements
- One button ease
- Support for all past and present DCA plug-ins

Capabilities

- **Broadest coverage** – receivers and clock recovery modules cover widest range of data rates and wavelengths
- **S-parameters** – one button push shows you reflection and transmission parameters – Option 202 and TDR
- **Pattern lock** – internally generates pattern trigger from an ordinary clock
- **Eyeline mode** – isolates specific bit sequences, creates an averaged eye diagram
- **Interference and jitter mode** – one-button RJ/DJ, RN/DI separation; accurate, stable, in-depth interference and jitter analysis
- **Jitter analysis with the 86107A precision timebase** – achieve the most accurate jitter measurements with the lowest jitter intrinsic of any enterprise jitter solution to measure ultra high performance components
- **Open operating system** – Windows® XP Pro allows external applications to be installed

“ Easy jitter analysis that scales to any bit rate I might need in the future – at an amazingly cost-effective price. That this comes with 3 other other instruments in the same package is amazing! ”

Smashing through the barriers to gigabit jitter analysis

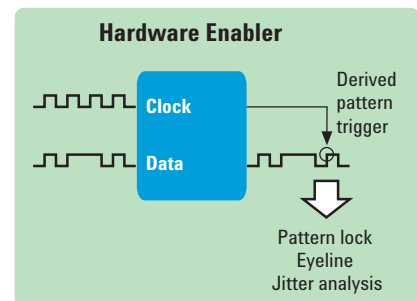



Jitter analyzer

Pages 6-7

- One button does it all
- Easy set up means you get right answers faster
- Separation of interference and jitter into subcomponents for fast debugging
- Highly repeatable measurements
- High sensitivity – ideal for testing devices with low intrinsic interference and jitter
- Negligible jitter contribution from the instrument – you're measuring your device, not your test equipment

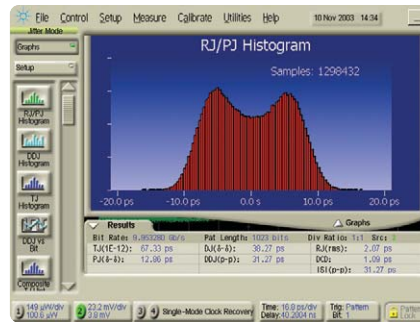

4 essential tools in 1

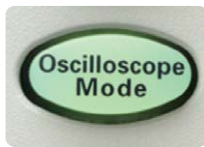

Wide bandwidth oscilloscope

Page 10

- Electrical bandwidths from 12 to over 80 GHz ensure the most accurate waveforms
- Pulse trains viewed without the need for a separate pattern or frame trigger
- Analog scope look and feel
- Trigger bandwidth to > 13 GHz (option 001) or 43 GHz (with 86107A precision time base)

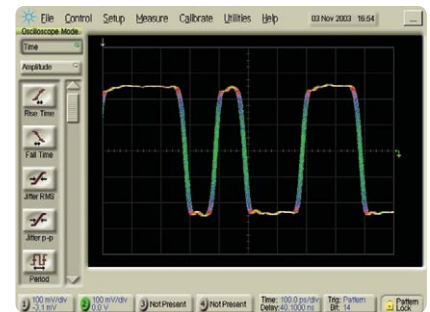

Signal integrity analyzer

Page 11

- Analysis of single-ended and mixed-mode S-parameters through embedded software
- Verify the transmission quality of components and channels with a precision time domain reflectometer
- Single ended or differential TDR for accurate impedance measurements
- Advanced calibration techniques remove cabling/fixturing/probe effects; measure just the test device



Digital communications analyzer

Pages 12-13

- Widely trusted for optical and electrical eye diagram analysis
- Easy transmitter compliance testing to international standards
- Optical bitrate coverage from 155 Mb/s to > 40 Gb/s
- Optical module bandwidth to > 65 GHz
- Fast test throughput for manufacturing
- NRZ/RZ built-in measurement ease
- Completely compatible with the 86100B
- Windows® XP Pro open environment and easy networking
- Eyeline mode allows averaging of eye diagrams, isolation of mask violation bit sequences

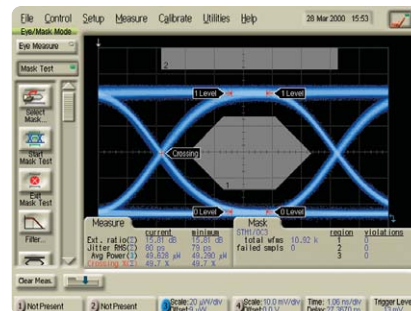



Think Interference And Jitter Measurements Are Hard To Make? *Think Again.*



The DCA-J takes interference and jitter analysis to a new level of simplicity and accuracy. Add to that the scalability to any data rate that is likely in the future, and you have the ultimate in investment protection.

As device performance and system requirements push jitter performance to ever higher levels, it is sometimes hard to distinguish between the behavior of your device and the interference and jitter of your test equipment. That will never be a problem with the DCA-J. The instrument interference and jitter in the standard main-frame is already very low. Combine that with the 86107A precision timebase, and intrinsic interference and jitter falls away to less than 250 fs. DCA-J – see what’s really going on.

“ As bit rates increase, jitter budgeting and characterization of jitter performance present an ever increasing challenge. In order to manage jitter effectively, we need tools that can decompose the jitter into the numerical and statistical forms that allow us to predict our performance effectively and provide the insight necessary to solve problems quickly. The new capability of the DCA-J provides irreplaceable visibility for the challenges of jitter characterization of our world class products. This new instrument is a major contribution to our ability to manage jitter. ”

—Anthony Sanders
Principal Engineer, Infineon Technologies

Key enablers

- Interference and jitter measurements at any rate, even beyond 40 Gb/s
- Interference and jitter separation into subcomponents
- No need for a pattern trigger
- Stable, accurate measurements
- One button ease
- Wide bandwidth means lowest intrinsic ISI/DDJ
- Lowest jitter floor means highest sensitivity RJ measurements
- Support for all DCA plug-ins, optical and electrical
- Limit tests provide quick pass-fail interference and jitter results

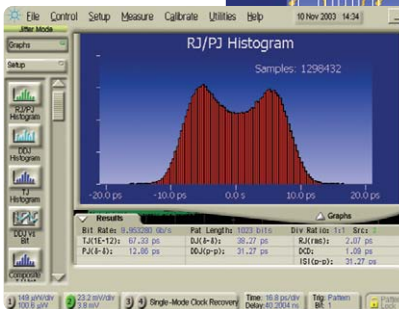
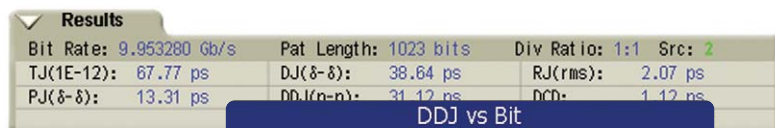

Displays that save you time

Sometimes you want to get in-depth analysis of a difficult device performance issue. Sometimes you want data views that are compatible with other instruments so you can correlate multiple answers. And then, there are times when you just want to know whether your device meets a standard.

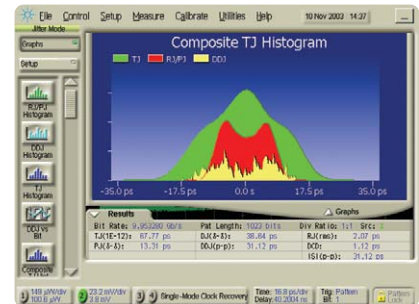

The DCA-J handles all of these situations by providing revealing histograms and intuitive graphical views, and by providing an easy and simple table of jitter sub-components. Its aim is to save you time.

The *Fastest* Way To The Right Answer

1

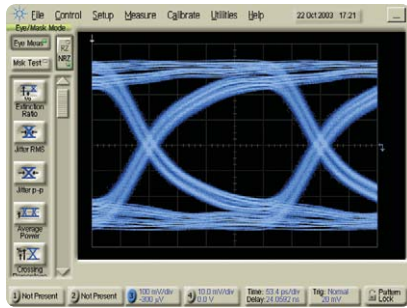

Easy setup, easy triggering

Many interference and jitter measurements turn out to be inaccurate because of some small but important error in a complicated measurement setup. With the DCA-J, a simple physical setup, combined with a user interface that never lets you get lost, makes getting simple, accurate interference and jitter measurements easy.

2

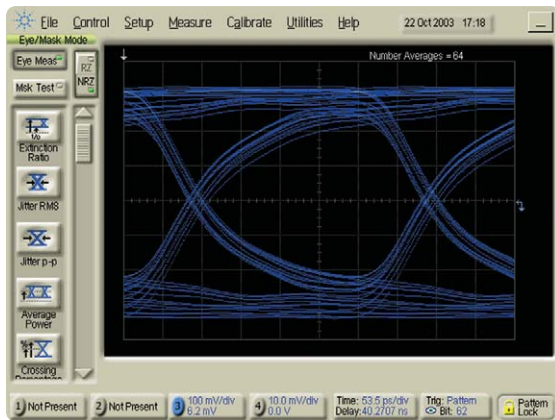

Eyeline mode—see your problem sequences

It's easy to move between eye diagrams that overlay all possible bit sequences to single valued waveforms that show individual bit sequences. Sometimes it would be useful to make the noise disappear and just see the inter-symbol effects (ISI). Averaging in eyeline mode enables you to do exactly that. Now you can see exactly which sequences are causing mask violations. No need for a pattern trigger either—connect your signal and in most cases the instrument detects pattern length and bit rate without being told—you have an immediate display to work from.

3

Interference and jitter mode – one button gateway to understanding jitter

Interference and jitter can be a complex subject, and sometimes it can seem that your test equipment is making it even more complicated. Ultimately, you just want to get a design completed and working. Finally, there is a test solution that makes things simpler.

Eye diagrams have proved useful because they are so intuitive. Building on this intuitiveness, the DCA-J shows you the behavior of your device in the jitter domain but always tracks back to the eye diagram. Measurements not making sense? Maybe something changed in your setup. It's easy to switch back to the eye and quickly see whether everything is how you left it. Results are in familiar formats – but that have never been available for 6, 10, or 40 Gb/s applications. Simplicity in setup and operation means you can be confident that you are making accurate, valuable measurements from the very beginning.

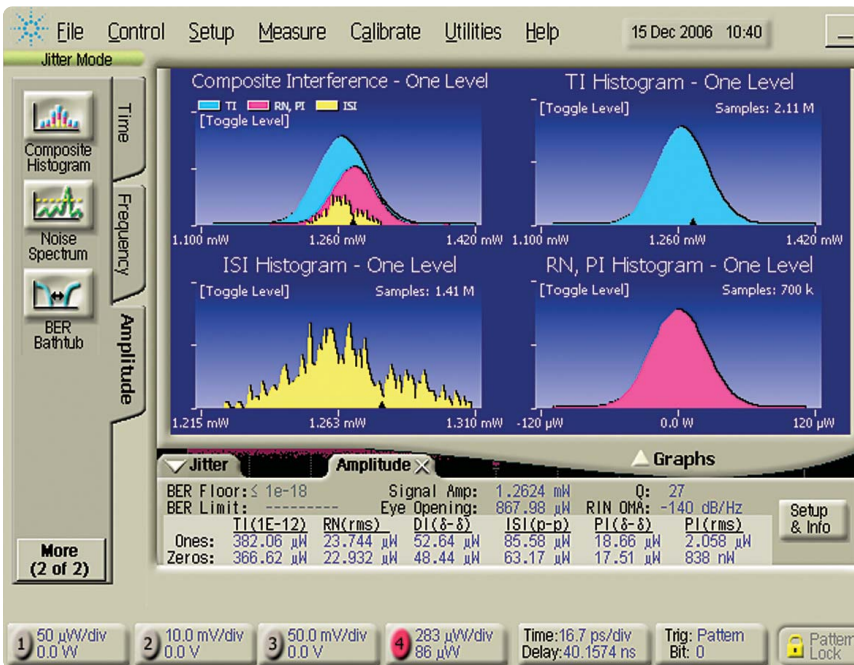

The Big Picture—4 Instruments In 1



Compatible

Modules for the 83480A/54750A are compatible with the 86100 family.

NRZ/RZ

Complete set of NRZ/RZ measurements

Touchscreen

A high performance touchscreen allows easy navigation of the instrument interface. Or, use dedicated knobs or a mouse—the choice is yours.

Easy user interface

A well-designed Windows®-based graphical user interface makes it easy to access advanced features.

Icons provide access to an extensive set of common tests and measurements.

Dedicated interference and jitter analysis mode

Whether you are making electrical or optical measurements, quickly change between observing the eye to making quick, accurate, and intuitive interference and jitter measurements with the touch of a button.

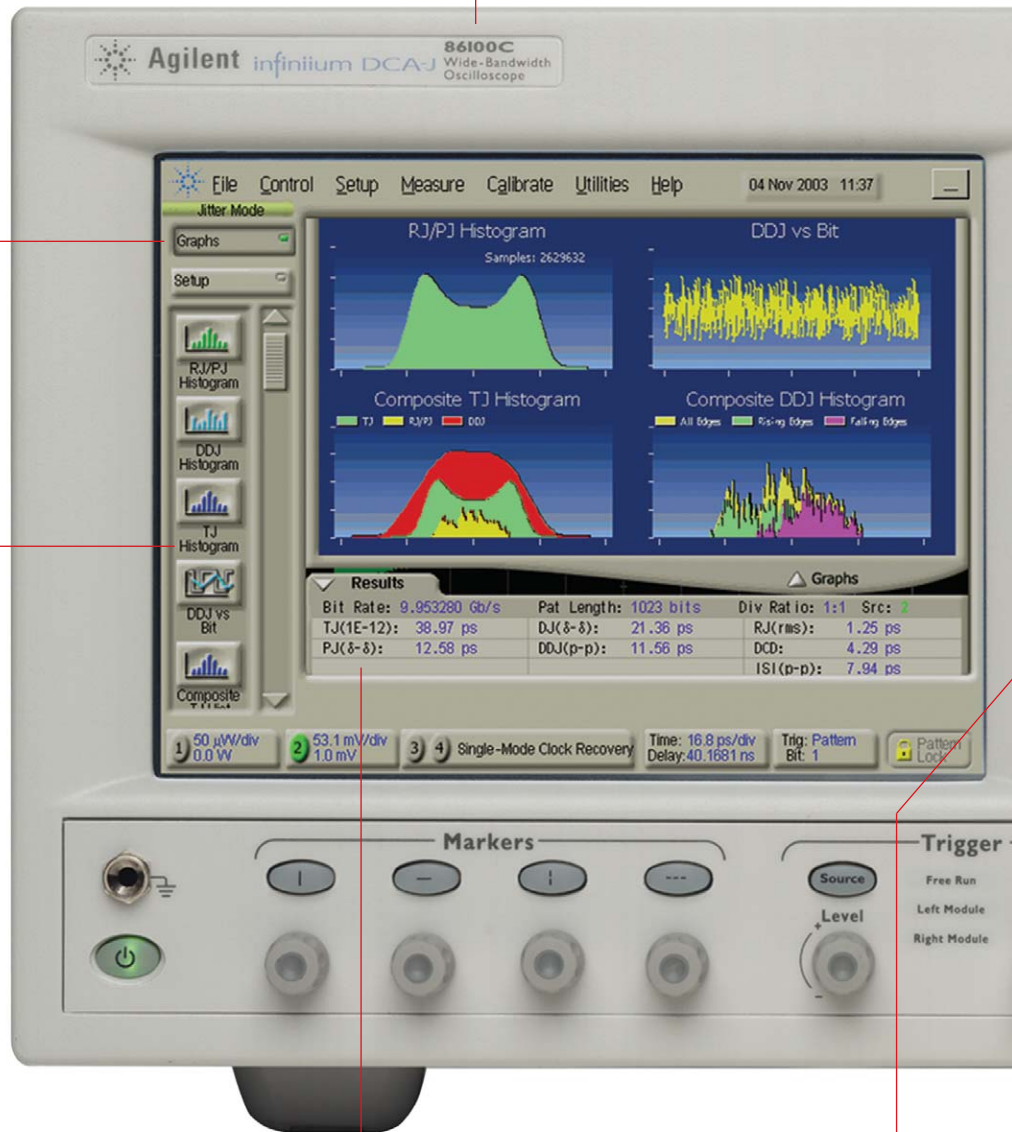



Autoscale

Improved autoscale for a quick display of waveforms including eye-diagrams

Flexible storage

Internal hard drive, front panel USB port, and supplied USB pen drive make storage and transfer of setups, image files, database files, and waveforms easy.

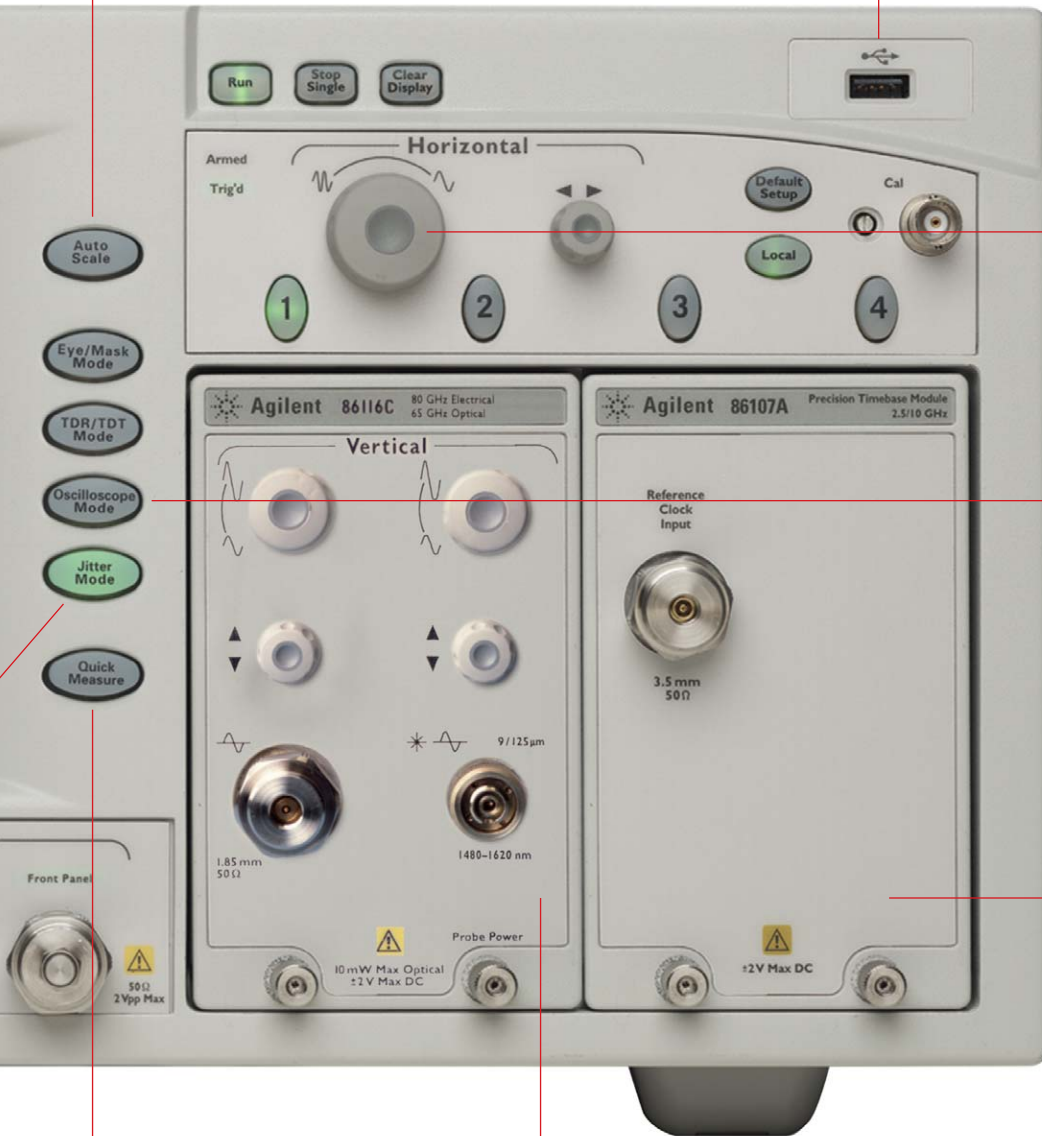

Dedicated controls for common adjustments

Analog oscilloscope type front panel provides simple controls for basic functions.

4 instruments in 1

A digital communications analyzer, a full featured wide-bandwidth oscilloscope, a time domain reflectometer and now a fast and accurate jitter analyzer. Just select the desired operating mode to set up the instrument you want.

Very low intrinsic jitter

The intrinsic jitter noise floor of the instrument is extremely low, making it easy to measure high performance designs where instrument jitter might otherwise hide the real device performance. For the ultimate in performance, the 86107A can be used to reduce the intrinsic jitter to an industry leading level.

Quick measure

Use quick measure to do a compliance test with a single button press. Quick measure can also be configured to automatically perform your favorite four measurements.

Modular

Configure the 86100C for the exact capability you need with a large family of plug-in modules to choose from.



Fast Time To Insight

With higher bit rates being used in ever lower target cost systems, advanced techniques are being used to get a low system BER. Circuit boards constructed from FR-4 can be cheap, but they distort pulse trains passing across them. Designers are increasingly employing pre-emphasis and equalization to counteract inter-symbol interference (ISI) and open up the eye. However, it can be hard to measure the effectiveness of such systems. Designers use modeling to predict component performance, but they ultimately need to verify with real-world measurements.



In the modern ultra high speed SERDES business, understanding jitter at the zero crossing points of a waveform is not enough. Accurate capture of very long data packets becomes a requirement to permit post-processing both for design analysis and standards compliance testing. It is also our desire to have a single signal analysis platform to handle bit rates from 1 Gb/s to 12.5 Gb/s and beyond.

The 86100C meets our requirements well. In addition to its new jitter analysis package, the combination of its flexible triggering system and precision timebase enables the capture of averaged very long data packet waveforms with unprecedented accuracy. The speed of the instrument has also been impressive with DDJ measurements that used to take hours being reduced to less than a minute.

—Steve Hubbins
Silicon Evaluations Specialist, Texas Instruments

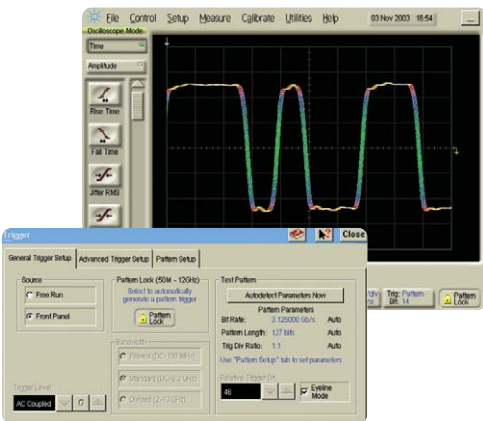

Pattern Lock control

The DCA-J can swiftly provide insight

- Pattern Lock enables single-valued waveform viewing at even the fastest bit rates when **no separate pattern trigger** is available.
- Triggering is also enhanced with the industry's most capable **optical and electrical clock recovery** instrument solution, the 83496B.
- With electrical channels that have bandwidths ranging from 12 GHz to in excess of 80 GHz, you can be sure of the most precise pulse fidelity.
- **Probing** – if connectorized test points are not available, use the award-winning Infiniimax probes to their maximum bandwidth advantage (in excess of 12 GHz) by pairing them with the N1022A probe adapter and the DCA-J's wide bandwidth inputs.



- Even closed eyes can be captured and opened as pulse train data and the effectiveness of common **equalization** techniques are seen from on-board algorithms.
- With many standards scaling up in bandwidth at an increasing rate, the DCA-J has you covered for now and for the foreseeable future. All at a new price/performance benchmark.

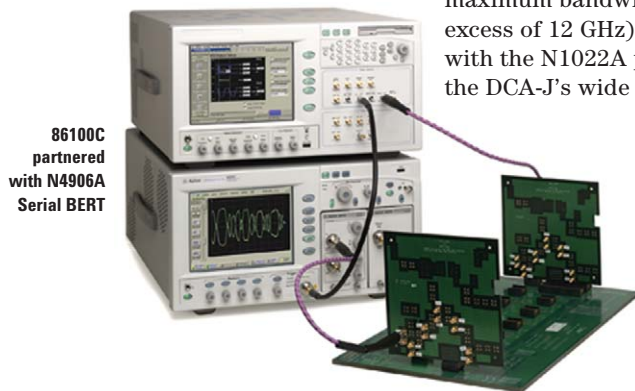

86100C partnered with N4906A Serial BERT

An end to bit rates
outpacing your test equipment



Superior Signal Integrity Insight

Configure the DCA as a time domain reflectometer (TDR) to quantify the transmission and reflection properties of components and channels.

- View S-parameter performance at the touch of one button for single-ended or mixed-mode circuits
- Unique calibration capabilities remove systematic measurement errors from cabling, connectors, and probes so you see only the properties of the test device
- Similar to calibrations of network analyzers...just place a short circuit and load at the reference plane of the test device
- Increase the two-event resolution impedance precision of the TDR through pulse enhancement
- See sub-millimeter two-event resolution and accurately measure impedance for ultra-fast edge speeds with accessories from Picosecond Pulse Labs (www.Picosecond.com)

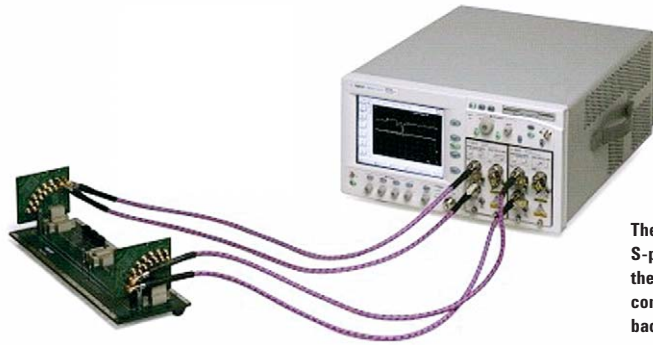

The DCA-J, TDR module and S-parameter software covers the challenge of characterizing complex circuitry such as backplanes.

- Highest fidelity and most symmetrical dual-TDR outputs yield precision differential and common mode results in a single setup
- Gain insight and improved modeling through frequency domain S-parameters and export in Touchstone format
- Use the N1930A physical layer test system software to automatically configure and calibrate the 86100 TDR system, providing a complete set of single-ended and mixed-mode frequency domain S-parameters

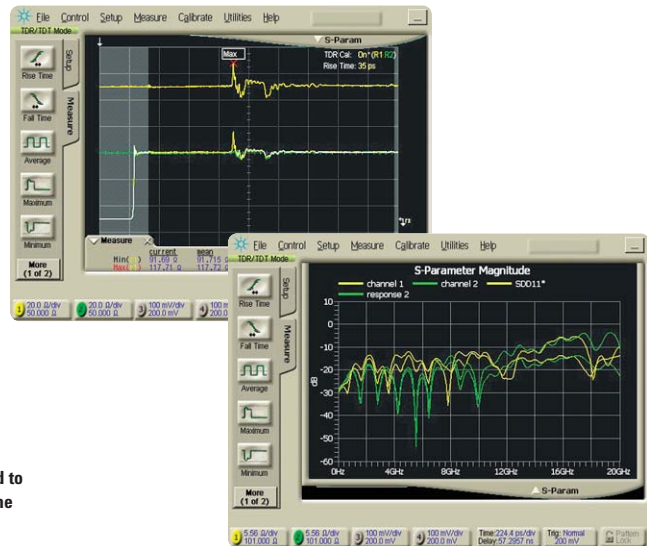
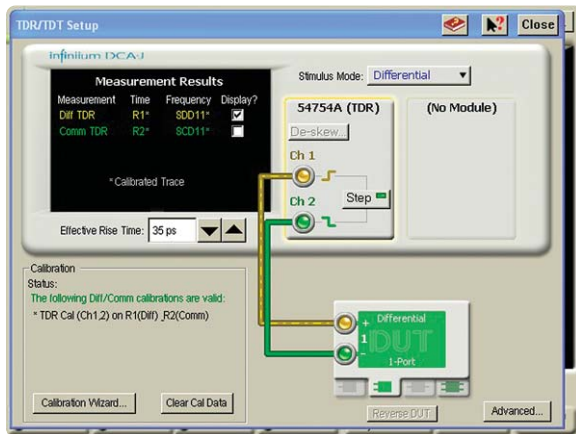

Intuitive setup guides lead to accurate results in the time and frequency domain.



In Just A Few Minutes, Become An Expert In Compliance Testing

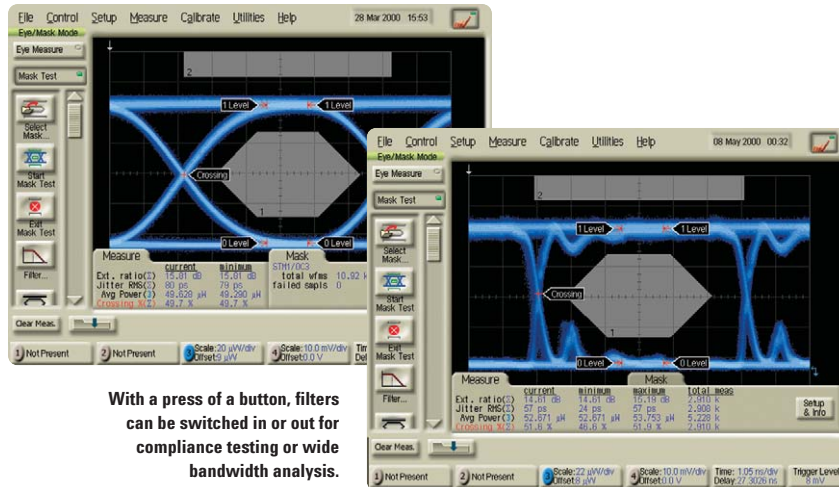

With a press of a button, filters can be switched in or out for compliance testing or wide bandwidth analysis.

SONET/SDH compliance

Transmitters used in SONET/SDH applications must perform according to a rigorous set of industry-defined standards. A significant portion of what defines acceptable performance is based on waveform quality tested with a high-speed sampling oscilloscope. The 86100C is ideally suited to verify transmitter compliance quickly and accurately. Tests are performed automatically according to industry-recognized procedures. The 86105B and 86105C are industry leaders in waveform fidelity, mask margin, and extinction ratio accuracy up to 11 Gb/s applications.

Easy. Quick. Accurate.

The 86100C makes compliance testing straightforward—only two keystrokes are needed to perform a complete compliance test. Scaling the waveform, acquiring the data, and completing the compliance test require only a few seconds. Many plug-in modules contain multiple filters so many different rates can be tested with the required standards-based reference receiver methodology. Filters are easily switched out to allow testing with the full instrument bandwidth.

Enterprise & storage

Transmitter testing for 10 Gigabit Ethernet and 10X Fiber Channel uses similar methodologies to those used in SONET/SDH, but there are some important variations. An aspect that makes testing easier is that despite the differing bit rates (10.3125 Gb/s and 10.51875 Gb/s respectively) the compliance filter has been specified to be the same frequency as for 9.95 Gb/s SONET/SDH.

Clock recovery is a more significant difference. Transmitter test requires the use of a clock trigger that is derived from the transmitted signal itself. A critical feature of the clock recovery process is the loop bandwidth. This is intended to “track out” the jitter components that are less than the specified bandwidth, so that only elements beyond this are displayed on the eye diagram. The 83496B clock recovery module is compliant to this requirement as well as offering continuous rate coverage from 50 Mb/s to 13.5 Gb/s to cover nearly all applications. In addition, the 83496B can track spread-spectrum clocking (SSC), and provide the data to measure phase noise.

Mask test diagnostics—86100C infinium DCA-J goes beyond basic testing with margin analysis for process monitoring. Mask hits/failures are easily viewed with red pixels.

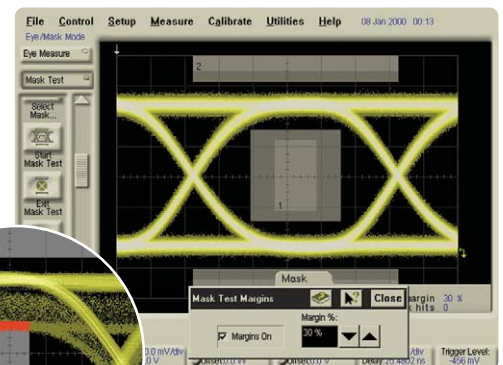
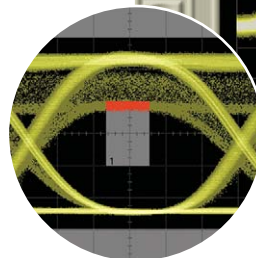

40 Gb/s RZ? No Problem!

There are many demanding aspects to 40 Gb/s testing. RZ modulation is now a common format in 40 Gb/s systems, and has a unique set of measurement parameters defined to describe it. Components designed for 40 Gb/s systems also must have very low intrinsic jitter to successfully operate, with levels sometimes so low that it is difficult to tell whether measured jitter is the result of component jitter or the inherent jitter noise floor of the measuring instrument.

“ The most significant improvement is that we can now show a repeatable, low jitter result to customers without going into lengthy discussions about test methods. As a result, we are able to go to customers with results taken directly from the equipment – results better than anything they’ve seen before.

We expect additional future business directly as a result of returning to the 86100 platform, recognizing this as the premier solution in our measurement laboratory. ”

—Matt Isaacs
Verification Engineer, Broadcom Corporation



To counter both of these new challenges, Agilent has industry leading answers to enable your success. A broad choice of modules is led by the 86118A module with 70+ GHz dual electrical remote heads, or choose the 86116C 65 GHz optical/ 80 GHz electrical module¹. In both cases, once the signal is acquired, it is a breeze to activate the automated RZ

measurements to instantly see contrast ratio, eye opening factor, and many other critical parameters.

The 86116C also has 4th order Bessel-Thomson filters that make it a reference receiver for 39-43 Gb/s signals.

To lower the intrinsic jitter of the instrument for the most demanding applications, the 86107A has enabled many, many customers to see their true device performance. This module has revolutionized high performance

10 Gb/s and 40 Gb/s measurements. The 86107A² reduces the inherent timebase interference and jitter to about 200 fs – almost a factor of 5 reduction in system jitter.

The 86107A requires an electrical reference clock that is synchronous with the signal under test and allows timebase resolution to be improved from 2 ps/division to 500 fs/division. For 40 Gb/s applications, the 86107A is considered a must.

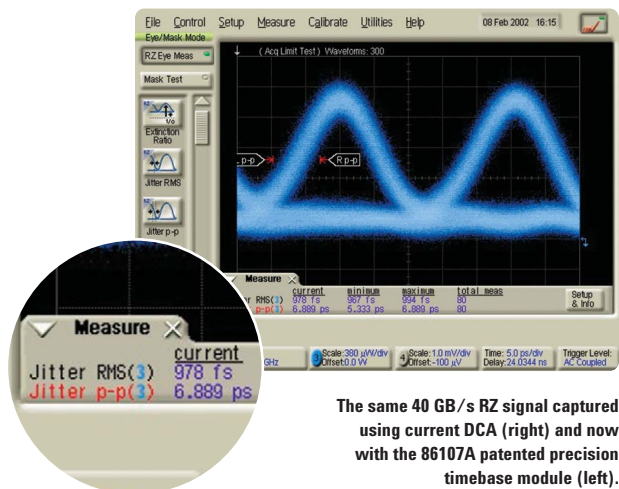
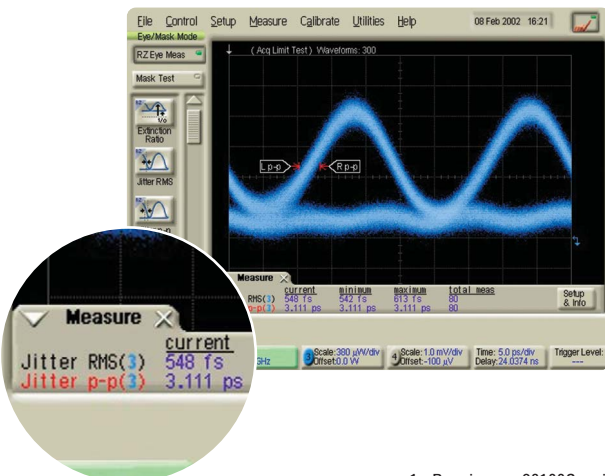

The same 40 GB/s RZ signal captured using current DCA (right) and now with the 86107A patented precision timebase module (left).

1 Requires an 86100C mainframe
2 Compatible with any 86100 A/ B/C mainframe

Configurations Matching Your Applications

86100C Infiniium DCA-J Mainframe				
<p>Electrical 1 to 12 Gb/s</p> <p>86112A Dual channels > 20 GHz each</p> <p>83496B Electrical clock recovery (#100, 200, 300)</p>	<p>Electrical 20, 40 Gb/s</p> <p>86118A Dual remote heads 70 GHz each</p> <p>86107A Precision timebase (#040)</p>	<p>Optical 1 to 12 Gb/s</p> <p>86105C 9 GHz optical channel 20 GHz electrical channel</p> <p>83496B Optical clock recovery (#101, 200, 300)</p>	<p>Optical 20, 40 Gb/s</p> <p>86116C 65 GHz optical channel 80 GHz electrical channel</p> <p>86107A Precision timebase (#040)</p>	<p>TDR</p> <p>54754A Differential TDR/ Dual 18 GHz channels</p>

Other modules and options available. See the Technical Specifications, Literature Number 5989-0278EN or www.agilent.com for configuration details.

More details can be found in the Infiniium DCA Technical Specifications, 5989-0278EN

See also the 86100C library at www.agilent.com for application notes and additional product information

Mainframe

86100C	Digital communications analyzer, 3.2 GHz trigger bandwidth.
Option 001	Enhanced trigger to 13 GHz+, pattern lock, eyeline mode.
Option 200	Jitter analysis software package (requires Option 001). TJ, RJ, DJ, DDJ, PJ, DCD histograms and numerical results. DDJ vs. Bit display. SRJ analysis.
Option 201	Advanced waveform analysis software package (requires Option 001 & 101). Bathtub, export of large single valued waveform segments, equalization of closed eyes.
Option 202	Enhanced impedance and S-parameter software.
Option 300	Advanced amplitude analysis (requires Options 200 & 001)

Dual Electrical Modules

54754A	Differential TDR module with dual 18 GHz TDR/ electrical channels
86112A	Dual 20 GHz electrical channels
86117A	Dual 50 GHz electrical channels
86118A	Dual 70 GHz electrical remote sampling channels

Optical / Electrical Modules

86105B	15 GHz optical channel (single-mode, unamplified)/ 20 GHz electrical channel
86105C	9 GHz optical channel (multimode, amplified)/ 20 GHz electrical channel
86106B	28 GHz optical channel (single-mode, unamplified)/ 40 GHz electrical channel
86116A	53 GHz optical channel/ 63 GHz electrical channel
86116B	65 GHz optical channel/ 80 GHz electrical channel
86116C²	65 GHz optical channel (single-mode, unamplified) 80 GHz electrical channel

Clock recovery and timebase modules¹

83496B-100²	50 Mb/s to 7.1 Gb/s Electrical Clock Recovery
83496B-101²	Single-Mode (1250 to 1620 nm) and Multimode (780 to 1330 nm) Optical Clock Recovery
86107A	Precision Timebase Reference

Upgrade services

86100CS-001	Enhanced trigger hardware upgrade
86100CU-200	Enhanced jitter analysis SW upgrade
86100CU-201	Advanced waveform analysis SW upgrade
86100CU-202	Enhanced impedance and S-parameter software upgrade
86100CU-300	Advanced amplitude analysis SW upgrade
83496UAB	Upgrades the 83496A to the "B" performance
86100A/B to 86100C upgrade	Contact Agilent Technologies for current trade-in deals

Time domain reflectometer

54754A	Dual channel differential TDR module.
---------------	---------------------------------------

¹ See technical specifications for detailed configuration options.

² Module not compatible with the 86100A and 86100B DCA mainframe. If you want to upgrade older DCAs, contact Agilent Technologies and ask for current trade-in deals.

Interfaces and Accessories

Probes, adapters and other interface kits

Other application-specific probe and interfaces kits are available from Agilent Technologies or its channel partners. See www.agilent.com or contact your local sales office for details.



N1080A HDMI fixtures – literature number 5989-5118EN



N1022A probe adapter for Agilent 1130 or 1150 probe series – literature number 5988-8541EN

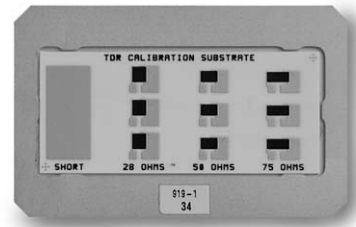

N1020A-K05 calibration substrate – literature number 5968-7376E



N1020A-K09, 10, 11 TDR cables for FireWire, Gigabit Ethernet, HSSDC, and Fiber Channel – literature number 5980-2933EN



N1020A TDR probe – literature number 5968-4811E



N1024A TDR calibration kit – literature number 5989-4149EN

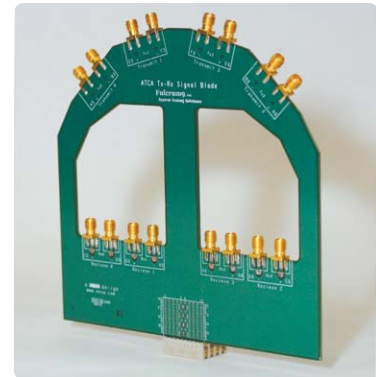

Advanced TCA Tx/Rx SignalBlade™ (F9 Systems – www.f9-systems.com)

9ps Step

35ps Step

Picosecond Pulse Labs 4020 Source Enhancements Module with 86118A Remote Head for ultra-fast TDR measurements.

Complementary Products

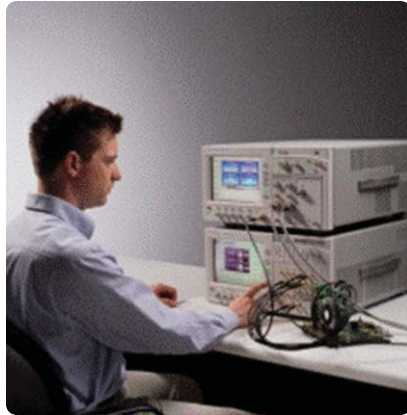

86100C Infiniium DCA-J (top) with a N4903A J-BERT allows you complete insights into your physical layer performance

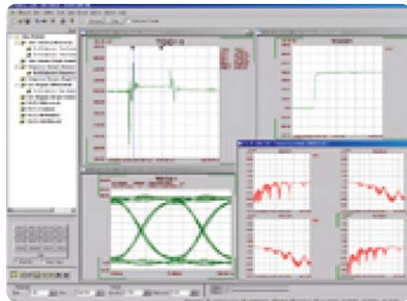

The N1930A physical layer test system (PLTS) software provides confidence in your design through complete characterization and behavior model extraction of your device under test (DUT). It supports both TDR and VNA platforms from Agilent Technologies.

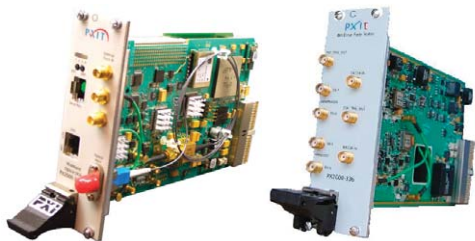

Agilent's PXI-based Digital Communication Analyzer, Bit Error Ratio Tester, Pattern Generator and Synthesizer provide fast and cost-effective test solutions for broadband optical transceiver manufacturing.

Windows and MS Windows are U.S. registered trademarks of Microsoft Corporation.

Remove all doubt

Our repair and calibration services will get your equipment back to you, performing like new, when promised. You will get full value out of your Agilent equipment throughout its lifetime. Your equipment will be serviced by Agilent-trained technicians using the latest factory calibration procedures, automated repair diagnostics and genuine parts. You will always have the utmost confidence in your measurements.

Agilent offers a wide range of additional expert test and measurement services for your equipment, including initial start-up assistance onsite education and training, as well as design, system integration, and project management.

For more information on repair and calibration services, go to

www.agilent.com/find/removealldoubt

Agilent Email Updates

www.agilent.com/find/emailupdates
Get the latest information on the products and applications you select.

Agilent Direct

www.agilent.com/find/agilentdirect
Quickly choose and use your test equipment solutions with confidence.

Agilent Open

www.agilent.com/find/open
Agilent Open simplifies the process of connecting and programming test systems to help engineers design, validate and manufacture electronic products. Agilent offers open connectivity for a broad range of system-ready instruments, open industry software, PC-standard I/O and global support, which are combined to more easily integrate test system development.

www.agilent.com

For more information on Agilent Technologies' products, applications or services, please contact your local Agilent office. The complete list is available at:

www.agilent.com/find/contactus

Online assistance:

www.agilent.com/comms/dca

Phone or Fax

United States:

(tel) 800 829 4444
(fax) 800 829 4433

Canada:

(tel) 877 894 4414
(fax) 800 746 4866

China:

(tel) 800 810 0189
(fax) 800 820 2816

Europe:

(tel) 31 20 547 2111

Japan:

(tel) (81) 426 56 7832
(fax) (81) 426 56 7840

Korea:

(tel) (080) 769 0800
(fax) (080) 769 0900

Latin America:

(tel) (305) 269 7500

Taiwan:

(tel) 0800 047 866
(fax) 0800 286 331

Other Asia Pacific Countries:

(tel) (65) 6375 8100
(fax) (65) 6755 0042

Email: tm_ap@agilent.com

Revised: 11/08/06

Product specifications and descriptions in this document subject to change without notice.

© Agilent Technologies, Inc. 2003 - 2007
Printed in USA, January 12, 2007
5988-5235EN



Agilent Technologies