

---

# Embra

Product Specifications	166
Fabrics and Options	167
Contrasting Fabric	168
End Caps	169
Product Positioning	171
Product Pages	172
COM Yardage Requirements	183

**EMBRA PRODUCT SPECIFICATIONS**

**CUSHIONS**

- Cushions are made of high grade, high resiliency, CFC-free, laminated polyurethane foam

**ARMS**

- Arms are 4" thick
- Arm frames are constructed of ½" thick plywood
- Arm tops and outside panels feature ½" and ¾" thick high grade polyurethane foam
- Arms feature a sewn slipcover with French seams that is stapled into place

**BACK, SEAT, AND ARMS**

- Back, seat, and arms have decorative top-stitch detailing

**END CAP TABLES, CORNER TABLES, AND TABLETS**

- End cap tables, corner tables, and tablets consist of a HPL top surface, MDF core, and a 3D Laminate matte luxe bottom surface with low sheen
- Matte luxe provides a soft touch and feel
- All surfaces have rounded corners and sides

**ARM CAPS**

- Arm caps are available in wood, polyurethane, and solid surface
- EOS<sup>CU</sup> (Cupron enhanced EOS) biocidal solid surface arm caps are optional on solid surface arm cap model; upcharge applies

**TABLETS**

- Tablets are handed and swing 90 degrees, allowing easy access
- Tablet mechanism attaches to the front of arm (field installed) and features a platinum metallic finish

**SEATS**

- Seats feature a high-tension, strip webbing suspension
- Seat upholstery features a wrap-around upholstery method and is stapled into place

**LEG FRAMES**

- Leg frames are casted aluminum side frame; powdercoated

**RAILS**

- Rails are rectangular tubular steel with 2mm wall thickness; powdercoat finish

**POWER/USB CENTER**

- Mini-Tap<sup>®</sup> power/USB center option features one AC power outlet and USB A+C dual charging ports
- Factory installed; upcharge applies

**CLEAN OUT**

- Clean out is standard on all models to make cleaning easy and simple
- Clean out space is slightly visible between back and seat cushions, but does not detract from the aesthetic or function of the lounge

**GLIDES**

- Non-skid, adjustable black glides are 1" in diameter with 1" adjustability

**FRAME**

- Frame is constructed of ¾" thick OSB, using a lap-joint construction method
- Frames are glued and screwed together

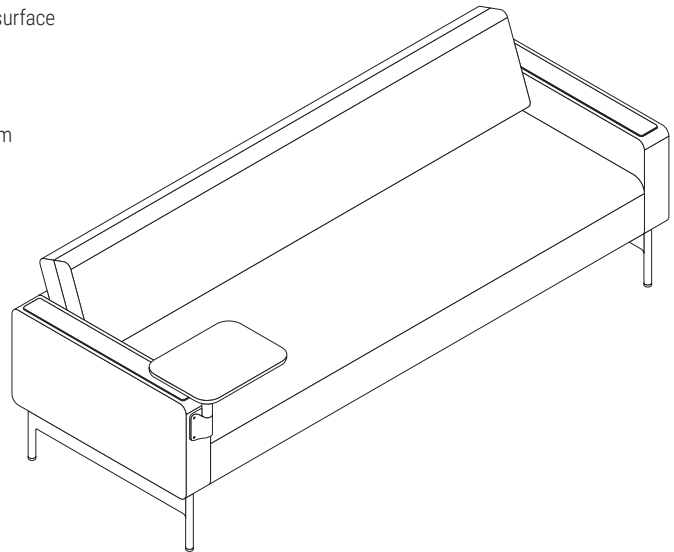
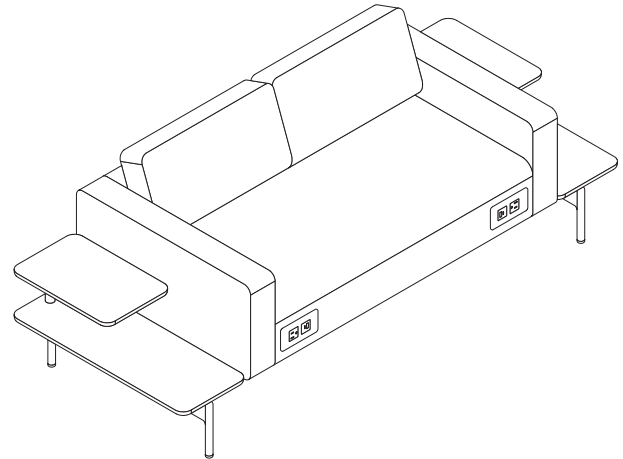

**SURFACE MATERIALS**

See the Kimball Hospitality Surface Materials Reference Guide at [kimballhospitality.com](http://kimballhospitality.com) for a complete overview of our materials program, including:

- Characteristics of wood
- Special wood finishes
- Customer-specified laminate (CSL)
- Customer-specified paint (CSP)
- Fabric application and colorways
- Customer's own material (COM) process overview
- Alliance program

**ALLIANCE FABRIC PROGRAM**

Kimball Hospitality has analyzed each model to most accurately reflect the COM/COL yardage requirements shown on page 183.

The yardage requirement for each model is based on 54" W fabric and cutting the fabric up the roll.

If repeat is larger than 18", contact Customer Service to confirm the correct amount of yardage required. When ordering 10 or more chairs in the same COM, yardage requirements may be reduced.

Contact Customer Service.

**PRICE GRADES A-R**

See Surface Materials at [www.kimball.com](http://www.kimball.com) for a wide variety of graded-in fabrics from Arc-Com, CF Stinson, DesignTex, Maharam, Momentum, and Ultrafabrics.

**FABRIC SAMPLES**

If you need samples for presentation(s), contact our alliance partners directly at:

Arc-Com	800.223.5466	<a href="http://arc-com.com">arc-com.com</a>
DesignTex	800.221.1540	<a href="http://designtex.com">designtex.com</a>
CF Stinson	800.841.6279	<a href="http://cfstinson.com">cfstinson.com</a>
Maharam	800.645.3943	<a href="http://maharam.com">maharam.com</a>
Momentum	800.366.6839	<a href="http://memosamples.com">memosamples.com</a>
Ultrafabrics	877.309.6648	<a href="http://ultrafabricsllc.com">ultrafabricsllc.com</a>

**END CAP TABLES AND STORAGE TABLES, CORNER TABLES AND TABLETS**

**3D LAMINATE**

**MATTE LUXE**

- 462 Cinder
- 440 Cloud
- 405 Designer White

**END CAP TOP SURFACES, TABLET TOP SURFACES, AND CORNER TABLE TOP SURFACES**

**HPL**

**WOOD STRAIGHT GRAIN**

- AD Almond Straight Grain
- CO Canyon Straight Grain
- DF Driftwood Straight Grain
- YO Monterey Straight Grain
- PB Portobello Straight Grain
- 792 Sable Straight Grain
- NW Tuscan Straight Grain

**SOLID**

- 462 Cinder
- 440 Cloud
- 405 Designer White

**FREESTANDING END CAP LOCATION**

- X None
- L Left as Seated
- R Right as Seated
- LR Left and Right as Seated

**BASE LEGS/RAILS, COAT RACK POLE BOTTOM SECTION, AND LAMP POLE BOTTOM SECTION**

**PAINT**

**SOLID COLOR PAINT**

- 462 Cinder
- 440 Cloud
- 405 Designer White

**METALLIC PAINT**

- 501 Platinum Metallic

**LAMP SHADE**

**PAINT**

**SOLID COLOR PAINT**

- BLK Matte black
- WHT Matte white

**METALLIC PAINT**

- SIL Silver

**ARM CAPS**

**POLYURETHANE**

- 495 Beige
- 462 Cinder
- 496 Grey

**SOLID SURFACE**

**STANDARD**

- 405 Designer White

**PREMIUM\***

- 495 EOS<sup>CU</sup> Beige
- 496 EOS<sup>CU</sup> Grey
- (1 Arm \$341 upcharge)
- (2 Arm \$682 upcharge)

**ARM CAPS, COAT RACK (UPPER SECTION), AND LAMP POLE (UPPER SECTION)**

**WOOD FINISH**

**PRICE GROUP 1**

- |               |               |
|---------------|---------------|
| AD Almond     | MH Mocha      |
| MC Amber      | YO Monterey   |
| IM Brighton   | PB Portobello |
| CO Canyon     | 792 Sable     |
| CC Cordoba    | SC Sedona     |
| DF Driftwood  | TW Tribeca    |
| ES Espresso   | NW Tuscan     |
| TM Huntington | UW Urban      |
| MW Midtown    |               |

IMPORTANT: Wood finishes applied to solid hardwood are complementary to the same wood finish applied to wood veneer, but not an exact match. Contact Customer Service for more information.

**TABLET LOCATION**

- L Left as Seated
- R Right as Seated
- LR Left and Right (\$1155 upcharge)

**MOISTURE BARRIER**

- X None
- MB1 Seat (\$122 upcharge)
- MB2 Seat and Inside Back (\$213 upcharge)

## TO ORDER CONTRASTING FABRIC, SPECIFY

### EMBRA

#### Chair, Loveseat, and Sofa Freestanding Lounge, Armless page 172

1. Model Number plus "X"
2. Inner Back Fabric Grade
3. Inner Back Fabric Number
4. Outer Back Fabric Grade
5. Outer Back Fabric Number
6. Seat Fabric Grade
7. Seat Fabric Number
8. Base Paint
9. Moisture Barrier Optional for Seat or Inside Back and Seat
10. Power/USB Option
11. End Cap Location

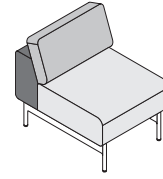

Contrasting Fabric may be specified on inside back, outside back, and seat

#### Chair and Loveseat Freestanding Lounge, Arms on Both Sides page 173 Sofa Freestanding Lounge, Arms on Both Sides page 174

1. Model Number plus "X"
2. Inner Back Fabric Grade
3. Inner Back Fabric Number
4. Outer Back Fabric Grade
5. Outer Back Fabric Number
6. Seat Fabric Grade
7. Seat Fabric Number
8. Arm Fabric Grade
9. Arm Fabric Number
10. Base Paint
11. Wood Finish Price Group
12. Arm Cap Designator (if applicable)
13. Moisture Barrier Optional for Seat or Inside Back and Seat
14. Power/USB Option
15. End Cap Location

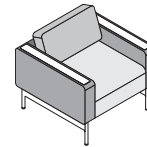

Contrasting Fabric may be specified on inside back, outside back, seat, and arms

## END CAPS

**End caps**, specified separately for field installation, are available for one or both ends of freestanding lounges

**End cap tables** provide easy-to-access horizontal surfaces. They are available in several styles to accommodate the needs in community spaces and patient rooms. They feature rounded corners and sides for safety

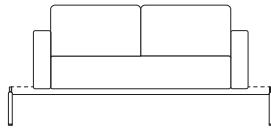

**End caps are supported by the leg frame** on the lounge or sofa model

**IMPORTANT:** The lounge model must be specified to accept an end cap

**By selecting the desired end cap location/connection** on freestanding lounge model, the rails and legs will be extended 6" to the left, right, or on both sides to accept and support an end cap

**End caps can be added to the left, right or both sides** of freestanding lounges with or without arms. Handing designation is determined from the user's perspective when seated

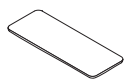

Single-Tier Table

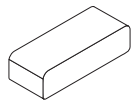

Upholstered Bench

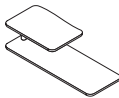

Tiered Table

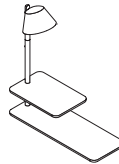

Tiered Table with Lamp

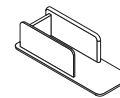

Storage Table

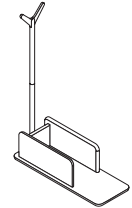

Storage Table with Coat Rack

## SINGLE-TIER TABLE:

- Can be used in any configuration, but is best suited for use with armless models
- Table surface is 32" deep x 12" wide x 1<sup>3</sup>/<sub>16</sub>" thick
- Height is 10<sup>13</sup>/<sub>16</sub>" above the floor when attached to leg frame (seat height is 18<sup>1</sup>/<sub>16</sub>")
- HPL top surface; underside is 3D laminate matte luxe

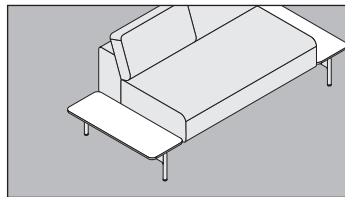

Single-Tier

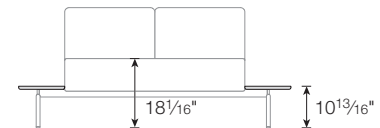

## UPHOLSTERED BENCH:

- For use with armless lounge models; ideal for back-to-back applications
- Bench surface is 32" deep x 12" wide x 18<sup>1</sup>/<sub>16</sub>" (same height as lounge seat)

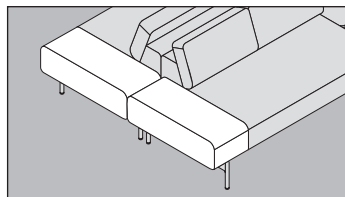

Upholstered Bench in Back-to-Back Application

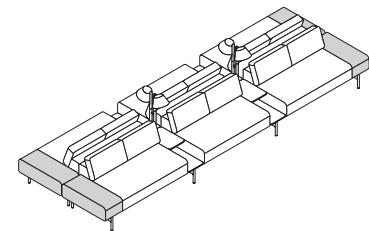

## GANGING APPLICATIONS:



**One ganging bracket** is required when lounge and/or end caps are used back-to-back. See page 175

## TO ORDER CONTRASTING FABRIC, SPECIFY

### END CAPS (CONTINUED)

#### TIERED TABLES WITH OR WITHOUT LAMP:

- Can be used in any configuration, but is best suited for use with models with arms
- Lower tier surface is 32" deep x 12" wide x  $\frac{1}{8}$ " thick; height is  $10\frac{13}{16}$ " above the floor when attached to leg frame
- Top tier is 18" deep and sits above the bottom tier by  $6\frac{3}{8}$ "
- HPL top surface; underside is 3D laminate matte luxe
- Lamp has 9" diameter aluminum spun lamp shade with powdercoat finish: Matte Black, Matte White, or Silver. Glossy white interior

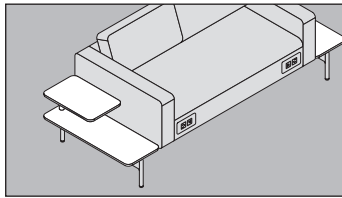

Tiered End Cap

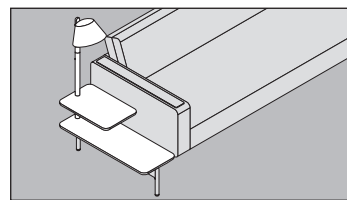
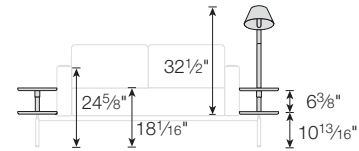

Tiered End Cap with Lamp  
• Lamp height is well-suited for reading

#### STORAGE TABLES WITH OR WITHOUT COAT RACK:

- Can be used in any configuration
- Coat rack models are best suited for end-of-run applications
- Storage area ideal for storing linens, pillows, or personal items
- Interior storage area is  $19\frac{1}{16}$ " deep x  $8\frac{7}{16}$ " wide x  $8\frac{1}{4}$ " high; height is  $10\frac{13}{16}$ " above the floor when attached to leg frame
- Table surface is 32" deep x 12" wide x  $\frac{1}{8}$ " thick; HPL top surface; underside is 3D laminate matte luxe
- Vertical sides of storage area are 3D laminate matte

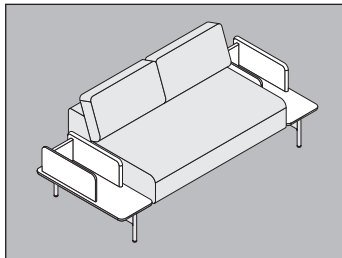

Storage End Cap

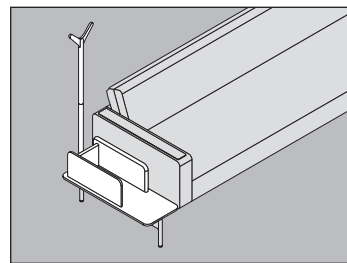
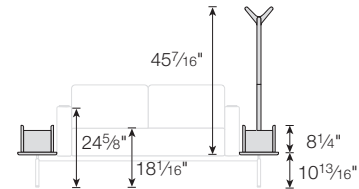

Storage End Cap with Coat Rack  
• Keeps personal items out of the sleep area and off of the floor

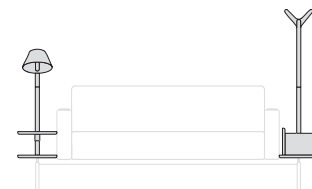

- Lamp and coat rack heights are different based on function

#### LAMP DETAILS:

- LED Light
- Touch switch on lamp shade interior
- Light output 320lm
- Light color: 2700K
- Power consumption: 4.5W
- Cord: white, 8 feet
- Input voltage: 100-240VAC, 50/60Hz
- UL listed
- Lamp pole is  $\frac{1}{4}$ " diameter; powdercoated lower section which connects to upper section with wood finish
- Lamp cord exits the upper wood section and re-enters the lower section to exit to the floor

**PRODUCT POSITIONING**

The Embra collection consists of freestanding lounge seating for community spaces, along with sleep sofas for patient spaces, to support a cohesive look throughout the facility. Intuitively designed with thoughtful details—including accessible power, storage for personal items, as well as surfaces and lighting—provide a sense of warmth and comfort

Additional features, including arm caps in multiple materials, clean out between the seat and back, and elevated metal legs, support cleanability and durability. Embra provides comfortable spaces for family interaction and quiet reflection with a homelike aesthetic

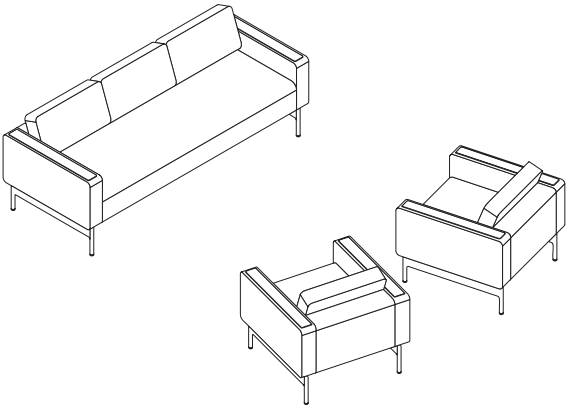

Freestanding Lounges



**TO ORDER, SPECIFY:**

1. Model Number
2. Inner Back Fabric Grade
3. Inner Back Fabric Number
4. Outer Back Fabric Grade
5. Outer Back Fabric Number
6. Seat Fabric Grade
7. Seat Fabric Number
8. Base Paint
9. Moisture Barrier Optional for Seat or Inside Back and Seat
10. Power/USB Option
11. End Cap Location

- See page 167 for Embra options
- See page 183 for COM fabric yardage

**FREESTANDING LOUNGE  
ARMLESS CHAIR**

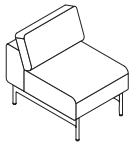

**MODEL  
NO.**

**ALLIANCE PROGRAM PRICE GRADES**

		A	B	C	D	E	F	G	H	I
		J	K	L	M	N	O	P	Q	R
K73FL1XA	Chair	\$ 2873	2958	3023	3089	3158	3242	3290	3380	3455
		3533	3659	3911	4070	4103	4133	4172	4211	4385

**DIMENSIONS**

Width	24	Seat Height	18½	End Cap Support (if Selected)	Weight	79.9
Depth	32⅝	Seat Depth	20½	Width (Each)	Cubic Ft.	19.30
Height	31¼	Seat Width	24			

- Contrasting fabric option – specify X (i.e., K73FL1XA); see page 168. For list pricing, use your electronic specification tool or contact customer service
- Tight back
- Clean out (visible)
- Metal rails and legs
- Non-skid, adjustable glides

**FREESTANDING LOUNGE  
ARMLESS LOVESEAT**

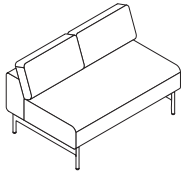

		A	B	C	D	E	F	G	H	I
		J	K	L	M	N	O	P	Q	R
K73FL2XA	Loveseat	\$ 4003	4127	4223	4320	4421	4544	4615	4747	4857
		4971	5156	5526	5759	5807	5851	5908	5966	6221

**DIMENSIONS**

Width	48½	Seat Height	18½	End Cap Support (if Selected)	Weight	129.5
Depth	32⅝	Seat Depth	20½	Width (Each)	Cubic Ft.	30.50
Height	31¼	Seat Width	48½			

- Contrasting fabric option – specify X (i.e., K73FL2XAX); see page 168. For list pricing, use your electronic specification tool or contact customer service
- Tight back
- Clean out
- Metal rails and legs
- Non-skid, adjustable glides

**FREESTANDING LOUNGE  
ARMLESS SOFA**

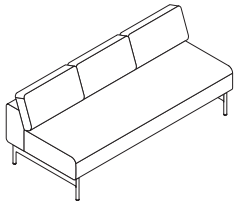

		A	B	C	D	E	F	G	H	I
		J	K	L	M	N	O	P	Q	R
K73FL3XA	Sofa	\$ 4753	4936	5078	5221	5370	5552	5656	5851	6014
		6183	6456	7002	7346	7418	7483	7567	7652	8029

**DIMENSIONS**

Width	72½	Seat Height	18½	End Cap Support (if Selected)	Weight	179.2
Depth	32⅝	Seat Depth	20½	Width (Each)	Cubic Ft.	41.60
Height	31¼	Seat Width	72½			

- Contrasting fabric option – specify X (i.e., K73FL3XAX); see page 168. For list pricing, use your electronic specification tool or contact customer service
- Tight back
- Clean out
- Metal rails and legs
- Non-skid, adjustable glides

EMBRA



**TO ORDER, SPECIFY:**

1. Model Number
2. Inner Back Fabric Grade
3. Inner Back Fabric Number
4. Outer Back Fabric Grade
5. Outer Back Fabric Number
6. Seat Fabric Grade
7. Seat Fabric Number
8. Arm Fabric Grade
9. Arm Fabric Number
10. Base Paint
11. Wood Finish Price Group
12. Arm Cap Designator (if applicable)
13. Moisture Barrier Optional for Seat or Inside Back and Seat
14. Power/USB Option
15. End Cap Location

- See page 167 for Embra options
- See page 183 for COM fabric yardage

**FREESTANDING LOUNGE  
ARMS ON BOTH SIDES  
CHAIR**

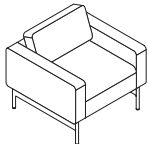

No Arm Caps

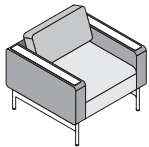

Arm Caps

**MODEL  
NO.**

**ALLIANCE PROGRAM PRICE GRADES**

		A	B	C	D	E	F	G	H	I
		J	K	L	M	N	O	P	Q	R
K73FL1A	No Arm Caps	\$ 3527	3666	3772	3880	3993	4130	4208	4355	4478
		4605	4811	5223	5482	5536	5585	5649	5713	5997
K73FL1ACW	Wood Arm Caps	3611	3750	3856	3964	4077	4214	4292	4439	4562
		4689	4895	5307	5566	5620	5669	5733	5797	6081
K73FL1ACP	Polyurethane Arm Caps	3705	3844	3950	4058	4171	4308	4386	4533	4656
		4783	4989	5401	5660	5714	5763	5827	5891	6175
K73FL1ACS	Solid Surface Arm Caps	4178	4317	4423	4531	4644	4781	4859	5006	5129
		5256	5462	5874	6133	6187	6236	6300	6364	6648

**DIMENSIONS**

Width	32 <sup>1</sup> / <sub>16</sub>	Seat Height	18 <sup>1</sup> / <sub>16</sub>	Arm Height		End Cap Support (if Selected)	
Depth	32 <sup>1</sup> / <sub>16</sub>	Seat Depth	20 <sup>1</sup> / <sub>2</sub>	No Arm Caps	24%	Width (Each)	6
Height	31 <sup>1</sup> / <sub>4</sub>	Seat Width	23 <sup>1</sup> / <sub>16</sub>	Arm Caps	24 <sup>13</sup> / <sub>16</sub>	Weight	
				Arm Width	4%	Cubic Ft.	21.50

- Contrasting fabric option – specify X (i.e., K73FL1AX); see page 168. For list pricing, use your electronic specification tool or contact customer service
- Tight back
- Clean out
- Metal rails and legs
- Non-skid, adjustable glides
- Arm caps on applicable models

**FREESTANDING LOUNGE  
ARMS ON BOTH SIDES  
LOVESEAT**

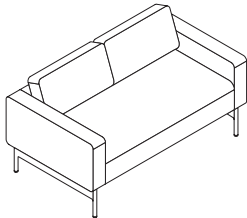

No Arm Caps

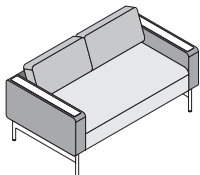

Arm Caps

**MODEL  
NO.**

**ALLIANCE PROGRAM PRICE GRADES**

		A	B	C	D	E	F	G	H	I
		J	K	L	M	N	O	P	Q	R
K73FL2A	No Arm Caps	\$ 4657	4835	4972	5111	5256	5432	5533	5722	5880
		6043	6308	6838	7171	7240	7303	7385	7468	7833
K73FL2ACW	Wood Arm Caps	4741	4919	5056	5195	5340	5516	5617	5806	5964
		6127	6392	6922	7255	7324	7387	7469	7552	7917
K73FL2ACP	Polyurethane Arm Caps	4835	5013	5150	5289	5434	5610	5711	5900	6058
		6221	6486	7016	7349	7418	7481	7563	7646	8011
K73FL2ACS	Solid Surface Arm Caps	5308	5486	5623	5762	5907	6083	6184	6373	6531
		6694	6959	7489	7822	7891	7954	8036	8119	8484

**DIMENSIONS**

Width	56 <sup>1</sup> / <sub>16</sub>	Seat Height	18 <sup>1</sup> / <sub>16</sub>	Arm Height		End Cap Support (if Selected)	
Depth	32 <sup>1</sup> / <sub>16</sub>	Seat Depth	20 <sup>1</sup> / <sub>2</sub>	No Arm Caps	24%	Width (Each)	6
Height	31 <sup>1</sup> / <sub>4</sub>	Seat Width	47 <sup>1</sup> / <sub>16</sub>	Arm Caps	24 <sup>13</sup> / <sub>16</sub>	Weight	
				Arm Width	4%	Cubic Ft.	32.70

- Contrasting fabric option – specify X (i.e., K73FL2AX); see page 168. For list pricing, use your electronic specification tool or contact customer service
- Tight back
- Clean out
- Metal rails and legs
- Non-skid, adjustable glides
- Arm caps on applicable models

**TO ORDER, SPECIFY:**

1. Model Number
2. Inner Back Fabric Grade
3. Inner Back Fabric Number
4. Outer Back Fabric Grade
5. Outer Back Fabric Number
6. Seat Fabric Grade
7. Seat Fabric Number
8. Arm Fabric Grade
9. Arm Fabric Number
10. Base Paint
11. Wood Finish Price Group
12. Arm Cap Designator (if applicable)
13. Moisture Barrier Optional for Seat or Inside Back and Seat
14. Power/USB Option
15. End Cap Location

- See page 167 for Embra options
- See page 183 for COM fabric yardage

EMBRA

**FREESTANDING LOUNGE  
ARMS ON BOTH SIDES  
SOFA**

**MODEL  
NO.**

**ALLIANCE PROGRAM PRICE GRADES**

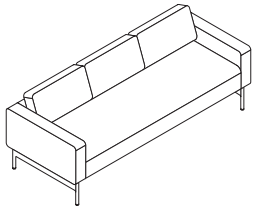

No Arm Caps

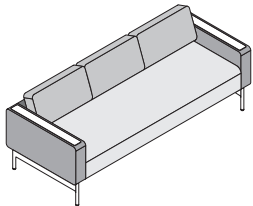

Arm Caps

			A	B	C	D	E	F	G	H	I
			J	K	L	M	N	O	P	Q	R
K73FL3A	No Arm Caps	\$	5407	5644	5827	6012	6205	6440	6574	6826	7037
			7255	7608	8314	8758	8851	8935	9044	9154	9641
K73FL3ACW	Wood Arm Caps		5491	5728	5911	6096	6289	6524	6658	6910	7121
			7339	7692	8398	8842	8935	9019	9128	9238	9725
K73FL3ACP	Polyurethane Arm Caps		5585	5822	6005	6190	6383	6618	6752	7004	7215
			7433	7786	8492	8936	9029	9113	9222	9332	9819
K73FL3ACS	Solid Surface Arm Caps		6058	6295	6478	6663	6856	7091	7225	7477	7688
			7906	8259	8965	9409	9502	9586	9695	9805	10292

**DIMENSIONS**

Width	80 <sup>1</sup> / <sub>16</sub>	Seat Height	18 <sup>1</sup> / <sub>16</sub>	Arm Height		End Cap Support (if Selected)
Depth	32 <sup>1</sup> / <sub>16</sub>	Seat Depth	20 <sup>1</sup> / <sub>2</sub>	No Arm Caps	24 <sup>1</sup> / <sub>16</sub>	Width (Each)
Height	31 <sup>1</sup> / <sub>4</sub>	Seat Width	71 <sup>1</sup> / <sub>16</sub>	Arm Caps	24 <sup>13</sup> / <sub>16</sub>	Weight
				Arm Width	4 <sup>1</sup> / <sub>16</sub>	Cubic Ft.
						43.80

- Contrasting fabric option – specify X (i.e., K73FL3AX); see page 168. For list pricing, use your electronic specification tool or contact customer service
- Tight back
- Clean out
- Metal rails and legs
- Non-skid, adjustable glides
- Arm caps on applicable models

**TO ORDER, SPECIFY:**

• See page 167 for Embra options

1. Model Number

**MODULAR LOUNGE  
GANGING BRACKET**



**MODEL  
NO.**

**LIST PRICE**

K73LGB      Ganging Bracket      \$    12

**DIMENSIONS**

Width	2	Weight	0.2
Depth	5 $\frac{1}{2}$	Cubic Ft.	0.20
Height	$\frac{1}{6}$		

# EMBRA

## TO ORDER, SPECIFY:

1. Model Number
2. HPL Surface Designator
3. 3D Laminate Matte Luxe Color for Bottom of Surface

• See page 167 for Embra options

### END CAPS SINGLE-TIER TABLE



### MODEL NO.

### LIST PRICE

---

K73ECT3212L	Single-Tier Table	\$	734
-------------	-------------------	----	-----

---

### DIMENSIONS

Width	12
Depth	32
Height	$\frac{13}{16}$

Weight	12.0
Cubic Ft.	.60

- HPL top surface with 3D laminate matte luxe underside
- Rounded corners and sides

**TO ORDER, SPECIFY:**

1. Model Number
2. HPL Surface Designator
3. 3D Laminate Matte Luxe Color for Bottom of Surface
4. Base Paint Designator

• See page 167 for Embra options

**END CAPS  
TIERED TABLE**

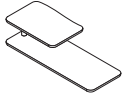

**MODEL  
NO.**

**LIST PRICE**

K73ECTT3212L	Tiered Table	\$ 1530
--------------	--------------	---------

**DIMENSIONS**

Width	12
Depth	32
Height	8

Weight	22.3
Cubic Ft.	4.50

- HPL top surface with 3D laminate matte luxe underside
- Rounded corners and sides

# EMBRA

## TO ORDER, SPECIFY:

• See page 167 for Embra options

1. Model Number
2. HPL Surface Designator
3. 3D Laminate Matte Luxe Color for Bottom of Surface
4. Lamp Pole Lower Section Paint Designator
5. Lamp Pole Upper Section Finish Group
6. Lamp Pole Upper Section Finish Designator
7. Lamp Shade Color

### END CAPS TIERED TABLE WITH LAMP

### MODEL NO.

### LIST PRICE

K73ECLTT3212L	Tiered Table with Lamp	\$ 2359
---------------	------------------------	---------

### DIMENSIONS

Width	12	Weight	26.6
Depth	32	Cubic Ft.	13.20
Height	8		
Lamp Height	32½		

- HPL top surface with 3D laminate matte luxe underside
- Rounded corners and sides
- Lamp shade is 9" diameter and features LED light with touch switch, powdercoated paint finish; field installed

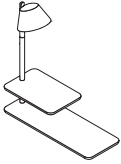

EMBRA

**TO ORDER, SPECIFY:**

• See page 167 for Embra options

1. Model Number
2. HPL Surface Designator
3. 3D Laminate Matte Luxe Color for Bottom of Surface
4. 3D Laminate Matte Luxe Color for Storage Vertical Surfaces

**END CAPS  
STORAGE TABLE**

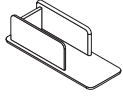

**MODEL  
NO.**

**LIST PRICE**

K73ECST3212L	Storage Table	\$ 2181
--------------	---------------	---------

**DIMENSIONS**

Width	12
Depth	32
Height	8 $\frac{1}{4}$
Interior Width	8 $\frac{7}{16}$

Weight	23.3
Cubic Ft.	5.00

- HPL top surface with 3D laminate matte luxe underside and vertical panels
- Rounded corners and sides

# EMBRA

## TO ORDER, SPECIFY:

• See page 167 for Embra options

1. Model Number
2. HPL Surface Designator
3. 3D Laminate Matte Luxe Color for Bottom of Surface
4. 3D Laminate Matte Luxe Color for Storage Vertical Surfaces
5. Coat Rack Lower Section Paint Designator
6. Coat Rack Upper Section Finish Group
7. Coat Rack Upper Section Finish Designator

### END CAPS STORAGE TABLE WITH COAT RACK

### MODEL NO.

### LIST PRICE

K73ECCRST3212L	Storage Table with Coat Rack	\$ 2785
----------------	------------------------------	---------

### DIMENSIONS

Width	12
Depth	32
Height	45 <sup>7</sup> / <sub>16</sub>
Interior Width	8 <sup>7</sup> / <sub>16</sub>

Weight	16.4
Cubic Ft.	8.90

- HPL top surface with 3D laminate matte luxe underside and vertical panels
- Rounded corners and sides
- Coat rack on applicable model: wood with wood finish and metal powdercoat paint

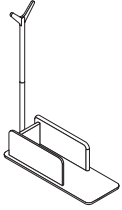

EMBRA



**TO ORDER, SPECIFY:**

1. Model Number
2. Fabric Grade
3. Fabric Number
4. Moisture Barrier Optional for Seat

- See page 167 for Embra options
- See page 183 for COM fabric yardage

**END CAPS  
UPHOLSTERED BENCH**

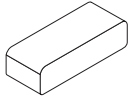

**MODEL  
NO.**

**ALLIANCE PROGRAM PRICE GRADES**

			A	B	C	D	E	F	G	H	I
			J	K	L	M	N	O	P	Q	R
K73ECBE3212U	Upholstered Bench End Cap	\$	951	994	1028	1061	1097	1139	1164	1210	1248
			1288	1352	1481	1562	1579	1594	1614	1634	1722

**DIMENSIONS**

Width 12¼  
 Depth 32  
 Height 8¼

Weight 19.9  
 Cubic Ft. 2.70

- Upholstered cushion

# EMBRA

## TO ORDER, SPECIFY:

• See page 167 for Embra options

1. Insert the Power Module Designator in Applicable Step in the Model Number Sequence

### KICK RAIL POWER/USB

### MODEL NO.

### LIST PRICE

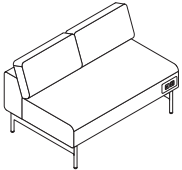

Left Front (as seated)

MTBLKL	Mini-Tap, Black	\$ 478
MTSILL	Mini-Tap, Silver	478
MTWHTL	Mini-Tap, White	478

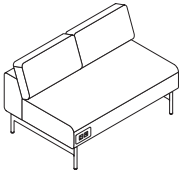

Right Front (as seated)

MTBLKR	Mini-Tap, Black	\$ 478
MTSILR	Mini-Tap, Silver	478
MTWHTR	Mini-Tap, White	478

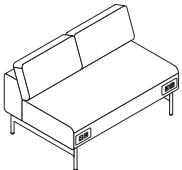

Left and Right Front (as seated)

MTBLKLR	Mini-Tap, Black	\$ 956
MTSILLR	Mini-Tap, Silver	956
MTWHTLR	Mini-Tap, White	956

### DIMENSIONS

Width 4½  
Height 2½

Weight  
Cubic Ft.

- **Mini-Tap® Power/USB Center** is available as a factory-installed option on the kickrail of freestanding lounges
- **Mini-Tap® Power/USB Center** features include:
  - Tamper-resistant single AC power outlet with shutter mechanism that protects children from sticking foreign objects into the receptacle
  - USB A-C dual charging ports
  - Spill-proof
  - UL listed
- **Overall size** is 4½" wide x 2½" high. Overall cord length is 72"; 50" length exits the bottom of the lounge and is positioned towards the outside of the lounge
- **Available colors:**
  - Black—Gloss black mounting plate, black receptacle
  - Silver—Silver powdercoat mounting plate, white receptacle
  - White—Gloss white mounting plate, white receptacle

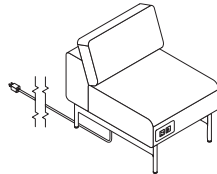

## COM YARDAGE REQUIREMENTS

### COM YARDAGE REQUIREMENTS (54" WIDTH – CUT UP THE ROLL)

MODEL	RAILROADED Contact customer service 800-634-9510 for ydg requirements	NON DIRECTIONAL OR SOLID	1"-4" REPEAT	5"-11" REPEAT	12"-18" REPEAT	COL SQUARE FEET
			4" VERTICAL X 4" HORIZONTAL	11" VERTICAL X 11" HORIZONTAL	18" VERTICAL X 18" HORIZONTAL	
K73FL1XA	Entire Unit	2.30	3.90	5.10	5.60	46.5
	Inner Back	0.70	1.40	1.60	2.10	14.4
	Outer Back	1.00	1.80	2.60	3.00	19.9
	Seat	1.30	1.50	2.20	2.60	25.5
K73FL2XA	Entire Unit	4.10	7.70	9.20	9.60	80.3
	Inner Back	1.30	2.40	2.80	3.10	25.5
	Outer Back	1.50	2.50	3.00	3.00	29.3
	Seat	1.60	3.10	3.80	4.60	32.1
K73FL3XA	Entire Unit	5.80	11.50	13.50	13.60	115.2
	Inner Back	1.90	3.90	4.70	5.10	38.2
	Outer Back	2.10	3.90	4.70	5.00	41
	Seat	2.50	4.30	5.10	6.10	49.3
K73FL1A, K73FL1ACW, K73FL1ACP, K73FL1ACS	Entire Unit	4.10	6.00	8.00	8.00	80.8
	Inner Back	0.70	1.40	1.60	2.10	14.4
	Outer Back	1.00	1.50	1.70	1.90	19.9
	Seat	1.30	1.80	2.60	3.00	25.5
	Arms	1.90	2.70	3.90	4.70	37.1
K73FL2A, K73FL2ACW, K73FL2ACP, K73FL2ACS	Entire Unit	5.80	9.50	11.70	11.70	115.7
	Inner Back	1.30	2.40	2.80	3.10	25.5
	Outer Back	1.50	2.50	3.00	3.00	29.3
	Seat	1.60	3.10	3.80	4.60	32.1
	Arms	1.90	2.50	3.50	4.20	37.1
K73FL3A, K73FL3ACW, K73FL3ACP, K73FL3ACS	Entire Unit	7.50	13.30	16.00	16.00	150
	Inner Back	1.90	3.90	4.70	5.10	38.2
	Outer Back	2.10	3.90	4.70	5.00	41
	Seat	2.50	4.30	5.10	6.10	49.3
	Arms	1.90	2.50	3.50	4.20	37.1
K73ECBE3212U	Entire Unit	1.50	1.70	2.60	3.20	30.4

EMBRA

