Villa Health

Product Specifications	684
Fabrics and Options	685
Product Pages	687
COM Yardage Requirements	696

VILLA HEALTH PRODUCT SPECIFICATIONS

MOBILE LOUNGE CHAIRS

- Clean out
- 123mm dual wheel casters on front: black
- Non-skid, adjustable glides on back legs
- Rounded handle on back: platinum metallic finish
- EOS^{CU} (Cupron-enhanced EOS) biocidal solid surface arm caps
- Power/USB grommet
- Legs: metal square, round, Y, or wood tapered

MOBILE LOUNGE CHAIRS WITH TABLET ARM

- Clean out
- 123mm dual wheel casters on front: black
- Non-skid, adjustable glides on back legs
- Rounded handle on back: platinum metallic finish
- Tablet arm: HPL or wood
- Tablet arm grommet (NH) to enable tablet arm to be moved to the other arm by user
- Power/USB grommet
- Legs: metal square, round, Y, or wood tapered

LOUNGE CHAIRS, LOVESEATS, SOFAS

- Clean out
- Non-skid, adjustable glides on legs
- EOS^{CU} (Cupron-enhanced EOS) biocidal solid surface arm caps
- Power/USB grommet
- Legs: metal square, round, Y, or wood tapered

LOUNGE CHAIRS, LOVESEATS, SOFAS WITH TABLET ARM

- Clean out
- Non-skid, adjustable glides on legs
- Tablet arm: HPL or wood
- Tablet arm grommet (NH) to enable tablet arm to be moved to the other arm by user
- Power/USB grommet
- Legs: metal square, round, Y, or wood tapered

45° CRESCENT LOUNGE

- Clean out
- Non-skid, adjustable glides on legs

OPTIONAL G55 POWER/USB MODULE

- Single-sided, pneumatic pop-out design: platinum metallic
- 6' cord
- 4" x 5" cut-out

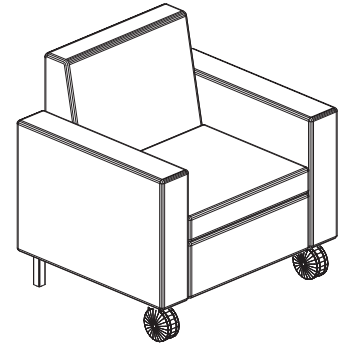

SURFACE MATERIALS

See the Kimball Hospitality Surface Materials Reference Guide at kimballhospitality.com for a complete overview of our materials program, including:

- Characteristics of wood
- Special wood finishes
- Customer specified laminate (CSL)
- Customer specified paint (CSP)
- Fabric application and colorways
- Customer's own material (COM) process overview
- Alliance program

ALLIANCE FABRIC PROGRAM

Kimball Hospitality has analyzed each model to most accurately reflect the COM/COL yardage requirements shown on page 696.

The yardage requirement for each model is based on 54" wide fabric and cutting the fabric up the roll.

If repeat is larger than 18", contact Customer Service to confirm the correct amount of yardage required. When ordering 10 or more chairs in the same COM, yardage requirements may be reduced.

Contact Customer Service.

PRICE GRADES A-R

See Surface Materials at www.kimballhospitality.com for a wide variety of graded-in fabrics from Arc-Com, CF Stinson, Designtex, Maharam, Momentum, and Ultrafabrics.

FABRIC SAMPLES

If you need samples for presentation(s), contact our alliance partners directly at:

Arc-Com	800.223.5466	arc-com.com
Designtex	800.221.1540	designtex.com
CF Stinson	800.841.6279	cfstinson.com
Maharam	800.645.3943	maharam.com
Momentum	800.366.6839	memosamples.com
Ultrafabrics	877.309.6648	ultrafabricsllc.com

ARM CAPS

3D LAMINATE

WOODGRAIN

MC	Amber Cherry
MH	Mocha Cherry
CO	Canyon Straight Grain
DF	Driftwood Straight Grain
YO	Monterey Straight Grain
NW	Tuscan Straight Grain

SOLID SURFACE

STANDARD

405	Designer White
-----	----------------

PREMIUM*

495	EOS ^{CU} Beige
496	EOS ^{CU} Grey
*\$1048 Upcharge	

WOOD

AD	Almond	MH	Mocha
MC	Amber	YO	Monterey
IM	Brighton	PB	Portobello
CO	Canyon	792	Sable
CC	Cordoba	SC	Sedona
DF	Driftwood	TW	Tribeca
ES	Espresso	NW	Tuscan
TM	Huntington	UW	Urban
MW	Midtown		

IMPORTANT: Wood finishes applied to solid hardwood are complementary to the same wood finish applied to wood veneer, but not an exact match
Contact Customer Service for more information

TABLETS

HIGH PRESSURE LAMINATE (HPL)

WOODGRAIN

MC	Amber Cherry
CC	Cordoba Cherry
MH	Mocha Cherry
SC	Sedona Cherry
IM	Brighton Maple
TM	Huntington Maple
MW	Midtown Walnut
TW	Tribeca Walnut
UW	Urban Walnut

SOLID COLOR

480	Antique White
403	Chamois
462	Cinder
440	Cloud
405	Designer White
450	Fog
488	Frosty White
461	Graphite
416	Putty
420	Sandstone
425	Shadow
460	Storm
419	Wallaby

WOOD STRAIGHT GRAIN

AD	Almond Straight Grain
CO	Canyon Straight Grain
DF	Driftwood Straight Grain
YO	Monterey Straight Grain
PB	Portobello Straight Grain
792	Sable Straight Grain
NW	Tuscan Straight Grain

TABLET ARM LOCATION

L	Left as Seated
R	Right as Seated
NH	Non-Handed (\$33 upcharge)
LR	(Loveseats and Sofas) Left and Right as Seated (\$407 upcharge for laminate) (\$437 upcharge for wood)

VILLA HEALTH

CASTERS

42 Black, Hard Dual Wheel

HANDLE

100_PL Round, Platinum Metal

LEG OPTIONS

SQUARE AND ROUND METAL LEGS

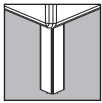

S

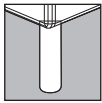

R

SOLID COLOR PAINT

462 Cinder
405 Designer White

METALLIC PAINT

501 Platinum Metallic

Y METAL LEG

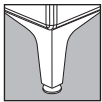

Y

SOLID COLOR PAINT

462 Cinder

METALLIC PAINT

501 Platinum Metallic

NON-PAINT

497 Polished Aluminum

TAPERED WOOD LEG

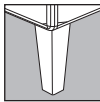

T

WOOD

AD Almond	MH Mocha
MC Amber	YO Monterey
IM Brighton	PB Portobello
CO Canyon	792 Sable
CC Cordoba	SC Sedona
DF Driftwood	TW Tribeca
ES Espresso	NW Tuscan
TM Huntington	UW Urban
MW Midtown	

OPTIONAL G55 POWER/USB MODULE

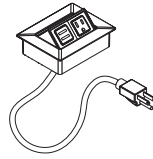

X No Power/USB Module
G55KRPL Left Front as Seated (\$426 upcharge)
G55KRPR Right Front as Seated (\$426 upcharge)
G55KRPLR Left and Right Front (\$852 upcharge)

TO ORDER, SPECIFY:

1. Model Number
2. Back Fabric Grade
3. Back Fabric Number
4. Seat Fabric Grade
5. Seat Fabric Number
6. Arm Fabric Grade
7. Arm Fabric Number
8. Wood Arm Cap Price Group (if applicable)
9. Arm Cap Finish Designator (if applicable)
10. Power/USB Module
11. Casters
12. Handle
13. Leg Option

- See pages 685-686 for Villa Health options
- See page 696 for COM fabric yardage

MOBILE LOUNGE CHAIR

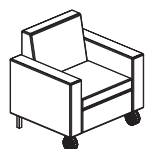

No Arm Caps

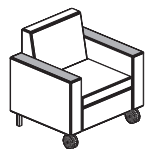

Arm Caps

MODEL NO.

ALLIANCE PROGRAM PRICE GRADES

			A	B	C	D	E	F	G	H	I
			J	K	L	M	N	O	P	Q	R
K6015ACOM	No Arm Caps	\$	2786	2951	3081	3210	3346	3511	3605	3782	3930
			4084	4331	4826	5139	5205	5264	5340	5416	5759
K6015ACOACWM	Wood Arm Caps		3209	3374	3504	3633	3769	3934	4028	4205	4353
			4507	4754	5249	5562	5628	5687	5763	5839	6182
K6015ACOACTM	3D Laminate Arm Caps		3210	3375	3505	3634	3770	3935	4029	4206	4354
			4508	4755	5250	5563	5629	5688	5764	5840	6183
K6015ACOACSM	Solid Surface Arm Caps		3499	3664	3794	3923	4059	4224	4318	4495	4643
			4797	5044	5539	5852	5918	5977	6053	6129	6472

DIMENSIONS

Width	35	Seat Height	18¾	Arm Height		Weight	61
Depth	29	Seat Depth	21½	No Arm Caps	26%	Cubic Ft.	28.70
Height	35¼	Seat Width	24¾	Arm Caps	27%		

- Clean out
- 123mm dual wheel casters on front: black
- Non-skid, adjustable glides on back legs
- Rounded handle on back: platinum metallic finish

VILLA HEALTH

TO ORDER, SPECIFY:

1. Model Number
2. Back Fabric Grade
3. Back Fabric Number
4. Seat Fabric Grade
5. Seat Fabric Number
6. Arm Fabric Grade
7. Arm Fabric Number
8. Wood Arm Cap Price Group (if applicable)
9. Tablet Arm Finish Designator
10. Tablet Arm Location
11. Power/USB Module
12. Casters
13. Handle
14. Leg Option

- See pages 685-686 for Villa Health options
- See page 696 for COM fabric yardage

MOBILE LOUNGE CHAIR WITH TABLET ARM

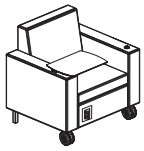

Tablet Arm
Note: Illustration above shows power/USB grommet and non-handed tablet arm grommet options

MODEL NO.

ALLIANCE PROGRAM PRICE GRADES

			A	B	C	D	E	F	G	H	I
			J	K	L	M	N	O	P	Q	R
K6015ACOTLM	HPL Tablet Arm	\$	3195	3360	3490	3619	3755	3920	4014	4191	4339
			4493	4740	5235	5548	5614	5673	5749	5825	6168
K6015ACOTWM	Wood Tablet Arm		3227	3392	3522	3651	3787	3952	4046	4223	4371
			4525	4772	5267	5580	5646	5705	5781	5857	6200

DIMENSIONS

Width	35	Seat Height	18¾	Arm Height	26¾	Weight	69
Depth	29	Seat Depth	21¾			Cubic Ft.	28.70
Height	35¾	Seat Width	24¾				

- Clean out
- 123mm dual wheel casters on front: black
- Non-skid, adjustable glides on back legs
- Rounded handle on back: platinum metallic finish
- Tablet arm location may be specified as: L (left as seated); R (right as seated); or NH (non-handed for a \$33 upcharge)

TO ORDER, SPECIFY:

1. Model Number
2. Back Fabric Grade
3. Back Fabric Number
4. Seat Fabric Grade
5. Seat Fabric Number
6. Arm Fabric Grade
7. Arm Fabric Number
8. Wood Arm Cap Price Group (if applicable)
9. Arm Cap Finish Designator (if applicable)
10. Power/USB Module
11. Leg Option

- See pages 685-686 for Villa Health options
- See page 696 for COM fabric yardage

LOUNGE CHAIR

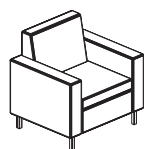

No Arm Caps

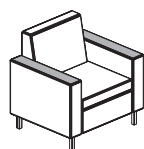

Arm Caps

MODEL NO.

ALLIANCE PROGRAM PRICE GRADES

		A	B	C	D	E	F	G	H	I
		J	K	L	M	N	O	P	Q	R
K6015ACO	No Arm Caps	\$ 2598	2763	2893	3022	3158	3323	3417	3594	3742
		3896	4143	4638	4951	5017	5076	5152	5228	5571
K6015ACOACW	Wood Arm Caps	3019	3184	3314	3443	3579	3744	3838	4015	4163
		4317	4564	5059	5372	5438	5497	5573	5649	5992
K6015ACOACT	3D Laminate Arm Caps	3019	3184	3314	3443	3579	3744	3838	4015	4163
		4317	4564	5059	5372	5438	5497	5573	5649	5992
K6015ACOACS	Solid Surface Arm Caps	3310	3475	3605	3734	3870	4035	4129	4306	4454
		4608	4855	5350	5663	5729	5788	5864	5940	6283

DIMENSIONS

Width	35	Seat Height	18¾	Arm Height		Weight	61
Depth	29	Seat Depth	21½	No Arm Caps	26%	Cubic Ft.	28.70
Height	35¼	Seat Width	24¾	Arm Caps	27%		

- Clean out
- Non-skid, adjustable glides on legs

VILLA HEALTH

TO ORDER, SPECIFY:

1. Model Number
2. Back Fabric Grade
3. Back Fabric Number
4. Seat Fabric Grade
5. Seat Fabric Number
6. Arm Fabric Grade
7. Arm Fabric Number
8. Wood or HPL Price Group
9. Tablet Arm Finish Designator
10. Tablet Arm Location
11. Power/USB Module
12. Leg Option

- See pages 685-686 for Villa Health options
- See page 696 for COM fabric yardage

LOUNGE CHAIR WITH TABLET ARM

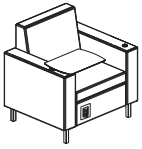

Tablet Arm
Note: Illustration above shows power/USB grommet (on the right as seated) and non-handed tablet arm grommet options

MODEL NO.

ALLIANCE PROGRAM PRICE GRADES

			A	B	C	D	E	F	G	H	I
			J	K	L	M	N	O	P	Q	R
K6015ACOTL	HPL Tablet Arm	\$	3006	3171	3301	3430	3566	3731	3825	4002	4150
			4304	4551	5046	5359	5425	5484	5560	5636	5979
K6015ACOTW	Wood Tablet Arm		3038	3203	3333	3462	3598	3763	3857	4034	4182
			4336	4583	5078	5391	5457	5516	5592	5668	6011

DIMENSIONS

Width	35	Seat Height	18¾	Arm Height	26¾	Weight	69
Depth	29	Seat Depth	21¾			Cubic Ft.	28.70
Height	35¾	Seat Width	24¾				

- Clean out
- Non-skid, adjustable glides on back legs
- Tablet arm location may be specified as: L (left as seated); R (right as seated); or NH (non-handed for a \$33 upcharge)

TO ORDER, SPECIFY:

1. Model Number
2. Back Fabric Grade
3. Back Fabric Number
4. Seat Fabric Grade
5. Seat Fabric Number
6. Arm Fabric Grade
7. Arm Fabric Number
8. Wood Arm Cap Price Group (if applicable)
9. Arm Cap Finish Designator (if applicable)
10. Power/USB Module
11. Leg Option

- See pages 685-686 for Villa Health options
- See page 696 for COM fabric yardage

LOVESEAT

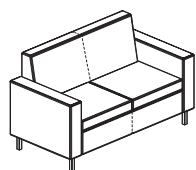

No Arm Caps

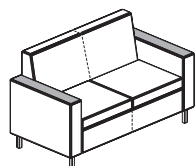

Arm Caps

MODEL NO.

ALLIANCE PROGRAM PRICE GRADES

			A	B	C	D	E	F	G	H	I
			J	K	L	M	N	O	P	Q	R
K6025ACO	No Arm Caps	\$	3438	3646	3808	3970	4140	4348	4467	4689	4874
			5066	5376	5998	6391	6472	6546	6642	6738	7168
K6025ACOACW	Wood Arm Caps		3860	4068	4230	4392	4562	4770	4889	5111	5296
			5488	5798	6420	6813	6894	6968	7064	7160	7590
K6025ACOACT	3D Laminate Arm Caps		3861	4069	4231	4393	4563	4771	4890	5112	5297
			5489	5799	6421	6814	6895	6969	7065	7161	7591
K6025ACOACS	Solid Surface Arm Caps		4147	4355	4517	4679	4849	5057	5176	5398	5583
			5775	6085	6707	7100	7181	7255	7351	7447	7877

DIMENSIONS

Width	58¾	Seat Height	18¾	Arm Height		Weight	83.9
Depth	29	Seat Depth	21½	No Arm Caps	26%	Cubic Ft.	37.40
Height	35¼	Seat Width	48¾	Arm Caps	27%		

- Clean out
- Non-skid, adjustable glides on back legs

VILLA HEALTH

VILLA HEALTH

TO ORDER, SPECIFY:

1. Model Number
2. Back Fabric Grade
3. Back Fabric Number
4. Seat Fabric Grade
5. Seat Fabric Number
6. Arm Fabric Grade
7. Arm Fabric Number
8. Wood or HPL Price Group
9. Tablet Arm Finish Designator
10. Tablet Arm Location
11. Power/USB Module
12. Leg Option

- See pages 685-686 for Villa Health options
- See page 696 for COM fabric yardage

LOVESEAT WITH TABLET ARM

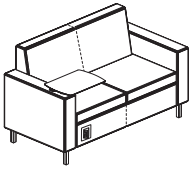

Tablet Arm
Note: Illustration above shows power/USB grommet option (on right as seated)

MODEL NO.

ALLIANCE PROGRAM PRICE GRADES

			A	B	C	D	E	F	G	H	I
			J	K	L	M	N	O	P	Q	R
K6025ACOTL	HPL Tablet Arm	\$	3849	4057	4219	4381	4551	4759	4878	5100	5285
			5477	5787	6409	6802	6883	6957	7053	7149	7579
K6025ACOTW	Wood Tablet Arm		3879	4087	4249	4411	4581	4789	4908	5130	5315
			5507	5817	6439	6832	6913	6987	7083	7179	7609

DIMENSIONS

Width	58¾	Seat Height	18¾	Arm Height	26¾	Weight	91.9
Depth	29	Seat Depth	21¾			Cubic Ft.	37.40
Height	35¾	Seat Width	48¾				

- Clean out
- Non-skid, adjustable glides on back legs
- Tablet arm location may be specified as: L (left as seated); R (right as seated); NH (non-handed for a \$33 upcharge) or LR (left and right as seated). A \$407 upcharge applies for laminate tablet and a \$437 upcharge applies for a wood tablet

TO ORDER, SPECIFY:

1. Model Number
2. Back Fabric Grade
3. Back Fabric Number
4. Seat Fabric Grade
5. Seat Fabric Number
6. Arm Fabric Grade
7. Arm Fabric Number
8. Wood Arm Cap Price Group (if applicable)
9. Arm Cap Finish Designator (if applicable)
10. Power/USB Module
11. Leg Option

- See pages 685-686 for Villa Health options
- See page 696 for COM fabric yardage

SOFA

MODEL NO.

ALLIANCE PROGRAM PRICE GRADES

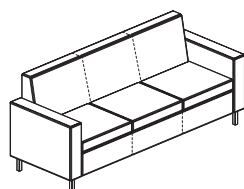

No Arm Caps

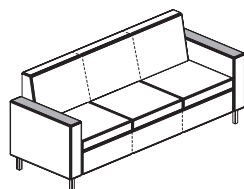

Arm Caps

		A	B	C	D	E	F	G	H	I
		J	K	L	M	N	O	P	Q	R
K6035ACO	No Arm Caps	\$ 4278	4529	4723	4919	5124	5373	5515	5782	6005
		6236	6610	7358	7829	7927	8016	8132	8248	8764
K6035ACOACW	Wood Arm Caps	4701	4952	5146	5342	5547	5796	5938	6205	6428
		6659	7033	7781	8252	8350	8439	8555	8671	9187
K6035ACOACT	3D Laminate Arm Caps	4701	4952	5146	5342	5547	5796	5938	6205	6428
		6659	7033	7781	8252	8350	8439	8555	8671	9187
K6035ACOACS	Solid Surface Arm Caps	4989	5240	5434	5630	5835	6084	6226	6493	6716
		6947	7321	8069	8540	8638	8727	8843	8959	9475

DIMENSIONS

Width	82¾	Seat Height	18¾	Arm Height		Weight	114.8
Depth	29	Seat Depth	21½	No Arm Caps	26%	Cubic Ft.	64.60
Height	35¼	Seat Width	72¼	Arm Caps	27%		

- Clean out
- Non-skid, adjustable glides on back legs

VILLA HEALTH

TO ORDER, SPECIFY:

1. Model Number
2. Back Fabric Grade
3. Back Fabric Number
4. Seat Fabric Grade
5. Seat Fabric Number
6. Arm Fabric Grade
7. Arm Fabric Number
8. Wood or HPL Price Group
9. Tablet Arm Finish Designator
10. Tablet Arm Location
11. Power/USB Module
12. Leg Option

- See pages 685-686 for Villa Health options
- See page 696 for COM fabric yardage

SOFA WITH TABLET ARM

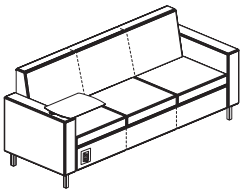

Tablet Arm
Note: Illustration at left shows power/USB grommet option (on right as seated)

MODEL NO.

ALLIANCE PROGRAM PRICE GRADES

			A	B	C	D	E	F	G	H	I
			J	K	L	M	N	O	P	Q	R
K6035ACOTL	HPL Tablet Arm	\$	4687	4938	5132	5328	5533	5782	5924	6191	6414
			6645	7019	7767	8238	8336	8425	8541	8657	9173
K6035ACOTW	Wood Tablet Arm		4718	4969	5163	5359	5564	5813	5955	6222	6445
			6676	7050	7798	8269	8367	8456	8572	8688	9204

DIMENSIONS

Width	82¼	Seat Height	18¾	Arm Height	26¾	Weight	122.8
Depth	29	Seat Depth	21¾			Cubic Ft.	64.60
Height	35½	Seat Width	72¼				

- Clean out
- Non-skid, adjustable glides on back legs
- Tablet arm location may be specified as: L (left as seated); R (right as seated); NH (non-handed for a \$33 upcharge) or LR (left and right as seated). A \$407 upcharge applies for laminate tablet and a \$437 upcharge applies for a wood tablet

TO ORDER, SPECIFY:

1. Model Number
2. Back Fabric Grade
3. Back Fabric Number
4. Seat Fabric Grade
5. Seat Fabric Number
6. Seat Cushion Firmness
7. Power/USB Module
8. Leg Option

- See pages 685-686 for Villa Health options
- See page 696 for COM fabric yardage

45° CRESCENT LOUNGE

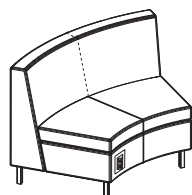

Note: Illustration above shows power/USB grommet option (on right as seated)

MODEL NO.

ALLIANCE PROGRAM PRICE GRADES

			A	B	C	D	E	F	G	H	I
			J	K	L	M	N	O	P	Q	R
K60CCCO	Crescent Lounge	\$	3425	3568	3680	3792	3909	4052	4133	4286	4414
			4547	4761	5189	5459	5516	5567	5633	5699	5995

DIMENSIONS

Width	53	Seat Height	18¾	Weight	112.5
Depth	32	Seat Depth	21¾	Cubic Ft.	51.30
Height	35¼	Seat Width	53		

- Clean out
- Non-skid, adjustable glides on back legs
- Seat cushion firmness - specify STD Standard cushion

COM YARDAGE REQUIREMENTS

COM YARDAGE REQUIREMENTS (54" WIDTH – CUT UP THE ROLL)

MODEL	RAILROADED Contact customer service 800-634-9510 for ydg requirements	NON DIRECTIONAL OR SOLID	1"-4" REPEAT	5"-11" REPEAT	12"-18" REPEAT	COL SQUARE FEET
			4" VERTICAL X 4" HORIZONTAL	11" VERTICAL X 11" HORIZONTAL	18" VERTICAL X 18" HORIZONTAL	
K6015ACOM, K6015ACOACWM, K6015ACOACTM, K6015ACOACSM	Entire Unit	4.70	6.00	7.80	8.80	91
	Back	1.80	1.90	2.10	3.10	33.3
	Base/Seat	1.40	1.50	2.70	3.70	25
	Arms	2.70	2.80	3.80	4.00	51.5
K6015ACOTLM, K6015ACOTWM	Entire Unit	4.70	6.00	7.80	8.80	91
	Back	1.80	1.90	2.10	3.10	33.3
	Base/Seat	1.40	1.50	2.70	3.70	25
	Arms	2.70	2.80	3.80	4.00	51.5
K6015ACO, K6015ACOACW, K6015ACOACT, K6015ACOACS	Entire Unit	4.70	6.00	7.80	8.80	91
	Back	1.80	1.90	2.10	3.10	33.3
	Base/Seat	1.40	1.50	2.70	3.70	25
	Arms	2.70	2.80	3.80	4.00	51.5
K6015ACOTL, K6015ACOTW	Entire Unit	4.70	6.00	7.80	8.80	91
	Back	1.80	1.90	2.10	3.10	33.3
	Base/Seat	1.40	1.50	2.70	3.70	25
	Arms	2.70	2.80	3.80	4.00	51.5
K6025ACO, K6025ACOACW, K6025ACOACT, K6025ACOACS	Entire Unit	5.90	9.10	11.80	12.30	117
	Back	2.60	4.70	5.50	5.50	62.5
	Base/Seat	2.10	3.00	4.50	6.20	40
	Arms	2.70	2.80	3.80	4.00	51.5
K6025ACOTL, K6025ACOTW	Entire Unit	5.90	9.10	11.80	12.30	117
	Back	2.60	4.70	5.50	5.50	62.5
	Base/Seat	2.10	3.00	4.50	6.20	40
	Arms	2.70	2.80	3.80	4.00	51.5
K6035ACO, K6035ACOACW, K6035ACOACT, K6035ACOACS	Entire Unit	7.70	12.30	15.20	17.20	151
	Back	3.30	5.20	5.80	7.10	63
	Base/Seat	2.90	4.30	6.30	8.70	57
	Arms	2.70	2.80	3.80	4.00	51.5
K6035ACOTL, K6035ACOTW	Entire Unit	7.70	12.30	15.20	17.20	151
	Back	3.30	5.20	5.80	7.10	63
	Base/Seat	2.90	4.30	6.30	8.70	57
	Arms	2.70	2.80	3.80	4.00	51.5
K60CCCO	Entire Unit	4.30	5.30	6.90	8.70	83.5
	Back	3.40	3.50	3.90	4.50	66.5
	Base/Seat	2.90	4.30	6.30	8.70	57