Pairings Health

Product Specifications	460
Fabrics and Options	461
Contrasting Fabrics Specifications	464
Product Pages	466
COM Yardage Requirements	488

PAIRINGS HEALTH PRODUCT SPECIFICATIONS

FRAME CONSTRUCTION

- Frame is constructed of plywood, using a lap-joint construction method
- Frames are glued and screwed

SEAT CONSTRUCTION

- Seats feature a high tension, strip webbing suspension that is stapled to the frame
- Seat upholstery features a wrap-around upholstery method and is stapled into place
- Clean out design allows for easy clean up of debris or liquids
- Clean out space does not detract from the aesthetic or function of the lounge

CUSHIONS

- Cushions are made of high grade, high resiliency, CFC-free, laminated polyurethane foam
- Seat cushions are 2¾" thick
- Back cushions are 2" thick and upholstered using the slipcover method and finished with French seams:
 - Double stitch seams in center (27" wide segments)
 - Single French seams at sides of lounge to create double stitch appearance when joined with other lounge units

CONTRASTING FABRIC

- Contrasting fabric may be specified for back, seat, and arms.
- While seat and back upholstery will align on a unit, there is no guarantee that individual models will align when attached to each other
- Fabrics reflect light differently when viewed at various angles, creating a natural phenomenon called "flip." Flip is visible on all fabrics and is not considered a defect; it is more easily recognized on fabrics with a nap or shimmer

ARMS

- Arm tops and outside panels feature ¾"-thick, high grade polyurethane foam
- Arms feature a sewn slipcover with French seams that is stapled into place

TECH ARM

- Models with tech arm feature an HPL with phenolic core tablet on an articulating arm

POWER/USB

- Power/USB modules are available on left, right, or left and right kickrail as well as left, right, or left and right front of arm on 8" and tech arms. See page 463

LEGS

- Legs are 9¼" high and available in two shapes:
 - Metal spider leg
 - Round wood leg (upcharge applies)
- Non-skid, adjustable glides are 2" in diameter

HANDING DESIGNATION (LEFT OR RIGHT OF UNIT)

- Determined from the user's perspective when seated

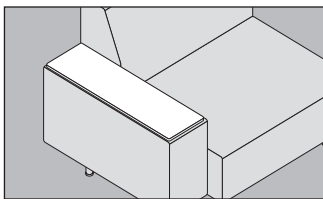
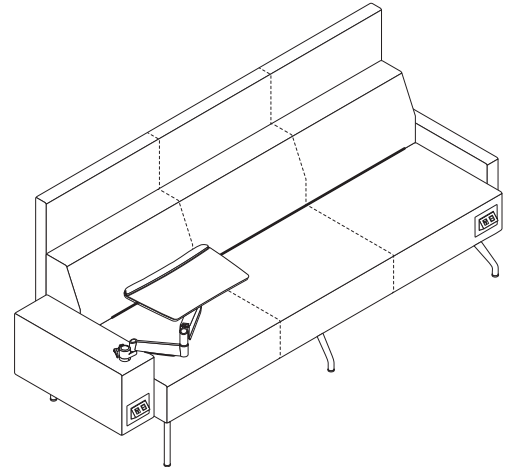

Arm caps

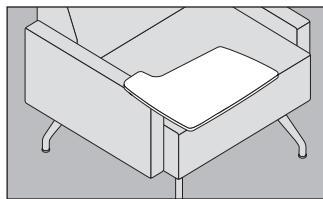

Tablet arms

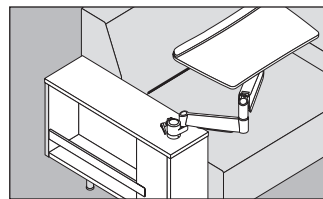

Storage tech arm

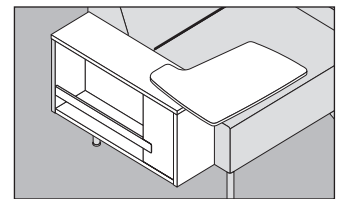

Storage tablet arm

FABRIC APPLICATION DIAGRAMS

90° CORNERS:

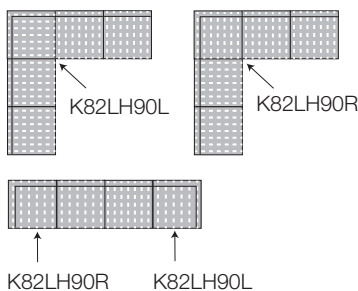

CORNER BENCHES:

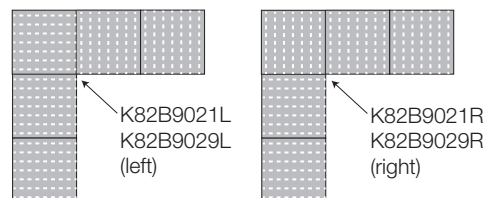

SURFACE MATERIALS

See the Kimball Hospitality Surface Materials Reference Guide at kimballhospitality.com for a complete overview of our materials program, including:

- Characteristics of wood
- Special wood finishes
- Customer specified laminate (CSL)
- Customer specified paint (CSP)
- Fabric application and colorways
- Customer's own material (COM) process overview
- Alliance program

ALLIANCE FABRIC PROGRAM

Kimball Hospitality has analyzed each model to most accurately reflect the COM/COL yardage requirements shown on page 488.

The yardage requirement for each model is based on 54" wide fabric and cutting the fabric up the roll.

If repeat is larger than 18", contact Customer Service to confirm the correct amount of yardage required. When ordering 10 or more chairs in the same COM, yardage requirements may be reduced.

Contact Customer Service.

PRICE GRADES A-R

See Surface Materials at www.kimballhospitality.com for a wide variety of graded-in fabrics from Arc-Com, CF Stinson, Designtex, Maharam, Momentum, and Ultrafabrics.

FABRIC SAMPLES

If you need samples for presentation(s), contact our alliance partners directly at:

Arc-Com	800.223.5466	arc-com.com
Designtex	800.221.1540	designtex.com
CF Stinson	800.841.6279	cfstinson.com
Maharam	800.645.3943	maharam.com
Momentum	800.366.6839	memosamples.com
Ultrafabrics	877.309.6648	ultrafabricsllc.com

ARM CAPS

3D LAMINATE

WOODGRAIN	SOLID	PATTERN
MC Amber Cherry	480 Antique White	484 Cashmere Fiber
MH Mocha Cherry	462 Cinder	466 Concrete Fiber
	440 Cloud	
CO Canyon Straight Grain	405 Designer White	
DF Driftwood Straight Grain	450 Fog	
YO Monterey Straight Grain	420 Sandstone	
NW Tuscan Straight Grain		

SOLID SURFACE

405 Designer White

WOOD

AD Almond	MH Mocha
MC Amber	YO Monterey
IM Brighton	PB Portobello
CO Canyon	792 Sable
CC Cordoba	SC Sedona
DF Driftwood	TW Tribeca
ES Espresso	NW Tuscan
TM Huntington	UW Urban
MW Midtown	

TABLET TOPS

3D LAMINATE

WOODGRAIN	SOLID	PATTERN
MC Amber Cherry	480 Antique White	484 Cashmere Fiber
MH Mocha Cherry	462 Cinder	466 Concrete Fiber
	440 Cloud	
CO Canyon Straight Grain	405 Designer White	
DF Driftwood Straight Grain	450 Fog	
YO Monterey Straight Grain	420 Sandstone	
NW Tuscan Straight Grain		

TABLET / TECH ARM TABLET

HIGH PRESSURE LAMINATE (HPL)

WOODGRAIN	WOOD STRAIGHT GRAIN
MC Amber Cherry	AD Almond Straight Grain
CC Cordoba Cherry	CO Canyon Straight Grain
MH Mocha Cherry	DF Driftwood Straight Grain
SC Sedona Cherry	YO Monterey Straight Grain
	PB Portobello Straight Grain
IM Brighton Maple	792 Sable Straight Grain
TM Huntington Maple	NW Tuscan Straight Grain
MW Midtown Walnut	
TW Tribeca Walnut	
UW Urban Walnut	

SOLID

480	Antique White
403	Chamois
462	Cinder
405	Designer White

LEGS

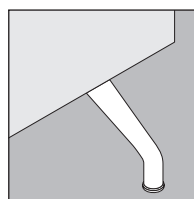

SPIDER LEG

No designator
(No upcharge)

FINISHES

494	Brushed Aluminum
497	Polished Aluminum

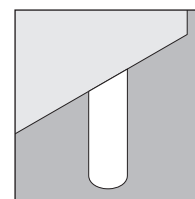

ROUND LEG

Designator = **R**
(+\$104 per model)

WOOD

AD Almond	MH Mocha
MC Amber	YO Monterey
IM Brighton	PB Portobello
CO Canyon	792 Sable
CC Cordoba	SC Sedona
DF Driftwood	TW Tribeca
ES Espresso	NW Tuscan
TM Huntington	UW Urban
MW Midtown	

For round leg option, specify the leg designator and finish designator together in one step.

Examples:

RMC = Round wood leg in Amber
RUW = Round wood leg in Urban

IMPORTANT: Wood finishes applied to solid hardwood are complementary to the same wood finish applied to wood veneer, but not an exact match
Contact Customer Service for more information

PAIRINGS HEALTH

ARM CAPS

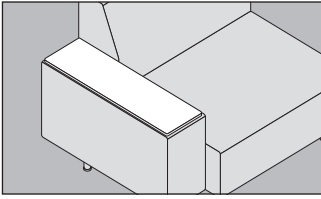

Arm cap substitution, when desired, must be made for each arm, and *must be the same* on both arms for models with arms on both sides (regardless if it is 2", 8", 8" tech arm, or a combination)

For example:

K82LH32L**AU**2**RAU**PFB would become K82LH32L**AW**2**RAW**PFB to add wood arm caps on both arms

IMPORTANT: Upcharges listed are per arm.

Handing designation (left or right of unit) is determined from the user's perspective when seated

TABLE ARMS

Tablet arm substitution is available on select models. See individual pricing page for availability by model

Tablet arms are available on both arms of two and three seat models with 8" arms only; tablet materials must match

Tablet arm/arm cap combinations are only available in the combinations at below and at right

Tablet arms are mounted to upholstered arms

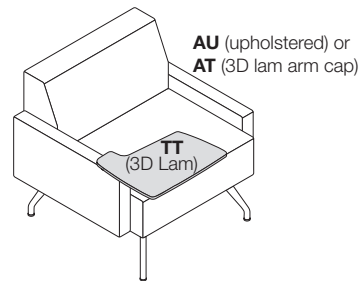
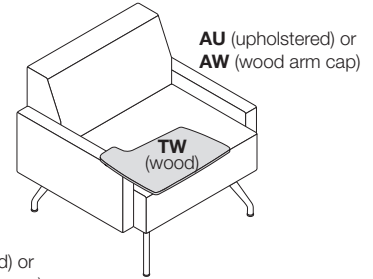
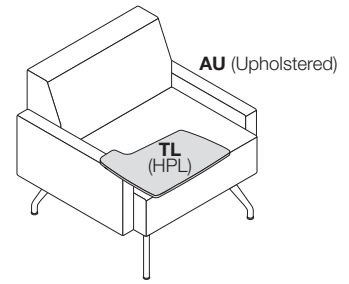

HOW TO SPECIFY

DESCRIPTION	HOW TO SPECIFY	ON 2" ARM (PER ARM)	ON 8" ARM (PER ARM)	ON 8" TECH ARM (PER ARM)
ARM CAPS				
3D laminate arm cap	Substitute AT for AU in model	+\$46	+\$56	+\$56
Wood arm cap	Substitute AW for AU in model	+\$71	+\$86	+\$86
Solid surface arm cap	Substitute AS for AU in model	+\$92	+\$116	+\$116
TABLET ARMS				
3D laminate tablet	Substitute TT for AU in model	+\$103	+\$127	—
HPL tablet with phenolic core	Substitute TL for AU in model	+\$288	+\$358	—
Wood tablet	Substitute TW for AU in model	+\$300	+\$369	—

FACTORY-INSTALLED POWER/USB OPTIONS FOR LOUNGE SEATING

KICKRAIL POWER/USB:

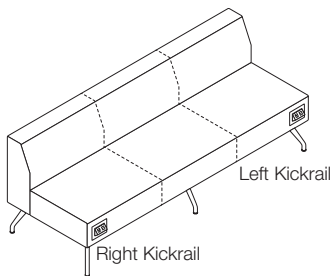
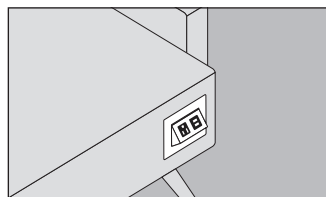

ARM POWER/USB:

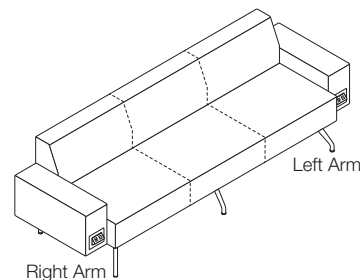
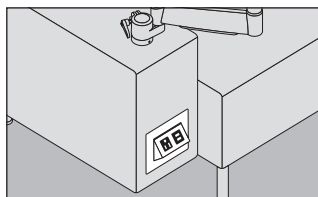

HOW TO SPECIFY

1. Insert the power module designator in applicable step in the model number sequence

LOCATION	OPTION DESIGNATORS	OPTION DESIGNATORS	UPCHARGE
	KICK RAIL POWER/USB	8" OR TECH ARM POWER/USB	
Left front (as seated)	G55KRPL	G55APL	+\$406
	G56KRPL	G56APL	+\$434
Right front (as seated)	G55KRPR	G55APR	+\$406
	G56KRPR	G56APR	+\$434
Left and right front (as seated)	G55KRPLR	G55APLR	+\$812
	G56KRPLR	G56APLR	+\$868

IMPORTANT: Specify based on connector type, cord length and circuit configuration:

- G55** 6' cord with three-prong plug
- G56** 10' cord with three-prong plug

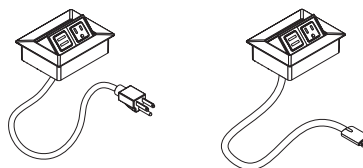

Power/USB modules feature a single-sided, pneumatic pop-out. Actual cut-out size is for 4" x 5". Modules are painted in platinum metallic

Handing designation (left or right of unit) is determined from the user's perspective when seated

TO ORDER CONTRASTING FABRIC, SPECIFY

PAIRINGS HEALTH

Armless Lounge page 466

Corner & Crescent page 484

1. Model Number plus "X"
2. Back Fabric Grade
3. Back Fabric Number
4. Seat Fabric Grade
5. Seat Fabric Number
6. Kickrail Power/USB Option
7. Leg Option



Contrasting Fabric may be specified on seat and back

One Seat Lounge, 2" Arms page 467

Two Seat Lounge 2" Arms page 477

Three Seat Lounge 2" Arms page 481

1. Model Number plus "X"
2. Back Fabric Grade
3. Back Fabric Number
4. Seat Fabric Grade
5. Seat Fabric Number
6. Arm Fabric Grade
7. Arm Fabric Number
8. Arm Cap or Tablet Arm Finish Price Group (if applicable)
9. Arm Cap or Tablet Arm Finish Designator (if applicable)
10. Kickrail Power/USB Option
11. Leg Option



Contrasting Fabric may be specified on seat, back, and arm

One Seat Lounge 8" Arms page 468

Two Seat Lounge 8" Arms page 478

1. Model Number plus "X"
2. Back Fabric Grade
3. Back Fabric Number
4. Seat Fabric Grade
5. Seat Fabric Number
6. Arm Fabric Grade
7. Arm Fabric Number
8. Arm Cap or Tablet Arm Finish Price Group (if applicable)
9. Arm Cap or Tablet Arm Finish Designator (if applicable)
10. Kickrail Power/USB Option
11. Arm Power/USB Option
12. Leg Option



Contrasting Fabric may be specified on seat, back, and arm

One Seat Lounge Tech Arm Left page 469

One Seat Lounge Tech Arm Right page 470

Two Seat Lounge Tech Arm Left or Both Sides page 479

Two Seat Lounge Tech Arm Right page 480

Three Seat Lounge Tech Arm Left or Both Sides page 482

Three Seat Lounge Tech Arm Right page 483

1. Model Number plus "X"
2. Back Fabric Grade
3. Back Fabric Number
4. Seat Fabric Grade
5. Seat Fabric Number
6. Arm Fabric Grade
7. Arm Fabric Number
8. Arm Cap Finish Price Group (if applicable)
9. Arm Cap Finish Designator (if applicable)
10. Tech Tablet Laminate Price Group
11. Tech Tablet Laminate Designator
12. Kickrail Power/USB Option
13. Arm Power/USB Option
14. Leg Option



Contrasting Fabric may be specified on seat, back, and arm

One Seat Lounge TFL Storage Tech Arm Left page 471
One Seat Lounge TFL Storage Tech Arm Right page 472

1. Model Number plus "X"
2. Back Fabric Grade
3. Back Fabric Number
4. Seat Fabric Grade
5. Seat Fabric Number
6. Arm Fabric Grade (2" or 8" arm only)
7. Arm Fabric Number (2" or 8" arm only)
8. Tech Tablet HPL Price Group
9. Tech Tablet HPL Designator
10. Storage TFL Designator
11. Kickrail Power/USB Option
12. Arm Power/USB Option
13. Leg Option



Contrasting Fabric may be specified on seat, back, and arms

One Seat Lounge Wood Storage Tech Arm Left page 473
One Seat Lounge Wood Storage Tech Arm Right page 474

1. Model Number plus "X"
2. Back Fabric Grade
3. Back Fabric Number
4. Seat Fabric Grade
5. Seat Fabric Number
6. Arm Fabric Grade (2" or 8" arm only)
7. Arm Fabric Number (2" or 8" arm only)
8. Tech Tablet HPL Price Group
9. Tech Tablet HPL Designator
10. Storage Wood Price Group
11. Storage Wood Finish Designator
12. Kickrail Power/USB Option
13. Arm Power/USB Option
14. Leg Option



Contrasting Fabric may be specified on seat, back, and arm

One Seat Lounge TFL Storage Tablet Arm Left or Right page 475

1. Model Number plus "X"
2. Back Fabric Grade
3. Back Fabric Number
4. Seat Fabric Grade
5. Seat Fabric Number
6. Tablet HPL or Wood Price Group
7. Tablet Finish Designator
8. Storage TFL Designator
9. Kickrail Power/USB Option
10. Arm Power/USB Option
11. Leg Option



Contrasting Fabric may be specified on seat, back, and arm

One Seat Lounge Wood Storage Tablet Arm Left or Right page 476

1. Model Number plus "X"
2. Back Fabric Grade
3. Back Fabric Number
4. Seat Fabric Grade
5. Seat Fabric Number
6. Tablet HPL Price Group (HPL only)
7. Tablet Finish Designator (3D laminate and HPL only)
8. Storage Wood Price Group
9. Storage Wood Designator
10. Kickrail Power/USB Option
11. Arm Power/USB Option
12. Leg Option



Contrasting Fabric may be specified on seat, back, and arm

PAIRINGS HEALTH

TO ORDER, SPECIFY

1. Model Number
2. Back Fabric Grade
3. Back Fabric Number
4. Seat Fabric Grade
5. Seat Fabric Number
6. Kickrail Power/USB Option
7. Leg Option

• See pages 461-463 for Pairings Health options
 See pages 488-507 for COM fabric yardage

ARMLESS LOUNGE

MODEL NO.

ALLIANCE PROGRAM PRICE GRADES



One Seat

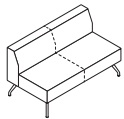

Two Seat

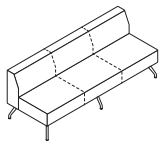

Three Seat

			A	B	C	D	E	F	G	H	I
			J	K	L	M	N	O	P	Q	R
K82LH1	One Seat	\$	1968	2069	2146	2224	2306	2402	2461	2565	2653
			2745	2893	3189	3374	3416	3448	3497	3541	3744
K82LH2	Two Seat		2738	2898	3022	3145	3276	3429	3524	3689	3830
			3977	4213	4685	4980	5046	5098	5176	5246	5570
K82LH3	Three Seat		3825	4060	4242	4426	4617	4843	4982	5226	5435
			5652	6000	6696	7131	7227	7305	7418	7523	8001

DIMENSIONS - ONE SEAT

Width	27	Seat Height	18	Weight	38.50
Depth	29	Seat Depth	21	Cubic Ft.	13.50
Height	30	Seat Width	27		

DIMENSIONS - TWO SEAT

Width	54	Seat Height	18	Weight	60.20
Depth	29	Seat Depth	21	Cubic Ft.	36.50
Height	30	Seat Width	54		

DIMENSIONS - THREE SEAT

Width	81	Seat Height	18	Weight	85.70
Depth	29	Seat Depth	21	Cubic Ft.	54.20
Height	30	Seat Width	81		

- Contrasting fabric option – specify X (i.e., K82LH1X); see page 464. For list pricing, use your electronic specification tool or contact customer service
- Kickrail power/USB
- Leg options

TO ORDER, SPECIFY

1. Model Number
2. Back Fabric Grade
3. Back Fabric Number
4. Seat Fabric Grade
5. Seat Fabric Number
6. Arm Fabric Grade
7. Arm Fabric Number
8. Arm Cap or Tablet Arm Finish Price Group (if applicable)
9. Arm Cap or Tablet Arm Finish Designator (if applicable)
10. Kickrail Power/USB Option
11. Leg Option

• See pages 461-463 for Pairings Health options
 See pages 488-507 for COM fabric yardage

**ONE SEAT LOUNGE
 2" ARMS**



Left Arm



Right Arm



Left and Right Arms

**MODEL
 NO.**

ALLIANCE PROGRAM PRICE GRADES

		A	B	C	D	E	F	G	H	I
		J	K	L	M	N	O	P	Q	R
K82LH12LAU	2" Arm Left	\$ 2352	2480	2578	2677	2781	2903	2978	3110	3222
		3339	3527	3903	4138	4191	4232	4294	4350	4608
K82LH12RAU	2" Arm Right	2352	2480	2578	2677	2781	2903	2978	3110	3222
		3339	3527	3903	4138	4191	4232	4294	4350	4608
K82LH12LAU2RAU	2" Arms Left and Right	2729	2881	2998	3116	3240	3385	3474	3632	3765
		3905	4129	4577	4857	4920	4969	5042	5109	5417

DIMENSIONS

Width - L or R	29	Seat Height	18	Arm Height	22	Weight - L or R	38.50
Width - L and R	31	Seat Depth	21	Arm Depth	26	Weight - L and R	49.70
Depth	29	Seat Width	27	Arm Width	2	Cubic Ft. - L or R	13.50
Height	30					Cubic Ft. - L and R	14.70

- Contrasting fabric option – specify X (i.e., K82LH12LAUX); see page 464. For list pricing, use your electronic specification tool or contact customer service
- Arm options
- Kickrail power/USB
- Leg options

PAIRINGS HEALTH

TO ORDER, SPECIFY

1. Model Number
2. Back Fabric Grade
3. Back Fabric Number
4. Seat Fabric Grade
5. Seat Fabric Number
6. Arm Fabric Grade
7. Arm Fabric Number
8. Arm Cap or Tablet Arm Finish Price Group (if applicable)
9. Arm Cap or Tablet Arm Finish Designator (if applicable)
10. Kickrail Power/USB Option
11. Arm Power/USB Option
12. Leg Option

• See pages 461-463 for Pairings Health options
See pages 488-507 for COM fabric yardage

ONE SEAT LOUNGE 8" ARMS



Left Arm



Right Arm

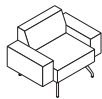

Left and Right Arms

MODEL NO.

ALLIANCE PROGRAM PRICE GRADES

			A	B	C	D	E	F	G	H	I
			J	K	L	M	N	O	P	Q	R
K82LH18LAU	8" Arm Left	\$	2429	2557	2655	2754	2858	2980	3055	3187	3299
			3416	3604	3980	4215	4268	4309	4371	4427	4685
K82LH18RAU	8" Arm Right		2429	2557	2655	2754	2858	2980	3055	3187	3299
			3416	3604	3980	4215	4268	4309	4371	4427	4685
K82LH18LAU8RAU	8" Arms Left and Right		2882	3034	3151	3269	3393	3538	3627	3785	3918
			4058	4282	4730	5010	5073	5122	5195	5262	5570

DIMENSIONS

Width - L or R	35	Seat Height	18	Arm Height	22	Weight - L or R	50.50
Width - L and R	43	Seat Depth	21	Arm Depth	26	Weight - L and R	59.00
Depth	29	Seat Width	27	Arm Width	8	Cubic Ft. - L or R	15.10
Height	30					Cubic Ft. - L and R	17.00

- Contrasting fabric option – specify X (i.e., K82LH18LAUX); see page 464. For list pricing, use your electronic specification tool or contact customer service
- Arm options
- Kickrail power/USB
- Arm Power/USB
- Leg options

TO ORDER, SPECIFY

1. Model Number
2. Back Fabric Grade
3. Back Fabric Number
4. Seat Fabric Grade
5. Seat Fabric Number
6. Arm Fabric Grade
7. Arm Fabric Number
8. Arm Cap Finish Price Group
(if applicable)
9. Arm Cap Finish Designator
(if applicable)
10. Tech Tablet Laminate Price Group
11. Tech Tablet Laminate Designator
12. Kickrail Power/USB Option
13. Arm Power/USB Option
14. Leg Option

• See pages 461-463 for Pairings Health options
See pages 488-507 for COM fabric yardage

**ONE SEAT LOUNGE
TECH ARM LEFT**



2" Arm Right



8" Arm Right

**MODEL
NO.**

ALLIANCE PROGRAM PRICE GRADES

			A	B	C	D	E	F	G	H	I
			J	K	L	M	N	O	P	Q	R
K82LH1TLAU		\$	3216	3344	3442	3541	3645	3767	3842	3974	4086
			4203	4391	4767	5002	5055	5096	5158	5214	5472
K82LH1TLAU2RAU	2" Arm Right		3596	3748	3865	3983	4107	4252	4341	4499	4632
			4772	4996	5444	5724	5787	5836	5909	5976	6284
K82LH1TLAU8RAU	8" Arm Right		3671	3823	3940	4058	4182	4327	4416	4574	4707
			4847	5071	5519	5799	5862	5911	5984	6051	6359

DIMENSIONS

Width	35	Seat Height	18	Arm Height	22	Weight	53.70
Depth	29	Seat Depth	21	Arm Depth	26	Cubic Ft.	15.10
Height	30	Seat Width	27	Arm Width	8		

DIMENSIONS - 2" ARM RIGHT

Width	37	Seat Height	18	Arm Height	22	Weight	64.30
Depth	29	Seat Depth	21	Arm Depth	26	Cubic Ft.	15.70
Height	30	Seat Width	27	Arm Width	8		

DIMENSIONS - 8" ARM RIGHT

Width	43	Seat Height	18	Arm Height	22	Weight	66.60
Depth	29	Seat Depth	21	Arm Depth	26	Cubic Ft.	17.00
Height	30	Seat Width	27	Arm Width	8		

- Contrasting fabric option – specify X (i.e., K82LH1TLAUX); see page 464. For list pricing, use your electronic specification tool or contact customer service
- Arm options
- Kickrail power/USB
- Arm power/USB
- Leg options

PAIRINGS HEALTH

TO ORDER, SPECIFY

1. Model Number
2. Back Fabric Grade
3. Back Fabric Number
4. Seat Fabric Grade
5. Seat Fabric Number
6. Arm Fabric Grade
7. Arm Fabric Number
8. Arm Cap Finish Price Group (if applicable)
9. Arm Cap Finish Designator (if applicable)
10. Tech Tablet Laminate Price Group
11. Tech Tablet Laminate Designator
12. Kickrail Power/USB Option
13. Arm Power/USB Option
14. Leg Option

• See pages 461-463 for Pairings Health options
See pages 488-507 for COM fabric yardage

ONE SEAT LOUNGE TECH ARM RIGHT



2" Arm Left



8" Arm Left

MODEL NO.

ALLIANCE PROGRAM PRICE GRADES

		ALLIANCE PROGRAM PRICE GRADES								
		A	B	C	D	E	F	G	H	I
		J	K	L	M	N	O	P	Q	R
K82LH1TRAU		\$ 3216	3344	3442	3541	3645	3767	3842	3974	4086
K82LH12LAUTRAU	2" Arm Left	4203	4391	4767	5002	5055	5096	5158	5214	5472
K82LH18LAUTRAU	8" Arm Left	3596	3748	3865	3983	4107	4252	4341	4499	4632
		4772	4996	5444	5724	5787	5836	5909	5976	6284
		3671	3823	3940	4058	4182	4327	4416	4574	4707
		4847	5071	5519	5799	5862	5911	5984	6051	6359

DIMENSIONS

Width	35	Seat Height	18	Arm Height	22	Weight	48.60
Depth	29	Seat Depth	21	Arm Depth	26	Cubic Ft.	15.10
Height	30	Seat Width	27	Arm Width	8		

DIMENSIONS - 2" ARM LEFT

Width	37	Seat Height	18	Arm Height	22	Weight	64.30
Depth	29	Seat Depth	21	Arm Depth	26	Cubic Ft.	15.70
Height	30	Seat Width	27	Arm Width	8		

DIMENSIONS - 8" ARM RIGHT

Width	43	Seat Height	18	Arm Height	22	Weight	66.60
Depth	29	Seat Depth	21	Arm Depth	26	Cubic Ft.	17.00
Height	30	Seat Width	27	Arm Width	8		

- Contrasting fabric option – specify X (i.e., K82LH1TRAUX); see page 464. For list pricing, use your electronic specification tool or contact customer service
- Arm options
- Kickrail power/USB
- Arm power/USB
- Leg options

TO ORDER, SPECIFY

1. Model Number
2. Back Fabric Grade
3. Back Fabric Number
4. Seat Fabric Grade
5. Seat Fabric Number
6. Arm Fabric Grade (2" or 8" arm only)
7. Arm Fabric Number (2" or 8" arm only)
8. Tech Tablet HPL Price Group
9. Tech Tablet HPL Designator
10. Storage TFL Designator
11. Kickrail Power/USB Option
12. Arm Power/USB Option
13. Leg Option

• See pages 461-463 for Pairings Health options
 See pages 488-507 for COM fabric yardage

**ONE SEAT LOUNGE
 TFL STORAGE
 TECH ARM LEFT**



2" Arm Right

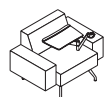

8" Arm Right

MODEL NO.

ALLIANCE PROGRAM PRICE GRADES

		A	B	C	D	E	F	G	H	I
		J	K	L	M	N	O	P	Q	R
K82LH1TLLLS	\$	3243	3344	3421	3499	3581	3677	3736	3840	3928
		4020	4168	4464	4649	4691	4723	4772	4816	5019
K82LH1TLLLS2RAU	2" Arm Right	4116	4244	4342	4441	4545	4667	4742	4874	4986
		5103	5291	5667	5902	5955	5996	6058	6114	6372
K82LH1TLLLS8RAU	8" Arm Right	4193	4321	4419	4518	4622	4744	4819	4951	5063
		5180	5368	5744	5979	6032	6073	6135	6191	6449

DIMENSIONS

Width	35	Seat Height	18	Arm Height	22	Weight	48.60
Depth	29	Seat Depth	21	Arm Depth	26	Cubic Ft.	15.10
Height	30	Seat Width	27	Arm Width	8		

DIMENSIONS - 2" ARM RIGHT

Width	37	Seat Height	18	Arm Height	22	Weight	64.30
Depth	29	Seat Depth	21	Arm Depth	26	Cubic Ft.	15.70
Height	30	Seat Width	27	Arm Width	8		

DIMENSIONS - 8" ARM RIGHT

Width	43	Seat Height	18	Arm Height	22	Weight	59.00
Depth	29	Seat Depth	21	Arm Depth	26	Cubic Ft.	17.00
Height	30	Seat Width	27	Arm Width	8		

- Contrasting fabric option – specify X (i.e., K82LH1TLLLSX); see page 465. For list pricing, use your electronic specification tool or contact customer service
- Kickrail power/USB
- Arm power/USB
- Leg options

PAIRINGS HEALTH

TO ORDER, SPECIFY

1. Model Number
2. Back Fabric Grade
3. Back Fabric Number
4. Seat Fabric Grade
5. Seat Fabric Number
6. Arm Fabric Grade (2" or 8" arm only)
7. Arm Fabric Number (2" or 8" arm only)
8. Tech Tablet HPL Price Group
9. Tech Tablet HPL Designator
10. Storage TFL Designator
11. Kickrail Power/USB Option
12. Arm Power/USB Option
13. Leg Option

• See pages 461-463 for Pairings Health options
See pages 488-507 for COM fabric yardage

ONE SEAT LOUNGE TFL STORAGE TECH ARM RIGHT

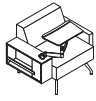
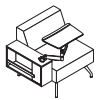

2" Arm Left

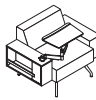

8" Arm Left

MODEL NO.

ALLIANCE PROGRAM PRICE GRADES

		A	B	C	D	E	F	G	H	I
		J	K	L	M	N	O	P	Q	R
K82LH1TRLLS	\$	3243	3344	3421	3499	3581	3677	3736	3840	3928
		4020	4168	4464	4649	4691	4723	4772	4816	5019
K82LH12LAUTRLLS	2" Arm Left	4116	4244	4342	4441	4545	4667	4742	4874	4986
		5103	5291	5667	5902	5955	5996	6058	6114	6372
K82LH18LAUTRLLS	8" Arm Left	4193	4321	4419	4518	4622	4744	4819	4951	5063
		5180	5368	5744	5979	6032	6073	6135	6191	6449

DIMENSIONS

Width	35	Seat Height	18	Arm Height	22	Weight	48.60
Depth	29	Seat Depth	21	Arm Depth	26	Cubic Ft.	15.10
Height	30	Seat Width	27	Arm Width	8		

DIMENSIONS - 2" ARM LEFT

Width	37	Seat Height	18	Arm Height	22	Weight	64.30
Depth	29	Seat Depth	21	Arm Depth	26	Cubic Ft.	15.70
Height	30	Seat Width	27	Arm Width	8		

DIMENSIONS - 8" ARM LEFT

Width	43	Seat Height	18	Arm Height	22	Weight	59.00
Depth	29	Seat Depth	21	Arm Depth	26	Cubic Ft.	17.00
Height	30	Seat Width	27	Arm Width	8		

- Contrasting fabric option – specify X (i.e., H82LH1TRLLSX); see page 465. For list pricing, use your electronic specification tool or contact customer service
- Kickrail power/USB
- Arm power/USB
- Leg options

TO ORDER, SPECIFY

1. Model Number
2. Back Fabric Grade
3. Back Fabric Number
4. Seat Fabric Grade
5. Seat Fabric Number
6. Arm Fabric Grade (2" or 8" arm only)
7. Arm Fabric Number (2" or 8" arm only)
8. Tech Tablet HPL Price Group
9. Tech Tablet HPL Designator
10. Storage Wood Price Group
11. Storage Wood Finish Designator
12. Kickrail Power/USB Option
13. Arm Power/USB Option
14. Leg Option

• See pages 461-463 for Pairings Health options
See pages 488-507 for COM fabric yardage

**ONE SEAT LOUNGE
WOOD STORAGE
TECH ARM LEFT**



2" Arm Right



8" Arm Right

**MODEL
NO.**

ALLIANCE PROGRAM PRICE GRADES

		A	B	C	D	E	F	G	H	I
		J	K	L	M	N	O	P	Q	R
K82LH1TLWS	\$	3335	3436	3513	3591	3673	3769	3828	3932	4020
		4112	4260	4556	4741	4783	4815	4864	4908	5111
K82LH1TLWS2RAU	2" Arm Right	4234	4362	4460	4559	4663	4785	4860	4992	5104
		5221	5409	5785	6020	6073	6114	6176	6232	6490
K82LH1TLWS8RAU	8" Arm Right	4312	4440	4538	4637	4741	4863	4938	5070	5182
		5299	5487	5863	6098	6151	6192	6254	6310	6568

DIMENSIONS

Width	35	Seat Height	18	Arm Height	22	Weight	48.60
Depth	29	Seat Depth	21	Arm Depth	26	Cubic Ft.	15.10
Height	30	Seat Width	27	Arm Width	8		

DIMENSIONS - 2" ARM RIGHT

Width	37	Seat Height	18	Arm Height	22	Weight	64.30
Depth	29	Seat Depth	21	Arm Depth	26	Cubic Ft.	15.70
Height	30	Seat Width	27	Arm Width	8		

DIMENSIONS - 8" ARM RIGHT

Width	43	Seat Height	18	Arm Height	22	Weight	59.00
Depth	29	Seat Depth	21	Arm Depth	26	Cubic Ft.	17.00
Height	30	Seat Width	27	Arm Width	8		

- Contrasting fabric option – specify X (i.e., K82LH1TLWSX); see page 465. For list pricing, use your electronic specification tool or contact customer service
- Kickrail power/USB
- Arm power/USB
- Leg options

PAIRINGS HEALTH

TO ORDER, SPECIFY

1. Model Number
2. Back Fabric Grade
3. Back Fabric Number
4. Seat Fabric Grade
5. Seat Fabric Number
6. Arm Fabric Grade (2" or 8" arm only)
7. Arm Fabric Number (2" or 8" arm only)
8. Tech Tablet HPL Price Group
9. Tech Tablet HPL Designator
10. Storage Wood Price Group
11. Storage Wood Finish Designator
12. Kickrail Power/USB Option
13. Arm Power/USB Option
14. Leg Option

• See pages 461-463 for Pairings Health options
See pages 488-507 for COM fabric yardage

ONE SEAT LOUNGE WOOD STORAGE TECH ARM RIGHT



2" Arm Left



8" Arm Left

MODEL NO.

ALLIANCE PROGRAM PRICE GRADES

		A	B	C	D	E	F	G	H	I
		J	K	L	M	N	O	P	Q	R
K82LH1TRWS	\$	3335	3436	3513	3591	3673	3769	3828	3932	4020
		4112	4260	4556	4741	4783	4815	4864	4908	5111
K82LH12LAUTRWS	2" Arm Left	4234	4362	4460	4559	4663	4785	4860	4992	5104
		5221	5409	5785	6020	6073	6114	6176	6232	6490
K82LH18LAUTRWS	8" Arm Left	4312	4440	4538	4637	4741	4863	4938	5070	5182
		5299	5487	5863	6098	6151	6192	6254	6310	6568

DIMENSIONS

Width	35	Seat Height	18	Arm Height	22	Weight	48.60
Depth	29	Seat Depth	21	Arm Depth	26	Cubic Ft.	15.10
Height	30	Seat Width	27	Arm Width	8		

DIMENSIONS - 2" ARM LEFT

Width	37	Seat Height	18	Arm Height	22	Weight	64.30
Depth	29	Seat Depth	21	Arm Depth	26	Cubic Ft.	15.70
Height	30	Seat Width	27	Arm Width	8		

DIMENSIONS - 8" ARM RIGHT

Width	43	Seat Height	18	Arm Height	22	Weight	59.00
Depth	29	Seat Depth	21	Arm Depth	26	Cubic Ft.	17.00
Height	30	Seat Width	27	Arm Width	8		

- Contrasting fabric option – specify X (i.e., K82LH1TRWSX); see page 465. For list pricing, use your electronic specification tool or contact customer service
- Kickrail power/USB
- Arm power/USB
- Leg options

TO ORDER, SPECIFY

1. Model Number
2. Back Fabric Grade
3. Back Fabric Number
4. Seat Fabric Grade
5. Seat Fabric Number
6. Tablet HPL or Wood Price Group
(omit for 3D laminate)
7. Tablet Finish Designator
8. Storage TFL Designator
9. Kickrail Power/USB Option
10. Arm Power/USB Option
11. Leg Option

• See pages 461-463 for Pairings Health options
See pages 488-507 for COM fabric yardage

**ONE SEAT LOUNGE
TFL STORAGE
TABLET ARM LEFT**



3D Laminate Tablet



HPL Tablet with Phenolic Core



Wood Tablet

MODEL NO.

ALLIANCE PROGRAM PRICE GRADES

			A	B	C	D	E	F	G	H	I
			J	K	L	M	N	O	P	Q	R
K82LH18LTLLS	3D Laminate Tablet	\$	3327	3428	3505	3583	3665	3761	3820	3924	4012
			4104	4252	4548	4733	4775	4807	4856	4900	5103
K82LH18LTLLS	HPL Tablet with Phenolic Core		3562	3663	3740	3818	3900	3996	4055	4159	4247
			4339	4487	4783	4968	5010	5042	5091	5135	5338
K82LH18LTWLLS	Wood Tablet		3574	3675	3752	3830	3912	4008	4067	4171	4259
			4351	4499	4795	4980	5022	5054	5103	5147	5350

DIMENSIONS

Width	37	Seat Height	18	Arm Height	22	Weight	48.60
Depth	29	Seat Depth	21	Arm Depth	26	Cubic Ft.	15.10
Height	30	Seat Width	27	Arm Width	8		

- Contrasting fabric option – specify X (i.e., K82LH18LTLLSX); see page 465. For list pricing, use your electronic specification tool or contact customer service
- Kickrail power/USB
- Arm power/USB
- Leg options

**ONE SEAT LOUNGE
TFL STORAGE
TABLET ARM RIGHT**

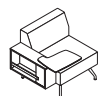

3D Laminate Tablet

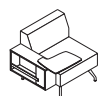

HPL Tablet with Phenolic Core



Wood Tablet

			A	B	C	D	E	F	G	H	I
			J	K	L	M	N	O	P	Q	R
K82LH18RTLLS	3D Laminate Tablet	\$	3327	3428	3505	3583	3665	3761	3820	3924	4012
			4104	4252	4548	4733	4775	4807	4856	4900	5103
K82LH18RTLLS	HPL Tablet with Phenolic Core		3562	3663	3740	3818	3900	3996	4055	4159	4247
			4339	4487	4783	4968	5010	5042	5091	5135	5338
K82LH18RTWLLS	Wood Tablet		3574	3675	3752	3830	3912	4008	4067	4171	4259
			4351	4499	4795	4980	5022	5054	5103	5147	5350

DIMENSIONS

Width	37	Seat Height	18	Arm Height	22	Weight	48.60
Depth	29	Seat Depth	21	Arm Depth	26	Cubic Ft.	15.10
Height	30	Seat Width	27	Arm Width	8		

- Contrasting fabric option – specify X (i.e., K82LH18RTLLSX); see page 465. For list pricing, use your electronic specification tool or contact customer service
- Kickrail power/USB
- Arm power/USB
- Leg options

PAIRINGS HEALTH

TO ORDER, SPECIFY

1. Model Number
2. Back Fabric Grade
3. Back Fabric Number
4. Seat Fabric Grade
5. Seat Fabric Number
6. Tablet HPL Price Group (HPL only)
7. Tablet Finish Designator (3D laminate and HPL only)
8. Storage Wood Price Group
9. Storage Wood Designator
10. Kickrail Power/USB Option
11. Arm Power/USB Option
12. Leg Option

• See pages 461-463 for Pairings Health options
See pages 488-507 for COM fabric yardage

ONE SEAT LOUNGE WOOD STORAGE TABLET ARM LEFT



3D Laminate Tablet



HPL Tablet with Phenolic Core



Wood Tablet

MODEL NO.

ALLIANCE PROGRAM PRICE GRADES

			A	B	C	D	E	F	G	H	I
			J	K	L	M	N	O	P	Q	R
K82LH18LTTWS	3D Laminate Tablet	\$	3444	3545	3622	3700	3782	3878	3937	4041	4129
			4221	4369	4665	4850	4892	4924	4973	5017	5220
K82LH18LTLWS	HPL Tablet with Phenolic Core		3680	3781	3858	3936	4018	4114	4173	4277	4365
			4457	4605	4901	5086	5128	5160	5209	5253	5456
K82LH18LTWWS	Wood Tablet		3692	3793	3870	3948	4030	4126	4185	4289	4377
			4469	4617	4913	5098	5140	5172	5221	5265	5468

DIMENSIONS

Width	37	Seat Height	18	Arm Height	22	Weight	48.60
Depth	29	Seat Depth	21	Arm Depth	26	Cubic Ft.	15.10
Height	30	Seat Width	27	Arm Width	8		

- Contrasting fabric option – specify X (i.e., K82LH18LTLWSX); see page 465. For list pricing, use your electronic specification tool or contact customer service
- Kickrail power/USB
- Arm power/USB
- Leg options

ONE SEAT LOUNGE WOOD STORAGE TABLET ARM RIGHT



3D Laminate Tablet



HPL Tablet with Phenolic Core



Wood Tablet

			A	B	C	D	E	F	G	H	I
			J	K	L	M	N	O	P	Q	R
K82LH18RTTWS	3D Laminate Tablet	\$	3444	3545	3622	3700	3782	3878	3937	4041	4129
			4221	4369	4665	4850	4892	4924	4973	5017	5220
K82LH18RTLWS	HPL Tablet with Phenolic Core		3680	3781	3858	3936	4018	4114	4173	4277	4365
			4457	4605	4901	5086	5128	5160	5209	5253	5456
K82LH18RTWWS	Wood Tablet		3692	3793	3870	3948	4030	4126	4185	4289	4377
			4469	4617	4913	5098	5140	5172	5221	5265	5468

DIMENSIONS

Width	37	Seat Height	18	Arm Height	22	Weight	48.60
Depth	29	Seat Depth	21	Arm Depth	26	Cubic Ft.	15.10
Height	30	Seat Width	27	Arm Width	8		

- Contrasting fabric option – specify X (i.e., K82LH18RTTWSX); see page 465. For list pricing, use your electronic specification tool or contact customer service
- Kickrail power/USB
- Arm power/USB
- Leg options

TO ORDER, SPECIFY

1. Model Number
2. Back Fabric Grade
3. Back Fabric Number
4. Seat Fabric Grade
5. Seat Fabric Number
6. Arm Fabric Grade
7. Arm Fabric Number
8. Arm Cap or Tablet Arm Finish Price Group (if applicable)
9. Arm Cap or Tablet Arm Finish Designator (if applicable)
10. Kickrail Power/USB Option
11. Leg Option

• See pages 461-463 for Pairings Health options
See pages 488-507 for COM fabric yardage

**TWO SEAT LOUNGE
2" ARMS**

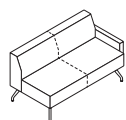

Left Arm

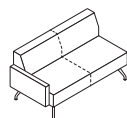

Right Arm

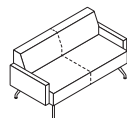

Left and Right Arms

**MODEL
NO.**

ALLIANCE PROGRAM PRICE GRADES

			A	B	C	D	E	F	G	H	I
			J	K	L	M	N	O	P	Q	R
K82LH22LAU	2" Arm Left	\$	3121	3308	3453	3597	3750	3929	4040	4233	4398
			4570	4846	5398	5743	5820	5881	5972	6054	6433
K82LH22RAU	2" Arm Right		3121	3308	3453	3597	3750	3929	4040	4233	4398
			4570	4846	5398	5743	5820	5881	5972	6054	6433
K82LH22LAU2RAU	2" Arms Left and Right		3500	3711	3875	4038	4211	4413	4538	4757	4943
			5138	5450	6074	6464	6551	6620	6722	6815	7244

DIMENSIONS

Width - L or R	56	Seat Height	18	Arm Height	22	Weight - L or R	65.80
Width - L and R	58	Seat Depth	21	Arm Depth	26	Weight - L and R	71.40
Depth	29	Seat Width	54	Arm Width	2	Cubic Ft. - L or R	38.50
Height	30					Cubic Ft. - L and R	40.40

- Contrasting fabric option – specify X (i.e., K82LH22LAUX); see page 464. For list pricing, use your electronic specification tool or contact customer service
- Arm options
- Kickrail power/USB
- Leg options

PAIRINGS HEALTH

TO ORDER, SPECIFY

1. Model Number
2. Back Fabric Grade
3. Back Fabric Number
4. Seat Fabric Grade
5. Seat Fabric Number
6. Arm Fabric Grade
7. Arm Fabric Number
8. Arm Cap or Tablet Arm Finish Price Group (if applicable)
9. Arm Cap or Tablet Arm Finish Designator (if applicable)
10. Kickrail Power/USB Option
11. Arm Power/USB Option
12. Leg Option

• See pages 461-463 for Pairings Health options
See pages 488-507 for COM fabric yardage

TWO SEAT LOUNGE 8" ARMS

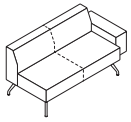

Left Arm

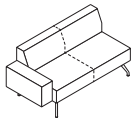

Right Arm

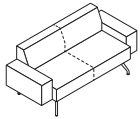

Left and Right Arms

MODEL NO.

ALLIANCE PROGRAM PRICE GRADES

			A	B	C	D	E	F	G	H	I
			J	K	L	M	N	O	P	Q	R
K82LH28LAU	8" Arm Left	\$	3198	3385	3530	3674	3827	4006	4117	4310	4475
			4647	4923	5475	5820	5897	5958	6049	6131	6510
K82LH28RAU	8" Arm Right		3198	3385	3530	3674	3827	4006	4117	4310	4475
			4647	4923	5475	5820	5897	5958	6049	6131	6510
K82LH28LAU8RAU	8" Arms Left and Right		3653	3864	4028	4191	4364	4566	4691	4910	5096
			5291	5603	6227	6617	6704	6773	6875	6968	7397

DIMENSIONS

Width - L or R	62	Seat Height	18	Arm Height	22	Weight - L or R	69.80
Width - L and R	70	Seat Depth	21	Arm Depth	26	Weight - L and R	79.40
Depth	29	Seat Width	54	Arm Width	8	Cubic Ft. - L or R	41.70
Height	30					Cubic Ft. - L and R	46.80

- Contrasting fabric option – specify X (i.e., K82LH28LAUX); see page 464. For list pricing, use your electronic specification tool or contact customer service
- Arm options
- Kickrail power/USB
- Arm power/USB
- Leg options

TO ORDER, SPECIFY

1. Model Number
2. Back Fabric Grade
3. Back Fabric Number
4. Seat Fabric Grade
5. Seat Fabric Number
6. Arm Fabric Grade
7. Arm Fabric Number
8. Arm Cap Finish Price Group
(if applicable)
9. Arm Cap Arm Finish Designator
(if applicable)
10. Tech Tablet Laminate Price Group
11. Tech Tablet Laminate Designator
12. Kickrail Power/USB Option
13. Arm Power/USB Option
14. Leg Option

• See pages 461-463 for Pairings Health options
See pages 488-507 for COM fabric yardage

**TWO SEAT LOUNGE
TECH ARM LEFT OR
BOTH SIDES**

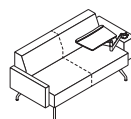

2" Arm Right

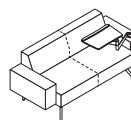

8" Arm Right

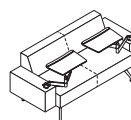

Both Sides

**MODEL
NO.**

ALLIANCE PROGRAM PRICE GRADES

		ALLIANCE PROGRAM PRICE GRADES									
		A	B	C	D	E	F	G	H	I	
		J	K	L	M	N	O	P	Q	R	
K82LH2TLAU		\$ 3988	4175	4320	4464	4617	4796	4907	5100	5265	
		5437	5713	6265	6610	6687	6748	6839	6921	7300	
K82LH2TLAU2RAU	2" Arm Right	4366	4577	4741	4904	5077	5279	5404	5623	5809	
		6004	6316	6940	7330	7417	7486	7588	7681	8110	
K82LH2TLAU8RAU	8" Arm Right	4442	4653	4817	4980	5153	5355	5480	5699	5885	
		6080	6392	7016	7406	7493	7562	7664	7757	8186	
K82LH2TLAU8RAU	Both Sides	5362	5573	5737	5900	6073	6275	6400	6619	6805	
		7000	7312	7936	8326	8413	8482	8584	8677	9106	

DIMENSIONS

Width	62	Seat Height	18	Arm Height	22	Weight	76.40
Depth	29	Seat Depth	21	Arm Depth	26	Cubic Ft.	41.70
Height	30	Seat Width	54	Arm Width	8		

DIMENSIONS - 2" ARM RIGHT

Width	64	Seat Height	18	Arm Height	22	Weight	81.00
Depth	29	Seat Depth	21	Arm Depth	26	Cubic Ft.	43.60
Height	30	Seat Width	54	Arm Width	8		

DIMENSIONS - 8" ARM RIGHT AND BOTH SIDES

Width	70	Seat Height	18	Arm Height	22	Weight	85.00
Depth	29	Seat Depth	21	Arm Depth	26	Cubic Ft.	46.80
Height	30	Seat Width	54	Arm Width	8		

- Contrasting fabric option – specify X (i.e., K82LH2TLAUX); see page 464. For list pricing, use your electronic specification tool or contact customer service
- Kickrail power/USB
- Arm power/USB
- Leg options

PAIRINGS HEALTH

TO ORDER, SPECIFY

1. Model Number
2. Back Fabric Grade
3. Back Fabric Number
4. Seat Fabric Grade
5. Seat Fabric Number
6. Arm Fabric Grade
7. Arm Fabric Number
8. Arm Cap Finish Price Group (if applicable)
9. Arm Cap Finish Designator (if applicable)
10. Tech Tablet Laminate Price Group
11. Tech Tablet Laminate Designator
12. Kickrail Power/USB Option
13. Arm Power/USB Option
14. Leg Option

• See pages 461-463 for Pairings Health options
See pages 488-507 for COM fabric yardage

TWO SEAT LOUNGE TECH ARM RIGHT

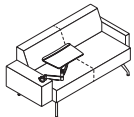
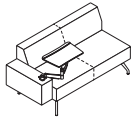

2" Arm Left

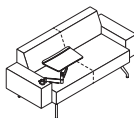

8" Arm Left

MODEL NO.

ALLIANCE PROGRAM PRICE GRADES

		ALLIANCE PROGRAM PRICE GRADES									
		A	B	C	D	E	F	G	H	I	
		J	K	L	M	N	O	P	Q	R	
K82LH2TRAU		\$ 3988	4175	4320	4464	4617	4796	4907	5100	5265	
K82LH22LAUTRAU	2" Arm Left	5437	5713	6265	6610	6687	6748	6839	6921	7300	
K82LH28LAUTRAU	8" Arm Left	4366	4577	4741	4904	5077	5279	5404	5623	5809	
		6004	6316	6940	7330	7417	7486	7588	7681	8110	
		4442	4653	4817	4980	5153	5355	5480	5699	5885	
		6080	6392	7016	7406	7493	7562	7664	7757	8186	

DIMENSIONS

Width	62	Seat Height	18	Arm Height	22	Weight	76.40
Depth	29	Seat Depth	54	Arm Depth	26	Cubic Ft.	41.70
Height	30	Seat Width	27	Arm Width	8		

DIMENSIONS - 2" ARM LEFT

Width	64	Seat Height	18	Arm Height	22	Weight	81.00
Depth	29	Seat Depth	21	Arm Depth	26	Cubic Ft.	43.60
Height	30	Seat Width	54	Arm Width	8		

DIMENSIONS - 8" ARM LEFT

Width	70	Seat Height	18	Arm Height	22	Weight	85.00
Depth	29	Seat Depth	21	Arm Depth	26	Cubic Ft.	46.80
Height	30	Seat Width	54	Arm Width	8		

- Contrasting fabric option – specify X (i.e., K82LH2TRAUX); see page 464. For list pricing, use your electronic specification tool or contact customer service
- Kickrail power/USB
- Arm power/USB
- Leg options

TO ORDER, SPECIFY

1. Model Number
2. Back Fabric Grade
3. Back Fabric Number
4. Seat Fabric Grade
5. Seat Fabric Number
6. Arm Fabric Grade
7. Arm Fabric Number
8. Arm Cap or Tablet Arm Finish Price Group (if applicable)
9. Arm Cap or Tablet Arm Finish Designator (if applicable)
10. Kickrail Power/USB Option
11. Leg Option

• See pages 461-463 for Pairings Health options
See pages 488-507 for COM fabric yardage

**THREE SEAT LOUNGE
2" ARMS**

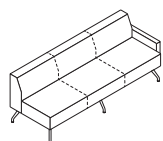

Left Arm

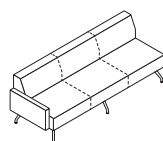

Right Arm

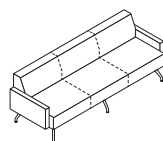

Left and Right Arms

**MODEL
NO.**

ALLIANCE PROGRAM PRICE GRADES

			A	B	C	D	E	F	G	H	I
			J	K	L	M	N	O	P	Q	R
K82LH32LAU	2" Arm Left	\$	4208	4470	4673	4878	5091	5343	5498	5770	6003
			6245	6633	7409	7894	8001	8088	8214	8331	8864
K82LH32RAU	2" Arm Right		4208	4470	4673	4878	5091	5343	5498	5770	6003
			6245	6633	7409	7894	8001	8088	8214	8331	8864
K82LH32LAU2RAU	2" Arms Left and Right		4587	4873	5095	5319	5552	5827	5996	6294	6548
			6813	7237	8085	8615	8732	8827	8964	9092	9675

DIMENSIONS

Width - L or R	83	Seat Height	18	Arm Height	22	Weight - L or R	91.30
Width - L and R	85	Seat Depth	21	Arm Depth	26	Weight - L and R	96.90
Depth	29	Seat Width	81	Arm Width	2	Cubic Ft. - L or R	56.20
Height	30					Cubic Ft. - L and R	58.10

- Contrasting fabric option – specify X (i.e., K82LH32LAUX); see page 464. For list pricing, use your electronic specification tool or contact customer service
- Arm options
- Kickrail power/USB
- Leg options

**THREE SEAT LOUNGE
8" ARMS**

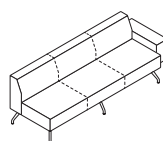

Left Arm

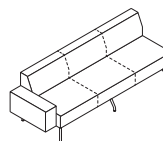

Right Arm

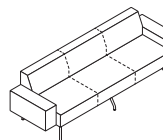

Left and Right Arms

			A	B	C	D	E	F	G	H	I
			J	K	L	M	N	O	P	Q	R
K82LH38LAU	8" Arm Left	\$	4284	4546	4749	4954	5167	5419	5574	5846	6079
			6321	6709	7485	7970	8077	8164	8290	8407	8940
K82LH38RAU	8" Arm Right		4284	4546	4749	4954	5167	5419	5574	5846	6079
			6321	6709	7485	7970	8077	8164	8290	8407	8940
K82LH38LAU8RAU	8" Arms Left and Right		4739	5025	5247	5471	5704	5979	6148	6446	6700
			6965	7389	8237	8767	8884	8979	9116	9244	9827

DIMENSIONS

Width - L or R	89	Seat Height	18	Arm Height	22	Weight - L or R	95.30
Width - L and R	97	Seat Depth	21	Arm Depth	26	Weight - L and R	104.90
Depth	29	Seat Width	81	Arm Width	2	Cubic Ft. - L or R	59.40
Height	30					Cubic Ft. - L and R	64.50

- Contrasting fabric option – specify X (i.e., K82LH38LAUX); see page 464. For list pricing, use your electronic specification tool or contact customer service
- Arm options
- Kickrail power/USB
- Leg options

PAIRINGS HEALTH

TO ORDER, SPECIFY

1. Model Number
2. Back Fabric Grade
3. Back Fabric Number
4. Seat Fabric Grade
5. Seat Fabric Number
6. Arm Fabric Grade
7. Arm Fabric Number
8. Arm Cap Finish Price Group (if applicable)
9. Arm Cap Finish Designator (if applicable)
10. Tech Tablet Laminate Price Group
11. Tech Tablet Laminate Designator
12. Kickrail Power/USB Option
13. Arm Power/USB Option
14. Leg Option

• See pages 461-463 for Pairings Health options
See pages 488-507 for COM fabric yardage

THREE SEAT LOUNGE TECH ARM LEFT OR BOTH SIDES

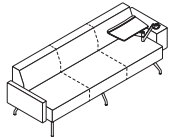
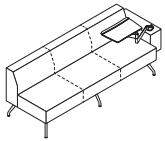

2" Arm Right

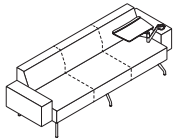

8" Arm Right

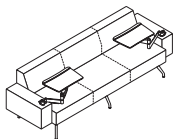

Both Sides

MODEL NO.

ALLIANCE PROGRAM PRICE GRADES

		ALLIANCE PROGRAM PRICE GRADES									
		A	B	C	D	E	F	G	H	I	
		J	K	L	M	N	O	P	Q	R	
K82LH3TLAU		\$ 5073	5335	5538	5743	5956	6208	6363	6635	6868	
		7110	7498	8274	8759	8866	8953	9079	9196	9729	
K82LH3TLAU2RAU	2" Arm Right	5451	5737	5959	6183	6416	6691	6860	7158	7412	
		7677	8101	8949	9479	9596	9691	9828	9956	10539	
K82LH3TLAU8RAU	8" Arm Right	5529	5815	6037	6261	6494	6769	6938	7236	7490	
		7755	8179	9027	9557	9674	9769	9906	10034	10617	
K82LH3TLAU8RAU	Both Sides	6473	6759	6981	7205	7438	7713	7882	8180	8434	
		8699	9123	9971	10501	10618	10713	10850	10978	11561	

DIMENSIONS

Width	89	Seat Height	18	Arm Height	22	Weight	100.90
Depth	29	Seat Depth	21	Arm Depth	26	Cubic Ft.	59.40
Height	30	Seat Width	81	Arm Width	8		

DIMENSIONS - 2" ARM RIGHT

Width	91	Seat Height	18	Arm Height	22	Weight	106.50
Depth	29	Seat Depth	21	Arm Depth	26	Cubic Ft.	61.30
Height	30	Seat Width	81	Arm Width	8		

DIMENSIONS - 8" ARM RIGHT AND BOTH SIDES

Width	97	Seat Height	18	Arm Height	22	Weight - 8" Arm Right	110.50
Depth	29	Seat Depth	21	Arm Depth	26	Weight - Both Sides	85.00
Height	30	Seat Width	81	Arm Width	8	Cubic Ft. - 8" Arm Right	64.50
						Cubic Ft. - Both Sides	46.80

- Contrasting fabric option – specify X (i.e., H82LH3TLAUX); see page 464. For list pricing, use your electronic specification tool or contact customer service
- Arm options
- Kickrail power/USB
- Arm power/USB
- Leg options

TO ORDER, SPECIFY

1. Model Number
2. Back Fabric Grade
3. Back Fabric Number
4. Seat Fabric Grade
5. Seat Fabric Number
6. Arm Fabric Grade
7. Arm Fabric Number
8. Arm Cap Finish Price Group
(if applicable)
9. Arm Cap Finish Designator
(if applicable)
10. Tech Tablet Laminate Price Group
11. Tech Tablet Laminate Designator
12. Kickrail Power/USB Option
13. Arm Power/USB Option
14. Leg Option

• See pages 461-463 for Pairings Health options
See pages 488-507 for COM fabric yardage

**THREE SEAT LOUNGE
TECH ARM RIGHT**

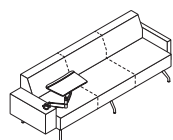
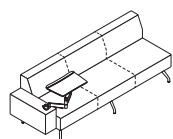

2" Arm Left

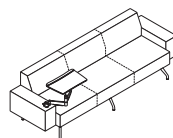

8" Arm Left

**MODEL
NO.**

ALLIANCE PROGRAM PRICE GRADES

		A	B	C	D	E	F	G	H	I
		J	K	L	M	N	O	P	Q	R
K82LH3TRAU		\$ 5073	5335	5538	5743	5956	6208	6363	6635	6868
		7110	7498	8274	8759	8866	8953	9079	9196	9729
K82LH32LAUTRAU	2" Arm Left	5451	5737	5959	6183	6416	6691	6860	7158	7412
		7677	8101	8949	9479	9596	9691	9828	9956	10539
K82LH38LAUTRAU	8" Arm Left	5529	5815	6037	6261	6494	6769	6938	7236	7490
		7755	8179	9027	9557	9674	9769	9906	10034	10617

DIMENSIONS

Width	89	Seat Height	18	Arm Height	22	Weight	100.90
Depth	29	Seat Depth	21	Arm Depth	26	Cubic Ft.	59.40
Height	30	Seat Width	81	Arm Width	8		

DIMENSIONS - 2" ARM LEFT

Width	91	Seat Height	18	Arm Height	22	Weight	106.50
Depth	29	Seat Depth	21	Arm Depth	26	Cubic Ft.	61.30
Height	30	Seat Width	81	Arm Width	8		

DIMENSIONS - 8" ARM LEFT

Width	97	Seat Height	18	Arm Height	22	Weight	110.50
Depth	29	Seat Depth	21	Arm Depth	26	Cubic Ft.	64.50
Height	30	Seat Width	81	Arm Width	8		

- Contrasting fabric option – specify X (i.e., K82LH3TRAUX); see page 464. For list pricing, use your electronic specification tool or contact customer service
- Arm options
- Kickrail power/USB
- Arm power/USB
- Leg options

PAIRINGS HEALTH

TO ORDER, SPECIFY

1. Model Number
2. Back Fabric Grade
3. Back Fabric Number
4. Seat Fabric Grade
5. Seat Fabric Number
6. Kickrail Power/USB Option (omit for corner)
7. Leg Option

• See pages 461-463 for Pairings Health options
See pages 488-507 for COM fabric yardage

CORNERS & CRESCENTS LOUNGE

MODEL NO.

ALLIANCE PROGRAM PRICE GRADES



90° Corner Left (as seated)



90° Corner Right (as seated)

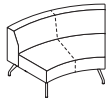

45° Crescent

			A	B	C	D	E	F	G	H	I
			J	K	L	M	N	O	P	Q	R
K82LH90L	90° Corner Left (as seated)	\$	2091	2173	2236	2300	2366	2445	2494	2579	2651
			2727	2848	3090	3242	3275	3303	3342	3379	3545
K82LH90R	90° Corner Right (as seated)		2091	2173	2236	2300	2366	2445	2494	2579	2651
			2727	2848	3090	3242	3275	3303	3342	3379	3545
K82LH45	45° Crescent		2622	2745	2841	2938	3038	3157	3231	3359	3469
			3583	3767	4133	4362	4412	4454	4513	4568	4820

DIMENSIONS - CORNER

Width	29	Seat Height	18	Weight	48.80
Depth	29	Seat Depth	21	Cubic Ft.	20.50
Height	30	Seat Width	29		

DIMENSIONS - CRESCENT

Width	54	Seat Height	18	Weight	77.30
Depth	29	Seat Depth	21	Cubic Ft.	40.90
Height	30	Seat Width	54		

- Corner and crescent lounge models coordinate with Pairings Health lounge models, but do not feature a clean-out.
- Can be used in conjunction with Kimball Pairings benches, tables, and perch models.
- Contrasting fabric option – specify X (i.e., K82LH90LX); see page 464. For list pricing, use your electronic specification tool or contact customer service
- No clean out
- Kickrail power/USB on crescent
- Leg options
- IMPORTANT: Fabrics reflect light differently when viewed at various angles, creating a natural phenomenon called "flip." Flip is visible on all fabrics and is not considered a defect; it is more easily recognized on fabrics with a nap or shimmer and more apparent on crescent or corner units

TO ORDER, SPECIFY

1. Model Number
2. Fabric Grade
3. Fabric Number
4. Kickrail Power/USB Option
5. Leg Option

• See pages 461-463 for Pairings Health options
 See pages 488-507 for COM fabric yardage

**BENCH
21" DEEP**



One Seat

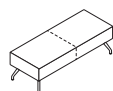

Two Seat

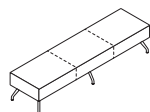

Three Seat

**MODEL
NO.**

ALLIANCE PROGRAM PRICE GRADES

				A	B	C	D	E	F	G	H	I
				J	K	L	M	N	O	P	Q	R
K82BH121	One Seat	\$	1566	1607	1638	1669	1702	1741	1764	1806	1842	
			1879	1939	2058	2132	2149	2162	2181	2199	2281	
K82BH221	Two Seat	2004	2078	2135	2191	2251	2322	2365	2441	2506		
		2574	2682	2899	3035	3064	3089	3124	3157	3306		
K82BH321	Three Seat	2591	2699	2784	2868	2956	3060	3124	3236	3332		
		3433	3593	3913	4114	4158	4194	4246	4294	4514		

DIMENSIONS - ONE SEAT

Width	27	Seat Height	18	Weight	
Depth	21	Seat Depth	21	Cubic Ft.	
Height	18	Seat Width	27		

DIMENSIONS - TWO SEAT

Width	54	Seat Height	18	Weight	
Depth	21	Seat Depth	21	Cubic Ft.	
Height	18	Seat Width	54		

DIMENSIONS - THREE SEAT

Width	81	Seat Height	18	Weight	
Depth	21	Seat Depth	21	Cubic Ft.	
Height	18	Seat Width	81		

- Kickrail power/USB
- Leg options

**BENCH
29" DEEP**



One Seat

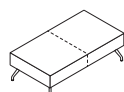

Two Seat

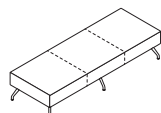

Three Seat

			A	B	C	D	E	F	G	H	I	
			J	K	L	M	N	O	P	Q	R	
K82BH129	One Seat	\$	1702	1764	1812	1860	1911	1970	2007	2071	2126	
			2184	2275	2459	2574	2599	2619	2649	2677	2803	
K82BH229	Two Seat	2206	2307	2385	2462	2544	2641	2700	2804	2893		
		2986	3134	3431	3617	3657	3691	3739	3784	3988		
K82BH329	Three Seat	2724	2867	2979	3090	3207	3345	3430	3579	3706		
		3839	4052	4476	4742	4800	4848	4917	4981	5273		

DIMENSIONS - ONE SEAT

Width	27	Seat Height	18	Weight	
Depth	29	Seat Depth	21	Cubic Ft.	
Height	18	Seat Width	27		

DIMENSIONS - TWO SEAT

Width	54	Seat Height	18	Weight	
Depth	29	Seat Depth	21	Cubic Ft.	
Height	18	Seat Width	54		

DIMENSIONS - THREE SEAT

Width	81	Seat Height	18	Weight	
Depth	29	Seat Depth	21	Cubic Ft.	
Height	18	Seat Width	81		

- Kickrail power/USB
- Leg options

PAIRINGS HEALTH

TO ORDER, SPECIFY

1. Model Number
2. Fabric Grade
3. Fabric Number
4. Leg Option

• See pages 461-463 for Pairings Health options
 See pages 488-507 for COM fabric yardage

90° CORNER BENCH



21" Deep



29" Deep

MODEL NO.

ALLIANCE PROGRAM PRICE GRADES

			A	B	C	D	E	F	G	H	I
			J	K	L	M	N	O	P	Q	R
K82BH9021L	21" Deep, Left (as seated)	\$	1429	1464	1492	1519	1548	1582	1603	1640	1671
			1704	1757	1861	1927	1941	1953	1970	1986	2058
K82BH9021R	21" Deep, Right (as seated)		1429	1464	1492	1519	1548	1582	1603	1640	1671
			1704	1757	1861	1927	1941	1953	1970	1986	2058
K82BH9029L	29" Deep, Left (as seated)		1894	1959	2009	2059	2112	2174	2213	2280	2337
			2397	2493	2684	2804	2830	2852	2883	2912	3043
K82BH9029R	29" Deep, Right (as seated)		1894	1959	2009	2059	2112	2174	2213	2280	2337
			2397	2493	2684	2804	2830	2852	2883	2912	3043

DIMENSIONS - 21" DEEP

Width	21	Seat Height	18	Weight
Depth	21	Seat Depth	21	Cubic Ft.
Height	18	Seat Width	21	

DIMENSIONS - 29" DEEP

Width	29	Seat Height	18	Weight
Depth	29	Seat Depth	29	Cubic Ft.
Height	18	Seat Width	29	

- Kickrail power/USB
- Leg options

TO ORDER, SPECIFY

1. Model Number
2. Fabric Grade
3. Fabric Number
4. Kickrail Power/USB option
5. Leg Option

• See pages 461-463 for Pairings Health options
 See pages 488-507 for COM fabric yardage

45° CRESCENT BENCH

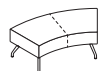

21" Deep

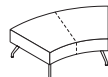

29" Deep

MODEL NO.

ALLIANCE PROGRAM PRICE GRADES

MODEL NO.	SEAT DEPTH	PRICE	A	B	C	D	E	F	G	H	I
			J	K	L	M	N	O	P	Q	R
K82BH4521	21" Deep	\$ 2159	2213	2256	2298	2342	2394	2426	2482	2530	
		2581	2661	2821	2922	2944	2962	2988	3012	3122	
K82BH4529	29" Deep	2753	2818	2868	2918	2971	3033	3072	3139	3196	
		3256	3352	3543	3663	3689	3711	3742	3771	3902	

DIMENSIONS - 21" DEEP

Width	54	Seat Height	18	Weight	
Depth	21	Seat Depth	21	Cubic Ft.	
Height	18	Seat Width	54		

DIMENSIONS - 29" DEEP

Width	54	Seat Height	18	Weight	
Depth	29	Seat Depth	29	Cubic Ft.	
Height	18	Seat Width	54		

- Kickrail power/USB
- Leg options

COM YARDAGE REQUIREMENTS

COM YARDAGE REQUIREMENTS (54" WIDTH – CUT UP THE ROLL)

MODEL	RAILROADED Contact customer service 800-634-9510 for ydg requirements	NON DIRECTIONAL OR SOLID	1"-4" REPEAT	5"-11" REPEAT	12"-18" REPEAT	COL SQUARE FEET
			4" VERTICAL X 4" HORIZONTAL	11" VERTICAL X 11" HORIZONTAL	18" VERTICAL X 18" HORIZONTAL	
K82BH121	Entire Unit	1.40	1.90	2.10	3.20	28
K82BH129	Entire Unit	2.20	2.50	3.60	3.60	44
K82BH221	Entire Unit	2.60	2.90	4.50	4.70	52
K82BH229	Entire Unit	3.60	4.00	5.10	5.80	72
K82BH321	Entire Unit	3.50	3.90	5.10	5.70	70
K82BH329	Entire Unit	5.10	5.50	7.40	7.80	102
K82BH4521	Entire Unit	2.20	2.50	3.60	3.60	44
K82BH4529	Entire Unit	1.80	2.00	3.90	4.30	40
K82BH9021D	Entire Unit	1.30	1.50	2.10	3.20	26
K82BH9021L	Entire Unit	1.10	1.30	2.10	3.20	22
K82BH9021R	Entire Unit	1.10	1.30	2.10	3.20	22
K82BH9029D	Entire Unit	2.40	2.80	3.90	4.30	47.5
K82BH9029L	Entire Unit	2.20	2.50	3.60	3.60	44
K82BH9029R	Entire Unit	2.20	2.50	3.60	3.60	44
K82LH1	Entire Unit	2.50	3.10	3.90	4.80	49
	Back	1.40	1.70	2.10	3.30	28
	Seat	1.20	1.70	2.40	3.20	21.5
K82LH12LAP	Entire Unit	3.90	4.50	4.70	4.90	75.5
	Back	1.60	1.80	1.90	2.00	30.5
	Seat	2.10	2.40	2.50	2.60	38.2
	Arm	1.00	1.20	1.20	1.30	20
K82LH12LAP2RAP	Entire Unit	4.70	5.40	5.60	5.90	91.5
	Back	1.60	1.80	1.90	2.00	30.5
	Seat	2.10	2.40	2.50	2.60	38.2
	Arm	1.80	2.10	2.20	2.30	34
K82LH12LAS	Entire Unit	3.90	4.50	4.70	4.90	75.5
	Back	1.60	1.80	1.90	2.00	30.5
	Seat	2.10	2.40	2.50	2.60	38.2
	Arm	1.00	1.20	1.20	1.30	20
K82LH12LAS2RAS	Entire Unit	4.70	5.40	5.60	5.90	91.5
	Back	1.60	1.80	1.90	2.00	30.5
	Seat	2.10	2.40	2.50	2.60	38.2
	Arm	1.80	2.10	2.20	2.30	34
K82LH12LASTRAS	Entire Unit	4.80	5.50	5.80	6.00	94
	Back	1.60	1.80	1.90	2.00	30.5
	Seat	2.10	2.40	2.50	2.60	38.2
	Arm	1.90	2.20	2.30	2.40	38
K82LH12LAT	Entire Unit	3.90	4.50	4.70	4.90	75.5
	Back	1.60	1.80	1.90	2.00	30.5
	Seat	2.10	2.40	2.50	2.60	38.2
	Arm	1.00	1.20	1.20	1.30	20
K82LH12LAT2RAT	Entire Unit	4.70	5.40	5.60	5.90	91.5
	Back	1.60	1.80	1.90	2.00	30.5
	Seat	2.10	2.40	2.50	2.60	38.2
	Arm	1.80	2.10	2.20	2.30	34
K82LH12LAT2RTT	Entire Unit	4.70	5.40	5.60	5.90	91.5
	Back	1.60	1.80	1.90	2.00	30.5
	Seat	2.10	2.40	2.50	2.60	38.2
	Arm	1.80	2.10	2.20	2.30	34
K82LH12LATTRAT	Entire Unit	4.80	5.50	5.80	6.00	94
	Back	1.60	1.80	1.90	2.00	30.5
	Seat	2.10	2.40	2.50	2.60	38.2
	Arm	1.90	2.20	2.30	2.40	38
K82LH12LATTRLLS	Entire Unit	3.90	4.50	4.70	4.90	75.5
	Back	1.60	1.80	1.90	2.00	30.5
	Seat	2.10	2.40	2.50	2.60	38.2
	Arm	1.00	1.20	1.20	1.30	20

COM YARDAGE REQUIREMENTS

COM YARDAGE REQUIREMENTS (54" WIDTH – CUT UP THE ROLL)

MODEL	RAILROADED Contact customer service 800-634-9510 for ydg requirements	NON DIRECTIONAL OR SOLID	1"-4" REPEAT	5"-11" REPEAT	12"-18" REPEAT	COL SQUARE FEET
			4" VERTICAL X 4" HORIZONTAL	11" VERTICAL X 11" HORIZONTAL	18" VERTICAL X 18" HORIZONTAL	
K82LH12LAU	Entire Unit	3.90	4.50	4.70	4.90	75.5
	Back	1.60	1.80	1.90	2.00	30.5
	Seat	2.10	2.40	2.50	2.60	38.2
	Arm	1.00	1.20	1.20	1.30	20
K82LH12LAU2RAU	Entire Unit	4.80	5.50	5.80	6.00	92
	Back	1.60	1.80	1.90	2.00	30.5
	Seat	2.10	2.40	2.50	2.60	38.2
	Arm	1.90	2.20	2.30	2.40	36
K82LH12LAU2RTL	Entire Unit	4.80	5.50	5.80	6.00	92
	Back	1.60	1.80	1.90	2.00	30.5
	Seat	2.10	2.40	2.50	2.60	38.2
	Arm	1.90	2.20	2.30	2.40	36
K82LH12LAU2RTT	Entire Unit	4.80	5.50	5.80	6.00	92
	Back	1.60	1.80	1.90	2.00	30.5
	Seat	2.10	2.40	2.50	2.60	38.2
	Arm	1.90	2.20	2.30	2.40	36
K82LH12LAU2RTW	Entire Unit	4.80	5.50	5.80	6.00	92
	Back	1.60	1.80	1.90	2.00	30.5
	Seat	2.10	2.40	2.50	2.60	38.2
	Arm	1.90	2.20	2.30	2.40	36
K82LH12LAUTRAU	Entire Unit	4.80	5.50	5.80	6.00	94
	Back	1.60	1.80	1.90	2.00	30.5
	Seat	2.10	2.40	2.50	2.60	38.2
	Arm	1.90	2.20	2.30	2.40	38
K82LH12LAUTRLLS	Entire Unit	3.90	4.50	4.70	4.90	75.5
	Back	1.60	1.80	1.90	2.00	30.5
	Seat	2.10	2.40	2.50	2.60	38.2
	Arm	1.00	1.20	1.20	1.30	20
K82LH12LAUTRWS	Entire Unit	3.90	4.50	4.70	4.90	75.5
	Back	1.60	1.80	1.90	2.00	30.5
	Seat	2.10	2.40	2.50	2.60	38.2
	Arm	1.00	1.20	1.20	1.30	20
K82LH12LAW	Entire Unit	3.90	4.50	4.70	4.90	75.5
	Back	1.60	1.80	1.90	2.00	30.5
	Seat	2.10	2.40	2.50	2.60	38.2
	Arm	1.00	1.20	1.20	1.30	20
K82LH12LAW2RAW	Entire Unit	4.70	5.40	5.60	5.90	91.5
	Back	1.60	1.80	1.90	2.00	30.5
	Seat	2.10	2.40	2.50	2.60	38.2
	Arm	1.80	2.10	2.20	2.30	34
K82LH12LAW2RTW	Entire Unit	4.70	5.40	5.60	5.90	91.5
	Back	1.60	1.80	1.90	2.00	30.5
	Seat	2.10	2.40	2.50	2.60	38.2
	Arm	1.80	2.10	2.20	2.30	34
K82LH12LAWTRAW	Entire Unit	4.80	5.50	5.80	6.00	94
	Back	1.60	1.80	1.90	2.00	30.5
	Seat	2.10	2.40	2.50	2.60	38.2
	Arm	1.90	2.20	2.30	2.40	38
K82LH12LAWTRWS	Entire Unit	3.90	4.50	4.70	4.90	75.5
	Back	1.60	1.80	1.90	2.00	30.5
	Seat	2.10	2.40	2.50	2.60	38.2
	Arm	1.00	1.20	1.20	1.30	20
K82LH12LTL	Entire Unit	3.90	4.50	4.70	4.90	75.5
	Back	1.60	1.80	1.90	2.00	30.5
	Seat	2.10	2.40	2.50	2.60	38.2
	Arm	1.00	1.20	1.20	1.30	20
K82LH12LTL2RAU	Entire Unit	4.80	5.50	5.80	6.00	92
	Back	1.60	1.80	1.90	2.00	30.5
	Seat	2.10	2.40	2.50	2.60	38.2
	Arm	1.90	2.20	2.30	2.40	36

COM YARDAGE REQUIREMENTS

COM YARDAGE REQUIREMENTS (54" WIDTH – CUT UP THE ROLL)

MODEL	RAILROADED Contact customer service 800-634-9510 for ydg requirements	NON DIRECTIONAL OR SOLID	1"-4" REPEAT	5"-11" REPEAT	12"-18" REPEAT	COL SQUARE FEET
			4" VERTICAL X 4" HORIZONTAL	11" VERTICAL X 11" HORIZONTAL	18" VERTICAL X 18" HORIZONTAL	
K82LH12LTT	Entire Unit	3.90	4.50	4.70	4.90	75.5
	Back	1.60	1.80	1.90	2.00	30.5
	Seat	2.10	2.40	2.50	2.60	38.2
	Arm	1.00	1.20	1.20	1.30	20
K82LH12LTT2RAT	Entire Unit	4.70	5.40	5.60	5.90	91.5
	Back	1.60	1.80	1.90	2.00	30.5
	Seat	2.10	2.40	2.50	2.60	38.2
	Arm	1.80	2.10	2.20	2.30	34
K82LH12LTT2RAU	Entire Unit	4.80	5.50	5.80	6.00	92
	Back	1.60	1.80	1.90	2.00	30.5
	Seat	2.10	2.40	2.50	2.60	38.2
	Arm	1.90	2.20	2.30	2.40	36
K82LH12LTW	Entire Unit	3.90	4.50	4.70	4.90	75.5
	Back	1.60	1.80	1.90	2.00	30.5
	Seat	2.10	2.40	2.50	2.60	38.2
	Arm	1.00	1.20	1.20	1.30	20
K82LH12LTW2RAU	Entire Unit	4.80	5.50	5.80	6.00	92
	Back	1.60	1.80	1.90	2.00	30.5
	Seat	2.10	2.40	2.50	2.60	38.2
	Arm	1.90	2.20	2.30	2.40	36
K82LH12LTW2RAW	Entire Unit	4.70	5.40	5.60	5.90	91.5
	Back	1.60	1.80	1.90	2.00	30.5
	Seat	2.10	2.40	2.50	2.60	38.2
	Arm	1.80	2.10	2.20	2.30	34
K82LH12RAP	Entire Unit	3.90	4.50	4.70	4.90	75.5
	Back	1.60	1.80	1.90	2.00	30.5
	Seat	2.10	2.40	2.50	2.60	38.2
	Arm	1.00	1.20	1.20	1.30	20
K82LH12RAS	Entire Unit	3.90	4.50	4.70	4.90	75.5
	Back	1.60	1.80	1.90	2.00	30.5
	Seat	2.10	2.40	2.50	2.60	38.2
	Arm	1.00	1.20	1.20	1.30	20
K82LH12RAT	Entire Unit	3.90	4.50	4.70	4.90	75.5
	Back	1.60	1.80	1.90	2.00	30.5
	Seat	2.10	2.40	2.50	2.60	38.2
	Arm	1.00	1.20	1.20	1.30	20
K82LH12RAU	Entire Unit	3.90	4.50	4.70	4.90	75.5
	Back	1.60	1.80	1.90	2.00	30.5
	Seat	2.10	2.40	2.50	2.60	38.2
	Arm	1.00	1.20	1.20	1.30	20
K82LH12RAW	Entire Unit	3.90	4.50	4.70	4.90	75.5
	Back	1.60	1.80	1.90	2.00	30.5
	Seat	2.10	2.40	2.50	2.60	38.2
	Arm	1.00	1.20	1.20	1.30	20
K82LH12RTL	Entire Unit	3.90	4.50	4.70	4.90	75.5
	Back	1.60	1.80	1.90	2.00	30.5
	Seat	2.10	2.40	2.50	2.60	38.2
	Arm	1.00	1.20	1.20	1.30	20
K82LH12RTT	Entire Unit	3.90	4.50	4.70	4.90	75.5
	Back	1.60	1.80	1.90	2.00	30.5
	Seat	2.10	2.40	2.50	2.60	38.2
	Arm	1.00	1.20	1.20	1.30	20
K82LH12RTW	Entire Unit	3.90	4.50	4.70	4.90	75.5
	Back	1.60	1.80	1.90	2.00	30.5
	Seat	2.10	2.40	2.50	2.60	38.2
	Arm	1.00	1.20	1.20	1.30	20
K82LH18LAS	Entire Unit	3.90	4.50	4.70	4.90	75.5
	Back	1.60	1.80	1.90	2.00	30.5
	Seat	2.10	2.40	2.50	2.60	38.2
	Arm	1.00	1.20	1.20	1.30	20

COM YARDAGE REQUIREMENTS

COM YARDAGE REQUIREMENTS (54" WIDTH – CUT UP THE ROLL)

MODEL	RAILOADED Contact customer service 800-634-9510 for ydg requirements	NON DIRECTIONAL OR SOLID	1"-4" REPEAT	5"-11" REPEAT	12"-18" REPEAT	COL SQUARE FEET
			4" VERTICAL X 4" HORIZONTAL	11" VERTICAL X 11" HORIZONTAL	18" VERTICAL X 18" HORIZONTAL	
K82LH18LAS8RAS	Entire Unit	4.70	5.40	5.60	5.90	91.5
	Back	1.60	1.80	1.90	2.00	30.5
	Seat	2.10	2.40	2.50	2.60	38.2
	Arm	1.80	2.10	2.20	2.30	36
K82LH18LASTRAS	Entire Unit	4.70	5.40	5.60	5.90	91.5
	Back	1.60	1.80	1.90	2.00	30.5
	Seat	2.10	2.40	2.50	2.60	38.2
	Arm	1.80	2.10	2.20	2.30	36
K82LH18LAT	Entire Unit	3.90	4.50	4.70	4.90	75.5
	Back	1.60	1.80	1.90	2.00	30.5
	Seat	2.10	2.40	2.50	2.60	38.2
	Arm	1.00	1.20	1.20	1.30	20
K82LH18LAT8RAT	Entire Unit	4.70	5.40	5.60	5.90	91.5
	Back	1.60	1.80	1.90	2.00	30.5
	Seat	2.10	2.40	2.50	2.60	38.2
	Arm	1.80	2.10	2.20	2.30	36
K82LH18LAT8RTT	Entire Unit	4.70	5.40	5.60	5.90	91.5
	Back	1.60	1.80	1.90	2.00	30.5
	Seat	2.10	2.40	2.50	2.60	38.2
	Arm	1.80	2.10	2.20	2.30	36
K82LH18LATTRAT	Entire Unit	4.70	5.40	5.60	5.90	91.5
	Back	1.60	1.80	1.90	2.00	30.5
	Seat	2.10	2.40	2.50	2.60	38.2
	Arm	1.80	2.10	2.20	2.30	36
K82LH18LATRLLS	Entire Unit	3.90	4.50	4.70	4.90	75.5
	Back	1.60	1.80	1.90	2.00	30.5
	Seat	2.10	2.40	2.50	2.60	38.2
	Arm	1.00	1.20	1.20	1.30	20
K82LH18LAU	Entire Unit	3.90	4.50	4.70	4.90	75.5
	Back	1.60	1.80	1.90	2.00	30.5
	Seat	2.10	2.40	2.50	2.60	38.2
	Arm	1.00	1.20	1.20	1.30	20
K82LH18LAU8RAU	Entire Unit	4.80	5.50	5.80	6.00	94
	Back	1.60	1.80	1.90	2.00	30.5
	Seat	2.10	2.40	2.50	2.60	38.2
	Arm	1.90	2.20	2.30	2.40	36
K82LH18LAU8RTL	Entire Unit	4.80	5.50	5.80	6.00	94
	Back	1.60	1.80	1.90	2.00	30.5
	Seat	2.10	2.40	2.50	2.60	38.2
	Arm	1.90	2.20	2.30	2.40	36
K82LH18LAU8RTT	Entire Unit	4.80	5.50	5.80	6.00	94
	Back	1.60	1.80	1.90	2.00	30.5
	Seat	2.10	2.40	2.50	2.60	38.2
	Arm	1.90	2.20	2.30	2.40	36
K82LH18LAU8RTW	Entire Unit	4.80	5.50	5.80	6.00	94
	Back	1.60	1.80	1.90	2.00	30.5
	Seat	2.10	2.40	2.50	2.60	38.2
	Arm	1.90	2.20	2.30	2.40	36
K82LH18LAU8TRAU	Entire Unit	4.80	5.50	5.80	6.00	94
	Back	1.60	1.80	1.90	2.00	30.5
	Seat	2.10	2.40	2.50	2.60	38.2
	Arm	1.90	2.20	2.30	2.40	36
K82LH18LAU8RLLS	Entire Unit	3.90	4.50	4.70	4.90	75.5
	Back	1.60	1.80	1.90	2.00	30.5
	Seat	2.10	2.40	2.50	2.60	38.2
	Arm	1.00	1.20	1.20	1.30	20
K82LH18LAU8TRWS	Entire Unit	3.90	4.50	4.70	4.90	75.5
	Back	1.60	1.80	1.90	2.00	30.5
	Seat	2.10	2.40	2.50	2.60	38.2
	Arm	1.00	1.20	1.20	1.30	20

COM YARDAGE REQUIREMENTS

COM YARDAGE REQUIREMENTS (54" WIDTH – CUT UP THE ROLL)

MODEL	RAILROADED Contact customer service 800-634-9510 for ydg requirements	NON DIRECTIONAL OR SOLID	1"-4" REPEAT	5"-11" REPEAT	12"-18" REPEAT	COL SQUARE FEET
			4" VERTICAL X 4" HORIZONTAL	11" VERTICAL X 11" HORIZONTAL	18" VERTICAL X 18" HORIZONTAL	
K82LH18LAW	Entire Unit	3.90	4.50	4.70	4.90	75.5
	Back	1.60	1.80	1.90	2.00	30.5
	Seat	2.10	2.40	2.50	2.60	38.2
	Arm	1.00	1.20	1.20	1.30	20
K82LH18LAW8RAW	Entire Unit	4.70	5.40	5.60	5.90	91.5
	Back	1.60	1.80	1.90	2.00	30.5
	Seat	2.10	2.40	2.50	2.60	38.2
	Arm	1.80	2.10	2.20	2.30	36
K82LH18LAW8RTW	Entire Unit	4.70	5.40	5.60	5.90	91.5
	Back	1.60	1.80	1.90	2.00	30.5
	Seat	2.10	2.40	2.50	2.60	38.2
	Arm	1.80	2.10	2.20	2.30	36
K82LH18LAWTRAW	Entire Unit	4.70	5.40	5.60	5.90	91.5
	Back	1.60	1.80	1.90	2.00	30.5
	Seat	2.10	2.40	2.50	2.60	38.2
	Arm	1.80	2.10	2.20	2.30	36
K82LH18LAWTRWS	Entire Unit	3.90	4.50	4.70	4.90	75.5
	Back	1.60	1.80	1.90	2.00	30.5
	Seat	2.10	2.40	2.50	2.60	38.2
	Arm	1.00	1.20	1.20	1.30	20
K82LH18LTL	Entire Unit	3.90	4.50	4.70	4.90	75.5
	Back	1.60	1.80	1.90	2.00	30.5
	Seat	2.10	2.40	2.50	2.60	38.2
	Arm	1.00	1.20	1.20	1.30	20
K82LH18LTL8RAU	Entire Unit	4.80	5.50	5.80	6.00	94
	Back	1.60	1.80	1.90	2.00	30.5
	Seat	2.10	2.40	2.50	2.60	38.2
	Arm	1.90	2.20	2.30	2.40	36
K82LH18LTL LLS	Entire Unit	3.00	3.50	3.60	3.80	57
	Back	1.60	1.80	1.90	2.00	30.5
	Seat	2.10	2.40	2.50	2.60	38.2
K82LH18LTLWS	Entire Unit	3.00	3.50	3.60	3.80	57
	Back	1.60	1.80	1.90	2.00	30.5
	Seat	2.10	2.40	2.50	2.60	38.2
K82LH18LTT	Entire Unit	3.90	4.50	4.70	4.90	75.5
	Back	1.60	1.80	1.90	2.00	30.5
	Seat	2.10	2.40	2.50	2.60	38.2
	Arm	1.00	1.20	1.20	1.30	20
K82LH18LTT8RAT	Entire Unit	4.70	5.40	5.60	5.90	91.5
	Back	1.60	1.80	1.90	2.00	30.5
	Seat	2.10	2.40	2.50	2.60	38.2
	Arm	1.80	2.10	2.20	2.30	36
K82LH18LTT8RAU	Entire Unit	4.80	5.50	5.80	6.00	94
	Back	1.60	1.80	1.90	2.00	30.5
	Seat	2.10	2.40	2.50	2.60	38.2
	Arm	1.90	2.20	2.30	2.40	36
K82LH18LTT LLS	Entire Unit	3.00	3.50	3.60	3.80	57
	Back	1.60	1.80	1.90	2.00	30.5
	Seat	2.10	2.40	2.50	2.60	38.2
K82LH18LTTWS	Entire Unit	3.00	3.50	3.60	3.80	57
	Back	1.60	1.80	1.90	2.00	30.5
	Seat	2.10	2.40	2.50	2.60	38.2
K82LH18LTW	Entire Unit	3.90	4.50	4.70	4.90	75.5
	Back	1.60	1.80	1.90	2.00	30.5
	Seat	2.10	2.40	2.50	2.60	38.2
	Arm	1.00	1.20	1.20	1.30	20
K82LH18LTW8RAU	Entire Unit	4.80	5.50	5.80	6.00	94
	Back	1.60	1.80	1.90	2.00	30.5
	Seat	2.10	2.40	2.50	2.60	38.2
	Arm	1.90	2.20	2.30	2.40	36

COM YARDAGE REQUIREMENTS

COM YARDAGE REQUIREMENTS (54" WIDTH – CUT UP THE ROLL)

MODEL	RAILOADED Contact customer service 800-634-9510 for ydg requirements	NON DIRECTIONAL OR SOLID	1"-4" REPEAT	5"-11" REPEAT	12"-18" REPEAT	COL SQUARE FEET
			4" VERTICAL X 4" HORIZONTAL	11" VERTICAL X 11" HORIZONTAL	18" VERTICAL X 18" HORIZONTAL	
K82LH18LTW8RAW	Entire Unit	4.70	5.40	5.60	5.90	91.5
	Back	1.60	1.80	1.90	2.00	30.5
	Seat	2.10	2.40	2.50	2.60	38.2
	Arm	1.80	2.10	2.20	2.30	36
K82LH18LTWLLS	Entire Unit	3.00	3.50	3.60	3.80	57
	Back	1.60	1.80	1.90	2.00	30.5
	Seat	2.10	2.40	2.50	2.60	38.2
K82LH18LTWWS	Entire Unit	3.00	3.50	3.60	3.80	57
	Back	1.60	1.80	1.90	2.00	30.5
	Seat	2.10	2.40	2.50	2.60	38.2
K82LH18RAS	Entire Unit	3.90	4.50	4.70	4.90	75.5
	Back	1.60	1.80	1.90	2.00	30.5
	Seat	2.10	2.40	2.50	2.60	38.2
	Arm	1.00	1.20	1.20	1.30	20
K82LH18RAT	Entire Unit	3.90	4.50	4.70	4.90	75.5
	Back	1.60	1.80	1.90	2.00	30.5
	Seat	2.10	2.40	2.50	2.60	38.2
	Arm	1.00	1.20	1.20	1.30	20
K82LH18RAU	Entire Unit	3.90	4.50	4.70	4.90	75.5
	Back	1.60	1.80	1.90	2.00	30.5
	Seat	2.10	2.40	2.50	2.60	38.2
	Arm	1.00	1.20	1.20	1.30	20
K82LH18RAW	Entire Unit	3.90	4.50	4.70	4.90	75.5
	Back	1.60	1.80	1.90	2.00	30.5
	Seat	2.10	2.40	2.50	2.60	38.2
	Arm	1.00	1.20	1.20	1.30	20
K82LH18RTL	Entire Unit	3.90	4.50	4.70	4.90	75.5
	Back	1.60	1.80	1.90	2.00	30.5
	Seat	2.10	2.40	2.50	2.60	38.2
	Arm	1.00	1.20	1.20	1.30	20
K82LH18RTL LLS	Entire Unit	3.00	3.50	3.60	3.80	57
	Back	1.60	1.80	1.90	2.00	30.5
	Seat	2.10	2.40	2.50	2.60	38.2
K82LH18RTLWS	Entire Unit	3.00	3.50	3.60	3.80	57
	Back	1.60	1.80	1.90	2.00	30.5
	Seat	2.10	2.40	2.50	2.60	38.2
K82LH18RTT	Entire Unit	3.90	4.50	4.70	4.90	75.5
	Back	1.60	1.80	1.90	2.00	30.5
	Seat	2.10	2.40	2.50	2.60	38.2
	Arm	1.00	1.20	1.20	1.30	20
K82LH18RTT LLS	Entire Unit	3.00	3.50	3.60	3.80	57
	Back	1.60	1.80	1.90	2.00	30.5
	Seat	2.10	2.40	2.50	2.60	38.2
K82LH18RTTWS	Entire Unit	3.00	3.50	3.60	3.80	57
	Back	1.60	1.80	1.90	2.00	30.5
	Seat	2.10	2.40	2.50	2.60	38.2
K82LH18RTW	Entire Unit	3.90	4.50	4.70	4.90	75.5
	Back	1.60	1.80	1.90	2.00	30.5
	Seat	2.10	2.40	2.50	2.60	38.2
	Arm	1.00	1.20	1.20	1.30	20
K82LH18RTW LLS	Entire Unit	3.00	3.50	3.60	3.80	57
	Back	1.60	1.80	1.90	2.00	30.5
	Seat	2.10	2.40	2.50	2.60	38.2
K82LH18RTWWS	Entire Unit	3.00	3.50	3.60	3.80	57
	Back	1.60	1.80	1.90	2.00	30.5
	Seat	2.10	2.40	2.50	2.60	38.2
K82LH1TLAS	Entire Unit	3.90	4.50	4.70	4.90	75.5
	Back	1.60	1.80	1.90	2.00	30.5
	Seat	2.10	2.40	2.50	2.60	38.2
	Arm	1.00	1.20	1.20	1.30	20

COM YARDAGE REQUIREMENTS

COM YARDAGE REQUIREMENTS (54" WIDTH – CUT UP THE ROLL)

MODEL	RAILROADED Contact customer service 800-634-9510 for ydg requirements	NON DIRECTIONAL OR SOLID	1"-4" REPEAT	5"-11" REPEAT	12"-18" REPEAT	COL SQUARE FEET
			4" VERTICAL X 4" HORIZONTAL	11" VERTICAL X 11" HORIZONTAL	18" VERTICAL X 18" HORIZONTAL	
K82LH1TLAS2RAS	Entire Unit	4.80	5.50	5.80	6.00	94
	Back	1.60	1.80	1.90	2.00	30.5
	Seat	2.10	2.40	2.50	2.60	38.2
	Arm	1.90	2.20	2.30	2.40	38
K82LH1TLAS8RAS	Entire Unit	4.70	5.40	5.60	5.90	91.5
	Back	1.60	1.80	1.90	2.00	30.5
	Seat	2.10	2.40	2.50	2.60	38.2
	Arm	1.80	2.10	2.20	2.30	36
K82LH1TLAT	Entire Unit	3.90	4.50	4.70	4.90	75.5
	Back	1.60	1.80	1.90	2.00	30.5
	Seat	2.10	2.40	2.50	2.60	38.2
	Arm	1.00	1.20	1.20	1.30	20
K82LH1TLAT2RAT	Entire Unit	4.80	5.50	5.80	6.00	94
	Back	1.60	1.80	1.90	2.00	30.5
	Seat	2.10	2.40	2.50	2.60	38.2
	Arm	1.90	2.20	2.30	2.40	38
K82LH1TLAT8RAT	Entire Unit	4.70	5.40	5.60	5.90	91.5
	Back	1.60	1.80	1.90	2.00	30.5
	Seat	2.10	2.40	2.50	2.60	38.2
	Arm	1.80	2.10	2.20	2.30	36
K82LH1TLAU	Entire Unit	3.90	4.50	4.70	4.90	75.5
	Back	1.60	1.80	1.90	2.00	30.5
	Seat	2.10	2.40	2.50	2.60	38.2
	Arm	1.00	1.20	1.20	1.30	20
K82LH1TLAU2RAU	Entire Unit	4.80	5.50	5.80	6.00	94
	Back	1.60	1.80	1.90	2.00	30.5
	Seat	2.10	2.40	2.50	2.60	38.2
	Arm	1.90	2.20	2.30	2.40	38
K82LH1TLAU8RAU	Entire Unit	4.80	5.50	5.80	6.00	94
	Back	1.60	1.80	1.90	2.00	30.5
	Seat	2.10	2.40	2.50	2.60	38.2
	Arm	1.90	2.20	2.30	2.40	36
K82LH1TLAW	Entire Unit	3.90	4.50	4.70	4.90	75.5
	Back	1.60	1.80	1.90	2.00	30.5
	Seat	2.10	2.40	2.50	2.60	38.2
	Arm	1.00	1.20	1.20	1.30	20
K82LH1TLAW2RAW	Entire Unit	4.80	5.50	5.80	6.00	94
	Back	1.60	1.80	1.90	2.00	30.5
	Seat	2.10	2.40	2.50	2.60	38.2
	Arm	1.90	2.20	2.30	2.40	38
K82LH1TLAW8RAW	Entire Unit	4.70	5.40	5.60	5.90	91.5
	Back	1.60	1.80	1.90	2.00	30.5
	Seat	2.10	2.40	2.50	2.60	38.2
	Arm	1.80	2.10	2.20	2.30	36
K82LH1TLLLS	Entire Unit	3.00	3.50	3.60	3.80	57
	Back	1.60	1.80	1.90	2.00	30.5
	Seat	2.10	2.40	2.50	2.60	38.2
K82LH1TLLLS2RAT	Entire Unit	3.90	4.50	4.70	4.90	75.5
	Back	1.60	1.80	1.90	2.00	30.5
	Seat	2.10	2.40	2.50	2.60	38.2
	Arm	1.00	1.20	1.20	1.30	20
K82LH1TLLLS2RAU	Entire Unit	3.90	4.50	4.70	4.90	75.5
	Back	1.60	1.80	1.90	2.00	30.5
	Seat	2.10	2.40	2.50	2.60	38.2
	Arm	1.00	1.20	1.20	1.30	20
K82LH1TLLLS8RAT	Entire Unit	3.90	4.50	4.70	4.90	75.5
	Back	1.60	1.80	1.90	2.00	30.5
	Seat	2.10	2.40	2.50	2.60	38.2
	Arm	1.00	1.20	1.20	1.30	20

COM YARDAGE REQUIREMENTS

COM YARDAGE REQUIREMENTS (54" WIDTH – CUT UP THE ROLL)

MODEL	RAILOADED Contact customer service 800-634-9510 for ydg requirements	NON DIRECTIONAL OR SOLID	1"-4" REPEAT	5"-11" REPEAT	12"-18" REPEAT	COL SQUARE FEET
			4" VERTICAL X 4" HORIZONTAL	11" VERTICAL X 11" HORIZONTAL	18" VERTICAL X 18" HORIZONTAL	
K82LH1TLLS8RAU	Entire Unit	3.90	4.50	4.70	4.90	75.5
	Back	1.60	1.80	1.90	2.00	30.5
	Seat	2.10	2.40	2.50	2.60	38.2
	Arm	1.00	1.20	1.20	1.30	20
K82LH1TLWS	Entire Unit	3.00	3.50	3.60	3.80	57
	Back	1.60	1.80	1.90	2.00	30.5
	Seat	2.10	2.40	2.50	2.60	38.2
K82LH1TLWS2RAU	Entire Unit	3.90	4.50	4.70	4.90	75.5
	Back	1.60	1.80	1.90	2.00	30.5
	Seat	2.10	2.40	2.50	2.60	38.2
	Arm	1.00	1.20	1.20	1.30	20
K82LH1TLWS2RAW	Entire Unit	3.90	4.50	4.70	4.90	75.5
	Back	1.60	1.80	1.90	2.00	30.5
	Seat	2.10	2.40	2.50	2.60	38.2
	Arm	1.00	1.20	1.20	1.30	20
K82LH1TLWS8RAU	Entire Unit	3.90	4.50	4.70	4.90	75.5
	Back	1.60	1.80	1.90	2.00	30.5
	Seat	2.10	2.40	2.50	2.60	38.2
	Arm	1.00	1.20	1.20	1.30	20
K82LH1TLWS8RAW	Entire Unit	3.90	4.50	4.70	4.90	75.5
	Back	1.60	1.80	1.90	2.00	30.5
	Seat	2.10	2.40	2.50	2.60	38.2
	Arm	1.00	1.20	1.20	1.30	20
K82LH1TRAS	Entire Unit	3.90	4.50	4.70	4.90	75.5
	Back	1.60	1.80	1.90	2.00	30.5
	Seat	2.10	2.40	2.50	2.60	38.2
	Arm	1.00	1.20	1.20	1.30	20
K82LH1TRAT	Entire Unit	3.90	4.50	4.70	4.90	75.5
	Back	1.60	1.80	1.90	2.00	30.5
	Seat	2.10	2.40	2.50	2.60	38.2
	Arm	1.00	1.20	1.20	1.30	20
K82LH1TRAU	Entire Unit	3.90	4.50	4.70	4.90	75.5
	Back	1.60	1.80	1.90	2.00	30.5
	Seat	2.10	2.40	2.50	2.60	38.2
	Arm	1.00	1.20	1.20	1.30	20
K82LH1TRAW	Entire Unit	3.90	4.50	4.70	4.90	75.5
	Back	1.60	1.80	1.90	2.00	30.5
	Seat	2.10	2.40	2.50	2.60	38.2
	Arm	1.00	1.20	1.20	1.30	20
K82LH1TRLLS	Entire Unit	3.00	3.50	3.60	3.80	57
	Back	1.60	1.80	1.90	2.00	30.5
	Seat	2.10	2.40	2.50	2.60	38.2
K82LH1TRWS	Entire Unit	3.00	3.50	3.60	3.80	57
	Back	1.60	1.80	1.90	2.00	30.5
	Seat	2.10	2.40	2.50	2.60	38.2
K82LH2	Entire Unit	5.80	6.70	7.00	7.30	112.4
	Back	3.10	3.60	3.70	3.90	60.4
	Seat	2.80	3.20	3.40	3.50	53.2
K82LH22LAP	Entire Unit	6.70	7.70	8.00	8.40	130.9
	Back	3.10	3.60	3.70	3.90	60.4
	Seat	2.80	3.20	3.40	3.50	53.2
	Arm	1.00	1.20	1.20	1.30	20
K82LH22LAP2RAP	Entire Unit	7.50	8.60	9.00	9.40	145.9
	Back	3.10	3.60	3.70	3.90	60.4
	Seat	2.80	3.20	3.40	3.50	53.2
	Arm	1.80	2.10	2.20	2.30	34
K82LH22LAS	Entire Unit	6.70	7.70	8.00	8.40	130.9
	Back	3.10	3.60	3.70	3.90	60.4
	Seat	2.80	3.20	3.40	3.50	53.2
	Arm	1.00	1.20	1.20	1.30	20

COM YARDAGE REQUIREMENTS

COM YARDAGE REQUIREMENTS (54" WIDTH – CUT UP THE ROLL)

MODEL	RAILROADED Contact customer service 800-634-9510 for ydg requirements	NON DIRECTIONAL OR SOLID	1"-4" REPEAT	5"-11" REPEAT	12"-18" REPEAT	COL SQUARE FEET
			4" VERTICAL X 4" HORIZONTAL	11" VERTICAL X 11" HORIZONTAL	18" VERTICAL X 18" HORIZONTAL	
K82LH22LAS2RAS	Entire Unit	7.50	8.60	9.00	9.40	145.9
	Back	3.10	3.60	3.70	3.90	60.4
	Seat	2.80	3.20	3.40	3.50	53.2
	Arm	1.80	2.10	2.20	2.30	34
K82LH22LASTRAS	Entire Unit	7.50	8.60	9.00	9.40	145.9
	Back	3.10	3.60	3.70	3.90	60.4
	Seat	2.80	3.20	3.40	3.50	53.2
	Arm	1.90	2.20	2.30	2.40	38
K82LH22LAT	Entire Unit	6.70	7.70	8.00	8.40	130.9
	Back	3.10	3.60	3.70	3.90	60.4
	Seat	2.80	3.20	3.40	3.50	53.2
	Arm	1.00	1.20	1.20	1.30	20
K82LH22LAT2RAT	Entire Unit	7.50	8.60	9.00	9.40	145.9
	Back	3.10	3.60	3.70	3.90	60.4
	Seat	2.80	3.20	3.40	3.50	53.2
	Arm	1.80	2.10	2.20	2.30	34
K82LH22LAT2RTT	Entire Unit	7.50	8.60	9.00	9.40	145.9
	Back	3.10	3.60	3.70	3.90	60.4
	Seat	2.80	3.20	3.40	3.50	53.2
	Arm	1.80	2.10	2.20	2.30	34
K82LH22LATTRAT	Entire Unit	7.50	8.60	9.00	9.40	145.9
	Back	3.10	3.60	3.70	3.90	60.4
	Seat	2.80	3.20	3.40	3.50	53.2
	Arm	1.90	2.20	2.30	2.40	38
K82LH22LAU	Entire Unit	6.70	7.70	8.00	8.40	130.9
	Back	3.10	3.60	3.70	3.90	60.4
	Seat	2.80	3.20	3.40	3.50	53.2
	Arm	1.00	1.20	1.20	1.30	20
K82LH22LAU2RAU	Entire Unit	7.60	8.70	9.10	9.50	148.4
	Back	3.10	3.60	3.70	3.90	60.4
	Seat	2.80	3.20	3.40	3.50	53.2
	Arm	1.90	2.20	2.30	2.40	36
K82LH22LAU2RTL	Entire Unit	7.60	8.70	9.10	9.50	148.4
	Back	3.10	3.60	3.70	3.90	60.4
	Seat	2.80	3.20	3.40	3.50	53.2
	Arm	1.90	2.20	2.30	2.40	36
K82LH22LAU2RTT	Entire Unit	7.60	8.70	9.10	9.50	148.4
	Back	3.10	3.60	3.70	3.90	60.4
	Seat	2.80	3.20	3.40	3.50	53.2
	Arm	1.90	2.20	2.30	2.40	36
K82LH22LAU2RTW	Entire Unit	7.60	8.70	9.10	9.50	148.4
	Back	3.10	3.60	3.70	3.90	60.4
	Seat	2.80	3.20	3.40	3.50	53.2
	Arm	1.90	2.20	2.30	2.40	36
K82LH22LAUTRAU	Entire Unit	7.60	8.70	9.10	9.50	148.4
	Back	3.10	3.60	3.70	3.90	60.4
	Seat	2.80	3.20	3.40	3.50	53.2
	Arm	1.90	2.20	2.30	2.40	38
K82LH22LAW	Entire Unit	6.70	7.70	8.00	8.40	130.9
	Back	3.10	3.60	3.70	3.90	60.4
	Seat	2.80	3.20	3.40	3.50	53.2
	Arm	1.00	1.20	1.20	1.30	20
K82LH22LAW2RAW	Entire Unit	7.50	8.60	9.00	9.40	145.9
	Back	3.10	3.60	3.70	3.90	60.4
	Seat	2.80	3.20	3.40	3.50	53.2
	Arm	1.80	2.10	2.20	2.30	34
K82LH22LAW2RTW	Entire Unit	7.50	8.60	9.00	9.40	145.9
	Back	3.10	3.60	3.70	3.90	60.4
	Seat	2.80	3.20	3.40	3.50	53.2
	Arm	1.80	2.10	2.20	2.30	34

COM YARDAGE REQUIREMENTS

COM YARDAGE REQUIREMENTS (54" WIDTH – CUT UP THE ROLL)

MODEL	RAILROADED Contact customer service 800-634-9510 for ydg requirements	NON DIRECTIONAL OR SOLID	1"-4" REPEAT	5"-11" REPEAT	12"-18" REPEAT	COL SQUARE FEET
			4" VERTICAL X 4" HORIZONTAL	11" VERTICAL X 11" HORIZONTAL	18" VERTICAL X 18" HORIZONTAL	
K82LH22LAWTRAW	Entire Unit	7.50	8.60	9.00	9.40	145.9
	Back	3.10	3.60	3.70	3.90	60.4
	Seat	2.80	3.20	3.40	3.50	53.2
	Arm	1.90	2.20	2.30	2.40	38
K82LH22LTL	Entire Unit	6.70	7.70	8.00	8.40	130.9
	Back	3.10	3.60	3.70	3.90	60.4
	Seat	2.80	3.20	3.40	3.50	53.2
	Arm	1.00	1.20	1.20	1.30	20
K82LH22LTL2RAU	Entire Unit	6.70	7.70	8.00	8.40	130.9
	Back	3.10	3.60	3.70	3.90	60.4
	Seat	2.80	3.20	3.40	3.50	53.2
	Arm	1.00	1.20	1.20	1.30	20
K82LH22LTT	Entire Unit	6.70	7.70	8.00	8.40	130.9
	Back	3.10	3.60	3.70	3.90	60.4
	Seat	2.80	3.20	3.40	3.50	53.2
	Arm	1.00	1.20	1.20	1.30	20
K82LH22LTT2RAT	Entire Unit	7.50	8.60	9.00	9.40	145.9
	Back	3.10	3.60	3.70	3.90	60.4
	Seat	2.80	3.20	3.40	3.50	53.2
	Arm	1.80	2.10	2.20	2.30	34
K82LH22LTT2RAU	Entire Unit	7.60	8.70	9.10	9.50	148.4
	Back	3.10	3.60	3.70	3.90	60.4
	Seat	2.80	3.20	3.40	3.50	53.2
	Arm	1.90	2.20	2.30	2.40	36
K82LH22LTW	Entire Unit	6.70	7.70	8.00	8.40	130.9
	Back	3.10	3.60	3.70	3.90	60.4
	Seat	2.80	3.20	3.40	3.50	53.2
	Arm	1.00	1.20	1.20	1.30	20
K82LH22LTW2RAU	Entire Unit	7.60	8.70	9.10	9.50	148.4
	Back	3.10	3.60	3.70	3.90	60.4
	Seat	2.80	3.20	3.40	3.50	53.2
	Arm	1.90	2.20	2.30	2.40	36
K82LH22LTW2RAW	Entire Unit	7.50	8.60	9.00	9.40	145.9
	Back	3.10	3.60	3.70	3.90	60.4
	Seat	2.80	3.20	3.40	3.50	53.2
	Arm	1.80	2.10	2.20	2.30	34
K82LH22RAP	Entire Unit	6.70	7.70	8.00	8.40	130.9
	Back	3.10	3.60	3.70	3.90	60.4
	Seat	2.80	3.20	3.40	3.50	53.2
	Arm	1.00	1.20	1.20	1.30	20
K82LH22RAS	Entire Unit	6.70	7.70	8.00	8.40	130.9
	Back	3.10	3.60	3.70	3.90	60.4
	Seat	2.80	3.20	3.40	3.50	53.2
	Arm	1.00	1.20	1.20	1.30	20
K82LH22RAT	Entire Unit	6.70	7.70	8.00	8.40	130.9
	Back	3.10	3.60	3.70	3.90	60.4
	Seat	2.80	3.20	3.40	3.50	53.2
	Arm	1.00	1.20	1.20	1.30	20
K82LH22RAU	Entire Unit	6.70	7.70	8.00	8.40	130.9
	Back	3.10	3.60	3.70	3.90	60.4
	Seat	2.80	3.20	3.40	3.50	53.2
	Arm	1.00	1.20	1.20	1.30	20
K82LH22RAW	Entire Unit	6.70	7.70	8.00	8.40	130.9
	Back	3.10	3.60	3.70	3.90	60.4
	Seat	2.80	3.20	3.40	3.50	53.2
	Arm	1.00	1.20	1.20	1.30	20
K82LH22RTL	Entire Unit	6.70	7.70	8.00	8.40	130.9
	Back	3.10	3.60	3.70	3.90	60.4
	Seat	2.80	3.20	3.40	3.50	53.2
	Arm	1.00	1.20	1.20	1.30	20

COM YARDAGE REQUIREMENTS

COM YARDAGE REQUIREMENTS (54" WIDTH – CUT UP THE ROLL)

MODEL	RAILROADED Contact customer service 800-634-9510 for ydg requirements	NON DIRECTIONAL OR SOLID	1"-4" REPEAT	5"-11" REPEAT	12"-18" REPEAT	COL SQUARE FEET
			4" VERTICAL X 4" HORIZONTAL	11" VERTICAL X 11" HORIZONTAL	18" VERTICAL X 18" HORIZONTAL	
K82LH22RTT	Entire Unit	6.70	7.70	8.00	8.40	130.9
	Back	3.10	3.60	3.70	3.90	60.4
	Seat	2.80	3.20	3.40	3.50	53.2
	Arm	1.00	1.20	1.20	1.30	20
K82LH22RTW	Entire Unit	6.70	7.70	8.00	8.40	130.9
	Back	3.10	3.60	3.70	3.90	60.4
	Seat	2.80	3.20	3.40	3.50	53.2
	Arm	1.00	1.20	1.20	1.30	20
K82LH28LAS	Entire Unit	6.70	7.70	8.00	8.40	130.9
	Back	3.10	3.60	3.70	3.90	60.4
	Seat	2.80	3.20	3.40	3.50	53.2
	Arm	1.00	1.20	1.20	1.30	20
K82LH28LAS8RAS	Entire Unit	7.50	8.60	9.00	9.40	145.9
	Back	3.10	3.60	3.70	3.90	60.4
	Seat	2.80	3.20	3.40	3.50	53.2
	Arm	1.80	2.10	2.20	2.30	36
K82LH28LASTRAS	Entire Unit	7.50	8.60	9.00	9.40	145.9
	Back	3.10	3.60	3.70	3.90	60.4
	Seat	2.80	3.20	3.40	3.50	53.2
	Arm	1.80	2.10	2.20	2.30	36
K82LH28LAT	Entire Unit	6.70	7.70	8.00	8.40	130.9
	Back	3.10	3.60	3.70	3.90	60.4
	Seat	2.80	3.20	3.40	3.50	53.2
	Arm	1.00	1.20	1.20	1.30	20
K82LH28LAT8RAT	Entire Unit	7.50	8.60	9.00	9.40	145.9
	Back	3.10	3.60	3.70	3.90	60.4
	Seat	2.80	3.20	3.40	3.50	53.2
	Arm	1.80	2.10	2.20	2.30	36
K82LH28LAT8RTT	Entire Unit	7.60	8.70	9.10	9.50	148.4
	Back	3.10	3.60	3.70	3.90	60.4
	Seat	2.80	3.20	3.40	3.50	53.2
	Arm	1.80	2.10	2.20	2.30	36
K82LH28LAT8RAT	Entire Unit	7.50	8.60	9.00	9.40	145.9
	Back	3.10	3.60	3.70	3.90	60.4
	Seat	2.80	3.20	3.40	3.50	53.2
	Arm	1.80	2.10	2.20	2.30	36
K82LH28LAU	Entire Unit	6.70	7.70	8.00	8.40	130.9
	Back	3.10	3.60	3.70	3.90	60.4
	Seat	2.80	3.20	3.40	3.50	53.2
	Arm	1.00	1.20	1.20	1.30	20
K82LH28LAU8RAU	Entire Unit	7.60	8.70	9.10	9.50	148.4
	Back	3.10	3.60	3.70	3.90	60.4
	Seat	2.80	3.20	3.40	3.50	53.2
	Arm	1.90	2.20	2.30	2.40	36
K82LH28LAU8RTL	Entire Unit	7.60	8.70	9.10	9.50	148.4
	Back	3.10	3.60	3.70	3.90	60.4
	Seat	2.80	3.20	3.40	3.50	53.2
	Arm	1.90	2.20	2.30	2.40	36
K82LH28LAU8RTT	Entire Unit	7.60	8.70	9.10	9.50	148.4
	Back	3.10	3.60	3.70	3.90	60.4
	Seat	2.80	3.20	3.40	3.50	53.2
	Arm	1.90	2.20	2.30	2.40	36
K82LH28LAU8RTW	Entire Unit	7.60	8.70	9.10	9.50	148.4
	Back	3.10	3.60	3.70	3.90	60.4
	Seat	2.80	3.20	3.40	3.50	53.2
	Arm	1.90	2.20	2.30	2.40	36
K82LH28LAU8TRAU	Entire Unit	7.60	8.70	9.10	9.50	148.4
	Back	3.10	3.60	3.70	3.90	60.4
	Seat	2.80	3.20	3.40	3.50	53.2
	Arm	1.90	2.20	2.30	2.40	36

COM YARDAGE REQUIREMENTS

COM YARDAGE REQUIREMENTS (54" WIDTH – CUT UP THE ROLL)

MODEL	RAILROADED Contact customer service 800-634-9510 for ydg requirements	NON DIRECTIONAL OR SOLID	1"-4" REPEAT	5"-11" REPEAT	12"-18" REPEAT	COL SQUARE FEET
			4" VERTICAL X 4" HORIZONTAL	11" VERTICAL X 11" HORIZONTAL	18" VERTICAL X 18" HORIZONTAL	
K82LH28LAW	Entire Unit	6.70	7.70	8.00	8.40	130.9
	Back	3.10	3.60	3.70	3.90	60.4
	Seat	2.80	3.20	3.40	3.50	53.2
	Arm	1.00	1.20	1.20	1.30	20
K82LH28LAW8RAW	Entire Unit	7.50	8.60	9.00	9.40	145.9
	Back	3.10	3.60	3.70	3.90	60.4
	Seat	2.80	3.20	3.40	3.50	53.2
	Arm	1.80	2.10	2.20	2.30	36
K82LH28LAW8RTW	Entire Unit	7.60	8.70	9.10	9.50	148.4
	Back	3.10	3.60	3.70	3.90	60.4
	Seat	2.80	3.20	3.40	3.50	53.2
	Arm	1.80	2.10	2.20	2.30	36
K82LH28LAWTRAW	Entire Unit	7.50	8.60	9.00	9.40	145.9
	Back	3.10	3.60	3.70	3.90	60.4
	Seat	2.80	3.20	3.40	3.50	53.2
	Arm	1.80	2.10	2.20	2.30	36
K82LH28LTL	Entire Unit	6.70	7.70	8.00	8.40	130.9
	Back	3.10	3.60	3.70	3.90	60.4
	Seat	2.80	3.20	3.40	3.50	53.2
	Arm	1.00	1.20	1.20	1.30	20
K82LH28LTL8RAU	Entire Unit	7.60	8.70	9.10	9.50	148.4
	Back	3.10	3.60	3.70	3.90	60.4
	Seat	2.80	3.20	3.40	3.50	53.2
	Arm	1.90	2.20	2.30	2.40	36
K82LH28LTL8RTL	Entire Unit	7.60	8.70	9.10	9.50	148.4
	Back	3.10	3.60	3.70	3.90	60.4
	Seat	2.80	3.20	3.40	3.50	53.2
	Arm	1.90	2.20	2.30	2.40	36
K82LH28LTT	Entire Unit	6.70	7.70	8.00	8.40	130.9
	Back	3.10	3.60	3.70	3.90	60.4
	Seat	2.80	3.20	3.40	3.50	53.2
	Arm	1.00	1.20	1.20	1.30	20
K82LH28LTT8RAT	Entire Unit	7.60	8.70	9.10	9.50	148.4
	Back	3.10	3.60	3.70	3.90	60.4
	Seat	2.80	3.20	3.40	3.50	53.2
	Arm	1.80	2.10	2.20	2.30	36
K82LH28LTT8RAU	Entire Unit	7.60	8.70	9.10	9.50	148.4
	Back	3.10	3.60	3.70	3.90	60.4
	Seat	2.80	3.20	3.40	3.50	53.2
	Arm	1.90	2.20	2.30	2.40	36
K82LH28LTT8RTT	Entire Unit	7.60	8.70	9.10	9.50	148.4
	Back	3.10	3.60	3.70	3.90	60.4
	Seat	2.80	3.20	3.40	3.50	53.2
	Arm	1.90	2.20	2.30	2.40	36
K82LH28LTW	Entire Unit	6.70	7.70	8.00	8.40	130.9
	Back	3.10	3.60	3.70	3.90	60.4
	Seat	2.80	3.20	3.40	3.50	53.2
	Arm	1.00	1.20	1.20	1.30	20
K82LH28LTW8RAU	Entire Unit	7.60	8.70	9.10	9.50	148.4
	Back	3.10	3.60	3.70	3.90	60.4
	Seat	2.80	3.20	3.40	3.50	53.2
	Arm	1.90	2.20	2.30	2.40	36
K82LH28LTW8RAW	Entire Unit	7.60	8.70	9.10	9.50	148.4
	Back	3.10	3.60	3.70	3.90	60.4
	Seat	2.80	3.20	3.40	3.50	53.2
	Arm	1.80	2.10	2.20	2.30	36
K82LH28LTW8RTW	Entire Unit	7.60	8.70	9.10	9.50	148.4
	Back	3.10	3.60	3.70	3.90	60.4
	Seat	2.80	3.20	3.40	3.50	53.2
	Arm	1.90	2.20	2.30	2.40	36

COM YARDAGE REQUIREMENTS

COM YARDAGE REQUIREMENTS (54" WIDTH – CUT UP THE ROLL)

MODEL	RAILROADED Contact customer service 800-634-9510 for ydg requirements	NON DIRECTIONAL OR SOLID	1"-4" REPEAT	5"-11" REPEAT	12"-18" REPEAT	COL SQUARE FEET
			4" VERTICAL X 4" HORIZONTAL	11" VERTICAL X 11" HORIZONTAL	18" VERTICAL X 18" HORIZONTAL	
K82LH28RAS	Entire Unit	6.70	7.70	8.00	8.40	130.9
	Back	3.10	3.60	3.70	3.90	60.4
	Seat	2.80	3.20	3.40	3.50	53.2
	Arm	1.00	1.20	1.20	1.30	20
K82LH28RAT	Entire Unit	6.70	7.70	8.00	8.40	130.9
	Back	3.10	3.60	3.70	3.90	60.4
	Seat	2.80	3.20	3.40	3.50	53.2
	Arm	1.00	1.20	1.20	1.30	20
K82LH28RAU	Entire Unit	6.70	7.70	8.00	8.40	130.9
	Back	3.10	3.60	3.70	3.90	60.4
	Seat	2.80	3.20	3.40	3.50	53.2
	Arm	1.00	1.20	1.20	1.30	20
K82LH28RAW	Entire Unit	6.70	7.70	8.00	8.40	130.9
	Back	3.10	3.60	3.70	3.90	60.4
	Seat	2.80	3.20	3.40	3.50	53.2
	Arm	1.00	1.20	1.20	1.30	20
K82LH28RTL	Entire Unit	6.70	7.70	8.00	8.40	130.9
	Back	3.10	3.60	3.70	3.90	60.4
	Seat	2.80	3.20	3.40	3.50	53.2
	Arm	1.00	1.20	1.20	1.30	20
K82LH28RTT	Entire Unit	6.70	7.70	8.00	8.40	130.9
	Back	3.10	3.60	3.70	3.90	60.4
	Seat	2.80	3.20	3.40	3.50	53.2
	Arm	1.00	1.20	1.20	1.30	20
K82LH28RTW	Entire Unit	6.70	7.70	8.00	8.40	130.9
	Back	3.10	3.60	3.70	3.90	60.4
	Seat	2.80	3.20	3.40	3.50	53.2
	Arm	1.00	1.20	1.20	1.30	20
K82LH2TLAS	Entire Unit	6.70	7.70	8.00	8.40	130.9
	Back	3.10	3.60	3.70	3.90	60.4
	Seat	2.80	3.20	3.40	3.50	53.2
	Arm	1.00	1.20	1.20	1.30	20
K82LH2TLAS2RAS	Entire Unit	7.50	8.60	9.00	9.40	145.9
	Back	3.10	3.60	3.70	3.90	60.4
	Seat	2.80	3.20	3.40	3.50	53.2
	Arm	1.90	2.20	2.30	2.40	38
K82LH2TLAS8RAS	Entire Unit	7.50	8.60	9.00	9.40	145.9
	Back	3.10	3.60	3.70	3.90	60.4
	Seat	2.80	3.20	3.40	3.50	53.2
	Arm	1.80	2.10	2.20	2.30	36
K82LH2TLASTRAS	Entire Unit	7.60	8.70	9.10	9.50	148.4
	Back	3.10	3.60	3.70	3.90	60.4
	Seat	2.80	3.20	3.40	3.50	53.2
	Arm	1.90	2.20	2.30	2.40	36
K82LH2TLAT	Entire Unit	6.70	7.70	8.00	8.40	130.9
	Back	3.10	3.60	3.70	3.90	60.4
	Seat	2.80	3.20	3.40	3.50	53.2
	Arm	1.00	1.20	1.20	1.30	20
K82LH2TLAT2RAT	Entire Unit	7.50	8.60	9.00	9.40	145.9
	Back	3.10	3.60	3.70	3.90	60.4
	Seat	2.80	3.20	3.40	3.50	53.2
	Arm	1.90	2.20	2.30	2.40	38
K82LH2TLAT8RAT	Entire Unit	7.50	8.60	9.00	9.40	145.9
	Back	3.10	3.60	3.70	3.90	60.4
	Seat	2.80	3.20	3.40	3.50	53.2
	Arm	1.90	2.20	2.30	2.40	38
K82LH2TLATTRAT	Entire Unit	7.60	8.70	9.10	9.50	148.4
	Back	3.10	3.60	3.70	3.90	60.4
	Seat	2.80	3.20	3.40	3.50	53.2
	Arm	1.90	2.20	2.30	2.40	36

COM YARDAGE REQUIREMENTS

COM YARDAGE REQUIREMENTS (54" WIDTH – CUT UP THE ROLL)

MODEL	RAILROADED Contact customer service 800-634-9510 for ydg requirements	NON DIRECTIONAL OR SOLID	1"-4" REPEAT	5"-11" REPEAT	12"-18" REPEAT	COL SQUARE FEET
			4" VERTICAL X 4" HORIZONTAL	11" VERTICAL X 11" HORIZONTAL	18" VERTICAL X 18" HORIZONTAL	
K82LH2TLAU	Entire Unit	6.70	7.70	8.00	8.40	130.9
	Back	3.10	3.60	3.70	3.90	60.4
	Seat	2.80	3.20	3.40	3.50	53.2
	Arm	1.00	1.20	1.20	1.30	20
K82LH2TLAU2RAU	Entire Unit	7.60	8.70	9.10	9.50	148.4
	Back	3.10	3.60	3.70	3.90	60.4
	Seat	2.80	3.20	3.40	3.50	53.2
	Arm	1.90	2.20	2.30	2.40	38
K82LH2TLAU8RAU	Entire Unit	7.60	8.70	9.10	9.50	148.4
	Back	3.10	3.60	3.70	3.90	60.4
	Seat	2.80	3.20	3.40	3.50	53.2
	Arm	1.90	2.20	2.30	2.40	36
K82LH2TLAU8TRAU	Entire Unit	7.60	8.70	9.10	9.50	148.4
	Back	3.10	3.60	3.70	3.90	60.4
	Seat	2.80	3.20	3.40	3.50	53.2
	Arm	1.90	2.20	2.30	2.40	36
K82LH2TLAW	Entire Unit	6.70	7.70	8.00	8.40	130.9
	Back	3.10	3.60	3.70	3.90	60.4
	Seat	2.80	3.20	3.40	3.50	53.2
	Arm	1.00	1.20	1.20	1.30	20
K82LH2TLAW2RAW	Entire Unit	7.50	8.60	9.00	9.40	145.9
	Back	3.10	3.60	3.70	3.90	60.4
	Seat	2.80	3.20	3.40	3.50	53.2
	Arm	1.90	2.20	2.30	2.40	38
K82LH2TLAW8RAW	Entire Unit	7.50	8.60	9.00	9.40	145.9
	Back	3.10	3.60	3.70	3.90	60.4
	Seat	2.80	3.20	3.40	3.50	53.2
	Arm	1.80	2.10	2.20	2.30	36
K82LH2TLAW8TRAU	Entire Unit	7.60	8.70	9.10	9.50	148.4
	Back	3.10	3.60	3.70	3.90	60.4
	Seat	2.80	3.20	3.40	3.50	53.2
	Arm	1.90	2.20	2.30	2.40	36
K82LH2TRAS	Entire Unit	6.70	7.70	8.00	8.40	130.9
	Back	3.10	3.60	3.70	3.90	60.4
	Seat	2.80	3.20	3.40	3.50	53.2
	Arm	1.00	1.20	1.20	1.30	20
K82LH2TRAT	Entire Unit	6.70	7.70	8.00	8.40	130.9
	Back	3.10	3.60	3.70	3.90	60.4
	Seat	2.80	3.20	3.40	3.50	53.2
	Arm	1.00	1.20	1.20	1.30	20
K82LH2TRAU	Entire Unit	6.70	7.70	8.00	8.40	130.9
	Back	3.10	3.60	3.70	3.90	60.4
	Seat	2.80	3.20	3.40	3.50	53.2
	Arm	1.00	1.20	1.20	1.30	20
K82LH2TRAW	Entire Unit	6.70	7.70	8.00	8.40	130.9
	Back	3.10	3.60	3.70	3.90	60.4
	Seat	2.80	3.20	3.40	3.50	53.2
	Arm	1.00	1.20	1.20	1.30	20
K82LH3	Entire Unit	8.70	10.00	10.40	10.90	168.3
	Back	4.50	5.20	5.40	5.60	89.7
	Seat	4.20	4.80	5.00	5.30	79.2
K82LH32LAP	Entire Unit	9.60	11.00	11.50	12.00	186.8
	Back	4.50	5.20	5.40	5.60	89.7
	Seat	4.20	4.80	5.00	5.30	79.2
	Arm	1.00	1.20	1.20	1.30	20
K82LH32LAP2RAP	Entire Unit	10.50	12.10	12.60	13.10	204.3
	Back	4.50	5.20	5.40	5.60	89.7
	Seat	4.20	4.80	5.00	5.30	79.2
	Arm	1.80	2.10	2.20	2.30	34

COM YARDAGE REQUIREMENTS

COM YARDAGE REQUIREMENTS (54" WIDTH – CUT UP THE ROLL)

MODEL	RAILROADED Contact customer service 800-634-9510 for ydg requirements	NON DIRECTIONAL OR SOLID	1"-4" REPEAT	5"-11" REPEAT	12"-18" REPEAT	COL SQUARE FEET
			4" VERTICAL X 4" HORIZONTAL	11" VERTICAL X 11" HORIZONTAL	18" VERTICAL X 18" HORIZONTAL	
K82LH32LAS	Entire Unit	9.60	11.00	11.50	12.00	186.8
	Back	4.50	5.20	5.40	5.60	89.7
	Seat	4.20	4.80	5.00	5.30	79.2
	Arm	1.00	1.20	1.20	1.30	20
K82LH32LAS2RAS	Entire Unit	10.50	12.10	12.60	13.10	204.3
	Back	4.50	5.20	5.40	5.60	89.7
	Seat	4.20	4.80	5.00	5.30	79.2
	Arm	1.80	2.10	2.20	2.30	34
K82LH32LASTRAS	Entire Unit	10.40	12.00	12.50	13.00	202.3
	Back	4.50	5.20	5.40	5.60	89.7
	Seat	4.20	4.80	5.00	5.30	79.2
	Arm	1.90	2.20	2.30	2.40	38
K82LH32LAT	Entire Unit	9.60	11.00	11.50	12.00	186.8
	Back	4.50	5.20	5.40	5.60	89.7
	Seat	4.20	4.80	5.00	5.30	79.2
	Arm	1.00	1.20	1.20	1.30	20
K82LH32LAT2RAT	Entire Unit	10.50	12.10	12.60	13.10	204.3
	Back	4.50	5.20	5.40	5.60	89.7
	Seat	4.20	4.80	5.00	5.30	79.2
	Arm	1.80	2.10	2.20	2.30	34
K82LH32LAT2RTT	Entire Unit	10.40	12.00	12.50	13.00	202.3
	Back	4.50	5.20	5.40	5.60	89.7
	Seat	4.20	4.80	5.00	5.30	79.2
	Arm	1.80	2.10	2.20	2.30	34
K82LH32LATTRAT	Entire Unit	10.40	12.00	12.50	13.00	202.3
	Back	4.50	5.20	5.40	5.60	89.7
	Seat	4.20	4.80	5.00	5.30	79.2
	Arm	1.90	2.20	2.30	2.40	38
K82LH32LAU	Entire Unit	9.60	11.00	11.50	12.00	186.8
	Back	4.50	5.20	5.40	5.60	89.7
	Seat	4.20	4.80	5.00	5.30	79.2
	Arm	1.00	1.20	1.20	1.30	20
K82LH32LAU2RAU	Entire Unit	10.50	12.10	12.60	13.10	204.3
	Back	4.50	5.20	5.40	5.60	89.7
	Seat	4.00	4.60	4.80	5.00	79.2
	Arm	1.90	2.20	2.30	2.40	36
K82LH32LAU2RTL	Entire Unit	10.30	11.80	12.40	12.90	204.3
	Back	4.50	5.20	5.40	5.60	89.7
	Seat	4.00	4.60	4.80	5.00	79.2
	Arm	1.90	2.20	2.30	2.40	36
K82LH32LAU2RTT	Entire Unit	10.30	11.80	12.40	12.90	204.3
	Back	4.50	5.20	5.40	5.60	89.7
	Seat	4.00	4.60	4.80	5.00	79.2
	Arm	1.90	2.20	2.30	2.40	36
K82LH32LAU2RTW	Entire Unit	10.50	12.10	12.60	13.10	204.3
	Back	4.50	5.20	5.40	5.60	89.7
	Seat	4.20	4.80	5.00	5.30	79.2
	Arm	1.90	2.20	2.30	2.40	36
K82LH32LAUTRAU	Entire Unit	10.50	12.10	12.60	13.10	204.3
	Back	4.50	5.20	5.40	5.60	89.7
	Seat	4.20	4.80	5.00	5.30	79.2
	Arm	1.90	2.20	2.30	2.40	38
K82LH32LAW	Entire Unit	5.20	6.00	6.20	6.50	98.8
	Back	4.50	5.20	5.40	5.60	89.7
	Seat	4.20	4.80	5.00	5.30	79.2
	Arm	1.80	2.10	2.20	2.30	34
K82LH32LAW2RAW	Entire Unit	10.50	12.10	12.60	13.10	204.3
	Back	4.50	5.20	5.40	5.60	89.7
	Seat	4.20	4.80	5.00	5.30	79.2
	Arm	1.80	2.10	2.20	2.30	34

COM YARDAGE REQUIREMENTS

COM YARDAGE REQUIREMENTS (54" WIDTH – CUT UP THE ROLL)

MODEL	RAILROADED Contact customer service 800-634-9510 for ydg requirements	NON DIRECTIONAL OR SOLID	1"-4" REPEAT	5"-11" REPEAT	12"-18" REPEAT	COL SQUARE FEET
			4" VERTICAL X 4" HORIZONTAL	11" VERTICAL X 11" HORIZONTAL	18" VERTICAL X 18" HORIZONTAL	
K82LH32LAW2RTW	Entire Unit	10.40	12.00	12.50	13.00	202.3
	Back	4.50	5.20	5.40	5.60	89.7
	Seat	4.20	4.80	5.00	5.30	79.2
	Arm	1.80	2.10	2.20	2.30	34
K82LH32LAWTRAW	Entire Unit	10.40	12.00	12.50	13.00	202.3
	Back	4.50	5.20	5.40	5.60	89.7
	Seat	4.20	4.80	5.00	5.30	79.2
	Arm	1.90	2.20	2.30	2.40	38
K82LH32LTL	Entire Unit	9.60	11.00	11.50	12.00	186.8
	Back	4.50	5.20	5.40	5.60	89.7
	Seat	4.20	4.80	5.00	5.30	79.2
	Arm	1.00	1.20	1.20	1.30	20
K82LH32LTL2RAU	Entire Unit	10.50	12.10	12.60	13.10	204.3
	Back	4.50	5.20	5.40	5.60	89.7
	Seat	4.20	4.80	5.00	5.30	79.2
	Arm	1.90	2.20	2.30	2.40	36
K82LH32LTT	Entire Unit	9.60	11.00	11.50	12.00	186.8
	Back	4.50	5.20	5.40	5.60	89.7
	Seat	4.20	4.80	5.00	5.30	79.2
	Arm	1.00	1.20	1.20	1.30	20
K82LH32LTT2RAT	Entire Unit	10.40	12.00	12.50	13.00	202.3
	Back	4.50	5.20	5.40	5.60	89.7
	Seat	4.20	4.80	5.00	5.30	79.2
	Arm	1.80	2.10	2.20	2.30	34
K82LH32LTT2RAU	Entire Unit	10.50	12.10	12.60	13.10	204.3
	Back	4.50	5.20	5.40	5.60	89.7
	Seat	4.20	4.80	5.00	5.30	79.2
	Arm	1.90	2.20	2.30	2.40	36
K82LH32LTTW	Entire Unit	9.60	11.00	11.50	12.00	186.8
	Back	4.50	5.20	5.40	5.60	89.7
	Seat	4.20	4.80	5.00	5.30	79.2
	Arm	1.00	1.20	1.20	1.30	20
K82LH32LTTW2RAU	Entire Unit	10.50	12.10	12.60	13.10	204.3
	Back	4.50	5.20	5.40	5.60	89.7
	Seat	4.20	4.80	5.00	5.30	79.2
	Arm	1.90	2.20	2.30	2.40	36
K82LH32LTTW2RAW	Entire Unit	10.40	12.00	12.50	13.00	202.3
	Back	4.50	5.20	5.40	5.60	89.7
	Seat	4.20	4.80	5.00	5.30	79.2
	Arm	1.80	2.10	2.20	2.30	34
K82LH32RAP	Entire Unit	9.60	11.00	11.50	12.00	186.8
	Back	4.50	5.20	5.40	5.60	89.7
	Seat	4.20	4.80	5.00	5.30	79.2
	Arm	1.00	1.20	1.20	1.30	20
K82LH32RAS	Entire Unit	9.60	11.00	11.50	12.00	186.8
	Back	4.50	5.20	5.40	5.60	89.7
	Seat	4.20	4.80	5.00	5.30	79.2
	Arm	1.00	1.20	1.20	1.30	20
K82LH32RAT	Entire Unit	9.60	11.00	11.50	12.00	186.8
	Back	4.50	5.20	5.40	5.60	89.7
	Seat	4.20	4.80	5.00	5.30	79.2
	Arm	1.00	1.20	1.20	1.30	20
K82LH32RAU	Entire Unit	9.60	11.00	11.50	12.00	186.8
	Back	4.50	5.20	5.40	5.60	89.7
	Seat	4.20	4.80	5.00	5.30	79.2
	Arm	1.00	1.20	1.20	1.30	20
K82LH32RAW	Entire Unit	9.60	11.00	11.50	12.00	186.8
	Back	4.50	5.20	5.40	5.60	89.7
	Seat	4.20	4.80	5.00	5.30	79.2
	Arm	1.00	1.20	1.20	1.30	20

COM YARDAGE REQUIREMENTS

COM YARDAGE REQUIREMENTS (54" WIDTH – CUT UP THE ROLL)

MODEL	RAILROADED Contact customer service 800-634-9510 for ydg requirements	NON DIRECTIONAL OR SOLID	1"-4" REPEAT	5"-11" REPEAT	12"-18" REPEAT	COL SQUARE FEET
			4" VERTICAL X 4" HORIZONTAL	11" VERTICAL X 11" HORIZONTAL	18" VERTICAL X 18" HORIZONTAL	
K82LH32RTL	Entire Unit	9.60	11.00	11.50	12.00	186.8
	Back	4.50	5.20	5.40	5.60	89.7
	Seat	4.20	4.80	5.00	5.30	79.2
	Arm	1.00	1.20	1.20	1.30	20
K82LH32RTT	Entire Unit	9.60	11.00	11.50	12.00	186.8
	Back	4.50	5.20	5.40	5.60	89.7
	Seat	4.20	4.80	5.00	5.30	79.2
	Arm	1.00	1.20	1.20	1.30	20
K82LH32RTW	Entire Unit	9.60	11.00	11.50	12.00	186.8
	Back	4.50	5.20	5.40	5.60	89.7
	Seat	4.20	4.80	5.00	5.30	79.2
	Arm	1.00	1.20	1.20	1.30	20
K82LH38LAS	Entire Unit	9.60	11.00	11.50	12.00	186.8
	Back	4.50	5.20	5.40	5.60	89.7
	Seat	4.20	4.80	5.00	5.30	79.2
	Arm	1.00	1.20	1.20	1.30	20
K82LH38LAS8RAS	Entire Unit	10.40	12.00	12.50	13.00	202.3
	Back	4.50	5.20	5.40	5.60	89.7
	Seat	4.20	4.80	5.00	5.30	79.2
	Arm	1.80	2.10	2.20	2.30	36
K82LH38LASTRAS	Entire Unit	10.40	12.00	12.50	13.00	202.3
	Back	4.50	5.20	5.40	5.60	89.7
	Seat	4.20	4.80	5.00	5.30	79.2
	Arm	1.80	2.10	2.20	2.30	36
K82LH38LAT	Entire Unit	9.60	11.00	11.50	12.00	186.8
	Back	4.50	5.20	5.40	5.60	89.7
	Seat	4.20	4.80	5.00	5.30	79.2
	Arm	1.00	1.20	1.20	1.30	20
K82LH38LAT8RAT	Entire Unit	10.40	12.00	12.50	13.00	202.3
	Back	4.50	5.20	5.40	5.60	89.7
	Seat	4.20	4.80	5.00	5.30	79.2
	Arm	1.80	2.10	2.20	2.30	36
K82LH38LAT8RTT	Entire Unit	10.40	12.00	12.50	13.00	202.3
	Back	4.50	5.20	5.40	5.60	89.7
	Seat	4.20	4.80	5.00	5.30	79.2
	Arm	1.80	2.10	2.20	2.30	36
K82LH38LATTRAT	Entire Unit	10.40	12.00	12.50	13.00	202.3
	Back	4.50	5.20	5.40	5.60	89.7
	Seat	4.20	4.80	5.00	5.30	79.2
	Arm	1.80	2.10	2.20	2.30	36
K82LH38LAU	Entire Unit	9.60	11.00	11.50	12.00	186.8
	Back	4.50	5.20	5.40	5.60	89.7
	Seat	4.20	4.80	5.00	5.30	79.2
	Arm	1.00	1.20	1.20	1.30	20
K82LH38LAU8RAU	Entire Unit	10.50	12.10	12.60	13.10	204.3
	Back	4.50	5.20	5.40	5.60	89.7
	Seat	4.20	4.80	5.00	5.30	79.2
	Arm	1.90	2.20	2.30	2.40	36
K82LH38LAU8RTL	Entire Unit	10.50	12.10	12.60	13.10	204.3
	Back	4.50	5.20	5.40	5.60	89.7
	Seat	4.20	4.80	5.00	5.30	79.2
	Arm	1.90	2.20	2.30	2.40	36
K82LH38LAU8RTT	Entire Unit	10.50	12.10	12.60	13.10	204.3
	Back	4.50	5.20	5.40	5.60	89.7
	Seat	4.20	4.80	5.00	5.30	79.2
	Arm	1.90	2.20	2.30	2.40	36
K82LH38LAU8RTW	Entire Unit	10.50	12.10	12.60	13.10	204.3
	Back	4.50	5.20	5.40	5.60	89.7
	Seat	4.20	4.80	5.00	5.30	79.2
	Arm	1.90	2.20	2.30	2.40	36

COM YARDAGE REQUIREMENTS

COM YARDAGE REQUIREMENTS (54" WIDTH – CUT UP THE ROLL)

MODEL	RAILROADED Contact customer service 800-634-9510 for ydg requirements	NON DIRECTIONAL OR SOLID	1"-4" REPEAT	5"-11" REPEAT	12"-18" REPEAT	COL SQUARE FEET
			4" VERTICAL X 4" HORIZONTAL	11" VERTICAL X 11" HORIZONTAL	18" VERTICAL X 18" HORIZONTAL	
K82LH38LAUTRAU	Entire Unit	10.50	12.10	12.60	13.10	204.3
	Back	4.50	5.20	5.40	5.60	89.7
	Seat	4.20	4.80	5.00	5.30	79.2
	Arm	1.90	2.20	2.30	2.40	36
K82LH38LAW	Entire Unit	9.60	11.00	11.50	12.00	186.8
	Back	4.50	5.20	5.40	5.60	89.7
	Seat	4.20	4.80	5.00	5.30	79.2
	Arm	1.00	1.20	1.20	1.30	20
K82LH38LAW8RAW	Entire Unit	10.40	12.00	12.50	13.00	202.3
	Back	4.50	5.20	5.40	5.60	89.7
	Seat	4.20	4.80	5.00	5.30	79.2
	Arm	1.80	2.10	2.20	2.30	36
K82LH38LAW8RTW	Entire Unit	10.40	12.00	12.50	13.00	202.3
	Back	4.50	5.20	5.40	5.60	89.7
	Seat	4.20	4.80	5.00	5.30	79.2
	Arm	1.80	2.10	2.20	2.30	36
K82LH38LAWTRAW	Entire Unit	10.40	12.00	12.50	13.00	202.3
	Back	4.50	5.20	5.40	5.60	89.7
	Seat	4.20	4.80	5.00	5.30	79.2
	Arm	1.80	2.10	2.20	2.30	36
K82LH38LTL	Entire Unit	9.60	11.00	11.50	12.00	186.8
	Back	4.50	5.20	5.40	5.60	89.7
	Seat	4.20	4.80	5.00	5.30	79.2
	Arm	1.00	1.20	1.20	1.30	20
K82LH38LTL8RAU	Entire Unit	10.50	12.10	12.60	13.10	204.3
	Back	4.50	5.20	5.40	5.60	89.7
	Seat	4.20	4.80	5.00	5.30	79.2
	Arm	1.90	2.20	2.30	2.40	36
K82LH38LTL8RTL	Entire Unit	10.50	12.10	12.60	13.10	204.3
	Back	4.50	5.20	5.40	5.60	89.7
	Seat	4.20	4.80	5.00	5.30	79.2
	Arm	1.90	2.20	2.30	2.40	36
K82LH38LTT	Entire Unit	9.60	11.00	11.50	12.00	186.8
	Back	4.50	5.20	5.40	5.60	89.7
	Seat	4.20	4.80	5.00	5.30	79.2
	Arm	1.00	1.20	1.20	1.30	20
K82LH38LTT8RAT	Entire Unit	10.40	12.00	12.50	13.00	202.3
	Back	4.50	5.20	5.40	5.60	89.7
	Seat	4.20	4.80	5.00	5.30	79.2
	Arm	1.80	2.10	2.20	2.30	36
K82LH38LTT8RAU	Entire Unit	10.50	12.10	12.60	13.10	204.3
	Back	4.50	5.20	5.40	5.60	89.7
	Seat	4.20	4.80	5.00	5.30	79.2
	Arm	1.90	2.20	2.30	2.40	36
K82LH38LTT8RTT	Entire Unit	10.50	12.10	12.60	13.10	204.3
	Back	4.50	5.20	5.40	5.60	89.7
	Seat	4.20	4.80	5.00	5.30	79.2
	Arm	1.90	2.20	2.30	2.40	36
K82LH38LTTW	Entire Unit	9.60	11.00	11.50	12.00	186.8
	Back	4.50	5.20	5.40	5.60	89.7
	Seat	4.20	4.80	5.00	5.30	79.2
	Arm	1.00	1.20	1.20	1.30	20
K82LH38LTTW8RAU	Entire Unit	10.50	12.10	12.60	13.10	204.3
	Back	4.50	5.20	5.40	5.60	89.7
	Seat	4.20	4.80	5.00	5.30	79.2
	Arm	1.90	2.20	2.30	2.40	36
K82LH38LTTW8RAW	Entire Unit	10.40	12.00	12.50	13.00	202.3
	Back	4.50	5.20	5.40	5.60	89.7
	Seat	4.20	4.80	5.00	5.30	79.2
	Arm	1.80	2.10	2.20	2.30	36

COM YARDAGE REQUIREMENTS

COM YARDAGE REQUIREMENTS (54" WIDTH – CUT UP THE ROLL)

MODEL	RAILROADED Contact customer service 800-634-9510 for ydg requirements	NON DIRECTIONAL OR SOLID	1"-4" REPEAT	5"-11" REPEAT	12"-18" REPEAT	COL SQUARE FEET
			4" VERTICAL X 4" HORIZONTAL	11" VERTICAL X 11" HORIZONTAL	18" VERTICAL X 18" HORIZONTAL	
K82LH38LTW8RTW	Entire Unit	10.50	12.10	12.60	13.10	204.3
	Back	4.50	5.20	5.40	5.60	89.7
	Seat	4.20	4.80	5.00	5.30	79.2
	Arm	1.90	2.20	2.30	2.40	36
K82LH38RAS	Entire Unit	9.60	11.00	11.50	12.00	186.8
	Back	4.50	5.20	5.40	5.60	89.7
	Seat	4.20	4.80	5.00	5.30	79.2
	Arm	1.00	1.20	1.20	1.30	20
K82LH38RAT	Entire Unit	9.60	11.00	11.50	12.00	186.8
	Back	4.50	5.20	5.40	5.60	89.7
	Seat	4.20	4.80	5.00	5.30	79.2
	Arm	1.00	1.20	1.20	1.30	20
K82LH38RAU	Entire Unit	9.60	11.00	11.50	12.00	186.8
	Back	4.50	5.20	5.40	5.60	89.7
	Seat	4.20	4.80	5.00	5.30	79.2
	Arm	1.00	1.20	1.20	1.30	20
K82LH38RAW	Entire Unit	9.60	11.00	11.50	12.00	186.8
	Back	4.50	5.20	5.40	5.60	89.7
	Seat	4.20	4.80	5.00	5.30	79.2
	Arm	1.00	1.20	1.20	1.30	20
K82LH38RTL	Entire Unit	9.60	11.00	11.50	12.00	186.8
	Back	4.50	5.20	5.40	5.60	89.7
	Seat	4.20	4.80	5.00	5.30	79.2
	Arm	1.00	1.20	1.20	1.30	20
K82LH38RTT	Entire Unit	9.60	11.00	11.50	12.00	186.8
	Back	4.50	5.20	5.40	5.60	89.7
	Seat	4.20	4.80	5.00	5.30	79.2
	Arm	1.00	1.20	1.20	1.30	20
K82LH38RTW	Entire Unit	9.60	11.00	11.50	12.00	186.8
	Back	4.50	5.20	5.40	5.60	89.7
	Seat	4.20	4.80	5.00	5.30	79.2
	Arm	1.00	1.20	1.20	1.30	20
K82LH3TLAS	Entire Unit	9.60	11.00	11.50	12.00	186.8
	Back	4.50	5.20	5.40	5.60	89.7
	Seat	4.20	4.80	5.00	5.30	79.2
	Arm	1.00	1.20	1.20	1.30	20
K82LH3TLAS2RAS	Entire Unit	10.40	12.00	12.50	13.00	202.3
	Back	4.50	5.20	5.40	5.60	89.7
	Seat	4.20	4.80	5.00	5.30	79.2
	Arm	1.90	2.20	2.30	2.40	38
K82LH3TLAS8RAS	Entire Unit	10.40	12.00	12.50	13.00	202.3
	Back	4.50	5.20	5.40	5.60	89.7
	Seat	4.20	4.80	5.00	5.30	79.2
	Arm	1.80	2.10	2.20	2.30	36
K82LH3TLAS2RAS	Entire Unit	10.50	12.10	12.60	13.10	204.3
	Back	4.50	5.20	5.40	5.60	89.7
	Seat	4.20	4.80	5.00	5.30	79.2
	Arm	1.90	2.20	2.30	2.40	36
K82LH3TLAT	Entire Unit	9.60	11.00	11.50	12.00	186.8
	Back	4.50	5.20	5.40	5.60	89.7
	Seat	4.20	4.80	5.00	5.30	79.2
	Arm	1.00	1.20	1.20	1.30	20
K82LH3TLAT2RAT	Entire Unit	10.40	12.00	12.50	13.00	202.3
	Back	4.50	5.20	5.40	5.60	89.7
	Seat	4.20	4.80	5.00	5.30	79.2
	Arm	1.90	2.20	2.30	2.40	38
K82LH3TLAT8RAT	Entire Unit	10.40	12.00	12.50	13.00	202.3
	Back	4.50	5.20	5.40	5.60	89.7
	Seat	4.20	4.80	5.00	5.30	79.2
	Arm	1.80	2.10	2.20	2.30	36

COM YARDAGE REQUIREMENTS

COM YARDAGE REQUIREMENTS (54" WIDTH – CUT UP THE ROLL)

MODEL	RAILOADED Contact customer service 800-634-9510 for ydg requirements	NON DIRECTIONAL OR SOLID	1"-4" REPEAT	5"-11" REPEAT	12"-18" REPEAT	COL SQUARE FEET
			4" VERTICAL X 4" HORIZONTAL	11" VERTICAL X 11" HORIZONTAL	18" VERTICAL X 18" HORIZONTAL	
K82LH3TLATTRAT	Entire Unit	10.50	12.10	12.60	13.10	204.3
	Back	4.50	5.20	5.40	5.60	89.7
	Seat	4.20	4.80	5.00	5.30	79.2
	Arm	1.90	2.20	2.30	2.40	36
K82LH3TLAU	Entire Unit	9.60	11.00	11.50	12.00	186.8
	Back	4.50	5.20	5.40	5.60	89.7
	Seat	4.20	4.80	5.00	5.30	79.2
	Arm	1.00	1.20	1.20	1.30	20
K82LH3TLAU2RAU	Entire Unit	10.50	12.10	12.60	13.10	204.3
	Back	4.50	5.20	5.40	5.60	89.7
	Seat	4.20	4.80	5.00	5.30	79.2
	Arm	1.90	2.20	2.30	2.40	38
K82LH3TLAU8RAU	Entire Unit	10.50	12.10	12.60	13.10	204.3
	Back	4.50	5.20	5.40	5.60	89.7
	Seat	4.20	4.80	5.00	5.30	79.2
	Arm	1.90	2.20	2.30	2.40	36
K82LH3TLAU8TRAU	Entire Unit	10.50	12.10	12.60	13.10	204.3
	Back	4.50	5.20	5.40	5.60	89.7
	Seat	4.20	4.80	5.00	5.30	79.2
	Arm	1.90	2.20	2.30	2.40	36
K82LH3TLAW	Entire Unit	9.60	11.00	11.50	12.00	186.8
	Back	4.50	5.20	5.40	5.60	89.7
	Seat	4.20	4.80	5.00	5.30	79.2
	Arm	1.00	1.20	1.20	1.30	20
K82LH3TLAW2RAW	Entire Unit	10.40	12.00	12.50	13.00	202.3
	Back	4.50	5.20	5.40	5.60	89.7
	Seat	4.20	4.80	5.00	5.30	79.2
	Arm	1.90	2.20	2.30	2.40	38
K82LH3TLAW8RAW	Entire Unit	10.40	12.00	12.50	13.00	202.3
	Back	4.50	5.20	5.40	5.60	89.7
	Seat	4.20	4.80	5.00	5.30	79.2
	Arm	1.80	2.10	2.20	2.30	36
K82LH3TLAWTRAW	Entire Unit	10.50	12.10	12.60	13.10	204.3
	Back	4.50	5.20	5.40	5.60	89.7
	Seat	4.20	4.80	5.00	5.30	79.2
	Arm	1.90	2.20	2.30	2.40	36
K82LH3TRAS	Entire Unit	9.60	11.00	11.50	12.00	186.8
	Back	4.50	5.20	5.40	5.60	89.7
	Seat	4.20	4.80	5.00	5.30	79.2
	Arm	1.00	1.20	1.20	1.30	20
K82LH3TRAT	Entire Unit	9.60	11.00	11.50	12.00	186.8
	Back	4.50	5.20	5.40	5.60	89.7
	Seat	4.20	4.80	5.00	5.30	79.2
	Arm	1.00	1.20	1.20	1.30	20
K82LH3TRAU	Entire Unit	9.60	11.00	11.50	12.00	186.8
	Back	4.50	5.20	5.40	5.60	89.7
	Seat	4.20	4.80	5.00	5.30	79.2
	Arm	1.00	1.20	1.20	1.30	20
K82LH3TRAW	Entire Unit	9.60	11.00	11.50	12.00	186.8
	Back	4.50	5.20	5.40	5.60	89.7
	Seat	4.20	4.80	5.00	5.30	79.2
	Arm	1.00	1.20	1.20	1.30	20

