

---

# Villa Health

Product Specifications	702
Fabrics and Options	703
Product Pages	705
COM Yardage Requirements	714

## VILLA HEALTH PRODUCT SPECIFICATIONS

### MOBILE LOUNGE CHAIRS

- Clean out
- 123mm dual wheel casters on front: black
- Non-skid, adjustable glides on back legs
- Rounded handle on back: platinum metallic finish
- EOS<sup>CU</sup> (Cupron-enhanced EOS) biocidal solid surface arm caps
- Power/USB grommet
- Legs: metal square, round, Y, or wood tapered

### MOBILE LOUNGE CHAIRS WITH TABLET ARM

- Clean out
- 123mm dual wheel casters on front: black
- Non-skid, adjustable glides on back legs
- Rounded handle on back: platinum metallic finish
- Tablet arm: HPL or wood
- Tablet arm grommet (NH) to enable tablet arm to be moved to the other arm by user
- Power/USB grommet
- Legs: metal square, round, Y, or wood tapered

### LOUNGE CHAIRS, LOVESEATS, SOFAS

- Clean out
- Non-skid, adjustable glides on legs
- EOS<sup>CU</sup> (Cupron-enhanced EOS) biocidal solid surface arm caps
- Power/USB grommet
- Legs: metal square, round, Y, or wood tapered

### LOUNGE CHAIRS, LOVESEATS, SOFAS WITH TABLET ARM

- Clean out
- Non-skid, adjustable glides on legs
- Tablet arm: HPL or wood
- Tablet arm grommet (NH) to enable tablet arm to be moved to the other arm by user
- Power/USB grommet
- Legs: metal square, round, Y, or wood tapered

### 45° CRESCENT LOUNGE

- Clean out
- Non-skid, adjustable glides on legs

### OPTIONAL G55 POWER/USB MODULE

- Single-sided, pneumatic pop-out design: platinum metallic
- 6' cord
- 4" x 5" cut-out

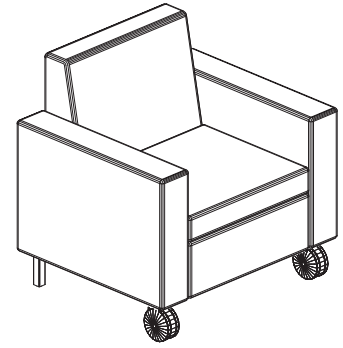

## SURFACE MATERIALS

See the Kimball Hospitality Surface Materials Reference Guide at [kimballhospitality.com](http://kimballhospitality.com) for a complete overview of our materials program, including:

- Characteristics of wood
- Special wood finishes
- Customer specified laminate (CSL)
- Customer specified paint (CSP)
- Fabric application and colorways
- Customer's own material (COM) process overview
- Alliance program

### ALLIANCE FABRIC PROGRAM

Kimball Hospitality has analyzed each model to most accurately reflect the COM/COL yardage requirements shown on page 714.

The yardage requirement for each model is based on 54" wide fabric and cutting the fabric up the roll.

If repeat is larger than 18", contact Customer Service to confirm the correct amount of yardage required. When ordering 10 or more chairs in the same COM, yardage requirements may be reduced.

Contact Customer Service.

### PRICE GRADES A-R

See Surface Materials at [www.kimballhospitality.com](http://www.kimballhospitality.com) for a wide variety of graded-in fabrics from Arc-Com, Carnegie, CF Stinson, Designtex, Maharam, Mayer, Momentum, and Ultrafabrics.

### FABRIC SAMPLES

If you need samples for presentation(s), contact our alliance partners directly at:

Arc-Com	800.223.5466	<a href="http://arc-com.com">arc-com.com</a>
Carnegie	800.727.6770	<a href="http://carnegiefabrics.com">carnegiefabrics.com</a>
CF Stinson	800.841.6279	<a href="http://cfstinson.com">cfstinson.com</a>
Designtex	800.221.1540	<a href="http://designtex.com">designtex.com</a>
Maharam	800.645.3943	<a href="http://maharam.com">maharam.com</a>
Mayer	800.428.4415	<a href="http://mayerfabrics.com">mayerfabrics.com</a>
Momentum	800.366.6839	<a href="http://memosamples.com">memosamples.com</a>
Ultrafabrics	877.309.6648	<a href="http://ultrafabricsllc.com">ultrafabricsllc.com</a>

## ARM CAPS

### 3D LAMINATE

#### WOODGRAIN

CO	Canyon
DF	Driftwood
MH	Mocha
YO	Monterey
NW	Tuscan

### SOLID SURFACE

#### STANDARD

7101	Bisque
405	Designer White

#### PREMIUM\*

467	Carbon Concrete
468	Neutral Concrete
464	Peace Grey
469	Weathered Concrete

\*\$446 Upcharge applies

#### EOS\*

495	EOS <sup>CU</sup> Beige
496	EOS <sup>CU</sup> Grey

\*\$1206 Upcharge applies

### WOOD

BZ	Brazilwood	MH	Mocha
CO	Canyon	YO	Monterey
CI	Chai	PC	Porcini
CC	Cordoba	PB	Portobello
DF	Driftwood	792	Sable
KN	Kona	NW	Tuscan
MW	Midtown	WL	Willow

IMPORTANT: Wood finishes applied to solid hardwood are complementary to the same wood finish applied to wood veneer, but not an exact match. Contact Customer Service for more information.

## TABLETS

### HIGH PRESSURE LAMINATE (HPL)

#### WOODGRAIN

BZ	Brazilwood
CO	Canyon
CI	Chai
CC	Cordoba
DF	Driftwood
KN	Kona
MW	Midtown
MH	Mocha
YO	Monterey
PC	Porcini
PB	Portobello
792	Sable
NW	Tuscan
WL	Willow

#### SOLID COLOR

462	Cinder
440	Cloud
457	Dapple
405	Designer White
450	Fog
488	Frosty White
461	Graphite
425	Shadow
460	Storm
419	Wallaby

### TABLET ARM LOCATION

L	Left as Seated
R	Right as Seated
NH	Non-Handed (\$38 upcharge)
LR	(Loveseats and Sofas) Left and Right as Seated (\$469 upcharge for laminate) (\$503 upcharge for wood)

# VILLA HEALTH

## CASTERS

42 Black, Hard Dual Wheel

## HANDLE

100\_PL Round, Platinum Metal

## LEG OPTIONS

### SQUARE AND ROUND METAL LEGS

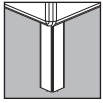

S

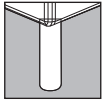

R

### SOLID COLOR PAINT

462 Cinder  
405 Designer White

### METALLIC PAINT

501 Platinum Metallic

### Y METAL LEG

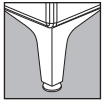

Y

### SOLID COLOR PAINT

462 Cinder

### METALLIC PAINT

501 Platinum Metallic

### NON-PAINT

497 Polished Aluminum

### TAPERED WOOD LEG

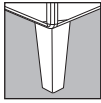

T

### WOOD

BZ	Brazilwood	MH	Mocha
CO	Canyon	YO	Monterey
CI	Chai	PC	Porcini
CC	Cordoba	PB	Portobello
DF	Driftwood	792	Sable
KN	Kona	NW	Tuscan
MW	Midtown	WL	Willow

## OPTIONAL G55 POWER/USB MODULE

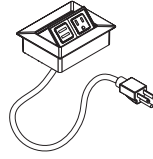

X No Power/USB Module  
 G55KRPL Left Front as Seated (\$490 upcharge)  
 G55KRPR Right Front as Seated (\$490 upcharge)  
 G55KRPLR Left and Right Front (\$980 upcharge)

**TO ORDER, SPECIFY:**

1. Model Number
2. Back Fabric Grade
3. Back Fabric Number
4. Seat Fabric Grade
5. Seat Fabric Number
6. Arm Fabric Grade
7. Arm Fabric Number
8. Wood Arm Cap Price Group (if applicable)
9. Arm Cap Finish Designator (if applicable)
10. Power/USB Module
11. Casters
12. Handle
13. Leg Option

- See pages 703-704 for Villa Health options
- See page 714 for COM fabric yardage

**MOBILE LOUNGE CHAIR**

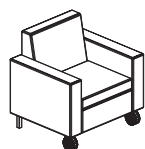

No Arm Caps

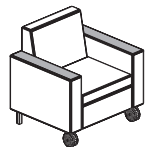

Arm Caps

**MODEL NO.**

**ALLIANCE PROGRAM PRICE GRADES**

			A	B	C	D	E	F	G	H	I
			J	K	L	M	N	O	P	Q	R
K6015ACOM	No Arm Caps	\$	3205	3394	3541	3689	3849	4038	4144	4350	4521
			4698	4982	5547	5908	5985	6055	6144	6226	6622
K6015ACOACWM	Wood Arm Caps		3692	3881	4028	4176	4336	4525	4631	4837	5008
			5185	5469	6034	6395	6472	6542	6631	6713	7109
K6015ACOACTM	3D Laminate Arm Caps		3693	3882	4029	4177	4337	4526	4632	4838	5009
			5186	5470	6035	6396	6473	6543	6632	6714	7110
K6015ACOACSM	Solid Surface Arm Caps		4025	4214	4361	4509	4669	4858	4964	5170	5341
			5518	5802	6367	6728	6805	6875	6964	7046	7442

**DIMENSIONS**

Width	35	Seat Height	18¾	Arm Height		Weight	61
Depth	29	Seat Depth	21½	No Arm Caps	26%	Cubic Ft.	28.70
Height	35¼	Seat Width	24¾	Arm Caps	27%		

- Clean out
- 123mm dual wheel casters on front: black
- Non-skid, adjustable glides on back legs
- Rounded handle on back: platinum metallic finish

# VILLA HEALTH

## TO ORDER, SPECIFY:

1. Model Number
2. Back Fabric Grade
3. Back Fabric Number
4. Seat Fabric Grade
5. Seat Fabric Number
6. Arm Fabric Grade
7. Arm Fabric Number
8. Wood Arm Cap Price Group (if applicable)
9. Tablet Arm Finish Designator
10. Tablet Arm Location
11. Power/USB Module
12. Casters
13. Handle
14. Leg Option

- See pages 703-704 for Villa Health options
- See page 714 for COM fabric yardage

VILLA HEALTH

### MOBILE LOUNGE CHAIR WITH TABLET ARM

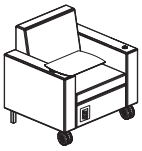

Tablet Arm  
Note: Illustration above shows power/USB grommet and non-handed tablet arm grommet options

### MODEL NO.

### ALLIANCE PROGRAM PRICE GRADES

			A	B	C	D	E	F	G	H	I
			J	K	L	M	N	O	P	Q	R
K6015ACOTLM	HPL Tablet Arm	\$	3676	3865	4012	4160	4320	4509	4615	4821	4992
			5169	5453	6018	6379	6456	6526	6615	6697	7093
K6015ACOTWM	Wood Tablet Arm		3713	3902	4049	4197	4357	4546	4652	4858	5029
			5206	5490	6055	6416	6493	6563	6652	6734	7130

### DIMENSIONS

Width	35	Seat Height	18¾	Arm Height	26¾	Weight	69
Depth	29	Seat Depth	21¾			Cubic Ft.	28.70
Height	35¾	Seat Width	24¾				

- Clean out
- 123mm dual wheel casters on front: black
- Non-skid, adjustable glides on back legs
- Rounded handle on back: platinum metallic finish
- Tablet arm location may be specified as: L (left as seated); R (right as seated); or NH (non-handed for a \$38 upcharge)

**TO ORDER, SPECIFY:**

1. Model Number
2. Back Fabric Grade
3. Back Fabric Number
4. Seat Fabric Grade
5. Seat Fabric Number
6. Arm Fabric Grade
7. Arm Fabric Number
8. Wood Arm Cap Price Group (if applicable)
9. Arm Cap Finish Designator (if applicable)
10. Power/USB Module
11. Leg Option

- See pages 703-704 for Villa Health options
- See page 714 for COM fabric yardage

**LOUNGE CHAIR**

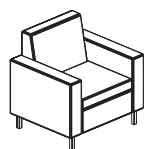

No Arm Caps

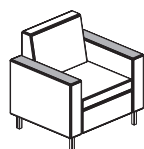

Arm Caps

**MODEL NO.**

**ALLIANCE PROGRAM PRICE GRADES**

		A	B	C	D	E	F	G	H	I
		J	K	L	M	N	O	P	Q	R
K6015ACO	No Arm Caps	\$ 2989	3178	3325	3473	3633	3822	3928	4134	4305
		4482	4766	5331	5692	5769	5839	5928	6010	6406
K6015ACOACW	Wood Arm Caps	3473	3662	3809	3957	4117	4306	4412	4618	4789
		4966	5250	5815	6176	6253	6323	6412	6494	6890
K6015ACOACT	3D Laminate Arm Caps	3473	3662	3809	3957	4117	4306	4412	4618	4789
		4966	5250	5815	6176	6253	6323	6412	6494	6890
K6015ACOACS	Solid Surface Arm Caps	3808	3997	4144	4292	4452	4641	4747	4953	5124
		5301	5585	6150	6511	6588	6658	6747	6829	7225

**DIMENSIONS**

Width	35	Seat Height	18¾	Arm Height		Weight	61
Depth	29	Seat Depth	21½	No Arm Caps	26%	Cubic Ft.	28.70
Height	35¼	Seat Width	24¾	Arm Caps	27%		

- Clean out
- Non-skid, adjustable glides on legs

# VILLA HEALTH

## TO ORDER, SPECIFY:

1. Model Number
2. Back Fabric Grade
3. Back Fabric Number
4. Seat Fabric Grade
5. Seat Fabric Number
6. Arm Fabric Grade
7. Arm Fabric Number
8. Wood or HPL Price Group
9. Tablet Arm Finish Designator
10. Tablet Arm Location
11. Power/USB Module
12. Leg Option

- See pages 703-704 for Villa Health options
- See page 714 for COM fabric yardage

## LOUNGE CHAIR WITH TABLET ARM

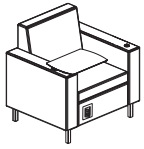

Tablet Arm  
Note: Illustration above shows power/USB grommet (on the right as seated) and non-handed tablet arm grommet options

## MODEL NO.

## ALLIANCE PROGRAM PRICE GRADES

			A	B	C	D	E	F	G	H	I
			J	K	L	M	N	O	P	Q	R
K6015ACOTL	HPL Tablet Arm	\$	3458	3647	3794	3942	4102	4291	4397	4603	4774
			4951	5235	5800	6161	6238	6308	6397	6479	6875
K6015ACOTW	Wood Tablet Arm		3495	3684	3831	3979	4139	4328	4434	4640	4811
			4988	5272	5837	6198	6275	6345	6434	6516	6912

## DIMENSIONS

Width	35	Seat Height	18¾	Arm Height	26¾	Weight	69
Depth	29	Seat Depth	21¾			Cubic Ft.	28.70
Height	35¾	Seat Width	24¾				

- Clean out
- Non-skid, adjustable glides on back legs
- Tablet arm location may be specified as: L (left as seated); R (right as seated); or NH (non-handed for a \$38 upcharge)



**TO ORDER, SPECIFY:**

1. Model Number
2. Back Fabric Grade
3. Back Fabric Number
4. Seat Fabric Grade
5. Seat Fabric Number
6. Arm Fabric Grade
7. Arm Fabric Number
8. Wood Arm Cap Price Group (if applicable)
9. Arm Cap Finish Designator (if applicable)
10. Power/USB Module
11. Leg Option

- See pages 703-704 for Villa Health options
- See page 714 for COM fabric yardage

**LOVESEAT**

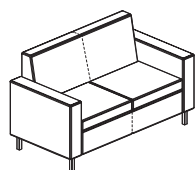

No Arm Caps

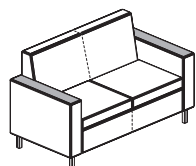

Arm Caps

**MODEL NO.**

**ALLIANCE PROGRAM PRICE GRADES**

		A	B	C	D	E	F	G	H	I
		J	K	L	M	N	O	P	Q	R
K6025ACO	No Arm Caps	\$ 3957	4194	4378	4564	4764	5000	5134	5392	5606
		5828	6184	6894	7345	7442	7530	7641	7746	8242
K6025ACOACW	Wood Arm Caps	4443	4680	4864	5050	5250	5486	5620	5878	6092
		6314	6670	7380	7831	7928	8016	8127	8232	8728
K6025ACOACT	3D Laminate Arm Caps	4444	4681	4865	5051	5251	5487	5621	5879	6093
		6315	6671	7381	7832	7929	8017	8128	8233	8729
K6025ACOACS	Solid Surface Arm Caps	4773	5010	5194	5380	5580	5816	5950	6208	6422
		6644	7000	7710	8161	8258	8346	8457	8562	9058

**DIMENSIONS**

Width	58¾	Seat Height	18¾	Arm Height		Weight	83.9
Depth	29	Seat Depth	21½	No Arm Caps	26%	Cubic Ft.	37.40
Height	35¼	Seat Width	48¾	Arm Caps	27%		

- Clean out
- Non-skid, adjustable glides on back legs

# VILLA HEALTH

## TO ORDER, SPECIFY:

1. Model Number
2. Back Fabric Grade
3. Back Fabric Number
4. Seat Fabric Grade
5. Seat Fabric Number
6. Arm Fabric Grade
7. Arm Fabric Number
8. Wood or HPL Price Group
9. Tablet Arm Finish Designator
10. Tablet Arm Location
11. Power/USB Module
12. Leg Option

- See pages 703-704 for Villa Health options
- See page 714 for COM fabric yardage

### LOVESEAT WITH TABLET ARM

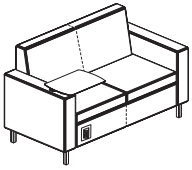

Tablet Arm  
Note: Illustration above shows power/USB grommet option (on right as seated)

### MODEL NO.

### ALLIANCE PROGRAM PRICE GRADES

			A	B	C	D	E	F	G	H	I
			J	K	L	M	N	O	P	Q	R
K6025ACOTL	HPL Tablet Arm	\$	4430	4667	4851	5037	5237	5473	5607	5865	6079
			6301	6657	7367	7818	7915	8003	8114	8219	8715
K6025ACOTW	Wood Tablet Arm		4465	4702	4886	5072	5272	5508	5642	5900	6114
			6336	6692	7402	7853	7950	8038	8149	8254	8750

### DIMENSIONS

Width	58¾	Seat Height	18¾	Arm Height	26¾	Weight	91.9
Depth	29	Seat Depth	21¾			Cubic Ft.	37.40
Height	35¾	Seat Width	48¾				

- Clean out
- Non-skid, adjustable glides on back legs
- Tablet arm location may be specified as: L (left as seated); R (right as seated); NH (non-handed for a \$38 upcharge) or LR (left and right as seated). A \$469 upcharge applies for laminate tablet and a \$503 upcharge applies for a wood tablet

**TO ORDER, SPECIFY:**

1. Model Number
2. Back Fabric Grade
3. Back Fabric Number
4. Seat Fabric Grade
5. Seat Fabric Number
6. Arm Fabric Grade
7. Arm Fabric Number
8. Wood Arm Cap Price Group (if applicable)
9. Arm Cap Finish Designator (if applicable)
10. Power/USB Module
11. Leg Option

- See pages 703-704 for Villa Health options
- See page 714 for COM fabric yardage

**SOFA**

**MODEL NO.**

**ALLIANCE PROGRAM PRICE GRADES**

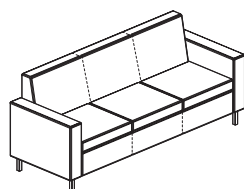

No Arm Caps

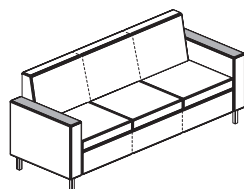

Arm Caps

		ALLIANCE PROGRAM PRICE GRADES									
		A	B	C	D	E	F	G	H	I	
		J	K	L	M	N	O	P	Q	R	
K6035ACO	No Arm Caps	\$ 4924	5209	5432	5654	5896	6179	6341	6651	6909	
		7176	7603	8458	9001	9116	9223	9357	9481	10079	
K6035ACOACW	Wood Arm Caps	5410	5695	5918	6140	6382	6665	6827	7137	7395	
		7662	8089	8944	9487	9602	9709	9843	9967	10565	
K6035ACOACT	3D Laminate Arm Caps	5410	5695	5918	6140	6382	6665	6827	7137	7395	
		7662	8089	8944	9487	9602	9709	9843	9967	10565	
K6035ACOACS	Solid Surface Arm Caps	5741	6026	6249	6471	6713	6996	7158	7468	7726	
		7993	8420	9275	9818	9933	10040	10174	10298	10896	

**DIMENSIONS**

Width	82¾	Seat Height	18¾	Arm Height		Weight	114.8
Depth	29	Seat Depth	21½	No Arm Caps	26%	Cubic Ft.	64.60
Height	35¼	Seat Width	72¼	Arm Caps	27%		

- Clean out
- Non-skid, adjustable glides on back legs

# VILLA HEALTH

## TO ORDER, SPECIFY:

1. Model Number
2. Back Fabric Grade
3. Back Fabric Number
4. Seat Fabric Grade
5. Seat Fabric Number
6. Arm Fabric Grade
7. Arm Fabric Number
8. Wood or HPL Price Group
9. Tablet Arm Finish Designator
10. Tablet Arm Location
11. Power/USB Module
12. Leg Option

- See pages 703-704 for Villa Health options
- See page 714 for COM fabric yardage

### SOFA WITH TABLET ARM

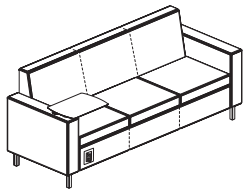

Tablet Arm  
 Note: Illustration at left shows power/USB grommet option (on right as seated)

### MODEL NO.

### ALLIANCE PROGRAM PRICE GRADES

			A	B	C	D	E	F	G	H	I
			J	K	L	M	N	O	P	Q	R
K6035ACOTL	HPL Tablet Arm	\$	5394	5679	5902	6124	6366	6649	6811	7121	7379
			7646	8073	8928	9471	9586	9693	9827	9951	10549
K6035ACOTW	Wood Tablet Arm		5430	5715	5938	6160	6402	6685	6847	7157	7415
			7682	8109	8964	9507	9622	9729	9863	9987	10585

### DIMENSIONS

Width	82¼	Seat Height	18¾	Arm Height	26¾	Weight	122.8
Depth	29	Seat Depth	21¾			Cubic Ft.	64.60
Height	35½	Seat Width	72¼				

- Clean out
- Non-skid, adjustable glides on back legs
- Tablet arm location may be specified as: L (left as seated); R (right as seated); NH (non-handed for a \$38 upcharge) or LR (left and right as seated). A \$469 upcharge applies for laminate tablet and a \$503 upcharge applies for a wood tablet

**TO ORDER, SPECIFY:**

1. Model Number
2. Back Fabric Grade
3. Back Fabric Number
4. Seat Fabric Grade
5. Seat Fabric Number
6. Seat Cushion Firmness
7. Power/USB Module
8. Leg Option

- See pages 703-704 for Villa Health options
- See page 714 for COM fabric yardage

**45° CRESCENT LOUNGE**

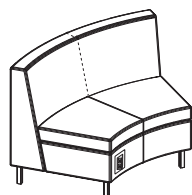

Note: Illustration above shows power/USB grommet option (on right as seated)

**MODEL NO.**

**ALLIANCE PROGRAM PRICE GRADES**

			A	B	C	D	E	F	G	H	I
			J	K	L	M	N	O	P	Q	R
K60CCCO	Crescent Lounge	\$	3940	4104	4231	4359	4497	4660	4752	4930	5078
			5231	5476	5965	6277	6343	6404	6481	6552	6894

**DIMENSIONS**

Width	53	Seat Height	18¾	Weight	112.5
Depth	32	Seat Depth	21¾	Cubic Ft.	51.30
Height	35¾	Seat Width	53		

- Clean out
- Non-skid, adjustable glides on back legs
- Seat cushion firmness - specify STD Standard cushion

VILLA HEALTH

# COM YARDAGE REQUIREMENTS

## COM YARDAGE REQUIREMENTS (54" WIDTH – CUT UP THE ROLL)

MODEL	RAILROADED Contact customer service 800-634-9510 for ydg requirements	NON DIRECTIONAL OR SOLID	1"-4" REPEAT	5"-11" REPEAT	12"-18" REPEAT	COL SQUARE FEET
			4" VERTICAL X 4" HORIZONTAL	11" VERTICAL X 11" HORIZONTAL	18" VERTICAL X 18" HORIZONTAL	
K6015ACOM, K6015ACOACWM, K6015ACOACTM, K6015ACOACSM	Entire Unit	4.70	6.00	7.80	8.80	91
	Back	1.80	1.90	2.10	3.10	33.3
	Base/Seat	1.40	1.50	2.70	3.70	25
	Arms	2.70	2.80	3.80	4.00	51.5
K6015ACOTLM, K6015ACOTWM	Entire Unit	4.70	6.00	7.80	8.80	91
	Back	1.80	1.90	2.10	3.10	33.3
	Base/Seat	1.40	1.50	2.70	3.70	25
	Arms	2.70	2.80	3.80	4.00	51.5
K6015ACO, K6015ACOACW, K6015ACOACT, K6015ACOACS	Entire Unit	4.70	6.00	7.80	8.80	91
	Back	1.80	1.90	2.10	3.10	33.3
	Base/Seat	1.40	1.50	2.70	3.70	25
	Arms	2.70	2.80	3.80	4.00	51.5
K6015ACOTL, K6015ACOTW	Entire Unit	4.70	6.00	7.80	8.80	91
	Back	1.80	1.90	2.10	3.10	33.3
	Base/Seat	1.40	1.50	2.70	3.70	25
	Arms	2.70	2.80	3.80	4.00	51.5
K6025ACO, K6025ACOACW, K6025ACOACT, K6025ACOACS	Entire Unit	5.90	9.10	11.80	12.30	117
	Back	2.60	4.70	5.50	5.50	62.5
	Base/Seat	2.10	3.00	4.50	6.20	40
	Arms	2.70	2.80	3.80	4.00	51.5
K6025ACOTL, K6025ACOTW	Entire Unit	5.90	9.10	11.80	12.30	117
	Back	2.60	4.70	5.50	5.50	62.5
	Base/Seat	2.10	3.00	4.50	6.20	40
	Arms	2.70	2.80	3.80	4.00	51.5
K6035ACO, K6035ACOACW, K6035ACOACT, K6035ACOACS	Entire Unit	7.70	12.30	15.20	17.20	151
	Back	3.30	5.20	5.80	7.10	63
	Base/Seat	2.90	4.30	6.30	8.70	57
	Arms	2.70	2.80	3.80	4.00	51.5
K6035ACOTL, K6035ACOTW	Entire Unit	7.70	12.30	15.20	17.20	151
	Back	3.30	5.20	5.80	7.10	63
	Base/Seat	2.90	4.30	6.30	8.70	57
	Arms	2.70	2.80	3.80	4.00	51.5
K60CCCO	Entire Unit	4.30	5.30	6.90	8.70	83.5
	Back	3.40	3.50	3.90	4.50	66.5
	Base/Seat	2.90	4.30	6.30	8.70	57