Embra

Product Specifications	166
Fabrics and Options	167
Contrasting Fabric	168
End Caps	169
Product Positioning	171
Product Pages	172
COM Yardage Requirements	183

EMBRA PRODUCT SPECIFICATIONS

CUSHIONS

- Cushions are made of high grade, high resiliency, CFC-free, laminated polyurethane foam

ARMS

- Arms are 4" thick
- Arm frames are constructed of ½" thick plywood
- Arm tops and outside panels feature ½" and ¾" thick high grade polyurethane foam
- Arms feature a sewn slipcover with French seams that is stapled into place

BACK, SEAT, AND ARMS

- Back, seat, and arms have decorative top-stitch detailing

END CAP TABLES, CORNER TABLES, AND TABLETS

- End cap tables, corner tables, and tablets consist of a HPL top surface, MDF core, and a 3D Laminate matte luxe bottom surface with low sheen
- Matte luxe provides a soft touch and feel
- All surfaces have rounded corners and sides

ARM CAPS

- Arm caps are available in wood, polyurethane, and solid surface
- EOS^{CU} (Cupron enhanced EOS) biocidal solid surface arm caps are optional on solid surface arm cap model; upcharge applies

TABLETS

- Tablets are handed and swing 90 degrees, allowing easy access
- Tablet mechanism attaches to the front of arm (field installed) and features a platinum metallic finish

SEATS

- Seats feature a high-tension, strip webbing suspension
- Seat upholstery features a wrap-around upholstery method and is stapled into place

LEG FRAMES

- Leg frames are casted aluminum side frame; powdercoated

RAILS

- Rails are rectangular tubular steel with 2mm wall thickness; powdercoat finish

POWER/USB CENTER

- Mini-Tap[®] power/USB center option features one AC power outlet and USB A+C dual charging ports
- Factory installed; upcharge applies

CLEAN OUT

- Clean out is standard on all models to make cleaning easy and simple
- Clean out space is slightly visible between back and seat cushions, but does not detract from the aesthetic or function of the lounge

GLIDES

- Non-skid, adjustable black glides are 1" in diameter with 1" adjustability

FRAME

- Frame is constructed of ¾" thick OSB, using a lap-joint construction method
- Frames are glued and screwed together

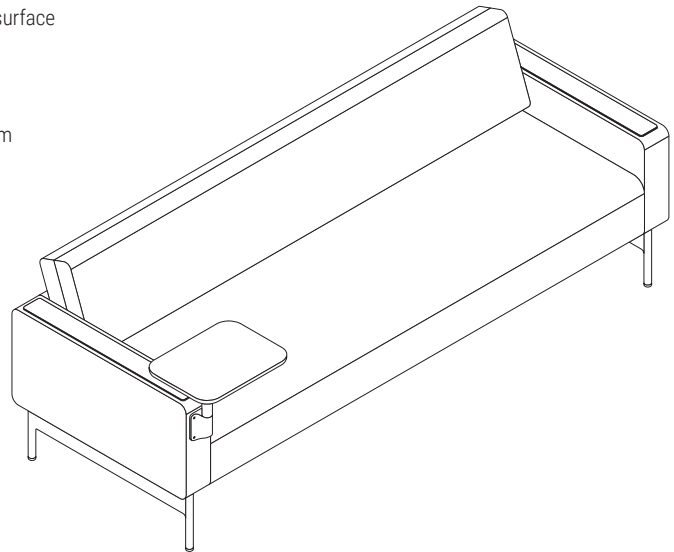
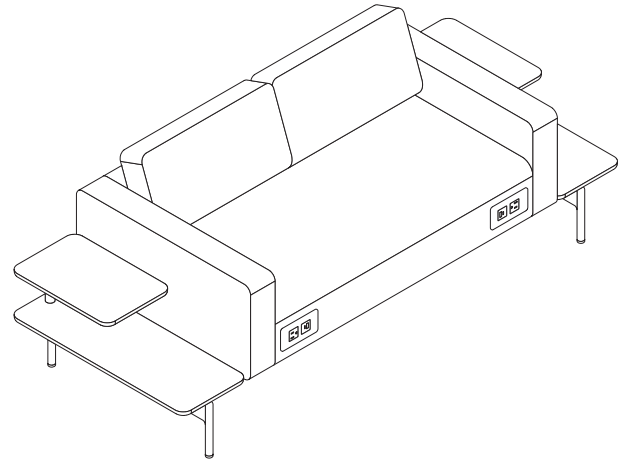

SURFACE MATERIALS

See the Kimball Hospitality Surface Materials Reference Guide at kimballhospitality.com for a complete overview of our materials program, including:

- Characteristics of wood
- Special wood finishes
- Customer-specified laminate (CSL)
- Customer-specified paint (CSP)
- Fabric application and colorways
- Customer's own material (COM) process overview
- Alliance program

ALLIANCE FABRIC PROGRAM

Kimball Hospitality has analyzed each model to most accurately reflect the COM/COL yardage requirements shown on page 183.

The yardage requirement for each model is based on 54" W fabric and cutting the fabric up the roll.

If repeat is larger than 18", contact Customer Service to confirm the correct amount of yardage required. When ordering 10 or more chairs in the same COM, yardage requirements may be reduced.

Contact Customer Service.

PRICE GRADES A-R

See Surface Materials at www.kimball.com for a wide variety of graded-in fabrics from Arc-Com, CF Stinson, DesignTex, Maharam, Momentum, and Ultrafabrics.

FABRIC SAMPLES

If you need samples for presentation(s), contact our alliance partners directly at:

Arc-Com	800.223.5466	arc-com.com
DesignTex	800.221.1540	designTex.com
CF Stinson	800.841.6279	cfstinson.com
Maharam	800.645.3943	maharam.com
Momentum	800.366.6839	memosamples.com
Ultrafabrics	877.309.6648	ultrafabricsllc.com

END CAP TABLES AND STORAGE TABLES, CORNER TABLES AND TABLETS

3D LAMINATE

MATTE LUXE

- 462 Cinder
- 440 Cloud
- 405 Designer White

END CAP TOP SURFACES, TABLET TOP SURFACES, AND CORNER TABLE TOP SURFACES

HPL

WOOD STRAIGHT GRAIN

- AD Almond Straight Grain
- CO Canyon Straight Grain
- DF Driftwood Straight Grain
- YO Monterey Straight Grain
- PB Portobello Straight Grain
- 792 Sable Straight Grain
- NW Tuscan Straight Grain

SOLID

- 462 Cinder
- 440 Cloud
- 405 Designer White

FREESTANDING END CAP LOCATION

- X None
- L Left as Seated
- R Right as Seated
- LR Left and Right as Seated

BASE LEGS/RAILS, COAT RACK POLE BOTTOM SECTION, AND LAMP POLE BOTTOM SECTION

PAINT

SOLID COLOR PAINT

- 462 Cinder
- 440 Cloud
- 405 Designer White

METALLIC PAINT

- 501 Platinum Metallic

LAMP SHADE

PAINT

SOLID COLOR PAINT

- BLK Matte black
- WHT Matte white

METALLIC PAINT

- SIL Silver

ARM CAPS

POLYURETHANE

- 495 Beige
- 462 Cinder
- 496 Grey

SOLID SURFACE

STANDARD

- 405 Designer White

PREMIUM*

- 495 EOS^{CU} Beige
- 496 EOS^{CU} Grey
- (1 Arm \$325 upcharge)
- (2 Arm \$650 upcharge)

ARM CAPS, COAT RACK (UPPER SECTION), AND LAMP POLE (UPPER SECTION)

WOOD FINISH

PRICE GROUP 1

AD Almond	MH Mocha
MC Amber	YO Monterey
IM Brighton	PB Portobello
CO Canyon	792 Sable
CC Cordoba	SC Sedona
DF Driftwood	TW Tribeca
ES Espresso	NW Tuscan
TM Huntington	UW Urban
MW Midtown	

IMPORTANT: Wood finishes applied to solid hardwood are complementary to the same wood finish applied to wood veneer, but not an exact match. Contact Customer Service for more information.

TABLET LOCATION

- L Left as Seated
- R Right as Seated
- LR Left and Right (\$100 upcharge)

MOISTURE BARRIER

- X None
- MB1 Seat (\$116 upcharge)
- MB2 Seat and Inside Back (\$203 upcharge)

TO ORDER CONTRASTING FABRIC, SPECIFY

EMBRA

Chair, Loveseat, and Sofa Freestanding Lounge, Armless page 172

1. Model Number plus "X"
2. Inner Back Fabric Grade
3. Inner Back Fabric Number
4. Outer Back Fabric Grade
5. Outer Back Fabric Number
6. Seat Fabric Grade
7. Seat Fabric Number
8. Base Paint
9. Moisture Barrier Optional for Seat or Inside Back and Seat
10. Power/USB Option
11. End Cap Location

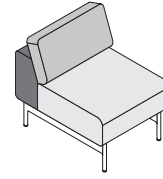

Contrasting Fabric may be specified on inside back, outside back, and seat

Chair and Loveseat Freestanding Lounge, Arms on Both Sides page 173 Sofa Freestanding Lounge, Arms on Both Sides page 174

1. Model Number plus "X"
2. Inner Back Fabric Grade
3. Inner Back Fabric Number
4. Outer Back Fabric Grade
5. Outer Back Fabric Number
6. Seat Fabric Grade
7. Seat Fabric Number
8. Arm Fabric Grade
9. Arm Fabric Number
10. Base Paint
11. Wood Finish Price Group
12. Arm Cap Designator (if applicable)
13. Moisture Barrier Optional for Seat or Inside Back and Seat
14. Power/USB Option
15. End Cap Location

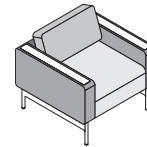

Contrasting Fabric may be specified on inside back, outside back, seat, and arms

END CAPS

End caps, specified separately for field installation, are available for one or both ends of freestanding lounges

End cap tables provide easy-to-access horizontal surfaces. They are available in several styles to accommodate the needs in community spaces and patient rooms. They feature rounded corners and sides for safety

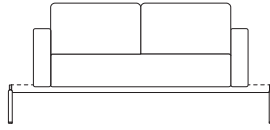

End caps are supported by the leg frame on the lounge or sofa model

IMPORTANT: The lounge model must be specified to accept an end cap

By selecting the desired end cap location/connection on freestanding lounge model, the rails and legs will be extended 6" to the left, right, or on both sides to accept and support an end cap

End caps can be added to the left, right or both sides of freestanding lounges with or without arms. Handing designation is determined from the user's perspective when seated



Single-Tier Table

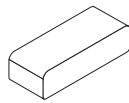

Upholstered Bench

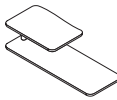

Tiered Table

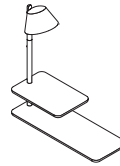

Tiered Table with Lamp

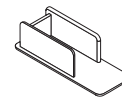

Storage Table

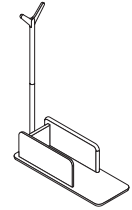

Storage Table with Coat Rack

SINGLE-TIER TABLE:

- Can be used in any configuration, but is best suited for use with armless models
- Table surface is 32" deep x 12" wide x 1³/₁₆" thick
- Height is 10¹³/₁₆" above the floor when attached to leg frame (seat height is 18¹/₁₆")
- HPL top surface; underside is 3D laminate matte luxe

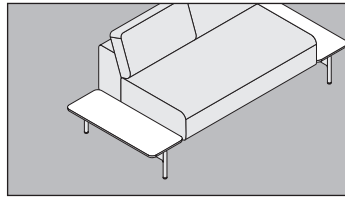

Single-Tier

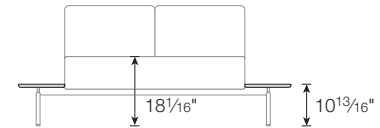

UPHOLSTERED BENCH:

- For use with armless lounge models; ideal for back-to-back applications
- Bench surface is 32" deep x 12" wide x 18¹/₁₆" (same height as lounge seat)

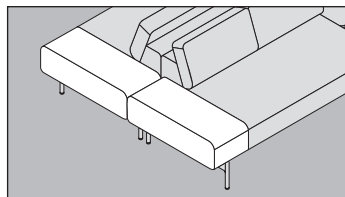

Upholstered Bench in Back-to-Back Application

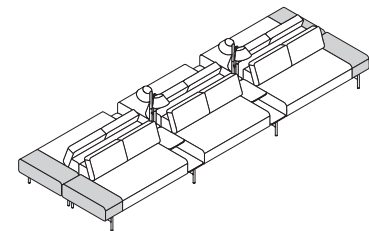

GANGING APPLICATIONS:



One ganging bracket is required when lounge and/or end caps are used back-to-back. See page 175

TO ORDER CONTRASTING FABRIC, SPECIFY

END CAPS (CONTINUED)

TIERED TABLES WITH OR WITHOUT LAMP:

- Can be used in any configuration, but is best suited for use with models with arms
- Lower tier surface is 32" deep x 12" wide x $\frac{1}{8}$ " thick; height is $10\frac{13}{16}$ " above the floor when attached to leg frame
- Top tier is 18" deep and sits above the bottom tier by $6\frac{3}{8}$ "
- HPL top surface; underside is 3D laminate matte luxe
- Lamp has 9" diameter aluminum spun lamp shade with powdercoat finish: Matte Black, Matte White, or Silver. Glossy white interior

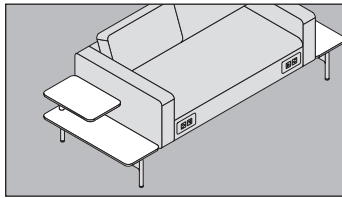

Tiered End Cap

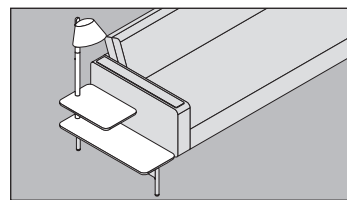
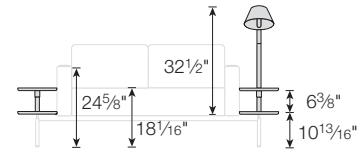

Tiered End Cap with Lamp
• Lamp height is well-suited for reading

STORAGE TABLES WITH OR WITHOUT COAT RACK:

- Can be used in any configuration
- Coat rack models are best suited for end-of-run applications
- Storage area ideal for storing linens, pillows, or personal items
- Interior storage area is $19\frac{1}{16}$ " deep x $8\frac{7}{16}$ " wide x $8\frac{1}{4}$ " high; height is $10\frac{13}{16}$ " above the floor when attached to leg frame
- Table surface is 32" deep x 12" wide x $\frac{1}{8}$ " thick; HPL top surface; underside is 3D laminate matte luxe
- Vertical sides of storage area are 3D laminate matte

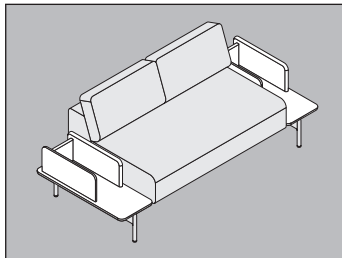

Storage End Cap

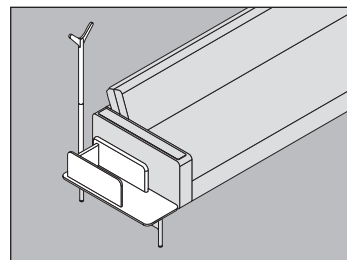
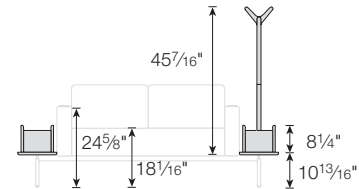

Storage End Cap with Coat Rack
• Keeps personal items out of the sleep area and off of the floor

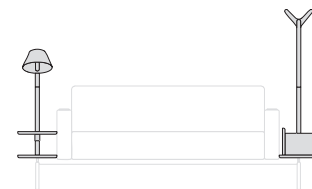

- Lamp and coat rack heights are different based on function

LAMP DETAILS:

- LED Light
- Touch switch on lamp shade interior
- Light output 320lm
- Light color: 2700K
- Power consumption: 4.5W
- Cord: white, 8 feet
- Input voltage: 100-240VAC, 50/60Hz
- UL listed
- Lamp pole is $1\frac{1}{4}$ " diameter; powdercoated lower section which connects to upper section with wood finish
- Lamp cord exits the upper wood section and re-enters the lower section to exit to the floor

PRODUCT POSITIONING

The Embra collection consists of freestanding lounge seating for community spaces, along with sleep sofas for patient spaces, to support a cohesive look throughout the facility. Intuitively designed with thoughtful details—including accessible power, storage for personal items, as well as surfaces and lighting—provide a sense of warmth and comfort

Additional features, including arm caps in multiple materials, clean out between the seat and back, and elevated metal legs, support cleanability and durability. Embra provides comfortable spaces for family interaction and quiet reflection with a homelike aesthetic

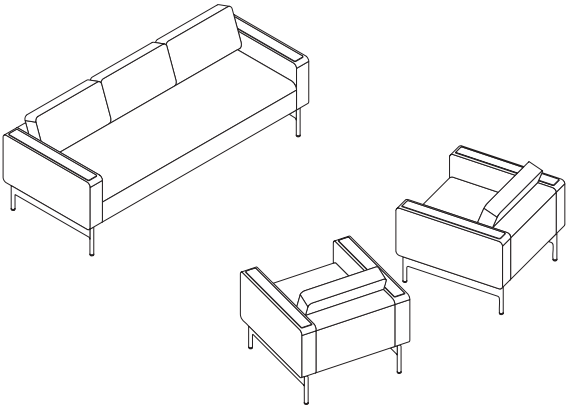

Freestanding Lounges



TO ORDER, SPECIFY:

1. Model Number
2. Inner Back Fabric Grade
3. Inner Back Fabric Number
4. Outer Back Fabric Grade
5. Outer Back Fabric Number
6. Seat Fabric Grade
7. Seat Fabric Number
8. Base Paint
9. Moisture Barrier Optional for Seat or Inside Back and Seat
10. Power/USB Option
11. End Cap Location

- See page 167 for Embra options
- See page 183 for COM fabric yardage

**FREESTANDING LOUNGE
ARMLESS CHAIR**

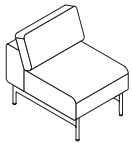

**MODEL
NO.**

ALLIANCE PROGRAM PRICE GRADES

		A	B	C	D	E	F	G	H	I
		J	K	L	M	N	O	P	Q	R
K73FL1XA	Chair	\$ 2735	2816	2879	2942	3009	3086	3134	3219	3290
		3365	3485	3725	3875	3909	3935	3974	4010	4175

DIMENSIONS

Width	24	Seat Height	18½	End Cap Support (if Selected)	Weight	79.9
Depth	32⅝	Seat Depth	20½	Width (Each)	Cubic Ft.	19.30
Height	31¼	Seat Width	24			

- Contrasting fabric option – specify X (i.e., K73FL1XA); see page 168. For list pricing, use your electronic specification tool or contact customer service
- Tight back
- Clean out (visible)
- Metal rails and legs
- Non-skid, adjustable glides

**FREESTANDING LOUNGE
ARMLESS LOVESEAT**

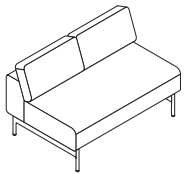

		A	B	C	D	E	F	G	H	I
		J	K	L	M	N	O	P	Q	R
K73FL2XA	Loveseat	\$ 3810	3930	4022	4115	4212	4326	4396	4520	4625
		4734	4910	5262	5482	5532	5570	5628	5681	5922

DIMENSIONS

Width	48½	Seat Height	18½	End Cap Support (if Selected)	Weight	129.5
Depth	32⅝	Seat Depth	20½	Width (Each)	Cubic Ft.	30.50
Height	31¼	Seat Width	48½			

- Contrasting fabric option – specify X (i.e., K73FL2XAX); see page 168. For list pricing, use your electronic specification tool or contact customer service
- Tight back
- Clean out
- Metal rails and legs
- Non-skid, adjustable glides

**FREESTANDING LOUNGE
ARMLESS SOFA**

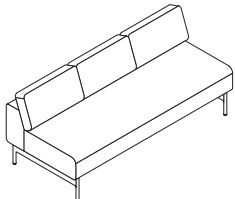

		A	B	C	D	E	F	G	H	I
		J	K	L	M	N	O	P	Q	R
K73FL3XA	Sofa	\$ 4524	4700	4836	4973	5117	5285	5389	5572	5727
		5889	6149	6669	6994	7067	7124	7209	7287	7644

DIMENSIONS

Width	72½	Seat Height	18½	End Cap Support (if Selected)	Weight	179.2
Depth	32⅝	Seat Depth	20½	Width (Each)	Cubic Ft.	41.60
Height	31¼	Seat Width	72½			

- Contrasting fabric option – specify X (i.e., K73FL3XAX); see page 168. For list pricing, use your electronic specification tool or contact customer service
- Tight back
- Clean out
- Metal rails and legs
- Non-skid, adjustable glides

EMBRA

TO ORDER, SPECIFY:

1. Model Number
2. Inner Back Fabric Grade
3. Inner Back Fabric Number
4. Outer Back Fabric Grade
5. Outer Back Fabric Number
6. Seat Fabric Grade
7. Seat Fabric Number
8. Arm Fabric Grade
9. Arm Fabric Number
10. Base Paint
11. Wood Finish Price Group
12. Arm Cap Designator (if applicable)
13. Moisture Barrier Optional for Seat or Inside Back and Seat
14. Power/USB Option
15. End Cap Location

- See page 167 for Embra options
- See page 183 for COM fabric yardage

**FREESTANDING LOUNGE
ARMS ON BOTH SIDES
CHAIR**

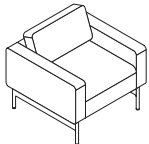

No Arm Caps

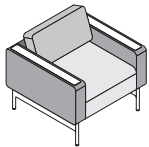

Arm Caps

**MODEL
NO.**

ALLIANCE PROGRAM PRICE GRADES

		A	B	C	D	E	F	G	H	I
		J	K	L	M	N	O	P	Q	R
K73FL1A	No Arm Caps	\$ 3358	3490	3593	3696	3805	3931	4009	4148	4264
		4387	4583	4975	5220	5275	5318	5381	5440	5710
K73FL1ACW	Wood Arm Caps	3438	3570	3673	3776	3885	4011	4089	4228	4344
		4467	4663	5055	5300	5355	5398	5461	5520	5790
K73FL1ACP	Polyurethane Arm Caps	3528	3660	3763	3866	3975	4101	4179	4318	4434
		4557	4753	5145	5390	5445	5488	5551	5610	5880
K73FL1ACS	Solid Surface Arm Caps	3978	4110	4213	4316	4425	4551	4629	4768	4884
		5007	5203	5595	5840	5895	5938	6001	6060	6330

DIMENSIONS

Width	32 ¹ / ₁₆	Seat Height	18 ¹ / ₁₆	Arm Height		End Cap Support (if Selected)	
Depth	32 ¹ / ₁₆	Seat Depth	20 ¹ / ₂	No Arm Caps	24%	Width (Each)	6
Height	31 ¹ / ₄	Seat Width	23 ¹ / ₁₆	Arm Caps	24 ¹³ / ₁₆	Weight	
				Arm Width	4%	Cubic Ft.	21.50

- Contrasting fabric option – specify X (i.e., K73FL1AX); see page 168. For list pricing, use your electronic specification tool or contact customer service
- Tight back
- Clean out
- Metal rails and legs
- Non-skid, adjustable glides
- Arm caps on applicable models

**FREESTANDING LOUNGE
ARMS ON BOTH SIDES
LOVESEAT**

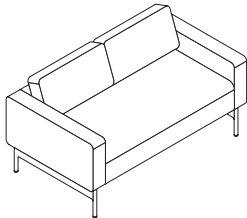

No Arm Caps

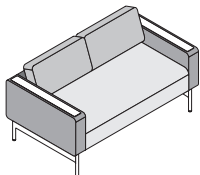

Arm Caps

**MODEL
NO.**

ALLIANCE PROGRAM PRICE GRADES

		A	B	C	D	E	F	G	H	I
		J	K	L	M	N	O	P	Q	R
K73FL2A	No Arm Caps	\$ 4433	4604	4736	4869	5008	5171	5271	5449	5599
		5756	6008	6512	6827	6898	6953	7035	7111	7457
K73FL2ACW	Wood Arm Caps	4513	4684	4816	4949	5088	5251	5351	5529	5679
		5836	6088	6592	6907	6978	7033	7115	7191	7537
K73FL2ACP	Polyurethane Arm Caps	4603	4774	4906	5039	5178	5341	5441	5619	5769
		5926	6178	6682	6997	7068	7123	7205	7281	7627
K73FL2ACS	Solid Surface Arm Caps	5053	5224	5356	5489	5628	5791	5891	6069	6219
		6376	6628	7132	7447	7518	7573	7655	7731	8077

DIMENSIONS

Width	56 ¹ / ₁₆	Seat Height	18 ¹ / ₁₆	Arm Height		End Cap Support (if Selected)	
Depth	32 ¹ / ₁₆	Seat Depth	20 ¹ / ₂	No Arm Caps	24%	Width (Each)	6
Height	31 ¹ / ₄	Seat Width	47 ¹ / ₁₆	Arm Caps	24 ¹³ / ₁₆	Weight	
				Arm Width	4%	Cubic Ft.	32.70

- Contrasting fabric option – specify X (i.e., K73FL2AX); see page 168. For list pricing, use your electronic specification tool or contact customer service
- Tight back
- Clean out
- Metal rails and legs
- Non-skid, adjustable glides
- Arm caps on applicable models

TO ORDER, SPECIFY:

1. Model Number
2. Inner Back Fabric Grade
3. Inner Back Fabric Number
4. Outer Back Fabric Grade
5. Outer Back Fabric Number
6. Seat Fabric Grade
7. Seat Fabric Number
8. Arm Fabric Grade
9. Arm Fabric Number
10. Base Paint
11. Wood Finish Price Group
12. Arm Cap Designator (if applicable)
13. Moisture Barrier Optional for Seat or Inside Back and Seat
14. Power/USB Option
15. End Cap Location

- See page 167 for Embra options
- See page 183 for COM fabric yardage

EMBRA

**FREESTANDING LOUNGE
ARMS ON BOTH SIDES
SOFA**

**MODEL
NO.**

ALLIANCE PROGRAM PRICE GRADES

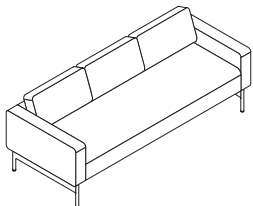

No Arm Caps

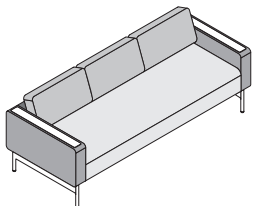

Arm Caps

			A	B	C	D	E	F	G	H	I
			J	K	L	M	N	O	P	Q	R
K73FL3A	No Arm Caps	\$	5147	5374	5550	5727	5913	6130	6264	6501	6701
			6911	7247	7919	8339	8433	8507	8616	8717	9179
K73FL3ACW	Wood Arm Caps		5227	5454	5630	5807	5993	6210	6344	6581	6781
			6991	7327	7999	8419	8513	8587	8696	8797	9259
K73FL3ACP	Polyurethane Arm Caps		5317	5544	5720	5897	6083	6300	6434	6671	6871
			7081	7417	8089	8509	8603	8677	8786	8887	9349
K73FL3ACS	Solid Surface Arm Caps		5767	5994	6170	6347	6533	6750	6884	7121	7321
			7531	7867	8539	8959	9053	9127	9236	9337	9799

DIMENSIONS

Width	80 ¹ / ₁₆	Seat Height	18 ¹ / ₁₆	Arm Height		End Cap Support (if Selected)	
Depth	32 ¹ / ₁₆	Seat Depth	20 ¹ / ₂	No Arm Caps	24 ¹ / ₁₆	Width (Each)	6
Height	31 ¹ / ₄	Seat Width	71 ¹ / ₁₆	Arm Caps	24 ¹³ / ₁₆	Weight	
				Arm Width	4 ¹ / ₁₆	Cubic Ft.	43.80

- Contrasting fabric option – specify X (i.e., K73FL3AX); see page 168. For list pricing, use your electronic specification tool or contact customer service
- Tight back
- Clean out
- Metal rails and legs
- Non-skid, adjustable glides
- Arm caps on applicable models

TO ORDER, SPECIFY:

• See page 167 for Embra options

1. Model Number

**MODULAR LOUNGE
GANGING BRACKET**



**MODEL
NO.**

LIST PRICE

K73LGB	Ganging Bracket	\$	11
--------	-----------------	----	----

DIMENSIONS

Width	2	Weight	0.2
Depth	5 $\frac{1}{2}$	Cubic Ft.	0.20
Height	$\frac{1}{8}$		

EMBRA

TO ORDER, SPECIFY:

1. Model Number
2. HPL Surface Designator
3. 3D Laminate Matte Luxe Color for Bottom of Surface

• See page 167 for Embra options

END CAPS SINGLE-TIER TABLE



MODEL NO.

LIST PRICE

K73ECT3212L	Single-Tier Table	\$	699
-------------	-------------------	----	-----

DIMENSIONS

Width	12
Depth	32
Height	1 ³ / ₁₆

Weight	12.0
Cubic Ft.	.60

- HPL top surface with 3D laminate matte luxe underside
- Rounded corners and sides

TO ORDER, SPECIFY:

• See page 167 for Embra options

1. Model Number
2. HPL Surface Designator
3. 3D Laminate Matte Luxe Color for Bottom of Surface
4. Base Paint Designator

**END CAPS
TIERED TABLE**

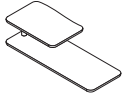

**MODEL
NO.**

LIST PRICE

K73ECTT3212L	Tiered Table	\$ 1457
--------------	--------------	---------

DIMENSIONS

Width	12
Depth	32
Height	8

Weight	22.3
Cubic Ft.	4.50

- HPL top surface with 3D laminate matte luxe underside
- Rounded corners and sides

EMBRA

TO ORDER, SPECIFY:

• See page 167 for Embra options

1. Model Number
2. HPL Surface Designator
3. 3D Laminate Matte Luxe Color for Bottom of Surface
4. Lamp Pole Lower Section Paint Designator
5. Lamp Pole Upper Section Finish Group
6. Lamp Pole Upper Section Finish Designator
7. Lamp Shade Color

END CAPS TIERED TABLE WITH LAMP

MODEL NO.

LIST PRICE

K73ECLTT3212L	Tiered Table with Lamp	\$ 2247
---------------	------------------------	---------

DIMENSIONS

Width	12	Weight	26.6
Depth	32	Cubic Ft.	13.20
Height	8		
Lamp Height	32½		

- HPL top surface with 3D laminate matte luxe underside
- Rounded corners and sides
- Lamp shade is 9" diameter and features LED light with touch switch, powdercoated paint finish; field installed

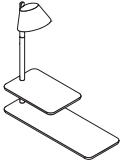

EMBRA

TO ORDER, SPECIFY:

• See page 167 for Embra options

1. Model Number
2. HPL Surface Designator
3. 3D Laminate Matte Luxe Color for Bottom of Surface
4. 3D Laminate Matte Luxe Color for Storage Vertical Surfaces

**END CAPS
STORAGE TABLE**

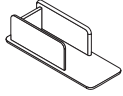

**MODEL
NO.**

LIST PRICE

K73ECST3212L	Storage Table	\$	2077
--------------	---------------	----	------

DIMENSIONS

Width	12
Depth	32
Height	8 ³ / ₄
Interior Width	8 ⁷ / ₁₆

Weight	23.3
Cubic Ft.	5.00

- HPL top surface with 3D laminate matte luxe underside and vertical panels
- Rounded corners and sides

EMBRA

TO ORDER, SPECIFY:

• See page 167 for Embra options

1. Model Number
2. HPL Surface Designator
3. 3D Laminate Matte Luxe Color for Bottom of Surface
4. 3D Laminate Matte Luxe Color for Storage Vertical Surfaces
5. Coat Rack Lower Section Paint Designator
6. Coat Rack Upper Section Finish Group
7. Coat Rack Upper Section Finish Designator

END CAPS STORAGE TABLE WITH COAT RACK

MODEL NO.

LIST PRICE

K73ECCRST3212L	Storage Table with Coat Rack	\$ 2652
----------------	------------------------------	---------

DIMENSIONS

Width	12
Depth	32
Height	45 ⁷ / ₁₆
Interior Width	8 ⁷ / ₁₆

Weight	16.4
Cubic Ft.	8.90

- HPL top surface with 3D laminate matte luxe underside and vertical panels
- Rounded corners and sides
- Coat rack on applicable model: wood with wood finish and metal powdercoat paint

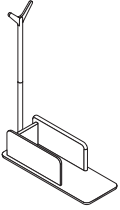

EMBRA

TO ORDER, SPECIFY:

1. Model Number
2. Fabric Grade
3. Fabric Number
4. Moisture Barrier Optional for Seat

- See page 167 for Embra options
- See page 183 for COM fabric yardage

**END CAPS
UPHOLSTERED BENCH**

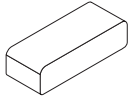

**MODEL
NO.**

ALLIANCE PROGRAM PRICE GRADES

			A	B	C	D	E	F	G	H	I
			J	K	L	M	N	O	P	Q	R
K73ECBE3212U	Upholstered Bench End Cap	\$	906	947	979	1011	1045	1085	1109	1152	1189
			1227	1288	1411	1487	1504	1518	1538	1556	1640

DIMENSIONS

Width 12¼
 Depth 32
 Height 8¼

Weight 19.9
 Cubic Ft. 2.70

- Upholstered cushion

EMBRA

TO ORDER, SPECIFY:

• See page 167 for Embra options

1. Insert the Power Module Designator in Applicable Step in the Model Number Sequence

KICK RAIL POWER/USB

MODEL NO.

LIST PRICE

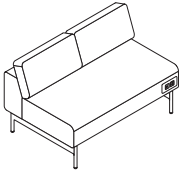

Left Front (as seated)

MTBLKL	Mini-Tap, Black	\$ 455
MTSILL	Mini-Tap, Silver	455
MTWHTL	Mini-Tap, White	455

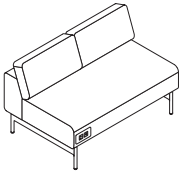

Right Front (as seated)

MTBLKR	Mini-Tap, Black	\$ 455
MTSILR	Mini-Tap, Silver	455
MTWHTR	Mini-Tap, White	455

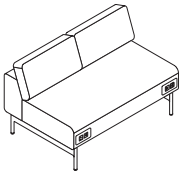

Left and Right Front (as seated)

MTBLKLR	Mini-Tap, Black	\$ 910
MTSILLR	Mini-Tap, Silver	910
MTWHTLR	Mini-Tap, White	910

DIMENSIONS

Width 4½
Height 2½

Weight
Cubic Ft.

- **Mini-Tap® Power/USB Center** is available as a factory-installed option on the kickrail of freestanding lounges
- **Mini-Tap® Power/USB Center** features include:
 - Tamper-resistant single AC power outlet with shutter mechanism that protects children from sticking foreign objects into the receptacle
 - USB A-C dual charging ports
 - Spill-proof
 - UL listed
- **Overall size** is 4½" wide x 2½" high. Overall cord length is 72"; 50" length exits the bottom of the lounge and is positioned towards the outside of the lounge
- **Available colors:**
 - Black—Gloss black mounting plate, black receptacle
 - Silver—Silver powdercoat mounting plate, white receptacle
 - White—Gloss white mounting plate, white receptacle

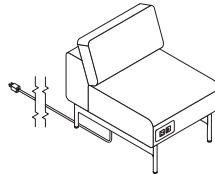

COM YARDAGE REQUIREMENTS

COM YARDAGE REQUIREMENTS (54" WIDTH – CUT UP THE ROLL)

MODEL	RAILROADED Contact customer service 800-634-9510 for ydg requirements	NON DIRECTIONAL OR SOLID	1"-4" REPEAT	5"-11" REPEAT	12"-18" REPEAT	COL SQUARE FEET
			4" VERTICAL X 4" HORIZONTAL	11" VERTICAL X 11" HORIZONTAL	18" VERTICAL X 18" HORIZONTAL	
K73FL1XA	Entire Unit	2.30	3.90	5.10	5.60	46.5
	Inner Back	0.70	1.40	1.60	2.10	14.4
	Outer Back	1.00	1.80	2.60	3.00	19.9
	Seat	1.30	1.50	2.20	2.60	25.5
K73FL2XA	Entire Unit	4.10	7.70	9.20	9.60	80.3
	Inner Back	1.30	2.40	2.80	3.10	25.5
	Outer Back	1.50	2.50	3.00	3.00	29.3
	Seat	1.60	3.10	3.80	4.60	32.1
K73FL3XA	Entire Unit	5.80	11.50	13.50	13.60	115.2
	Inner Back	1.90	3.90	4.70	5.10	38.2
	Outer Back	2.10	3.90	4.70	5.00	41
	Seat	2.50	4.30	5.10	6.10	49.3
K73FL1A, K73FL1ACW, K73FL1ACP, K73FL1ACS	Entire Unit	4.10	6.00	8.00	8.00	80.8
	Inner Back	0.70	1.40	1.60	2.10	14.4
	Outer Back	1.00	1.50	1.70	1.90	19.9
	Seat	1.30	1.80	2.60	3.00	25.5
	Arms	1.90	2.70	3.90	4.70	37.1
K73FL2A, K73FL2ACW, K73FL2ACP, K73FL2ACS	Entire Unit	5.80	9.50	11.70	11.70	115.7
	Inner Back	1.30	2.40	2.80	3.10	25.5
	Outer Back	1.50	2.50	3.00	3.00	29.3
	Seat	1.60	3.10	3.80	4.60	32.1
	Arms	1.90	2.50	3.50	4.20	37.1
K73FL3A, K73FL3ACW, K73FL3ACP, K73FL3ACS	Entire Unit	7.50	13.30	16.00	16.00	150
	Inner Back	1.90	3.90	4.70	5.10	38.2
	Outer Back	2.10	3.90	4.70	5.00	41
	Seat	2.50	4.30	5.10	6.10	49.3
	Arms	1.90	2.50	3.50	4.20	37.1
K73ECBE3212U	Entire Unit	1.50	1.70	2.60	3.20	30.4

EMBRA

