Embra

| | |
|--------------------------|-----|
| Product Specifications | 184 |
| Fabrics and Options | 185 |
| Contrasting Fabric | 186 |
| End Caps | 187 |
| Product Positioning | 189 |
| Product Pages | 190 |
| COM Yardage Requirements | 200 |

EMBRA PRODUCT SPECIFICATIONS

CUSHIONS

- Cushions are made of high grade, high resiliency, CFC-free, laminated polyurethane foam

ARMS

- Arms are 4" thick
- Arm frames are constructed of ½" thick plywood
- Arm tops and outside panels feature ½" and ¾" thick high grade polyurethane foam
- Arms feature a sewn slipcover with French seams that is stapled into place

BACK, SEAT, AND ARMS

- Back, seat, and arms have decorative top-stitch detailing

END CAP TABLES, CORNER TABLES, AND TABLETS

- End cap tables, corner tables, and tablets consist of a HPL top surface, MDF core, and a 3D Laminate matte luxe bottom surface with low sheen
- Matte luxe provides a soft touch and feel
- All surfaces have rounded corners and sides

ARM CAPS

- Arm caps are available in wood, polyurethane, and solid surface
- EOS^{CU} (Cupron enhanced EOS) biocidal solid surface arm caps are optional on solid surface arm cap model; upcharge applies

TABLETS

- Tablets are handed and swing 90 degrees, allowing easy access
- Tablet mechanism attaches to the front of arm (field installed) and features a platinum metallic finish

SEATS

- Seats feature a high-tension, strip webbing suspension
- Seat upholstery features a wrap-around upholstery method and is stapled into place

LEG FRAMES

- Leg frames are casted aluminum side frame; powdercoated

RAILS

- Rails are rectangular tubular steel with 2mm wall thickness; powdercoat finish

POWER/USB CENTER

- Mini-Tap[®] power/USB center option features one AC power outlet and USB A+C dual charging ports
- Factory installed; upcharge applies

CLEAN OUT

- Clean out is standard on all models to make cleaning easy and simple
- Clean out space is slightly visible between back and seat cushions, but does not detract from the aesthetic or function of the lounge

GLIDES

- Non-skid, adjustable black glides are 1" in diameter with 1" adjustability

FRAME

- Frame is constructed of ¾" thick OSB, using a lap-joint construction method
- Frames are glued and screwed together

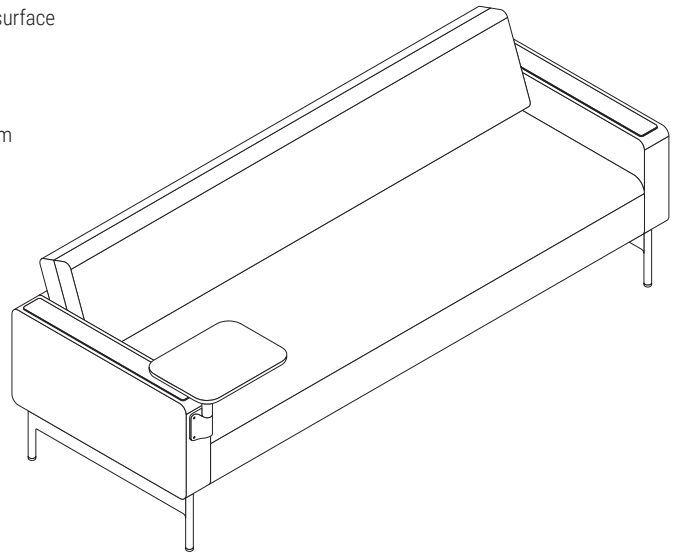
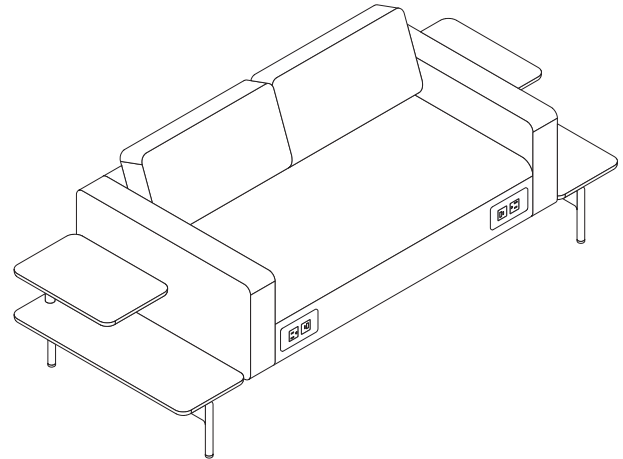

SURFACE MATERIALS

See the Kimball Hospitality Surface Materials Reference Guide at kimballhospitality.com for a complete overview of our materials program, including:

- Characteristics of wood
- Special wood finishes
- Customer-specified laminate (CSL)
- Customer-specified paint (CSP)
- Fabric application and colorways
- Customer's own material (COM) process overview
- Alliance program

ALLIANCE FABRIC PROGRAM

Kimball Hospitality has analyzed each model to most accurately reflect the COM/COL yardage requirements shown on page 200.

The yardage requirement for each model is based on 54" W fabric and cutting the fabric up the roll.

If repeat is larger than 18", contact Customer Service to confirm the correct amount of yardage required. When ordering 10 or more chairs in the same COM, yardage requirements may be reduced.

Contact Customer Service.

PRICE GRADES A-R

See Surface Materials at www.kimballhospitality.com for a wide variety of graded-in fabrics from Arc-Com, Carnegie, CF Stinson, Designtex, Maharam, Mayer, Momentum, and Ultrafabrics.

FABRIC SAMPLES

If you need samples for presentation(s), contact our alliance partners directly at:

| | | |
|--------------|--------------|--|
| Arc-Com | 800.223.5466 | arc-com.com |
| Carnegie | 800.727.6770 | carnegiefabrics.com |
| CF Stinson | 800.841.6279 | cfstinson.com |
| Designtex | 800.221.1540 | designtex.com |
| Maharam | 800.645.3943 | maharam.com |
| Mayer | 800.428.4415 | mayerfabrics.com |
| Momentum | 800.366.6839 | memosamples.com |
| Ultrafabrics | 877.309.6648 | ultrafabricsllc.com |

END CAP TABLES AND STORAGE TABLES, CORNER TABLES AND TABLETS

3D LAMINATE

MATTE LUXE

- 462 Cinder
- 440 Cloud
- 405 Designer White

END CAP TOP SURFACES, TABLET TOP SURFACES, AND CORNER TABLE TOP SURFACES

HPL

WOODGRAIN

- BZ Brazilwood
- CO Canyon
- CI Chai
- DF Driftwood
- KN Kona
- YO Monterey
- PC Porcini
- PB Portobello
- 792 Sable
- NW Tuscan
- WL Willow

SOLID

- 462 Cinder
- 440 Cloud
- 405 Designer White

FREESTANDING END CAP LOCATION

- X None
- L Left as Seated
- R Right as Seated
- LR Left and Right as Seated

BASE LEGS/RAILS, COAT RACK POLE BOTTOM SECTION, AND LAMP POLE BOTTOM SECTION

PAINT

SOLID COLOR PAINT

- 462 Cinder
- 440 Cloud
- 405 Designer White

METALLIC PAINT

- 501 Platinum Metallic

LAMP SHADE

PAINT

SOLID COLOR PAINT

- BLK Matte black
- WHT Matte white

METALLIC PAINT

- SIL Silver

ARM CAPS

POLYURETHANE

- 495 Beige
- 462 Cinder
- 496 Grey

SOLID SURFACE

STANDARD

- 7101 Bisque
- 405 Designer White

PREMIUM*

- 467 Carbon Concrete
- 468 Neutral Concrete
- 464 Peace Grey
- 469 Weathered Concrete

EOS*

- 495 EOS^{CU} Beige
- 496 EOS^{CU} Grey
- (1 Arm \$392 upcharge)
- (2 Arm \$784 upcharge)

*Upcharge applies

ARM CAPS, COAT RACK (UPPER SECTION), AND LAMP POLE (UPPER SECTION)

WOOD FINISH

PRICE GROUP 1

- | | |
|---------------|---------------|
| BZ Brazilwood | MH Mocha |
| CO Canyon | YO Monterey |
| CI Chai | PC Porcini |
| CC Cordoba | PB Portobello |
| DF Driftwood | 792 Sable |
| KN Kona | NW Tuscan |
| MW Midtown | WL Willow |

IMPORTANT: Wood finishes applied to solid hardwood are complementary to the same wood finish applied to wood veneer, but not an exact match. Contact Customer Service for more information.

TABLET LOCATION

- L Left as Seated
- R Right as Seated
- LR Left and Right (\$1328 upcharge)

MOISTURE BARRIER

- X None
- MB1 Seat (\$140 upcharge)
- MB2 Seat and Inside Back (\$245 upcharge)

TO ORDER CONTRASTING FABRIC, SPECIFY

EMBRA

Chair, Loveseat, and Sofa Freestanding Lounge, Armless page 190

1. Model Number plus "X"
2. Inner Back Fabric Grade
3. Inner Back Fabric Number
4. Outer Back Fabric Grade
5. Outer Back Fabric Number
6. Seat Fabric Grade
7. Seat Fabric Number
8. Base Paint
9. Moisture Barrier Optional for Seat or Inside Back and Seat
10. Power/USB Option
11. End Cap Location

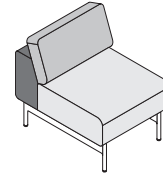

Contrasting Fabric may be specified on inside back, outside back, and seat

Chair and Loveseat Freestanding Lounge, Arms on Both Sides page 191 Sofa Freestanding Lounge, Arms on Both Sides page 192

1. Model Number plus "X"
2. Inner Back Fabric Grade
3. Inner Back Fabric Number
4. Outer Back Fabric Grade
5. Outer Back Fabric Number
6. Seat Fabric Grade
7. Seat Fabric Number
8. Arm Fabric Grade
9. Arm Fabric Number
10. Base Paint
11. Wood Finish Price Group
12. Arm Cap Designator (if applicable)
13. Moisture Barrier Optional for Seat or Inside Back and Seat
14. Power/USB Option
15. End Cap Location

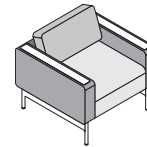

Contrasting Fabric may be specified on inside back, outside back, seat, and arms

END CAPS

End caps, specified separately for field installation, are available for one or both ends of freestanding lounges

End cap tables provide easy-to-access horizontal surfaces. They are available in several styles to accommodate the needs in community spaces and patient rooms. They feature rounded corners and sides for safety



End caps are supported by the leg frame on the lounge or sofa model

IMPORTANT: The lounge model must be specified to accept an end cap

By selecting the desired end cap location/connection on freestanding lounge model, the rails and legs will be extended 6" to the left, right, or on both sides to accept and support an end cap

End caps can be added to the left, right or both sides of freestanding lounges with or without arms. Handing designation is determined from the user's perspective when seated



Single-Tier Table

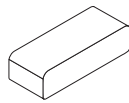

Upholstered Bench

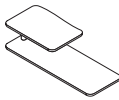

Tiered Table

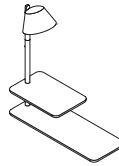

Tiered Table with Lamp

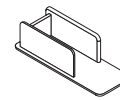

Storage Table

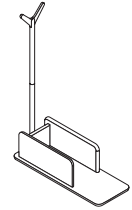

Storage Table with Coat Rack

SINGLE-TIER TABLE:

- Can be used in any configuration, but is best suited for use with armless models
- Table surface is 32" deep x 12" wide x 1³/₁₆" thick
- Height is 10¹³/₁₆" above the floor when attached to leg frame (seat height is 18¹/₁₆")
- HPL top surface; underside is 3D laminate matte luxe

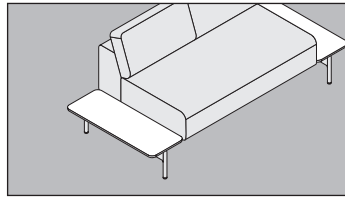

Single-Tier

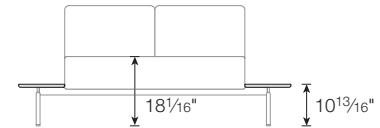

UPHOLSTERED BENCH:

- For use with armless lounge models; ideal for back-to-back applications
- Bench surface is 32" deep x 12" wide x 18¹/₁₆" (same height as lounge seat)

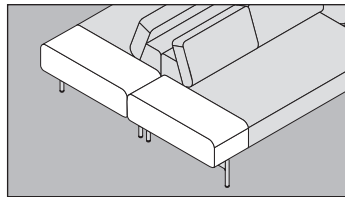

Upholstered Bench in Back-to-Back Application

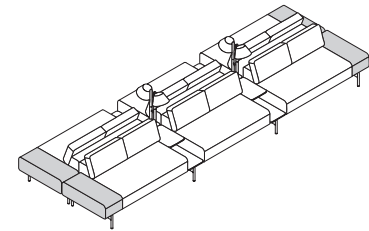

GANGING APPLICATIONS:



One ganging bracket is required when lounge and/or end caps are used back-to-back. See page 193

TO ORDER CONTRASTING FABRIC, SPECIFY

END CAPS (CONTINUED)

TIERED TABLES WITH OR WITHOUT LAMP:

- Can be used in any configuration, but is best suited for use with models with arms
- Lower tier surface is 32" deep x 12" wide x $\frac{1}{8}$ " thick; height is $10\frac{13}{16}$ " above the floor when attached to leg frame
- Top tier is 18" deep and sits above the bottom tier by $6\frac{3}{8}$ "
- HPL top surface; underside is 3D laminate matte luxe
- Lamp has 9" diameter aluminum spun lamp shade with powdercoat finish: Matte Black, Matte White, or Silver. Glossy white interior

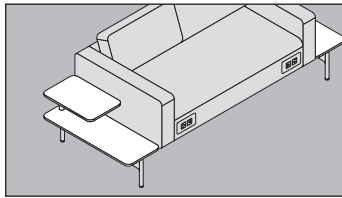

Tiered End Cap

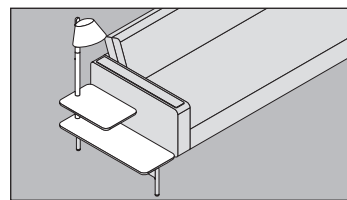
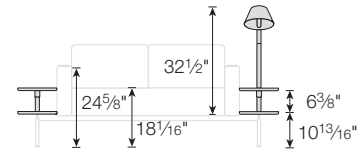

Tiered End Cap with Lamp
• Lamp height is well-suited for reading

STORAGE TABLES WITH OR WITHOUT COAT RACK:

- Can be used in any configuration
- Coat rack models are best suited for end-of-run applications
- Storage area ideal for storing linens, pillows, or personal items
- Interior storage area is $19\frac{1}{16}$ " deep x $8\frac{7}{16}$ " wide x $8\frac{1}{4}$ " high; height is $10\frac{13}{16}$ " above the floor when attached to leg frame
- Table surface is 32" deep x 12" wide x $\frac{1}{8}$ " thick; HPL top surface; underside is 3D laminate matte luxe
- Vertical sides of storage area are 3D laminate matte

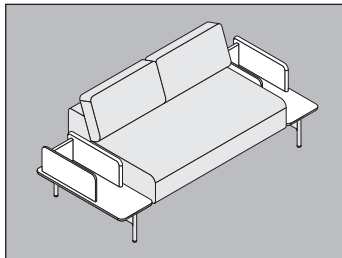

Storage End Cap

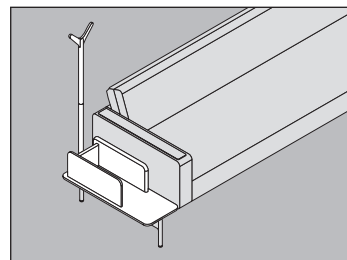
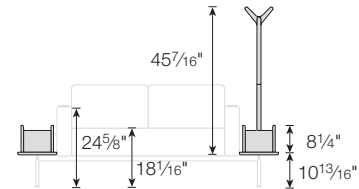

Storage End Cap with Coat Rack
• Keeps personal items out of the sleep area and off of the floor

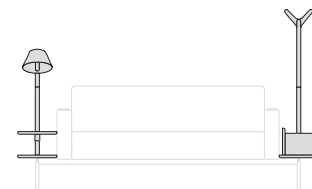

- Lamp and coat rack heights are different based on function

LAMP DETAILS:

- LED Light
- Touch switch on lamp shade interior
- Light output 320lm
- Light color: 2700K
- Power consumption: 4.5W
- Cord: white, 8 feet
- Input voltage: 100-240VAC, 50/60Hz
- UL listed
- Lamp pole is $1\frac{1}{4}$ " diameter; powdercoated lower section which connects to upper section with wood finish
- Lamp cord exits the upper wood section and re-enters the lower section to exit to the floor

PRODUCT POSITIONING

The Embra collection consists of freestanding lounge seating for community spaces, along with sleep sofas for patient spaces, to support a cohesive look throughout the facility. Intuitively designed with thoughtful details—including accessible power, storage for personal items, as well as surfaces and lighting—provide a sense of warmth and comfort

Additional features, including arm caps in multiple materials, clean out between the seat and back, and elevated metal legs, support cleanability and durability. Embra provides comfortable spaces for family interaction and quiet reflection with a homelike aesthetic

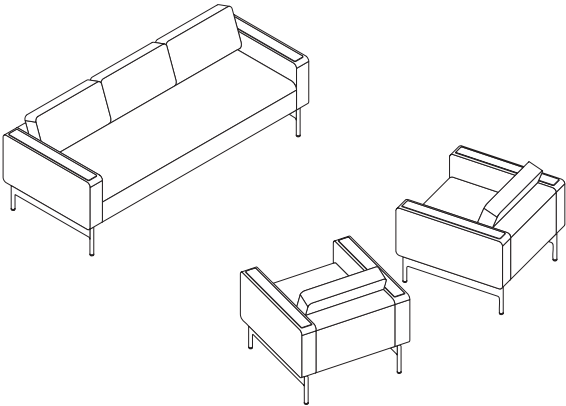

Freestanding Lounges



EMBRA

TO ORDER, SPECIFY:

1. Model Number
2. Inner Back Fabric Grade
3. Inner Back Fabric Number
4. Outer Back Fabric Grade
5. Outer Back Fabric Number
6. Seat Fabric Grade
7. Seat Fabric Number
8. Base Paint
9. Moisture Barrier Optional for Seat or Inside Back and Seat
10. Power/USB Option
11. End Cap Location

- See page 185 for Embra options
- See page 200 for COM fabric yardage

FREESTANDING LOUNGE ARMLESS CHAIR

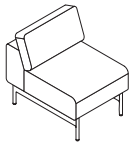

MODEL NO.

ALLIANCE PROGRAM PRICE GRADES

| | | | A | B | C | D | E | F | G | H | I |
|----------|-------|----|------|------|------|------|------|------|------|------|------|
| | | | J | K | L | M | N | O | P | Q | R |
| K73FL1XA | Chair | \$ | 3305 | 3401 | 3476 | 3551 | 3633 | 3728 | 3783 | 3887 | 3974 |
| | | | 4064 | 4208 | 4496 | 4679 | 4718 | 4754 | 4799 | 4841 | 5043 |

DIMENSIONS

| | | | | | | |
|--------|-----|-------------|-----|-------------------------------|-----------|-------|
| Width | 24 | Seat Height | 18½ | End Cap Support (if Selected) | Weight | 79.9 |
| Depth | 32⅙ | Seat Depth | 20½ | Width (Each) | Cubic Ft. | 19.30 |
| Height | 31¼ | Seat Width | 24 | | | |

- Contrasting fabric option – specify X (i.e., K73FL1XA); see page 186. For list pricing, use your electronic specification tool or contact customer service
- Tight back
- Clean out (visible)
- Metal rails and legs
- Non-skid, adjustable glides

FREESTANDING LOUNGE ARMLESS LOVESEAT

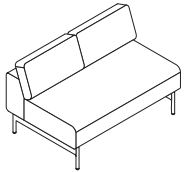

| | | | A | B | C | D | E | F | G | H | I |
|----------|----------|----|------|------|------|------|------|------|------|------|------|
| | | | J | K | L | M | N | O | P | Q | R |
| K73FL2XA | Loveseat | \$ | 4606 | 4746 | 4857 | 4966 | 5086 | 5226 | 5306 | 5459 | 5587 |
| | | | 5719 | 5930 | 6353 | 6620 | 6678 | 6731 | 6796 | 6858 | 7154 |

DIMENSIONS

| | | | | | | |
|--------|-----|-------------|-----|-------------------------------|-----------|-------|
| Width | 48½ | Seat Height | 18½ | End Cap Support (if Selected) | Weight | 129.5 |
| Depth | 32⅙ | Seat Depth | 20½ | Width (Each) | Cubic Ft. | 30.50 |
| Height | 31¼ | Seat Width | 48½ | | | |

- Contrasting fabric option – specify X (i.e., K73FL2XAX); see page 186. For list pricing, use your electronic specification tool or contact customer service
- Tight back
- Clean out
- Metal rails and legs
- Non-skid, adjustable glides

FREESTANDING LOUNGE ARMLESS SOFA

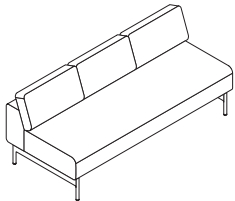

| | | | A | B | C | D | E | F | G | H | I |
|----------|------|----|------|------|------|------|------|------|------|------|------|
| | | | J | K | L | M | N | O | P | Q | R |
| K73FL3XA | Sofa | \$ | 5468 | 5676 | 5839 | 6001 | 6178 | 6385 | 6503 | 6729 | 6918 |
| | | | 7113 | 7425 | 8049 | 8445 | 8530 | 8608 | 8705 | 8796 | 9233 |

DIMENSIONS

| | | | | | | |
|--------|-----|-------------|-----|-------------------------------|-----------|-------|
| Width | 72½ | Seat Height | 18½ | End Cap Support (if Selected) | Weight | 179.2 |
| Depth | 32⅙ | Seat Depth | 20½ | Width (Each) | Cubic Ft. | 41.60 |
| Height | 31¼ | Seat Width | 72½ | | | |

- Contrasting fabric option – specify X (i.e., K73FL3XAX); see page 186. For list pricing, use your electronic specification tool or contact customer service
- Tight back
- Clean out
- Metal rails and legs
- Non-skid, adjustable glides

TO ORDER, SPECIFY:

1. Model Number
2. Inner Back Fabric Grade
3. Inner Back Fabric Number
4. Outer Back Fabric Grade
5. Outer Back Fabric Number
6. Seat Fabric Grade
7. Seat Fabric Number
8. Arm Fabric Grade
9. Arm Fabric Number
10. Base Paint
11. Wood Finish Price Group
12. Arm Cap Designator (if applicable)
13. Moisture Barrier Optional for Seat or Inside Back and Seat
14. Power/USB Option
15. End Cap Location

- See page 185 for Embra options
- See page 200 for COM fabric yardage

**FREESTANDING LOUNGE
ARMS ON BOTH SIDES
CHAIR**

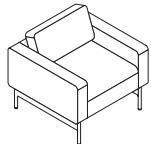

No Arm Caps

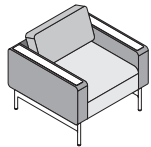

Arm Caps

**MODEL
NO.**

ALLIANCE PROGRAM PRICE GRADES

| | | A | B | C | D | E | F | G | H | I |
|-----------|------------------------|---------|------|------|------|------|------|------|------|------|
| | | J | K | L | M | N | O | P | Q | R |
| K73FL1A | No Arm Caps | \$ 4058 | 4215 | 4338 | 4460 | 4594 | 4749 | 4839 | 5009 | 5151 |
| | | 5298 | 5533 | 6004 | 6303 | 6366 | 6425 | 6499 | 6567 | 6897 |
| K73FL1ACW | Wood Arm Caps | 4155 | 4312 | 4435 | 4557 | 4691 | 4846 | 4936 | 5106 | 5248 |
| | | 5395 | 5630 | 6101 | 6400 | 6463 | 6522 | 6596 | 6664 | 6994 |
| K73FL1ACP | Polyurethane Arm Caps | 4263 | 4420 | 4543 | 4665 | 4799 | 4954 | 5044 | 5214 | 5356 |
| | | 5503 | 5738 | 6209 | 6508 | 6571 | 6630 | 6704 | 6772 | 7102 |
| K73FL1ACS | Solid Surface Arm Caps | 4807 | 4964 | 5087 | 5209 | 5343 | 5498 | 5588 | 5758 | 5900 |
| | | 6047 | 6282 | 6753 | 7052 | 7115 | 7174 | 7248 | 7316 | 7646 |

DIMENSIONS

| | | | | | | | |
|--------|---------------------------------|-------------|---------------------------------|-------------|----------------------------------|-------------------------------|-------|
| Width | 32 ¹ / ₁₆ | Seat Height | 18 ¹ / ₁₆ | Arm Height | | End Cap Support (if Selected) | |
| Depth | 32 ¹ / ₁₆ | Seat Depth | 20 ¹ / ₂ | No Arm Caps | 24% | Width (Each) | 6 |
| Height | 31 ¹ / ₄ | Seat Width | 23 ¹ / ₁₆ | Arm Caps | 24 ¹³ / ₁₆ | Weight | |
| | | | | Arm Width | 4% | Cubic Ft. | 21.50 |

- Contrasting fabric option – specify X (i.e., K73FL1AX); see page 186. For list pricing, use your electronic specification tool or contact customer service
- Tight back
- Clean out
- Metal rails and legs
- Non-skid, adjustable glides
- Arm caps on applicable models

**FREESTANDING LOUNGE
ARMS ON BOTH SIDES
LOVESEAT**

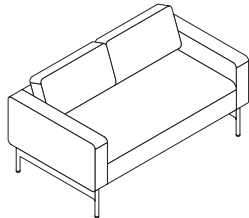

No Arm Caps

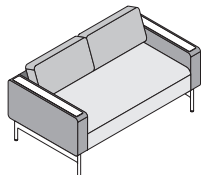

Arm Caps

**MODEL
NO.**

ALLIANCE PROGRAM PRICE GRADES

| | | A | B | C | D | E | F | G | H | I |
|-----------|------------------------|---------|------|------|------|------|------|------|------|------|
| | | J | K | L | M | N | O | P | Q | R |
| K73FL2A | No Arm Caps | \$ 5359 | 5560 | 5719 | 5875 | 6047 | 6247 | 6362 | 6581 | 6764 |
| | | 6953 | 7255 | 7861 | 8244 | 8326 | 8402 | 8496 | 8584 | 9008 |
| K73FL2ACW | Wood Arm Caps | 5455 | 5656 | 5815 | 5971 | 6143 | 6343 | 6458 | 6677 | 6860 |
| | | 7049 | 7351 | 7957 | 8340 | 8422 | 8498 | 8592 | 8680 | 9104 |
| K73FL2ACP | Polyurethane Arm Caps | 5563 | 5764 | 5923 | 6079 | 6251 | 6451 | 6566 | 6785 | 6968 |
| | | 7157 | 7459 | 8065 | 8448 | 8530 | 8606 | 8700 | 8788 | 9212 |
| K73FL2ACS | Solid Surface Arm Caps | 6107 | 6308 | 6467 | 6623 | 6795 | 6995 | 7110 | 7329 | 7512 |
| | | 7701 | 8003 | 8609 | 8992 | 9074 | 9150 | 9244 | 9332 | 9756 |

DIMENSIONS

| | | | | | | | |
|--------|---------------------------------|-------------|---------------------------------|-------------|----------------------------------|-------------------------------|-------|
| Width | 56 ¹ / ₁₆ | Seat Height | 18 ¹ / ₁₆ | Arm Height | | End Cap Support (if Selected) | |
| Depth | 32 ¹ / ₁₆ | Seat Depth | 20 ¹ / ₂ | No Arm Caps | 24% | Width (Each) | 6 |
| Height | 31 ¹ / ₄ | Seat Width | 47 ¹ / ₁₆ | Arm Caps | 24 ¹³ / ₁₆ | Weight | |
| | | | | Arm Width | 4% | Cubic Ft. | 32.70 |

- Contrasting fabric option – specify X (i.e., K73FL2AX); see page 186. For list pricing, use your electronic specification tool or contact customer service
- Tight back
- Clean out
- Metal rails and legs
- Non-skid, adjustable glides
- Arm caps on applicable models

TO ORDER, SPECIFY:

1. Model Number
2. Inner Back Fabric Grade
3. Inner Back Fabric Number
4. Outer Back Fabric Grade
5. Outer Back Fabric Number
6. Seat Fabric Grade
7. Seat Fabric Number
8. Arm Fabric Grade
9. Arm Fabric Number
10. Base Paint
11. Wood Finish Price Group
12. Arm Cap Designator (if applicable)
13. Moisture Barrier Optional for Seat or Inside Back and Seat
14. Power/USB Option
15. End Cap Location

- See page 185 for Embra options
- See page 200 for COM fabric yardage

EMBRA

**FREESTANDING LOUNGE
ARMS ON BOTH SIDES
SOFA**

**MODEL
NO.**

ALLIANCE PROGRAM PRICE GRADES

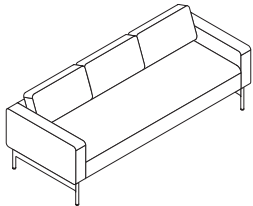

No Arm Caps

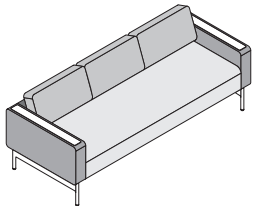

Arm Caps

| MODEL NO. | Description | Price | A | B | C | D | E | F | G | H | I |
|-----------|------------------------|---------|------|-------|-------|-------|-------|-------|-------|-------|---|
| | | | J | K | L | M | N | O | P | Q | R |
| K73FL3A | No Arm Caps | \$ 6221 | 6490 | 6701 | 6910 | 7139 | 7406 | 7559 | 7851 | 8095 | |
| | | 8347 | 8750 | 9557 | 10069 | 10178 | 10279 | 10405 | 10522 | 11087 | |
| K73FL3ACW | Wood Arm Caps | 6318 | 6587 | 6798 | 7007 | 7236 | 7503 | 7656 | 7948 | 8192 | |
| | | 8444 | 8847 | 9654 | 10166 | 10275 | 10376 | 10502 | 10619 | 11184 | |
| K73FL3ACP | Polyurethane Arm Caps | 6426 | 6695 | 6906 | 7115 | 7344 | 7611 | 7764 | 8056 | 8300 | |
| | | 8552 | 8955 | 9762 | 10274 | 10383 | 10484 | 10610 | 10727 | 11292 | |
| K73FL3ACS | Solid Surface Arm Caps | 6970 | 7239 | 7450 | 7659 | 7888 | 8155 | 8308 | 8600 | 8844 | |
| | | 9096 | 9499 | 10306 | 10818 | 10927 | 11028 | 11154 | 11271 | 11836 | |

DIMENSIONS

| | | | | | | | |
|--------|---------------------------------|-------------|---------------------------------|-------------|----------------------------------|-------------------------------|-------|
| Width | 80 ¹ / ₁₆ | Seat Height | 18 ¹ / ₁₆ | Arm Height | | End Cap Support (if Selected) | |
| Depth | 32 ¹ / ₁₆ | Seat Depth | 20 ¹ / ₂ | No Arm Caps | 24 ¹ / ₁₆ | Width (Each) | 6 |
| Height | 31 ¹ / ₄ | Seat Width | 71 ¹ / ₁₆ | Arm Caps | 24 ¹³ / ₁₆ | Weight | |
| | | | | Arm Width | 4 ¹ / ₁₆ | Cubic Ft. | 43.80 |

- Contrasting fabric option – specify X (i.e., K73FL3AX); see page 186. For list pricing, use your electronic specification tool or contact customer service
- Tight back
- Clean out
- Metal rails and legs
- Non-skid, adjustable glides
- Arm caps on applicable models

TO ORDER, SPECIFY:

• See page 185 for Embra options

1. Model Number

**MODULAR LOUNGE
GANGING BRACKET**



**MODEL
NO.**

LIST PRICE

K73LGB Ganging Bracket \$ 14

DIMENSIONS

Width 2
Depth 5½
Height ¼

Weight 0.2
Cubic Ft. 0.20

EMBRA

TO ORDER, SPECIFY:

1. Model Number
2. HPL Surface Designator
3. 3D Laminate Matte Luxe Color for Bottom of Surface

• See page 185 for Embra options

END CAPS SINGLE-TIER TABLE



MODEL NO.

LIST PRICE

| | | | |
|-------------|-------------------|----|-----|
| K73ECT3212L | Single-Tier Table | \$ | 844 |
|-------------|-------------------|----|-----|

DIMENSIONS

| | |
|--------|-----------------|
| Width | 12 |
| Depth | 32 |
| Height | $1\frac{3}{16}$ |

| | |
|-----------|------|
| Weight | 12.0 |
| Cubic Ft. | .60 |

- HPL top surface with 3D laminate matte luxe underside
- Rounded corners and sides

TO ORDER, SPECIFY:

1. Model Number
2. HPL Surface Designator
3. 3D Laminate Matte Luxe Color for Bottom of Surface
4. Base Paint Designator

• See page 185 for Embra options

**END CAPS
TIERED TABLE**

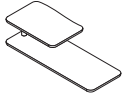

**MODEL
NO.**

LIST PRICE

| | | |
|--------------|--------------|---------|
| K73ECTT3212L | Tiered Table | \$ 1760 |
|--------------|--------------|---------|

DIMENSIONS

| | |
|--------|----|
| Width | 12 |
| Depth | 32 |
| Height | 8 |

| | |
|-----------|------|
| Weight | 22.3 |
| Cubic Ft. | 4.50 |

- HPL top surface with 3D laminate matte luxe underside
- Rounded corners and sides

EMBRA

TO ORDER, SPECIFY:

• See page 185 for Embra options

1. Model Number
2. HPL Surface Designator
3. 3D Laminate Matte Luxe Color for Bottom of Surface
4. Lamp Pole Lower Section Paint Designator
5. Lamp Pole Upper Section Finish Group
6. Lamp Pole Upper Section Finish Designator
7. Lamp Shade Color

END CAPS TIERED TABLE WITH LAMP

MODEL NO.

LIST PRICE

| | | |
|---------------|------------------------|---------|
| K73ECLTT3212L | Tiered Table with Lamp | \$ 2713 |
|---------------|------------------------|---------|

DIMENSIONS

| | | | |
|-------------|-----|-----------|-------|
| Width | 12 | Weight | 26.6 |
| Depth | 32 | Cubic Ft. | 13.20 |
| Height | 8 | | |
| Lamp Height | 32½ | | |

- HPL top surface with 3D laminate matte luxe underside
- Rounded corners and sides
- Lamp shade is 9" diameter and features LED light with touch switch, powdercoated paint finish; field installed

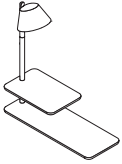

EMBRA

TO ORDER, SPECIFY:

• See page 185 for Embra options

1. Model Number
2. HPL Surface Designator
3. 3D Laminate Matte Luxe Color for Bottom of Surface
4. 3D Laminate Matte Luxe Color for Storage Vertical Surfaces
5. Coat Rack Lower Section Paint Designator
6. Coat Rack Upper Section Finish Group
7. Coat Rack Upper Section Finish Designator

**END CAPS
STORAGE TABLE WITH
COAT RACK**

**MODEL
NO.**

LIST PRICE

K73ECCRST3212L Storage Table with Coat Rack \$ 3203

DIMENSIONS

Width 12
 Depth 32
 Height 45⁷/₁₆
 Interior Width 8⁷/₁₆

Weight 16.4
 Cubic Ft. 8.90

- HPL top surface with 3D laminate matte luxe underside and vertical panels
- Rounded corners and sides
- Coat rack on applicable model: wood with wood finish and metal powdercoat paint

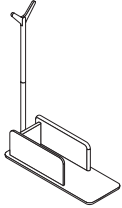

EMBRA

TO ORDER, SPECIFY:

1. Model Number
2. Fabric Grade
3. Fabric Number
4. Moisture Barrier Optional for Seat

- See page 185 for Embra options
- See page 200 for COM fabric yardage

END CAPS UPHOLSTERED BENCH

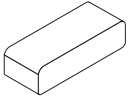

MODEL NO.

ALLIANCE PROGRAM PRICE GRADES

| | | | A | B | C | D | E | F | G | H | I |
|--------------|---------------------------|----|------|------|------|------|------|------|------|------|------|
| | | | J | K | L | M | N | O | P | Q | R |
| K73ECBE3212U | Upholstered Bench End Cap | \$ | 1095 | 1144 | 1182 | 1220 | 1262 | 1311 | 1338 | 1392 | 1436 |
| | | | 1482 | 1556 | 1702 | 1796 | 1816 | 1834 | 1857 | 1878 | 1981 |

DIMENSIONS

| | | | | | | | | | | |
|--------|-----|--|--|--|--|--|--|--|-----------|------|
| Width | 12¼ | | | | | | | | Weight | 19.9 |
| Depth | 32 | | | | | | | | Cubic Ft. | 2.70 |
| Height | 8¼ | | | | | | | | | |

- Upholstered cushion

TO ORDER, SPECIFY:

• See page 185 for Embra options

1. Insert the Power Module Designator in Applicable Step in the Model Number Sequence

KICK RAIL POWER/USB

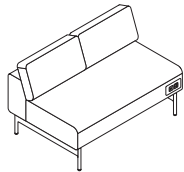

Left Front (as seated)

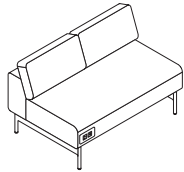

Right Front (as seated)

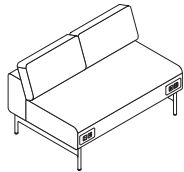

Left and Right Front (as seated)

MODEL NO.

LIST PRICE

| | | |
|--------|------------------|--------|
| MTBLKL | Mini-Tap, Black | \$ 550 |
| MTSILL | Mini-Tap, Silver | 550 |
| MTWHTL | Mini-Tap, White | 550 |

| | | |
|--------|------------------|--------|
| MTBLKR | Mini-Tap, Black | \$ 550 |
| MTSILR | Mini-Tap, Silver | 550 |
| MTWHTR | Mini-Tap, White | 550 |

| | | |
|---------|------------------|---------|
| MTBLKLR | Mini-Tap, Black | \$ 1100 |
| MTSILLR | Mini-Tap, Silver | 1100 |
| MTWHTLR | Mini-Tap, White | 1100 |

DIMENSIONS

Width 4½
Height 2½

Weight
Cubic Ft.

- **Mini-Tap® Power/USB Center** is available as a factory-installed option on the kickrail of freestanding lounges
- **Mini-Tap® Power/USB Center** features include:
 - Tamper-resistant single AC power outlet with shutter mechanism that protects children from sticking foreign objects into the receptacle
 - USB A-C dual charging ports
 - Spill-proof
 - UL listed
- **Overall size** is 4½" wide x 2½" high. Overall cord length is 72"; 50" length exits the bottom of the lounge and is positioned towards the outside of the lounge
- **Available colors:**
 - Black—Gloss black mounting plate, black receptacle
 - Silver—Silver powdercoat mounting plate, white receptacle
 - White—Gloss white mounting plate, white receptacle

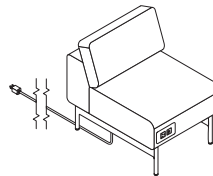

COM YARDAGE REQUIREMENTS

COM YARDAGE REQUIREMENTS (54" WIDTH – CUT UP THE ROLL)

| MODEL | RAILROADED Contact customer service 800-634-9510 for ydg requirements | NON DIRECTIONAL OR SOLID | 1"-4" REPEAT | 5"-11" REPEAT | 12"-18" REPEAT | COL SQUARE FEET |
|---|--|--------------------------------|-----------------------------------|-------------------------------------|-------------------------------------|-----------------------|
| | | | 4" VERTICAL X 4" HORIZONTAL | 11" VERTICAL X 11" HORIZONTAL | 18" VERTICAL X 18" HORIZONTAL | |
| K73FL1XA | Entire Unit | 2.30 | 3.90 | 5.10 | 5.60 | 46.5 |
| | Inner Back | 0.70 | 1.40 | 1.60 | 2.10 | 14.4 |
| | Outer Back | 1.00 | 1.80 | 2.60 | 3.00 | 19.9 |
| | Seat | 1.30 | 1.50 | 2.20 | 2.60 | 25.5 |
| K73FL2XA | Entire Unit | 4.10 | 7.70 | 9.20 | 9.60 | 80.3 |
| | Inner Back | 1.30 | 2.40 | 2.80 | 3.10 | 25.5 |
| | Outer Back | 1.50 | 2.50 | 3.00 | 3.00 | 29.3 |
| | Seat | 1.60 | 3.10 | 3.80 | 4.60 | 32.1 |
| K73FL3XA | Entire Unit | 5.80 | 11.50 | 13.50 | 13.60 | 115.2 |
| | Inner Back | 1.90 | 3.90 | 4.70 | 5.10 | 38.2 |
| | Outer Back | 2.10 | 3.90 | 4.70 | 5.00 | 41 |
| | Seat | 2.50 | 4.30 | 5.10 | 6.10 | 49.3 |
| K73FL1A, K73FL1ACW, K73FL1ACP, K73FL1ACS | Entire Unit | 4.10 | 6.00 | 8.00 | 8.00 | 80.8 |
| | Inner Back | 0.70 | 1.40 | 1.60 | 2.10 | 14.4 |
| | Outer Back | 1.00 | 1.50 | 1.70 | 1.90 | 19.9 |
| | Seat | 1.30 | 1.80 | 2.60 | 3.00 | 25.5 |
| | Arms | 1.90 | 2.70 | 3.90 | 4.70 | 37.1 |
| K73FL2A, K73FL2ACW, K73FL2ACP, K73FL2ACS | Entire Unit | 5.80 | 9.50 | 11.70 | 11.70 | 115.7 |
| | Inner Back | 1.30 | 2.40 | 2.80 | 3.10 | 25.5 |
| | Outer Back | 1.50 | 2.50 | 3.00 | 3.00 | 29.3 |
| | Seat | 1.60 | 3.10 | 3.80 | 4.60 | 32.1 |
| | Arms | 1.90 | 2.50 | 3.50 | 4.20 | 37.1 |
| K73FL3A, K73FL3ACW, K73FL3ACP, K73FL3ACS | Entire Unit | 7.50 | 13.30 | 16.00 | 16.00 | 150 |
| | Inner Back | 1.90 | 3.90 | 4.70 | 5.10 | 38.2 |
| | Outer Back | 2.10 | 3.90 | 4.70 | 5.00 | 41 |
| | Seat | 2.50 | 4.30 | 5.10 | 6.10 | 49.3 |
| | Arms | 1.90 | 2.50 | 3.50 | 4.20 | 37.1 |
| K73ECBE3212U | Entire Unit | 1.50 | 1.70 | 2.60 | 3.20 | 30.4 |