Embra

Product Specifications	184
Fabrics and Options	185
Contrasting Fabric	186
End Caps	187
Product Positioning	189
Product Pages	190
COM Yardage Requirements	200

EMBRA PRODUCT SPECIFICATIONS

CUSHIONS

- Cushions are made of high grade, high resiliency, CFC-free, laminated polyurethane foam

ARMS

- Arms are 4" thick
- Arm frames are constructed of ½" thick plywood
- Arm tops and outside panels feature ½" and ¾" thick high grade polyurethane foam
- Arms feature a sewn slipcover with French seams that is stapled into place

BACK, SEAT, AND ARMS

- Back, seat, and arms have decorative top-stitch detailing

END CAP TABLES, CORNER TABLES, AND TABLETS

- End cap tables, corner tables, and tablets consist of a HPL top surface, MDF core, and a 3D Laminate matte luxe bottom surface with low sheen
- Matte luxe provides a soft touch and feel
- All surfaces have rounded corners and sides

ARM CAPS

- Arm caps are available in wood, polyurethane, and solid surface
- EOS^{CU} (Cupron enhanced EOS) biocidal solid surface arm caps are optional on solid surface arm cap model; upcharge applies

TABLETS

- Tablets are handed and swing 90 degrees, allowing easy access
- Tablet mechanism attaches to the front of arm (field installed) and features a platinum metallic finish

SEATS

- Seats feature a high-tension, strip webbing suspension
- Seat upholstery features a wrap-around upholstery method and is stapled into place

LEG FRAMES

- Leg frames are casted aluminum side frame; powdercoated

RAILS

- Rails are rectangular tubular steel with 2mm wall thickness; powdercoat finish

POWER/USB CENTER

- Mini-Tap[®] power/USB center option features one AC power outlet and USB A+C dual charging ports
- Factory installed; upcharge applies

CLEAN OUT

- Clean out is standard on all models to make cleaning easy and simple
- Clean out space is slightly visible between back and seat cushions, but does not detract from the aesthetic or function of the lounge

GLIDES

- Non-skid, adjustable black glides are 1" in diameter with 1" adjustability

FRAME

- Frame is constructed of ¾" thick OSB, using a lap-joint construction method
- Frames are glued and screwed together

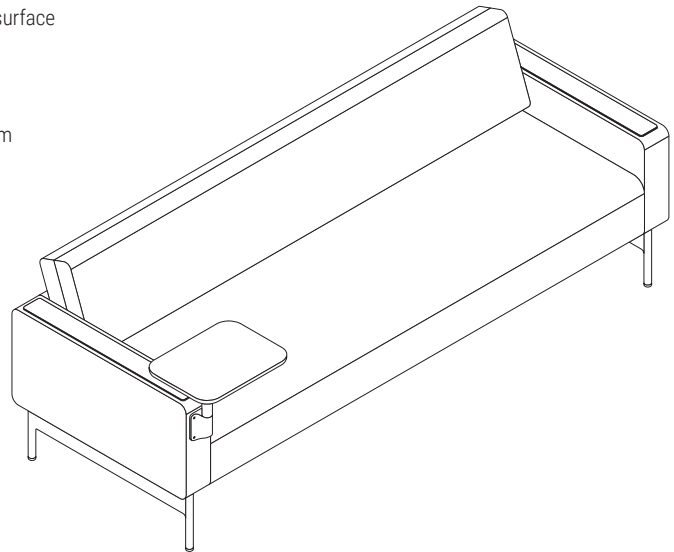
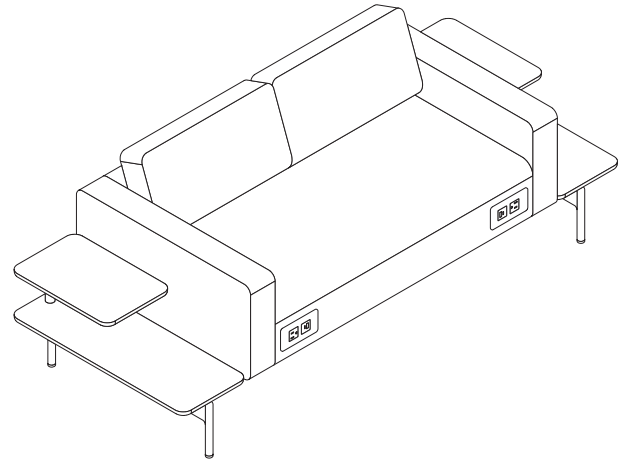

SURFACE MATERIALS

See the Kimball Hospitality Surface Materials Reference Guide at kimballhospitality.com for a complete overview of our materials program, including:

- Characteristics of wood
- Special wood finishes
- Customer-specified laminate (CSL)
- Customer-specified paint (CSP)
- Fabric application and colorways
- Customer's own material (COM) process overview
- Alliance program

ALLIANCE FABRIC PROGRAM

Kimball Hospitality has analyzed each model to most accurately reflect the COM/COL yardage requirements shown on page 200.

The yardage requirement for each model is based on 54" W fabric and cutting the fabric up the roll.

If repeat is larger than 18", contact Customer Service to confirm the correct amount of yardage required. When ordering 10 or more chairs in the same COM, yardage requirements may be reduced.

Contact Customer Service.

PRICE GRADES A-R

See Surface Materials at www.kimballhospitality.com for a wide variety of graded-in fabrics from Arc-Com, Carnegie, CF Stinson, Designtex, Maharam, Mayer, Momentum, and Ultrafabrics.

FABRIC SAMPLES

If you need samples for presentation(s), contact our alliance partners directly at:

Arc-Com	800.223.5466	arc-com.com
Carnegie	800.727.6770	carnegiefabrics.com
CF Stinson	800.841.6279	cfstinson.com
Designtex	800.221.1540	designtex.com
Maharam	800.645.3943	maharam.com
Mayer	800.428.4415	mayerfabrics.com
Momentum	800.366.6839	memosamples.com
Ultrafabrics	877.309.6648	ultrafabricsllc.com

END CAP TABLES AND STORAGE TABLES, CORNER TABLES AND TABLETS

3D LAMINATE

MATTE LUXE

- 462 Cinder
- 405 Cloud
- 405 Designer White

END CAP TOP SURFACES, TABLE TOP SURFACES, AND CORNER TABLE TOP SURFACES

HPL

WOODGRAIN

- BZ Brazilwood
- CO Canyon
- CI Chai
- DF Driftwood
- KN Kona
- YO Monterey
- PC Porcini
- PB Portobello
- 792 Sable
- NW Tuscan
- WL Willow

SOLID

- 462 Cinder
- 440 Cloud
- 405 Designer White

FREESTANDING END CAP LOCATION

- X None
- L Left as Seated
- R Right as Seated
- LR Left and Right as Seated

BASE LEGS/RAILS, COAT RACK POLE BOTTOM SECTION, AND LAMP POLE BOTTOM SECTION

PAINT

SOLID COLOR PAINT

- 462 Cinder
- 440 Cloud
- 405 Designer White

METALLIC PAINT

- 501 Platinum Metallic

LAMP SHADE

PAINT

SOLID COLOR PAINT

- BLK Matte black
- WHT Matte white

METALLIC PAINT

- SIL Silver

ARM CAPS

POLYURETHANE

- 495 Beige
- 462 Cinder
- 496 Grey

SOLID SURFACE

STANDARD

- 7101 Bisque
- 405 Designer White

PREMIUM*

- 467 Carbon Concrete
- 468 Neutral Concrete
- 464 Peace Grey
- 469 Weathered Concrete
- (1 Arm \$245 upcharge)
- (2 Arm \$490 upcharge)

EOS*

- 495 EOS^{CU} Beige
- 496 EOS^{CU} Grey
- (1 Arm \$431 upcharge)
- (2 Arm \$862 upcharge)

ARM CAPS, COAT RACK (UPPER SECTION), AND LAMP POLE (UPPER SECTION)

WOOD FINISH

PRICE GROUP 1

BZ	Brazilwood	MH	Mocha
CO	Canyon	YO	Monterey
CI	Chai	PC	Porcini
CC	Cordoba	PB	Portobello
DF	Driftwood	792	Sable
KN	Kona	NW	Tuscan
MW	Midtown	WL	Willow

IMPORTANT: Wood finishes applied to solid hardwood are complementary to the same wood finish applied to wood veneer, but not an exact match. Contact Customer Service for more information.

TABLET LOCATION

- L Left as Seated
- R Right as Seated
- LR Left and Right (\$1461 upcharge)

MOISTURE BARRIER

- X None
- MB1 Seat (\$154 upcharge)
- MB2 Seat and Inside Back (\$270 upcharge)

TO ORDER CONTRASTING FABRIC, SPECIFY

EMBRA

Chair, Loveseat, and Sofa Freestanding Lounge, Armless page 190

1. Model Number plus "X"
2. Inner Back Fabric Grade
3. Inner Back Fabric Number
4. Outer Back Fabric Grade
5. Outer Back Fabric Number
6. Seat Fabric Grade
7. Seat Fabric Number
8. Base Paint
9. Moisture Barrier Optional for Seat or Inside Back and Seat
10. Power/USB Option
11. End Cap Location

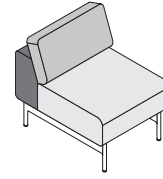

Contrasting Fabric may be specified on inside back, outside back, and seat

Chair and Loveseat Freestanding Lounge, Arms on Both Sides page 191 Sofa Freestanding Lounge, Arms on Both Sides page 192

1. Model Number plus "X"
2. Inner Back Fabric Grade
3. Inner Back Fabric Number
4. Outer Back Fabric Grade
5. Outer Back Fabric Number
6. Seat Fabric Grade
7. Seat Fabric Number
8. Arm Fabric Grade
9. Arm Fabric Number
10. Base Paint
11. Wood Finish Price Group
12. Arm Cap Designator (if applicable)
13. Moisture Barrier Optional for Seat or Inside Back and Seat
14. Power/USB Option
15. End Cap Location

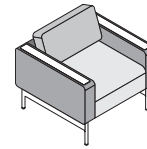

Contrasting Fabric may be specified on inside back, outside back, seat, and arms

END CAPS

End caps, specified separately for field installation, are available for one or both ends of freestanding lounges

End cap tables provide easy-to-access horizontal surfaces. They are available in several styles to accommodate the needs in community spaces and patient rooms. They feature rounded corners and sides for safety

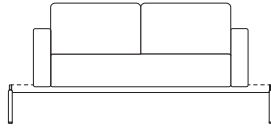

End caps are supported by the leg frame on the lounge or sofa model

IMPORTANT: The lounge model must be specified to accept an end cap

By selecting the desired end cap location/connection on freestanding lounge model, the rails and legs will be extended 6" to the left, right, or on both sides to accept and support an end cap

End caps can be added to the left, right or both sides of freestanding lounges with or without arms. Handing designation is determined from the user's perspective when seated



Single-Tier Table

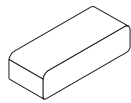

Upholstered Bench

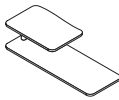

Tiered Table

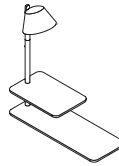

Tiered Table with Lamp

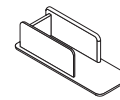

Storage Table

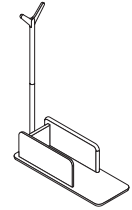

Storage Table with Coat Rack

SINGLE-TIER TABLE:

- Can be used in any configuration, but is best suited for use with armless models
- Table surface is 32" deep x 12" wide x 1³/₁₆" thick
- Height is 10¹³/₁₆" above the floor when attached to leg frame (seat height is 18¹/₁₆")
- HPL top surface; underside is 3D laminate matte luxe

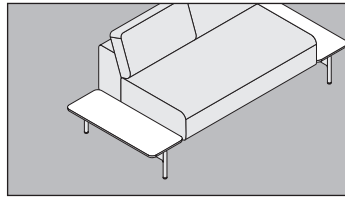

Single-Tier

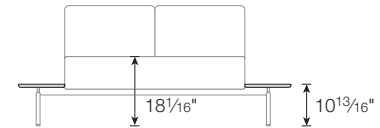

UPHOLSTERED BENCH:

- For use with armless lounge models; ideal for back-to-back applications
- Bench surface is 32" deep x 12" wide x 18¹/₁₆" (same height as lounge seat)

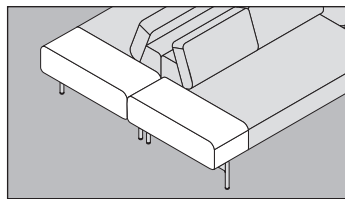

Upholstered Bench in Back-to-Back Application

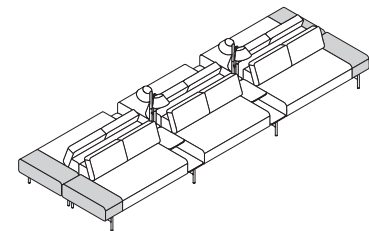

GANGING APPLICATIONS:



One ganging bracket is required when lounge and/or end caps are used back-to-back. See page 193

TO ORDER CONTRASTING FABRIC, SPECIFY

END CAPS (CONTINUED)

TIERED TABLES WITH OR WITHOUT LAMP:

- Can be used in any configuration, but is best suited for use with models with arms
- Lower tier surface is 32" deep x 12" wide x $\frac{1}{8}$ " thick; height is $10\frac{13}{16}$ " above the floor when attached to leg frame
- Top tier is 18" deep and sits above the bottom tier by $6\frac{3}{8}$ "
- HPL top surface; underside is 3D laminate matte luxe
- Lamp has 9" diameter aluminum spun lamp shade with powdercoat finish: Matte Black, Matte White, or Silver. Glossy white interior

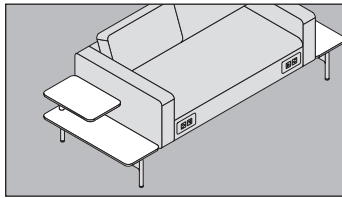

Tiered End Cap

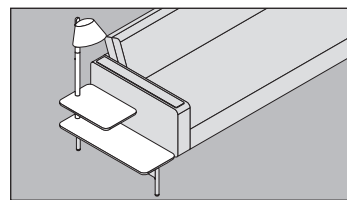
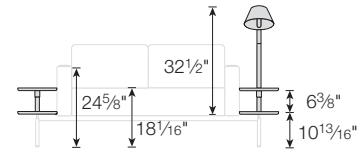

Tiered End Cap with Lamp
• Lamp height is well-suited for reading

STORAGE TABLES WITH OR WITHOUT COAT RACK:

- Can be used in any configuration
- Coat rack models are best suited for end-of-run applications
- Storage area ideal for storing linens, pillows, or personal items
- Interior storage area is $19\frac{1}{16}$ " deep x $8\frac{7}{16}$ " wide x $8\frac{1}{4}$ " high; height is $10\frac{13}{16}$ " above the floor when attached to leg frame
- Table surface is 32" deep x 12" wide x $\frac{1}{8}$ " thick; HPL top surface; underside is 3D laminate matte luxe
- Vertical sides of storage area are 3D laminate matte

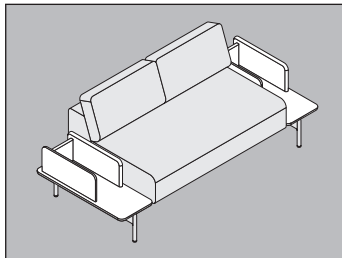

Storage End Cap

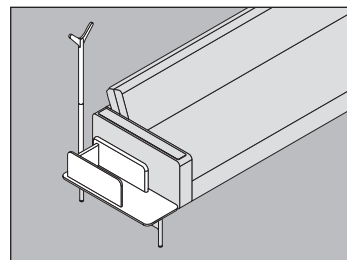
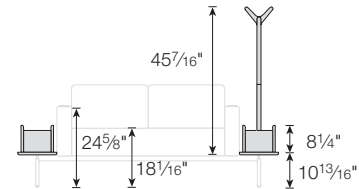

Storage End Cap with Coat Rack
• Keeps personal items out of the sleep area and off of the floor

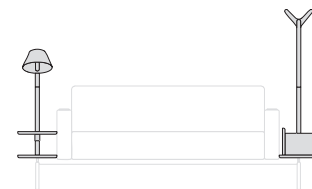

- Lamp and coat rack heights are different based on function

LAMP DETAILS:

- LED Light
- Touch switch on lamp shade interior
- Light output 320lm
- Light color: 2700K
- Power consumption: 4.5W
- Cord: white, 8 feet
- Input voltage: 100-240VAC, 50/60Hz
- UL listed
- Lamp pole is $1\frac{1}{4}$ " diameter; powdercoated lower section which connects to upper section with wood finish
- Lamp cord exits the upper wood section and re-enters the lower section to exit to the floor

PRODUCT POSITIONING

The Embra collection consists of freestanding lounge seating for community spaces, along with sleep sofas for patient spaces, to support a cohesive look throughout the facility. Intuitively designed with thoughtful details—including accessible power, storage for personal items, as well as surfaces and lighting—provide a sense of warmth and comfort

Additional features, including arm caps in multiple materials, clean out between the seat and back, and elevated metal legs, support cleanability and durability. Embra provides comfortable spaces for family interaction and quiet reflection with a homelike aesthetic

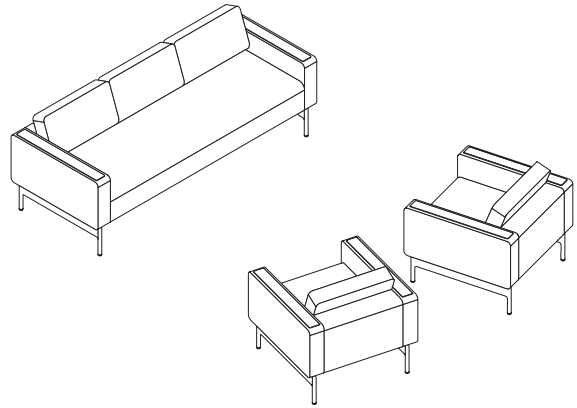

Freestanding Lounges

EMBRA

TO ORDER, SPECIFY:

1. Model Number
2. Inner Back Fabric Grade
3. Inner Back Fabric Number
4. Outer Back Fabric Grade
5. Outer Back Fabric Number
6. Seat Fabric Grade
7. Seat Fabric Number
8. Base Paint
9. Moisture Barrier Optional for Seat or Inside Back and Seat
10. Power/USB Option
11. End Cap Location

- See page 185 for Embra options
- See page 200 for COM fabric yardage

FREESTANDING LOUNGE ARMLESS CHAIR

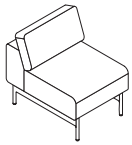

MODEL NO.

ALLIANCE PROGRAM PRICE GRADES

			A	B	C	D	E	F	G	H	I
			J	K	L	M	N	O	P	Q	R
K73FL1XA	Chair	\$	3637	3742	3824	3907	3997	4102	4162	4276	4372
			4471	4630	4945	5146	5191	5230	5278	5326	5548

DIMENSIONS

Width	24	Seat Height	18½	End Cap Support (if Selected)	Weight	79.9
Depth	32⅝	Seat Depth	20½	Width (Each)	Cubic Ft.	19.30
Height	31¼	Seat Width	24			

- Contrasting fabric option – specify X (i.e., K73FL1XA); see page 186. For list pricing, use your electronic specification tool or contact customer service
- Tight back
- Clean out (visible)
- Metal rails and legs
- Non-skid, adjustable glides

FREESTANDING LOUNGE ARMLESS LOVESEAT

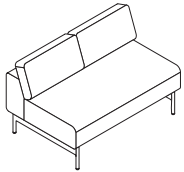

			A	B	C	D	E	F	G	H	I
			J	K	L	M	N	O	P	Q	R
K73FL2XA	Loveseat	\$	5069	5222	5342	5465	5597	5750	5838	6006	6146
			6292	6524	6987	7282	7348	7404	7475	7546	7871

DIMENSIONS

Width	48½	Seat Height	18½	End Cap Support (if Selected)	Weight	129.5
Depth	32⅝	Seat Depth	20½	Width (Each)	Cubic Ft.	30.50
Height	31¼	Seat Width	48½			

- Contrasting fabric option – specify X (i.e., K73FL2XAX); see page 186. For list pricing, use your electronic specification tool or contact customer service
- Tight back
- Clean out
- Metal rails and legs
- Non-skid, adjustable glides

FREESTANDING LOUNGE ARMLESS SOFA

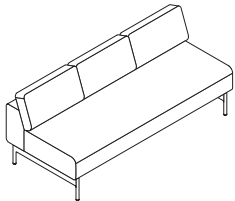

			A	B	C	D	E	F	G	H	I
			J	K	L	M	N	O	P	Q	R
K73FL3XA	Sofa	\$	6018	6245	6422	6603	6798	7025	7155	7402	7610
			7825	8169	8852	9287	9385	9469	9573	9677	10158

DIMENSIONS

Width	72½	Seat Height	18½	End Cap Support (if Selected)	Weight	179.2
Depth	32⅝	Seat Depth	20½	Width (Each)	Cubic Ft.	41.60
Height	31¼	Seat Width	72½			

- Contrasting fabric option – specify X (i.e., K73FL3XAX); see page 186. For list pricing, use your electronic specification tool or contact customer service
- Tight back
- Clean out
- Metal rails and legs
- Non-skid, adjustable glides

TO ORDER, SPECIFY:

1. Model Number
2. Inner Back Fabric Grade
3. Inner Back Fabric Number
4. Outer Back Fabric Grade
5. Outer Back Fabric Number
6. Seat Fabric Grade
7. Seat Fabric Number
8. Arm Fabric Grade
9. Arm Fabric Number
10. Base Paint
11. Wood Finish Price Group
12. Arm Cap Designator (if applicable)
13. Moisture Barrier Optional for Seat or Inside Back and Seat
14. Power/USB Option
15. End Cap Location

- See page 185 for Embra options
- See page 200 for COM fabric yardage

**FREESTANDING LOUNGE
ARMS ON BOTH SIDES
CHAIR**

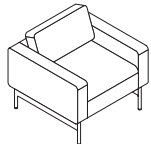

No Arm Caps

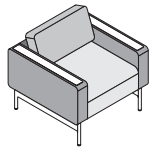

Arm Caps

**MODEL
NO.**

ALLIANCE PROGRAM PRICE GRADES

		A	B	C	D	E	F	G	H	I
		J	K	L	M	N	O	P	Q	R
K73FL1A	No Arm Caps	\$ 4467	4638	4772	4908	5055	5226	5324	5510	5667
		5829	6089	6603	6931	7005	7069	7147	7225	7588
K73FL1ACW	Wood Arm Caps	4573	4744	4878	5014	5161	5332	5430	5616	5773
		5935	6195	6709	7037	7111	7175	7253	7331	7694
K73FL1ACP	Polyurethane Arm Caps	4692	4863	4997	5133	5280	5451	5549	5735	5892
		6054	6314	6828	7156	7230	7294	7372	7450	7813
K73FL1ACS	Solid Surface Arm Caps	5290	5461	5595	5731	5878	6049	6147	6333	6490
		6652	6912	7426	7754	7828	7892	7970	8048	8411

DIMENSIONS

Width	32 ¹ / ₁₆	Seat Height	18 ¹ / ₁₆	Arm Height		End Cap Support (if Selected)	
Depth	32 ¹ / ₁₆	Seat Depth	20 ¹ / ₂	No Arm Caps	24%	Width (Each)	6
Height	31 ¹ / ₄	Seat Width	23 ¹ / ₁₆	Arm Caps	24 ¹³ / ₁₆	Weight	
				Arm Width	4%	Cubic Ft.	21.50

- Contrasting fabric option – specify X (i.e., K73FL1AX); see page 186. For list pricing, use your electronic specification tool or contact customer service
- Tight back
- Clean out
- Metal rails and legs
- Non-skid, adjustable glides
- Arm caps on applicable models

**FREESTANDING LOUNGE
ARMS ON BOTH SIDES
LOVESEAT**

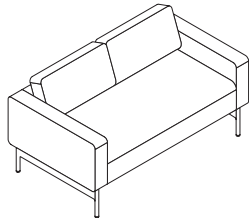

No Arm Caps

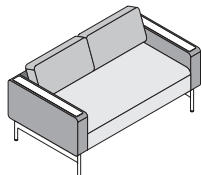

Arm Caps

**MODEL
NO.**

ALLIANCE PROGRAM PRICE GRADES

		A	B	C	D	E	F	G	H	I
		J	K	L	M	N	O	P	Q	R
K73FL2A	No Arm Caps	\$ 5898	6117	6289	6465	6654	6873	6999	7239	7440
		7649	7982	8644	9066	9161	9242	9343	9444	9910
K73FL2ACW	Wood Arm Caps	6004	6223	6395	6571	6760	6979	7105	7345	7546
		7755	8088	8750	9172	9267	9348	9449	9550	10016
K73FL2ACP	Polyurethane Arm Caps	6123	6342	6514	6690	6879	7098	7224	7464	7665
		7874	8207	8869	9291	9386	9467	9568	9669	10135
K73FL2ACS	Solid Surface Arm Caps	6721	6940	7112	7288	7477	7696	7822	8062	8263
		8472	8805	9467	9889	9984	10065	10166	10267	10733

DIMENSIONS

Width	56 ¹ / ₁₆	Seat Height	18 ¹ / ₁₆	Arm Height		End Cap Support (if Selected)	
Depth	32 ¹ / ₁₆	Seat Depth	20 ¹ / ₂	No Arm Caps	24%	Width (Each)	6
Height	31 ¹ / ₄	Seat Width	47 ¹ / ₁₆	Arm Caps	24 ¹³ / ₁₆	Weight	
				Arm Width	4%	Cubic Ft.	32.70

- Contrasting fabric option – specify X (i.e., K73FL2AX); see page 186. For list pricing, use your electronic specification tool or contact customer service
- Tight back
- Clean out
- Metal rails and legs
- Non-skid, adjustable glides
- Arm caps on applicable models

TO ORDER, SPECIFY:

1. Model Number
2. Inner Back Fabric Grade
3. Inner Back Fabric Number
4. Outer Back Fabric Grade
5. Outer Back Fabric Number
6. Seat Fabric Grade
7. Seat Fabric Number
8. Arm Fabric Grade
9. Arm Fabric Number
10. Base Paint
11. Wood Finish Price Group
12. Arm Cap Designator (if applicable)
13. Moisture Barrier Optional for Seat or Inside Back and Seat
14. Power/USB Option
15. End Cap Location

- See page 185 for Embra options
- See page 200 for COM fabric yardage

EMBRA

**FREESTANDING LOUNGE
ARMS ON BOTH SIDES
SOFA**

**MODEL
NO.**

ALLIANCE PROGRAM PRICE GRADES

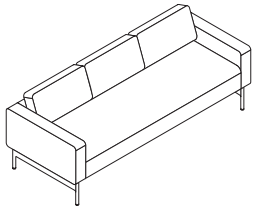

No Arm Caps

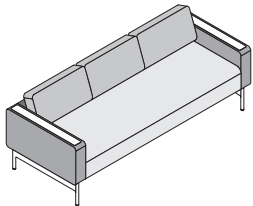

Arm Caps

			A	B	C	D	E	F	G	H	I
			J	K	L	M	N	O	P	Q	R
K73FL3A	No Arm Caps	\$	6848	7141	7370	7604	7856	8149	8317	8636	8905
			9183	9628	10510	11072	11199	11308	11442	11576	12198
K73FL3ACW	Wood Arm Caps		6954	7247	7476	7710	7962	8255	8423	8742	9011
			9289	9734	10616	11178	11305	11414	11548	11682	12304
K73FL3ACP	Polyurethane Arm Caps		7073	7366	7595	7829	8081	8374	8542	8861	9130
			9408	9853	10735	11297	11424	11533	11667	11801	12423
K73FL3ACS	Solid Surface Arm Caps		7672	7965	8194	8428	8680	8973	9141	9460	9729
			10007	10452	11334	11896	12023	12132	12266	12400	13022

DIMENSIONS

Width	80 ¹ / ₁₆	Seat Height	18 ¹ / ₁₆	Arm Height		End Cap Support (if Selected)	
Depth	32 ¹ / ₁₆	Seat Depth	20 ¹ / ₂	No Arm Caps	24 ¹ / ₁₆	Width (Each)	6
Height	31 ¹ / ₄	Seat Width	71 ¹ / ₁₆	Arm Caps	24 ¹³ / ₁₆	Weight	
				Arm Width	4 ¹ / ₁₆	Cubic Ft.	43.80

- Contrasting fabric option – specify X (i.e., K73FL3AX); see page 186. For list pricing, use your electronic specification tool or contact customer service
- Tight back
- Clean out
- Metal rails and legs
- Non-skid, adjustable glides
- Arm caps on applicable models

TO ORDER, SPECIFY:

• See page 185 for Embra options

1. Model Number

**MODULAR LOUNGE
GANGING BRACKET**



**MODEL
NO.**

LIST PRICE

K73LGB	Ganging Bracket	\$ 15
--------	-----------------	-------

DIMENSIONS

Width	2	Weight	0.2
Depth	5 $\frac{1}{2}$	Cubic Ft.	0.20
Height	$\frac{1}{6}$		

EMBRA

TO ORDER, SPECIFY:

1. Model Number
2. HPL Surface Designator
3. 3D Laminate Matte Luxe Color for Bottom of Surface

• See page 185 for Embra options

END CAPS SINGLE-TIER TABLE



MODEL NO.

LIST PRICE

K73ECT3212L	Single-Tier Table	\$	928
-------------	-------------------	----	-----

DIMENSIONS

Width	12
Depth	32
Height	$1\frac{3}{16}$

Weight	12.0
Cubic Ft.	.60

- HPL top surface with 3D laminate matte luxe underside
- Rounded corners and sides

TO ORDER, SPECIFY:

• See page 185 for Embra options

1. Model Number
2. HPL Surface Designator
3. 3D Laminate Matte Luxe Color for Bottom of Surface
4. Base Paint Designator

**END CAPS
TIERED TABLE**

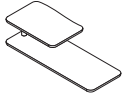

**MODEL
NO.**

LIST PRICE

K73ECTT3212L	Tiered Table	\$ 1936
--------------	--------------	---------

DIMENSIONS

Width	12
Depth	32
Height	8

Weight	22.3
Cubic Ft.	4.50

- HPL top surface with 3D laminate matte luxe underside
- Rounded corners and sides

EMBRA

TO ORDER, SPECIFY:

• See page 185 for Embra options

1. Model Number
2. HPL Surface Designator
3. 3D Laminate Matte Luxe Color for Bottom of Surface
4. Lamp Pole Lower Section Paint Designator
5. Lamp Pole Upper Section Finish Group
6. Lamp Pole Upper Section Finish Designator
7. Lamp Shade Color

END CAPS TIERED TABLE WITH LAMP

MODEL NO.

LIST PRICE

K73ECLTT3212L	Tiered Table with Lamp	\$ 2984
---------------	------------------------	---------

DIMENSIONS

Width	12	Weight	26.6
Depth	32	Cubic Ft.	13.20
Height	8		
Lamp Height	32½		

- HPL top surface with 3D laminate matte luxe underside
- Rounded corners and sides
- Lamp shade is 9" diameter and features LED light with touch switch, powdercoated paint finish; field installed

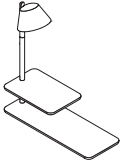

EMBRA

TO ORDER, SPECIFY:

• See page 185 for Embra options

1. Model Number
2. HPL Surface Designator
3. 3D Laminate Matte Luxe Color for Bottom of Surface
4. 3D Laminate Matte Luxe Color for Storage Vertical Surfaces
5. Coat Rack Lower Section Paint Designator
6. Coat Rack Upper Section Finish Group
7. Coat Rack Upper Section Finish Designator

**END CAPS
STORAGE TABLE WITH
COAT RACK**

**MODEL
NO.**

LIST PRICE

K73ECCRST3212L	Storage Table with Coat Rack	\$ 3523
----------------	------------------------------	---------

DIMENSIONS

Width	12	Weight	16.4
Depth	32	Cubic Ft.	8.90
Height	45 ⁷ / ₁₆		
Interior Width	8 ⁷ / ₁₆		

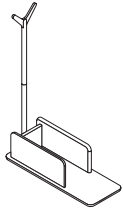

- HPL top surface with 3D laminate matte luxe underside and vertical panels
- Rounded corners and sides
- Coat rack on applicable model: wood with wood finish and metal powdercoat paint



EMBRA

TO ORDER, SPECIFY:

1. Model Number
2. Fabric Grade
3. Fabric Number
4. Moisture Barrier Optional for Seat

- See page 185 for Embra options
- See page 200 for COM fabric yardage

**END CAPS
UPHOLSTERED BENCH**

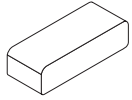

**MODEL
NO.**

ALLIANCE PROGRAM PRICE GRADES

			A	B	C	D	E	F	G	H	I
			J	K	L	M	N	O	P	Q	R
K73ECBE3212U	Upholstered Bench End Cap	\$	1205	1258	1300	1342	1388	1442	1472	1531	1580
			1630	1711	1872	1974	1997	2017	2042	2066	2179

DIMENSIONS

Width	12¼										
Depth	32								Weight		19.9
Height	8¼								Cubic Ft.		2.70

- Upholstered cushion

EMBRA

TO ORDER, SPECIFY:

• See page 185 for Embra options

1. Insert the Power Module Designator in Applicable Step in the Model Number Sequence

KICK RAIL POWER/USB

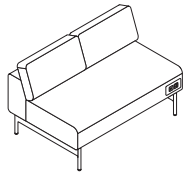

Left Front (as seated)

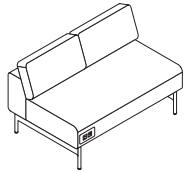

Right Front (as seated)

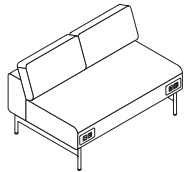

Left and Right Front (as seated)

MODEL NO.

LIST PRICE

MTBLKL	Mini-Tap, Black	\$ 605
MTSILL	Mini-Tap, Silver	605
MTWHTL	Mini-Tap, White	605

MTBLKR	Mini-Tap, Black	\$ 605
MTSILR	Mini-Tap, Silver	605
MTWHTR	Mini-Tap, White	605

MTBLKLR	Mini-Tap, Black	\$ 1210
MTSILLR	Mini-Tap, Silver	1210
MTWHTLR	Mini-Tap, White	1210

DIMENSIONS

Width 4½
Height 2½

Weight
Cubic Ft.

- **Mini-Tap® Power/USB Center** is available as a factory-installed option on the kickrail of freestanding lounges
- **Mini-Tap® Power/USB Center** features include:
 - One tamper-resistant single AC power outlet with shutter mechanism that protects children from sticking foreign objects into the receptacle
 - USB A-C dual charging ports (2 total)
 - Spill-proof
 - UL listed
- **Overall size** is 4½" wide x 2½" high. Overall cord length is 72"; 50" length exits the bottom of the lounge and is positioned towards the outside of the lounge
- **Available colors:**
 - Black—Gloss black mounting plate, black receptacle
 - Silver—Silver powdercoat mounting plate, white receptacle
 - White—Gloss white mounting plate, white receptacle

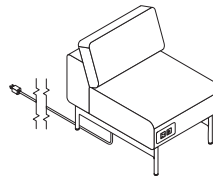

COM YARDAGE REQUIREMENTS

COM YARDAGE REQUIREMENTS (54" WIDTH – CUT UP THE ROLL)

MODEL	RAILROADED Contact customer service 800-634-9510 for ydg requirements	NON DIRECTIONAL OR SOLID	1"-4" REPEAT	5"-11" REPEAT	12"-18" REPEAT	COL SQUARE FEET
			4" VERTICAL X 4" HORIZONTAL	11" VERTICAL X 11" HORIZONTAL	18" VERTICAL X 18" HORIZONTAL	
K73FL1XA	Entire Unit	2.30	3.90	5.10	5.60	46.5
	Inner Back	0.70	1.40	1.60	2.10	14.4
	Outer Back	1.00	1.80	2.60	3.00	19.9
	Seat	1.30	1.50	2.20	2.60	25.5
K73FL2XA	Entire Unit	4.10	7.70	9.20	9.60	80.3
	Inner Back	1.30	2.40	2.80	3.10	25.5
	Outer Back	1.50	2.50	3.00	3.00	29.3
	Seat	1.60	3.10	3.80	4.60	32.1
K73FL3XA	Entire Unit	5.80	11.50	13.50	13.60	115.2
	Inner Back	1.90	3.90	4.70	5.10	38.2
	Outer Back	2.10	3.90	4.70	5.00	41
	Seat	2.50	4.30	5.10	6.10	49.3
K73FL1A, K73FL1ACW, K73FL1ACP, K73FL1ACS	Entire Unit	4.10	6.00	8.00	8.00	80.8
	Inner Back	0.70	1.40	1.60	2.10	14.4
	Outer Back	1.00	1.50	1.70	1.90	19.9
	Seat	1.30	1.80	2.60	3.00	25.5
	Arms	1.90	2.70	3.90	4.70	37.1
K73FL2A, K73FL2ACW, K73FL2ACP, K73FL2ACS	Entire Unit	5.80	9.50	11.70	11.70	115.7
	Inner Back	1.30	2.40	2.80	3.10	25.5
	Outer Back	1.50	2.50	3.00	3.00	29.3
	Seat	1.60	3.10	3.80	4.60	32.1
	Arms	1.90	2.50	3.50	4.20	37.1
K73FL3A, K73FL3ACW, K73FL3ACP, K73FL3ACS	Entire Unit	7.50	13.30	16.00	16.00	150
	Inner Back	1.90	3.90	4.70	5.10	38.2
	Outer Back	2.10	3.90	4.70	5.00	41
	Seat	2.50	4.30	5.10	6.10	49.3
	Arms	1.90	2.50	3.50	4.20	37.1
K73ECBE3212U	Entire Unit	1.50	1.70	2.60	3.20	30.4

EMBRA