Boyd

Product Specifications	70
Fabrics and Options	71
Contrasting Fabrics Specifications	72
Product Pages	73
COM Yardage Requirements	74

BOYD

BOYD PRODUCT SPECIFICATIONS

FRAME CONSTRUCTION

- Frame is constructed of plywood, utilizing lap joint construction that is glued and screwed

SEAT CONSTRUCTION

- Seat is designed for comfort, giving you a residential feel. Wrinkles in the seat cushion are adherent to the design and should be expected
- Attached seat cushion is 6" thick and made of high grade, high resiliency, CFC-free, laminated polyurethane

BACK CONSTRUCTION

- Back cushions consist of high density, high resiliency foam over a non-stretch woven suspension that is stapled to the frame
- Back cushion contains 4¾" thick high density, high resiliency, CFC-free, laminated polyurethane foam. Select standard cushion or sewn-tufted cushion

ARMS

- Arms feature a sewn slipcover over top ½" thick, high grade polyurethane foam

LEGS

- Leg and rail joints are double doweled, securely glued, and reinforced with corner blocks that are then glued and screwed to the base rails. The base frame is attached to the seat frame with wood screws through the rails
- 6" high legs are powder-coated steel and available in three styles: square, round or Y

GLIDES

- Non-skid, adjustable glides are 2" in diameter

CONTRASTING FABRICS

- Contrasting fabric may be specified on the outer frame, back cushion and seat cushion. If different price grades are selected, use our electronic specification tool for accurate pricing

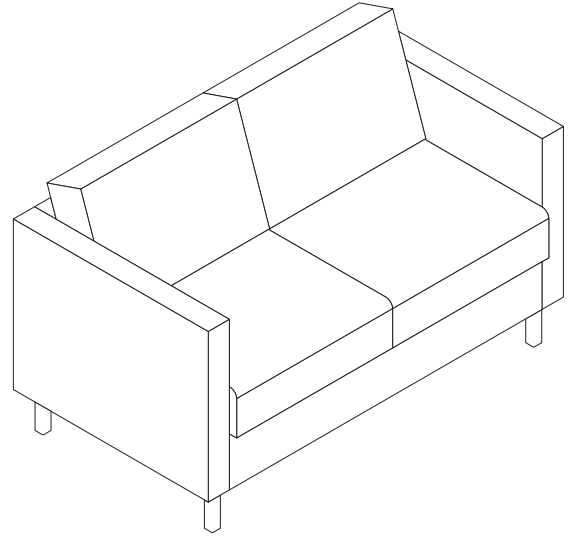

SURFACE MATERIALS

See the Kimball Hospitality Surface Materials Reference Guide at kimballhospitality.com for a complete overview of our materials program, including:

- Characteristics of wood
- Special wood finishes
- Customer specified laminate (CSL)
- Customer specified paint (CSP)
- Fabric application and colorways
- Customer's own material (COM) process overview
- Alliance program

ALLIANCE FABRIC PROGRAM

Kimball Hospitality has analyzed each model to most accurately reflect the COM/COL yardage requirements shown on page 74.

The yardage requirement for each model is based on 54" wide fabric and cutting the fabric up the roll.

If repeat is larger than 18", contact Customer Service to confirm the correct amount of yardage required. When ordering 10 or more chairs in the same COM, yardage requirements may be reduced.

Contact Customer Service.

PRICE GRADES A-R

See Surface Materials at www.kimballhospitality.com for a wide variety of graded-in fabrics from Arc-Com, Carnegie, CF Stinson, Designtex, Maharam, Mayer, Momentum, and Ultrafabrics.

FABRIC SAMPLES

If you need samples for presentation(s), contact our alliance partners directly at:

Arc-Com	800.223.5466	arc-com.com
Carnegie	800.727.6770	carnegiefabrics.com
CF Stinson	800.841.6279	cfstinson.com
Designtex	800.221.1540	designtex.com
Maharam	800.645.3943	maharam.com
Mayer	800.428.4415	mayerfabrics.com
Momentum	800.366.6839	memosamples.com
Ultrafabrics	877.309.6648	ultrafabricsllc.com

LEG OPTIONS

SQUARE METAL LEG

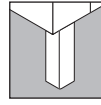

S

FINISHES

- 405 Designer White
- 462 Cinder
- 501 Platinum Metallic

ROUND METAL LEG

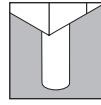

R

FINISHES

- 405 Designer White
- 462 Cinder
- 501 Platinum Metallic

Y METAL LEG

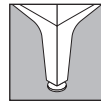

Y

FINISHES

- 462 Cinder
- 497 Polished Aluminum
- 501 Platinum Metallic

TO ORDER CONTRASTING FABRIC, SPECIFY

BOYD

One Seat Lounge page 73

Two Seat Lounge page 73

Three Seat Lounge page 73

1. Model Number plus "X"
2. Frame Upholstery Grade
3. Frame Upholstery Number
4. Back Upholstery Grade
5. Back Upholstery Number
6. Seat Upholstery Grade
7. Seat Upholstery Number
8. Specify Leg Option and Finish together in one step

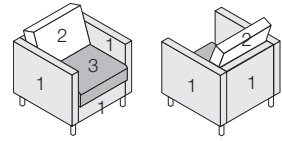

Contrasting fabric may be specified on the outer frame (1), back cushion (2), and seat cushion (3)

TO ORDER, SPECIFY:

1. Model Number
2. Frame Upholstery Grade
3. Frame Upholstery Number
4. Back Upholstery Grade
5. Back Upholstery Number
6. Seat Upholstery Grade
7. Seat Upholstery Number
8. Specify Leg Option and Finish together in one step

- See page 71 for Boyd options
- See page 74 for COM fabric yardage

ONE SEAT LOUNGE

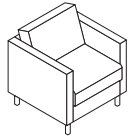

Standard Back Cushion

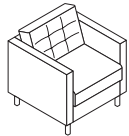

Sewn Tufted Back Cushion

MODEL NO.

ALLIANCE PROGRAM PRICE GRADES

			A	B	C	D	E	F	G	H	I
			J	K	L	M	N	O	P	Q	R
K741A	Standard Back Cushion	\$	2414	2597	2739	2882	3037	3218	3322	3520	3685
			3856	4130	4677	5025	5099	5167	5253	5333	5716
K741AT	Sewn Tufted Back Cushion		2719	2902	3044	3187	3342	3523	3627	3825	3990
			4161	4435	4982	5330	5404	5472	5558	5638	6021

DIMENSIONS

Width	28½	Seat Height	19	Arm Height	26½	Weight	
Depth	30	Seat Depth	19			Cubic Ft.	
Height	32	Seat Width	22½				

- Contrasting fabric option – specify X (i.e., K741AX); see page 72. For list pricing, use your electronic specification tool or contact customer service
- When specifying a striped or directional textile, a solid pattern is recommended for the back cushion due to alignment constraints

TWO SEAT LOUNGE

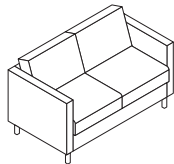

Standard Back Cushion

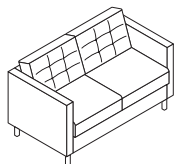

Sewn Tufted Back Cushion

			A	B	C	D	E	F	G	H	I
			J	K	L	M	N	O	P	Q	R
K742A	Standard Back Cushion	\$	3336	3560	3736	3910	4100	4324	4450	4694	4898
			5108	5444	6116	6542	6634	6718	6822	6920	7390
K742AT	Sewn Tufted Back Cushion		3944	4168	4344	4518	4708	4932	5058	5302	5506
			5716	6052	6724	7150	7242	7326	7430	7528	7998

DIMENSIONS

Width	51	Seat Height	19	Arm Height	26½	Weight	
Depth	30	Seat Depth	19			Cubic Ft.	
Height	32	Seat Width	45				

- Contrasting fabric option – specify X (i.e., K742AX); see page 72. For list pricing, use your electronic specification tool or contact customer service
- When specifying a striped or directional textile, a solid pattern is recommended for the back cushion due to alignment constraints

THREE SEAT LOUNGE

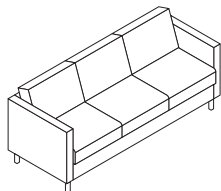

Standard Back Cushion

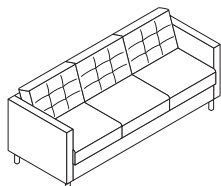

Sewn Tufted Back Cushion

			A	B	C	D	E	F	G	H	I
			J	K	L	M	N	O	P	Q	R
K743A	Standard Back Cushion	\$	4709	5008	5244	5478	5734	6034	6204	6532	6805
			7087	7538	8440	9013	9136	9249	9389	9520	10152
K743AT	Sewn Tufted Back Cushion		5473	5772	6008	6242	6498	6798	6968	7296	7569
			7851	8302	9204	9777	9900	10013	10153	10284	10916

DIMENSIONS

Width	73½	Seat Height	19	Arm Height	26½	Weight	
Depth	30	Seat Depth	19			Cubic Ft.	
Height	32	Seat Width	67½				

- Contrasting fabric option – specify X (i.e., K743AX); see page 72. For list pricing, use your electronic specification tool or contact customer service
- When specifying a striped or directional textile, a solid pattern is recommended for the back cushion due to alignment constraints

COM YARDAGE REQUIREMENTS

COM YARDAGE REQUIREMENTS (54" WIDTH – CUT UP THE ROLL)

MODEL	RAILROADED Contact customer service 800-634-9510 for ydg requirements	NON DIRECTIONAL OR SOLID	1"-4" REPEAT	5"-11" REPEAT	12"-18" REPEAT	COL SQUARE FEET
			4" VERTICAL X 4" HORIZONTAL	11" VERTICAL X 11" HORIZONTAL	18" VERTICAL X 18" HORIZONTAL	
K741A	Entire Unit	4.10	5.80	7.50	7.40	82
	Back	0.90	1.00	1.70	2.20	18
	Seat	1.10	1.20	1.50	1.80	22
	Frame	3.70	4.30	5.00	5.00	74
K741AT	Entire Unit	4.50	6.20	7.50	7.80	90
	Back	0.90	1.40	1.70	2.20	18
	Seat	1.10	1.20	1.50	1.80	22
	Frame	3.70	4.30	5.00	5.00	74
K742A	Entire Unit	6.00	8.90	11.10	12.20	119.5
	Back	1.50	1.80	3.30	4.20	30
	Seat	1.50	2.20	3.00	3.80	30
	Frame	4.00	5.40	6.30	6.00	80
K742AT	Entire Unit	6.10	9.40	11.10	12.20	121.5
	Back	1.50	2.40	3.30	4.20	30
	Seat	1.50	2.20	3.00	3.80	30
	Frame	4.00	5.40	6.30	6.00	80
K743A	Entire Unit	7.80	11.40	15.20	17.20	155.5
	Back	2.30	2.80	4.80	6.20	46
	Seat	2.30	3.20	4.60	5.80	46
	Frame	4.80	6.60	7.50	7.00	96
K743AT	Entire Unit	8.20	12.70	15.20	17.20	163.5
	Back	2.30	3.80	4.80	6.20	46
	Seat	2.30	3.20	4.60	5.80	46
	Frame	4.80	6.60	7.50	7.00	96

BOYD