Whittaker Health

Product Specifications	740
Fabrics and Options	741
Contrasting Fabrics Specifications	742
Product Pages	743
COM Yardage Requirements	775



WHITTAKER HEALTH PRODUCT SPECIFICATIONS

FRAME CONSTRUCTION

- Lounge frame is constructed of 5/8" thick OSB, using a lap-joint construction method
- Frames are glued and screwed together
- Moisture barrier is optional for seat, or seat and inside back. Upcharge applies

HANDING DESIGNATION

- Handing designation (left or right of unit) is determined from the user's perspective when seated
- Unit shown is a left corner with convenience arm right

SEAT CONSTRUCTION

- Seats feature a high tension, strip webbing suspension that is stapled to the frame
- Seat upholstery features a wrap-around upholstery method and is stapled into place
- Clean out is standard to make cleaning easy and simple
- Cushions are made of high grade, high resiliency, CFC-free, laminated polyurethane foam
- Seat cushions are 3 1/4" thick. Back cushions are 4 1/2"

CONTRASTING FABRIC

- Contrasting fabric may be specified for inner back, outer back, seat, arm, and front panel/accent

ARM CAPS

- Arm caps are available as an option on convenience arms (upcharge applies)
- Available in polyurethane, 3D laminate, solid surface, or wood

ARMS

- Arms are available in convenience and full heights
- Arm frames are constructed of 1/2" thick plywood
- Arm tops and outside panels feature 1/4" thick, high grade polyurethane foam
- Arms feature a sewn slipcover with French seams that is stapled into place

LEGS

- Legs are 2mm tubular metal and available in several finishes

RAILS

- Side rails are 8mm bar stock
- Front and back rails are 6mm bar stock

POWER/USB MODULE

- Power/USB module is available and can be attached anywhere underneath the unit
- Specified separately for field installation
- Includes a 6' cord with three-prong plug, one power receptacle and two USB ports

GLIDES

- Non-skid, adjustable glides are 3/4" in diameter

GANGING BRACKETS

- Two ganging brackets (K82PGB) are required to join two units together
- Lounge models have pre-drilled holes in the base to accept the ganging bracket and small mating piece
- Once brackets are installed, units slide together for a secure connection
- To disconnect, lift up and pull outward on the unit with the smaller, mating pieces
- Assembly instructions available at: kimballhospitality.com

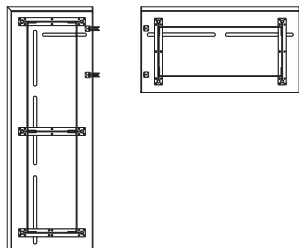
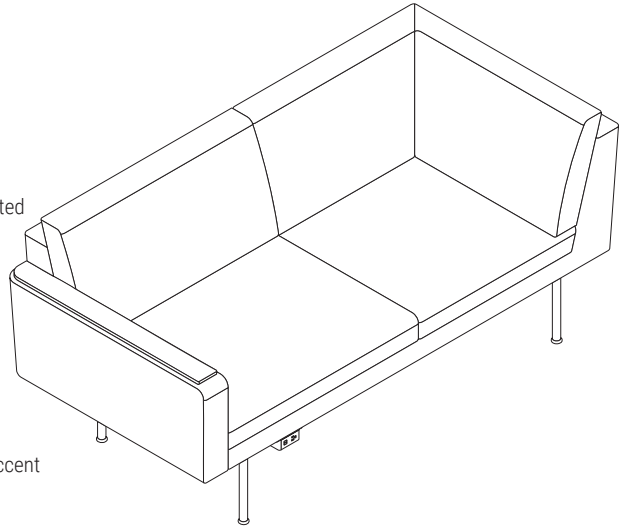

IMPORTANT: Applying upholsteries with horizontal or vertical patterns and stripes on corner units and the backs of units that will be used in a ganging application is discouraged

IMPORTANT: Fabrics reflect light differently when viewed at various angles, creating a natural phenomenon called "flip." Flip is visible on all fabrics and is not considered a defect; it is more easily recognized on fabrics with a nap or shimmer and more apparent on crescent or corner units

SURFACE MATERIALS

See the Kimball Hospitality Surface Materials Reference Guide at kimballhospitality.com for a complete overview of our materials program, including:

- Characteristics of wood
- Special wood finishes
- Customer specified laminate (CSL)
- Customer specified paint (CSP)
- Fabric application and colorways
- Customer's own material (COM) process overview
- Alliance program

ALLIANCE FABRIC PROGRAM

Kimball Hospitality has analyzed each model to most accurately reflect the COM/COL yardage requirements shown on page 775.

The yardage requirement for each model is based on 54" wide fabric and cutting the fabric up the roll.

If repeat is larger than 18", contact Customer Service to confirm the correct amount of yardage required. When ordering 10 or more chairs in the same COM, yardage requirements may be reduced.

Contact Customer Service.

PRICE GRADES A-R

See Surface Materials at www.kimballhospitality.com for a wide variety of graded-in fabrics from Arc-Com, CF Stinson, Designtex, Maharam, Momentum, and Ultrafabrics.

FABRIC SAMPLES

If you need samples for presentation(s), contact our alliance partners directly at:

Arc-Com	800.223.5466	arc-com.com
Designtex	800.221.1540	designtex.com
CF Stinson	800.841.6279	cfstinson.com
Maharam	800.645.3943	maharam.com
Momentum	800.366.6839	memosamples.com
Ultrafabrics	877.309.6648	ultrafabricsllc.com

LEGS

PAINT

462	Cinder
405	Designer White

NON-PAINT*

490	Chrome
552	Gold
553	Rose Gold

*\$218 upcharge

MOISTURE BARRIER

X	No Moisture Barrier
MB1	Seat (\$122 upcharge)
MB2	Seat and Inside Back (\$213 upcharge)

ARM CAPS

WOOD FINISHES

PRICE GROUP 1

MC	Amber Cherry
CC	Cordoba Cherry
MH	Mocha Cherry
SC	Sedona Cherry
IM	Brighton Maple
TM	Huntington Maple
ES	Espresso Walnut
MW	Midtown Walnut
TW	Tribeca Walnut
UW	Urban Walnut

AD	Almond Straight Grain
CO	Canyon Straight Grain
DF	Driftwood Straight Grain
YO	Monterey Straight Grain
PB	Portobello Straight Grain
792	Sable Straight Grain
NW	Tuscan Straight Grain

IMPORTANT: Wood finishes applied to solid hardwood are complementary to the same wood finish applied to wood veneer, but not an exact match. Contact Customer Service for more information.

POLYURETHANE

SOLID

495	Beige
462	Cinder
495	Grey

3D LAMINATE

WOODGRAIN

MC	Amber Cherry
MH	Mocha Cherry
CO	Canyon Straight Grain
DF	Driftwood Straight Grain
YO	Monterey Straight Grain
NW	Tuscan Straight Grain

SOLID SURFACE

STANDARD

405	Designer White
-----	----------------

PREMIUM*

495	EOS ^{CU} Beige
496	EOS ^{CU} Grey

*\$1048 upcharge

EOS^{CU} (Cupron enhanced EOS) is a Preventive/Biocidal Surface.™ A copper-oxide infused solid surface material, EOS^{CU} kills >99.9% of harmful bacteria** within two hours of exposure. (EPA registration #84542-7)

**Testing demonstrates effective antibacterial activity against *Staphylococcus aureus*, *Enterobacter aerogenes*, *Methicillin-Resistant Staphylococcus aureus*, *Escherichia coli*, and *Pseudomonas aeruginosa*

TO ORDER CONTRASTING FABRIC, SPECIFY

WHITTAKER HEALTH

One Seat, Two Seat, and Three Seat Armless Lounge Seating page 743

1. Model Number plus "X"
2. Inner Back Upholstery Grade
3. Inner Back Upholstery Number
4. Outer Back Upholstery Grade
5. Outer Back Upholstery Number
6. Seat Upholstery Grade
7. Seat Upholstery Number
8. Front Panel/Accent Upholstery Grade
9. Front Panel/Accent Upholstery Number
10. Leg Metal Finish Designator
11. Moisture Barrier Optional for Seat, or Seat and Inside Back

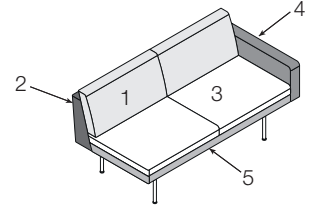

Contrasting fabric may be specified for inner back, outer back, seat, arm, and front panel/accent

One Seat and Two Seat Convenience Arm on Left Lounge page 744

Three Seat Convenience Arm on Left Lounge page 745

One Seat and Two Seat Convenience Arm on Right Lounge page 746

Three Seat Convenience Arm on Right Lounge page 747

One Seat and Two Seat Convenience Arm on Both Sides Lounge page 748

Three Seat Convenience Arm on Both Sides Lounge page 749

1. Model Number plus "X"
2. Inner Back Upholstery Grade
3. Inner Back Upholstery Number
4. Outer Back Upholstery Grade
5. Outer Back Upholstery Number
6. Seat Upholstery Grade
7. Seat Upholstery Number
8. Arm Upholstery Grade
9. Arm Upholstery Number
10. Front Panel/Accent Upholstery Grade
11. Front Panel/Accent Upholstery Number
12. Leg Metal Finish Designator
13. Arm Cap Finish or Color Designator (if applicable)
14. Moisture Barrier Optional for Seat, or Seat and Inside Back

One Seat and Two Seat Full Arm(s) Lounge page 750

Three Seat Full Arm(s) Lounge page 751

Two and Three Seat Interior Arms, No Side Arms Lounge page 752

1. Model Number plus "X"
2. Inner Back Upholstery Grade
3. Inner Back Upholstery Number
4. Outer Back Upholstery Grade
5. Outer Back Upholstery Number
6. Seat Upholstery Grade
7. Seat Upholstery Number
8. Arm Upholstery Grade
9. Arm Upholstery Number
10. Front Panel/Accent Upholstery Grade
11. Front Panel/Accent Upholstery Number
12. Leg Metal Finish Designator
13. Moisture Barrier Optional for Seat, or Seat and Inside Back

Two Seat Interior Arm in Center, Convenience Arm on Left Lounge page 753

Two Seat Interior Arm in Center, Convenience Arm on Right Lounge page 753

Two Seat Interior Arm in Center, Convenience Arm on Both Sides Lounge page 754

1. Model Number plus "X"
2. Inner Back Upholstery Grade
3. Inner Back Upholstery Number
4. Outer Back Upholstery Grade
5. Outer Back Upholstery Number
6. Seat Upholstery Grade
7. Seat Upholstery Number
8. Arm Upholstery Grade
9. Arm Upholstery Number
10. Front Panel/Accent Upholstery Grade
11. Front Panel/Accent Upholstery Number
12. Leg Metal Finish Designator
13. Arm Cap Finish or Color Designator (if applicable)
14. Moisture Barrier Optional for Seat, or Seat and Inside Back

TO ORDER, SPECIFY:

1. Model Number
2. Inner Back Upholstery Grade
3. Inner Back Upholstery Number
4. Outer Back Upholstery Grade
5. Outer Back Upholstery Number
6. Seat Upholstery Grade
7. Seat Upholstery Number
8. Front Panel/Accent Upholstery Grade
9. Front Panel/Accent Upholstery Number
10. Leg Metal Finish Designator
11. Moisture Barrier Optional for Seat, or Seat and Inside Back

- See page 741 for Whittaker Health options
- See pages 775-780 for COM fabric yardage

ARMLESS LOUNGE

MODEL NO.

ALLIANCE PROGRAM PRICE GRADES

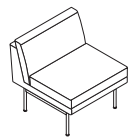

One Seat

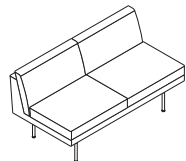

Two Seat

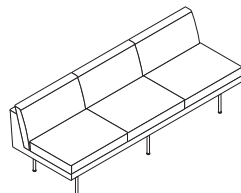

Three Seat

		A	B	C	D	E	F	G	H	I
		J	K	L	M	N	O	P	Q	R
K89L1XATB	One Seat	\$ 2345	2455	2541	2627	2717	2827	2889	3007	3105
		3208	3371	3702	3909	3953	3992	4042	4094	4320
K89L2XATB	Two Seat	3654	3830	3967	4106	4249	4426	4526	4715	4872
		5035	5299	5826	6158	6228	6291	6372	6454	6819
K89L3XATB	Three Seat	5019	5275	5477	5679	5890	6147	6293	6568	6798
		7037	7421	8192	8678	8778	8871	8989	9109	9640

DIMENSIONS - ONE SEAT

Width	31¼	Seat Height	18½	Weight	75
Depth	29¾	Seat Depth	20½	Cubic Ft.	11.00
Height	29⅜	Seat Width	27¾		

DIMENSIONS - TWO SEAT

Width	55½	Seat Height	18½	Weight	125
Depth	29¾	Seat Depth	20½	Cubic Ft.	36.00
Height	29⅜	Seat Width	55½		

DIMENSIONS - THREE SEAT

Width	82½	Seat Height	18½	Weight	199
Depth	29¾	Seat Depth	20½	Cubic Ft.	53.00
Height	29⅜	Seat Width	82½		

- Contrasting fabric option – specify X (i.e., K89L3XATBX); see page 742. For list pricing, use your electronic specification tool or contact customer service
- Weight Limit 253 lbs.
- Tight-back
- Clean out
- 2mm tubular metal legs
- Non-skid, adjustable glides

WHITTAKER HEALTH

TO ORDER, SPECIFY:

1. Model Number
2. Inner Back Upholstery Grade
3. Inner Back Upholstery Number
4. Outer Back Upholstery Grade
5. Outer Back Upholstery Number
6. Seat Upholstery Grade
7. Seat Upholstery Number
8. Arm Upholstery Grade
9. Arm Upholstery Number
10. Front Panel/Accent Upholstery Grade
11. Front Panel/Accent Upholstery Number
12. Leg Metal Finish Designator
13. Arm Cap Finish or Color Designator (if applicable)
14. Moisture Barrier Optional for Seat, or Seat and Inside Back

- See page 741 for Whittaker Health options
- See pages 775-780 for COM fabric yardage

ONE SEAT CONVENIENCE ARM ON LEFT LOUNGE

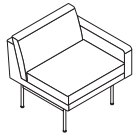

No Arm Cap

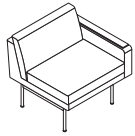

Arm Cap

MODEL NO.

ALLIANCE PROGRAM PRICE GRADES

			A	B	C	D	E	F	G	H	I
			J	K	L	M	N	O	P	Q	R
K89L1CVALUTB	No Arm Cap	\$	2817	2967	3084	3201	3324	3474	3558	3719	3852
			3992	4215	4665	4948	5007	5060	5129	5199	5508
K89L1CVALACWTB	Wood Arm Cap		2859	3009	3126	3243	3366	3516	3600	3761	3894
			4034	4257	4707	4990	5049	5102	5171	5241	5550
K89L1CVALACPTB	Polyurethane Arm Cap		2884	3034	3151	3268	3391	3541	3625	3786	3919
			4059	4282	4732	5015	5074	5127	5196	5266	5575
K89L1CVALACTTB	3D Laminate Arm Cap		2985	3135	3252	3369	3492	3642	3726	3887	4020
			4160	4383	4833	5116	5175	5228	5297	5367	5676
K89L1CVALACSTB	Solid Surface Arm Cap		3159	3309	3426	3543	3666	3816	3900	4061	4194
			4334	4557	5007	5290	5349	5402	5471	5541	5850

DIMENSIONS

Width	31¼	Seat Height	18½	Arm Height		Weight	86
Depth	29¾	Seat Depth	20½	No Arm Cap	22½	Cubic Ft.	21.00
Height	29⅜	Seat Width	27¾	Arm Cap	22⅞		
				Arm Width	3½		

- Contrasting fabric option – specify X (i.e., K89L1CVALUTBX); see page 742. For list pricing, use your electronic specification tool or contact customer service
- Weight Limit 253 lbs.
- Tight-back
- Clean out
- 2mm tubular metal legs
- Non-skid, adjustable glides
- Arm cap on applicable models

TWO SEAT CONVENIENCE ARM ON LEFT LOUNGE

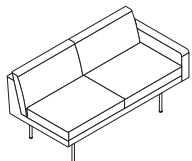

No Arm Cap

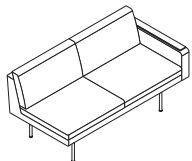

Arm Cap

			A	B	C	D	E	F	G	H	I
			J	K	L	M	N	O	P	Q	R
K89L2CVALUTB	No Arm Cap	\$	4100	4312	4477	4644	4817	5029	5150	5377	5566
			5763	6080	6715	7115	7199	7275	7372	7471	7910
K89L2CVALACWTB	Wood Arm Cap		4144	4356	4521	4688	4861	5073	5194	5421	5610
			5807	6124	6759	7159	7243	7319	7416	7515	7954
K89L2CVALACPTB	Polyurethane Arm Cap		4170	4382	4547	4714	4887	5099	5220	5447	5636
			5833	6150	6785	7185	7269	7345	7442	7541	7980
K89L2CVALACTTB	3D Laminate Arm Cap		4271	4483	4648	4815	4988	5200	5321	5548	5737
			5934	6251	6886	7286	7370	7446	7543	7642	8081
K89L2CVALACSTB	Solid Surface Arm Cap		4449	4661	4826	4993	5166	5378	5499	5726	5915
			6112	6429	7064	7464	7548	7624	7721	7820	8259

DIMENSIONS

Width	58½	Seat Height	18½	Arm Height		Weight	133
Depth	29¾	Seat Depth	20½	No Arm Cap	22½	Cubic Ft.	38.00
Height	29⅜	Seat Width	55½	Arm Cap	22⅞		
				Arm Width	3½		

- Contrasting fabric option – specify X (i.e., K89L2CVALUTBX); see page 742. For list pricing, use your electronic specification tool or contact customer service
- Weight Limit 253 lbs.
- Tight-back
- Clean out
- 2mm tubular metal legs
- Non-skid, adjustable glides
- Arm cap on applicable models

TO ORDER, SPECIFY:

1. Model Number
2. Inner Back Upholstery Grade
3. Inner Back Upholstery Number
4. Outer Back Upholstery Grade
5. Outer Back Upholstery Number
6. Seat Upholstery Grade
7. Seat Upholstery Number
8. Arm Upholstery Grade
9. Arm Upholstery Number
10. Front Panel/Accent Upholstery Grade
11. Front Panel/Accent Upholstery Number
12. Leg Metal Finish Designator
13. Arm Cap Finish or Color Designator (if applicable)
14. Moisture Barrier Optional for Seat, or Seat and Inside Back

- See page 741 for Whittaker Health options
- See pages 775-780 for COM fabric yardage

**THREE SEAT CONVENIENCE
ARM ON LEFT LOUNGE**

**MODEL
NO.**

ALLIANCE PROGRAM PRICE GRADES

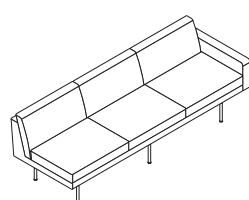

No Arm Cap

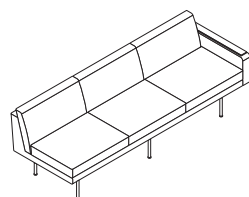

Arm Cap

			A	B	C	D	E	F	G	H	I
			J	K	L	M	N	O	P	Q	R
K89L3CVALUTB	No Arm Cap	\$	5417	5693	5909	6127	6352	6628	6785	7082	7327
			7583	7996	8822	9344	9452	9551	9679	9806	10378
K89L3CVALACWTB	Wood Arm Cap		5461	5737	5953	6171	6396	6672	6829	7126	7371
			7627	8040	8866	9388	9496	9595	9723	9850	10422
K89L3CVALACPTB	Polyurethane Arm Cap		5487	5763	5979	6197	6422	6698	6855	7152	7397
			7653	8066	8892	9414	9522	9621	9749	9876	10448
K89L3CVALACTTB	3D Laminate Arm Cap		5587	5863	6079	6297	6522	6798	6955	7252	7497
			7753	8166	8992	9514	9622	9721	9849	9976	10548
K89L3CVALACSTB	Solid Surface Arm Cap		5766	6042	6258	6476	6701	6977	7134	7431	7676
			7932	8345	9171	9693	9801	9900	10028	10155	10727

DIMENSIONS

Width	86	Seat Height	18 $\frac{1}{2}$	Arm Height		Weight	206
Depth	29 $\frac{3}{4}$	Seat Depth	20 $\frac{1}{4}$	No Arm Cap	22 $\frac{3}{4}$	Cubic Ft.	56.00
Height	29 $\frac{3}{16}$	Seat Width	82 $\frac{1}{2}$	Arm Cap	22 $\frac{1}{4}$		
				Arm Width	3 $\frac{1}{2}$		

- Contrasting fabric option – specify X (i.e., K89L3CVALUTBX); see page 742. For list pricing, use your electronic specification tool or contact customer service
- Weight Limit 253 lbs.
- Tight-back
- Clean out
- 2mm tubular metal legs
- Non-skid, adjustable glides
- Arm cap on applicable models

WHITTAKER HEALTH

TO ORDER, SPECIFY:

1. Model Number
2. Inner Back Upholstery Grade
3. Inner Back Upholstery Number
4. Outer Back Upholstery Grade
5. Outer Back Upholstery Number
6. Seat Upholstery Grade
7. Seat Upholstery Number
8. Arm Upholstery Grade
9. Arm Upholstery Number
10. Front Panel/Accent Upholstery Grade
11. Front Panel/Accent Upholstery Number
12. Leg Metal Finish Designator
13. Arm Cap Finish or Color Designator (if applicable)
14. Moisture Barrier Optional for Seat, or Seat and Inside Back

- See page 741 for Whittaker Health options
- See pages 775-780 for COM fabric yardage

ONE SEAT CONVENIENCE ARM ON RIGHT LOUNGE

MODEL NO.

ALLIANCE PROGRAM PRICE GRADES

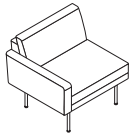

No Arm Cap

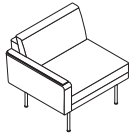

Arm Cap

			A	B	C	D	E	F	G	H	I
			J	K	L	M	N	O	P	Q	R
K89L1CVARUTB	No Arm Cap	\$	2817	2967	3084	3201	3324	3474	3558	3719	3852
			3992	4215	4665	4948	5007	5060	5129	5199	5508
K89L1CVARACWTB	Wood Arm Cap		2859	3009	3126	3243	3366	3516	3600	3761	3894
			4034	4257	4707	4990	5049	5102	5171	5241	5550
K89L1CVARACPTB	Polyurethane Arm Cap		2884	3034	3151	3268	3391	3541	3625	3786	3919
			4059	4282	4732	5015	5074	5127	5196	5266	5575
K89L1CVARACTTB	3D Laminate Arm Cap		2985	3135	3252	3369	3492	3642	3726	3887	4020
			4160	4383	4833	5116	5175	5228	5297	5367	5676
K89L1CVARACSTB	Solid Surface Arm Cap		3159	3309	3426	3543	3666	3816	3900	4061	4194
			4334	4557	5007	5290	5349	5402	5471	5541	5850

DIMENSIONS

Width	31 $\frac{1}{4}$	Seat Height	18 $\frac{1}{2}$	Arm Height		Weight	86
Depth	29 $\frac{3}{8}$	Seat Depth	20 $\frac{1}{8}$	No Arm Cap	22 $\frac{1}{8}$	Cubic Ft.	21.00
Height	29 $\frac{3}{16}$	Seat Width	27 $\frac{1}{4}$	Arm Cap	22 $\frac{1}{8}$		
				Arm Width	3 $\frac{1}{2}$		

- Contrasting fabric option – specify X (i.e., K89L1CVARUTBX); see page 742. For list pricing, use your electronic specification tool or contact customer service
- Weight Limit 253 lbs.
- Tight-back
- Clean out
- 2mm tubular metal legs
- Non-skid, adjustable glides
- Arm cap on applicable models

TWO SEAT CONVENIENCE ARM ON RIGHT LOUNGE

			A	B	C	D	E	F	G	H	I
			J	K	L	M	N	O	P	Q	R
K89L2CVARUTB	No Arm Cap	\$	4100	4312	4477	4644	4817	5029	5150	5377	5566
			5763	6080	6715	7115	7199	7275	7372	7471	7910
K89L2CVARACWTB	Wood Arm Cap		4144	4356	4521	4688	4861	5073	5194	5421	5610
			5807	6124	6759	7159	7243	7319	7416	7515	7954
K89L2CVARACPTB	Polyurethane Arm Cap		4170	4382	4547	4714	4887	5099	5220	5447	5636
			5833	6150	6785	7185	7269	7345	7442	7541	7980
K89L2CVARACTTB	3D Laminate Arm Cap		4271	4483	4648	4815	4988	5200	5321	5548	5737
			5934	6251	6886	7286	7370	7446	7543	7642	8081
K89L2CVARACSTB	Solid Surface Arm Cap		4449	4661	4826	4993	5166	5378	5499	5726	5915
			6112	6429	7064	7464	7548	7624	7721	7820	8259

DIMENSIONS

Width	58 $\frac{1}{2}$	Seat Height	18 $\frac{1}{2}$	Arm Height		Weight	133
Depth	29 $\frac{3}{4}$	Seat Depth	20 $\frac{1}{8}$	No Arm Cap	22 $\frac{1}{8}$	Cubic Ft.	38.00
Height	29 $\frac{13}{16}$	Seat Width	55 $\frac{1}{2}$	Arm Cap	22 $\frac{1}{8}$		
				Arm Width	3 $\frac{1}{2}$		

- Contrasting fabric option – specify X (i.e., K89L2CVARUTBX); see page 742. For list pricing, use your electronic specification tool or contact customer service
- Weight Limit 253 lbs.
- Tight-back
- Clean out
- 2mm tubular metal legs
- Non-skid, adjustable glides
- Arm cap on applicable models

TO ORDER, SPECIFY:

1. Model Number
2. Inner Back Upholstery Grade
3. Inner Back Upholstery Number
4. Outer Back Upholstery Grade
5. Outer Back Upholstery Number
6. Seat Upholstery Grade
7. Seat Upholstery Number
8. Arm Upholstery Grade
9. Arm Upholstery Number
10. Front Panel/Accent Upholstery Grade
11. Front Panel/Accent Upholstery Number
12. Leg Metal Finish Designator
13. Arm Cap Finish or Color Designator (if applicable)
14. Moisture Barrier Optional for Seat, or Seat and Inside Back

- See page 741 for Whittaker Health options
- See pages 775-780 for COM fabric yardage

**THREE SEAT CONVENIENCE
ARM ON RIGHT LOUNGE**

**MODEL
NO.**

ALLIANCE PROGRAM PRICE GRADES

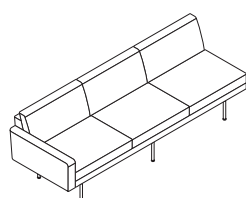

No Arm Cap

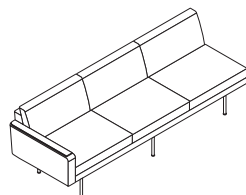

Arm Cap

			A	B	C	D	E	F	G	H	I
			J	K	L	M	N	O	P	Q	R
K89L3CVARUTB	No Arm Cap	\$	5417	5693	5909	6127	6352	6628	6785	7082	7327
			7583	7996	8822	9344	9452	9551	9679	9806	10378
K89L3CVARACWTB	Wood Arm Cap		5461	5737	5953	6171	6396	6672	6829	7126	7371
			7627	8040	8866	9388	9496	9595	9723	9850	10422
K89L3CVARACPTB	Polyurethane Arm Cap		5487	5763	5979	6197	6422	6698	6855	7152	7397
			7653	8066	8892	9414	9522	9621	9749	9876	10448
K89L3CVARACTTB	3D Laminate Arm Cap		5587	5863	6079	6297	6522	6798	6955	7252	7497
			7753	8166	8992	9514	9622	9721	9849	9976	10548
K89L3CVARACSTB	Solid Surface Arm Cap		5766	6042	6258	6476	6701	6977	7134	7431	7676
			7932	8345	9171	9693	9801	9900	10028	10155	10727

DIMENSIONS

Width	86	Seat Height	18 $\frac{1}{2}$	Arm Height		Weight	206
Depth	29 $\frac{3}{4}$	Seat Depth	20 $\frac{1}{4}$	No Arm Cap	22 $\frac{3}{4}$	Cubic Ft.	56.00
Height	29 $\frac{3}{8}$	Seat Width	82 $\frac{1}{2}$	Arm Cap	22 $\frac{1}{4}$		
				Arm Width	3 $\frac{1}{2}$		

- Contrasting fabric option – specify X (i.e., K89L3CVARUTBX); see page 742. For list pricing, use your electronic specification tool or contact customer service
- Weight Limit 253 lbs.
- Tight-back
- Clean out
- 2mm tubular metal legs
- Non-skid, adjustable glides
- Arm cap on applicable models

WHITTAKER HEALTH

WHITTAKER HEALTH

TO ORDER, SPECIFY:

1. Model Number
2. Inner Back Upholstery Grade
3. Inner Back Upholstery Number
4. Outer Back Upholstery Grade
5. Outer Back Upholstery Number
6. Seat Upholstery Grade
7. Seat Upholstery Number
8. Arm Upholstery Grade
9. Arm Upholstery Number
10. Front Panel/Accent Upholstery Grade
11. Front Panel/Accent Upholstery Number
12. Leg Metal Finish Designator
13. Arm Cap Finish or Color Designator (if applicable)
14. Moisture Barrier Optional for Seat, or Seat and Inside Back

- See page 741 for Whittaker Health options
- See pages 775-780 for COM fabric yardage

ONE SEAT CONVENIENCE ARM ON BOTH SIDES LOUNGE

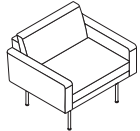

No Arm Caps

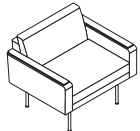

Arm Caps

MODEL NO.

ALLIANCE PROGRAM PRICE GRADES

			A	B	C	D	E	F	G	H	I
			J	K	L	M	N	O	P	Q	R
K89L1CVABUTB	No Arm Cap	\$	3100	3253	3373	3492	3618	3770	3857	4021	4157
			4300	4527	4987	5275	5336	5390	5460	5532	5846
K89L1CVABACWTB	Wood Arm Cap		3165	3318	3438	3557	3683	3835	3922	4086	4222
			4365	4592	5052	5340	5401	5455	5525	5597	5911
K89L1CVABACPTB	Polyurethane Arm Cap		3230	3383	3503	3622	3748	3900	3987	4151	4287
			4430	4657	5117	5405	5466	5520	5590	5662	5976
K89L1CVABACTTB	3D Laminate Arm Cap		3431	3584	3704	3823	3949	4101	4188	4352	4488
			4631	4858	5318	5606	5667	5721	5791	5863	6177
K89L1CVABACSTB	Solid Surface Arm Cap		3787	3940	4060	4179	4305	4457	4544	4708	4844
			4987	5214	5674	5962	6023	6077	6147	6219	6533

DIMENSIONS

Width	34 $\frac{3}{4}$	Seat Height	18 $\frac{1}{2}$	Arm Height		Weight	94
Depth	29 $\frac{3}{4}$	Seat Depth	20 $\frac{1}{4}$	No Arm Cap	22 $\frac{1}{4}$	Cubic Ft.	23.00
Height	29 $\frac{3}{16}$	Seat Width	27 $\frac{3}{4}$	Arm Cap	22 $\frac{1}{4}$		
				Arm Width	3 $\frac{1}{2}$		

- Contrasting fabric option – specify X (i.e., K89L1CVABUTBX); see page 742. For list pricing, use your electronic specification tool or contact customer service
- Weight Limit 253 lbs.
- Tight-back
- Clean out
- 2mm tubular metal legs
- Non-skid, adjustable glides
- Arm cap on applicable models

TWO SEAT CONVENIENCE ARM ON BOTH SIDES LOUNGE

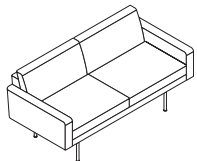

No Arm Caps

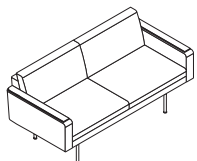

Arm Caps

			A	B	C	D	E	F	G	H	I
			J	K	L	M	N	O	P	Q	R
K89L2CVABUTB	No Arm Cap	\$	4389	4608	4779	4951	5130	5349	5474	5709	5904
			6107	6435	7091	7504	7591	7669	7770	7872	8325
K89L2CVABACWTB	Wood Arm Cap		4478	4697	4868	5040	5219	5438	5563	5798	5993
			6196	6524	7180	7593	7680	7758	7859	7961	8414
K89L2CVABACPTB	Polyurethane Arm Cap		4529	4748	4919	5091	5270	5489	5614	5849	6044
			6247	6575	7231	7644	7731	7809	7910	8012	8465
K89L2CVABACTTB	3D Laminate Arm Cap		4727	4946	5117	5289	5468	5687	5812	6047	6242
			6445	6773	7429	7842	7929	8007	8108	8210	8663
K89L2CVABACSTB	Solid Surface Arm Cap		5084	5303	5474	5646	5825	6044	6169	6404	6599
			6802	7130	7786	8199	8286	8364	8465	8567	9020

DIMENSIONS

Width	62 $\frac{1}{2}$	Seat Height	18 $\frac{1}{2}$	Arm Height		Weight	141
Depth	29 $\frac{3}{4}$	Seat Depth	20 $\frac{1}{4}$	No Arm Cap	22 $\frac{1}{4}$	Cubic Ft.	41.00
Height	29 $\frac{3}{16}$	Seat Width	55 $\frac{1}{2}$	Arm Cap	22 $\frac{1}{4}$		
				Arm Width	3 $\frac{1}{2}$		

- Contrasting fabric option – specify X (i.e., K89L2CVABUTBX); see page 742. For list pricing, use your electronic specification tool or contact customer service
- Weight Limit 253 lbs.
- Tight-back
- Clean out
- 2mm tubular metal legs
- Non-skid, adjustable glides
- Arm cap on applicable models

TO ORDER, SPECIFY:

1. Model Number
2. Inner Back Upholstery Grade
3. Inner Back Upholstery Number
4. Outer Back Upholstery Grade
5. Outer Back Upholstery Number
6. Seat Upholstery Grade
7. Seat Upholstery Number
8. Arm Upholstery Grade
9. Arm Upholstery Number
10. Front Panel/Accent Upholstery Grade
11. Front Panel/Accent Upholstery Number
12. Leg Metal Finish Designator
13. Arm Cap Finish or Color Designator (if applicable)
14. Moisture Barrier Optional for Seat, or Seat and Inside Back

- See page 741 for Whittaker Health options
- See pages 775-780 for COM fabric yardage

**THREE SEAT CONVENIENCE
ARM ON BOTH SIDES
LOUNGE**

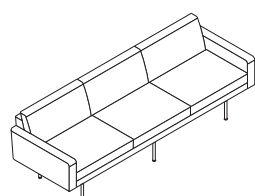

No Arm Caps

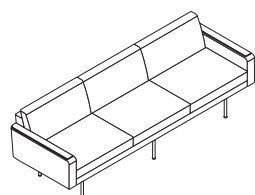

Arm Caps

**MODEL
NO.**

ALLIANCE PROGRAM PRICE GRADES

			A	B	C	D	E	F	G	H	I
			J	K	L	M	N	O	P	Q	R
K89L3CVABUTB	No Arm Cap	\$	5701	5984	6206	6429	6660	6943	7104	7409	7660
			7922	8346	9193	9728	9839	9940	10072	10202	10788
K89L3CVABACWTB	Wood Arm Cap		5789	6072	6294	6517	6748	7031	7192	7497	7748
			8010	8434	9281	9816	9927	10028	10160	10290	10876
K89L3CVABACPTB	Polyurethane Arm Cap		5842	6125	6347	6570	6801	7084	7245	7550	7801
			8063	8487	9334	9869	9980	10081	10213	10343	10929
K89L3CVABACTTB	3D Laminate Arm Cap		6042	6325	6547	6770	7001	7284	7445	7750	8001
			8263	8687	9534	10069	10180	10281	10413	10543	11129
K89L3CVABACSTB	Solid Surface Arm Cap		6399	6682	6904	7127	7358	7641	7802	8107	8358
			8620	9044	9891	10426	10537	10638	10770	10900	11486

DIMENSIONS

Width	89½	Seat Height	18½	Arm Height		Weight	214
Depth	29¾	Seat Depth	20¼	No Arm Cap	22¾	Cubic Ft.	58.00
Height	29¾	Seat Width	82½	Arm Cap	22¼		
				Arm Width	3½		

- Contrasting fabric option – specify X (i.e., K89L3CVABUTBX); see page 742. For list pricing, use your electronic specification tool or contact customer service
- Weight Limit 253 lbs.
- Tight-back
- Clean out
- 2mm tubular metal legs
- Non-skid, adjustable glides
- Arm cap on applicable models

WHITTAKER HEALTH

TO ORDER, SPECIFY:

1. Model Number
2. Inner Back Upholstery Grade
3. Inner Back Upholstery Number
4. Outer Back Upholstery Grade
5. Outer Back Upholstery Number
6. Seat Upholstery Grade
7. Seat Upholstery Number
8. Arm Upholstery Grade
9. Arm Upholstery Number
10. Front Panel/Accent Upholstery Grade
11. Front Panel/Accent Upholstery Number
12. Leg Metal Finish Designator
13. Moisture Barrier Optional for Seat, or Seat and Inside Back

- See page 741 for Whittaker Health options
- See pages 775-780 for COM fabric yardage

ONE SEAT FULL ARM(S) LOUNGE

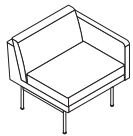

Full Arm on Left



Full Arm on Right

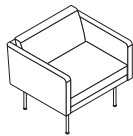

Full Arm on Both Sides

MODEL NO.

ALLIANCE PROGRAM PRICE GRADES

			A	B	C	D	E	F	G	H	I
			J	K	L	M	N	O	P	Q	R
K89L1FALTB	Full Arm on Left	\$	2822	2972	3089	3206	3329	3479	3563	3724	3857
			3997	4220	4670	4953	5012	5065	5134	5204	5513
K89L1FARTB	Full Arm on Right		2822	2972	3089	3206	3329	3479	3563	3724	3857
			3997	4220	4670	4953	5012	5065	5134	5204	5513
K89L1FABTB	Full Arm on Both Sides		3115	3283	3415	3546	3684	3852	3948	4128	4278
			4435	4686	5191	5508	5575	5635	5712	5791	6138

DIMENSIONS

Width	29¾	Seat Height	18¾	Arm Height	26¾	Weight	86
Depth	29¾	Seat Depth	20⅞	Arm Width	2	Weight Both Sides	93
Height	29⅜	Seat Width	27¾			Cubic Ft.	20.00
						Cubic Ft. Both Sides	22.00

- Contrasting fabric option – specify X (i.e., K89L1FALTBX); see page 742. For list pricing, use your electronic specification tool or contact customer service
- Weight Limit 253 lbs.
- Tight-back
- Clean out
- 2mm tubular metal legs
- Non-skid, adjustable glides

TWO SEAT FULL ARM(S) LOUNGE

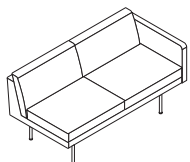

Full Arm on Left

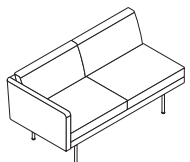

Full Arm on Right

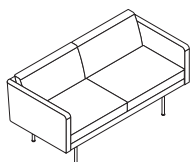

Full Arm on Both Sides

			A	B	C	D	E	F	G	H	I
			J	K	L	M	N	O	P	Q	R
K89L2FALTB	Full Arm on Left	\$	4122	4338	4506	4676	4852	5069	5191	5423	5615
			5815	6139	6785	7193	7278	7355	7455	7555	8003
K89L2FARTB	Full Arm on Right		4122	4338	4506	4676	4852	5069	5191	5423	5615
			5815	6139	6785	7193	7278	7355	7455	7555	8003
K89L2FABTB	Full Arm on Both Sides		4442	4676	4859	5043	5234	5469	5603	5854	6063
			6280	6632	7333	7775	7868	7952	8060	8169	8655

DIMENSIONS

Width	57¾	Seat Height	18¾	Arm Height	26¾	Weight	133
Depth	29¾	Seat Depth	20⅞	Arm Width	2	Weight Both Sides	140
Height	29⅜	Seat Width	55¾			Cubic Ft.	37.00
						Cubic Ft. Both Sides	39.00

- Contrasting fabric option – specify X (i.e., K89L2FALTBX); see page 742. For list pricing, use your electronic specification tool or contact customer service
- Weight Limit 253 lbs.
- Tight-back
- Clean out
- 2mm tubular metal legs
- Non-skid, adjustable glides

TO ORDER, SPECIFY:

1. Model Number
2. Inner Back Upholstery Grade
3. Inner Back Upholstery Number
4. Outer Back Upholstery Grade
5. Outer Back Upholstery Number
6. Seat Upholstery Grade
7. Seat Upholstery Number
8. Arm Upholstery Grade
9. Arm Upholstery Number
10. Front Panel/Accent Upholstery Grade
11. Front Panel/Accent Upholstery Number
12. Leg Metal Finish Designator
13. Moisture Barrier Optional for Seat, or Seat and Inside Back

- See page 741 for Whittaker Health options
- See pages 775-780 for COM fabric yardage

THREE SEAT FULL ARM(S) LOUNGE

MODEL NO.

ALLIANCE PROGRAM PRICE GRADES

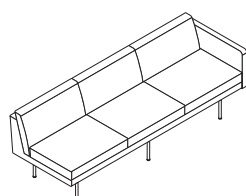

Full Arm on Left

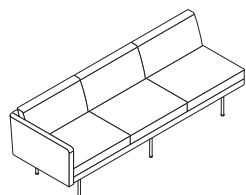

Full Arm on Right

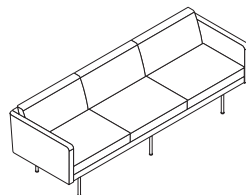

Full Arm on Both Sides

			A	B	C	D	E	F	G	H	I
			J	K	L	M	N	O	P	Q	R
K89L3FALTB	Full Arm on Left	\$	5273	5553	5772	5993	6221	6502	6660	6962	7210
			7469	7889	8726	9256	9365	9465	9596	9724	10305
K89L3FARTB	Full Arm on Right		5273	5553	5772	5993	6221	6502	6660	6962	7210
			7469	7889	8726	9256	9365	9465	9596	9724	10305
K89L3FABTB	Full Arm on Both Sides		5317	5615	5849	6084	6327	6626	6796	7117	7382
			7658	8106	8998	9562	9679	9786	9925	10062	10681

DIMENSIONS

Width	84½	Seat Height	18½	Arm Height	26½	Weight	206
Depth	29¾	Seat Depth	20¾	Arm Width	2	Weight Both Sides	214
Height	29¾	Seat Width	82½			Cubic Ft.	55.00
						Cubic Ft. Both Sides	56.00

- Contrasting fabric option – specify X (i.e., K89L3FALTBX); see page 742. For list pricing, use your electronic specification tool or contact customer service
- Weight Limit 253 lbs.
- Tight-back
- Clean out
- 2mm tubular metal legs
- Non-skid, adjustable glides

WHITTAKER HEALTH

WHITTAKER HEALTH

TO ORDER, SPECIFY:

1. Model Number
2. Inner Back Upholstery Grade
3. Inner Back Upholstery Number
4. Outer Back Upholstery Grade
5. Outer Back Upholstery Number
6. Seat Upholstery Grade
7. Seat Upholstery Number
8. Arm Upholstery Grade
9. Arm Upholstery Number
10. Front Panel/Accent Upholstery Grade
11. Front Panel/Accent Upholstery Number
12. Leg Metal Finish Designator
13. Moisture Barrier Optional for Seat, or Seat and Inside Back

- See page 741 for Whittaker Health options
- See pages 775-780 for COM fabric yardage

TWO SEAT INTERIOR ARMS, NO SIDE ARMS LOUNGE

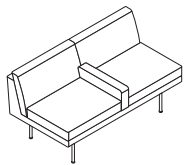

MODEL NO.

ALLIANCE PROGRAM PRICE GRADES

			A	B	C	D	E	F	G	H	I
			J	K	L	M	N	O	P	Q	R
K89L2XAITB	Interior Arm Center	\$	3610	3814	3974	4133	4300	4505	4621	4840	5022
			5211	5517	6129	6513	6595	6667	6761	6857	7278

DIMENSIONS

Width	55½	Seat Height	18½	Arm Height	26½	Weight	132
Depth	29¾	Seat Depth	20½	Arm Width	3½	Cubic Ft.	36.00
Height	29⅜	Seat Width	55%				

- Contrasting fabric option – specify X (i.e., K89L2XAITBX); see page 742. For list pricing, use your electronic specification tool or contact customer service
- Weight Limit 253 lbs.
- Tight-back
- Clean out
- 2mm tubular metal legs
- Non-skid, adjustable glides

THREE SEAT INTERIOR ARMS, NO SIDE ARMS LOUNGE

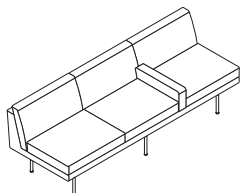

Interior Arm Left

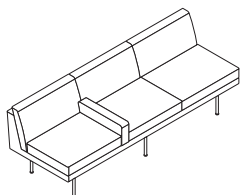

Interior Arm Right

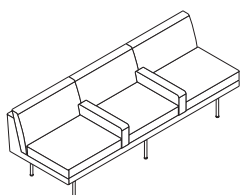

Interior Arms Left and Right

			A	B	C	D	E	F	G	H	I
			J	K	L	M	N	O	P	Q	R
K89L3XAILTB	Interior Arm Left	\$	4839	5113	5328	5544	5767	6043	6198	6494	6737
			6991	7402	8223	8741	8849	8947	9075	9201	9769
K89L3XAIRTB	Interior Arm Right		4839	5113	5328	5544	5767	6043	6198	6494	6737
			6991	7402	8223	8741	8849	8947	9075	9201	9769
K89L3XAIBTB	Interior Arms Left and Right		4846	5120	5335	5551	5774	6050	6205	6501	6744
			6998	7409	8230	8748	8856	8954	9082	9208	9776

DIMENSIONS

Width	82½	Seat Height	18½	Arm Height	26½	Weight	206
Depth	29¾	Seat Depth	20½	Arm Width	2	Weight Both Sides	213
Height	29⅜	Seat Width	82½			Cubic Ft.	53.00

- Contrasting fabric option – specify X (i.e., K89L3XAILTBX); see page 742. For list pricing, use your electronic specification tool or contact customer service
- Weight Limit 253 lbs.
- Tight-back
- Clean out
- 2mm tubular metal legs
- Non-skid, adjustable glides

TO ORDER, SPECIFY:

- 1. Model Number
- 2. Inner Back Upholstery Grade
- 3. Inner Back Upholstery Number
- 4. Outer Back Upholstery Grade
- 5. Outer Back Upholstery Number
- 6. Seat Upholstery Grade
- 7. Seat Upholstery Number
- 8. Arm Upholstery Grade
- 9. Arm Upholstery Number
- 10. Front Panel/Accent Upholstery Grade
- 11. Front Panel/Accent Upholstery Number
- 12. Leg Metal Finish Designator
- 13. Arm Cap Finish or Color Designator (if applicable)
- 14. Moisture Barrier Optional for Seat, or Seat and Inside Back

- See page 741 for Whittaker Health options
- See pages 775-780 for COM fabric yardage

TWO SEAT INTERIOR ARM IN CENTER, CONVENIENCE ARM ON LEFT LOUNGE

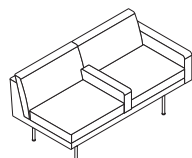

No Arm Caps

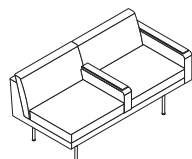

Arm Caps

MODEL NO.

ALLIANCE PROGRAM PRICE GRADES

		A	B	C	D	E	F	G	H	I
		J	K	L	M	N	O	P	Q	R
K89L2CVALIUTB	No Arm Caps	\$ 4180	4396	4564	4734	4910	5127	5249	5481	5673
		5873	6197	6843	7251	7336	7413	7513	7613	8061
K89L2CVALIACWTB	Wood Arm Caps	4262	4478	4646	4816	4992	5209	5331	5563	5755
		5955	6279	6925	7333	7418	7495	7595	7695	8143
K89L2CVALIACPTB	Polyurethane Arm Caps	4321	4537	4705	4875	5051	5268	5390	5622	5814
		6014	6338	6984	7392	7477	7554	7654	7754	8202
K89L2CVALIACTTB	3D Laminate Arm Caps	4854	5070	5238	5408	5584	5801	5923	6155	6347
		6547	6871	7517	7925	8010	8087	8187	8287	8735
K89L2CVALIACSTB	Solid Surface Arm Caps	5051	5267	5435	5605	5781	5998	6120	6352	6544
		6744	7068	7714	8122	8207	8284	8384	8484	8932

DIMENSIONS

Width	58 $\frac{3}{4}$	Seat Height	18 $\frac{1}{2}$	Arm Height		Weight	140
Depth	29 $\frac{3}{4}$	Seat Depth	20 $\frac{1}{4}$	No Arm Cap	22 $\frac{1}{4}$	Cubic Ft.	38.00
Height	29 $\frac{1}{2}$	Seat Width	25 $\frac{1}{2}$	Arm Cap	22 $\frac{1}{4}$		
				Arm Width	3 $\frac{1}{2}$		

- Contrasting fabric option – specify X (i.e., K89L2CVALIUTBX); see page 742. For list pricing, use your electronic specification tool or contact customer service
- Weight Limit 253 lbs.
- Tight-back
- Clean out
- 2mm tubular metal legs
- Non-skid, adjustable glides
- Arm caps on applicable models

TWO SEAT INTERIOR ARM IN CENTER, CONVENIENCE ARM ON RIGHT LOUNGE

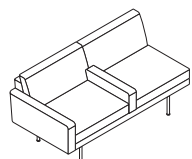

No Arm Caps

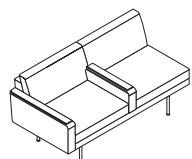

Arm Caps

		A	B	C	D	E	F	G	H	I
		J	K	L	M	N	O	P	Q	R
K89L2CVARIUTB	No Arm Caps	\$ 4180	4396	4564	4734	4910	5127	5249	5481	5673
		5873	6197	6843	7251	7336	7413	7513	7613	8061
K89L2CVARIACWTB	Wood Arm Caps	4262	4478	4646	4816	4992	5209	5331	5563	5755
		5955	6279	6925	7333	7418	7495	7595	7695	8143
K89L2CVARIACPTB	Polyurethane Arm Caps	4321	4537	4705	4875	5051	5268	5390	5622	5814
		6014	6338	6984	7392	7477	7554	7654	7754	8202
K89L2CVARIACTTB	3D Laminate Arm Caps	4854	5070	5238	5408	5584	5801	5923	6155	6347
		6547	6871	7517	7925	8010	8087	8187	8287	8735
K89L2CVARIACSTB	Solid Surface Arm Caps	5051	5267	5435	5605	5781	5998	6120	6352	6544
		6744	7068	7714	8122	8207	8284	8384	8484	8932

DIMENSIONS

Width	58 $\frac{3}{4}$	Seat Height	18 $\frac{1}{2}$	Arm Height		Weight	140
Depth	29 $\frac{3}{4}$	Seat Depth	20 $\frac{1}{4}$	No Arm Cap	22 $\frac{1}{4}$	Cubic Ft.	38.00
Height	29 $\frac{1}{2}$	Seat Width	25 $\frac{1}{2}$	Arm Cap	22 $\frac{1}{4}$		
				Arm Width	3 $\frac{1}{2}$		

- Contrasting fabric option – specify X (i.e., K89L2CVARIUTBX); see page 742. For list pricing, use your electronic specification tool or contact customer service
- Weight Limit 253 lbs.
- Tight-back
- Clean out
- 2mm tubular metal legs
- Non-skid, adjustable glides
- Arm caps on applicable models

TO ORDER, SPECIFY:

1. Model Number
2. Inner Back Upholstery Grade
3. Inner Back Upholstery Number
4. Outer Back Upholstery Grade
5. Outer Back Upholstery Number
6. Seat Upholstery Grade
7. Seat Upholstery Number
8. Arm Upholstery Grade
9. Arm Upholstery Number
10. Front Panel/Accent Upholstery Grade
11. Front Panel/Accent Upholstery Number
12. Leg Metal Finish Designator
13. Arm Cap Finish or Color Designator (if applicable)
14. Moisture Barrier Optional for Seat, or Seat and Inside Back

- See page 741 for Whittaker Health options
- See pages 775-780 for COM fabric yardage

TWO SEAT INTERIOR ARM IN CENTER, CONVENIENCE ARM ON BOTH SIDES LOUNGE

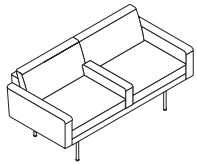

No Arm Caps

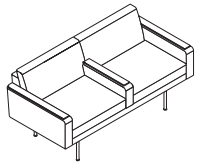

Arm Caps

MODEL NO.

ALLIANCE PROGRAM PRICE GRADES

			A	B	C	D	E	F	G	H	I
			J	K	L	M	N	O	P	Q	R
K89L2CVABIUTB	No Arm Caps	\$	4306	4529	4703	4878	5060	5284	5410	5649	5848
			6055	6389	7056	7477	7565	7645	7747	7851	8313
K89L2CVABIACWTB	Wood Arm Caps		4467	4690	4864	5039	5221	5445	5571	5810	6009
			6216	6550	7217	7638	7726	7806	7908	8012	8474
K89L2CVABIACPTB	Polyurethane Arm Caps		4665	4888	5062	5237	5419	5643	5769	6008	6207
			6414	6748	7415	7836	7924	8004	8106	8210	8672
K89L2CVABIACCTB	3D Laminate Arm Caps		5342	5565	5739	5914	6096	6320	6446	6685	6884
			7091	7425	8092	8513	8601	8681	8783	8887	9349
K89L2CVABIACSTB	Solid Surface Arm Caps		5608	5831	6005	6180	6362	6586	6712	6951	7150
			7357	7691	8358	8779	8867	8947	9049	9153	9615

DIMENSIONS

Width	62 $\frac{3}{8}$	Seat Height	18 $\frac{1}{2}$	Arm Height		Weight	140
Depth	29 $\frac{3}{4}$	Seat Depth	20 $\frac{1}{4}$	No Arm Cap	22 $\frac{3}{4}$	Cubic Ft.	38.00
Height	29 $\frac{3}{8}$	Seat Width	25 $\frac{1}{4}$	Arm Cap	22 $\frac{1}{4}$		
				Arm Width	3 $\frac{1}{2}$		

- Contrasting fabric option – specify X (i.e., K89L2CVABIUTBX); see page 742. For list pricing, use your electronic specification tool or contact customer service
- Weight Limit 253 lbs.
- Tight-back
- Clean out
- 2mm tubular metal legs
- Non-skid, adjustable glides
- Arm caps on applicable models

TO ORDER, SPECIFY:

- 1. Model Number
- 2. Inner Back Upholstery Grade
- 3. Inner Back Upholstery Number
- 4. Outer Back Upholstery Grade
- 5. Outer Back Upholstery Number
- 6. Seat Upholstery Grade
- 7. Seat Upholstery Number
- 8. Arm Upholstery Grade
- 9. Arm Upholstery Number
- 10. Front Panel/Accent Upholstery Grade
- 11. Front Panel/Accent Upholstery Number
- 12. Leg Metal Finish Designator
- 13. Arm Cap Finish or Color Designator (if applicable)
- 14. Moisture Barrier Optional for Seat, or Seat and Inside Back

- See page 741 for Whittaker Health options
- See pages 775-780 for COM fabric yardage

THREE SEAT INTERIOR ARM ON LEFT, CONVENIENCE ARM ON RIGHT LOUNGE

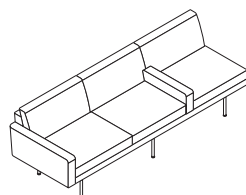

No Arm Caps

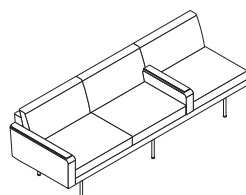

Arm Caps

MODEL NO.

ALLIANCE PROGRAM PRICE GRADES

		A	B	C	D	E	F	G	H	I
		J	K	L	M	N	O	P	Q	R
K89L3CVARILUTB	No Arm Caps	\$ 5350	5626	5842	6060	6285	6561	6718	7015	7260
		7516	7929	8755	9277	9385	9484	9612	9739	10311
K89L3CVARILACWTB	Wood Arm Caps	5419	5695	5911	6129	6354	6630	6787	7084	7329
		7585	7998	8824	9346	9454	9553	9681	9808	10380
K89L3CVARILACPTB	Polyurethane Arm Caps	5506	5782	5998	6216	6441	6717	6874	7171	7416
		7672	8085	8911	9433	9541	9640	9768	9895	10467
K89L3CVARILACTTB	3D Laminate Arm Caps	6055	6331	6547	6765	6990	7266	7423	7720	7965
		8221	8634	9460	9982	10090	10189	10317	10444	11016
K89L3CVARILACSTB	Solid Surface Arm Caps	6239	6515	6731	6949	7174	7450	7607	7904	8149
		8405	8818	9644	10166	10274	10373	10501	10628	11200

DIMENSIONS

Width	89½	Seat Height	18½	Arm Height		Weight	213
Depth	29¾	Seat Depth	20¾	No Arm Cap	22¾	Cubic Ft.	56.00
Height	29¾	Seat Width	25¾	Arm Cap	22¾		
				Arm Width	3½		

- Contrasting fabric option – specify X (i.e., K89L3CVARILUTBX); see page 742. For list pricing, use your electronic specification tool or contact customer service
- Weight Limit 253 lbs.
- Tight-back
- Clean out
- 2mm tubular metal legs
- Non-skid, adjustable glides
- Arm caps on applicable models

THREE SEAT INTERIOR ARM ON LEFT, CONVENIENCE ARMS ON BOTH SIDES LOUNGE

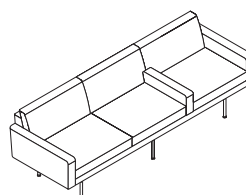

No Arm Caps

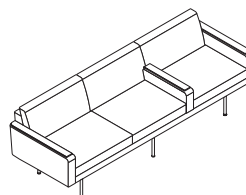

Arm Caps

		A	B	C	D	E	F	G	H	I
		J	K	L	M	N	O	P	Q	R
K89L3CVABILUTB	No Arm Caps	\$ 5685	5972	6197	6423	6657	6945	7107	7416	7671
		7937	8367	9225	9768	9880	9983	10116	10248	10843
K89L3CVABILACWTB	Wood Arm Caps	5714	6001	6226	6452	6686	6974	7136	7445	7700
		7966	8396	9254	9797	9909	10012	10145	10277	10872
K89L3CVABILACPTB	Polyurethane Arm Caps	5881	6168	6393	6619	6853	7141	7303	7612	7867
		8133	8563	9421	9964	10076	10179	10312	10444	11039
K89L3CVABILACTTB	3D Laminate Arm Caps	6716	7003	7228	7454	7688	7976	8138	8447	8702
		8968	9398	10256	10799	10911	11014	11147	11279	11874
K89L3CVABILACSTB	Solid Surface Arm Caps	6988	7275	7500	7726	7960	8248	8410	8719	8974
		9240	9670	10528	11071	11183	11286	11419	11551	12146

DIMENSIONS

Width	89½	Seat Height	18½	Arm Height		Weight	221
Depth	29¾	Seat Depth	20¾	No Arm Cap	22¾	Cubic Ft.	58.00
Height	29¾	Seat Width	25¾	Arm Cap	22¾		
				Arm Width	3½		

- Contrasting fabric option – specify X (i.e., K89L3CVABILUTBX); see page 742. For list pricing, use your electronic specification tool or contact customer service
- Weight Limit 253 lbs.
- Tight-back
- Clean out
- 2mm tubular metal legs
- Non-skid, adjustable glides
- Arm caps on applicable models

WHITTAKER HEALTH

TO ORDER, SPECIFY:

1. Model Number
2. Inner Back Upholstery Grade
3. Inner Back Upholstery Number
4. Outer Back Upholstery Grade
5. Outer Back Upholstery Number
6. Seat Upholstery Grade
7. Seat Upholstery Number
8. Arm Upholstery Grade
9. Arm Upholstery Number
10. Front Panel/Accent Upholstery Grade
11. Front Panel/Accent Upholstery Number
12. Leg Metal Finish Designator
13. Arm Cap Finish or Color Designator (if applicable)
14. Moisture Barrier Optional for Seat, or Seat and Inside Back

- See page 741 for Whittaker Health options
- See pages 775-780 for COM fabric yardage

THREE SEAT INTERIOR ARM ON RIGHT, CONVENIENCE ARM ON LEFT LOUNGE

MODEL NO.

ALLIANCE PROGRAM PRICE GRADES

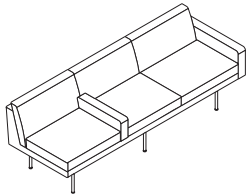

No Arm Caps

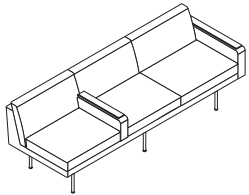

Arm Caps

			A	B	C	D	E	F	G	H	I
			J	K	L	M	N	O	P	Q	R
K89L3CVALIRUTB	No Arm Caps	\$	5350	5626	5842	6060	6285	6561	6718	7015	7260
			7516	7929	8755	9277	9385	9484	9612	9739	10311
K89L3CVALIRACWTB	Wood Arm Caps		5419	5695	5911	6129	6354	6630	6787	7084	7329
			7585	7998	8824	9346	9454	9553	9681	9808	10380
K89L3CVALIRACPTB	Polyurethane Arm Caps		5506	5782	5998	6216	6441	6717	6874	7171	7416
			7672	8085	8911	9433	9541	9640	9768	9895	10467
K89L3CVALIRACTTB	3D Laminate Arm Caps		6055	6331	6547	6765	6990	7266	7423	7720	7965
			8221	8634	9460	9982	10090	10189	10317	10444	11016
K89L3CVALIRACSTB	Solid Surface Arm Caps		6239	6515	6731	6949	7174	7450	7607	7904	8149
			8405	8818	9644	10166	10274	10373	10501	10628	11200

DIMENSIONS

Width	89 $\frac{1}{2}$	Seat Height	18 $\frac{1}{2}$	Arm Height		Weight	213
Depth	29 $\frac{3}{4}$	Seat Depth	20 $\frac{1}{4}$	No Arm Cap	22 $\frac{1}{4}$	Cubic Ft.	56.00
Height	29 $\frac{3}{8}$	Seat Width	25 $\frac{1}{4}$	Arm Cap	22 $\frac{1}{4}$		
				Arm Width	3 $\frac{1}{2}$		

- Contrasting fabric option – specify X (i.e., K89L3CVALIRUTBX); see page 742. For list pricing, use your electronic specification tool or contact customer service
- Weight Limit 253 lbs.
- Tight-back
- Clean out
- 2mm tubular metal legs
- Non-skid, adjustable glides
- Arm caps on applicable models

THREE SEAT INTERIOR ARM ON RIGHT, CONVENIENCE ARMS ON BOTH SIDES LOUNGE

			A	B	C	D	E	F	G	H	I
			J	K	L	M	N	O	P	Q	R
K89L3CVABIRUTB	No Arm Caps	\$	5685	5972	6197	6423	6657	6945	7107	7416	7671
			7937	8367	9225	9768	9880	9983	10116	10248	10843
K89L3CVABIRACWTB	Wood Arm Caps		5714	6001	6226	6452	6686	6974	7136	7445	7700
			7966	8396	9254	9797	9909	10012	10145	10277	10872
K89L3CVABIRACPTB	Polyurethane Arm Caps		5881	6168	6393	6619	6853	7141	7303	7612	7867
			8133	8563	9421	9964	10076	10179	10312	10444	11039
K89L3CVABIRACTTB	3D Laminate Arm Caps		6716	7003	7228	7454	7688	7976	8138	8447	8702
			8968	9398	10256	10799	10911	11014	11147	11279	11874
K89L3CVABIRACSTB	Solid Surface Arm Caps		6988	7275	7500	7726	7960	8248	8410	8719	8974
			9240	9670	10528	11071	11183	11286	11419	11551	12146

DIMENSIONS

Width	89 $\frac{1}{2}$	Seat Height	18 $\frac{1}{2}$	Arm Height		Weight	221
Depth	29 $\frac{3}{4}$	Seat Depth	20 $\frac{1}{4}$	No Arm Cap	22 $\frac{1}{4}$	Cubic Ft.	58.00
Height	29 $\frac{3}{8}$	Seat Width	25 $\frac{1}{4}$	Arm Cap	22 $\frac{1}{4}$		
				Arm Width	3 $\frac{1}{2}$		

- Contrasting fabric option – specify X (i.e., K89L3CVABIRUTBX); see page 742. For list pricing, use your electronic specification tool or contact customer service
- Weight Limit 253 lbs.
- Tight-back
- Clean out
- 2mm tubular metal legs
- Non-skid, adjustable glides
- Arm caps on applicable models

TO ORDER, SPECIFY:

- 1. Model Number
- 2. Inner Back Upholstery Grade
- 3. Inner Back Upholstery Number
- 4. Outer Back Upholstery Grade
- 5. Outer Back Upholstery Number
- 6. Seat Upholstery Grade
- 7. Seat Upholstery Number
- 8. Arm Upholstery Grade
- 9. Arm Upholstery Number
- 10. Front Panel/Accent Upholstery Grade
- 11. Front Panel/Accent Upholstery Number
- 12. Leg Metal Finish Designator
- 13. Arm Cap Finish or Color Designator (if applicable)
- 14. Moisture Barrier Optional for Seat, or Seat and Inside Back

- See page 741 for Whittaker Health options
- See pages 775-780 for COM fabric yardage

**THREE SEAT INTERIOR
ARMS ON LEFT AND RIGHT,
CONVENIENCE ARM ON
RIGHT LOUNGE**

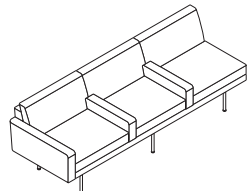

No Arm Caps

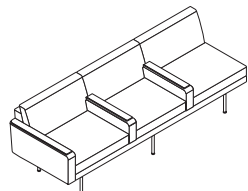

Arm Caps

**MODEL
NO.**

ALLIANCE PROGRAM PRICE GRADES

			A	B	C	D	E	F	G	H	I
			J	K	L	M	N	O	P	Q	R
K89L3CVARIBUTB	No Arm Caps	\$	5620	5914	6145	6377	6617	6912	7079	7396	7658
			7930	8372	9253	9810	9925	10030	10168	10303	10913
K89L3CVARIBACWTB	Wood Arm Caps		5703	5997	6228	6460	6700	6995	7162	7479	7741
			8013	8455	9336	9893	10008	10113	10251	10386	10996
K89L3CVARIBACPTB	Polyurethane Arm Caps		5821	6115	6346	6578	6818	7113	7280	7597	7859
			8131	8573	9454	10011	10126	10231	10369	10504	11114
K89L3CVARIBACTTB	3D Laminate Arm Caps		6628	6922	7153	7385	7625	7920	8087	8404	8666
			8938	9380	10261	10818	10933	11038	11176	11311	11921
K89L3CVARIBACSTB	Solid Surface Arm Caps		6910	7204	7435	7667	7907	8202	8369	8686	8948
			9220	9662	10543	11100	11215	11320	11458	11593	12203

DIMENSIONS

Width	89½	Seat Height	18½	Arm Height		Weight	221
Depth	29¾	Seat Depth	20¾	No Arm Cap	22¾	Cubic Ft.	58.00
Height	29¾	Seat Width	25¾	Arm Cap	22¾		
				Arm Width	3½		

- Contrasting fabric option – specify X (i.e., K89L3CVARIBUTBX); see page 742. For list pricing, use your electronic specification tool or contact customer service
- Weight Limit 253 lbs.
- Tight-back
- Clean out
- 2mm tubular metal legs
- Non-skid, adjustable glides
- Arm caps on applicable models

**THREE SEAT INTERIOR
ARMS ON LEFT AND RIGHT,
CONVENIENCE ARM ON
LEFT LOUNGE**

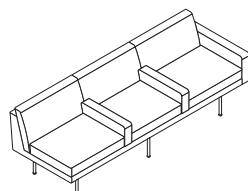

No Arm Caps

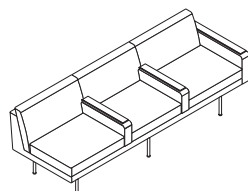

Arm Caps

			A	B	C	D	E	F	G	H	I
			J	K	L	M	N	O	P	Q	R
K89L3CVALIBUTB	No Arm Caps	\$	5620	5914	6145	6377	6617	6912	7079	7396	7658
			7930	8372	9253	9810	9925	10030	10168	10303	10913
K89L3CVALIBACWTB	Wood Arm Caps		5703	5997	6228	6460	6700	6995	7162	7479	7741
			8013	8455	9336	9893	10008	10113	10251	10386	10996
K89L3CVALIBACPTB	Polyurethane Arm Caps		5821	6115	6346	6578	6818	7113	7280	7597	7859
			8131	8573	9454	10011	10126	10231	10369	10504	11114
K89L3CVALIBACTTB	3D Laminate Arm Caps		6628	6922	7153	7385	7625	7920	8087	8404	8666
			8938	9380	10261	10818	10933	11038	11176	11311	11921
K89L3CVALIBACSTB	Solid Surface Arm Caps		6910	7204	7435	7667	7907	8202	8369	8686	8948
			9220	9662	10543	11100	11215	11320	11458	11593	12203

DIMENSIONS

Width	89½	Seat Height	18½	Arm Height		Weight	220
Depth	29¾	Seat Depth	20¾	No Arm Cap	22¾	Cubic Ft.	56.00
Height	29¾	Seat Width	25¾	Arm Cap	22¾		
				Arm Width	3½		

- Contrasting fabric option – specify X (i.e., K89L3CVALIBUTBX); see page 742. For list pricing, use your electronic specification tool or contact customer service
- Weight Limit 253 lbs.
- Tight-back
- Clean out
- 2mm tubular metal legs
- Non-skid, adjustable glides
- Arm caps on applicable models

WHITTAKER HEALTH

TO ORDER, SPECIFY:

1. Model Number
2. Inner Back Upholstery Grade
3. Inner Back Upholstery Number
4. Outer Back Upholstery Grade
5. Outer Back Upholstery Number
6. Seat Upholstery Grade
7. Seat Upholstery Number
8. Arm Upholstery Grade
9. Arm Upholstery Number
10. Front Panel/Accent Upholstery Grade
11. Front Panel/Accent Upholstery Number
12. Leg Metal Finish Designator
13. Arm Cap Finish or Color Designator (if applicable)
14. Moisture Barrier Optional for Seat, or Seat and Inside Back

- See page 741 for Whittaker Health options
- See pages 775-780 for COM fabric yardage

THREE SEAT INTERIOR ARMS ON LEFT AND RIGHT, CONVENIENCE ARMS ON BOTH SIDES LOUNGE

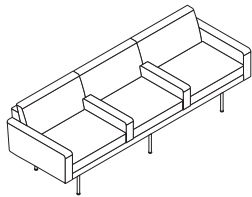

No Arm Caps

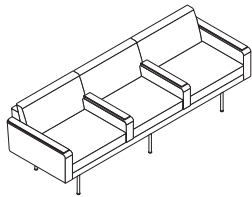

Arm Caps

MODEL NO.

ALLIANCE PROGRAM PRICE GRADES

			A	B	C	D	E	F	G	H	I
			J	K	L	M	N	O	P	Q	R
K89L3CVABIBUTB	No Arm Caps	\$	5941	6235	6466	6698	6938	7233	7400	7717	7979
			8251	8693	9574	10131	10246	10351	10489	10624	11234
K89L3CVABIBACWTB	Wood Arm Caps		5949	6243	6474	6706	6946	7241	7408	7725	7987
			8259	8701	9582	10139	10254	10359	10497	10632	11242
K89L3CVABIBACPTB	Polyurethane Arm Caps		6196	6490	6721	6953	7193	7488	7655	7972	8234
			8506	8948	9829	10386	10501	10606	10744	10879	11489
K89L3CVABIBACTTB	3D Laminate Arm Caps		7289	7583	7814	8046	8286	8581	8748	9065	9327
			9599	10041	10922	11479	11594	11699	11837	11972	12582
K89L3CVABIBACSTB	Solid Surface Arm Caps		7635	7929	8160	8392	8632	8927	9094	9411	9673
			9945	10387	11268	11825	11940	12045	12183	12318	12928

DIMENSIONS

Width	89½	Seat Height	18½	Arm Height		Weight	228
Depth	29¾	Seat Depth	20¼	No Arm Cap	22¾	Cubic Ft.	58.00
Height	29¾	Seat Width	25¼	Arm Cap	22¼		
				Arm Width	3½		

- Contrasting fabric option – specify X (i.e., K89L3CVABIBUTBX); see page 742. For list pricing, use your electronic specification tool or contact customer service
- Weight Limit 253 lbs.
- Tight-back
- Clean out
- 2mm tubular metal legs
- Non-skid, adjustable glides
- Arm caps on applicable models

TO ORDER, SPECIFY:

1. Model Number
2. Inner Back Upholstery Grade
3. Inner Back Upholstery Number
4. Outer Back Upholstery Grade
5. Outer Back Upholstery Number
6. Seat Upholstery Grade
7. Seat Upholstery Number
8. Front Panel/Accent Upholstery Grade
9. Front Panel/Accent Upholstery Number
10. Leg Metal Finish Designator
11. Moisture Barrier Optional for Seat, or Seat and Inside Back

- See page 741 for Whittaker Health options
- See pages 775-780 for COM fabric yardage

ARMLESS LEFT CORNER LOUNGE

MODEL NO.

ALLIANCE PROGRAM PRICE GRADES

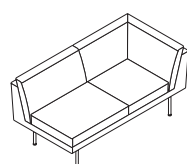

Two Seat

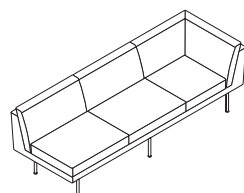

Three Seat

			A	B	C	D	E	F	G	H	I
			J	K	L	M	N	O	P	Q	R
K89C2LXATB	Two Seat	\$	3889	4092	4252	4413	4580	4784	4900	5118	5301
			5490	5796	6408	6793	6873	6946	7040	7136	7557
K89C3LXATB	Three Seat		5202	5469	5680	5890	6110	6378	6532	6817	7057
			7305	7706	8510	9015	9122	9217	9341	9466	10019

DIMENSIONS - TWO SEAT

Width	57 ¹ / ₆	Seat Height	18 ¹ / ₂	Weight	135
Depth	29 ³ / ₄	Seat Depth	20 ¹ / ₆	Cubic Ft.	37.00
Height	29 ¹ / ₆	Seat Width	47 ¹ / ₆		

DIMENSIONS - THREE SEAT

Width	84 ¹ / ₂	Seat Height	18 ¹ / ₂	Weight	182
Depth	29 ³ / ₄	Seat Depth	20 ¹ / ₆	Cubic Ft.	55.00
Height	29 ¹ / ₆	Seat Width	74 ³ / ₄		

- Contrasting fabric option – specify X (i.e., K89C2LXATBX); see page 742. For list pricing, use your electronic specification tool or contact customer service
- Weight Limit 253 lbs.
- Tight-back
- Clean out
- 2mm tubular metal legs
- Non-skid, adjustable glides

WHITTAKER HEALTH

TO ORDER, SPECIFY:

1. Model Number
2. Inner Back Upholstery Grade
3. Inner Back Upholstery Number
4. Outer Back Upholstery Grade
5. Outer Back Upholstery Number
6. Seat Upholstery Grade
7. Seat Upholstery Number
8. Arm Upholstery Grade
9. Arm Upholstery Number
10. Front Panel/Accent Upholstery Grade
11. Front Panel/Accent Upholstery Number
12. Leg Metal Finish Designator
13. Arm Cap Finish or Color Designator (if applicable)
14. Moisture Barrier Optional for Seat, or Seat and Inside Back

- See page 741 for Whittaker Health options
- See pages 775-780 for COM fabric yardage

TWO SEAT LEFT CORNER CONVENIENCE ARM ON RIGHT LOUNGE

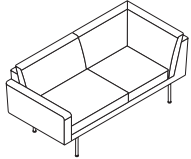

No Arm Cap

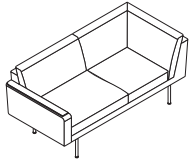

Arm Cap

MODEL NO.

ALLIANCE PROGRAM PRICE GRADES

			A	B	C	D	E	F	G	H	I
			J	K	L	M	N	O	P	Q	R
K89C2LCVAUTB	No Arm Cap	\$	4341	4580	4768	4957	5154	5393	5530	5786	6001
			6224	6583	7303	7756	7850	7936	8046	8159	8654
K89C2LCVAACWTB	Wood Arm Cap		4386	4625	4813	5002	5199	5438	5575	5831	6046
			6269	6628	7348	7801	7895	7981	8091	8204	8699
K89C2LCVAACPTB	Polyurethane Arm Cap		4412	4651	4839	5028	5225	5464	5601	5857	6072
			6295	6654	7374	7827	7921	8007	8117	8230	8725
K89C2LCVAACCTB	3D Laminate Arm Cap		4512	4751	4939	5128	5325	5564	5701	5957	6172
			6395	6754	7474	7927	8021	8107	8217	8330	8825
K89C2LCVAACSTB	Solid Surface Arm Cap		4691	4930	5118	5307	5504	5743	5880	6136	6351
			6574	6933	7653	8106	8200	8286	8396	8509	9004

DIMENSIONS

Width	62 $\frac{1}{2}$	Seat Height	18 $\frac{1}{2}$	Arm Height		Weight	142
Depth	29 $\frac{3}{4}$	Seat Depth	20 $\frac{1}{2}$	No Arm Cap	22 $\frac{1}{2}$	Cubic Ft.	40.00
Height	29 $\frac{3}{8}$	Seat Width	25 $\frac{1}{2}$	Arm Cap	22 $\frac{1}{2}$		
				Arm Width	3 $\frac{1}{2}$		

- Contrasting fabric option – specify X (i.e., K89C2LCVAUTBX); see page 742. For list pricing, use your electronic specification tool or contact customer service
- Weight Limit 253 lbs.
- Tight-back
- Clean out
- 2mm tubular metal legs
- Non-skid, adjustable glides
- Arm caps on applicable models

THREE SEAT LEFT CORNER CONVENIENCE ARM ON RIGHT LOUNGE

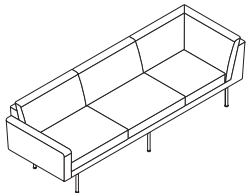

No Arm Cap

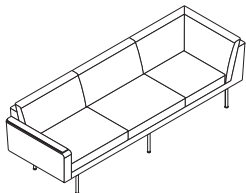

Arm Cap

			A	B	C	D	E	F	G	H	I
			J	K	L	M	N	O	P	Q	R
K89C3LCVAUTB	No Arm Cap	\$	5653	5956	6195	6433	6683	6986	7161	7484	7756
			8038	8492	9404	9977	10098	10206	10346	10488	11115
K89C3LCVAACWTB	Wood Arm Cap		5697	6000	6239	6477	6727	7030	7205	7528	7800
			8082	8536	9448	10021	10142	10250	10390	10532	11159
K89C3LCVAACPTB	Polyurethane Arm Cap		5723	6026	6265	6503	6753	7056	7231	7554	7826
			8108	8562	9474	10047	10168	10276	10416	10558	11185
K89C3LCVAACCTB	3D Laminate Arm Cap		5824	6127	6366	6604	6854	7157	7332	7655	7927
			8209	8663	9575	10148	10269	10377	10517	10659	11286
K89C3LCVAACSTB	Solid Surface Arm Cap		6002	6305	6544	6782	7032	7335	7510	7833	8105
			8387	8841	9753	10326	10447	10555	10695	10837	11464

DIMENSIONS

Width	88	Seat Height	18 $\frac{1}{2}$	Arm Height		Weight	190
Depth	29 $\frac{3}{4}$	Seat Depth	20 $\frac{1}{2}$	No Arm Cap	22 $\frac{1}{2}$	Cubic Ft.	57.00
Height	29 $\frac{3}{8}$	Seat Width	74 $\frac{1}{4}$	Arm Cap	22 $\frac{1}{2}$		
				Arm Width	3 $\frac{1}{2}$		

- Contrasting fabric option – specify X (i.e., K89C3LCVAUTBX); see page 742. For list pricing, use your electronic specification tool or contact customer service
- Weight Limit 253 lbs.
- Tight-back
- Clean out
- 2mm tubular metal legs
- Non-skid, adjustable glides
- Arm caps on applicable models

TO ORDER, SPECIFY:

1. Model Number
2. Inner Back Upholstery Grade
3. Inner Back Upholstery Number
4. Outer Back Upholstery Grade
5. Outer Back Upholstery Number
6. Seat Upholstery Grade
7. Seat Upholstery Number
8. Arm Upholstery Grade
9. Arm Upholstery Number
10. Front Panel/Accent Upholstery Grade
11. Front Panel/Accent Upholstery Number
12. Leg Metal Finish Designator
13. Moisture Barrier Optional for Seat, or Seat and Inside Back

- See page 741 for Whittaker Health options
- See pages 775-780 for COM fabric yardage

**FULL ARM ON RIGHT
LEFT CORNER LOUNGE**

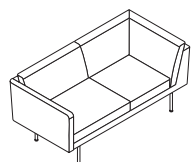

Two Seat

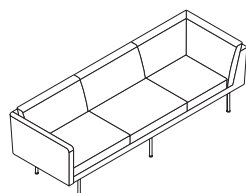

Three Seat

**MODEL
NO.**

ALLIANCE PROGRAM PRICE GRADES

		A	B	C	D	E	F	G	H	I
		J	K	L	M	N	O	P	Q	R
K89C2LFATB	Two Seat	\$ 4345	4588	4779	4971	5171	5415	5553	5814	6032
		6258	6624	7355	7816	7911	7998	8111	8225	8729
K89C3LFATB	Three Seat	5657	5964	6206	6447	6700	7008	7184	7512	7787
		8072	8533	9456	10037	10159	10268	10411	10554	11190

DIMENSIONS - TWO SEAT

Width	59½	Seat Height	18½	Arm Height	26½	Weight	142
Depth	29¾	Seat Depth	20½	Arm Width	2	Cubic Ft.	39.00
Height	29⅜	Seat Width	47½				

DIMENSIONS - THREE SEAT

Width	86½	Seat Height	18½	Arm Height	26½	Weight	190
Depth	29¾	Seat Depth	20½	Arm Width	2	Cubic Ft.	56.00
Height	29⅜	Seat Width	74¾				

- Contrasting fabric option – specify X (i.e., K89C2LFATBX); see page 742. For list pricing, use your electronic specification tool or contact customer service
- Weight Limit 253 lbs.
- Tight-back
- Clean out
- 2mm tubular metal legs
- Non-skid, adjustable glides

**THREE SEAT LEFT CORNER,
INTERIOR ARM ON RIGHT
LOUNGE**

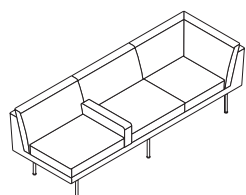

		A	B	C	D	E	F	G	H	I
		J	K	L	M	N	O	P	Q	R
K89C3LXAIRTB	Three Seat	\$ 5093	5394	5632	5868	6116	6419	6592	6914	7184
		7464	7916	8823	9392	9513	9620	9760	9901	10524

DIMENSIONS

Width	84½	Seat Height	18½	Arm Height	22½	Weight	189
Depth	29¾	Seat Depth	20½	Arm Width	3½	Cubic Ft.	55.00
Height	29⅜	Seat Width	25⅜				

- Contrasting fabric option – specify X (i.e., K89C3LXAIRTBX); see page 742. For list pricing, use your electronic specification tool or contact customer service
- Weight Limit 253 lbs.
- Tight-back
- Clean out
- 2mm tubular metal legs
- Non-skid, adjustable glides

WHITTAKER HEALTH

TO ORDER, SPECIFY:

1. Model Number
2. Inner Back Upholstery Grade
3. Inner Back Upholstery Number
4. Outer Back Upholstery Grade
5. Outer Back Upholstery Number
6. Seat Upholstery Grade
7. Seat Upholstery Number
8. Arm Upholstery Grade
9. Arm Upholstery Number
10. Front Panel/Accent Upholstery Grade
11. Front Panel/Accent Upholstery Number
12. Leg Metal Finish Designator
13. Arm Cap Finish or Color Designator (if applicable)
14. Moisture Barrier Optional for Seat, or Seat and Inside Back

- See page 741 for Whittaker Health options
- See pages 775-780 for COM fabric yardage

THREE SEAT LEFT CORNER, INTERIOR ARM ON RIGHT, CONVENIENCE ARM ON RIGHT LOUNGE

MODEL NO.

ALLIANCE PROGRAM PRICE GRADES

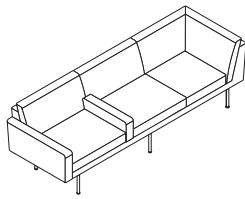

No Arm Caps

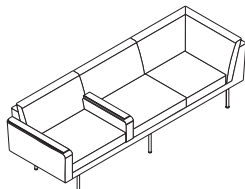

Arm Caps

			A	B	C	D	E	F	G	H	I
			J	K	L	M	N	O	P	Q	R
K89C3LCVAUIRTB	No Arm Caps	\$	5637	5940	6179	6417	6667	6970	7145	7468	7740
			8022	8476	9388	9961	10082	10190	10330	10472	11099
K89C3LCVAACWIRTB	Wood Arm Caps		5696	5999	6238	6476	6726	7029	7204	7527	7799
			8081	8535	9447	10020	10141	10249	10389	10531	11158
K89C3LCVAACPIRTB	Polyurethane Arm Caps		5779	6082	6321	6559	6809	7112	7287	7610	7882
			8164	8618	9530	10103	10224	10332	10472	10614	11241
K89C3LCVAACTIRTB	3D Laminate Arm Caps		5944	6247	6486	6724	6974	7277	7452	7775	8047
			8329	8783	9695	10268	10389	10497	10637	10779	11406
K89C3LCVAACSIRTB	Solid Surface Arm Caps		6334	6637	6876	7114	7364	7667	7842	8165	8437
			8719	9173	10085	10658	10779	10887	11027	11169	11796

DIMENSIONS

Width	88	Seat Height	18 $\frac{1}{2}$	Arm Height		Weight	197
Depth	29 $\frac{3}{4}$	Seat Depth	20 $\frac{1}{4}$	No Arm Cap	22 $\frac{3}{4}$	Cubic Ft.	57.00
Height	29 $\frac{3}{16}$	Seat Width	25 $\frac{1}{16}$	Arm Cap	22 $\frac{1}{16}$		
				Arm Width	3 $\frac{1}{2}$		

- Contrasting fabric option – specify X (i.e., K89C3LCVAUIRTBX); see page 742. For list pricing, use your electronic specification tool or contact customer service
- Weight Limit 253 lbs.
- Tight-back
- Clean out
- 2mm tubular metal legs
- Non-skid, adjustable glides
- Arm caps on applicable models

TO ORDER, SPECIFY:

1. Model Number
2. Inner Back Upholstery Grade
3. Inner Back Upholstery Number
4. Outer Back Upholstery Grade
5. Outer Back Upholstery Number
6. Seat Upholstery Grade
7. Seat Upholstery Number
8. Front Panel/Accent Upholstery Grade
9. Front Panel/Accent Upholstery Number
10. Leg Metal Finish Designator
11. Moisture Barrier Optional for Seat, or Seat and Inside Back

- See page 741 for Whittaker Health options
- See pages 775-780 for COM fabric yardage

ARMLESS RIGHT CORNER LOUNGE

MODEL NO.

ALLIANCE PROGRAM PRICE GRADES

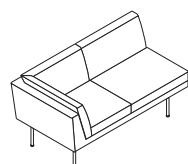

Two Seat

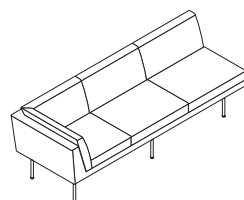

Three Seat

			A	B	C	D	E	F	G	H	I
			J	K	L	M	N	O	P	Q	R
K89C2RXATB	Two Seat	\$	3889	4092	4252	4413	4580	4784	4900	5118	5301
			5490	5796	6408	6793	6873	6946	7040	7136	7557
K89C3RXATB	Three Seat		5202	5469	5680	5890	6110	6378	6532	6817	7057
			7305	7706	8510	9015	9122	9217	9341	9466	10019

DIMENSIONS - TWO SEAT

Width	57 ¹ / ₆	Seat Height	18 ¹ / ₂	Weight	135
Depth	29 ³ / ₄	Seat Depth	20 ¹ / ₆	Cubic Ft.	37.00
Height	29 ¹ / ₆	Seat Width	47 ¹ / ₆		

DIMENSIONS - THREE SEAT

Width	84 ¹ / ₂	Seat Height	18 ¹ / ₂	Weight	182
Depth	29 ³ / ₄	Seat Depth	20 ¹ / ₆	Cubic Ft.	55.00
Height	29 ¹ / ₆	Seat Width	74 ³ / ₄		

- Contrasting fabric option – specify X (i.e., K89C2RXATBX); see page 742. For list pricing, use your electronic specification tool or contact customer service
- Weight Limit 253 lbs.
- Tight-back
- Clean out
- 2mm tubular metal legs
- Non-skid, adjustable glides

WHITTAKER HEALTH

WHITTAKER HEALTH

TO ORDER, SPECIFY:

1. Model Number
2. Inner Back Upholstery Grade
3. Inner Back Upholstery Number
4. Outer Back Upholstery Grade
5. Outer Back Upholstery Number
6. Seat Upholstery Grade
7. Seat Upholstery Number
8. Arm Upholstery Grade
9. Arm Upholstery Number
10. Front Panel/Accent Upholstery Grade
11. Front Panel/Accent Upholstery Number
12. Leg Metal Finish Designator
13. Arm Cap Finish or Color Designator (if applicable)
14. Moisture Barrier Optional for Seat, or Seat and Inside Back

- See page 741 for Whittaker Health options
- See pages 775-780 for COM fabric yardage

TWO SEAT RIGHT CORNER CONVENIENCE ARM ON LEFT LOUNGE

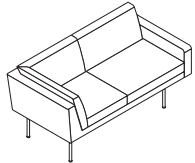

No Arm Cap

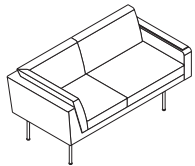

Arm Cap

MODEL NO.

ALLIANCE PROGRAM PRICE GRADES

			A	B	C	D	E	F	G	H	I
			J	K	L	M	N	O	P	Q	R
K89C2RCVAUTB	No Arm Cap	\$	4341	4580	4768	4957	5154	5393	5530	5786	6001
			6224	6583	7303	7756	7850	7936	8046	8159	8654
K89C2RCVAACWTB	Wood Arm Cap		4386	4625	4813	5002	5199	5438	5575	5831	6046
			6269	6628	7348	7801	7895	7981	8091	8204	8699
K89C2RCVAACPTB	Polyurethane Arm Cap		4412	4651	4839	5028	5225	5464	5601	5857	6072
			6295	6654	7374	7827	7921	8007	8117	8230	8725
K89C2RCVAACCTB	3D Laminate Arm Cap		4512	4751	4939	5128	5325	5564	5701	5957	6172
			6395	6754	7474	7927	8021	8107	8217	8330	8825
K89C2RCVAACSTB	Solid Surface Arm Cap		4691	4930	5118	5307	5504	5743	5880	6136	6351
			6574	6933	7653	8106	8200	8286	8396	8509	9004

DIMENSIONS

Width	62 $\frac{1}{2}$	Seat Height	18 $\frac{1}{2}$	Arm Height		Weight	142
Depth	29 $\frac{3}{4}$	Seat Depth	20 $\frac{1}{4}$	No Arm Cap	22 $\frac{1}{4}$	Cubic Ft.	40.00
Height	29 $\frac{3}{8}$	Seat Width	47 $\frac{1}{4}$	Arm Cap	22 $\frac{1}{4}$		
				Arm Width	3 $\frac{1}{2}$		

- Contrasting fabric option – specify X (i.e., K89C2RCVAUTBX); see page 742. For list pricing, use your electronic specification tool or contact customer service
- Weight Limit 253 lbs.
- Tight-back
- Clean out
- 2mm tubular metal legs
- Non-skid, adjustable glides
- Arm caps on applicable models

THREE SEAT RIGHT CORNER CONVENIENCE ARM ON LEFT LOUNGE

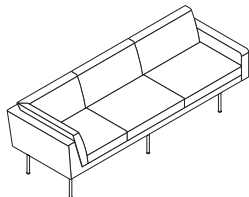

No Arm Cap

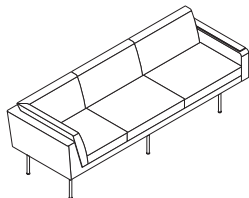

Arm Cap

			A	B	C	D	E	F	G	H	I
			J	K	L	M	N	O	P	Q	R
K89C3RCVAUTB	No Arm Cap	\$	5653	5956	6195	6433	6683	6986	7161	7484	7756
			8038	8492	9404	9977	10098	10206	10346	10488	11115
K89C3RCVAACWTB	Wood Arm Cap		5697	6000	6239	6477	6727	7030	7205	7528	7800
			8082	8536	9448	10021	10142	10250	10390	10532	11159
K89C3RCVAACPTB	Polyurethane Arm Cap		5723	6026	6265	6503	6753	7056	7231	7554	7826
			8108	8562	9474	10047	10168	10276	10416	10558	11185
K89C3RCVAACCTB	3D Laminate Arm Cap		5824	6127	6366	6604	6854	7157	7332	7655	7927
			8209	8663	9575	10148	10269	10377	10517	10659	11286
K89C3RCVAACSTB	Solid Surface Arm Cap		6002	6305	6544	6782	7032	7335	7510	7833	8105
			8387	8841	9753	10326	10447	10555	10695	10837	11464

DIMENSIONS

Width	88	Seat Height	18 $\frac{1}{2}$	Arm Height		Weight	190
Depth	29 $\frac{3}{4}$	Seat Depth	20 $\frac{1}{4}$	No Arm Cap	22 $\frac{1}{4}$	Cubic Ft.	57.00
Height	29 $\frac{3}{8}$	Seat Width	74 $\frac{1}{4}$	Arm Cap	22 $\frac{1}{4}$		
				Arm Width	3 $\frac{1}{2}$		

- Contrasting fabric option – specify X (i.e., K89C3RCVAUTBX); see page 742. For list pricing, use your electronic specification tool or contact customer service
- Weight Limit 253 lbs.
- Tight-back
- Clean out
- 2mm tubular metal legs
- Non-skid, adjustable glides
- Arm caps on applicable models

TO ORDER, SPECIFY:

1. Model Number
2. Inner Back Upholstery Grade
3. Inner Back Upholstery Number
4. Outer Back Upholstery Grade
5. Outer Back Upholstery Number
6. Seat Upholstery Grade
7. Seat Upholstery Number
8. Arm Upholstery Grade
9. Arm Upholstery Number
10. Front Panel/Accent Upholstery Grade
11. Front Panel/Accent Upholstery Number
12. Leg Metal Finish Designator
13. Moisture Barrier Optional for Seat, or Seat and Inside Back

- See page 741 for Whittaker Health options
- See pages 775-780 for COM fabric yardage

FULL ARM ON LEFT RIGHT CORNER LOUNGE

MODEL NO.

ALLIANCE PROGRAM PRICE GRADES

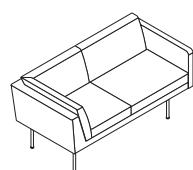

Two Seat

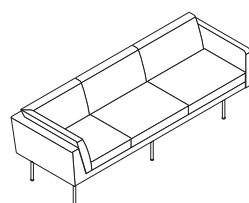

Three Seat

		A	B	C	D	E	F	G	H	I
		J	K	L	M	N	O	P	Q	R
K89C2RFATB	Two Seat	\$ 4345	4588	4779	4971	5171	5415	5553	5814	6032
		6258	6624	7355	7816	7911	7998	8111	8225	8729
K89C3RFATB	Three Seat	5657	5964	6206	6447	6700	7008	7184	7512	7787
		8072	8533	9456	10037	10159	10268	10411	10554	11190

DIMENSIONS - TWO SEAT

Width	59½	Seat Height	18½	Arm Height	26½	Weight	142
Depth	29¾	Seat Depth	20½	Arm Width	2	Cubic Ft.	39.00
Height	29⅓	Seat Width	47½				

DIMENSIONS - THREE SEAT

Width	86½	Seat Height	18½	Arm Height	26½	Weight	190
Depth	29¾	Seat Depth	20½	Arm Width	2	Cubic Ft.	56.00
Height	29⅓	Seat Width	74¾				

- Contrasting fabric option – specify X (i.e., K89C2RFATBX); see page 742. For list pricing, use your electronic specification tool or contact customer service
- Weight Limit 253 lbs.
- Tight-back
- Clean out
- 2mm tubular metal legs
- Non-skid, adjustable glides

TO ORDER, SPECIFY:

1. Model Number
2. Inner Back Upholstery Grade
3. Inner Back Upholstery Number
4. Outer Back Upholstery Grade
5. Outer Back Upholstery Number
6. Seat Upholstery Grade
7. Seat Upholstery Number
8. Arm Upholstery Grade
9. Arm Upholstery Number
10. Front Panel/Accent Upholstery Grade
11. Front Panel/Accent Upholstery Number
12. Leg Metal Finish Designator
13. Moisture Barrier Optional for Seat, or Seat and Inside Back

- See page 741 for Whittaker Health options
- See pages 775-780 for COM fabric yardage

THREE SEAT RIGHT CORNER, INTERIOR ARM ON LEFT LOUNGE

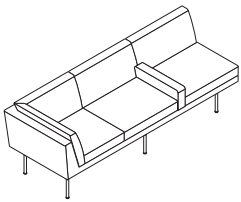

MODEL NO.

ALLIANCE PROGRAM PRICE GRADES

		A	B	C	D	E	F	G	H	I
		J	K	L	M	N	O	P	Q	R
K89C3RXAILTB	Three Seat	\$ 5093	5394	5632	5868	6116	6419	6592	6914	7184
		7464	7916	8823	9392	9513	9620	9760	9901	10524

DIMENSIONS

Width	84½	Seat Height	18¾	Arm Height	22¾	Weight	189
Depth	29¾	Seat Depth	20¾	Arm Width	3½	Cubic Ft.	55.00
Height	29¾	Seat Width	25¾				

- Contrasting fabric option – specify X (i.e., K89C3RXAILTBX); see page 742. For list pricing, use your electronic specification tool or contact customer service
- Weight Limit 253 lbs.
- Tight-back
- Clean out
- 2mm tubular metal legs
- Non-skid, adjustable glides

TO ORDER, SPECIFY:

1. Model Number
2. Inner Back Upholstery Grade
3. Inner Back Upholstery Number
4. Outer Back Upholstery Grade
5. Outer Back Upholstery Number
6. Seat Upholstery Grade
7. Seat Upholstery Number
8. Arm Upholstery Grade
9. Arm Upholstery Number
10. Front Panel/Accent Upholstery Grade
11. Front Panel/Accent Upholstery Number
12. Leg Metal Finish Designator
13. Arm Cap Finish or Color Designator (if applicable)
14. Moisture Barrier Optional for Seat, or Seat and Inside Back

- See page 741 for Whittaker Health options
- See pages 775-780 for COM fabric yardage

THREE SEAT RIGHT CORNER, INTERIOR ARM ON LEFT, CONVENIENCE ARM ON LEFT LOUNGE

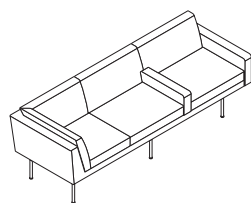

No Arm Caps

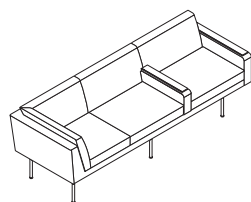

Arm Caps

MODEL NO.

ALLIANCE PROGRAM PRICE GRADES

			A	B	C	D	E	F	G	H	I
			J	K	L	M	N	O	P	Q	R
K89C3RCVAUILTB	No Arm Caps	\$	5637	5940	6179	6417	6667	6970	7145	7468	7740
			8022	8476	9388	9961	10082	10190	10330	10472	11099
K89C3RCVAACWILTB	Wood Arm Caps		5696	5999	6238	6476	6726	7029	7204	7527	7799
			8081	8535	9447	10020	10141	10249	10389	10531	11158
K89C3RCVAACPILTB	Polyurethane Arm Caps		5779	6082	6321	6559	6809	7112	7287	7610	7882
			8164	8618	9530	10103	10224	10332	10472	10614	11241
K89C3RCVAACTILTB	3D Laminate Arm Caps		5944	6247	6486	6724	6974	7277	7452	7775	8047
			8329	8783	9695	10268	10389	10497	10637	10779	11406
K89C3RCVAACSILTB	Solid Surface Arm Caps		6334	6637	6876	7114	7364	7667	7842	8165	8437
			8719	9173	10085	10658	10779	10887	11027	11169	11796

DIMENSIONS

Width	88	Seat Height	18 ⁵ / ₁₆	Arm Height		Weight	197
Depth	29 ³ / ₁₆	Seat Depth	20 ¹ / ₁₆	No Arm Cap	22 ³ / ₁₆	Cubic Ft.	57.00
Height	29 ¹³ / ₁₆	Seat Width	25 ¹³ / ₁₆	Arm Cap	22 ¹ / ₁₆		
				Arm Width	3 ¹ / ₂		

- Contrasting fabric option – specify X (i.e., K89C3RCVAUILTBX); see page 742. For list pricing, use your electronic specification tool or contact customer service
- Weight Limit 253 lbs.
- Tight-back
- Clean out
- 2mm tubular metal legs
- Non-skid, adjustable glides
- Arm caps on applicable models

WHITTAKER HEALTH

WHITTAKER HEALTH

TO ORDER, SPECIFY:

1. Model Number
2. Inner Back Upholstery Grade
3. Inner Back Upholstery Number
4. Outer Back Upholstery Grade
5. Outer Back Upholstery Number
6. Seat Upholstery Grade
7. Seat Upholstery Number
8. Front Panel/Accent Upholstery Grade
9. Front Panel/Accent Upholstery Number
10. Leg Metal Finish Designator
11. Moisture Barrier Optional for Seat, or Seat and Inside Back

- See page 741 for Whittaker Health options
- See pages 775-780 for COM fabric yardage

TWO SEAT ARMLESS, PENINSULA LOUNGE

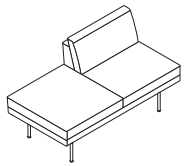

Back on Left Side

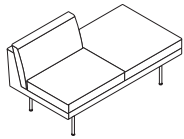

Back on Right Side

MODEL NO.

ALLIANCE PROGRAM PRICE GRADES

			A	B	C	D	E	F	G	H	I
			J	K	L	M	N	O	P	Q	R
K89PE2LTB	Back on Left Side	\$	3391	3545	3667	3786	3914	4068	4157	4322	4460
			4604	4836	5300	5592	5653	5708	5780	5852	6171
K89PE2RTB	Back on Right Side		3391	3545	3667	3786	3914	4068	4157	4322	4460
			4604	4836	5300	5592	5653	5708	5780	5852	6171

DIMENSIONS

Width	55½	Seat Height	18½	Weight	107
Depth	29¾	Seat Depth	20½	Cubic Ft.	36.00
Height	29¾	Seat Width	55½		

- Contrasting fabric option – specify X (i.e., K89PE2LTBX); see page 742. For list pricing, use your electronic specification tool or contact customer service
- Weight Limit 253 lbs.
- Tight-back
- Clean out
- 2mm tubular metal legs
- Non-skid, adjustable glides

THREE SEAT ARMLESS, PENINSULA LOUNGE

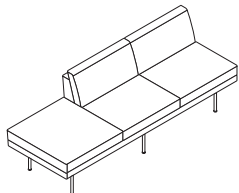

Back on Left Side

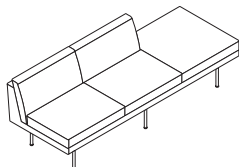

Back on Right Side

			A	B	C	D	E	F	G	H	I
			J	K	L	M	N	O	P	Q	R
K89PE3LTB	Back on Left Side	\$	4635	4858	5033	5209	5391	5615	5742	5981	6181
			6388	6723	7392	7814	7902	7982	8085	8189	8652
K89PE3RTB	Back on Right Side		4635	4858	5033	5209	5391	5615	5742	5981	6181
			6388	6723	7392	7814	7902	7982	8085	8189	8652

DIMENSIONS

Width	82½	Seat Height	18½	Weight	181
Depth	29¾	Seat Depth	20½	Cubic Ft.	53.00
Height	29¾	Seat Width	82½		

- Contrasting fabric option – specify X (i.e., K89PE3LTBX); see page 742. For list pricing, use your electronic specification tool or contact customer service
- Weight Limit 253 lbs.
- Tight-back
- Clean out
- 2mm tubular metal legs
- Non-skid, adjustable glides

TO ORDER, SPECIFY:

- 1. Model Number
- 2. Inner Back Upholstery Grade
- 3. Inner Back Upholstery Number
- 4. Outer Back Upholstery Grade
- 5. Outer Back Upholstery Number
- 6. Seat Upholstery Grade
- 7. Seat Upholstery Number
- 8. Arm Upholstery Grade
- 9. Arm Upholstery Number
- 10. Front Panel/Accent Upholstery Grade
- 11. Front Panel/Accent Upholstery Number
- 12. Leg Metal Finish Designator
- 13. Arm Cap Finish or Color Designator (if applicable)
- 14. Moisture Barrier Optional for Seat, or Seat and Inside Back

- See page 741 for Whittaker Health options
- See pages 775-780 for COM fabric yardage

TWO SEAT BACK AND CONVENIENCE ARM ON LEFT, PENINSULA LOUNGE

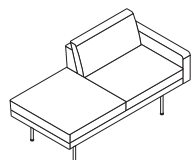

No Arm Cap

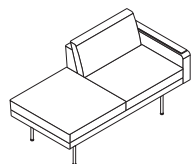

Arm Cap

MODEL NO.

ALLIANCE PROGRAM PRICE GRADES

		A	B	C	D	E	F	G	H	I
		J	K	L	M	N	O	P	Q	R
K89PE2RCVARUTB	No Arm Cap	\$ 3937	4127	4277	4424	4582	4771	4881	5084	5254
		5432	5717	6289	6649	6724	6792	6880	6969	7362
K89PE2RCVARACWTB	Wood Arm Cap	3981	4171	4321	4468	4626	4815	4925	5128	5298
		5476	5761	6333	6693	6768	6836	6924	7013	7406
K89PE2RCVARACPTB	Polyurethane Arm Cap	4007	4197	4347	4494	4652	4841	4951	5154	5324
		5502	5787	6359	6719	6794	6862	6950	7039	7432
K89PE2RCVARACTTB	3D Laminate Arm Cap	4107	4297	4447	4594	4752	4941	5051	5254	5424
		5602	5887	6459	6819	6894	6962	7050	7139	7532
K89PE2RCVARACSTB	Solid Surface Arm Cap	4287	4477	4627	4774	4932	5121	5231	5434	5604
		5782	6067	6639	6999	7074	7142	7230	7319	7712

DIMENSIONS

Width	58%	Seat Height	18%	Arm Height		Weight	115
Depth	29%	Seat Depth	20 ³ / ₁₆	No Arm Cap	22 ³ / ₁₆	Cubic Ft.	38.00
Height	29 ¹³ / ₁₆	Seat Width	55%	Arm Cap	22 ¹ / ₁₆		
				Arm Width	3 ¹ / ₂		

- Contrasting fabric option – specify X (i.e., K89PE2RCVARUTBX); see page 742. For list pricing, use your electronic specification tool or contact customer service
- Weight Limit 253 lbs.
- Tight-back
- Clean out
- 2mm tubular metal legs
- Non-skid, adjustable glides
- Arm cap on applicable models

THREE SEAT BACK AND CONVENIENCE ARM ON LEFT, PENINSULA LOUNGE

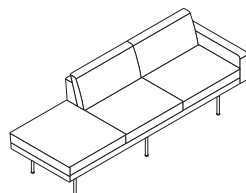

No Arm Cap

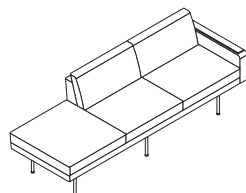

Arm Cap

		A	B	C	D	E	F	G	H	I
		J	K	L	M	N	O	P	Q	R
K89PE3RCVARUTB	No Arm Cap	\$ 5015	5274	5477	5681	5893	6152	6300	6577	6809
		7050	7438	8215	8705	8807	8900	9019	9140	9677
K89PE3RCVARACWTB	Wood Arm Cap	5186	5445	5648	5852	6064	6323	6471	6748	6980
		7221	7609	8386	8876	8978	9071	9190	9311	9848
K89PE3RCVARACPTB	Polyurethane Arm Cap	5309	5568	5771	5975	6187	6446	6594	6871	7103
		7344	7732	8509	8999	9101	9194	9313	9434	9971
K89PE3RCVARACTTB	3D Laminate Arm Cap	5411	5670	5873	6077	6289	6548	6696	6973	7205
		7446	7834	8611	9101	9203	9296	9415	9536	10073
K89PE3RCVARACSTB	Solid Surface Arm Cap	5588	5847	6050	6254	6466	6725	6873	7150	7382
		7623	8011	8788	9278	9380	9473	9592	9713	10250

DIMENSIONS

Width	88	Seat Height	18%	Arm Height		Weight	188
Depth	29%	Seat Depth	20 ³ / ₁₆	No Arm Cap	22 ³ / ₁₆	Cubic Ft.	56.00
Height	29 ¹³ / ₁₆	Seat Width	25 ³ / ₁₆	Arm Cap	22 ¹ / ₁₆		
				Arm Width	3 ¹ / ₂		

- Contrasting fabric option – specify X (i.e., K89PE3RCVARUTBX); see page 742. For list pricing, use your electronic specification tool or contact customer service
- Weight Limit 253 lbs.
- Tight-back
- Clean out
- 2mm tubular metal legs
- Non-skid, adjustable glides
- Arm cap on applicable models

TO ORDER, SPECIFY:

- 1. Model Number
- 2. Inner Back Upholstery Grade
- 3. Inner Back Upholstery Number
- 4. Outer Back Upholstery Grade
- 5. Outer Back Upholstery Number
- 6. Seat Upholstery Grade
- 7. Seat Upholstery Number
- 8. Arm Upholstery Grade
- 9. Arm Upholstery Number
- 10. Front Panel/Accent Upholstery Grade
- 11. Front Panel/Accent Upholstery Number
- 12. Leg Metal Finish Designator
- 13. Arm Cap Finish or Color Designator (if applicable)
- 14. Moisture Barrier Optional for Seat, or Seat and Inside Back

- See page 741 for Whittaker Health options
- See pages 775-780 for COM fabric yardage

TWO SEAT BACK AND CONVENIENCE ARM ON RIGHT, PENINSULA LOUNGE

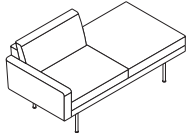

No Arm Cap

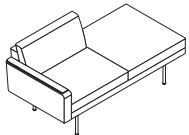

Arm Cap

MODEL NO.

ALLIANCE PROGRAM PRICE GRADES

		A	B	C	D	E	F	G	H	I
		J	K	L	M	N	O	P	Q	R
K89PE2LCVALUTB	No Arm Cap	\$ 3937	4127	4277	4424	4582	4771	4881	5084	5254
		5432	5717	6289	6649	6724	6792	6880	6969	7362
K89PE2LCVALACWTB	Wood Arm Cap	3981	4171	4321	4468	4626	4815	4925	5128	5298
		5476	5761	6333	6693	6768	6836	6924	7013	7406
K89PE2LCVALACPTB	Polyurethane Arm Cap	4007	4197	4347	4494	4652	4841	4951	5154	5324
		5502	5787	6359	6719	6794	6862	6950	7039	7432
K89PE2LCVALACTTB	3D Laminate Arm Cap	4107	4297	4447	4594	4752	4941	5051	5254	5424
		5602	5887	6459	6819	6894	6962	7050	7139	7532
K89PE2LCVALACSTB	Solid Surface Arm Cap	4287	4477	4627	4774	4932	5121	5231	5434	5604
		5782	6067	6639	6999	7074	7142	7230	7319	7712

DIMENSIONS

Width	58%	Seat Height	18%	Arm Height		Weight	115
Depth	29%	Seat Depth	20%	No Arm Cap	22 ³ / ₁₆	Cubic Ft.	38.00
Height	29 ³ / ₁₆	Seat Width	55%	Arm Cap	22 ¹ / ₁₆		
				Arm Width	3 ¹ / ₂		

- Contrasting fabric option – specify X (i.e., K89PE2LCVALUTBX); see page 742. For list pricing, use your electronic specification tool or contact customer service
- Weight Limit 253 lbs.
- Tight-back
- Clean out
- 2mm tubular metal legs
- Non-skid, adjustable glides
- Arm cap on applicable models

THREE SEAT BACK AND CONVENIENCE ARM ON RIGHT, PENINSULA LOUNGE

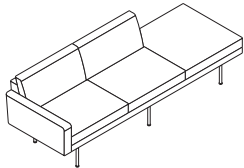

No Arm Cap

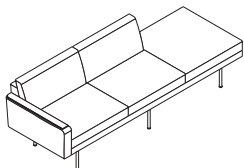

Arm Cap

		A	B	C	D	E	F	G	H	I
		J	K	L	M	N	O	P	Q	R
K89PE3LCVALUTB	No Arm Cap	\$ 5015	5274	5477	5681	5893	6152	6300	6577	6809
		7050	7438	8215	8705	8807	8900	9019	9140	9677
K89PE3LCVALACWTB	Wood Arm Cap	5186	5445	5648	5852	6064	6323	6471	6748	6980
		7221	7609	8386	8876	8978	9071	9190	9311	9848
K89PE3LCVALACPTB	Polyurethane Arm Cap	5309	5568	5771	5975	6187	6446	6594	6871	7103
		7344	7732	8509	8999	9101	9194	9313	9434	9971
K89PE3LCVALACTTB	3D Laminate Arm Cap	5411	5670	5873	6077	6289	6548	6696	6973	7205
		7446	7834	8611	9101	9203	9296	9415	9536	10073
K89PE3LCVALACSTB	Solid Surface Arm Cap	5588	5847	6050	6254	6466	6725	6873	7150	7382
		7623	8011	8788	9278	9380	9473	9592	9713	10250

DIMENSIONS

Width	88	Seat Height	18%	Arm Height		Weight	188
Depth	29%	Seat Depth	20%	No Arm Cap	22 ³ / ₁₆	Cubic Ft.	56.00
Height	29 ³ / ₁₆	Seat Width	25%	Arm Cap	22 ¹ / ₁₆		
				Arm Width	3 ¹ / ₂		

- Contrasting fabric option – specify X (i.e., K89PE3LCVALUTBX); see page 742. For list pricing, use your electronic specification tool or contact customer service
- Weight Limit 253 lbs.
- Tight-back
- Clean out
- 2mm tubular metal legs
- Non-skid, adjustable glides
- Arm cap on applicable models

TO ORDER, SPECIFY:

1. Model Number
2. Inner Back Upholstery Grade
3. Inner Back Upholstery Number
4. Outer Back Upholstery Grade
5. Outer Back Upholstery Number
6. Seat Upholstery Grade
7. Seat Upholstery Number
8. Arm Upholstery Grade
9. Arm Upholstery Number
10. Front Panel/Accent Upholstery Grade
11. Front Panel/Accent Upholstery Number
12. Leg Metal Finish Designator
13. Moisture Barrier Optional for Seat, or Seat and Inside Back

- See page 741 for Whittaker Health options
- See pages 775-780 for COM fabric yardage

THREE SEAT INTERIOR ARM, PENINSULA LOUNGE

MODEL NO. ALLIANCE PROGRAM PRICE GRADES

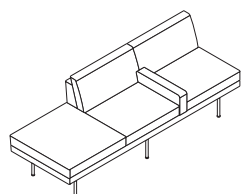

Back on Left Side

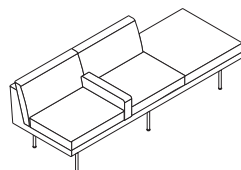

Back on Right Side

			A	B	C	D	E	F	G	H	I
			J	K	L	M	N	O	P	Q	R
K89PE3LILTB	Back on Left Side	\$	4450	4684	4869	5052	5244	5480	5614	5865	6075
			6292	6645	7348	7791	7884	7968	8077	8186	8673
K89PE3RIRTB	Back on Right Side		4450	4684	4869	5052	5244	5480	5614	5865	6075
			6292	6645	7348	7791	7884	7968	8077	8186	8673

DIMENSIONS

Width	86	Seat Height	18 $\frac{1}{2}$	Weight	188
Depth	29 $\frac{3}{4}$	Seat Depth	20 $\frac{1}{16}$	Cubic Ft.	53.00
Height	29 $\frac{13}{16}$	Seat Width	25 $\frac{13}{16}$		

- Contrasting fabric option – specify X (i.e., K89PE3LILTBX); see page 742. For list pricing, use your electronic specification tool or contact customer service
- Weight Limit 253 lbs.
- Tight-back
- Clean out
- 2mm tubular metal legs
- Non-skid, adjustable glides

WHITTAKER HEALTH

TO ORDER, SPECIFY:

1. Model Number
2. Inner Back Upholstery Grade
3. Inner Back Upholstery Number
4. Outer Back Upholstery Grade
5. Outer Back Upholstery Number
6. Seat Upholstery Grade
7. Seat Upholstery Number
8. Front Panel/Accent Upholstery Grade
9. Front Panel/Accent Upholstery Number
10. Leg Metal Finish Designator
11. Moisture Barrier Optional for Seat, or Seat and Inside Back

- See page 741 for Whittaker Health options
- See pages 775-780 for COM fabric yardage

TWO SEAT CORNERS, PENINSULA LOUNGE

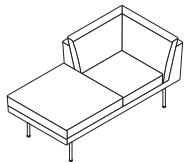

Left Corner

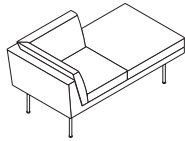

Right Corner

MODEL NO.

ALLIANCE PROGRAM PRICE GRADES

			A	B	C	D	E	F	G	H	I
			J	K	L	M	N	O	P	Q	R
K89CP2LTB	Left Corner	\$	3627	3799	3933	4070	4210	4383	4480	4665	4819
			4977	5236	5751	6077	6144	6205	6286	6365	6722
K89CP2RTB	Right Corner		3627	3799	3933	4070	4210	4383	4480	4665	4819
			4977	5236	5751	6077	6144	6205	6286	6365	6722

DIMENSIONS

Width	57 $\frac{1}{16}$	Seat Height	18 $\frac{1}{16}$	Weight	140
Depth	29 $\frac{3}{16}$	Seat Depth	20 $\frac{1}{16}$	Cubic Ft.	37.00
Height	29 $\frac{13}{16}$	Seat Width	51 $\frac{1}{4}$		

- Contrasting fabric option – specify X (i.e., K89CP2LTBX); see page 742. For list pricing, use your electronic specification tool or contact customer service
- Weight Limit 253 lbs.
- Tight-back
- Clean out
- 2mm tubular metal legs
- Non-skid, adjustable glides

THREE SEAT CORNERS, PENINSULA LOUNGE

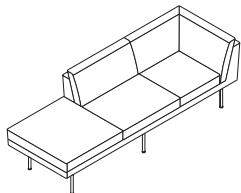

Back on Left Side

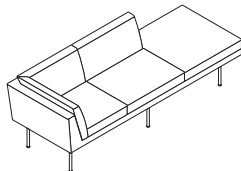

Back on Right Side

			A	B	C	D	E	F	G	H	I
			J	K	L	M	N	O	P	Q	R
K89CP3LTB	Back on Left Side	\$	4700	4937	5124	5312	5507	5746	5881	6136	6349
			6569	6927	7641	8091	8184	8269	8380	8491	8983
K89CP3RTB	Back on Right Side		4700	4937	5124	5312	5507	5746	5881	6136	6349
			6569	6927	7641	8091	8184	8269	8380	8491	8983

DIMENSIONS

Width	84 $\frac{1}{2}$	Seat Height	18 $\frac{1}{16}$	Weight	200
Depth	29 $\frac{3}{16}$	Seat Depth	20 $\frac{1}{16}$	Cubic Ft.	55.00
Height	29 $\frac{13}{16}$	Seat Width	74 $\frac{1}{16}$		

- Contrasting fabric option – specify X (i.e., K89CP3LTBX); see page 742. For list pricing, use your electronic specification tool or contact customer service
- Weight Limit 253 lbs.
- Tight-back
- Clean out
- 2mm tubular metal legs
- Non-skid, adjustable glides

TO ORDER, SPECIFY:

1. Model Number
2. Seat Upholstery Grade
3. Seat Upholstery Number
4. Front Panel/Accent Upholstery Grade
5. Front Panel/Accent Upholstery Number
6. Leg Metal Finish Designator
7. Moisture Barrier Optional for Seat, or Seat and Inside Back

- See page 741 for Whittaker Health options
- See pages 775-780 for COM fabric yardage

BENCHES

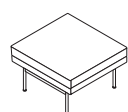

One Seat

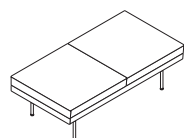

Two Seat

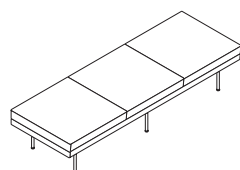

Three Seat

MODEL NO.

ALLIANCE PROGRAM PRICE GRADES

			A	B	C	D	E	F	G	H	I
			J	K	L	M	N	O	P	Q	R
K89BE1	One Seat	\$	1466	1526	1573	1620	1669	1729	1763	1828	1881
			1937	2027	2207	2320	2344	2365	2393	2421	2544
K89BE2	Two Seat		2319	2423	2505	2585	2672	2776	2836	2946	3039
			3137	3293	3605	3802	3843	3881	3928	3977	4193
K89BE3	Three Seat		2939	3085	3199	3313	3432	3577	3660	3816	3946
			4081	4299	4735	5010	5067	5119	5186	5254	5555

DIMENSIONS - ONE SEAT

Width	27½"			Weight	58
Depth	28"			Cubic Ft.	11.00
Height	17"				

DIMENSIONS - TWO SEAT

Width	55"			Weight	96
Depth	28"			Cubic Ft.	21.00
Height	17"				

DIMENSIONS - THREE SEAT

Width	82½"			Weight	140
Depth	28"			Cubic Ft.	31.00
Height	17"				

- Contrasting fabric option – specify X (i.e., K89BE1X); see page 742. For list pricing, use your electronic specification tool or contact customer service
- Weight Limit 253 lbs.
- 2mm tubular metal legs
- Non-skid, adjustable glides

WHITTAKER HEALTH

TO ORDER, SPECIFY:

• See page 741 for Whittaker Health options

1. Model Number

GANGING DEVICE

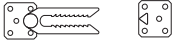

MODEL NO.

LIST PRICE

K82PGB	Ganging Device	\$ 43
--------	----------------	-------

DIMENSIONS

Weight	2
Cubic Ft.	1.00

- Two two-piece ganging devices are required to join two units together

POWER/USB MODULE

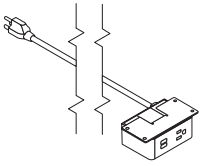

K87EUM	Power/USB Module	\$ 339
--------	------------------	--------

DIMENSIONS

Width	4.05
Depth	2.77
Height	1.69

Weight	2
Cubic Ft.	1.00

- Can be placed under all Whittaker lounge models
- 6' cord with three-prong plug
- 1 power receptacle
- 2 USB ports

COM YARDAGE REQUIREMENTS

COM YARDAGE REQUIREMENTS (54" WIDTH – CUT UP THE ROLL)

MODEL	RAILROADED Contact customer service 800-634-9510 for ydg requirements	NON DIRECTIONAL OR SOLID	1"-4" REPEAT	5"-11" REPEAT	12"-18" REPEAT	COL SQUARE FEET
			4" VERTICAL X 4" HORIZONTAL	11" VERTICAL X 11" HORIZONTAL	18" VERTICAL X 18" HORIZONTAL	
K89L1XATB	Entire Unit	3.50	4.50	5.00	6.00	70.3
	Inner Back	1.30	1.80	2.00	2.50	25.5
	Outer Back	1.20	1.50	2.00	2.80	24.4
	Seat	0.90	1.30	2.00	2.00	18.3
	Accent	0.50	1.00	1.50	2.30	10
K89L2XATB	Entire Unit	5.90	7.50	8.50	9.50	118.4
	Inner Back	2.50	3.00	3.50	4.50	49.3
	Outer Back	1.50	2.00	3.00	4.50	29.9
	Seat	1.80	2.00	3.00	3.00	34.9
	Accent	0.60	1.00	1.80	2.80	11.1
K89L3XATB	Entire Unit	9.10	10.50	12.00	14.00	181
	Inner Back	3.70	4.50	5.00	6.50	73.1
	Outer Back	2.20	3.00	4.00	6.00	43.2
	Seat	2.60	3.00	4.00	3.50	51.5
	Accent	0.80	1.50	2.00	3.30	14.9
K89L1CVALUTB, K89L1CVALACWTB, K89L1CVALACPTB, K89L1CVALACTTB, K89L1CVALACSTB	Entire Unit	4.30	5.00	6.00	7.00	84.7
	Inner Back	1.30	1.80	2.00	2.50	25.5
	Outer Back	1.20	1.50	2.00	2.80	24.4
	Seat	0.90	1.30	2.00	2.00	18.3
	Arm	1.40	1.50	1.80	2.50	28.2
	Accent	0.50	1.00	1.50	2.30	10
K89L2CVALUTB, K89L2CVALACWTB, K89L2CVALACPTB, K89L2CVALACTTB, K89L2CVALACSTB	Entire Unit	6.60	8.00	9.00	10.50	132.3
	Inner Back	2.50	3.00	3.50	4.50	49.3
	Outer Back	1.50	2.00	3.00	4.50	29.9
	Seat	1.80	2.00	3.00	3.00	34.9
	Arm	1.30	1.50	1.80	2.50	25.5
	Accent	0.60	1.00	1.80	2.80	11.1
K89L3CVALUTB, K89L3CVALACWTB, K89L3CVALACPTB, K89L3CVALACTTB, K89L3CVALACSTB	Entire Unit	9.60	11.30	12.50	14.50	190.4
	Inner Back	3.60	4.50	5.00	6.50	72.5
	Outer Back	2.10	3.00	4.00	6.00	42.6
	Seat	2.10	3.00	4.00	3.50	41
	Arm	1.30	1.50	1.80	2.50	25.5
	Accent	0.70	1.50	2.00	3.30	14.4
K89L1CVARUTB, K89L1CVARACWTB, K89L1CVARACPTB, K89L1CVARACTTB, K89L1CVARACSTB	Entire Unit	4.30	5.00	6.00	7.00	84.7
	Inner Back	1.30	1.80	2.00	2.50	25.5
	Outer Back	1.20	1.50	2.00	2.80	24.4
	Seat	0.90	1.30	2.00	2.00	18.3
	Arm	1.40	1.50	1.80	2.50	28.2
	Accent	0.50	1.00	1.50	2.30	10
K89L2CVARUTB, K89L2CVARACWTB, K89L2CVARACPTB, K89L2CVARACTTB, K89L2CVARACSTB	Entire Unit	6.60	8.00	9.00	10.50	132.3
	Inner Back	2.50	3.00	3.50	4.50	49.3
	Outer Back	1.50	2.00	3.00	4.50	29.9
	Seat	1.80	2.00	3.00	3.00	34.9
	Arm	1.30	1.50	1.80	2.50	25.5
	Accent	0.60	1.00	1.80	2.80	11.1
K89L3CVARUTB, K89L3CVARACWTB, K89L3CVARACPTB, K89L3CVARACTTB, K89L3CVARACSTB	Entire Unit	9.60	11.30	12.50	14.50	190.4
	Inner Back	3.60	4.50	5.00	6.50	72.5
	Outer Back	2.10	3.00	4.00	6.00	42.6
	Seat	2.10	3.00	4.00	3.50	41
	Arm	1.30	1.50	1.80	2.50	25.5
	Accent	0.70	1.50	2.00	3.30	14.4
K89L1CVABUTB, K89L1CVABACWTB, K89L1CVABACPTB, K89L1CVABACTTB, K89L1CVABACSTB	Entire Unit	5.00	6.00	7.00	8.00	99.1
	Inner Back	1.30	1.80	2.00	2.50	25.5
	Outer Back	1.20	1.50	2.00	2.80	24.4
	Seat	0.90	1.30	2.00	2.00	18.3
	Arms	1.50	2.00	3.00	3.80	30.4
	Accent	0.50	1.00	1.50	2.30	10

COM YARDAGE REQUIREMENTS

COM YARDAGE REQUIREMENTS (54" WIDTH – CUT UP THE ROLL)

MODEL	RAILROADED Contact customer service 800-634-9510 for ydg requirements	NON DIRECTIONAL OR SOLID	1"-4" REPEAT	5"-11" REPEAT	12"-18" REPEAT	COL SQUARE FEET
			4" VERTICAL X 4" HORIZONTAL	11" VERTICAL X 11" HORIZONTAL	18" VERTICAL X 18" HORIZONTAL	
K89L2CVABUTB,	Entire Unit	7.40	9.00	10.00	11.50	147.2
K89L2CVABACWTB,	Inner Back	2.50	3.00	3.50	4.50	49.2
K89L2CVABACPTB,	Outer Back	1.50	2.00	3.00	4.50	29.9
K89L2CVABACTTB,	Seat	1.80	2.00	3.00	3.00	34.9
K89L2CVABACSTB	Arms	1.50	2.00	3.00	3.80	30.4
	Accent	0.60	1.00	1.80	2.80	11.1
K89L3CVABUTB,	Entire Unit	10.30	12.00	13.50	15.50	204.8
K89L3CVABACWTB,	Inner Back	3.60	4.50	5.00	6.50	72.5
K89L3CVABACPTB,	Outer Back	2.10	3.00	4.00	6.00	42.6
K89L3CVABACTTB,	Seat	2.10	3.00	4.00	3.50	41
K89L3CVABACSTB	Arms	1.50	2.00	3.00	3.80	30.4
	Accent	0.70	1.50	2.00	3.30	14.4
K89L1FALTB, K89L1FARTB	Entire Unit	4.40	5.50	6.50	7.00	88.6
	Inner Back	1.30	1.80	2.00	2.50	25.5
	Outer Back	1.20	1.50	2.00	2.80	24.4
	Seat	0.90	1.30	2.00	2.00	18.3
	Arm	1.40	1.80	2.00	2.50	28.2
	Accent	0.50	1.00	1.50	2.30	10
K89L1FABTB	Entire Unit	5.50	6.50	7.50	8.00	109.6
	Inner Back	1.30	1.80	2.00	2.50	25.5
	Outer Back	1.20	1.50	2.00	2.80	24.4
	Seat	0.90	1.30	2.00	2.00	18.3
	Arms	2.10	2.50	3.30	4.50	41.5
	Accent	0.50	1.00	1.50	2.30	10
K89L2FALTB, K89L2FARTB	Entire Unit	6.90	8.50	10.00	11.00	138.4
	Inner Back	2.50	3.00	3.50	4.50	49.3
	Outer Back	1.50	2.00	3.00	4.50	29.9
	Seat	1.80	2.00	3.00	3.00	34.9
	Arm	1.40	1.80	2.00	2.50	28.2
	Accent	0.60	1.00	1.80	2.80	11.1
K89L2FABTB	Entire Unit	7.90	9.50	11.00	12.00	157.7
	Inner Back	2.50	3.00	3.50	4.50	49.3
	Outer Back	1.50	2.00	3.00	4.50	29.9
	Seat	1.80	2.00	3.00	3.00	34.9
	Arms	2.10	2.50	3.30	4.50	41.5
	Accent	0.60	1.00	1.80	2.80	11.1
K89L3FALTB, K89L3FARTB	Entire Unit	9.80	12.00	13.00	15.00	195.9
	Inner Back	3.60	4.50	5.00	6.50	72.5
	Outer Back	2.10	3.00	4.00	6.00	42.6
	Seat	2.10	3.00	4.00	3.50	41
	Arm	1.40	1.80	2.00	2.50	28.2
	Accent	0.70	1.50	2.00	3.30	14.4
K89L3FABTB	Entire Unit	10.80	13.00	14.50	16.50	215.3
	Inner Back	3.60	4.50	5.00	6.50	72.5
	Outer Back	2.10	3.00	4.00	6.00	42.6
	Seat	2.10	3.00	4.00	3.50	41
	Arms	2.10	2.50	3.30	4.50	41.5
	Accent	0.70	1.50	2.00	3.30	14.4
K89L2XAIBT	Entire Unit	5.10	7.50	8.50	10.50	101.8
	Inner Back	2.50	3.00	3.50	4.50	49.3
	Outer Back	1.50	2.00	3.00	4.50	29.9
	Seat	1.50	2.00	3.00	3.00	30.4
	Arm	1.20	1.40	1.50	2.00	24.4
	Accent	0.60	1.00	1.80	2.80	11.1
K89L3XAIBT, K89L3XAIRTB	Entire Unit	10.10	10.50	12.00	14.50	202
	Inner Back	2.10	3.00	4.00	3.50	41
	Outer Back	2.10	3.00	4.00	6.00	42.6
	Seat	2.10	3.00	4.00	3.50	41
	Arm	1.20	1.40	1.50	2.00	24.4
	Accent	0.70	1.50	2.00	3.30	14.4

COM YARDAGE REQUIREMENTS

COM YARDAGE REQUIREMENTS (54" WIDTH – CUT UP THE ROLL)

MODEL	RAILROADED Contact customer service 800-634-9510 for ydg requirements	NON DIRECTIONAL OR SOLID	1"-4" REPEAT	5"-11" REPEAT	12"-18" REPEAT	COL SQUARE FEET
			4" VERTICAL X 4" HORIZONTAL	11" VERTICAL X 11" HORIZONTAL	18" VERTICAL X 18" HORIZONTAL	
K89L3XAIBTB	Entire Unit	10.10	11.00	12.50	15.50	202
	Inner Back	3.60	4.50	5.00	6.50	72.5
	Outer Back	2.10	3.00	4.00	6.00	42.6
	Seat	2.10	3.00	4.00	3.50	41
	Arm	1.20	1.50	2.50	2.80	24.4
	Accent	0.70	1.50	2.00	3.30	14.4
K89L2CVALIUTB, K89L2CVALIACWTB, K89L2CVALIACPTB, K89L2CVALIACSTB	Entire Unit	5.90	8.00	9.00	11.50	117.3
	Inner Back	2.50	3.00	3.50	4.50	49.3
	Outer Back	1.50	2.00	3.00	4.50	29.9
	Seat	1.80	2.00	3.00	3.00	34.9
	Arms	1.40	1.80	2.50	3.00	28.2
	Accent	0.60	1.00	1.80	2.80	11.1
K89L2CVARIUTB, K89L2CVARIACWTB, K89L2CVARIACPTB, K89L2CVARIACSTB	Entire Unit	5.90	8.00	9.00	11.50	117.3
	Inner Back	2.50	3.00	3.50	4.50	49.3
	Outer Back	1.50	2.00	3.00	4.50	29.9
	Seat	1.80	2.00	3.00	3.00	34.9
	Arms	1.40	1.80	2.50	3.00	28.2
	Accent	0.60	1.00	1.80	2.80	11.1
K89L2CVABIUTB, K89L2CVABIACWTB, K89L2CVABIACPTB, K89L2CVABIACSTB	Entire Unit	6.60	9.00	10.50	12.50	130.6
	Inner Back	2.50	3.00	3.50	4.50	49.3
	Outer Back	1.50	2.00	3.00	4.50	29.9
	Seat	1.80	2.00	3.00	3.00	34.9
	Arms	1.70	2.50	4.50	5.00	33.2
	Accent	0.60	1.00	1.80	2.80	11.1
K89L3CVARILUTB, K89L3CVARILACWTB, K89L3CVARILACPTB, K89L3CVARILACSTB	Entire Unit	8.70	11.30	13.00	15.50	173.8
	Inner Back	3.60	4.50	5.00	6.50	72.5
	Outer Back	2.10	3.00	4.00	6.00	42.6
	Seat	2.10	3.00	4.00	3.50	41
	Arms	1.30	1.80	2.50	3.00	25.5
	Accent	0.70	1.50	2.00	3.30	14.4
K89L3CVABILUTB, K89L3CVABILACWTB, K89L3CVABILACPTB, K89L3CVABILACSTB	Entire Unit	9.40	12.50	14.00	16.50	188.2
	Inner Back	3.60	4.50	5.00	6.50	72.5
	Outer Back	2.10	3.00	4.00	6.00	42.6
	Seat	2.10	3.00	4.00	3.50	41
	Arms	1.70	2.50	4.50	5.00	33.2
	Accent	0.70	1.50	2.00	3.30	14.4
K89L3CVALIRUTB, K89L3CVALIRACWTB, K89L3CVALIRACPTB, K89L3CVALIRACSTB	Entire Unit	8.70	11.30	13.00	15.50	173.8
	Inner Back	3.60	4.50	5.00	6.50	72.5
	Outer Back	2.10	3.00	4.00	6.00	42.6
	Seat	2.10	3.00	4.00	3.50	41
	Arms	1.30	1.80	2.50	3.00	25.5
	Accent	0.70	1.50	2.00	3.30	14.4
K89L3CVABIRUTB, K89L3CVABIRACWTB, K89L3CVABIRACPTB, K89L3CVABIRACSTB	Entire Unit	9.40	12.50	14.00	16.50	188.2
	Inner Back	3.60	4.50	5.00	6.50	72.5
	Outer Back	2.10	3.00	4.00	6.00	42.6
	Seat	2.10	3.00	4.00	3.50	41
	Arms	1.70	2.50	4.50	5.00	33.2
	Accent	0.70	1.50	2.00	3.30	14.4
K89L3CVARIBUTB, K89L3CVARIBACWTB, K89L3CVARIBACPTB, K89L3CVARIBACSTB	Entire Unit	8.00	11.50	13.50	16.30	159.4
	Inner Back	3.60	4.50	5.00	6.50	72.5
	Outer Back	2.10	3.00	4.00	6.00	42.6
	Seat	2.10	3.00	4.00	3.50	41
	Arms	1.90	3.00	4.50	5.00	38.7
	Accent	0.70	1.50	2.00	3.30	14.4
K89L3CVALIBUTB, K89L3CVALIBACWTB, K89L3CVALIBACPTB, K89L3CVALIBACSTB	Entire Unit	8.00	11.50	13.50	16.30	159.4
	Inner Back	3.60	4.50	5.00	6.50	72.5
	Outer Back	2.10	3.00	4.00	6.00	42.6
	Seat	2.10	3.00	4.00	3.50	41
	Arms	1.90	3.00	4.50	5.00	38.7
	Accent	0.70	1.50	2.00	3.30	14.4

COM YARDAGE REQUIREMENTS

COM YARDAGE REQUIREMENTS (54" WIDTH – CUT UP THE ROLL)

MODEL	RAILROADED Contact customer service 800-634-9510 for ydg requirements	NON DIRECTIONAL OR SOLID	1"-4" REPEAT	5"-11" REPEAT	12"-18" REPEAT	COL SQUARE FEET
			4" VERTICAL X 4" HORIZONTAL	11" VERTICAL X 11" HORIZONTAL	18" VERTICAL X 18" HORIZONTAL	
K89L3CVABIBUTB,	Entire Unit	8.60	12.50	15.00	17.50	171.6
K89L3CVABIBACWTB,	Inner Back	3.60	4.50	5.00	6.50	72.5
K89L3CVABIBACPTB,	Outer Back	2.10	3.00	4.00	6.00	42.6
K89L3CVABIBACTTB,	Seat	2.10	3.00	4.00	3.50	41
K89L3CVABIBACSTB	Arms	1.90	3.00	4.50	5.00	38.7
	Accent	0.70	1.50	2.00	3.30	14.4
K89C2LXATB	Entire Unit	6.20	8.50	10.50	12.50	123.4
	Inner Back	3.00	4.50	5.00	6.00	59.8
	Outer Back	2.20	2.80	4.00	5.30	43.2
	Seat	1.60	2.00	2.50	2.50	32.1
	Accent	0.50	1.00	1.50	2.30	10
K89C3LXATB	Entire Unit	9.30	12.00	14.00	16.50	184.8
	Inner Back	3.10	3.80	5.80	6.50	75.8
	Outer Back	2.90	3.50	5.00	7.30	57
	Seat	2.30	2.80	4.00	3.50	45.9
	Accent	0.60	1.00	1.80	2.80	11.6
K89C2LCVAUTB,	Entire Unit	6.90	9.00	11.00	13.00	137.3
K89C2LCVAACWTB,	Inner Back	3.00	4.50	5.00	6.00	59.8
K89C2LCVAACPTB,	Outer Back	2.20	2.80	4.00	5.30	43.2
K89C2LCVAACTTB,	Seat	1.60	2.00	2.50	2.50	32.1
K89C2LCVAACSTB	Arm	1.30	1.50	1.80	2.50	25.5
	Accent	0.50	1.00	1.50	2.30	10
K89C3LCVAUTB,	Entire Unit	9.80	12.50	14.50	17.50	194.3
K89C3LCVAACWTB,	Inner Back	3.80	5.80	6.50	7.50	75.8
K89C3LCVAACPTB,	Outer Back	2.90	3.50	5.00	7.30	57
K89C3LCVAACTTB,	Seat	2.30	2.80	4.00	3.50	45.9
K89C3LCVAACSTB	Arm	1.30	1.50	1.80	2.50	25.5
	Accent	0.60	1.00	1.80	2.80	11.6
K89C2LFATB	Entire Unit	7.20	9.50	11.50	13.50	142.8
	Inner Back	3.00	4.50	5.00	6.00	59.8
	Outer Back	2.20	2.80	4.00	5.30	43.2
	Seat	1.60	2.00	2.50	2.50	32.1
	Arm	1.40	1.80	2.00	2.50	28.2
	Accent	0.50	1.00	1.50	2.30	10
K89C3LFATB	Entire Unit	10.10	13.00	15.50	17.50	200.9
	Inner Back	3.80	5.80	6.50	7.50	75.8
	Outer Back	2.90	3.50	5.00	7.30	57
	Seat	2.30	2.80	4.00	3.50	45.9
	Arm	1.40	1.80	2.00	2.50	28.2
	Accent	0.60	1.00	1.80	2.80	11.6
K89C3LXAIRTB	Entire Unit	8.30	12.00	14.00	17.00	164.9
	Inner Back	3.80	5.80	6.50	7.50	75.8
	Outer Back	2.90	3.50	5.00	7.30	57
	Seat	2.30	2.80	4.00	3.50	45.9
	Arm	1.20	1.40	1.50	2.00	12.2
	Accent	0.60	1.00	1.80	2.80	11.6
K89C3LCVAUIRTB,	Entire Unit	9.20	13.00	15.00	18.00	182.6
K89C3LCVAACWIRTB,	Inner Back	3.80	5.80	6.50	7.50	75.8
K89C3LCVAACPIRTB,	Outer Back	2.90	3.50	5.00	7.30	57
K89C3LCVAACTIRTB,	Seat	2.30	2.80	4.00	3.50	45.9
K89C3LCVAACSIRTB	Arms	1.30	1.80	2.50	3.00	25.5
	Accent	0.60	1.00	1.80	2.80	11.6
K89C2RXATB	Entire Unit	6.20	8.50	10.50	12.50	123.4
	Inner Back	3.00	4.50	5.00	6.00	59.8
	Outer Back	2.20	2.80	4.00	5.30	43.2
	Seat	1.60	2.00	2.50	2.50	32.1
	Accent	0.50	1.00	1.50	2.30	10
K89C3RXATB	Entire Unit	9.30	12.00	14.00	16.50	184.8
	Inner Back	3.10	3.80	5.80	6.50	75.8
	Outer Back	2.90	3.50	5.00	7.30	57
	Seat	2.30	2.80	4.00	3.50	45.9
	Accent	0.60	1.00	1.80	2.80	11.6

COM YARDAGE REQUIREMENTS

COM YARDAGE REQUIREMENTS (54" WIDTH – CUT UP THE ROLL)

MODEL	RAILOADED Contact customer service 800-634-9510 for ydg requirements	NON DIRECTIONAL OR SOLID	1"-4" REPEAT	5"-11" REPEAT	12"-18" REPEAT	COL SQUARE FEET
			4" VERTICAL X 4" HORIZONTAL	11" VERTICAL X 11" HORIZONTAL	18" VERTICAL X 18" HORIZONTAL	
K89C2RCVAUTB,	Entire Unit	6.90	9.00	11.00	13.00	137.3
K89C2RCVAACWTB,	Inner Back	3.00	4.50	5.00	6.00	59.8
K89C2RCVAACPTB,	Outer Back	2.20	2.80	4.00	5.30	43.2
K89C2RCVAACCTB,	Seat	1.60	2.00	2.50	2.50	32.1
K89C2RCVAACSTB	Arm	1.30	1.50	1.80	2.50	25.5
	Accent	0.50	1.00	1.50	2.30	10
K89C3RCVAUTB,	Entire Unit	9.80	12.50	14.50	17.50	194.3
K89C3RCVAACWTB,	Inner Back	3.80	5.80	6.50	7.50	75.8
K89C3RCVAACPTB,	Outer Back	2.90	3.50	5.00	7.30	57
K89C3RCVAACCTB,	Seat	2.30	2.80	4.00	3.50	45.9
K89C3RCVAACSTB	Arm	1.30	1.50	1.80	2.50	25.5
	Accent	0.60	1.00	1.80	2.80	11.6
K89C2RFATB	Entire Unit	7.20	9.50	11.50	13.50	142.8
	Inner Back	3.00	4.50	5.00	6.00	59.8
	Outer Back	2.20	2.80	4.00	5.30	43.2
	Seat	1.60	2.00	2.50	2.50	32.1
	Arm	1.40	1.80	2.00	2.50	28.2
	Accent	0.50	1.00	1.50	2.30	10
K89C3RFATB	Entire Unit	10.10	13.00	15.50	17.50	200.9
	Inner Back	3.80	5.80	6.50	7.50	75.8
	Outer Back	2.90	3.50	5.00	7.30	57
	Seat	2.30	2.80	4.00	3.50	45.9
	Arm	1.40	1.80	2.00	2.50	28.2
	Accent	0.60	1.00	1.80	2.80	11.6
K89C3RXAILTB	Entire Unit	8.30	12.00	14.00	17.00	164.9
	Inner Back	3.80	5.80	6.50	7.50	75.8
	Outer Back	2.90	3.50	5.00	7.30	57
	Seat	2.30	2.80	4.00	3.50	45.9
	Arm	1.20	1.40	1.50	2.00	12.2
	Accent	0.60	1.00	1.80	2.80	11.6
K89C3RCVAUILTB,	Entire Unit	9.20	13.00	15.00	18.00	182.6
K89C3RCVAACWILTB,	Inner Back	3.80	5.80	6.50	7.50	75.8
K89C3RCVAACPILTB,	Outer Back	2.90	3.50	5.00	7.30	57
K89C3RCVAACILTB,	Seat	2.30	2.80	4.00	3.50	45.9
K89C3RCVAACSILTB	Arms	1.30	1.80	2.50	3.00	25.5
	Accent	0.60	1.00	1.80	2.80	11.6
K89PE2LTB, K89PE2RTB	Entire Unit	5.20	6.00	7.00	8.00	103.5
	Inner Back	1.30	1.80	2.00	2.50	25.5
	Outer Back	1.20	1.50	2.00	2.80	24.4
	Seat	2.10	2.50	3.30	3.30	41.5
	Accent	0.90	1.50	2.00	3.30	18.8
K89PE3LTB, K89PE3RTB	Entire Unit	7.60	9.00	10.50	12.00	152.2
	Inner Back	2.50	3.00	3.50	4.30	49.3
	Outer Back	1.50	2.00	3.00	4.30	29.9
	Seat	2.90	3.30	4.50	4.50	57.6
	Accent	1.10	1.50	2.30	3.80	22.1
K89PE2RCVARUTB,	Entire Unit	5.90	7.00	8.00	9.00	117.3
K89PE2RCVARACWTB,	Inner Back	1.30	1.80	2.00	2.50	25.5
K89PE2RCVARACPTB,	Outer Back	1.20	1.50	2.00	2.80	24.4
K89PE2RCVARACTTB,	Seat	2.10	2.50	3.30	3.30	41.5
K89PE2RCVARACSTB	Arm	1.30	1.50	1.80	2.50	25.5
	Accent	0.90	1.50	2.00	3.30	18.8
K89PE3RCVARUTB,	Entire Unit	8.40	10.00	11.00	13.00	166.6
K89PE3RCVARACWTB,	Inner Back	2.50	3.00	3.50	4.30	49.3
K89PE3RCVARACPTB,	Outer Back	1.50	2.00	3.00	4.30	29.9
K89PE3RCVARACTTB,	Seat	2.90	3.30	4.50	4.50	57.6
K89PE3RCVARACSTB	Arms	1.30	1.50	1.80	2.50	25.5
	Accent	1.10	1.50	2.30	3.80	22.1

COM YARDAGE REQUIREMENTS

COM YARDAGE REQUIREMENTS (54" WIDTH – CUT UP THE ROLL)

MODEL	RAILROADED Contact customer service 800-634-9510 for ydg requirements	NON DIRECTIONAL OR SOLID	1"-4" REPEAT	5"-11" REPEAT	12"-18" REPEAT	COL SQUARE FEET
			4" VERTICAL X 4" HORIZONTAL	11" VERTICAL X 11" HORIZONTAL	18" VERTICAL X 18" HORIZONTAL	
K89PE2LCVALUTB,	Entire Unit	5.90	7.00	8.00	9.00	117.3
K89PE2LCVALACWTB,	Inner Back	1.30	1.80	2.00	2.50	25.5
K89PE2LCVALACPTB,	Outer Back	1.20	1.50	2.00	2.80	24.4
K89PE2LCVALACCTTB,	Seat	2.10	2.50	3.30	3.30	41.5
K89PE2LCVALACSTB	Arm	1.30	1.50	1.80	2.50	25.5
	Accent	0.90	1.50	2.00	3.30	18.8
K89PE3LCVALUTB,	Entire Unit	8.40	10.00	11.00	13.00	166.6
K89PE3LCVALACWTB,	Inner Back	2.50	3.00	3.50	4.30	49.3
K89PE3LCVALACPTB,	Outer Back	1.50	2.00	3.00	4.30	29.9
K89PE3LCVALACCTTB,	Seat	2.90	3.30	4.50	4.50	57.6
K89PE3LCVALACSTB	Arms	1.30	1.50	1.80	2.50	25.5
	Accent	1.10	1.50	2.30	3.80	22.1
K89PE3LILT, K89PE3LIRT	Entire Unit	7.00	9.00	11.00	13.50	139.5
	Inner Back	2.50	3.00	3.50	4.30	49.3
	Outer Back	1.50	2.00	3.00	4.30	29.9
	Seat	2.10	3.30	4.50	4.50	41.5
	Arm	1.20	1.40	1.50	2.00	12.2
	Accent	1.10	1.50	2.30	3.80	22.1
K89CP2LTB, K89CP2RTB	Entire Unit	5.00	7.00	9.00	10.00	99.1
	Inner Back	2.00	3.00	3.50	4.30	40.4
	Outer Back	1.50	2.00	3.00	4.30	29.3
	Seat	1.90	2.50	2.80	2.80	38.2
	Accent	0.70	1.30	1.80	2.80	14.4
K89CP3LTB, K89CP3RTB	Entire Unit	8.20	10.50	12.50	14.50	163.3
	Inner Back	3.00	4.30	4.80	5.80	59.8
	Outer Back	2.20	2.80	3.00	5.80	43.2
	Seat	2.60	3.30	4.00	4.00	52
	Accent	0.70	1.80	2.30	3.80	14.4
K89BE1	Entire Unit	2.00	2.40	3.00	4.50	40.4
	Seat	1.30	1.50	2.30	2.30	24.9
	Accent	0.90	1.20	1.80	2.80	17.7
K89BE2	Entire Unit	3.60	4.00	5.00	7.00	70.8
	Seat	2.40	2.70	3.80	4.00	47
	Accent	1.40	1.60	2.30	4.00	27.1
K89BE3	Entire Unit	5.10	5.80	6.80	9.50	101.3
	Seat	3.50	3.80	5.00	5.30	69.7
	Accent	1.70	2.00	3.00	5.00	33.8